FCC Test Report

Report No.: AGC03588150604FE02

FCC ID : 2AE6GVHF-04BP
APPLICATION PURPOSE : ORIGINAL EQUIPMENT
PRODUCT DESIGNATION : Body-worn Wireless Microphone
BRAND NAME : Gemini
MODEL NAME : VHF-04BP
CLIENT : INNOVATIVE CONCEPTS AND DESIGN LLC
DATE OF ISSUE : Jul9, 2015
STANDARD(S) : FCC PART 74 RULES
REPORT VERSION : V1.0

Attestation of Global Compliance (Shenzhen) Co., Ltd.



CAUTION:

This report shall not be reproduced except in full without the written permission of the test laboratory and shall not be quoted out of context.



REPORT REVISE RECORD

Report Version	Revise Time	Issued Date	Valid Version	Notes
V1.0	/	Jul.9, 2015	Valid	Original Report

TABLE OF CONTENTS

1. VERIFICATION OF COMPLIANCE	5
2. GENERAL INFORMATION	6
2.1 PRODUCT DESCRIPTION.....	6
2.2 RELATED SUBMITTAL(S) / GRANT (S).....	7
2.3 TEST METHODOLOGY	7
2.4 SPECIAL ACCESSORIE	7
2.5 EQUIPMENT MODIFICATIONS.....	7
2.6 DIFFERENCES BETWEEN MODELS.....	7
2.7 TEST FACILITY	8
3. SYSTEM TEST CONFIGURATION	9
3.1 EUT CONFIGURATION	9
3.2 EUT EXERCISE	9
3.3 GENERAL TECHNICAL REQUIREMENTS	9
3.4 CONFIGURATION OF TESTED SYSTEM.....	10
4. SUMMARY OF TEST RESULTS.....	11
5. DESCRIPTION OF TEST MODES.....	11
6. MAXIMUM TRANSMITTER POWER	12
6.1 PROVISIONS APPLICABLE	12
6.2 MEASUREMENT PROCEDURE.....	12
6.3 TEST SETUP BLOCK DAIGRAM.....	14
6.4 TEST RESULT.....	15
7. MODULATION CHARACTERISTICS.....	16
7.1 PROVISIONS APPLICABLE	16
7.2 MEASUREMENT METHOD.....	16
7.3 TEST RESULT	17
8. FREQUENCY TOLERANCE.....	26
8.1 PROVISIONS APPLICABLE.....	26
8.2 MEASUREMENT PROCEDURE	26
8.3 TEST SETUP BLOCK DIAGRAM.....	27
8.4 TEST RESULT	27
9. EMISSION BANDWIDTH	30

9.1 PROVISIONS APPLICABLE	30
9.2 MEASUREMENT PROCEDURE	30
9.3 TEST SETUP BLOCK DIAGRAM	30
9.4 TEST RESULT	31
10. UNWANTED RADIATION	32
10.1 PROVISIONS APPLICABLE	32
10.2 MEASUREMENT PROCEDURE	32
10.3 TEST SETUP BLOCK DIAGRAM	33
10.4 TEST RESULTS	35
APPENDIX I : PHOTOGRAPHS OF TEST SETUP	38
APPENDIX II : PHOTOGRAPHS OF EUT	39

1. VERIFICATION OF COMPLIANCE

Applicant	INNOVATIVE CONCEPTS AND DESIGN LLC
Address	107 Trumbull Street - Bldg F8, 2nd Flr, Elizabeth, NJ 07206 USA
Manufacturer	PROAUDIO ELECTRONICS CO., LIMITED
Address	FLAT 03H 15/F CARNIVAL COMMERCIAL BUILDING 18 JAVA ROAD NORTH POINT HK
Product Description	Body-worn Wireless Microphone
Brand Name	Gemini
Model Name	VHF-04BP
Date of Test	Jun.29, 2015 to Jul.2, 2015

We hereby certify that:

The report for the equipment was prepared by Dongguan Precise Testing Service Co., Ltd. The test data, data evaluation, test procedures, and equipment configurations shown in this report were made in accordance with the procedures given in TIA/EIA 603; ANSI C 63.4:2009 and the sample tested as described in this report is in compliance with the FCC Rules Part 74 Subpart H. The test results of this report relate only to the tested sample identified in this report.

Tested By :

Sally Wu

Sally Wu

Jul.9, 2015

Reviewed By :

Max Zhang

Max Zhang

Jul.9, 2015

Approved By:

Solger Zhang

Solger Zhang

Jul.9, 2015

2. GENERAL INFORMATION

2.1 PRODUCT DESCRIPTION

The EUT is a Body-worn Wireless Microphone designed as Low Power Auxiliary Stations for transmitting voice only. It is designed by way of utilizing the FM modulation achieves the system operating.

A major technical description of EUT is described as following:

Communication Type	Voice / Tone only
Modulation	FM
Emission Type	F3E
Emission Bandwidth	60.63kHz(Max)
Peak Frequency Deviation	48.75KHz(Max)
Audio Frequency Deviation	19.86 KHz(Max)
Maximum Output Power	1.19 mW
Output Power Modification	Fixed can't be changed
Antenna Designation	Integral
Power Supply	DC 3V
Battery Endpoint	DC 2.55V
Operation Frequency Range and Channel	Frequency Range: 177.6MHz or 186.6MHz, 198.6MHz , 204.6 MHz
	Channel: High Channel: 204.6MHz, Middle Channel: 198.6MHz, Low Channel: 177.6MHz
Frequency Tolerance	0.000195%

2.2 RELATED SUBMITTAL(S) / GRANT (S)

This submittal(s) (test report) is intended for **FCC ID: 2AE6GVHF-04BP** filing to comply with the FCC Part 74, Subpart H Rules.

2.3 TEST METHODOLOGY

The radiated emission testing was performed according to the procedures of ANSI TIA/EIA 603 and FCC CFR 47 2.1046, 2.1047, 2.1049, 2.1051, 2.1053, 2.1055 and 2.1057

2.4 SPECIAL ACCESSORIE

Not available for this EUT intended for grant.

2.5 EQUIPMENT MODIFICATIONS

Not available for this EUT intended for grant.

2.6 DIFFERENCES BETWEEN MODELS

Not available for this EUT intended for grant.

2.7 TEST FACILITY

Site	Dongguan Precise Testing Service Co., Ltd.
Location	Building D,Baoding Technology Park,Guangming Road2,Dongcheng District, Dongguan, Guangdong, China,
FCC Registration No.	371540
Description	The test site is constructed and calibrated to meet the FCC requirements in documents ANSI C63.4:2009.

ALL TEST EQUIPMENT LIST

Radiated Emission Test Site					
Name of Equipment	Manufacturer	Model Number	Serial Number	Last Calibration	Due Calibration
EMI Test Receiver	Rohde & Schwarz	ESCI	101417	July 4, 2014	July 3, 2015
Trilog Broadband Antenna (25M-1GHz)	SCHWARZBECK	VULB9160	9160-3355	July 4, 2014	July 3, 2015
Signal Amplifier	SCHWARZBECK	BBV 9475	9745-0013	July 4, 2014	July 3, 2015
RF Cable	SCHWARZBECK	AK9515E	96221	July 4, 2014	July 3, 2015
3m Anechoic Chamber	CHENGYU	966	PTS-001	June 6, 2015	June 5, 2016
MULTI-DEVICE Positioning Controller	Max-Full	MF-7802	MF780208339	N/A	N/A
Active loop antenna (9K-30MHz)	Schwarzbeck	FMZB1519	1519-038	June 6, 2015	June 5, 2016
Spectrum analyzer	Agilent	E4407B	MY46185649	June 6, 2015	June 5, 2016
Horn Antenna (1G-18GHz)	SCHWARZBECK	BBHA9120D	9120D-1246	July 11, 2014	July 10, 2015
Spectrum Analyzer	Agilent	E4411B	MY4511453	July 4, 2014	July 3, 2015
MODULATION ANALYZER	HP	8920B	3104A03367	July 16, 2014	July 15, 2015
DC POWER SUPPLY	ZHAOXIN	RXN-605D	N/A	July 16, 2014	July 15, 2015

NOTE: 8920B can generate audio modulation frequency.

3. SYSTEM TEST CONFIGURATION

3.1 EUT CONFIGURATION

The EUT configuration for testing is installed on RF field strength measurement to meet the Commission's requirement and operating in a manner which intends to maximize its emission characteristics in a continuous normal application.

3.2 EUT EXERCISE

The Transmitter was operated in the normal operating mode. The TX frequency was fixed which was for the purpose of the measurements.

3.3 GENERAL TECHNICAL REQUIREMENTS

- a) Section 74.861 (e) - 1: Maximum transmitter power less than 250mW
- b) Section 74.861 (e) - 3: Peak Frequency Deviation less than ± 75 KHz
- c) Section 74.861 (e) - 4: Frequency Tolerance less than 0.005%
- d) Section 74.861 (e) - 5: Emission Bandwidth shall less than 200 KHz
- e). Section 74.861 (e) - 6: Unwanted radiation

According to Section 74.861 (e) – 6, the mean power of emission shall be attenuated below the mean output power of the transmitter in accordance with the following schedule:

- 1). At least 25 dB on any frequency removed from the center of the authorized bandwidth by more than 50% up to and including 100% of the authorized bandwidth.
- 2). At least 35 dB on any frequency removed from the center of the authorized bandwidth by more than 100% up to and including 250% of the authorized bandwidth.
- 4). At least $43 + 10 \log_{10}(T)$ dB on any frequency removed from the center of the authorized bandwidth by more than 250%

3.4 CONFIGURATION OF TESTED SYSTEM

Fig. 2-1 Configuration of Tested System



Table 2-1 Equipment Used in Tested System

Item	Equipment	Mfr/Brand	Model/Type No.	FCC ID	Series No.	Note
1.	Body-worn Wireless Microphone	Gemini	VHF-04BP	2AE6GVHF-04BP	N/A	EUT
--	--	--	--	--	--	--
--	--	--	--	--	--	--

4. SUMMARY OF TEST RESULTS

FCC Rules	Description Of Test	Result
§74.861 (e)-1	Carrier Power	Compliant
§74.861 (e)-3	Frequency Deviation	Compliant
§74.861 (e)-4	Frequency Tolerance	Compliant
§74.861 (e)-5	Operating Bandwidth	Compliant
§74.861 (e)-6	Unwanted Radiation	Compliant

5. DESCRIPTION OF TEST MODES

Test mode:

Mode 1: TX in Low Channel

Mode 2: TX in middle Channel

Mode 3: TX in high Channel

Note: The EUT (Body-Worn Transmitter) has been tested under normal operating condition. Three channels (the Low channel, the middle channel and the High channel) have been chosen for testing. On each channel three axes have been evaluated for radiated emission.

6. MAXIMUM TRANSMITTER POWER

6.1 PROVISIONS APPLICABLE

According to FCC Part 74 Section 74.861(e) – 1: The power of the measured unmodulated carrier power at the output of the transmitter power amplifier may not exceed 250mW

6.2 MEASUREMENT PROCEDURE

- 1). On a test site, the EUT shall be placed on a turntable, and in the position closest to the normal use as declared by the user.
- 2). The test antenna shall be oriented initially for vertical polarization located 3m from the EUT to correspond to the transmitter.
- 3). The output of the antenna shall be connected to the measuring receiver and either a peak or quasi-peak detector was used for the measurement as indicated on the report. The detector selection is based on how close the emission level was approaching the limit.
- 4). The transmitter shall be switched on; if possible, without the modulation and the measurement receiver shall be tuned to the frequency of the transmitter under test.
- 5). The test antenna shall be raised and lowered through the specified range of height until the measuring receiver detects a maximum signal level.
- 6). The transmitter shall then be rotated through 360° in the horizontal plane, until the maximum signal level is detected by the measuring receiver.
- 7). The test antenna shall be raised and lowered again through the specified range of height until the measuring receiver detects a maximum signal level.
- 8). The maximum signal level detected by the measuring receiver shall be noted.
- 9). Replace the antenna with a proper Antenna (substitution antenna).
- 10). The substitution antenna shall be oriented for vertical polarization and, if necessary, the length of the substitution antenna shall be adjusted to correspond to the frequency of transmitting.

- 11). The substitution antenna shall be connected to a calibrated signal generator.
- 12). If necessary, the input attenuator setting of the measuring receiver shall be adjusted in order to increase the sensitivity of the measuring receiver.
- 13). The test antenna shall be raised and lowered through the specified range of the height to ensure that the maximum signal is received.
- 14). The input signal to substitution antenna shall be adjusted to the level that produces a level detected by the measuring receiver, that is equal to the level noted while the transmitter radiated power was measured, corrected for the change of input attenuation setting of the measuring receiver.
- 15). The input level to the substitution antenna shall be recorded as power level in dBm, corrected for any change of input attenuator setting of the measuring receiver.
- 16). The measurement shall be repeated with the test antenna and the substitution antenna oriented for horizontal polarization.
- 17). The measure of the effective radiated power is the larger of the two levels recorded, at the input to the substitution antenna, corrected for the gain of the substitution antenna if necessary.

6.3 TEST SETUP BLOCK DAIGRAM

TEST SETUP OF SUBSTITUTION METHOD

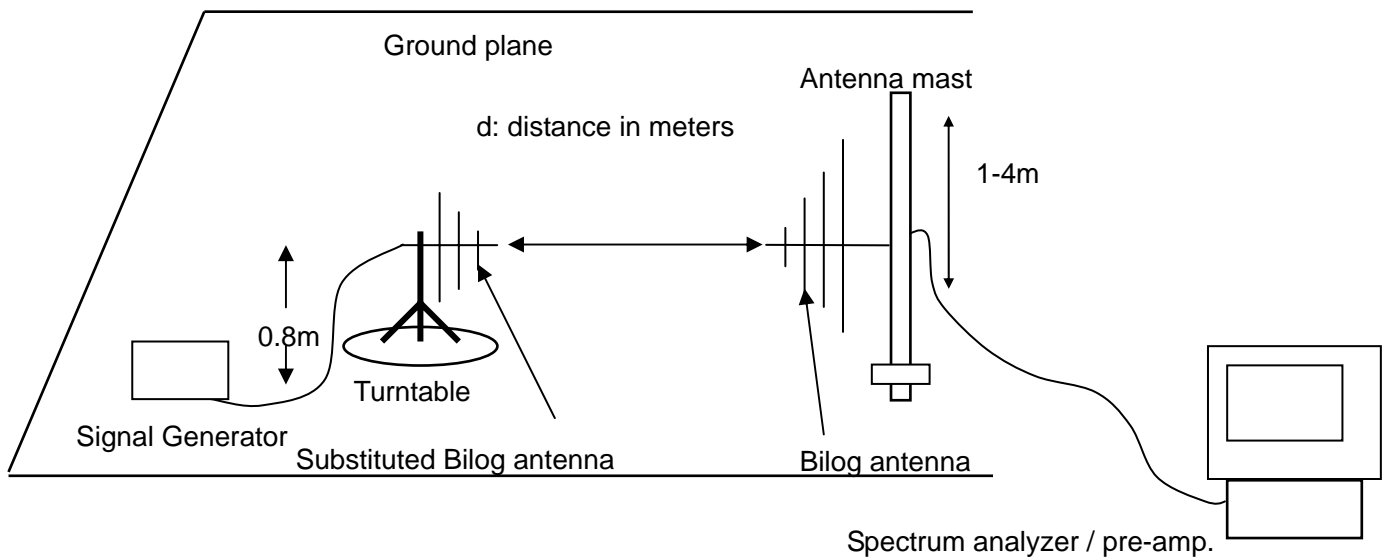
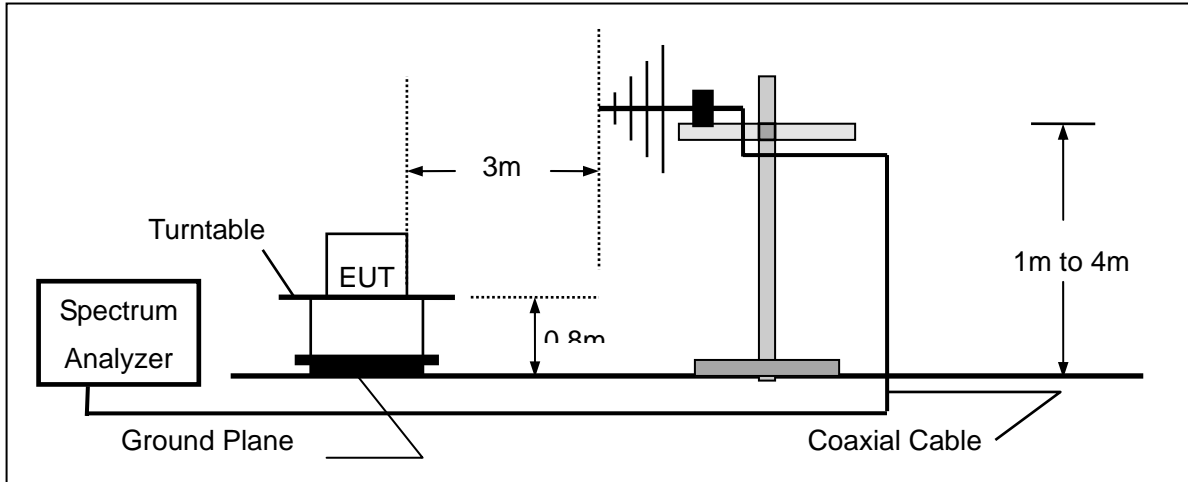

6.4 TEST RESULT

Test Result @Low Channel

Freq.	Antenna	Corrected Power		Limit
(MHz)	Polarity	(dBm)	(mW)	(mW)
177.600	V	0.58	1.14	50
177.600	H	-1.86	0.65	50

Test Result @Middle Channel

Freq.	Antenna	Corrected Power		Limit
(MHz)	Polarity	(dBm)	(mW)	(mW)
198.600	V	0.64	1.16	50
198.600	H	-1.74	0.67	50

Test Result @High Channel

Freq.	Antenna	Corrected Power		Limit
(MHz)	Polarity	(dBm)	(mW)	(mW)
204.600	V	0.76	1.19	50
204.600	H	-1.27	0.75	50

7. MODULATION CHARACTERISTICS

7.1 PROVISIONS APPLICABLE

- a). According to CFR 47 section 2.1047(a), for Voice Modulation Communication Equipment, the frequency response of the audio modulation circuit over a range of 100 to 5000Hz shall be measured.
- b). According to CFR 47 section 74.861(e)-3, any form of modulation may be used. A maximum deviation of ± 75 KHz is permitted when frequency modulation is employed.

7.2 MEASUREMENT METHOD

7.2.1 MODULATION LIMIT

- 1). Configure the EUT as shown in figure 6-1, adjust the audio input for 60% of rated system deviation at 1KHz using this level as a reference (0dB) and vary the input level from -20 to $+20$ dB. Record the frequency deviation obtained as a function of the input level.
- 2). Repeat step 1 with input frequency changing to 300, 1000, 3000, and 12000 Hz in sequence.

7.2.2 AUDIO FREQUENCY RESPONSE

- 1). Configure the EUT as shown in figure 6-1.
- 2). Adjust the audio input for 20% of rated system deviation at 1 KHz using this level as a reference (0 dB).
- 3). Vary the Audio frequency from 100 Hz to 30 KHz and record the frequency deviation.
- 4). Audio Frequency Response = $20\log_{10}$ (Deviation of test frequency/Deviation of 1 KHz reference).

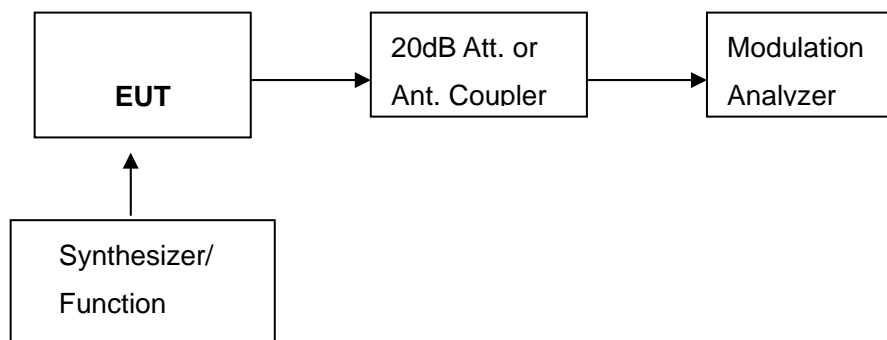

Figure 6-1: Modulation Characteristic Measurement Configuration

7.3 TEST RESULT

a). Modulation Limit:

Test Result @Low Channel

Modulation Level (dB)	Peak Freq. Deviation At 300 Hz (KHz)	Peak Freq. Deviation At 1000 Hz (KHz)	Peak Freq. Deviation At 3000 Hz (KHz)	Peak Freq. Deviation At 12000 Hz (KHz)
-20	19.36	28.56	29.33	30.27
-15	21.56	30.27	31.19	33.57
-10	25.78	33.19	36.57	38.64
-5	34.26	40.87	42.27	44.34
0	36.57	45.37	45.43	46.29
5	37.14	46.97	47.23	48.02
10	37.86	47.12	47.53	48.16
15	38.14	47.25	48.37	48.27
20	38.51	48.39	48.41	48.64

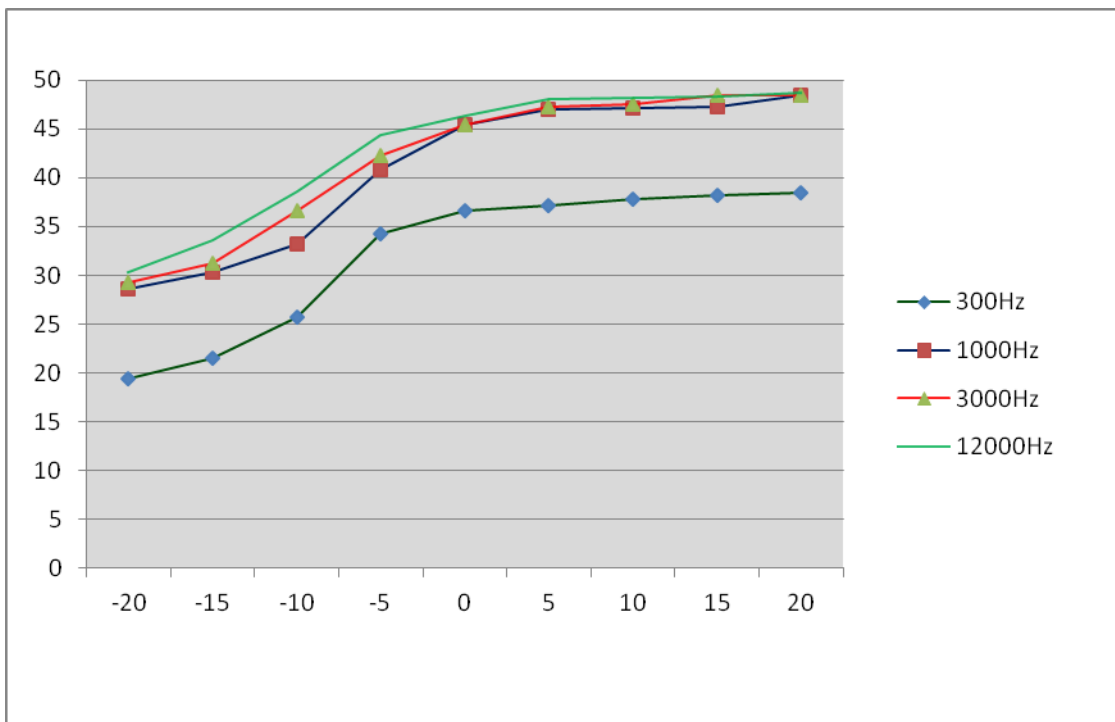

Test Result @ Middle Channel

Modulation Level (dB)	Peak Freq. Deviation At 300 Hz (KHz)	Peak Freq. Deviation At 1000 Hz (KHz)	Peak Freq. Deviation At 3000 Hz (KHz)	Peak Freq. Deviation At 12000 Hz (KHz)
-20	19.34	28.51	29.37	30.26
-15	21.51	30.19	31.27	33.61
-10	25.53	33.37	36.46	38.29
-5	34.42	40.73	42.31	44.37
0	36.51	45.39	45.45	46.37
5	37.19	46.83	47.42	48.15
10	37.73	47.64	47.73	48.31
15	38.34	47.54	48.41	48.35
20	38.52	48.31	48.47	48.69

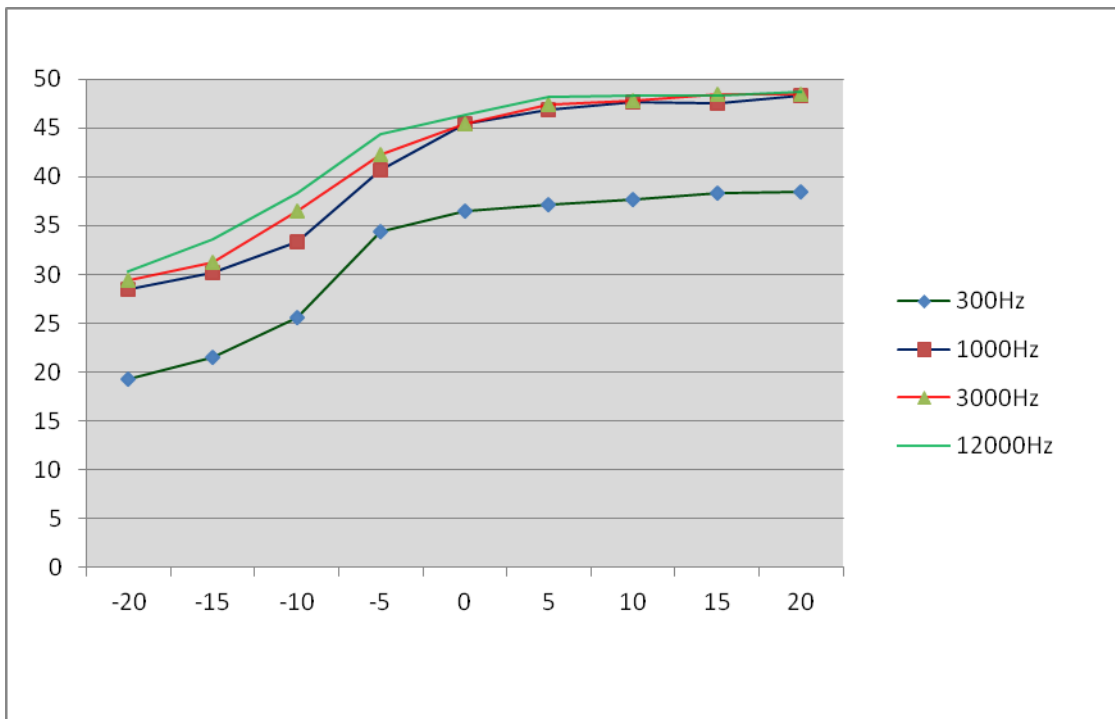

Test Result @High Channel

Modulation Level (dB)	Peak Freq. Deviation At 300 Hz (KHz)	Peak Freq. Deviation At 1000 Hz (KHz)	Peak Freq. Deviation At 3000 Hz (KHz)	Peak Freq. Deviation At 12000 Hz (KHz)
-20	19.19	28.37	29.65	30.49
-15	21.79	30.37	31.51	33.86
-10	25.41	33.61	36.58	38.37
-5	34.86	40.67	42.43	44.86
0	36.57	45.57	45.89	46.49
5	37.37	46.52	47.87	48.29
10	37.35	47.58	47.67	48.46
15	38.16	47.38	48.61	48.47
20	38.27	48.42	48.66	48.75

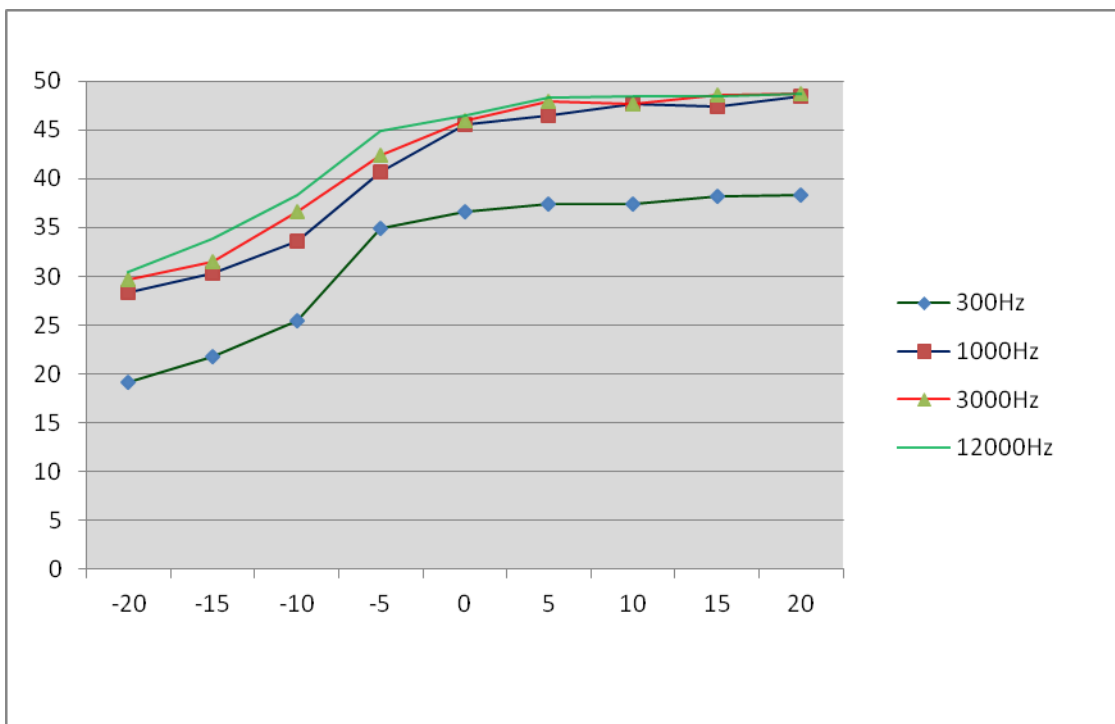

b). Audio Frequency Response:

Test Result @ Low Channel

Frequency (Hz)	Deviation (KHz)
100	8.18
200	9.86
300	10.12
400	11.02
500	11.56
600	11.82
700	12.74
800	12.98
900	13.27
1000	14.57
1200	15.13
1400	15.37
1600	15.79
1800	16.83
2000	16.97
2400	17.06
2500	17.39
2800	17.83
3000	18.05
3200	18.36
3600	18.94
4000	19.32
4500	19.64
5000	19.86
5500	19.64
6000	19.37
6500	19.05
7000	18.64
7500	18.37
9000	18.25
10000	17.97
12000	16.56
14000	13.21
18000	12.86
20000	10.02
30000	8.76

Audio Frequency Response @Low Channel

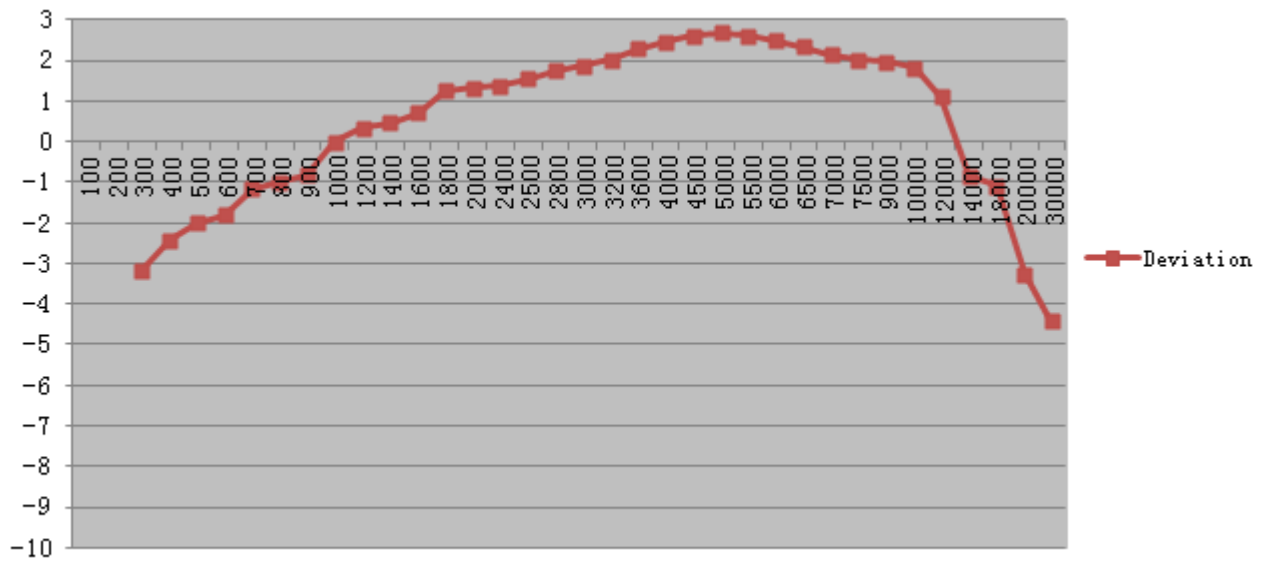

Test Result @Middle Channel

Frequency (Hz)	Deviation (KHz)
100	8.21
200	9.54
300	10.34
400	11.12
500	11.48
600	11.76
700	12.69
800	12.83
900	13.41
1000	14.52
1200	15.27
1400	15.31
1600	15.59
1800	16.75
2000	16.98
2400	17.12
2800	17.42
3200	17.86
3600	18.13
4000	18.37
4500	18.86
5000	19.37
5500	19.66
6000	19.75
6500	19.67
7000	19.35
8000	19.12
9000	18.67
10000	18.32
12000	18.27
14000	17.75
16000	16.43
18000	13.27
20000	12.72
25000	10.13
30000	8.89

Audio Frequency Response @Middle Channel

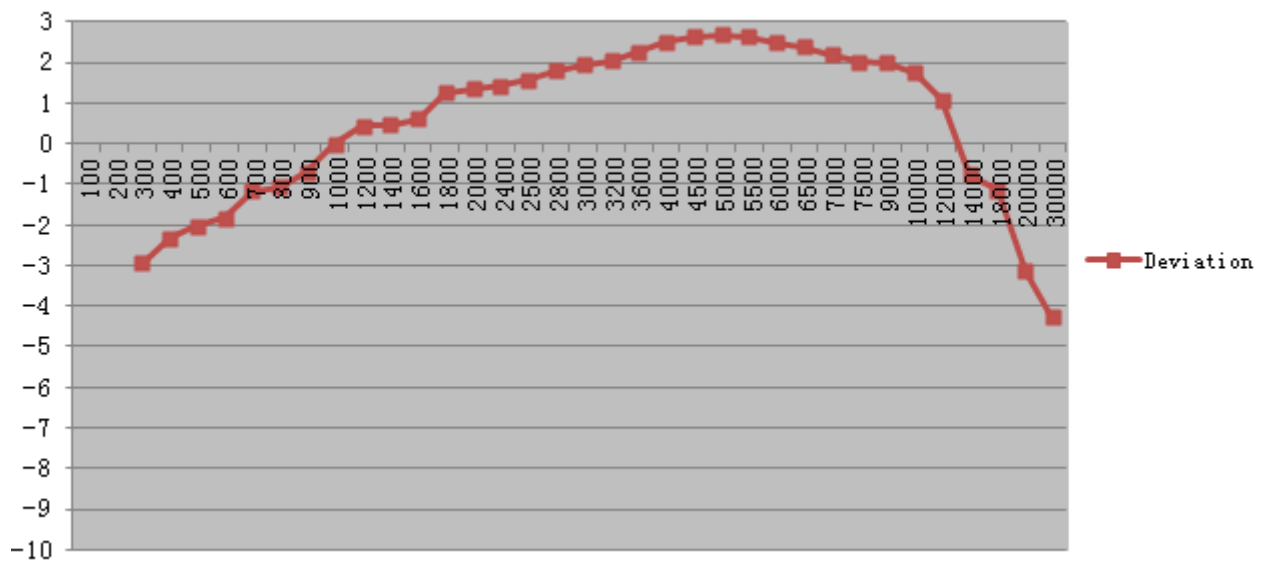

Test Result @High Channel

Frequency (Hz)	Deviation (KHz)
100	8.38
200	9.75
300	10.28
400	11.31
500	11.56
600	11.89
700	12.15
800	12.38
900	13.42
1000	14.19
1200	15.38
1400	15.46
1600	15.85
1800	16.17
2000	16.38
2400	17.26
2800	17.39
3200	17.48
3600	18.25
4000	18.34
4500	18.76
5000	19.41
5500	19.59
6000	19.83
6500	19.51
7000	19.39
8000	19.25
9000	18.49
10000	18.28
12000	18.15
14000	17.86
16000	16.75
18000	13.22
20000	12.46
25000	10.18
30000	8.96

Audio Frequency Response@ High Channel

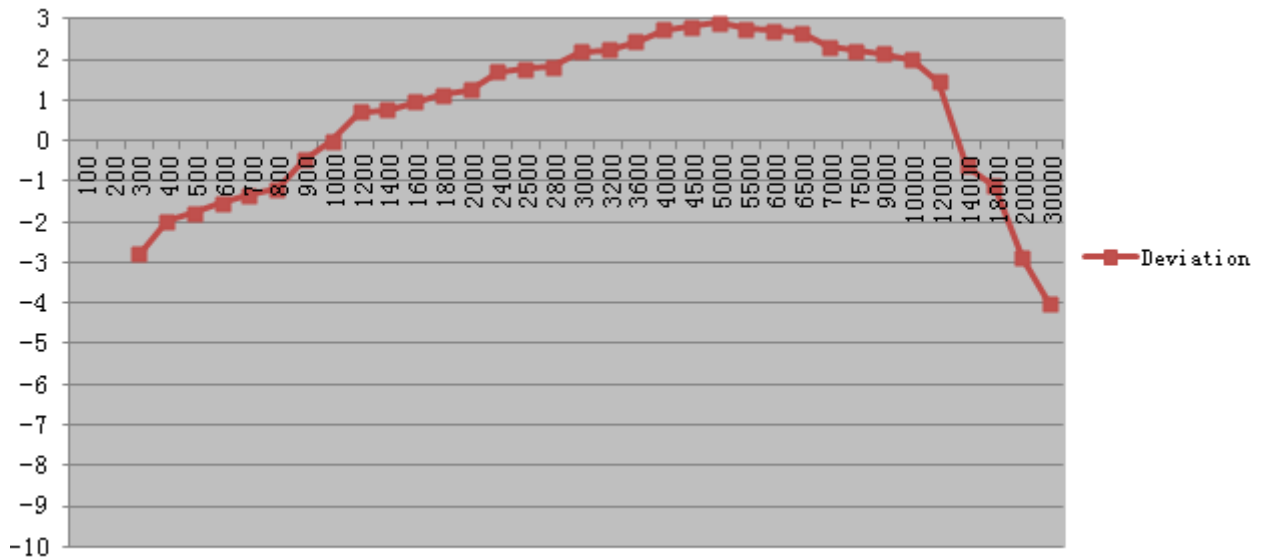

8. FREQUENCY TOLERANCE

8.1 PROVISIONS APPLICABLE

- a). According to FCC Part 2 Section 2.1055(a)(1), the frequency stability shall be measured with variation of ambient temperature from -30°C to $+50^{\circ}\text{C}$ centigrade.
- b). According to FCC Part 2 Section 2.1055(d)(2), for hand carried battery powered equipment, the frequency stability shall be measured with reducing primary supply voltage to the battery operating end point, which is specified by the manufacture.
- c). According to FCC Part 74 Section 74.861(e)-4, the frequency tolerance must be maintained within 0.005%.

8.2 MEASUREMENT PROCEDURE

8.2.1 FREQUENCY STABILITY VERSUS ENVIRONMENTAL TEMPERATURE

- 1) Setup the configuration per figure 7-1 for frequencies measurement inside an environment chamber, install new battery in the EUT.
- 2) Turn on EUT and set SA center frequency to the EUT radiated frequency. Set SA Resolution Bandwidth to 1KHz and Video Resolution Bandwidth to 1KHz and Frequency Span to 50KHz. Record this frequency as reference frequency.
- 3) Set the temperature of chamber to 50°C . Allow sufficient time (approximately 30 min) for the temperature of the chamber to stabilize. While maintaining a constant temperature inside the chamber, turn the EUT on and measure the EUT operating frequency.
- 4) Repeat step 2 with a 10°C decreased per stage until the lowest temperature -30°C is measured, record all measured frequencies on each temperature step.

8.2.2 FREQUENCY STABILITY VERSUS INPUT VOLTAGE

- 1) Setup the configuration per figure 7-1 for frequencies measured at temperature if it is within 15°C to 25°C . Otherwise, an environment chamber set for a temperature of 20°C shall be used. Install new battery in the EUT.
- 2) Set SA center frequency to the EUT radiated frequency. Set SA Resolution Bandwidth to 1 KHz and Video Resolution Bandwidth to 1KHz. Record this frequency as reference frequency.
- 3) For battery operated only device, supply the EUT primary voltage at the operating end point which is specified by manufacturer and record the frequency.

8.3 TEST SETUP BLOCK DIAGRAM

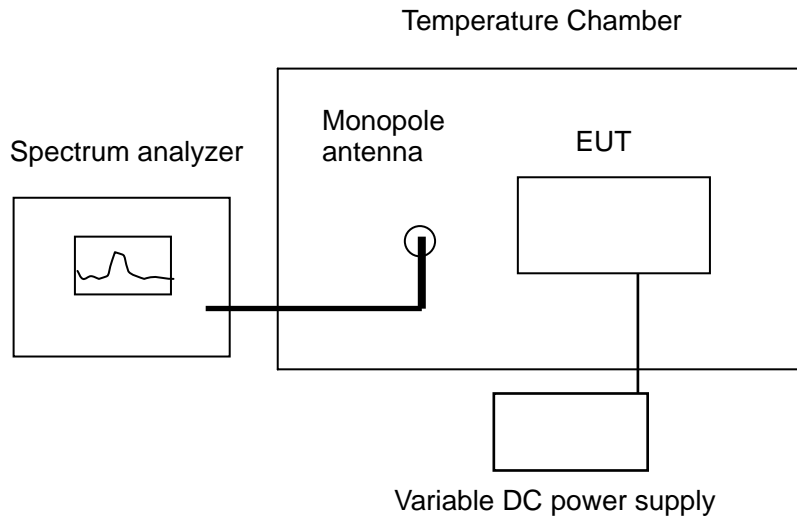

Figure 7-1

8.4 TEST RESULT

a) Frequency stability versus input voltage (battery operation end point voltage is 2.55 V)

Wireless Microphone	Reference Frequency (MHz)	Frequency Measured at End Point Voltage	Frequency Error (%)	Limit (%)
Low channel	177.6	177.60257	0.00145	0.005
Middle Channel	198.6	198.60273	0.00137	0.005
High channel	204.6	204.60399	0.00195	0.005

b) Frequency stability versus ambient temperature

Test Result @ Low Channel

Reference Frequency: 177.600MHz		Limit: ±0.005%	
Environment Temperature (°C)	Power Supply	Frequency deviation measured with time Elapsed (30 minutes)	
		(MHz)	%
50	DC 3V	177.60208	0.00117
40	DC 3V	177.60195	0.00110
30	DC 3V	177.60156	0.00088
20	DC 3V	177.60132	0.00074
10	DC 3V	177.60086	0.00048
0	DC 3V	177.60123	0.00069
-10	DC 3V	177.60165	0.00093
-20	DC 3V	177.60196	0.00110
-30	DC 3V	177.60204	0.00115

Test Result @ Middle Channel

Reference Frequency: 198.600MHz		Limit: $\pm 0.005\%$	
Environment Temperature (°C)	Power Supply	Frequency deviation measured with time Elapsed(30 minutes)	
		(MHz)	%
50	DC 3V	198.60216	0.00109
40	DC 3V	198.60171	0.00086
30	DC 3V	198.60153	0.00077
20	DC 3V	198.60096	0.00048
10	DC 3V	198.60113	0.00057
0	DC 3V	198.60165	0.00083
-10	DC 3V	198.60179	0.00090
-20	DC 3V	198.60193	0.00097
-30	DC 3V	198.60196	0.00099

Test Result @ High Channel

Reference Frequency: 204.600 MHz		Limit: $\pm 0.005\%$	
Environment Temperature (°C)	Power Supply	Frequency deviation measured with time Elapsed (30 minutes)	
		(MHz)	%
50	DC 3V	204.60198	0.00097
40	DC 3V	204.60186	0.00091
30	DC 3V	204.60129	0.00063
20	DC 3V	204.60098	0.00048
10	DC 3V	204.60102	0.00050
0	DC 3V	204.60138	0.00067
-10	DC 3V	204.60159	0.00078
-20	DC 3V	204.60186	0.00091
-30	DC 3V	204.60201	0.00098

9. EMISSION BANDWIDTH

9.1 PROVISIONS APPLICABLE

According to FCC Part 74 Section 74.861(e)-5: The operation bandwidth shall not exceed 200 KHz

9.2 MEASUREMENT PROCEDURE

- 1). The EUT was placed on a turn table which is 0.8m above ground plane.
- 2). Set EUT as normal operation
- 3). Set SPA Center Frequency = fundamental frequency, RBW=10 KHz, VBW=30 KHz, Span =600 KHz.
- 4). Set SPA Max hold. Mark peak, -26dB.

9.3 TEST SETUP BLOCK DIAGRAM

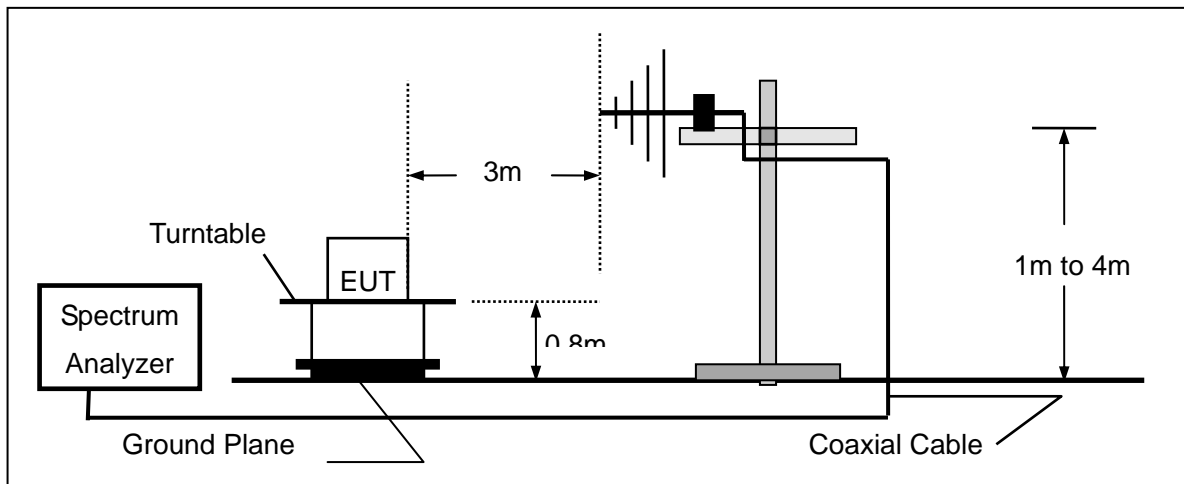

9.4 TEST RESULT

26 dB Test Result			
Operation Channel	Test Data	Limit	Result
Low Channel	60.55 KHz	≤200 KHz	Pass
Middle Channel	60.41 KHz	≤200 KHz	Pass
High Channel	60.63 KHz	≤200 KHz	Pass

Emission Bandwidth @ High Channel

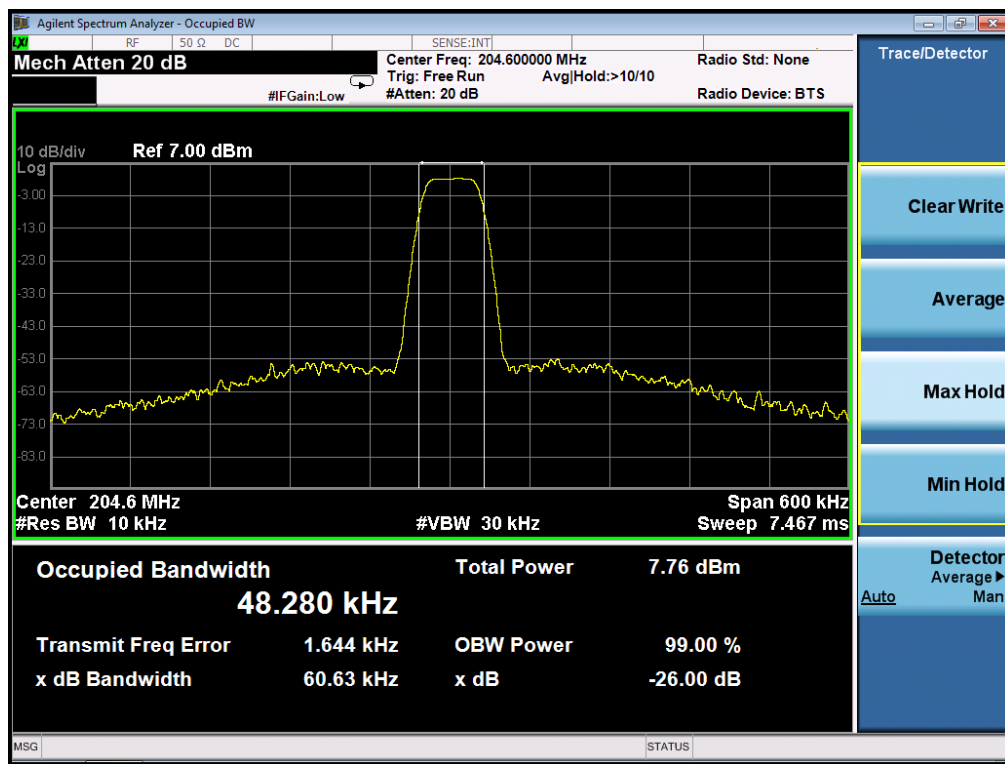

Note: All the above channels (High, middle, Low) were tested, there is only give the worst data.

10. UNWANTED RADIATION

10.1 PROVISIONS APPLICABLE

According to Section 74.861(e)-6, the mean power of emissions shall be attenuated below the mean output power of the transmitter in accordance with the following schedule:

- 1). On any frequency removed from the operating frequency by more than 50 percent up to and including 100 percent of the authorized bandwidth: at least 25 dB;
- 2). On any frequency removed from the operating frequency by more than 100 percent up to and including 250 percent of the authorized bandwidth: at least 35 dB;
- 3). On any frequency removed from the operating frequency by more than 250 percent of the authorized bandwidth:
at least $43 + 10 \log_{10} (TP)$ dB

10.2 MEASUREMENT PROCEDURE

- 1). On a test site, the EUT shall be placed on a turntable, and in the position closest to the normal use as declared by the user.
- 2). The test antenna shall be oriented initially for vertical polarization located 3m from the EUT to correspond to the transmitter.
- 3). The output of the antenna shall be connected to the measuring receiver and either a peak or quasi-peak detector was used for the measurement as indicated on the report. The detector selection is based on how close the emission level was approaching the limit.
- 4). The transmitter shall be switched on; if possible, without the modulation and the measurement receiver shall be tuned to the frequency of the transmitter under test.
- 5). The test antenna shall be raised and lowered through the specified range of height until the measuring receiver detects a maximum signal level.
- 6). The transmitter shall then be rotated through 360° in the horizontal plane, until the maximum signal level is detected by the measuring receiver.
- 7). The test antenna shall be raised and lowered again through the specified range of height until the measuring receiver detects a maximum signal level.
- 8). The maximum signal level detected by the measuring receiver shall be noted.
- 9). The measurement shall be repeated with the test antenna set to horizontal polarization.

- 10). Replace the antenna with a proper Antenna (substitution antenna).
- 11). The substitution antenna shall be oriented for vertical polarization and, if necessary, the length of the substitution antenna shall be adjusted to correspond to the frequency of transmitting.
- 12). The substitution antenna shall be connected to a calibrated signal generator.
- 13). If necessary, the input attenuator setting of the measuring receiver shall be adjusted in order to increase the sensitivity of the measuring receiver.
- 14). The test antenna shall be raised and lowered through the specified range of the height to ensure that the maximum signal is received.
- 15). The input signal to substitution antenna shall be adjusted to the level that produces a level detected by the measuring receiver, that is equal to the level noted while the transmitter radiated power was measured, corrected for the change of input attenuation setting of the measuring receiver.
- 16). The input level to the substitution antenna shall be recorded as power level in dBm, corrected for any change of input attenuator setting of the measuring receiver.
- 17). The measurement shall be repeated with the test antenna and the substitution antenna oriented for horizontal polarization.

10.3 TEST SETUP BLOCK DIAGRAM

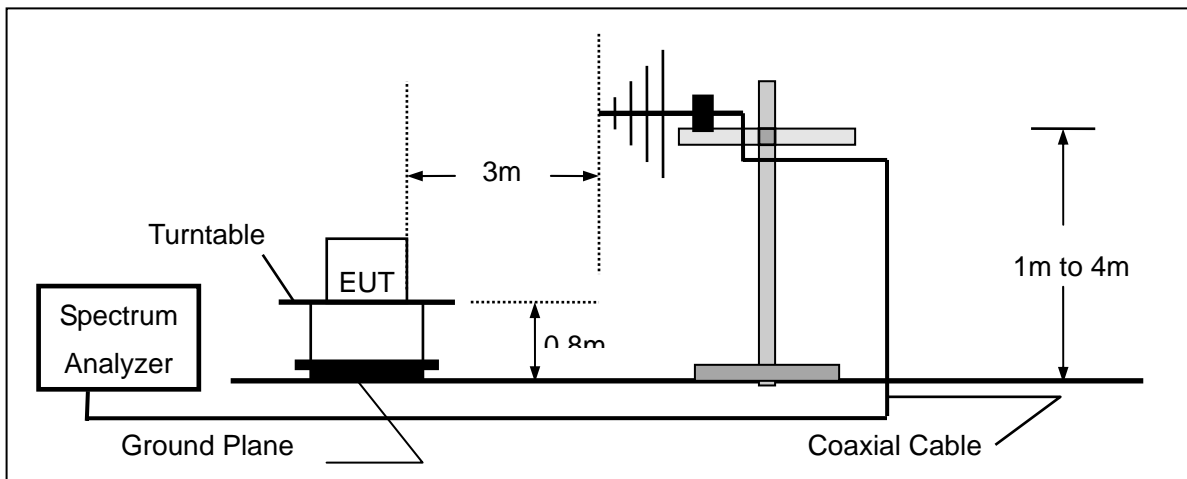

Substitution Method:

Radiation below 1GHz

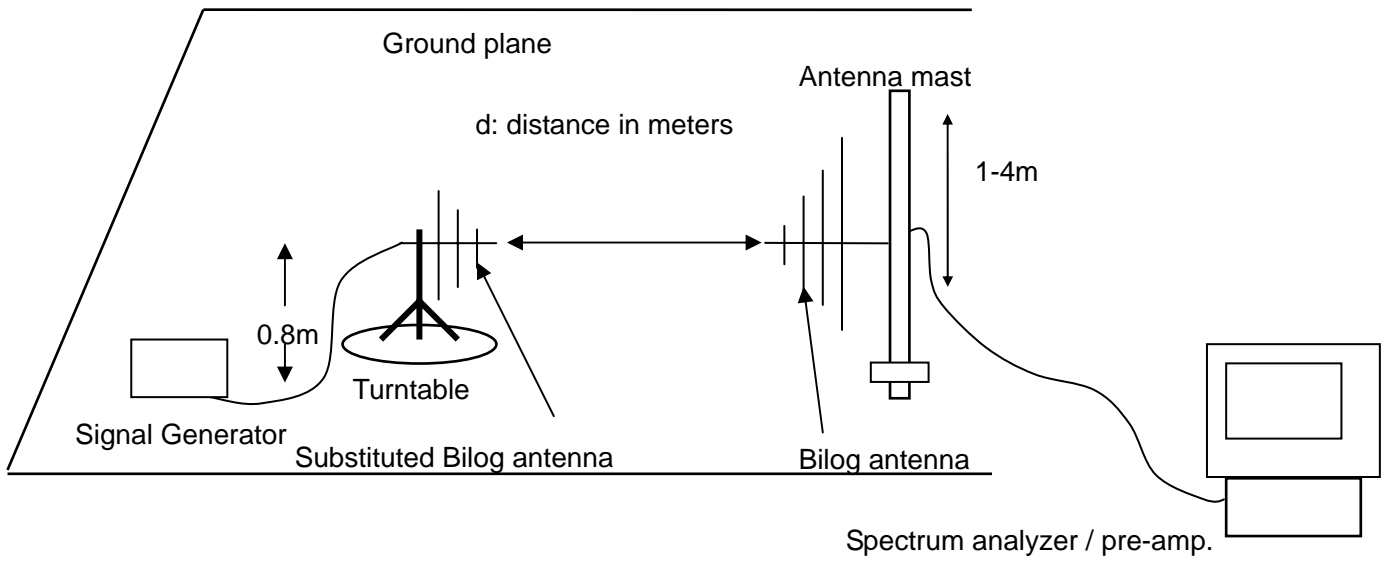

Radiation above 1GHz

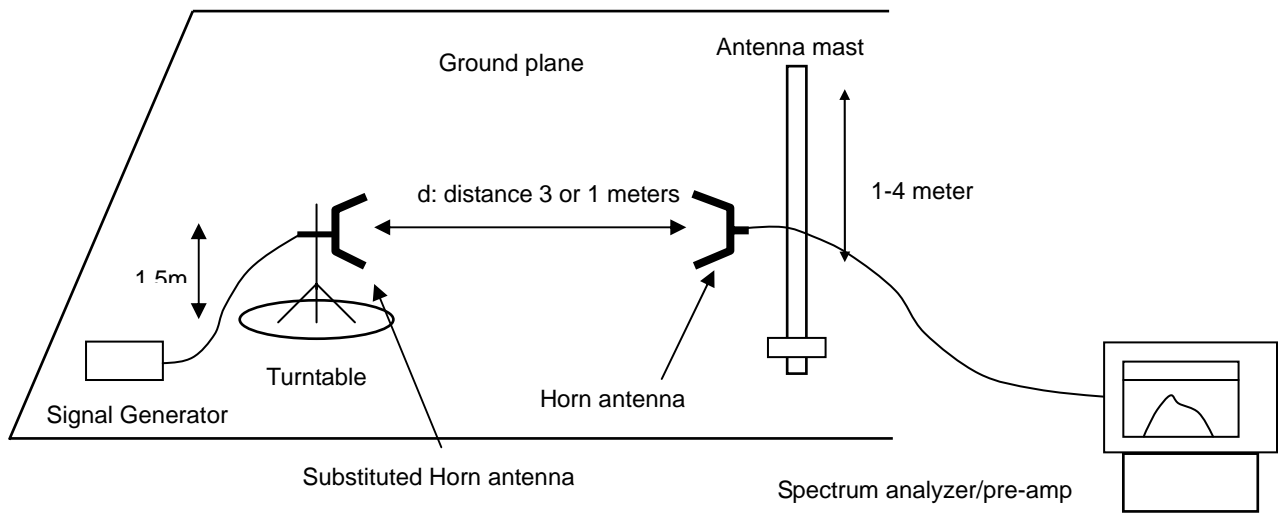

10.4 TEST RESULTS

Calculation: Limit (dBm)= EL-43-10lg (TP)

Notes: No emission found below 30MHz,EL is the emission level of the Output

Power expressed in dBm, TP=[10^(EL/10)]/1000 W.

Limit (dBm)=EL-43-10lg(TP) = -13dBm

Test Result @ Low Channel

Frequency MHz	Polarization	Level dBm	Limit dBm	Margin dB	Pass/Fail
355.2	V	-23.4	-13	10.4	Pass
532.8	V	-26.8	-13	13.8	Pass
710.4	V	-31.5	-13	18.5	Pass
355.2	H	-24.2	-13	11.2	Pass
532.8	H	-29.8	-13	16.8	Pass
710.4	H	-31.5	-13	18.5	Pass
--	V	--	--	--	--
--	H	--	--	--	--

Test Result @ Middle Channel

Frequency MHz	Polarization	Level dBm	Limit dBm	Margin dB	Pass/Fail
397.2	V	-24.2	-13	11.2	Pass
595.8	V	-26.3	-13	13.3	Pass
794.4	V	-30.5	-13	17.5	Pass
397.2	H	-25.7	-13	12.7	Pass
595.8	H	-28.6	-13	15.6	Pass
794.4	H	-30.7	-13	17.7	Pass
--	V	--	--	--	--
--	H	--	--	--	--

Test Result @ High Channel

Frequency MHz	Polarization	Level dBm	Limit dBm	Margin dB	Pass/Fail
409.2	V	-23.8	-13	10.8	Pass
613.8	V	-25.7	-13	12.7	Pass
818.4	V	-30.9	-13	17.9	Pass
409.2	H	-25.7	-13	12.7	Pass
613.8	H	-27.6	-13	14.6	Pass
818.4	H	-31.8	-13	18.8	Pass
--	V	--	--	--	--
--	H	--	--	--	--

Notes: -- means the output power of all the spurious frequency is at least 20dB down to the limit.

Emission Mask @ High Channel

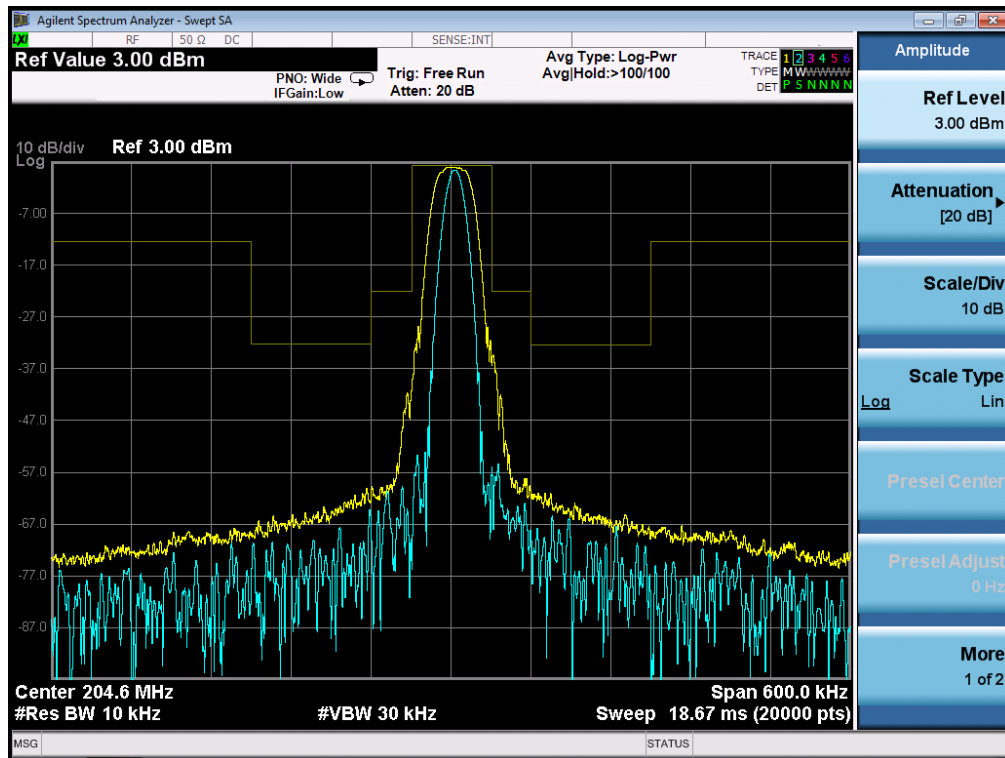

APPENDIX I : PHOTOGRAPHS OF TEST SETUP
RADIATED EMISSION TEST SETUP

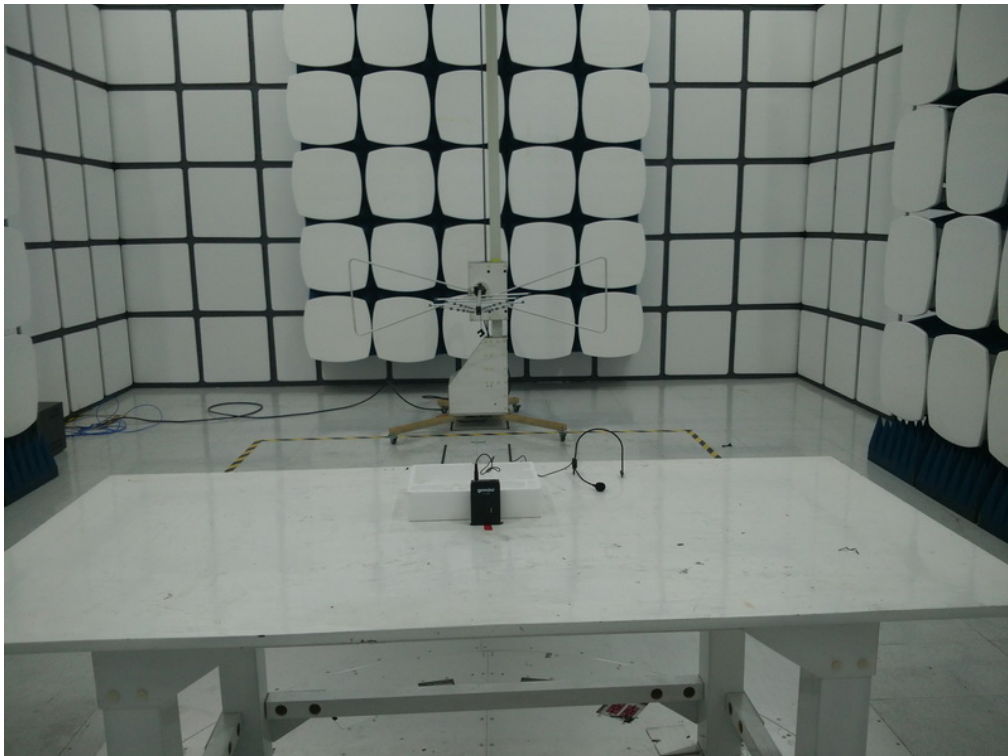

APPENDIX II: PHOTOGRAPHS OF EUT TOTAL VIEW OF EUT



TOP VIEW OF EUT



BOTTOM VIEW OF EUT



FRONT VIEW OF EUT



BACK VIEW OF EUT

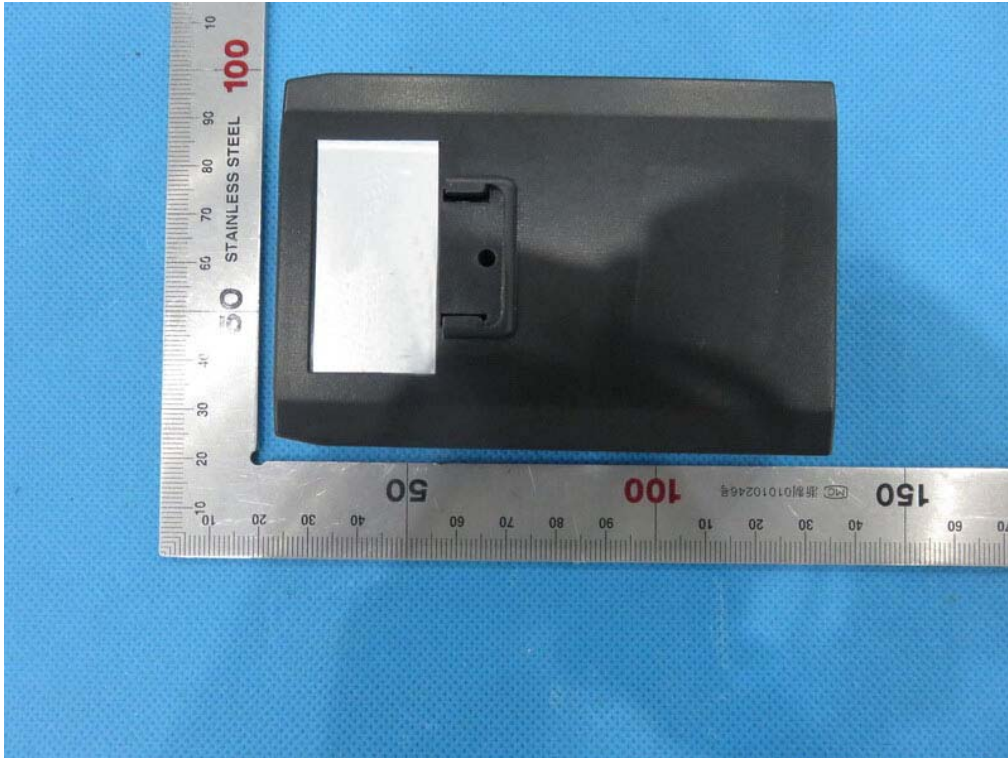

LEFT VIEW OF EUT

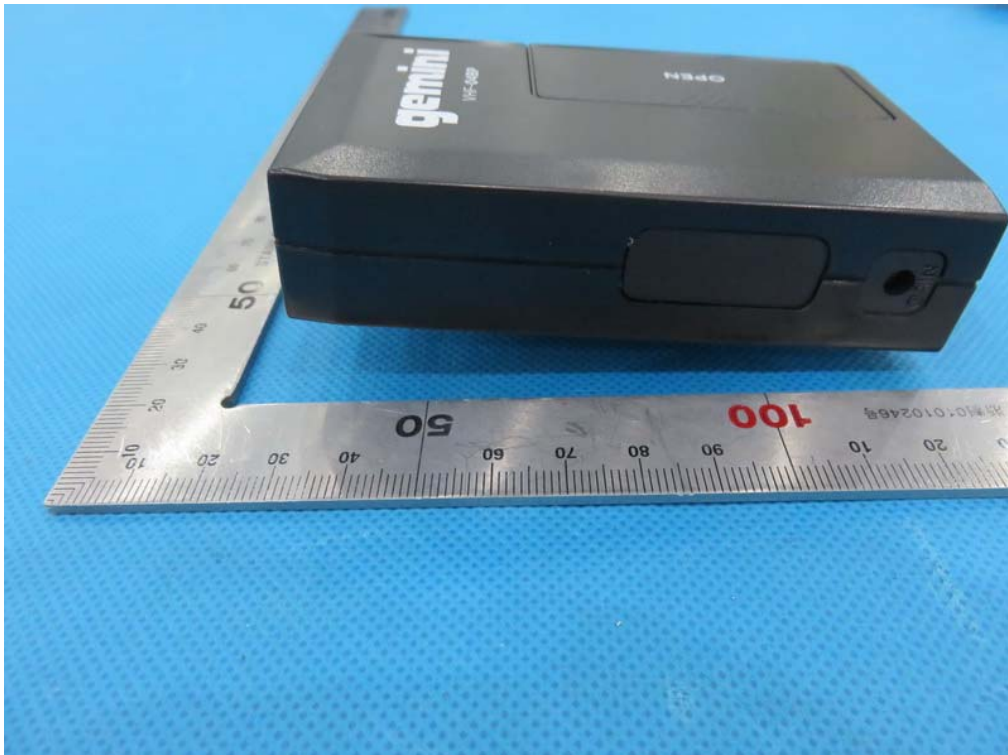

RIGHT VIEW OF EUT



OPEN VIEW OF EUT

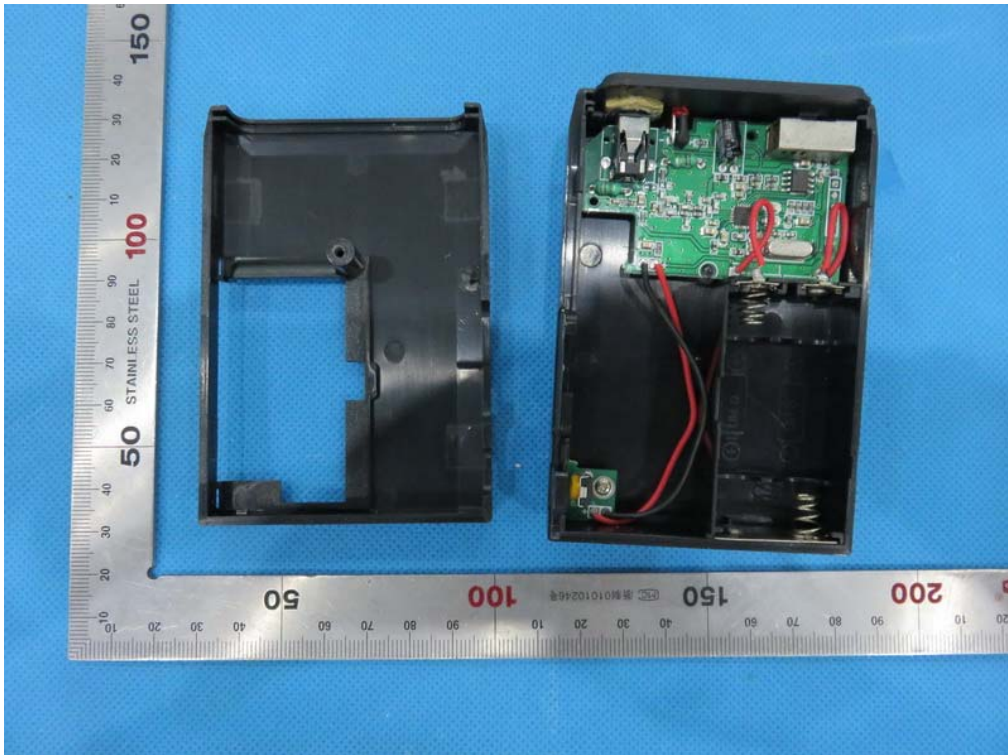

INTERNAL VIEW OF EUT-1

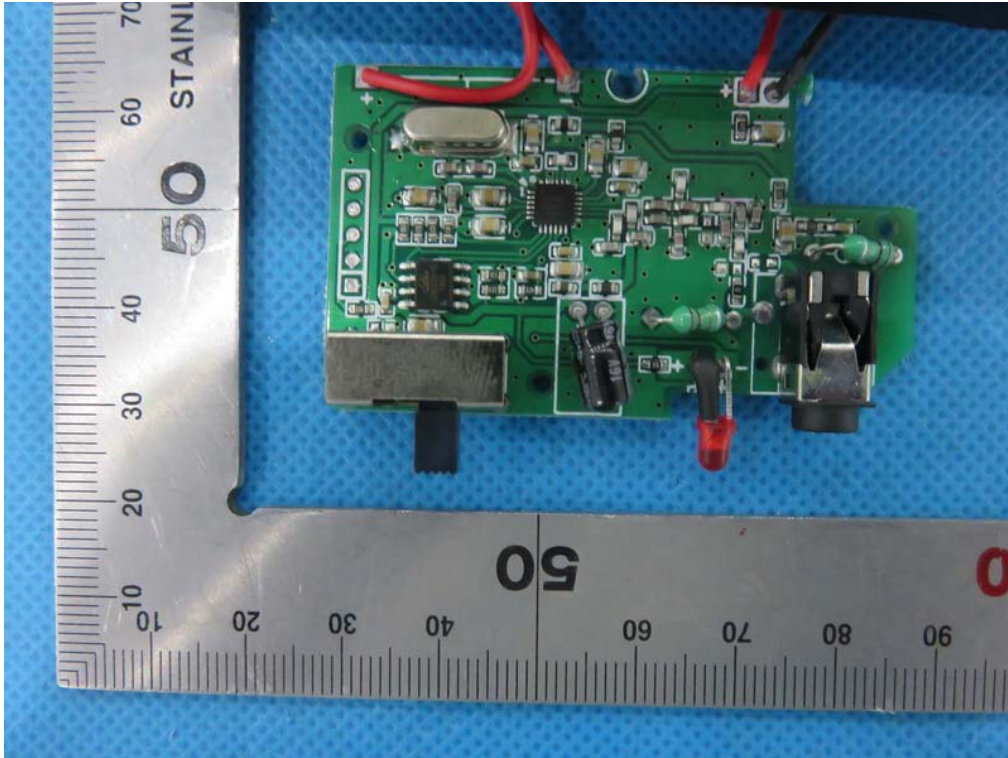

INTERNAL VIEW OF EUT-2

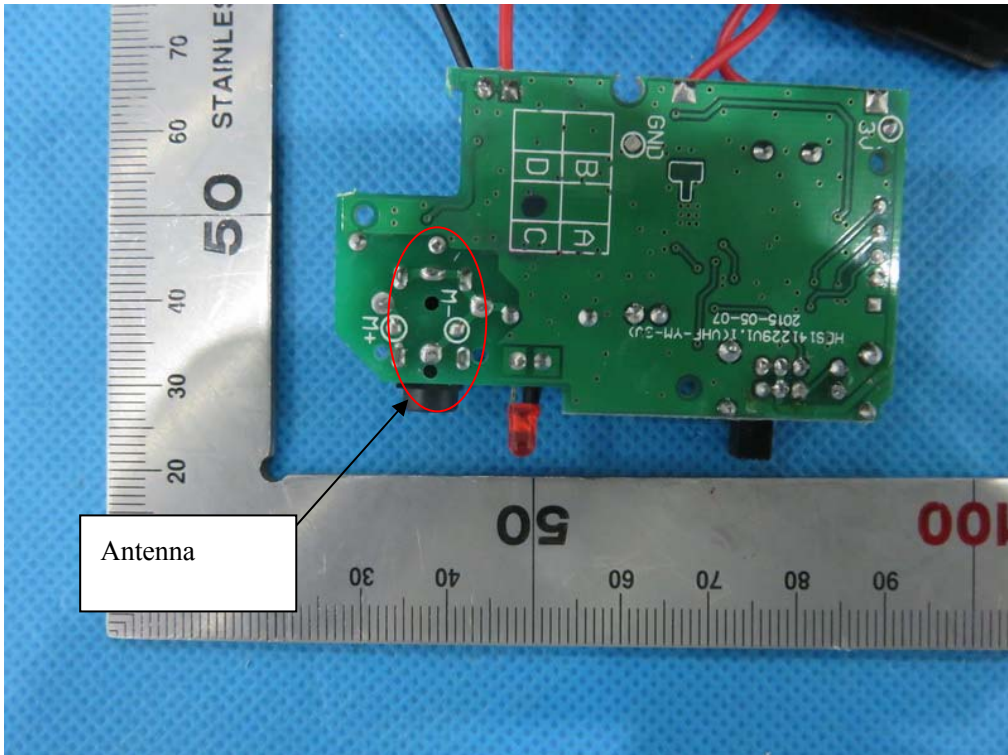

INTERNAL VIEW OF EUT-3

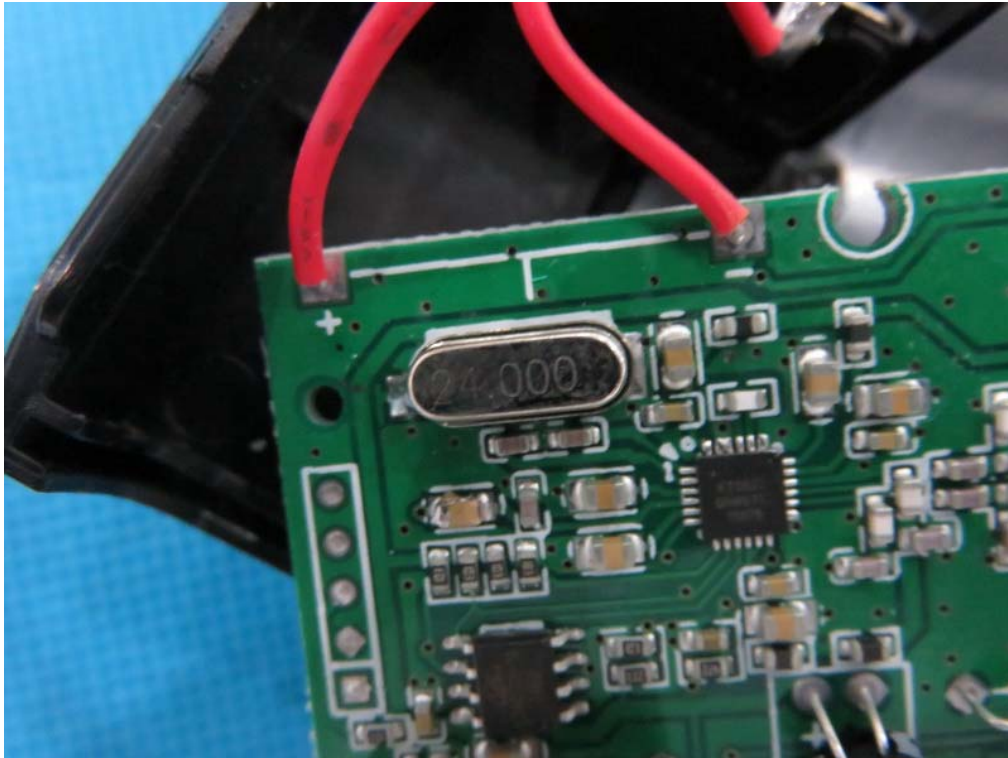

---END OF REPORT---