



**FCC 47 CFR PART 15 SUBPART C 15.247
TEST REPORT
FOR
BLUETOOTH SPEAKER**

Model : ALP-XP800,ALP-XP800 BLU,ALP-XP800 GRN,
ALP-XP800 RDSX,ALP-XP800 RDSKN,ALP-XP800 CMO

Issued to
INNOVATIVE CONCEPTS AND DESIGN LLC
107 TRUMBULL STREET, BLDG F8, ELIZABETH, NJ 07206

Issued by
WH Technology Corp.



Open Site	No.120, Ln. 5, Hudong St., Xizhi Dist., New Taipei City 221, Taiwan (R.O.C.)	
EMC Test Site	Xizhi Office and Lab	7F., No.262, Sec. 3, Datong Rd., Xizhi Dist., New Taipei City 221, Taiwan (R.O.C.)
Tel.: +886-2-7729-7707 Fax: +886-2- 8648-1311		

Note: This test refers exclusively to the test presented test model and sample. This report shall not be reproduced except in full, without the written approval of WH Technology Corp. This document may be altered or revised by WH Technology Corp. Personnel only, and shall be noted in the revision section of the document.



Contents

PHOTOS OF EUT 1. General Information.....	3
1. General Information.....	4
2. Report of Measurements and Examinations.....	5
2.1 List of Measurements and Examinations.....	5
3. Test Configuration of Equipment under Test.....	6
3.1 Description of the tested samples.....	6
3.2 Carrier Frequency of Channels.....	7
3.3 Test Mode and Test Software.....	8
3.4 TEST Methodology & General Test Procedures.....	9
3.5 Measurement Uncertainty.....	10
3.6 Description of the Support Equipments.....	10
4. Test and measurement equipment.....	11
4.1 calibration.....	11
4.2 equipment.....	11
5. Antenna Requirements.....	14
5.1 Standard Applicable.....	14
5.2 Antenna Construction and Directional Gain.....	14
6. Test of Conducted Emission.....	15
6.1 Test Limit.....	15
6.2 Test Procedures.....	15
6.3 Typical Test Setup.....	16
6.4 Test Result and Data.....	17
7. Test of Radiated Emission.....	19
7.1 Test Limit.....	19
7.2 Test Procedures.....	19
7.3 Typical Test Setup.....	20
7.4 Test Result and Data (9kHz ~ 30MHz).....	22
7.5 Test Result and Data (30MHz ~ 1GHz, worst emissions found).....	22
7.6 Test Result and Data (Above 1GHz).....	24
7.7 Restrict Band Emission Measurement Data.....	26
8. Bandwidth Measurement Data.....	29
8.1 Test Limit.....	29
8.2 Test Procedures.....	29
8.3 Test Setup Layout.....	29
8.4 Test Result and Data.....	30
9. Maximum Peak Output Power.....	35
9.1 Test Limit.....	35
9.2 Test Procedures.....	35



9.3	Test Setup Layout	35
9.4	Test Result and Data	36
10.	Carrier Frequency Separation	37
10.1	Test Limit	37
10.2	Test Procedures	37
10.3	Test Setup Layout	37
10.4	Test Result and Data	38
11.	Number Of Hopping Channel.....	40
11.1	Test Limit	40
11.2	Test Procedure	40
11.3	Test Setup Layout	40
11.4	Test Result and Data	41
12.	Dwell Time	43
12.1	Test Limit	43
12.2	Test Procedure	43
12.3	Test Setup Layout	43
12.4	Test Result and Data	44
13.	Band Edges Measurement	49
13.1	Test Limit	49
13.2	Test Procedure	49
13.3	Test Setup Layout	49
13.4	Test Result and Data	50
14.	Restricted Bands of Operation	54
14.1	Labeling Requirement.....	54

APPENDIX 1 PHOTOS OF TEST CONFIGURATION

APPENDIX 2 PHOTOS OF EUT



1. General Information

Applicant : **INNOVATIVE CONCEPTS AND DESIGN LLC**

Address : **107 TRUMBULL STREET, BLDG F8, ELIZABETH,
NJ 07206**

Manufacturer : **SHENZHEN YOUJUN ELECTRONICS LIMITED**

Address : **#12B,the first industrial Area,Fu min Boulevard Bai hua
Community,Guang ming street Guang ming new
Dist,Shenzhen City,China**

EUT : **BLUETOOTH SPEAKER**

Model Name : **ALP-XP800,ALP-XP800 BLU,ALP-XP800 GRN,
ALP-XP800 RDSX,ALP-XP800 RDSKN,ALP-XP800 CMO**

Model Differences : **All models are identical except model name and
colors.**

Is here with confirmed to comply with the requirements set out in the FCC Rules and Regulations Part 15 Subpart C and the measurement procedures were according to ANSI C63.10-2013. The said equipment in the configuration described in this report shows the maximum emission levels emanating

FCC part 15 subpart C

Receipt Date : 12/03/2017

Final Test Date : 12/19/2017

Tested By:

Reviewed by:

Dec. 20, 2017

Dec. 20, 2017

Date

Bell Wei/ Engineer

Date

Mike Lee / Manager
Designation Number: TW1083



2. Report of Measurements and Examinations

2.1 List of Measurements and Examinations

FCC Rule	Description of Test	Result
Maximum Peak Output Power	FCC Part 15: 15.247(b)(1) ANSI C63.4 :2014&RSS-247 5.4(2) & ANSI C63.10 :2013	Pass
Bandwidth	FCC Part 15: 15.215 ANSI C63.4 :2014&RSS-247 5.1(2) & ANSI C63.10 :2013	Pass
Carrier Frequency Separation	FCC Part 15: 15.247(a)(1) ANSI C63.4 :2014& RSS-247 5.1(2) & ANSI C63.10 :2013	Pass
Number Of Hopping Channel	FCC Part 15: 15.247(a)(1)(iii) ANSI C63.4 :2014&RSS-247 5.1(4) & ANSI C63.10 :2013	Pass
Dwell Time	FCC Part 15: 15.247(a)(1)(iii) ANSI C63.4 :2014&RSS-247 5.1(4) & ANSI C63.10 :2013	Pass
Radiated Emission	FCC Part 15: 15.209 FCC Part 15: 15.247(d) ANSI C63.4 :2014&RSS-247 Section 5.5& ANSI C63.10 :2013	Pass
Band Edge Compliance	FCC Part 15: 15.247(d) ANSI C63.4 :2014&RSS-247 Section 5.5& ANSI C63.10 :2013	Pass
Power Line Conducted Emissions	FCC Part 15: 15.207 ANSI C63.4 :2014&IC RSS Gen, Section 7.2.4& ANSI C63.10 :2013	Pass
Antenna requirement	15: 15.203 &IC RSS Gen, Section 7.1.4	Pass



3. Test Configuration of Equipment under Test

3.1 Description of the tested samples

EUT Name : BLUETOOTH SPEAKER

Model Number : ALP-XP800

FCCID : 2AE6GALP-XP800

Receipt Date : 12/04/2017

Power From : Inside Outside
Adaptor Battery AC Power Source
DC Power Source Support Unit PC or NB

Operate Frequency : Refer to the channel list as described below (2.402 ~2.480 GHz)

Modulation Technique : GFSK, π /4DQPSK,8DPSK

Number of Channels : 79

Channel spacing : N/A 1 MHz

Operating Mode : Simplex Half Duplex

Bluetooth version : V4.2

Antenna Type : PCB Antenna

Antenna gain : 0 dBi



3.2 Carrier Frequency of Channels

Channel	Frequency (MHz)	Channel	Frequency (MHz)	Channel	Frequency (MHz)
00	2402	27	2429	54	2456
01	2403	28	2430	55	2457
02	2404	29	2431	56	2458
03	2405	30	2432	57	2459
04	2406	31	2433	58	2460
05	2407	32	2434	59	2461
06	2408	33	2435	60	2462
07	2409	34	2436	61	2463
08	2410	35	2437	62	2464
09	2411	36	2438	63	2465
10	2412	37	2439	64	2466
11	2413	38	2440	65	2467
12	2414	39	2441	66	2468
13	2415	40	2442	67	2469
14	2416	41	2443	68	2470
15	2417	42	2444	69	2471
16	2418	43	2445	70	2472
17	2419	44	2446	71	2473
18	2420	45	2447	72	2474
19	2421	46	2448	73	2475
20	2422	47	2449	74	2476
21	2423	48	2450	75	2477
22	2424	49	2451	76	2478
23	2425	50	2452	77	2479
24	2426	51	2453	78	2480
25	2427	52	2454	--	--
26	2428	53	2455	--	--



3.3 Test Mode and Test Software

- a. During testing, the interface cables and equipment positions were varied according to ANSI C63.4.
- b. The complete test system included Notebook and EUT for RF test.
- c. Test Software: Radio Test.exe
- d. New Battery was used for all testing and the worst radiated emission case from X,Y and Z axis evaluation was selected for testing.
- e. The following test modes were performed for test:
 - BT: CH00: 2402MHz, CH39: 2441MHz, CH78: 2480MHz



3.4 TEST Methodology & General Test Procedures

All testing as described bellowed were performed in accordance with ANSI C63.4:2014 and ANSI C63.10:2013.

Conducted Emissions

The EUT is placed on a wood table, which is at 0.8 m above ground plane acceding to clause 15.207 and requirements of ANSI C63.4:2014. Conducted emissions from the EUT measured in the frequency range between 0.15 MHz and 30MHz are using CISPR Quasi-Peak / Average detectors.

Radiated Emissions

The EUT is a placed on a turn table, which is 0.8 m above ground plane. The turntable was rotated through 360 degrees to determine the position of maximum emission level. The EUT is placed at 3m away from the receiving antenna, which varied from 1m to 4m to find out the highest emission. Each emission was to be maximized by changing the polarization of receiving antenna both horizontal and vertical.

- 1) Putting the EUT on the platform and turning on the EUT (on/off button on the bottom of the EUT).
- 2) Setting test channel described as “Channel setting and operating condition”, and testing channel by channel.
- 3) For the maximum output power measurement, we followed the method of measurement KDB558074 D01.
- 4) For the spurious emission test based on ANSI(2014), at the frequency where below 1GHz used quasi-peak detector mode; where above 1GHz used the peak and average detector mode. IF the peak value may be under average limit, the average mode will not be performed.



3.5 Measurement Uncertainty

Measurement Item	Uncertainty
Peak Output Power(conducted)	±1.345dB
Power Spectral Density	±1.347dB
Radiated emission(1G-25GHz)	±5.00dB
Radiated emission(30M-1GHz)	±3.89dB
Conducted emission	±1.81dB

3.6 Description of the Support Equipments

Setup Diagram

See test photographs attached in appendix 1 for the actual connections between EUT and support equipment.

Support Equipment

Peripherals Devices:

OUTSIDE SUPPORT EQUIPMENT							
No.	Equipment	Model	Serial No.	FCC ID/ BSMI ID	Trade name	Data Cable	Power Cord
1.	N/A	N/A	N/A	N/A	N/A	N/A	N/A
INSIDE SUPPORT EQUIPMENT							
No.	Equipment	Model	Serial No.	FCC ID/ BSMI ID	Trade name	Data Cable	Power Cord
1.	Li-ion Battery	18650	N/A	N/A	N/A	N/A	N/A

Note: All the above equipment /cable were placed in worse case position to maximize emission signals during emission test

Grounding: Grounding was in accordance with the manufacturer's requirement and conditions for the intended use.



4. Test and measurement equipment

4.1 calibration

The measuring equipment utilized to perform the tests documented in the report has been calibrated once a year or in accordance with the manufacturer's recommendations, and is traceable to recognized national standards.

4.2 equipment

The following list contains measurement equipment used for testing. The equipment conforms to the requirement of CISPR 16-1, ANSI C63.2 and. Other required standards.

Calibration of all test and measurement, including any accessories that may effect such calibration, is checked frequently to ensure the accuracy. Adjustments are made and correction factors are applied in accordance with the instructions contained in the respective.



TABLELIST OF TEST AND MEASUREMENT EQUIPMENT

Test Site	Instrument	Manufacturer	Model No.	S/N	Next Cal. Date
Conduction	Spectrum (9K--3GHz)	R&S	FSP3	833387/010	2018/09/20
	EMI Receiver	R&S	ESHS10	830223/008	2018/05/22
	LISN	Rolf Heine Hochfrequenztechnik	NNB-2/16z	98062	2018/05/25
	ISN	Schwarzbeck	8-Wire ISN CAT5	CAT5-8158-0094	2018/09/21
	RF Cable	N/A	N/A	EMI-3	2018/10/19
Radiation	Bilog antenna(30M-1G)	ETC	MCTD2786B	BLB16M04004/J B-5-004	2018/05/03
	Double Ridged Guide Horn antenna(1G-18G)	ETC	MCTD 1209	DRH15N0 2009	2018/11/23
	Horn antenna (18G-26G)	com-power	AH-826	81000	2018/08/15
	LOOP Antenna (Below 30M)	com-power	AL-130	17117	2018/10/04
	Pre amplifier (30M-1G)	EMC INSTRUMENT	EMC9135	980334	2018/05/04
	Microwave Preamplifier (1G-18G)	EMC INSTRUMENT	EMC051845	980108&AT -18001	2018/10/23
	Pre amplifier (18G~26G)	MITEQ	JS4-18002600-3 0-5A	808329	2018/08/10
	EMI Test	R&S	ESVS30	826006/002	2018/11/28



	Receiver		(20M-1000MHz)		
	RF Cable (open site)	EMCI	N male on end of both sides (EMI4)	30m	2018/10/19
	RF CABLE (1~26.5G)	HARBOUT INDUSTRIES	LL142MI(4M+4M)	NA	2018/03/08
	RF CABLE (1~26.5G)	HARBOUR INDUSTRIES	LL142MI(7M)	NA	2018/08/11
	Spectrum (9K--7GHz)	R&S	FSP7	830180/006	2018/03/25
	Spectrum (9K--40GHz)	AGILENT	8564EC	4046A0032	2018/03/01
Software	e3	AUDIX	N/A	N/A	N/A

***CALIBRATION INTERVAL OF INSTRUMENTS LISTED ABOVE IS ONE YEAR**



5. Antenna Requirements

5.1 Standard Applicable

For intentional device, according to FCC 47 CFR Section 15.203, an intentional radiator shall be designed to ensure that no antenna other than that furnished by the responsible party shall be used with the device.

And according to FCC 47 CFR Section 15.247 (b), if transmitting antennas of directional gain greater than 6dBi are used, the power shall be reduced by the amount in dB that the directional gain of the antenna exceeds 6dBi.

5.2 Antenna Construction and Directional Gain

Antenna Type: PCB Antenna

Antenna Gain: 0 dBi



6. Test of Conducted Emission

6.1 Test Limit

Conducted Emissions were measured from 150 kHz to 30 MHz with a bandwidth of 9 KHz on the 120 VAC power and return leads of the EUT according to the methods defined in ANSI C63.4-2014 Section 3.1. The EUT was placed on a nonmetallic stand in a shielded room 0.8 meters above the ground plane as shown in section 2.2. The interface cables and equipment positioning were varied within limits of reasonable applications to determine the position produced maximum conducted emissions.

Frequency (MHz)	Quasi Peak (dB μ V)	Average (dB μ V)
0.15 – 0.5	66-56*	56-46*
0.5 – 5.0	56	46
5.0 – 30.0	60	50

*Decreases with the logarithm of the frequency.

6.2 Test Procedures

- a. The EUT was placed 0.4 meter from the conducting wall of the shielding room was kept at least 80 centimeters from any other grounded conducting surface.
- b. Connect EUT to the power mains through a line impedance stabilization network (LISN).
- c. All the support units are connecting to the other LISN.
- d. The LISN provides 50 ohm coupling impedance for the measuring instrument.
- e. The FCC states that a 50 ohm, 50 micro-Henry LISN should be used.
- f. Both sides of AC line were checked for maximum conducted interference.
- g. The frequency range from 150 kHz to 30 MHz was searched.
- h. Set the test-receiver system to Peak Detect Function and Specified Bandwidth with Maximum Hold Mode.



6.3 Typical Test Setup

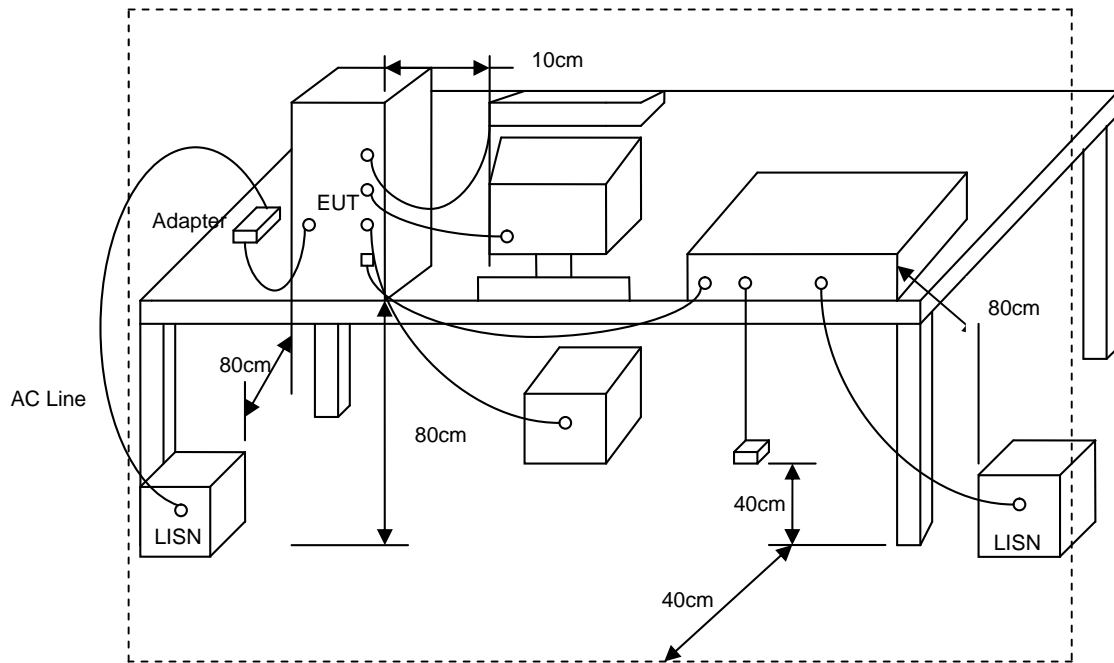



6.4 Test Result and Data

Power	: AC 120V/60Hz	Pol/Phase	: LINE
Test Mode 1	: TX CH39	Temperat	: 24.6 °C
Note	:	Humidity	: 57 %

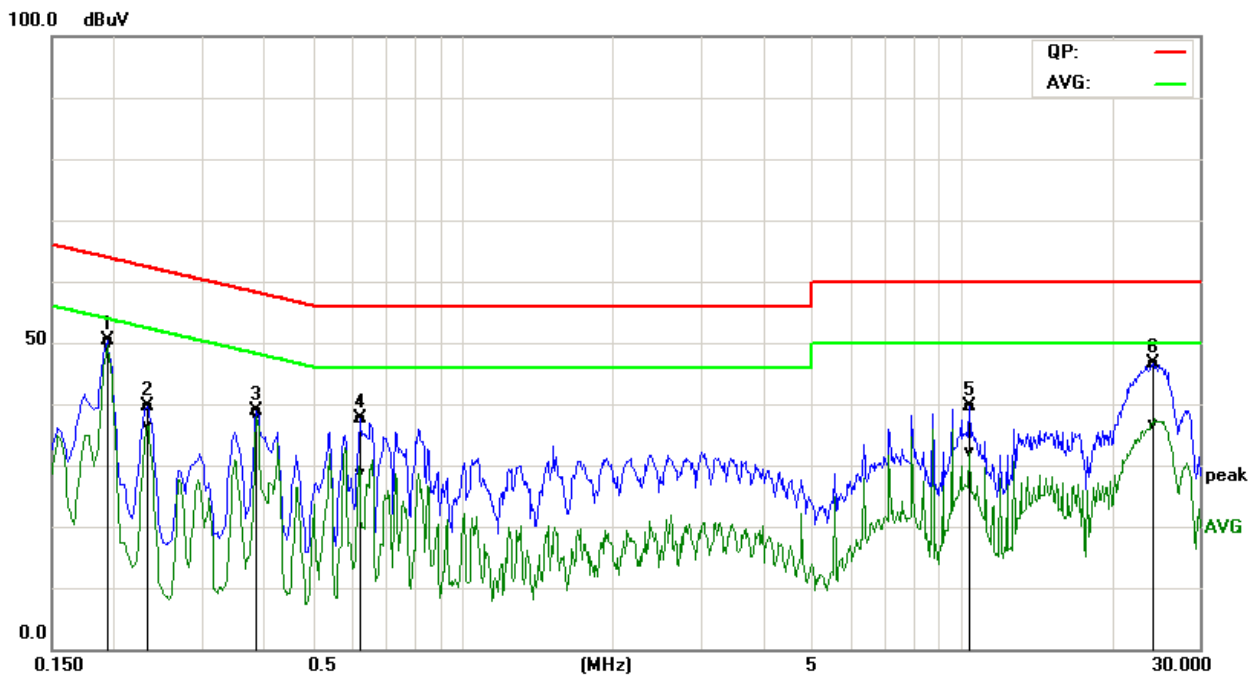

No.	Frequency (MHz)	QuasiPeak reading (dBuV)	Average reading (dBuV)	Correction factor (dB)	QuasiPeak result (dBuV)	Average result (dBuV)	QuasiPeak limit (dBuV)	Average limit (dBuV)	QuasiPeak margin (dB)	Average margin (dB)	Remark
1*	0.1940	40.78	39.81	9.69	50.47	49.50	63.86	53.86	-13.39	-4.36	Pass
2P	0.2340	29.78	26.53	9.95	39.73	36.48	62.31	52.31	-22.58	-15.83	Pass
3P	0.3860	28.99	27.87	9.91	38.90	37.78	58.15	48.15	-19.25	-10.37	Pass
4P	0.6220	27.61	18.79	9.92	37.53	28.71	56.00	46.00	-18.47	-17.29	Pass
5P	10.3660	29.63	21.94	10.09	39.72	32.03	60.00	50.00	-20.28	-17.97	Pass
6P	24.1740	35.86	25.93	10.73	46.59	36.66	60.00	50.00	-13.41	-13.34	Pass



Power	: AC 120V/60Hz	Pol/Phase	: NEUTRAL
Test Mode 1	: TX CH39	Temperatur	: 24.6 °C
Note	:	Humidity	: 57 %

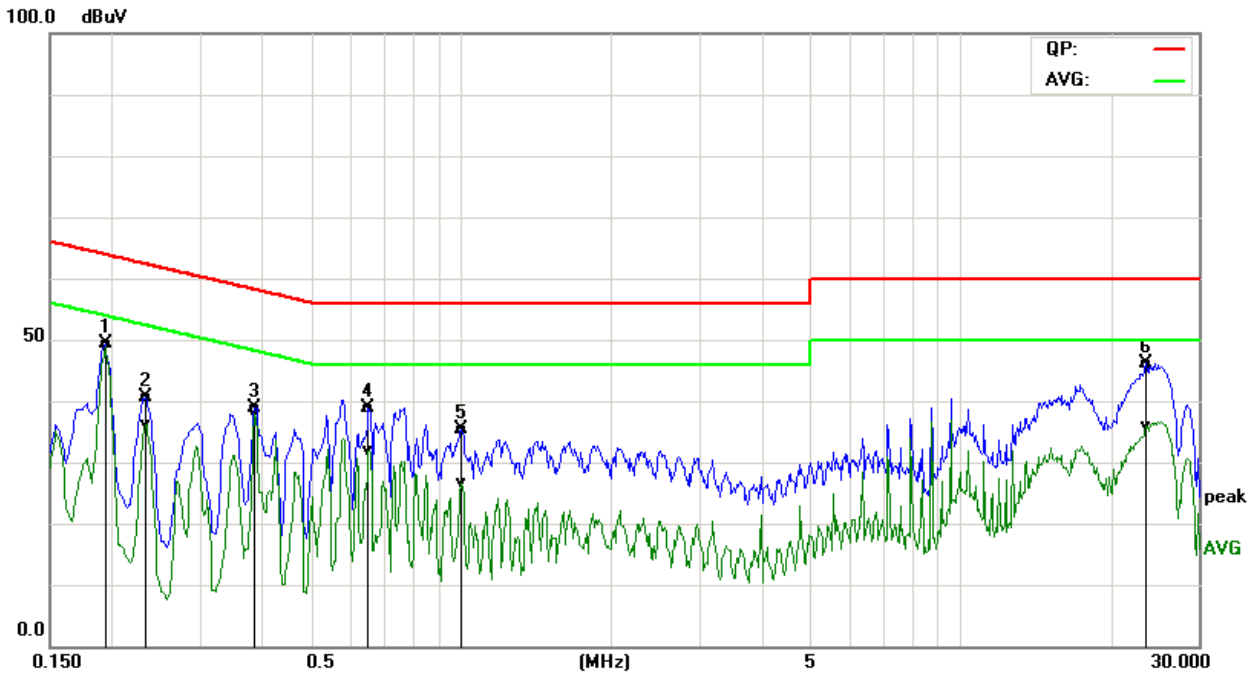

No.	Frequency (MHz)	QuasiPeak reading (dBuV)	Average reading (dBuV)	Correction factor (dB)	QuasiPeak result (dBuV)	Average result (dBuV)	QuasiPeak limit (dBuV)	Average limit (dBuV)	QuasiPeak margin (dB)	Average margin (dB)	Remark
1*	0.1940	39.65	39.08	9.69	49.34	48.77	63.86	53.86	-14.52	-5.09	Pass
2P	0.2340	30.64	26.20	9.95	40.59	36.15	62.31	52.31	-21.72	-16.16	Pass
3P	0.3860	29.08	28.08	9.91	38.99	37.99	58.15	48.15	-19.16	-10.16	Pass
4P	0.6540	29.05	21.84	9.93	38.98	31.77	56.00	46.00	-17.02	-14.23	Pass
5P	1.0020	25.23	16.72	10.03	35.26	26.75	56.00	46.00	-20.74	-19.25	Pass
6P	23.6340	35.35	25.04	10.77	46.12	35.81	60.00	50.00	-13.88	-14.19	Pass



7. Test of Radiated Emission

7.1 Test Limit

In any 100kHz bandwidth outside the frequency band in which the spread spectrum or digitally modulated intentional radiator is operating, the radio frequency power that is produced by the intentional radiator shall be at least 20dB below that in the 100kHz bandwidth within the band that contains the highest level of the desired power, based on either an RF conducted or a radiated measurement. If the transmitter measurement is based on the maximum conducted output power, the attenuation required under this paragraph shall be 30dB instead of 20dB. In addition, radiated emissions which fall in section 15.205(a) the restricted bands must also comply with the radiated emission limit specified in section 15.209(a).

Frequency (MHz)	Field Strength (microvolt/meter)	Measurement Distance (meters)
0.009 ~ 0.490	2400/F(kHz)	300
0.490 ~ 1.705	24000/F(kHz)	30
1.705 ~ 30.0	30	30
30 ~ 88	100	3
88 ~ 216	150	3
216 ~ 960	200	3
Above 960	500	3

7.2 Test Procedures

- a. The EUT was placed on a rotatable table top 0.8 meter above ground.
- b. The EUT was set 3 meters from the interference receiving antenna which was mounted on the top of a variable height antenna tower.
- c. The table was rotated 360 degrees to determine the position of the highest radiation.
- d. The antenna is a broadband antenna and its height is varied between one meter and four meters above ground to find the maximum value of the field strength both horizontal polarization and vertical polarization of the antenna are set to make the measurement.
- e. For each suspected emission the EUT was arranged to its worst case and then tune the antenna tower (from 1 M to 4 M) and turn table (from 0 degree to 360 degrees) to find the maximum reading.
- f. Set the test-receiver system to Peak or CISPR quasi-peak Detect Function and specified bandwidth with Maximum Hold Mode.
- g. If the emission level of the EUT in peak mode was 3 dB lower than the limit specified, then testing will be stopped and peak values of EUT will be reported, otherwise, the emissions which do not have 3 dB margin will be repeated one by one using the quasi-peak method and reported.
- h. For testing above 1GHz, the emission level of the EUT in peak mode was 20dB lower than average limit (that means the emission level in peak mode also complies with the limit in



average mode), then testing will be stopped and peak values of EUT will be reported, otherwise, the emissions will be measured in average mode again and reported.

- i. "Cone of radiation" has been considered to be 3dB bandwidth of the measurement antenna.

7.3 Typical Test Setup

For radiated emissions below 30MHz

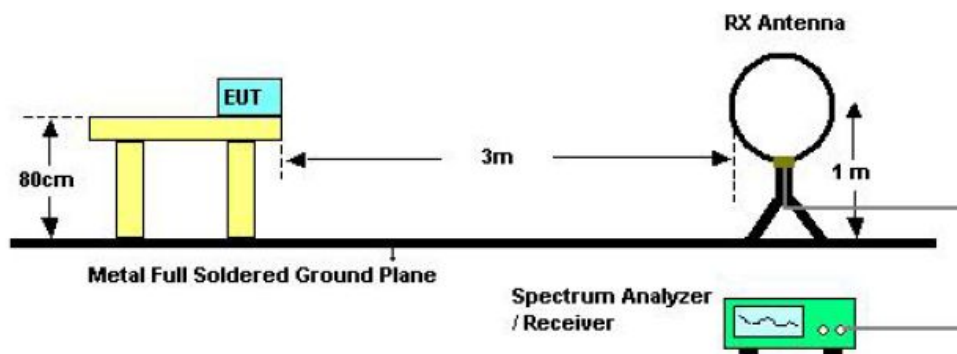

For radiated emissions above 30MHz

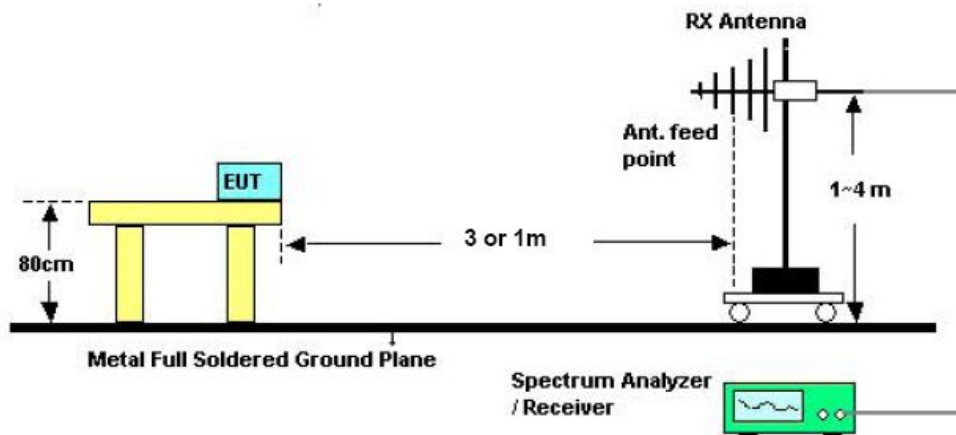

Above 10 GHz shall be extrapolated to the specified distance using an extrapolation factor of 20 dB/decade from 3m to 1m.

Distance extrapolation factor = $20 \log(\text{specific distance [3m]} / \text{test distance [1m]})$ (dB);

Limit line = specific limits (dBuV) + distance extrapolation factor [9.54 dB].



For radiated emissions frequency above 1GHz

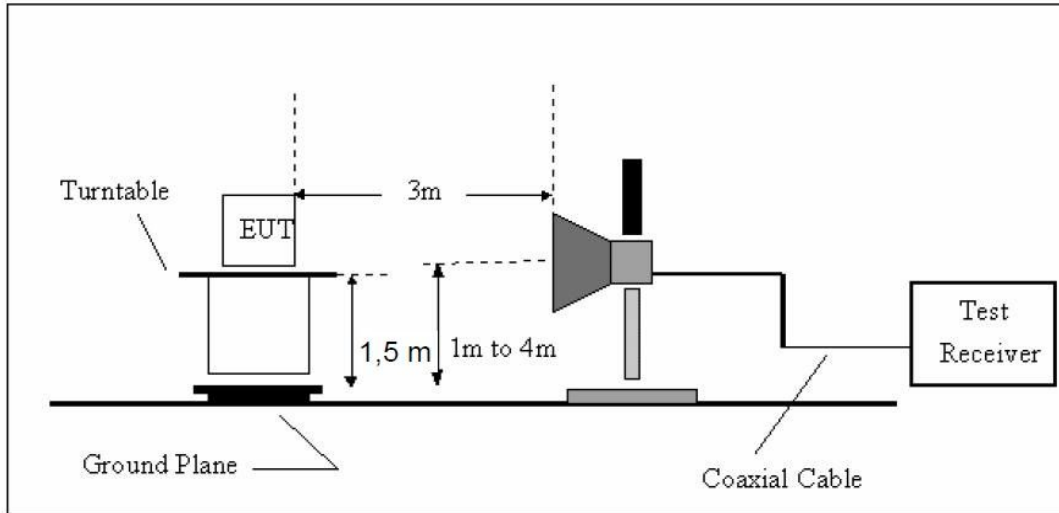

Note: For harmonic emissions test a appropriate high pass filter was inserted in the input port of AMP.



7.4 Test Result and Data (9kHz ~ 30MHz)

The 9kHz - 30MHz spurious emission is under limit 20dB more.

7.5 Test Result and Data (30MHz ~ 1GHz, worst emissions found)

Power	: DC 12V	Pol/Phase	: HORIZONTAL
Test Mode 1	: TX CH39	Temperature	: 30 °C
Memo	:	Humidity	: 59%

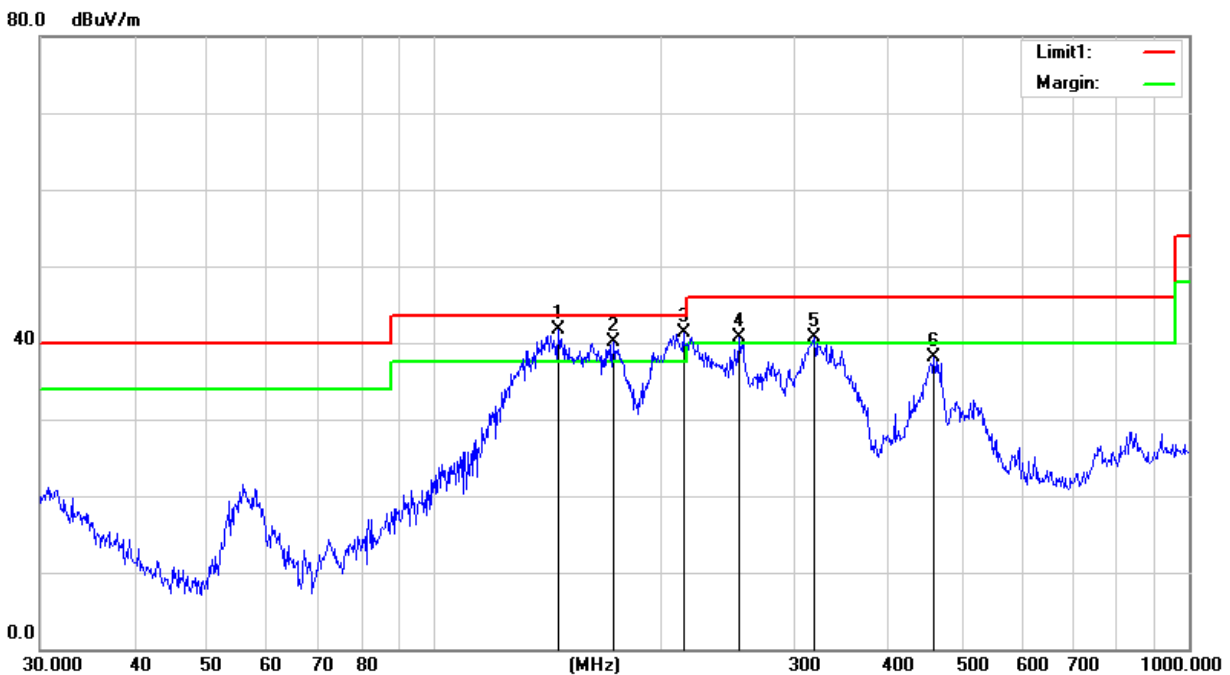

No.	Frequency (MHz)	Reading (dBuV)	Correction factor(dB/m)	Result (dBuV/m)	Limit (dBuV/m)	Margin (dB)	Degree (deg.)	Height (cm)	Remark
1*	145.8611	56.11	-14.47	41.64	43.50	-1.86			peak
2!	172.5988	55.59	-15.48	40.11	43.50	-3.39			peak
3!	213.7634	57.63	-16.40	41.23	43.50	-2.27			peak
4!	253.8367	55.59	-14.96	40.63	46.00	-5.37			peak
5!	318.8170	52.66	-11.94	40.72	46.00	-5.28			peak
6	459.1144	48.30	-10.12	38.18	46.00	-7.82			peak



Power	: DC 12V	Pol/Phase	: VERTICAL
Test Mode 1	: TX CH39	Temperature	: 30 °C
Memo	:	Humidity	: 59%

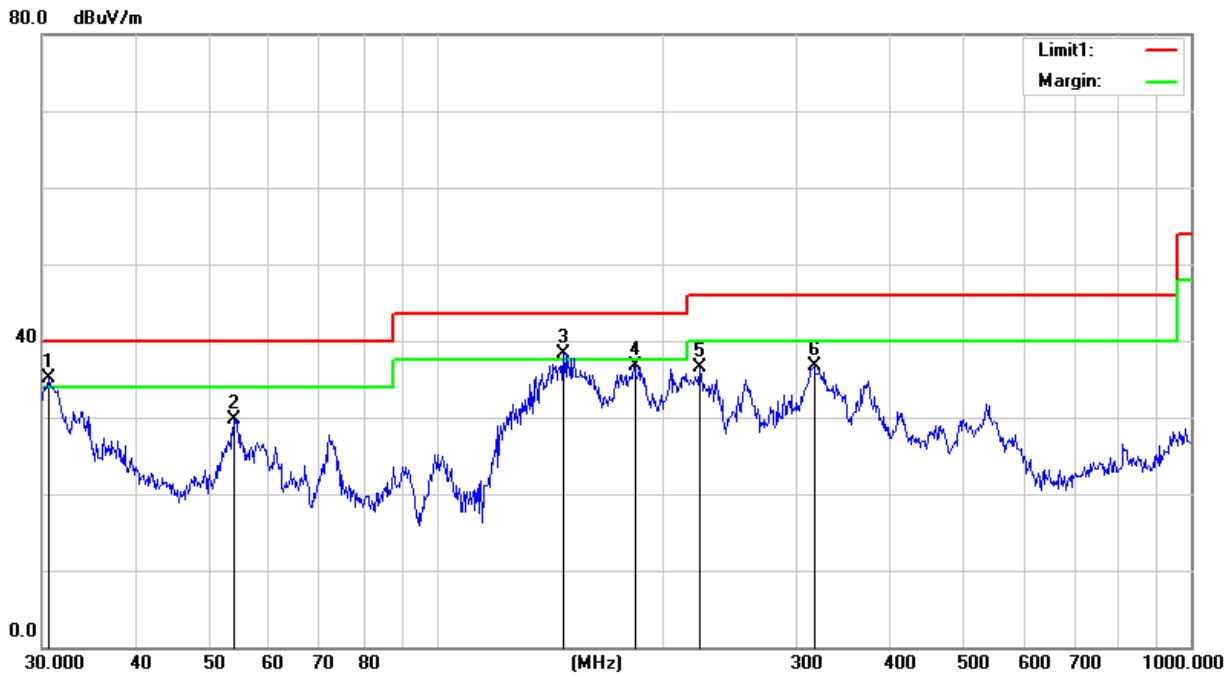

No.	Frequency (MHz)	Reading (dBuV)	Correction factor(dB/m)	Result (dBuV/m)	Limit (dBuV/m)	Margin (dB)	Degree (deg.)	Height (cm)	Remark
1*	30.6379	42.26	-7.11	35.15	40.00	-4.85			peak
2	53.8818	51.15	-21.36	29.79	40.00	-10.21			peak
3!	147.4036	52.75	-14.45	38.30	43.50	-5.20			peak
4	183.2005	53.00	-16.30	36.70	43.50	-6.80			peak
5	222.9502	52.41	-15.95	36.46	46.00	-9.54			peak
6	316.5890	48.66	-11.93	36.73	46.00	-9.27			peak



7.6 Test Result and Data (Above 1GHz)

Power	: DC 12V	Pol/Phase	: HORIZONTAL
Test Mode 1	: TX CH00,CH38,CH78	Temperature	: 30 °C
Memo	:	Humidity	: 59 %

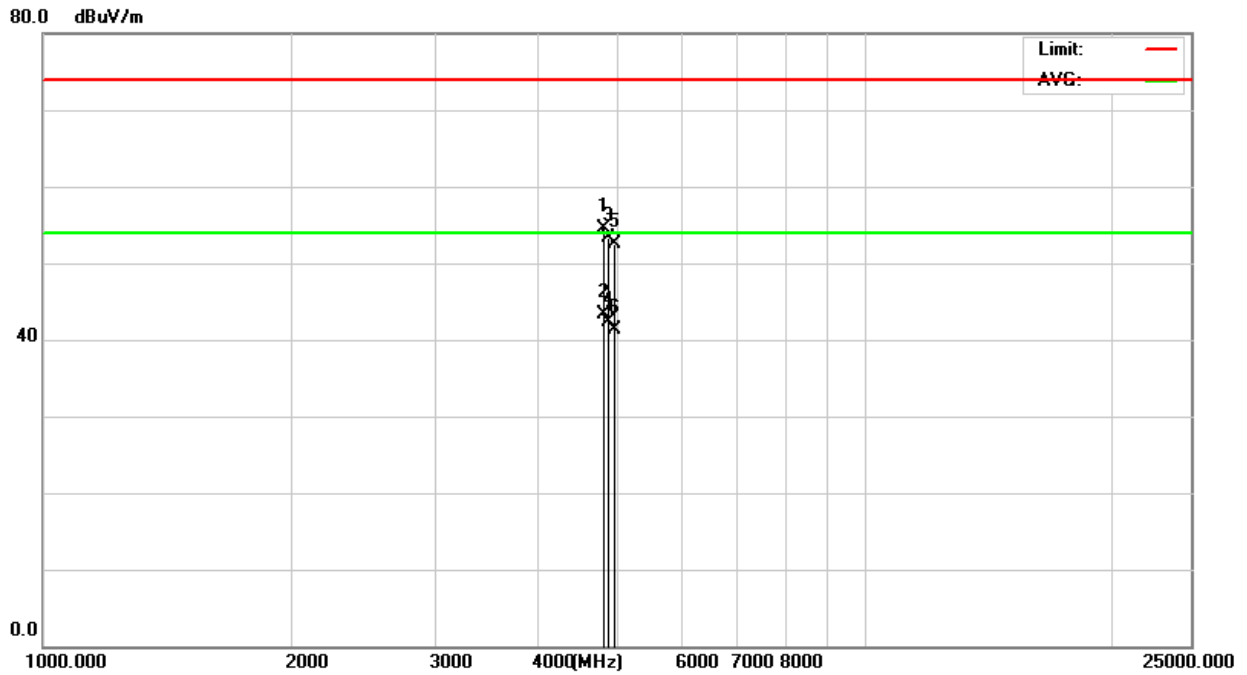

No.	Mk.	Freq. MHz	Reading Level dBuV	Correct Factor dB	Measure- ment dBuV/m	Limit dBuV/m	Over dB	Detector	Antenna Height cm	Table Degree	Comment
1		4804.000	46.33	8.12	54.45	74.00	-19.55	peak			
2	*	4804.000	35.27	8.12	43.39	54.00	-10.61	AVG			
3		4880.000	45.11	8.17	53.28	74.00	-20.72	peak			
4		4880.000	34.18	8.17	42.35	54.00	-11.65	AVG			
5		4960.000	44.39	8.21	52.60	74.00	-21.40	peak			
6		4960.000	33.18	8.21	41.39	54.00	-12.61	AVG			



Power	: DC 12V	Pol/Phase	: VERTICAL
Test Mode 1	: TX CH00,CH38,CH78	Temperature	: 30 °C
Memo	:	Humidity	: 59 %

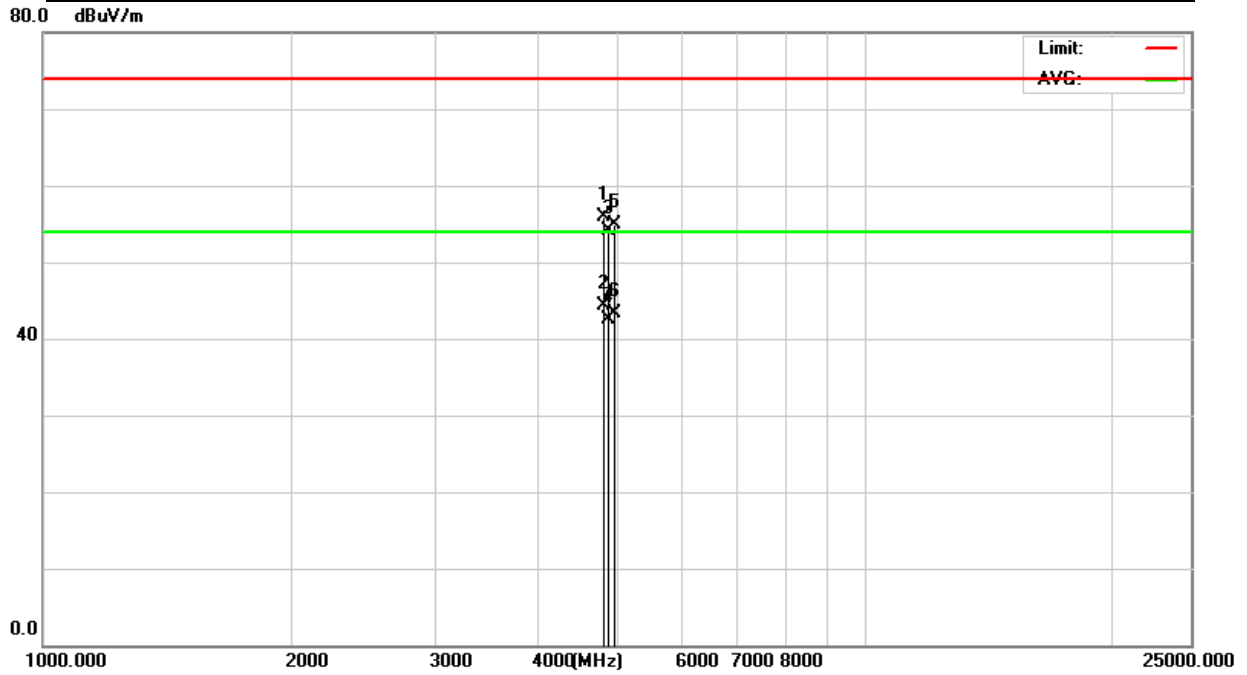

No.	Mk.	Freq. MHz	Reading Level dBuV	Correct Factor dB	Measure- ment dBuV/m	Limit dBuV/m	Over dB	Detector	Antenna Height cm	Table Degree degree	Comment
1		4804.000	47.69	8.12	55.81	74.00	-18.19	peak			
2	*	4804.000	36.25	8.12	44.37	54.00	-9.63	AVG			
3		4880.000	45.91	8.17	54.08	74.00	-19.92	peak			
4		4880.000	34.28	8.17	42.45	54.00	-11.55	AVG			
5		4960.000	46.66	8.21	54.87	74.00	-19.13	peak			
6		4960.000	35.17	8.21	43.38	54.00	-10.62	AVG			



7.7 Restrict Band Emission Measurement Data

Radiated Method

Power	: DC 12V	Pol/Phase	: H/V
Test Mode 1	: GFSK / $\pi/4$ DQPSK / 8- DPSK	Temperature	: 30 °C
Test Date	: Dec. 17, 2017	Humidity	: 59 %

GFSK

Channel 0						Fundamental Frequency: 2402 MHz				
Frequency (MHz)	Ant-Pol H/V	Meter Reading (dBuV)	Corrected Factor (dB)	Result (dBuV/m)	Remark	Limit (dBuV/m)		Margin (dB)	Table Deg.	Ant High (m)
						Peak	Ave			
2390.00	H	59.99	-13.99	46	Peak	74	54	-28	89.5	1.5
---	H	---	---	---	Ave	74	54	---	---	---
2390.00	V	58.14	-13.99	44.15	Peak	74	54	-29.85	174	1.5
---	V	---	---	---	Ave	74	54	---	---	---
Channel 78						Fundamental Frequency: 2480 MHz				
Frequency (MHz)	Ant-Pol H/V	Meter Reading (dBuV)	Corrected Factor (dB)	Result (dBuV/m)	Remark	Limit (dBuV/m)		Margin (dB)	Table Deg.	Ant High (m)
						Peak	Ave			
2483.5	H	58.62	-13.74	44.88	Peak	74	54	-29.12	37	1.5
---	H	---	---	---	Ave	74	54	---	---	---
2483.5	V	60.33	-13.74	46.59	Peak	74	54	-27.41	175	1.5
---	V	---	---	---	Ave	74	54	---	---	---



$\pi/4$ DQPSK

Channel 0						Fundamental Frequency: 2402 MHz				
Frequency (MHz)	Ant-Pol H/V	Meter Reading (dBuV)	Corrected Factor (dB)	Result (dBuV/m)	Remark	Limit (dBuV/m)		Margin (dB)	Table Deg.	Ant High (m)
						Peak	Ave			
2390.00	H	61.02	-13.99	47.03	Peak	74	54	-26.97	17	1.5
---	H	---	---	---	Ave	74	54	---	---	---
2390.00	V	59.88	-13.99	45.89	Peak	74	54	-28.11	45	1.5
---	V	---	---	---	Ave	74	54	---	---	---
Channel 78						Fundamental Frequency: 2480 MHz				
Frequency (MHz)	Ant-Pol H/V	Meter Reading (dBuV)	Corrected Factor (dB)	Result (dBuV/m)	Remark	Limit (dBuV/m)		Margin (dB)	Table Deg.	Ant High (m)
						Peak	Ave			
2483.5	H	62.33	-13.74	48.59	Peak	74	54	-25.41	36	1.5
---	H	---	---	---	Ave	74	54	---	---	---
2483.5	V	57.92	-13.74	44.18	Peak	74	54	-29.82	145	1.5
---	V	---	---	---	Ave	74	54	---	---	---

8- DPSK

Channel 0						Fundamental Frequency: 2402 MHz				
Frequency (MHz)	Ant-Pol H/V	Meter Reading (dBuV)	Corrected Factor (dB)	Result (dBuV/m)	Remark	Limit (dBuV/m)		Margin (dB)	Table Deg.	Ant High (m)
						Peak	Ave			
2390.00	H	59.74	-13.99	45.75	Peak	74	54	-28.25	17	1.5
---	H	---	---	---	Ave	74	54	---	---	---
2390.00	V	60.52	-13.99	46.53	Peak	74	54	-27.47	45	1.5
---	V	---	---	---	Ave	74	54	---	---	---
Channel 78						Fundamental Frequency: 2480 MHz				
Frequency (MHz)	Ant-Pol H/V	Meter Reading (dBuV)	Corrected Factor (dB)	Result (dBuV/m)	Remark	Limit (dBuV/m)		Margin (dB)	Table Deg.	Ant High (m)
						Peak	Ave			
2483.5	H	60.33	-13.74	46.59	Peak	74	54	-27.41	36	1.5
---	H	---	---	---	Ave	74	54	---	---	---
2483.5	V	58.84	-13.74	45.1	Peak	74	54	-28.9	145	1.5
---	V	---	---	---	Ave	74	54	---	---	---



Note:

1. Emission level = Reading level + Correction factor
2. Correction factor : Antenna factor, Cable loss, Pre-Amp, etc.
3. All emissions as described above were determining by rotating the EUT through three orthogonal axes to maximizing the emissions if the EUT belongs to hand-held or body-worn devices.
4. Measurements above 1000 MHz, Peak detector setting:
1 MHz RBW with 1 MHz VBW (Peak Detector).
5. Measurements above 1000 MHz, Average detector setting:
1 MHz RBW with 10Hz VBW (RMS Detector).
6. Peak detector measurement data will represent the worst case results.

Where limits are specified for both average and peak detector functions, if the peak measured value complies with the average limit, it is unnecessary to perform an average measurement.



8. Bandwidth Measurement Data

8.1 Test Limit

Please refer RSS-247 & section15.247.

8.2 Test Procedures

- a. The transmitter output was connected to the spectrum analyzer.
- b. Set RBW of spectrum analyzer to 100 KHz and VBW \geq 3x RBW.
- c. The 20 dB bandwidth is defined as the total spectrum the power of which is higher than peak power minus 20 dB.
- d. The 20dB Bandwidth was measured and recorded.

8.3 Test Setup Layout

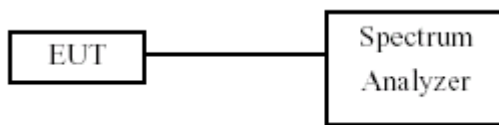



8.4 Test Result and Data

Test Date: Nov. 17, 2017

Temperature: 26°C

Atmospheric pressure: 1000 hPa

Humidity: 55%

Modulation Standard	Channel	Frequency (MHz)	20dB Bandwidth (MHz)
GFSK	0	2402	1.0907
	39	2440	1.0909
	78	2480	1.0883
$\pi/4$ DQPSK	0	2402	1.3600
	39	2440	1.3759
	78	2480	1.3406
8- DPSK	0	2402	1.3617
	39	2440	1.3502
	78	2480	1.3712

Modulation Standard: GFSK

Channel: 0

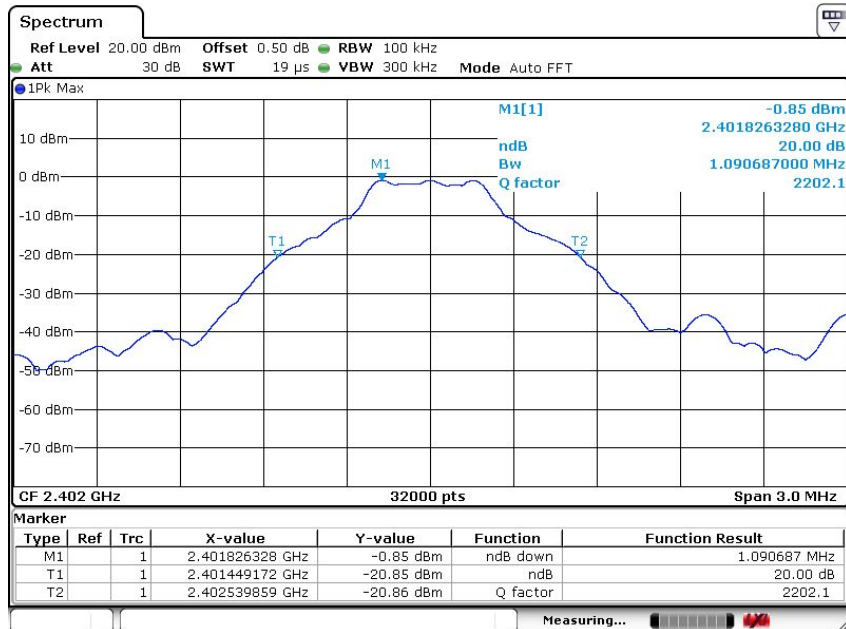



Modulation Standard: GFSK

Channel: 39

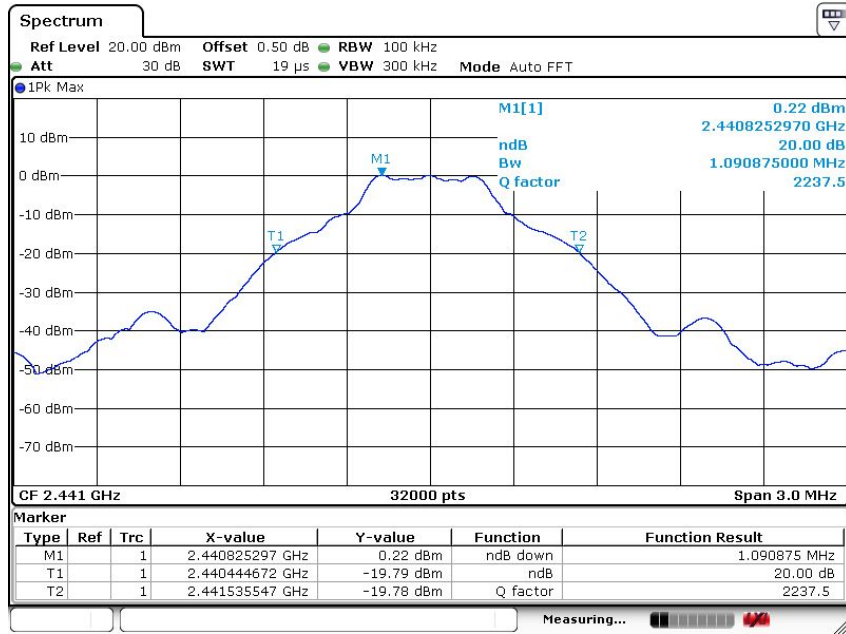

Modulation Standard: GFSK

Channel: 78

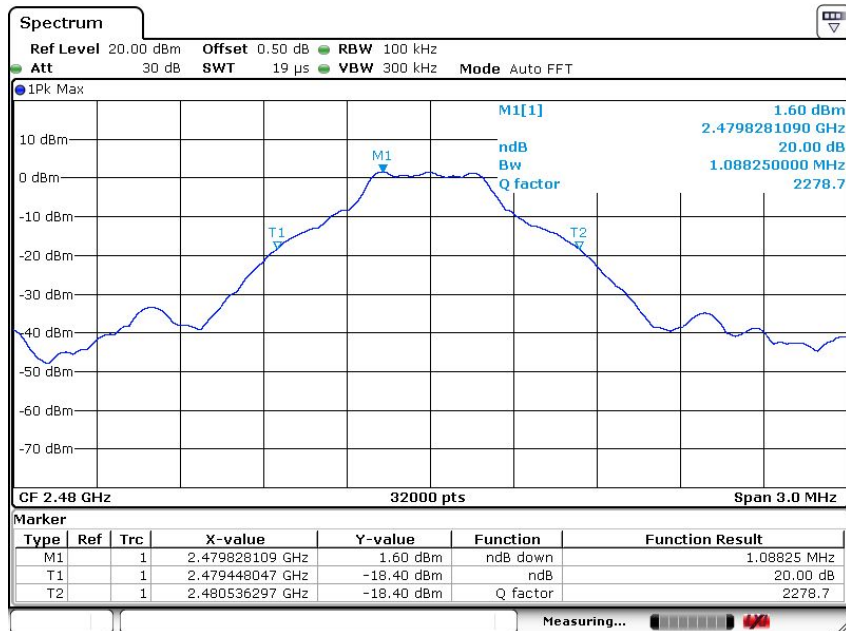



Modulation Standard: $\pi/4$ DQPSK

Channel: 0

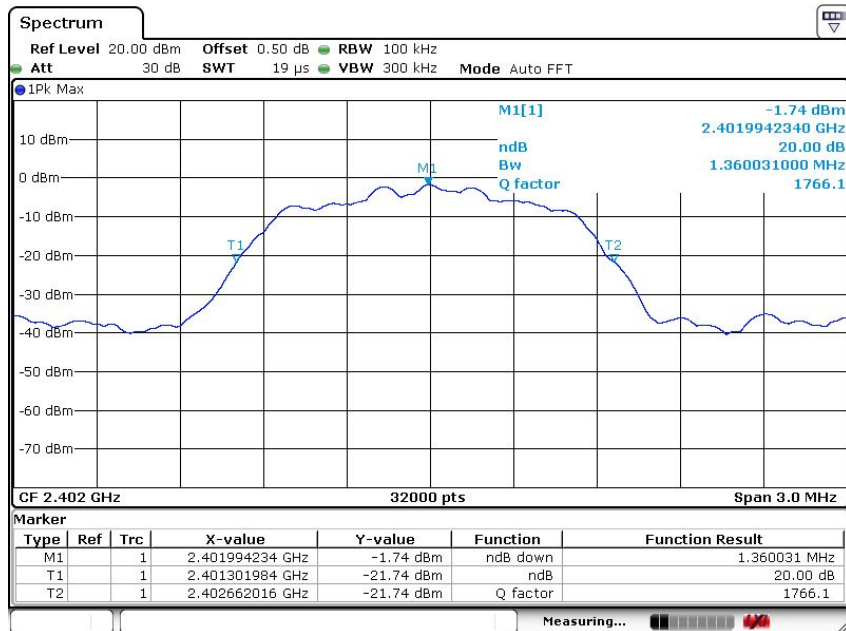

Modulation Standard: $\pi/4$ DQPSK

Channel: 39

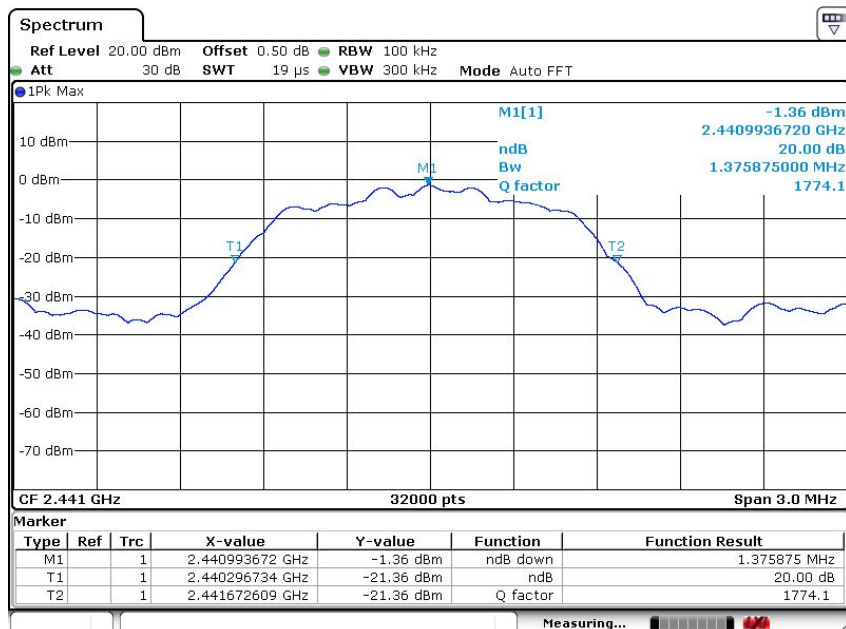



Modulation Standard: $\pi/4$ DQPSK

Channel: 78

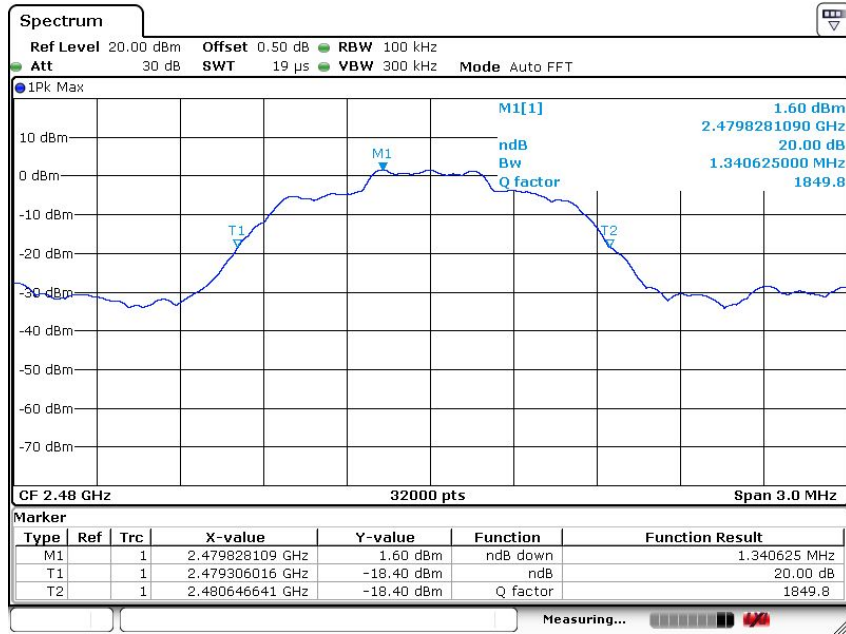

Modulation Standard: 8- DPSK

Channel: 0

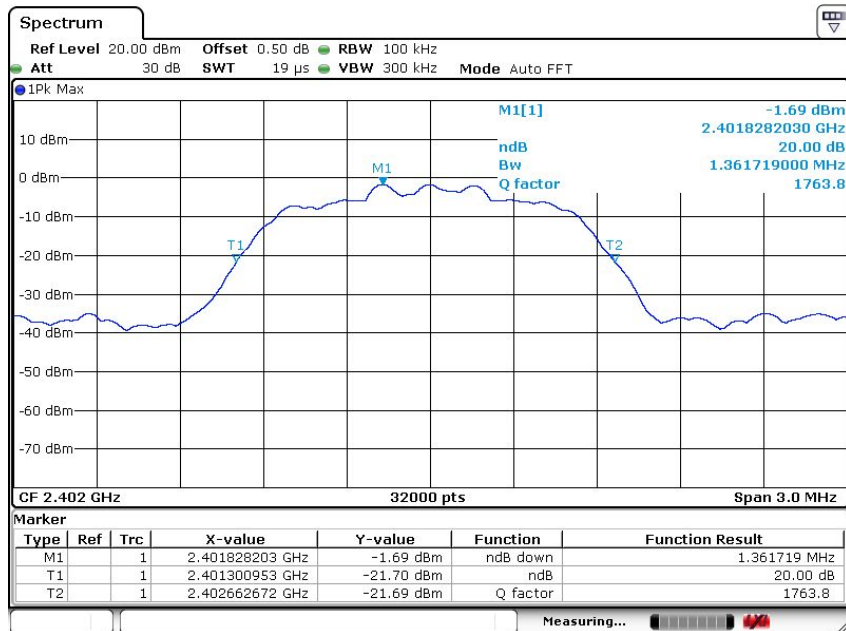



Modulation Standard: 8- DPSK

Channel: 39

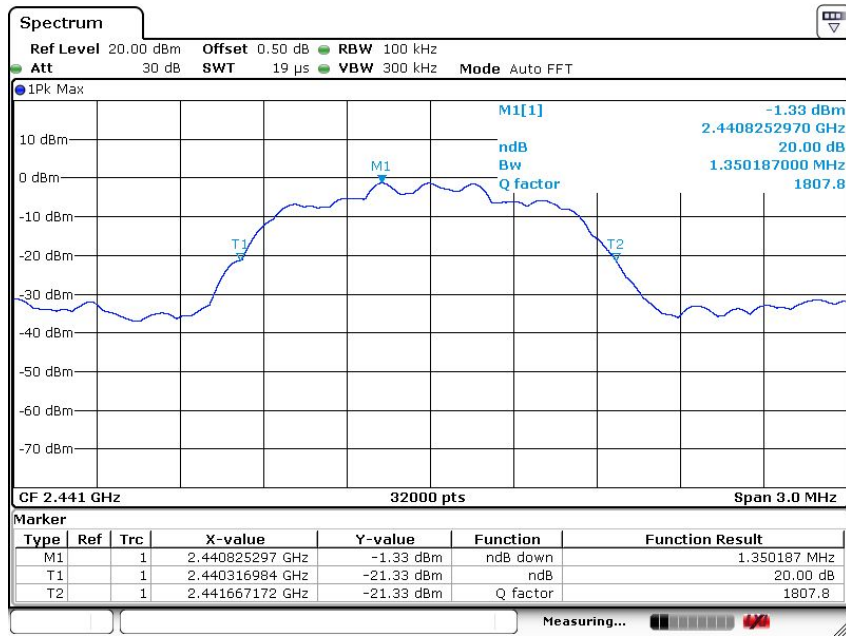

Modulation Standard: 8- DPSK

Channel: 78

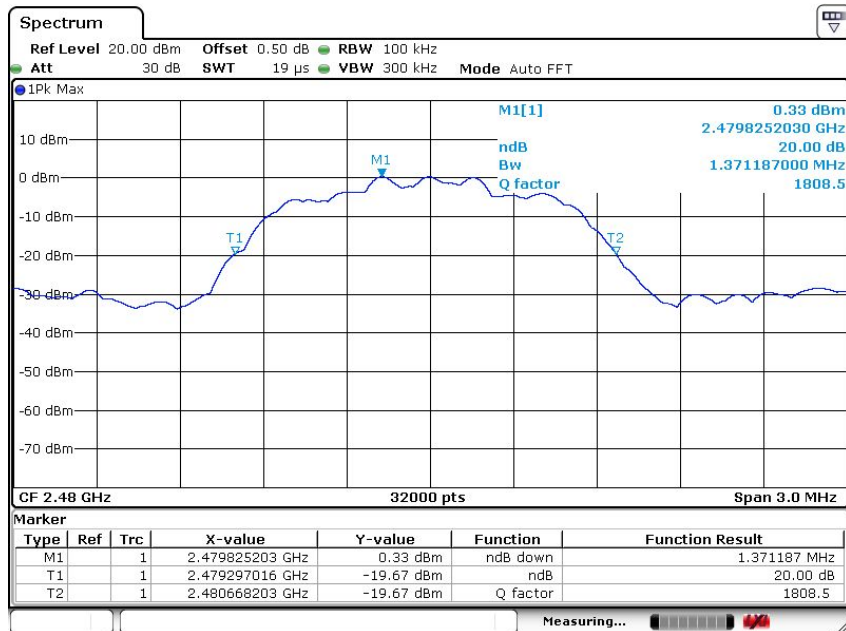



9. Maximum Peak Output Power

9.1 Test Limit

The Maximum Peak Output Power Measurement is 30dBm.

9.2 Test Procedures

- a. Peak power is measured using the wideband power meter.
- b. Power is integrated over a bandwidth greater than or equal to the 99% bandwidth.
- c. The Peak Output Power was measured and recorded.

9.3 Test Setup Layout

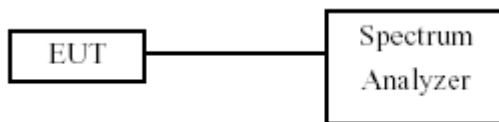



9.4 Test Result and Data

Test Date: Nov. 17, 2017

Temperature: 26°C

Atmospheric pressure: 1000hPa

Humidity: 55%

Modulation Standard	Channel	Frequency (MHz)	Peak Power Output (dBm)	Peak Power Output (mW)
GFSK	00	2402	3.69	2.34
	39	2441	3.48	2.23
	78	2480	3.61	2.30
$\pi/4$ DQPSK	00	2402	3.12	2.05
	39	2441	3.08	2.03
	78	2480	3.18	2.08
8DPSK	00	2402	3.09	2.04
	39	2441	3.02	2.00
	78	2480	3.10	2.04



10. Carrier Frequency Separation

10.1 Test Limit

- a. Frequency hopping systems shall have hopping channel carrier frequencies separated by a minimum of 25 kHz or the 20 dB bandwidth of the hopping channel, whichever is greater. Alternatively, frequency hopping systems operating in the 2400-2483.5 MHz band may have hopping channel carrier frequencies that are separated by 25 kHz or two-thirds of the 20 dB bandwidth of the hopping channel, whichever is greater, provided the systems operate with an output power no greater than 125 mW.

10.2 Test Procedures

- b. The transmitter output was connected to spectrum analyzer.
- c. The spectrum analyzer's resolution bandwidth were set at 100KHz RBW and 300KHz VBW as that of the fundamental frequency. Set the sweep time=auto couple.
- d. The Carrier Frequency Separation was measured and recorded.

10.3 Test Setup Layout

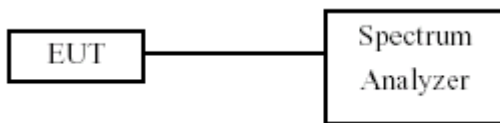



10.4 Test Result and Data

Test Date: Nov. 17, 2017

Temperature: 26°C

Atmospheric pressure: 1000 hPa

Humidity: 55%

Mode/Channel	Channel separation (KHz)	20dB Bandwidth (MHz)	Conclusion
GFSK	999.0	1.0883	PASS
$\pi/4$ DQPSK	999.0	1.3406	PASS
8- DPSK	998.3	1.3712	PASS

Modulation Standard: GFSK

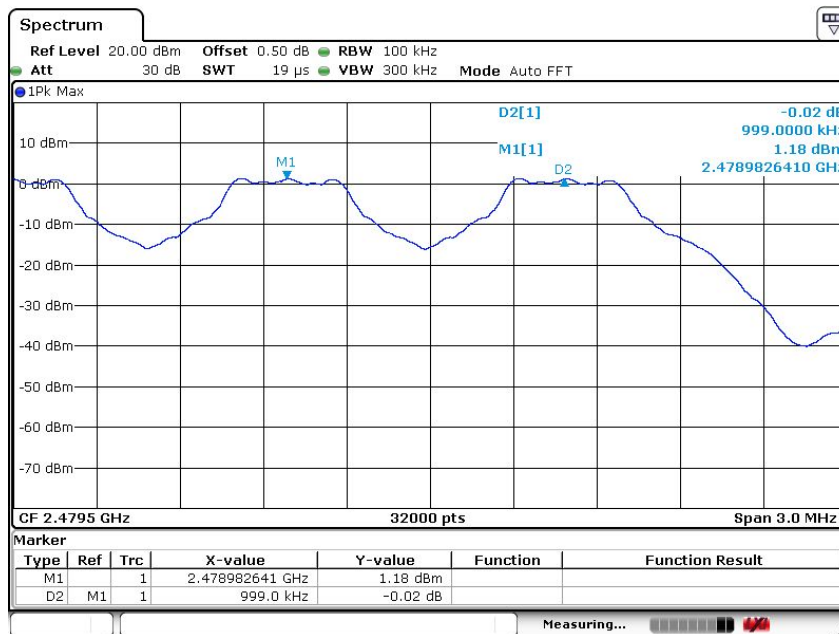



Modulation Standard: $\pi/4$ DQPSK

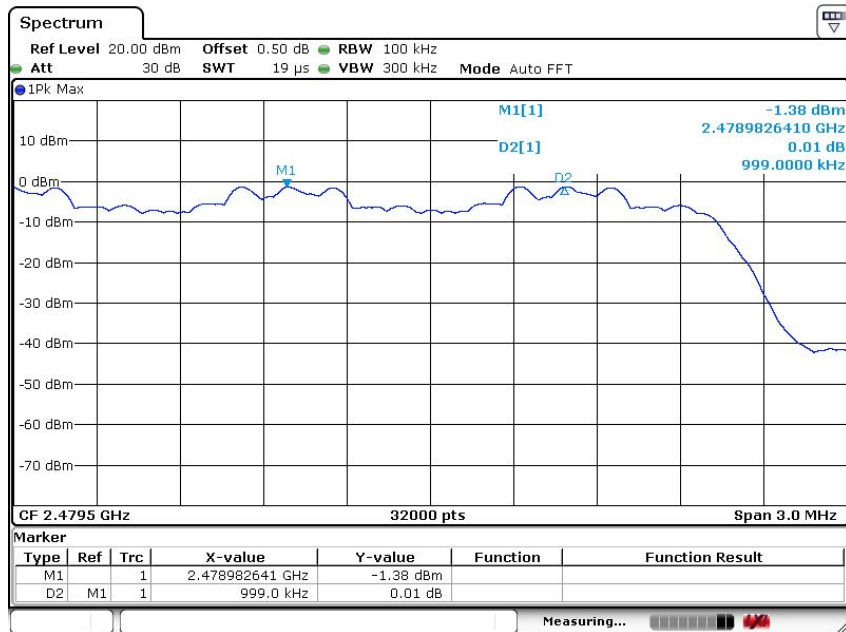

Modulation Standard: 8-DPSK

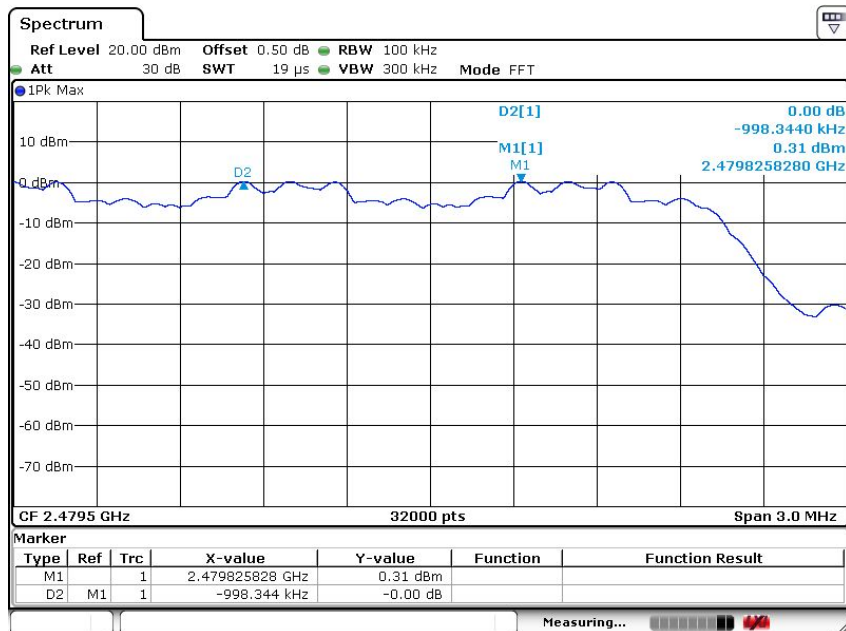



11. Number Of Hopping Channel

11.1 Test Limit

Frequency hopping systems in the 2400-2483.5 MHz band shall use at least 15 channels

11.2 Test Procedure

- a. The transmitter output was connected to the spectrum analyzer via a low lose cable.
- b. The transmitter output was coupled to a spectrum analyzer via a antenna. The number of hopping channel was measured by spectrum analyzer with 300kHz RBW and 1MHz VBW.
- c. The number of hopping channel was measured and recorded.

11.3 Test Setup Layout

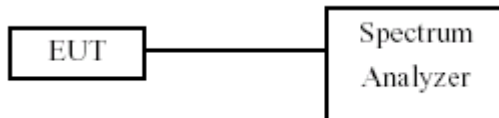



11.4 Test Result and Data

Original test data for hopping channel number

GFSK

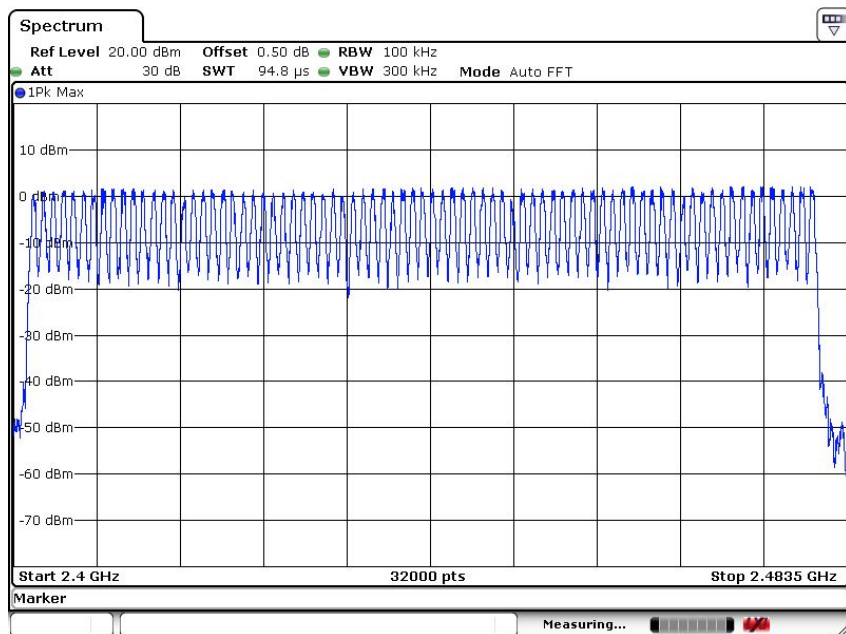



8- DPSK

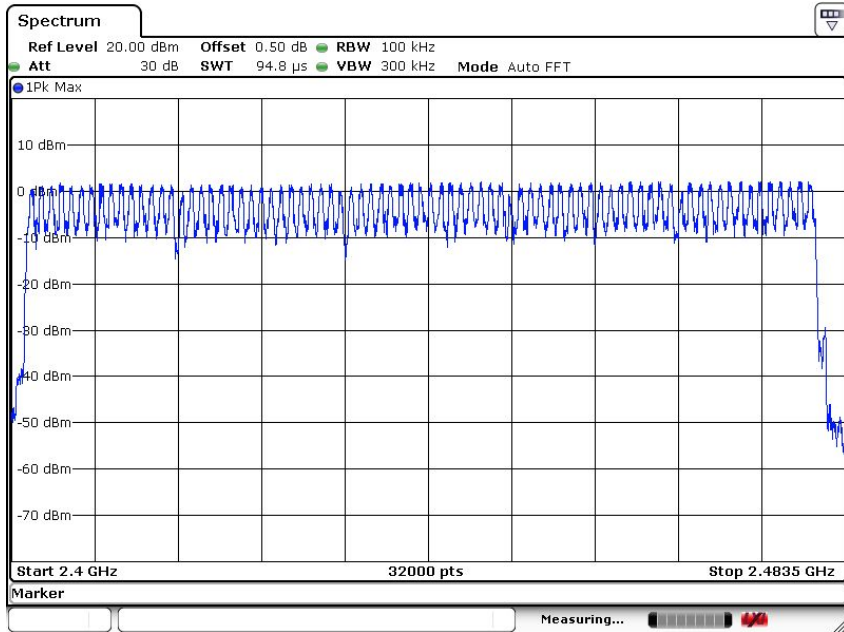



12. Dwell Time

12.1 Test Limit

Please refer RSS-247 & section15.247

12.2 Test Procedure

- d. The transmitter output was connected to the spectrum analyzer via a low lose cable.
- e. The transmitter output was coupled to a spectrum analyzer via a antenna. Set center frequency of spectrum analyzer = operating frequency
- f. Set the spectrum analyzer as RBW, VBW=1MHz, Span = 0Hz, Sweep = auto.
- g. Repeat above procedures until all frequency measured were complete

12.3 Test Setup Layout

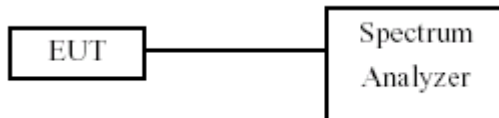



12.4 Test Result and Data

Original test data see the following page.

Mode	Data Packet	Frequency (MHz)	Pulse Duration (ms)	Dwell Time (s)	Limit (s)	Conclusion
GFSK	DH1	2402	0.462	0.148	<0.4	PASS
	DH3	2402	1.728	0.287	<0.4	PASS
	DH5	2402	2.997	0.319	<0.4	PASS
8- DPSK	DH1	2402	0.519	0.166	<0.4	PASS
	DH3	2402	1.752	0.291	<0.4	PASS
	DH5	2402	3.000	0.320	<0.4	PASS

Note: 1 A period time = 0.4 (s) * 79 = 31.6(s)

2 DH1 time slot = Pulse Duration * (1600/(1*79)) * A period

time DH3 time slot = Pulse Duration * (1600/(3*79)) * A

period time DH5 time slot = Pulse Duration *

(1600/(5*79)) * A period time



GFSK DH1/DH3/DH5

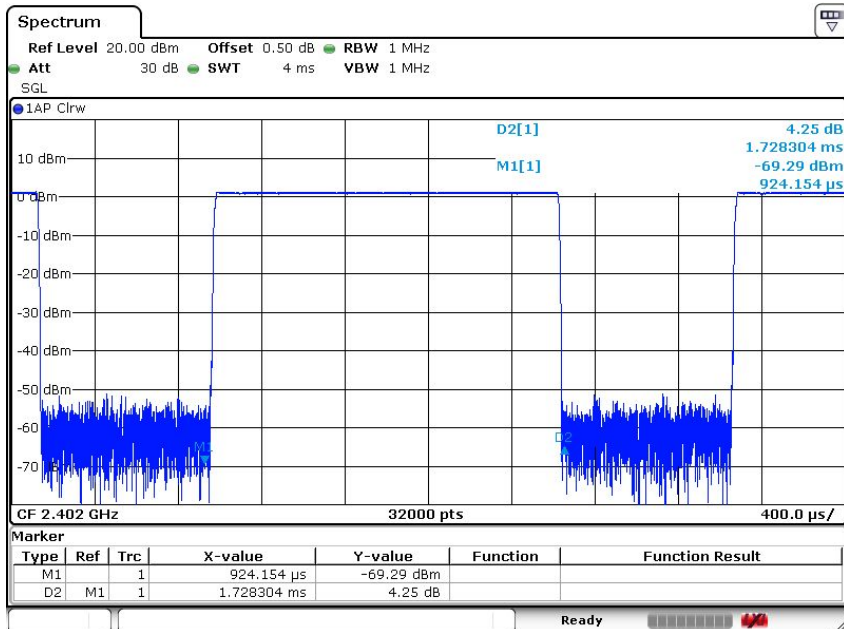
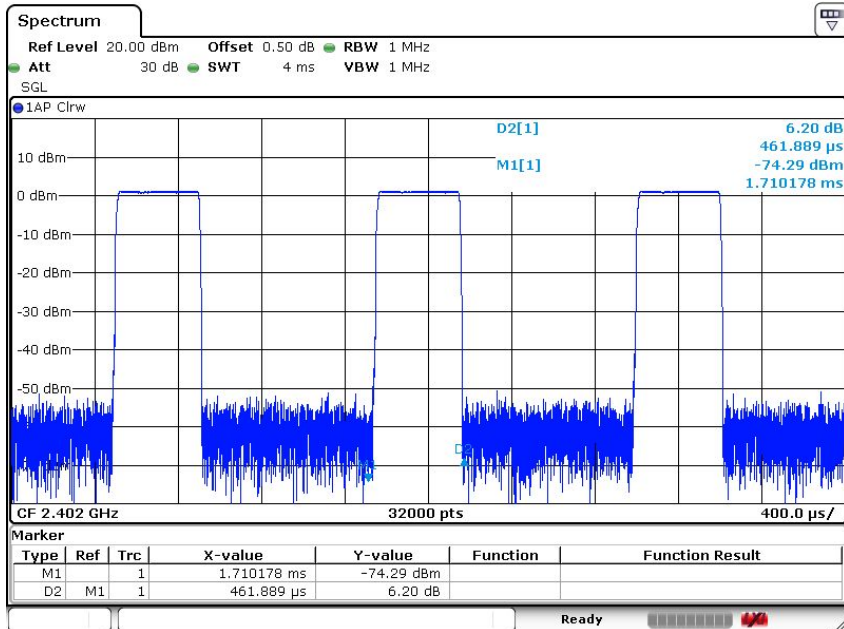

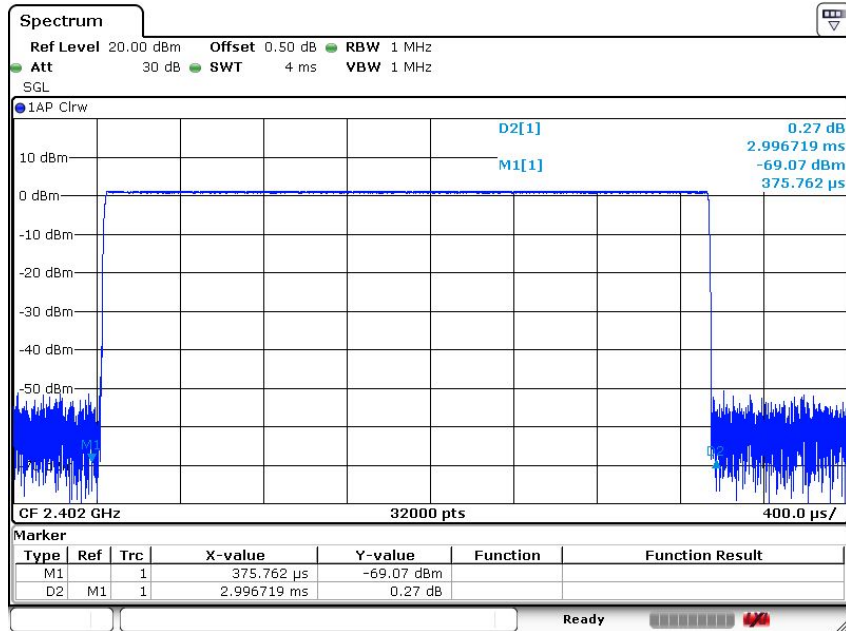



8- DPSK DH1/DH3/DH5

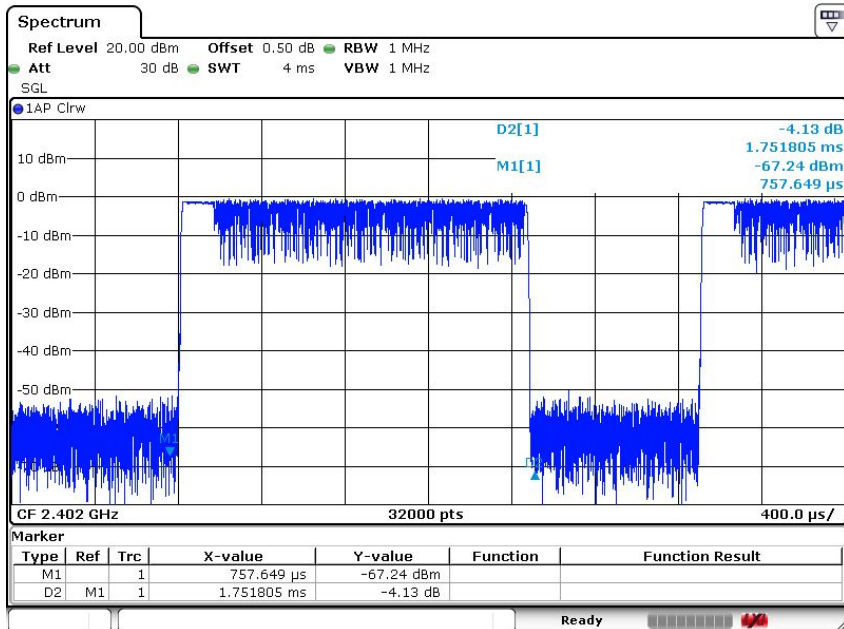
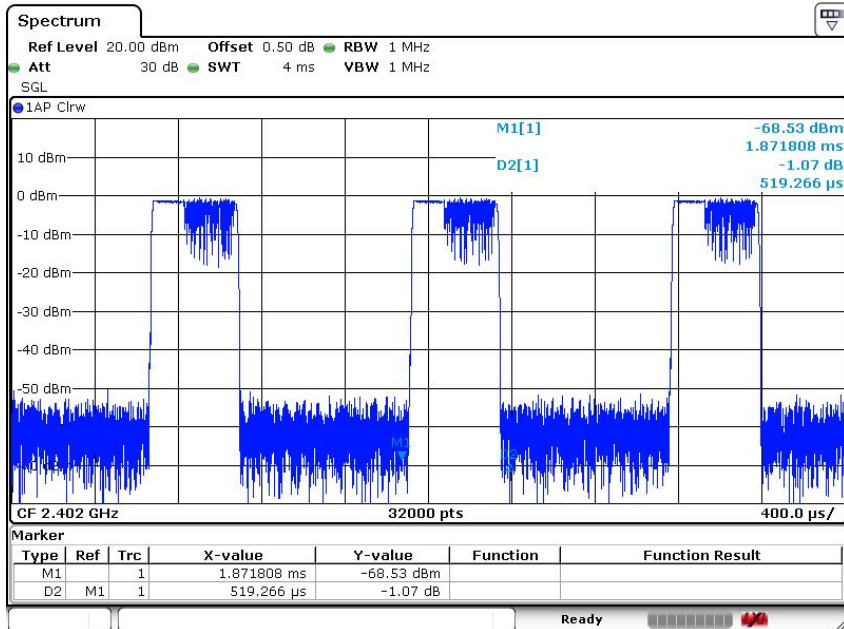

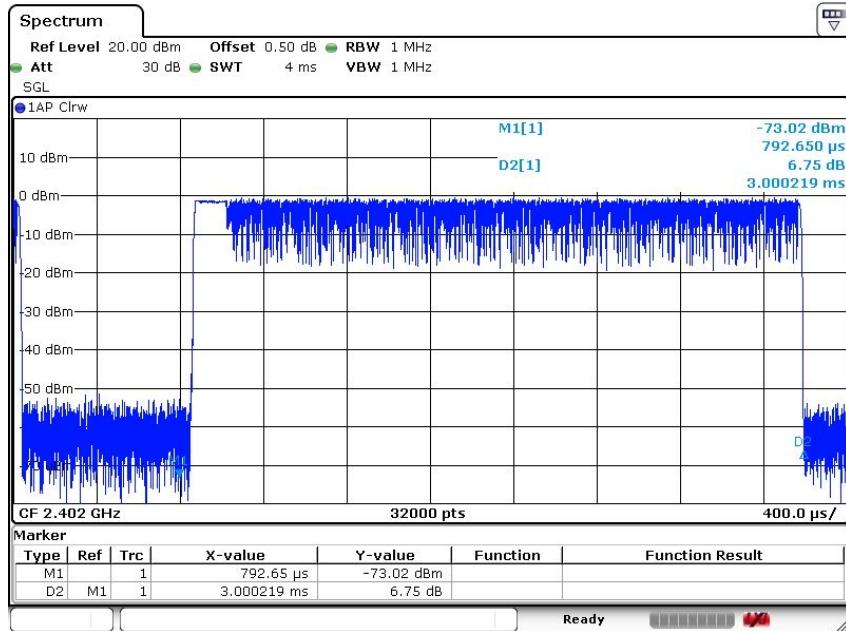



13. Band Edges Measurement

13.1 Test Limit

Below -20dB of the highest emission level of operating band (In 100 kHz Resolution Bandwidth)

13.2 Test Procedure

- h. The transmitter output was connected to the spectrum analyzer via a low lose cable.
- i. Set RBW of spectrum analyzer to 100 KHz and VBW of spectrum analyzer to 300 KHz with convenient frequency span including 100 KHz bandwidth from band edge.
- j. Peak conducted output power measured within any 100 kHz outside the authorized frequency band shall be attenuated by at least 20dB relative to the maximum measured in-band peak PSD level.
- k. The band edges was measured and recorded.

13.3 Test Setup Layout

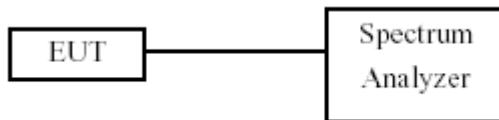



13.4 Test Result and Data

Test Date: Nov. 17, 2017

Temperature: 26°C

Atmospheric pressure: 1000hPa

Humidity: 55%

Modulation Standard: GFSK

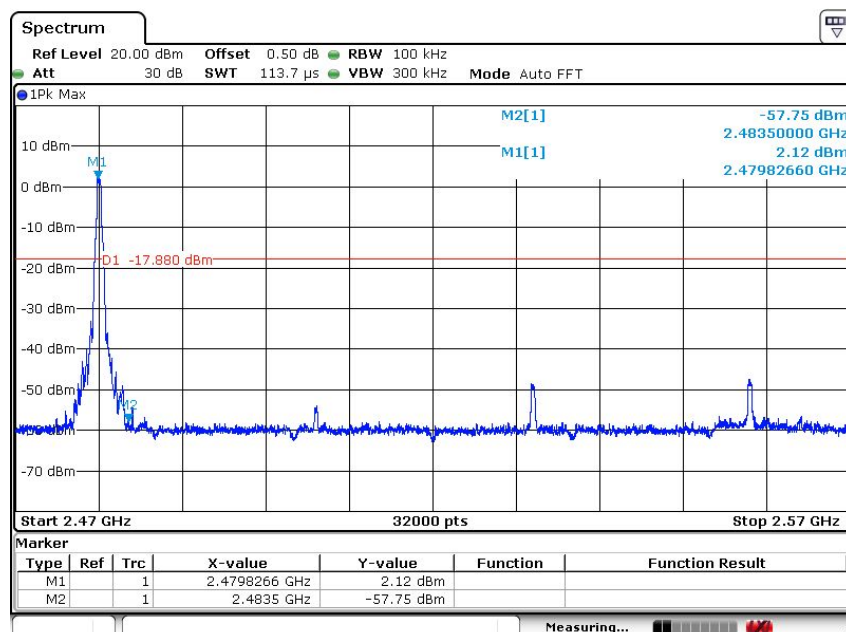
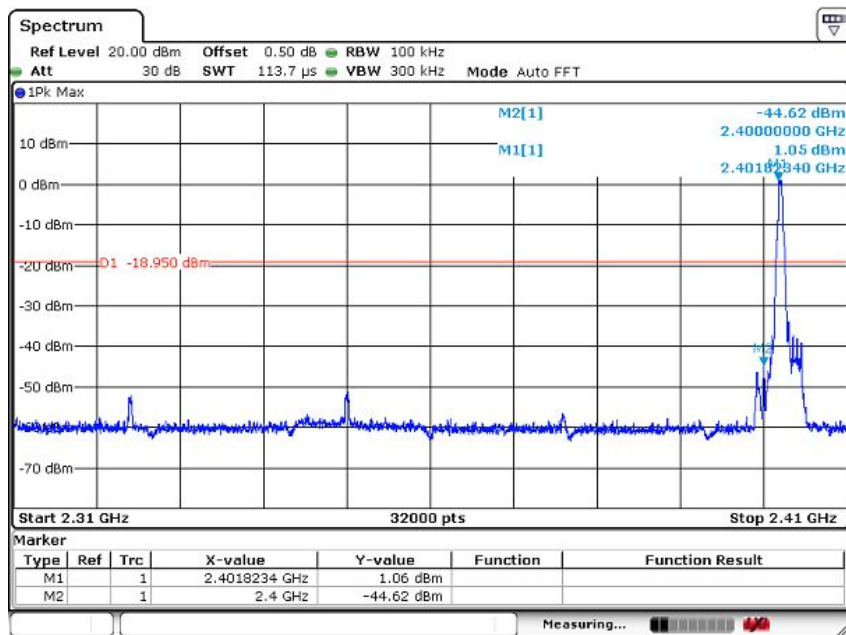



Modulation Standard: 8- DPSK

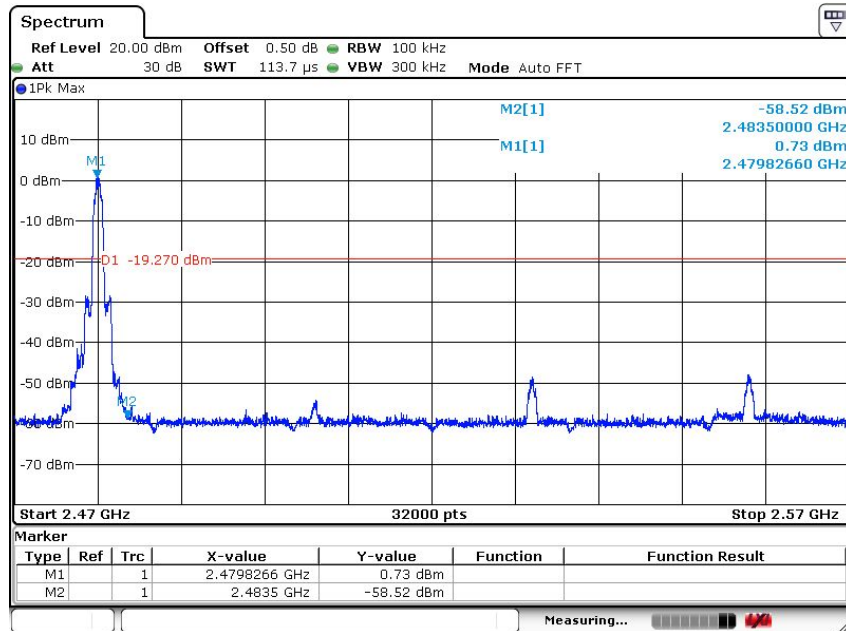
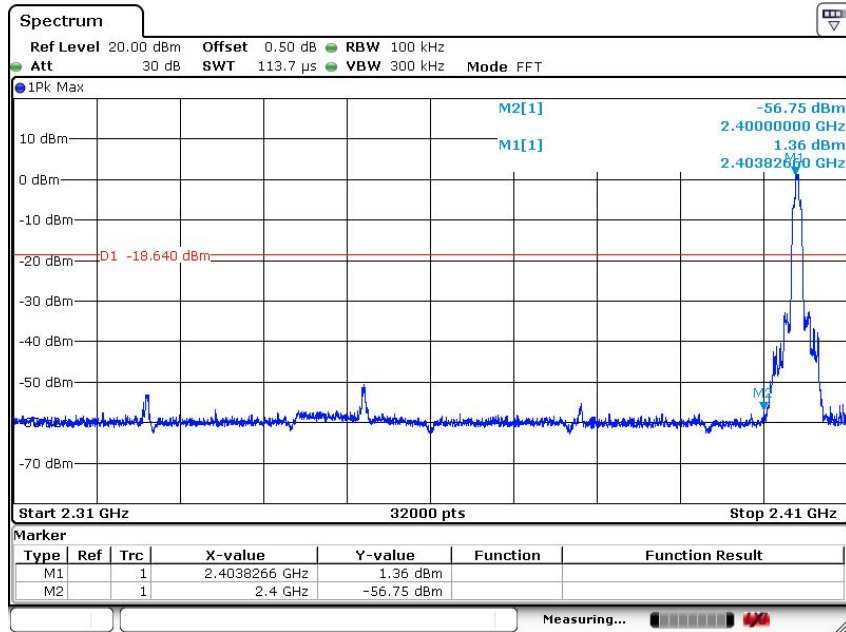



Hopping

Modulation Standard: GFSK

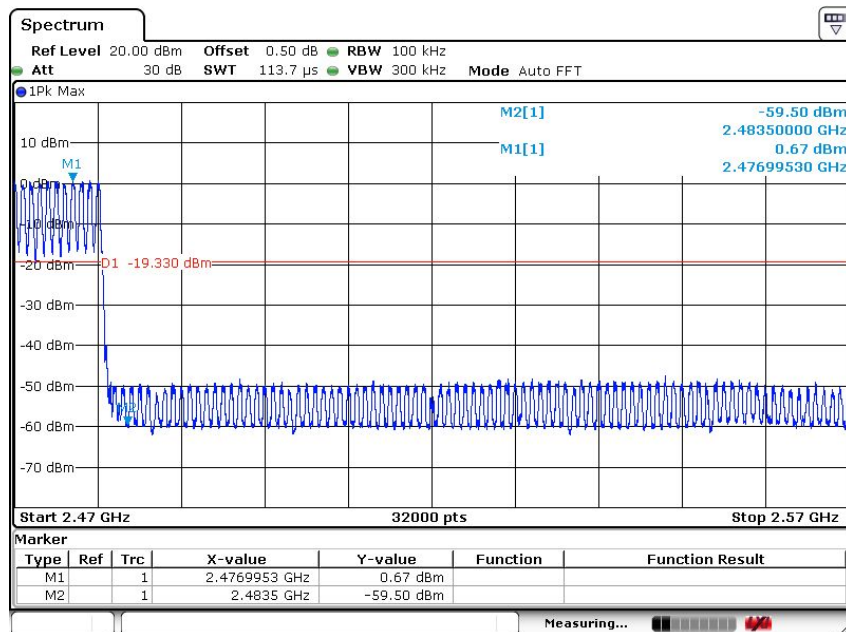
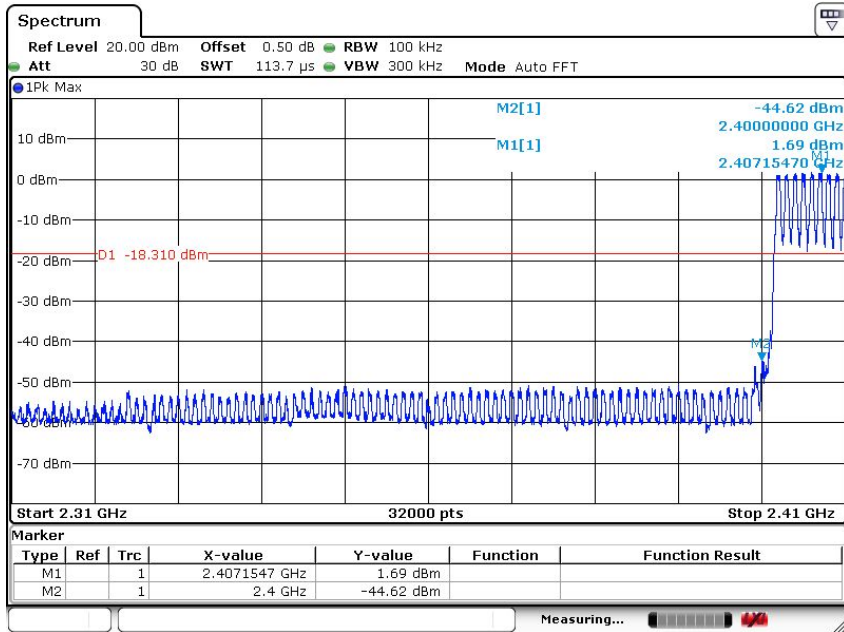



Modulation Standard: 8- DPSK

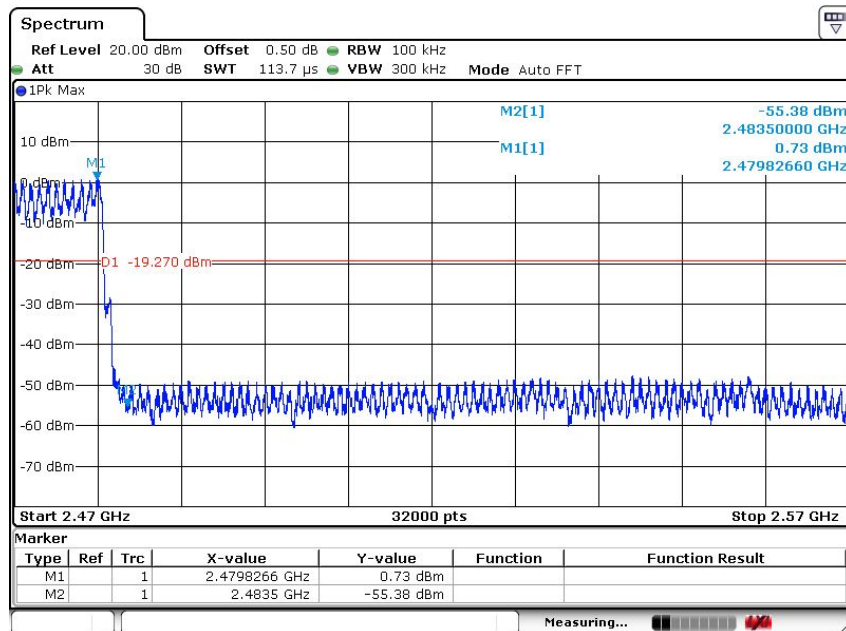
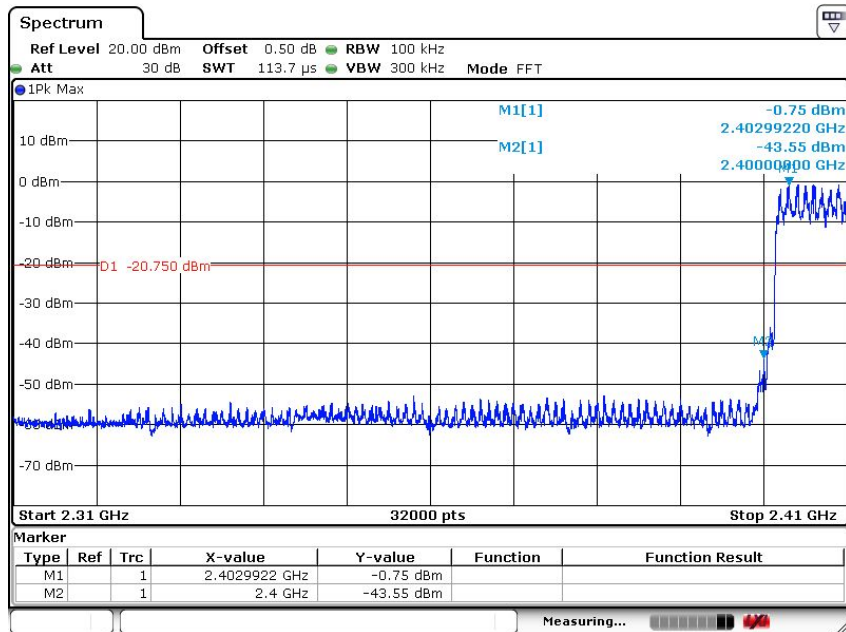



14. Restricted Bands of Operation

Only spurious emissions are permitted in any of the frequency bands listed below:

MHz	MHz	MHz	GHz
0.09000 – 0.11000	16.42000 – 16.42300	399.9 – 410.0	4.500 – 5.150
0.49500 – 0.505**	16.69475 – 16.69525	608.0 – 614.0	5.350 – 5.460
2.17350 – 2.19050	16.80425 – 16.80475	960.0 – 1240.0	7.250 – 7.750
4.12500 – 4.12800	25.50000 – 25.67000	1300.0 – 1427.0	8.025 – 8.500
4.17725 – 4.17775	37.50000 – 38.25000	1435.0 – 1626.5	9.000 – 9.200
4.20725 – 4.20775	73.00000 – 74.60000	1645.5 – 1646.5	9.300 – 9.500
6.21500 – 6.21800	74.80000 – 75.20000	1660.0 – 1710.0	10.600 – 12.700
6.26775 – 6.26825	108.00000 – 121.94000	1718.8 – 1722.2	13.250 – 13.400
6.31175 – 6.31225	123.00000 – 138.00000	2200.0 – 2300.0	14.470 – 14.500
8.29100 – 8.29400	149.90000 – 150.05000	2310.0 – 2390.0	15.350 – 16.200
8.36200 – 8.36600	156.52475 – 156.52525	2483.5 – 2500.0	17.700 – 21.400
8.37625 – 8.38675	156.70000 – 156.90000	2655.0 – 2900.0	22.010 – 23.120
8.41425 – 8.41475	162.01250 – 167.17000	3260.0 – 3267.0	23.600 – 24.000
12.29000 – 12.29300	167.72000 – 173.20000	3332.0 – 3339.0	31.200 – 31.800
12.51975 – 12.52025	240.00000 – 285.00000	3345.8 – 3358.0	36.430 – 36.500
12.57675 – 12.57725	322.00000 – 335.40000	3600.0 – 4400.0	Above 38.6
13.36000 – 13.41000			

** : Until February 1, 1999, this restricted band shall be 0.490-0.510 MHz

14.1 Labeling Requirement

The device shall bear the following statement in a conspicuous location on the device:

This device complies with part 15 of the FCC Rules. Operation is subject to the following two conditions: (1) This device may not cause harmful interference, and (2) this device must accept any interference received, including interference that may cause undesired operation.



APPENDIX 1 PHOTOS OF TEST CONFIGURATION



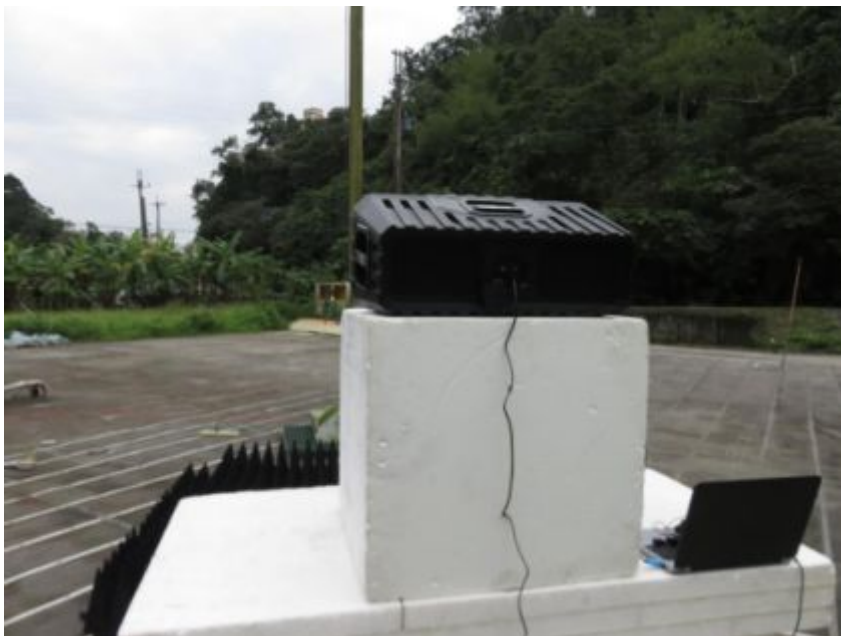



APPENDIX 2 PHOTOS OF EUT







