

**MINI HI-FI SYSTEM
GVD-2800**



Content

Important Notice:

Please retain original packaging for Warranty purposes. Please return with ALL supplied accessories.
Supplier reserves the right to make changes at any time without prior notice.

Safety Instructions	2
Caution	3
System Connection	4
Front Panel Functions.....	5
Rear Panel Functions.....	6
Remote Functions	7
System Setup.....	8-11
Bluetooth Operation/USB Copy	12
Common Operation.....	13-15
Radio Station/ Audio Input Operation	16
Fault Guide.....	17
Specifications.....	18

Safety Instructions

Please read the user and maintenance guide carefully and keep it in a safe place for future reference. To avoid the risk of electric shock, do not disassemble the enclosure. Refer all servicing to qualified service personnel.



Only use in altitudes below 5,000m.

Power Supply

Operate only from the power source specified on the unit.

Ventilation

The ventilation holes in the shell of the unit are designed for heat dissipation to prevent the unit from overheating. The holes should not be blocked or covered and do not place the unit on a bed or sofa.

Heat Sources

Do not place the unit near heat sources such as a boiler, electric furnace etc. Avoid direct sunlight.

Water and Moisture

Never use the unit in areas like the bathroom, kitchen or any area where it may be exposed to water.

Please do not place a vessel containing liquid on the unit.

Foreign Matters

Please do not insert foreign matters like metal articles etc. into the unit.

Cleaning

Please unplug the power plug before cleaning. Do not use a solution with corrosive substances, volatile solution or spray cleaning agents to clean the unit. Use a soft and damp cloth to clean .

Power Cable

When plugging or unplugging the power cable, please hold the plug tightly, and do not pull the cable. If the unit is not used for a long time or in use during a thunderstorm , please immediately unplug it from the socket.

Disc Door

When the disc door closes, keep fingers away from the door in order to avoid injury or damage to the unit.

Loading of Weight

To avoid damage, do not place heavy articles on the unit or step on it.

Connection with Other Equipment

When connecting other equipment, ensure that the power plug of each unit is unplugged. Otherwise, there may be risk of damage to equipment and/or personal injury.

Laser

When the cover is opened and the unit is working, do not look directly at the laser so as to avoid damage to one's eyesight.

Discs

Do not use broken, deformed or amended discs, otherwise the unit will operate faulty and the service life will be shortened.

Maintenance Service for the Faults

If any one of the following situations arise, please unplug the unit and contact qualified maintenance personnel:

- A. When the power wire or plug is damaged.
- B. When liquid or foreign matter has fallen into the unit.
- C. When the unit has been exposed to water or rain.
- D. When the unit doesn't work normally in accordance with the operating instructions.
Please do not adjust any control buttons not stipulated in the instructions as this can cause damage to the unit.
- E. When the unit falls from a high place or is damaged due to other reasons.
- F. When smoke is emitted from the unit.

Maintenance

Please do not try to maintain or repair the unit yourself . Please contact qualified maintenance personnel.

Replacement of Components

When a component needs to be replaced, please ask the maintenance personnel to replace the component from the same model. A component from a different model may cause further damage, electric shock or decrease the service life of the unit.

Safety Check

After the completion of the maintenance, ask the maintenance personnel to check the unit and ensure it's safety.

Caution

Please Note:

- When the unit is moved, please use the original paper box and packing materials and use the factory packing method to optimally protect the unit.
- Do not place volatile liquids beside the unit, and do not allow rubber or plastic to make contact with the unit for extended periods of time as these products may mark the surface of the unit.
- After the unit has been in use for a lengthy period of time, it may heat up on top and at the rear plate. This is normal.
- When the unit is not used, please take out the disc, close the disc door and turn the power off.
- If you have not used the unit for a long time and find that certain function keys are not working, please refer the unit to qualified service personnel for maintenance.

Location :

When your unit is placed near the TV, radio, or video tape recorder, poor image quality and sound distortion may occur. In that case, please relocate the unit away from such equipment.

Cleaning:

- Use a soft cloth to clean the unit.
- Please use the cloth with a small amount of diluted cleaning agent to deal with dirty spots which are not easily cleaned. Do not use any solvents with corrosive substances like diluted, gasoline solvent, abrasive solution, etc. which will damage the surface of the unit.

Warning: The cleaning and adjustment of internal parts should be conducted by trained authorised personnel.

Discs:

- How to take care of your discs: Do not touch the playing side of the disc.



- How to clean your discs: Use a soft cloth to wipe the disc from the centre out. Fingerprints and dust remaining on the disc will affect the quality of the image and sound. When cleaning stubborn dirt, use a clean soft cloth dipped into a little water to wipe the disc, then use a dry soft cloth to dry it. Do not use solutions like methylbenzene, cleaning agents or antistatic spray to clean the disc.



- How to store your discs: Do not place the discs in a place with heavy moisture, dust or direct sunlight. When the discs are not used, please place them in their boxes.



Batteries:

Using the batteries incorrectly will cause leakage or corrosion of the battery fluid. Please use the batteries in accordance with

the following instructions:

- Do not reverse the positive and negative polarity when the batteries are inserted.
- Do not recharge non-rechargeable batteries, disassemble the batteries, make them short circuit or throw them into a fire.
- Do not mix different types of batteries or old and new batteries.
- Do not keep damaged batteries in the remote.
- If the remote is not used for a long time, please remove the batteries to avoid damage caused by the leaking of the battery fluid.
- If the remote is faulty or its effective scope is reduced, please replace with new batteries.
- If the batteries have leaked battery fluid, please dry the battery box and replace with new batteries.

Remote Control:

Using the remote incorrectly will result in poor performance. Please use the remote in accordance with the following instructions:

- The emitter of the remote should not be exposed to sunlight.
- Please aim the remote at the reception window of the unit.
- Do not drop the remote as it may get damaged.
- Do not allow water or any other liquids to come into contact with the remote.
- Do not disassemble the remote.

Tips:

- Correctly place the batteries inside the battery box of the remote.
- The maximum reception distance between the remote and the unit is about 7m.
- The maximum effective angle of the remote aligning at the reception window is 30°.

System Connection

Description of Video Output Port:

Video Output

Connect to the video terminal of the TV.

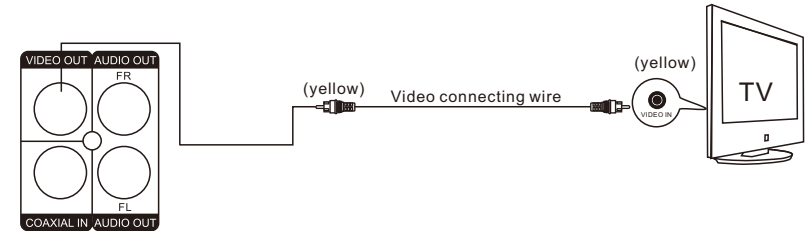

TV Audio Cable:

Connect the audio cable to the TV audio terminal.

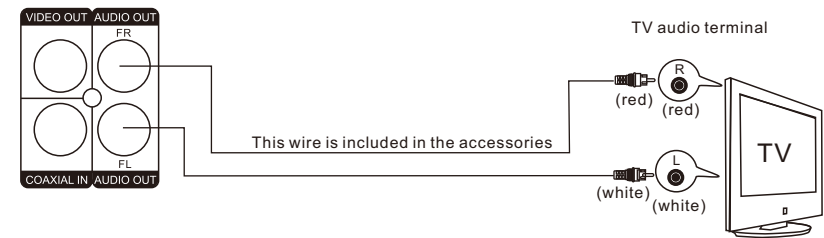

Surround Speaker Connecting Guide:

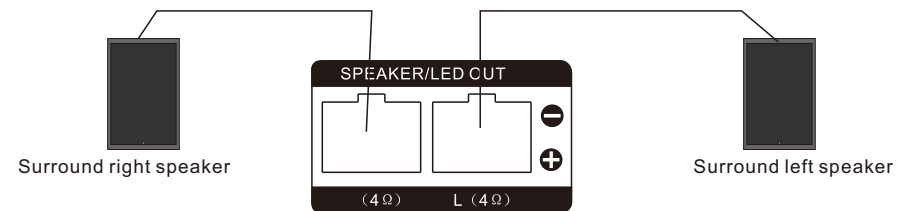

Please note:

- When connecting speakers, please make sure the front, center and surround speakers are connected correctly to the terminals. Do not short circuit the connections as this will cause damage to the system.
- To connect correctly, connect red wire to "+", and black wire to "-".

Front Panel Functions

Brief Introduction of Front Panel Functions

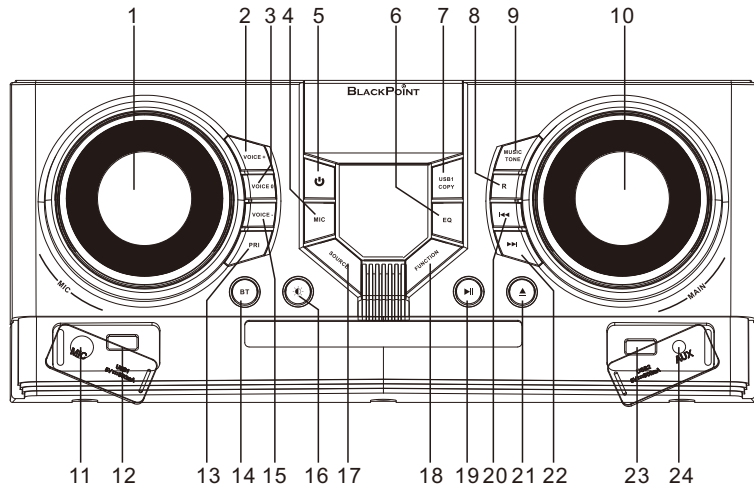

- 1.MIC Volume Button
- 2.VOICE change Key+
- 3.VOICE original sound Key
- 4.MIC Mode Button
- 5.Power Switch
- 6.EQ Key
- 7.USB 1 Copy Button
- 8.Repeat Button
- 9.Music Treble switch Button
- 10.Main Volume Button
- 11.MIC Interface 1
- 12.USB 1 Reading Interface
- 13.Micophone Priority Button
- 14.Bluetooth Switch Key
- 15.VOICE change Key-
- 16.Light
- 17.Function Button (DISC/BT/FM//AUX/LINE IN/USB Switch)
- 18.Play/Pause Button
- 19.Previous Button
- 20.Open/Close Button
- 21.Next Button
- 22.Previous Button
- 23.USB 2 Reading Interface
- 24.AUX Input Interface

Rear Panel Functions

Brief Introduction of Rear Panel Functions

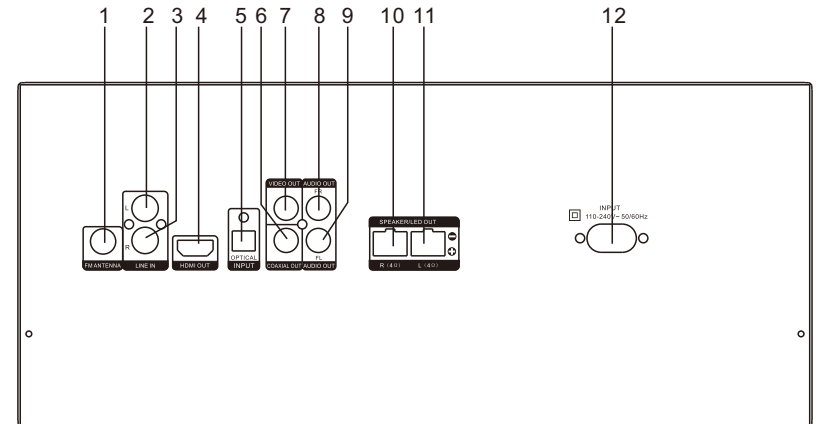

- 1.FM Antenna Terminal
- 2.Left Line in Terminal
- 3.Right Line in Terminal
- 4.HDMI Output
- 5.Optical Input
- 6.Video Output
- 7.Coaxial In
- 8.Left Audio Output
- 9.Right Audio Output
- 10.Right Speaker Terminal
- 11.Left Speaker Terminal
- 12.Power Input

Remote Functions

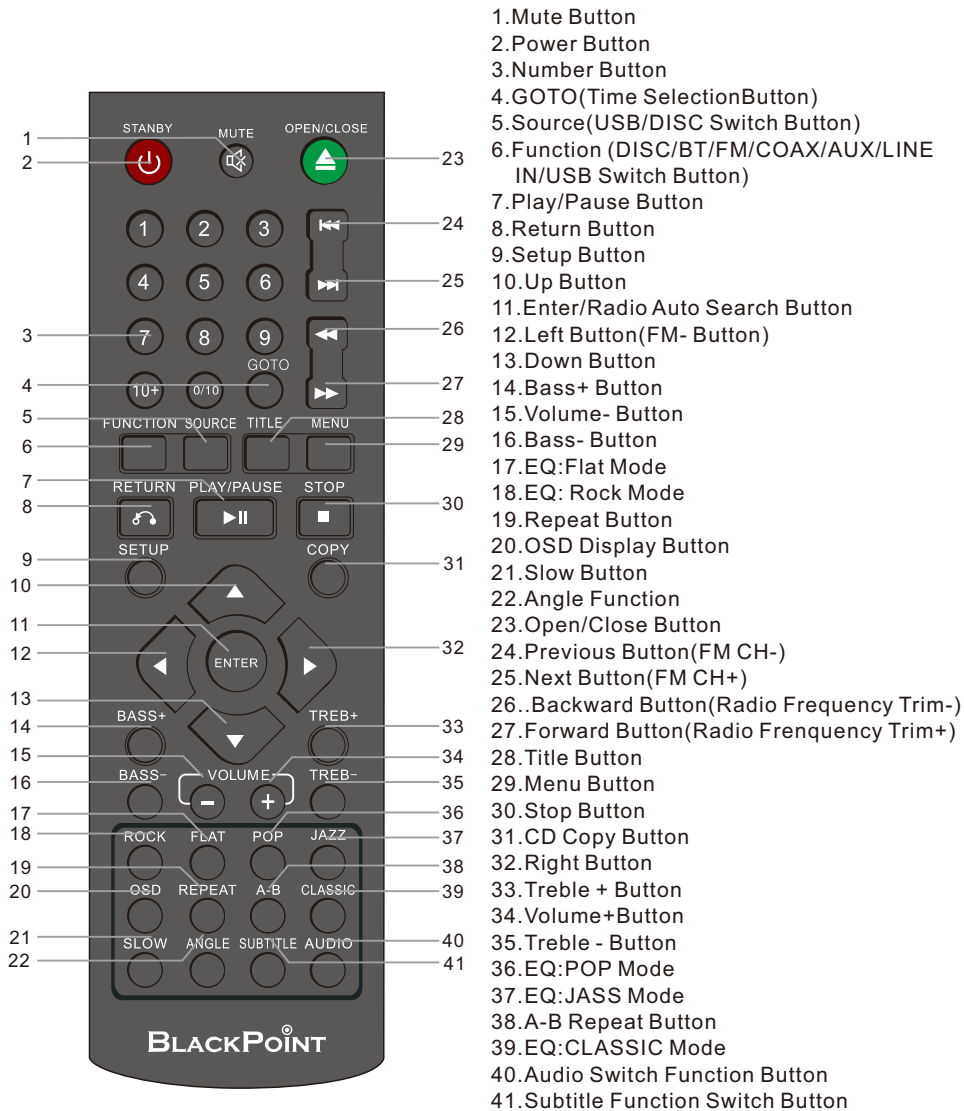

System Setup

System Setup

First press the **【Setup】** key on the remote control to enter the Setup menu. Then press Up, Down, Left or Right to highlight the option you want to adjust in the menu and press **【Enter】** to enter. To exit the setup menu, press the **【Setup】** key.

The setup operations are as follows:

I. TV System

Enter the **【TV System】** option, press **【▶▶】** key to enter the sub-menu and select one of the following systems: NTSC, PAL or AUTO.

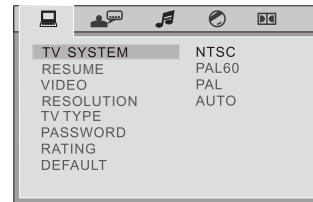

• Resume

Enter the **【Resume】** option and press **【▶▶】** key to enter the sub-menu. There are two options: "ON" or "OFF". If you choose "ON", then when the power resumes or the CD door is closed again, it will continue playing. If you choose "OFF", then when the power resumes or the CD door is closed again, it will play from the beginning.

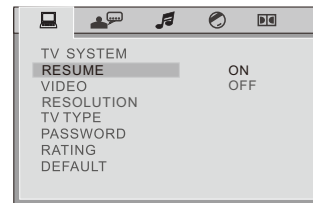

• Video

Enter the **【Video】** option and then press **【▶▶】** key to enter the sub-menu and select the output mode you require.

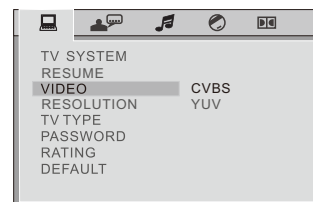

• Resolution

Enter the **【Resolution】** option and press **【▶▶】** to enter the sub-menu. The high definition output selections are as follows: 480/576P, 720, 1080P.

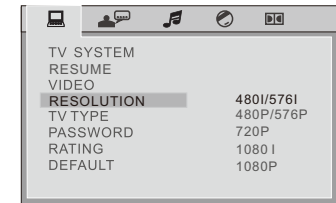

• TV Type

Enter the **【TV Type】** option and press **【▶▶】** key to enter the sub-menu. There are three modes to choose from: 4:3PS, 4:3LB or 16:9. Please select the mode that is the most compatible with your TV.

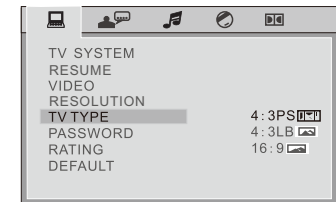

• Password

Enter the **【Password】** option, and press **【▶▶】** key to enter the sub-menu. When the initial setting is in "Password Lock" state, the "Rating" cannot be set and the password cannot be modified. If you need to modify the "Rating" and password, first enter the initial password and press **【Enter】** key to unlock (initial password: 0000 or 1234). The new password entered must be four digits and then press **【Enter】** key to take effect.

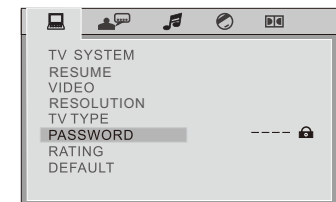

System Setup

• Rating

When playing a disc with a locking function, select the suitable play control rating. This setup can only be carried out when the password lock is off. Remember to switch the password lock back on after you have completed the setup so that the rating restrictions can be applied.

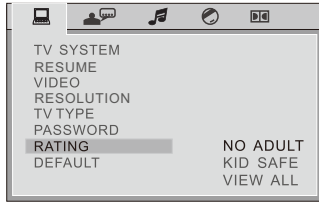

• Audio Language

Enter the **【Audio Lang】** option, press **【▶】** key to enter the sub-menu and select the audio language you need; ensure that the disc you wish to play has the required capability.

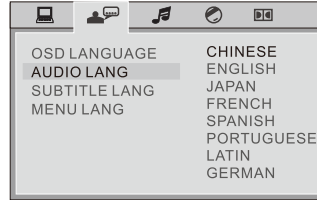

• Default

Enter **【Default】** option, press **【▶】** key to select "Restore" and press **【Enter】** key, so each setup will restore to factory default automatically.

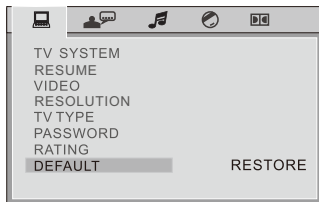

• Subtitle Lang

Enter the **【Subtitle Lang】** option, press **【▶】** key to enter the sub-menu and select the subtitle language you want; ensure that the disc you wish to play has the required capability.



II. Language Setup

The setup operations are as follows:

• OSD Language

Enter the **【OSD Language】** option, press **【▶】** key to enter the sub-menu and select the interface display language you want.

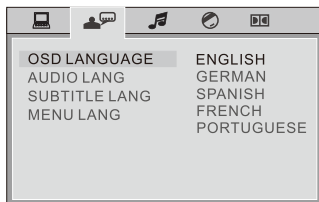

• Menu Lang

Enter the **【Menu Lang】** option, press **【▶】** key to enter the sub-menu and select the menu language you need; ensure that the disc you wish to play has the required capability.

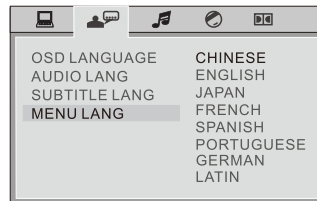

System Setup

III. Audio Setup

The setup operations are as follows:

• Audio Out

Enter the **【Audio out】** option, then press **【▶】** key to enter the sub-menu to select the audio out mode.

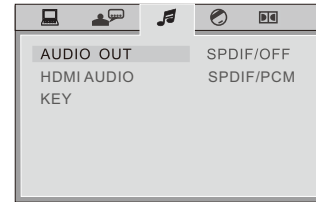

• HDMI Audio

Enter the **【HDMI Audio】** option and press **【▶】** key to enter the sub-menu. You can select: AUTO or PCM.

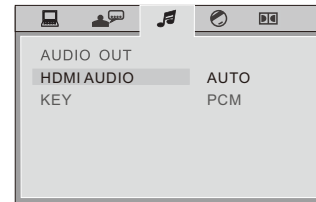

• Key

Enter the **【Key】** option, press **【▶】** key to enter the sub-menu, then use the direction keys "Up" or "Down" to adjust the key volume.

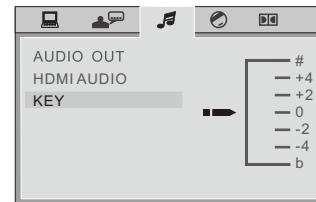

IV. Video Setup

The setup operations are as follows:

• Brightness

Enter the **【Brightness】** option, press **【▶】** key to enter the sub-menu, then use the direction keys "Up" or "Down" to adjust brightness parameters.

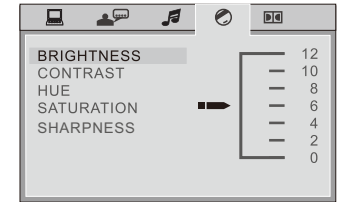

• Contrast

Enter the **【Contrast】** option, press **【▶】** key to enter the sub-menu, then use the direction keys "Up" or "Down" to adjust contrast parameters.

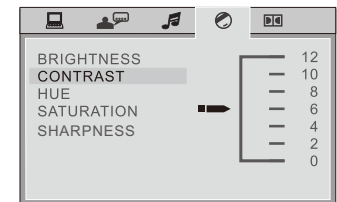

• Hue

Enter the **【Hue】** option, press **【▶】** key to enter the sub-menu, then use the direction keys "Up" or "Down" to adjust hue parameters.

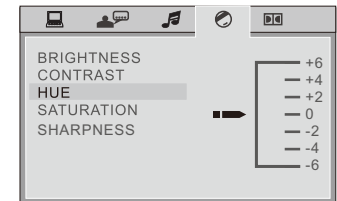

System Setup

● Saturation

Enter the [Saturation] option, press [▶] key to enter the sub-menu, then use the direction keys "Up" or "Down" to adjust saturation parameters.



● Dual Mono

Enter the [Dual Mono] option, then press [▶] key to enter the sub-menu; there are four modes to choose from: STEREO/MONO L/ MONO R/ MIX MONO.

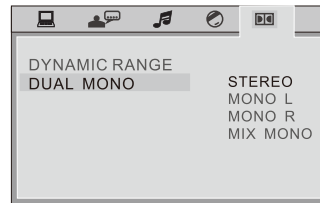

● Sharpness

Enter the [Sharpness] option, press [▶] key to enter the sub-menu, then use the direction keys "Up" or "Down" to adjust sharpness parameters.

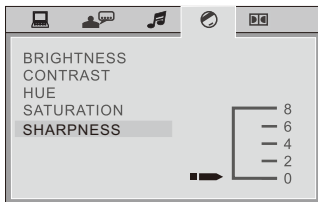

● Dynamic Range

Enter the [Dynamic Range] option, press [▶] key to enter the sub-menu then use the direction keys "Up" and "Down" to select your required option.

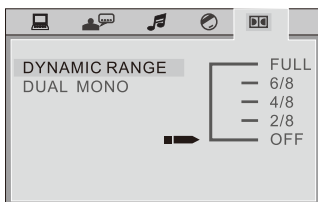

Bluetooth Operation/USB Copy

● Bluetooth Reception

To connect an external device to this unit via Bluetooth:

1. Press "Function Switch" on the remote control or on the panel to select the Bluetooth function. The corresponding screen will then display "BT" indicating that the Bluetooth function is on.
2. Ensure the Bluetooth function is on on the external device and search for H7.
Once found, click on it and pair. Some devices may need a pin code to connect; try 0000 or 1234. Once connected, you will hear a signal indicating that the connection is successful.

USB COPY

● CD File Copy

When playing CD disc, press [Copy] key on the remote, and enter the copy operation interface.

Multiple Setup

1. Move the highlight bar to the "SPEED" option, press the [ENTER] key, then select the desired multiple (i.e. copy speed).
2. In the copying process, select "CHANGE SPEED" option or press [ENTER] key to switch the copy speed.

● Bit Rate Setup

Move the highlight bar to the "BITRATE" option and press [ENTER] to set up; for the file with high bit rate, the capacity will be enlarged and the quality of file will be closer to that of original file. The system default is: 128KBPS.

● Create ID3 Information

Move the highlight bar to "CREATE ID3 TAG" option, press [ENTER] key to select or cancel. By selecting this option during the copying process, the file will be created with ID3 information which is produced automatically by the system.

● Create File List

Move the highlight bar to "CREATE FILE LIST" option, then press [ENTER] key to select or cancel. By selecting this option during the copying process, a file list will be produced automatically.

● Create Playlist

Move the highlight bar to "TRACK" option, press right key to select track option then press [ENTER] key to select the song to be copied or to be cancelled.

● Copy

Move the highlight bar to "START" option; at this time, the information about this copy will be shown on the right hand side (TOTAL TRACKS, TOTAL TIME and TOTAL SIZE). Then press [ENTER] key to start copying and system will write the CD in MP3 format onto the designated USB. When copying at normal speed, you can listen to the content to be copied at the same time; when selecting 4 times speed, it will be mute. Please note: When you press the [ENTER] key to switch speed, there will be slight sound which continues for a few seconds.

● Return from Copying Screen

Move the highlight bar to "QUIT" option and press [ENTER] key to confirm QUIT.

Please note: During copy, ensure that the available space on the USB is enough for the size of the file(s) to be copied then insert the USB into the USB interface. If you have two tracks with the same title, rename one of the tracks, otherwise one track will be saved over the other. While copying, do not pull the USB out or shut the unit down, as this could damage the unit or USB. If the USB cannot be read after it has been copied, please format the USB on your computer. Before you format, please save the important data from the USB.

Common Operation

Disc Playing Operation

● Sequence

- After reading disc, the unit will automatically go into sequence play mode.
- Press **【PLAY/PAUSE】** key in pause mode and play mode will be recovered.

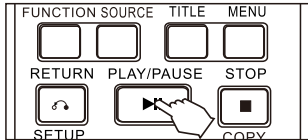

● Menu

Press **【MENU】** when using discs with VCD 2.0, or DVD format. Different formats of discs have different menus.

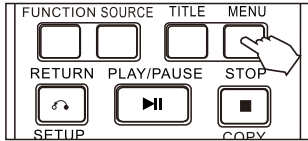

● Title

When playing DVD, you can choose this play mode.

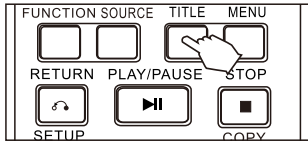

● Select

You can press the number keys on the remote to directly select the required track that you want to play. When VCD is in MENU mode, the track cannot be selected and can only be selected when the MENU mode is off. Different formats of discs have different selecting approaches (for example press number key "5" to select the 5th track. When selecting "23", press "10+" twice and the screen will show "20+"; then press number key "3" or try to press "2" then hold "3" and the unit will select 23).

● GOTO

Press **【GOTO】** key on the remote and use direction keys and number keys to finish time or track selecting function, then press **【ENTER】** key.

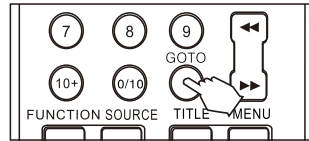

● Repeat

While playing, press **【REPEAT】** key on the remote. Different formats of discs have different repeating approaches to be selected: single cycle, title cycle or disc cycle.

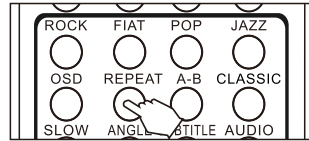

● Slow

During play, press **【SLOW】** key on the remote control. To go back to the normal speed, press **【PLAY】**.

Please note: In this mode, no audio will be heard and it only affects the video files.

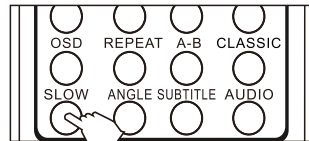

● COPY

Please note: For CD discs, the unit will copy in MP3 format onto the USB. It will copy directly.

Please see Copy Function Introduction for specific operating instructions.



Common Operation

● Function Switching

When you turn the unit on, you can press "FUNCTION" to switch between the different function modes: DISC/BT/FM/COAXIAL/AUX IN/LINE IN/USB.

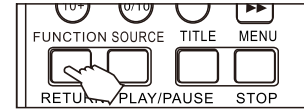

Please note: Please see function introduction for specific operation of FM and audio input.

Volume Adjustment

● Master Volume

Press "VOLUME +" or "VOLUME -" on the remote or turn the volume control knob on the panel to adjust the volume.

● Low Pitch

- Press **【VOLUME】** key on the panel, select "LOW PITCH BA" adjusting state, then press "VOLUME +" or "VOLUME -" key on the remote, or turn the volume control knob on the panel to adjust low pitch.

- Press "BASS +" or "BASS -" key on the remote to directly adjust low pitch.

- Adjustable range of low pitch: from -10 to +10.

● High Pitch

- Press **【VOLUME】** key on the panel, select "HIGH PITCH TR" adjusting state, then press "VOLUME +" or "VOLUME -" key on the remote or turn the volume control knob on the panel to adjust high pitch.

- Press "TREB +" or "TREB -" key on the remote to directly adjust high pitch.

- Adjustable range of high pitch: from -10 to +10.

Disc Playing Operation

Play MP3 Disc

● After inserting MP3 disc, the system will automatically search all directories containing an MP3 file. After searching, the system will enter the first directory by preference and play the first track of this directory (cursor stops in 01 position). The unit will play the tracks of this directory in sequence. At this time, you can press number keys to select which song you want to play.

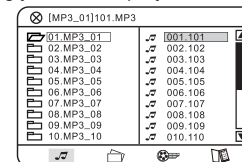

● Directory Selecting/ Press the Left key to return to directory list on the left hand side. Then use Up/Down keys to select folder directory on the left hand side. After the selection process is complete, press **【ENTER】** key to enter the playlist of the folder and the tracks of the playlist will automatically be played in sequence; or you can press number keys to select a specific song.

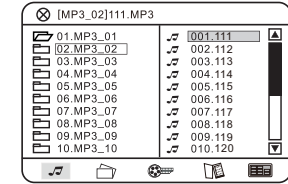

While playing, press **【<< /PREVIOUS】** or **【>> /NEXT】** key to select the previous or next song.

● Press **【REPEAT】** key to select single cycle, directory cycle or disc cycle modes.

● While playing, press **【PAUSE】** key to enter "Pause" state; press **【PLAY】** key to recover from that state. Please note: If you press **【PAUSE】** key twice, you will activate the "Pause" function.

Play JPEG Disc

● After inserting JPEG disc, the unit will automatically search and stop at the first image of the first directory found. Use the Up/Down keys to select image files; after you have finished selecting the images, press **【PLAY】** key to play from current image.

● Use the Up/Down keys to select image files; after you have finished selecting the images, press **【ENTER】** key to view the image. At this time, the image is in an idle state and you can press **【ZOOM】** key to zoom in on the image or press direction keys to move the image in different directions.

● When the image is idle and not zoomed in, press direction keys to rotate the image.

● Press **【PLAY】** key to play the image in sequence.

● After entering file menu on the right hand side, press the Up/Down keys and image content will be shown on the left hand side of the screen. You can also use this approach to view file(s).

Play MP3-JPEG Disc

● If you want to view images while playing MP3-JPEG mixed directory discs, use the Left/Right keys to select modes then use the direction keys to move the cursor to the icon of the required image and press **【ENTER】** to view the image.

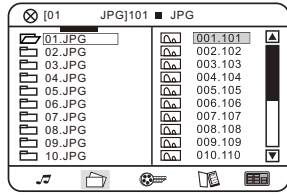

This equipment has been tested and found to comply with the limits for a Class B digital device, pursuant to part 15 of the FCC Rules. These limits are designed to provide reasonable protection against harmful interference in a residential installation. This equipment generates, uses and can radiate radio frequency energy and, if not installed and used in accordance with the instructions, may cause harmful interference to radio communications. However, there is no guarantee that interference will not occur in a particular installation. If this equipment does cause harmful interference to radio or television reception, which can be determined by turning the equipment off and on, the user is encouraged to try to correct the interference by one or more of the following measures:

- Reorient or relocate the receiving antenna.
- Increase the separation between the equipment and receiver.
- Connect the equipment into an outlet on a circuit different from that to which the receiver is connected.
- Consult the dealer or an experienced radio/TV technician for help.

Caution: Any changes or modifications to this device not explicitly approved by manufacturer could void your authority to operate this equipment.

This device complies with part 15 of the FCC Rules. Operation is subject to the following two conditions:
 (1) This device may not cause harmful interference, and (2) this device must accept any interference received, including interference that may cause undesired operation.

RF Exposure Information
 This equipment complies with FCC radiation exposure limits set forth for an uncontrolled environment. This equipment should be installed and operated with minimum distance 20cm between the radiator and your body.

- The method to viewing images is the same as that for playing JPEG discs.
 - If you want to view other types of files while playing MP3-other mixed directory discs, use the Left/Right keys to select mode then use the direction keys to move the cursor to the icon you want to view and press **【ENTER】** to play the selected file.
 - While playing discs with mixed directories, the approach to select a file is the same as playing MP3 disc.
 - The unit will automatically load the files to be played when a disc is inserted. The music files will play by default if there are also supported photo, movie and E book files on the disc.
- Play USB**
- When the USB has only one type of file, the playing method is the same as when you play a disc.
 - When the USB has various types of files, the unit will play the audio files with the MP3 or WMA formats after it has finished its search. The method to playing other types of files is the same as when you play a disc.

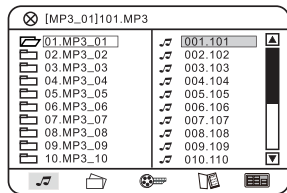

Remark:Support Max capacity for USB is 32GB

- Source switching
- 1.While the disc is playing, press **【SOURCE】** key on the remote control to switch to USB mode.
 2. An interface will appear when switching from disc to USB. Press direction keys to select the file then press **【ENTER】** key for confirmation.
 - 3.System will automatically load the USB files when there is no disc loaded.

FM Operation

FM Radio

- Press **【FUNCTION】** or **【FM】** key on the panel or remote to switch the unit to FM operation mode.

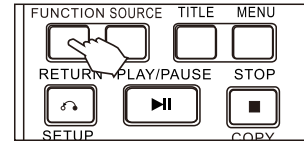

Manual Search

Press **【Fast Backward】** or **【Fast Forward】** keys on the panel or remote to manually tune and search. You can search desired radio stations backwards or forwards.

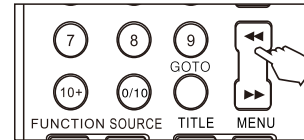

Auto Search

Press **【ENTER】** key on the panel or press and hold **【ENTER】** key on the remote control then the unit will automatically search in full band. FM frequency range:87-108MHZ(100KHZ for each step).

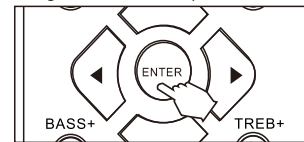

Please note: After you have found your specific station, the unit will automatically store it into current program. The FM search is affected by the radio signal strength. If no program is found during auto search or an offset frequency occurs, please use manual search, frequency-selecting search or adjust frequency by adjusting antenna position.

Frequency-Selecting Search

Press **【GOTO】** key on the remote, the unit will display frequency-selecting state then use number keys to input your desired radio frequency. FM frequency range: 87-108 MHZ

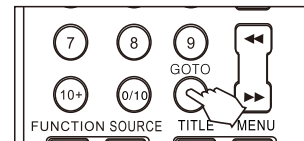

● **Radio Program Selection**

Press **【<<<】** and **【>>>】** keys on the remote or **【<<</PREVIOUS】** and **【>>>/NEXT】** keys on the panel to select stored radio program.

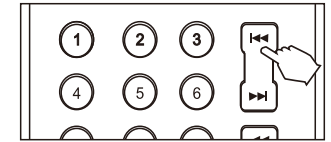

● **Radio Storage**

After operating the "Auto Search", the unit will automatically store the radio program(s) found in sequence. After operating "manual search" or "frequency-selecting search", the unit will automatically store current radio frequency into current program.

External Audio Input Setting

- Press **【FUNCTION】** key on the remote or panel to switch the unit into audio input state.

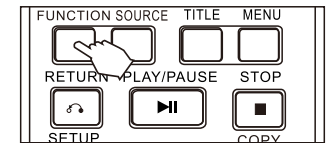

At this time, the unit will display "LINE IN".



At this time, the "AUX" or "Line in" channel interface of the unit must be connected to AF generator input of any machine.

Fault Guide

Troubleshooting

Before repairing, please take a look at the following problems and possible solutions first.

Problem	Reason	Measure
No power.	Plug not properly connected.	Connect attaching plug properly.
The unit doesn't work after the power has been switched on.	No disc or USB inserted.	Insert disc or USB.
No image.	TV isn't set to DVD output.	Set TV to current output platform.
	Bad video connection or not connected well.	Replace TV connection or connect correctly.
	Connected TV doesn't work.	Ensure TV works properly.
No sound.	Not set to current connecting channel.	Set to current connecting channel.
	Bad audio connection or not connected well.	Replace audio connection or connect correctly.
	Connected unit doesn't work or volume shutdown.	Ensure connected unit works properly or turn volume up.
Bad image quality.	Disc is dirty.	Clean disc.
	Bad image quality of disc.	Replace disc with good image quality.
DVD player is not activated.	No disc inserted.	Insert disc.
	Disc installed upside down.	Place the silk-screen side upwards.
	Disc installed incorrectly into it's slot.	Place disc into it's slot correctly.
	Disc is dirty.	Clean disc.
	TV displays setting screen.	Quit setting state.
	Locking level is activated.	Unlock or change locking level.
Remote malfunction.	Remote is not aimed at the receiving window.	Aim remote at the receiving window.
	The remote and DVD player are too far away from each other.	Please operate within effective range of 7m.
	There is a large obstacle between the remote and the receiving window.	Please move obstacle.
Mp3 no sound or with noise.	Remote has low batteries.	Please replace with new batteries.
	Unsupported file format.	Skip the file.
USB files are unavailable	No file on the USB or the format is incorrect.	Please store supportable file formats or format the USB then re-copy the files.
	USB is damaged.	Repair or replace the USB.

Specifications

Main Technical Parameters

Item	Parameter Index
Disc Type	MPEG4
	DVD
	SVCD VCD DVCD
	MP3
	CD
	CD-R CD-RW
Output Interface	Audio: 2.2 Track independent output
	Video: Composite signal (AV) output
	HMDI output
Video Characteristics	Video range: 1. 0Vp_p(75Ω loading)
	Y output range: 1. 0Vp_p(75Ω loading)
	C output range: 0. 286Vp_p/NTSC; 0. 3Vp_p/PLA (75Ω loading)
Audio Characteristics	Frequency characteristics: 70Hz ~20KHz (±75dB)
	SNR: >80dB
	THD: <0.01%
Power Voltage	110-240V ~50/60Hz
Consumed Power	≤250W
PMPO Power	1000W
Operating Temperature	-10℃~+45℃
Operating Humidity	15~75% (No drop condensation)
Accessories	Remote Control, User Manual, FM Antenna, AV Cable, AC Cord

Please note: Design and specification parameters can change without prior notice.