

RADIO TEST REPORT

FCC ID: 2AE6G-GDX

Product : Wireless microphone

Trade Mark : GEMINI

Model Name : GDX-2000M

Serial Model : GDX-1000M

Report No. : SER180330702001E

Prepared for

Innovative Concepts and Design LLC

107 Trumbull st. Building F8 Elizabeth, NJ 07206-2165 USA

Prepared by

Shenzhen NTEK Testing Technology Co., Ltd.

1/F, Building E, Fenda Science Park, Sanwei Community, Xixiang Street
Bao'an District, Shenzhen 518126 P.R. China

Tel.: +86-755-6115 9388 Fax.: +86-755-6115 6599

Website: <http://www.ntek.org.cn>



TEST RESULT CERTIFICATION

Applicant's name : Innovative Concepts and Design LLC
Address : 107 Trumbull st. Building F8 Elizabeth, NJ 07206-2165 USA
Manufacturer's Name : ENPING SANGE ELECTRONIC CO., LTD
Address : No. 12, F District, Individual & Foreign Capital Industry Zone, Enping City, Guangdong Province, P.R.C

Product description

Product name..... : Wireless microphone
Model and/or type reference : GDX-2000M
Serial Model : GDX-1000M
Rating(s)..... : DC 3V from battery

Standards : FCC Part15.249: 2018

Test procedure..... ANSI C63.10-2013

This device described above has been tested by NTEK, and the test results show that the equipment under test (EUT) is in compliance with the FCC requirements. And it is applicable only to the tested sample identified in the report.

This report shall not be reproduced except in full, without the written approval of NTEK, this document may be altered or revised by NTEK, personnel only, and shall be noted in the revision of the document.

Date of Test..... :
Date (s) of performance of tests..... : 30 Mar. 2018 ~27 Apr. 2018
Date of Issue..... : 27 Apr. 2018
Test Result..... : **Pass**

Testing Engineer : Eileen Liu.
(Eileen Liu)

Technical Manager : Jason Chen
(Jason Chen)

Authorized Signatory : Sam. Chen
(Sam Chen)

Table of Contents	Page
1 . SUMMARY OF TEST RESULTS	4
1.1 TEST FACILITY	5
1.2 MEASUREMENT UNCERTAINTY	5
2 . GENERAL INFORMATION	6
2.1 GENERAL DESCRIPTION OF EUT	6
2.2 DESCRIPTION OF TEST MODES	8
2.3 BLOCK DIGRAM SHOWING THE CONFIGURATION OF SYSTEM TESTED	9
2.4 DESCRIPTION OF SUPPORT UNITS(CONDUCTED MODE)	10
2.5 EQUIPMENTS LIST FOR ALL TEST ITEMS	11
3 . ANTENNA REQUIREMENT	13
3.1 STANDARD REQUIREMENT	13
3.2 EUT ANTENNA	13
3.3 CONDUCTED EMISSION MEASUREMENT	14
3.3.1 POWER LINE CONDUCTED EMISSION LIMITS	14
3.3.2 TEST PROCEDURE	14
3.3.3 DEVIATION FROM TEST STANDARD	14
3.3.4 TEST SETUP	15
3.2.5 TEST RESULT	16
3.4 RADIATED EMISSION MEASUREMENT	17
3.4.1 RADIATED EMISSION LIMITS	17
3.4.2 TEST PROCEDURE	18
3.4.3 DEVIATION FROM TEST STANDARD	18
3.4.4 TEST RESULTS (BELOW 30MHZ)	21
3.4.5 TEST RESULTS (BELOW 1000 MHZ)	22
3.4.6 TEST RESULTS (ABOVE 1000 MHZ)	28
3.4.7 TEST RESULTS (RESTRICTED BANDS REQUIREMENTS)	40
4 . FREQUENCY TOLERANCE	44
4.1 FREQUENCY TOLERANCE LIMITS	44
4.2TEST PROCEDURE	44
4.3 TEST SETUP	44
4.4 TEST RESULTS	44
5. BANDWIDTH TEST	48
5.1 TEST PROCEDURE	48
5.1 DEVIATION FROM STANDARD	48
5.1 TEST SETUP	48
6. TEST RESULTS	49

1. SUMMARY OF TEST RESULTS

Test procedures according to the technical standards:

FCC Part15, Subpart C (15.249)			
Standard Section	Test Item	Judgment	Remark
15.207	Conducted Emission	N/A	
15.203	Antenna Requirement	Pass	
15.249 15.209	Radiated Spurious Emission	Pass	
15.249(2)	Frequency Tolerance	Pass	
15.249(a)	Fundamental Measurement	Pass	
15.205	Band Edge Emission	Pass	
15.249	Occupied Bandwidth	Pass	

1.1 TEST FACILITY

Shenzhen NTEK Testing Technology Co., Ltd

Add. : 1/F, Building E, Fenda Science Park, Sanwei Community, Xixiang Street, Bao'an District, Shenzhen 518126 P.R. China.

FCC FRN Registration No.:463705; IC Registration No.:9270A-1

CNAS Registration No.:L5516

1.2 MEASUREMENT UNCERTAINTY

The reported uncertainty of measurement $y \pm U$, where expanded uncertainty U is based on a standard uncertainty multiplied by a coverage factor of $k=2$, providing a level of confidence of approximately **95 %**.

No.	Item	Uncertainty
1	Conducted Emission Test	$\pm 1.38\text{dB}$
2	RF power,conducted	$\pm 0.16\text{dB}$
3	Spurious emissions,conducted	$\pm 0.21\text{dB}$
4	All emissions,radiated(<1G)	$\pm 4.68\text{dB}$
5	All emissions,radiated(>1G)	$\pm 4.89\text{dB}$
6	Temperature	$\pm 0.5\text{C}$
7	Humidity	$\pm 2\%$

2. GENERAL INFORMATION

2.1 GENERAL DESCRIPTION OF EUT

Equipment	Wireless microphone
Trade Mark	GEMINI
Model Name	GDX-2000M
Serial Model	GDX-1000M
Model Difference	All the model are the same circuit and RF module, except the model name.
Product Description	The EUT is a Wireless microphone
	Operation Frequency: Frequency 1:2404-2434MHz Frequency 2:2444-2474 MHz
	Modulation Type: GFSK
	Antenna Designation: PCB Antenna
	Antenna Gain(Peak) 1 dBi
	Based on the application, features, or specification exhibited in User's Manual. More details of EUT technical specification, please refer to the User's Manual.
Channel List	Please refer to the Note 2.
Adapter	N/A
Battery	DC 3V
HW Version	BM-2419T3
SW Version	BM2419-TIA-A0

Note:

1. For a more detailed features description, please refer to the manufacturer's specifications or the User's Manual.

2.

Channel	Frequency 1 (MHz)	Frequency 2 (MHz)
01	2406	2446
02	2408	2448
03	2410	2450
04	2412	2452
05	2414	2454
06	2416	2456
07	2418	2458
08	2420	2460
09	2422	2462
10	2424	2464
11	2426	2466
12	2428	2468
13	2430	2470
14	2432	2472
15	2434	2474
16	2404	2444

3.

Table for Filed Antenna

Ant.	Brand	Model Name	Antenna Type	Connector	Gain (dBi)	NOTE
1	N/A	N/A	PCB Antenna	N/A	1	Antenna

2.2 DESCRIPTION OF TEST MODES

To investigate the maximum EMI emission characteristics generates from EUT, the test system was pre-scanning tested base on the consideration of following EUT operation mode or test configuration mode which possible have effect on EMI emission level. Each of these EUT operation mode(s) or test configuration mode(s) mentioned above was evaluated respectively.

Pretest Mode	Description
Mode 1	CH16
Mode 2	CH08
Mode 3	CH15

For Radiated Spurious Emission	
Pretest Mode	Description
Mode 1	CH16
Mode 2	CH08
Mode 3	CH15

For Conducted Emission	
Final Test Mode	Description
Mode 1	CH16
Mode 2	CH08
Mode 3	CH15

Note:

- (1) The measurements are performed at the highest, middle, lowest available channels.
- (2) Use the new battery to test.

2.3 BLOCK DIGRAM SHOWING THE CONFIGURATION OF SYSTEM TESTED

Radiated Spurious Emission Test

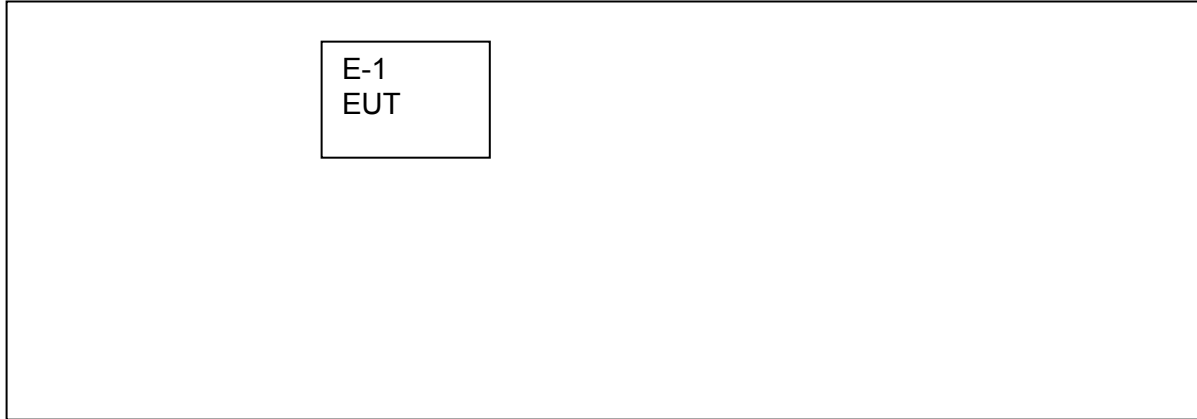

2.4 DESCRIPTION OF SUPPORT UNITS(CONDUCTED MODE)

The EUT has been tested as an independent unit together with other necessary accessories or support units. The following support units or accessories were used to form a representative test configuration during the tests.

Item	Equipment	Mfr/Brand	Model/Type No.	Series No.	Note
E-1	Wireless microphone	GEMINI	GDX-2000M	N/A	EUT

Item	Cable Type	Shielded Type	Ferrite Core	Length	Note

Note:

- (1) The support equipment was authorized by Declaration of Confirmation.
- (2) For detachable type I/O cable should be specified the length in cm in 『Length』 column.

2.5 EQUIPMENTS LIST FOR ALL TEST ITEMS
Radiation Test equipment

Item	Kind of Equipment	Manufacturer	Type No.	Serial No.	Last calibration	Calibrated until	Calibration period
1	Spectrum Analyzer	Agilent	E4407B	MY45108040	2017.06.06	2018.06.05	1 year
2	Spectrum Analyzer	Agilent	N9020A	MY49100060	2017.11.10	2018.11.09	1 year
3	EMI Test Receiver	Agilent	N9038A	MY53227146	2017.06.06	2018.06.05	1 year
4	Test Receiver	R&S	ESPI	101318	2017.06.06	2018.06.05	1 year
5	Bilog Antenna	TESEQ	CBL6111D	31216	2018.04.09	2019.04.08	1 year
6	50Ω Coaxial Switch	Anritsu	MP59B	6200983705	2017.06.06	2018.06.05	1 year
7	Horn Antenna	EM	EM-AH-10180	2011071402	2018.04.09	2019.04.08	1 year
8	Horn Ant	Schwarzbeck	BBHA 9170	9170-181	2017.07.06	2018.07.05	1 year
9	Amplifier	EMC	EMC051835SE	980246	2017.08.09	2018.08.08	1 year
10	Amplifier	MITEQ	TTA1840-35-HG	177156	2017.06.06	2018.06.05	1 year
11	Loop Antenna	ARA	PLA-1030/B	1029	2017.06.06	2018.06.05	1 year
12	Power Meter	DARE	RPR3006W	15I00041S NO84	2017.08.07	2018.08.06	1 year
13	Test Cable (9KHz-30MHz)	N/A	R-01	N/A	2017.04.21	2020.04.20	3 year
14	Test Cable (30MHz-1GHz)	N/A	R-02	N/A	2017.04.21	2020.04.20	3 year
15	High Test Cable(1G-40 GHz)	N/A	R-03	N/A	2017.04.21	2020.04.20	3 year
16	High Test Cable(1G-40 GHz)	N/A	R-04	N/A	2017.04.21	2020.04.20	3 year
17	temporary antenna connector (Note)	NTS	R001	N/A	N/A	N/A	N/A

Note:

We will use the temporary antenna connector (soldered on the PCB board) When conducted test
 And this temporary antenna connector is listed within the instrument list

Conduction Test equipment

Item	Kind of Equipment	Manufacturer	Type No.	Serial No.	Last calibration	Calibrated until	Calibration period
1	Test Receiver	R&S	ESCI	101160	2017.06.06	2018.06.05	1 year
2	LISN	R&S	ENV216	101313	2018.04.19	2019.04.18	1 year
3	LISN	SCHWARZBECK	NNLK 8129	8129245	2017.06.06	2018.06.05	1 year
4	50Ω Coaxial Switch	ANRITSU CORP	MP59B	6200983704	2017.06.06	2018.06.05	1 year
5	Test Cable (9KHz-30MHz)	N/A	C01	N/A	2017.04.21	2020.04.20	3 year
6	Test Cable (9KHz-30MHz)	N/A	C02	N/A	2017.04.21	2020.04.20	3 year
7	Test Cable (9KHz-30MHz)	N/A	C03	N/A	2017.04.21	2020.04.20	3 year

Note: Each piece of equipment is scheduled for calibration once a year except the Test Cable which is scheduled for calibration every 3 years.

3. ANTENNA REQUIREMENT

3.1 STANDARD REQUIREMENT

15.203 requirement: For intentional device, according to 15.203: an intentional radiator shall be designed to ensure that no antenna other than that furnished by the responsible party shall be used with the device.

3.2 EUT ANTENNA

The EUT antenna is permanent attached PCB antenna(Gain:1dBi). It comply with the standard requirement.

3.3 CONDUCTED EMISSION MEASUREMENT

3.3.1 POWER LINE CONDUCTED EMISSION Limits (Frequency Range 150KHz-30MHz)

Frequency(MHz)	Conducted Emission Limit	
	Quasi-peak	Average
0.15-0.5	66-56*	56-46*
0.5-5.0	56	46
5.0-30.0	60	50

Note: 1. *Decreases with the logarithm of the frequency
 2. The lower limit shall apply at the transition frequencies
 3. The limit decreases in line with the logarithm of the frequency in the range of 0.15 to 0.50MHz.

The following table is the setting of the receiver

Receiver Parameters	Setting
Attenuation	10 dB
Start Frequency	0.15 MHz
Stop Frequency	30 MHz
IF Bandwidth	9 kHz

3.3.2 TEST PROCEDURE

- a. The EUT was placed 0.4 meters from the horizontal ground plane with EUT being connected to the power mains through a line impedance stabilization network (LISN). All other support equipments powered from additional LISN(s). The LISN provide 50 Ohm/ 50uH of coupling impedance for the measuring instrument.
- b. Interconnecting cables that hang closer than 40 cm to the ground plane shall be folded back and forth in the center forming a bundle 30 to 40 cm long.
- c. I/O cables that are not connected to a peripheral shall be bundled in the center. The end of the cable may be terminated, if required, using the correct terminating impedance. The overall length shall not exceed 1 m.
- d. LISN at least 80 cm from nearest part of EUT chassis.
- e. For the actual test configuration, please refer to the related Item –EUT Test Photos.

3.3.3 DEVIATION FROM TEST STANDARD

No deviation

3.3.4 TEST SETUP

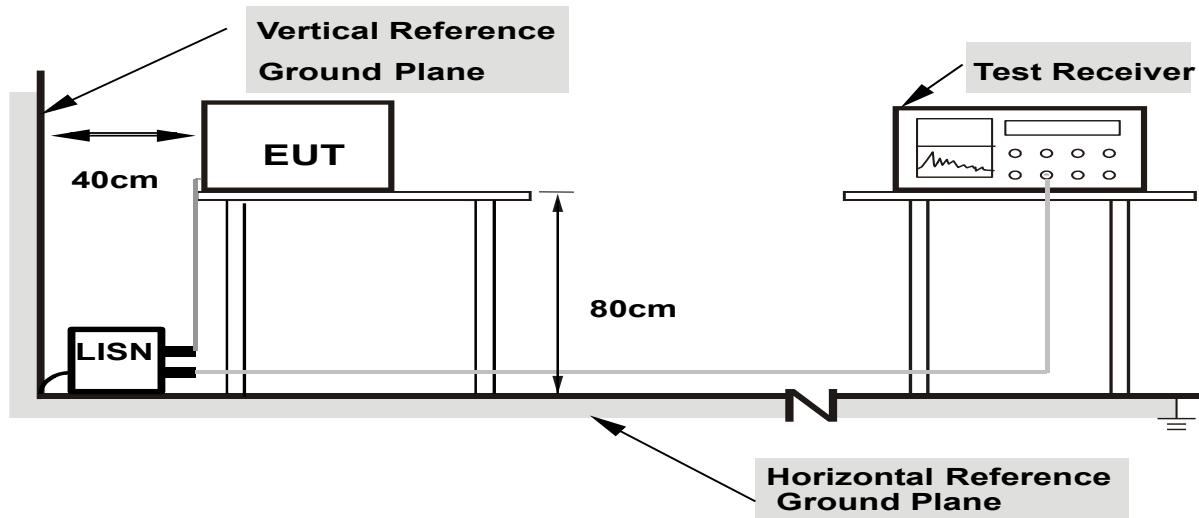

- Note:**
1. Support units were connected to second LISN.
 2. Both of LISNs (AMN) are 80 cm from EUT and at least 80 from other units and other metal planes

3.2.5 TEST RESULT

EUT :	Wireless microphone	Model Name. :	GDX-2000M
Temperature :	25 °C	Relative Humidity :	55%
Pressure :	1010hPa	Phase :	N/A
Test Voltage :	N/A	Test Mode :	N/A

Note: Not applicable

3.4 RADIATED EMISSION MEASUREMENT

3.4.1 Radiated Emission Limits (FCC 15.209)

Frequencies (MHz)	Field Strength (micorvolts/meter)	Measurement Distance (meters)
0.009~0.490	2400/F(KHz)	300
0.490~1.705	24000/F(KHz)	30
1.705~30.0	30	30
Frequency (MHz)	Limit (dBuV)	
30~88	40	3
88~216	43.5	3
216~960	46	3
960 -10000	54.00	3
*902 - 928	94.00	3

Note:

- (1) The tighter limit applies at the band edges.
- (2) Emission level (dBuV/m)=20log Emission level (uV/m).
- (3) *Note: This is the limit for the fundamental frequency.

LIMITS OF RADIATED EMISSION MEASUREMENT (FCC 15.249)

Frequency of Emission (MHz)	Field Strength of fundamental ((millivolts /meter)	Field Strength of Harmonics (microvolts/meter)
2400-2483.5	50	500

Notes:

- (1) Emissions radiated outside of the specified frequency bands, except for harmonics, shall be attenuated by at least 50 dB below the level of the fundamental or to the general radiated emission limits in Section 15.209, whichever is the lesser attenuation.

Spectrum Parameter	Setting
Attenuation	Auto
Start Frequency	1000 MHz
Stop Frequency	10th carrier harmonic
RB / VB (emission in restricted band)	1MHz / 1MHz for Peak

Receiver Parameter	Setting
Attenuation	Auto
Start ~ Stop Frequency	9kHz~150kHz / RB 200Hz for QP
Start ~ Stop Frequency	150kHz~30MHz / RB 9kHz for QP
Start ~ Stop Frequency	30MHz~1000MHz / RB 120kHz for QP

3.4.2 TEST PROCEDURE

- a. The measuring distance of at 3 m shall be used for measurements at frequency up to 1GHz. For frequencies above 1GHz, any suitable measuring distance may be used.
- b. The EUT was placed on the top of a rotating table 0.8 m for below 1GHz and 1.5m for above 1GHz the ground at a 3 meter. The table was rotated 360 degrees to determine the position of the highest radiation.
- c. The height of the equipment or of the substitution antenna shall be 0.8 m for below 1GHz and 1.5m for above 1GHz; the height of the test antenna shall vary between 1 m to 4 m. Both horizontal and vertical polarizations of the antenna are set to make the measurement.
- d. The initial step in collecting conducted emission data is a spectrum analyzer peak detector mode pre-scanning the measurement frequency range. Significant peaks are then marked and then Quasi Peak detector mode re-measured.
- e. If the Peak Mode measured value compliance with and lower than Quasi Peak Mode Limit, the EUT shall be deemed to meet QP Limits and then no additional QP Mode measurement performed.
- f. For the actual test configuration, please refer to the related Item –EUT Test Photos.

Note:

Both horizontal and vertical antenna polarities were tested and performed pretest to three orthogonal axis. The worst case emissions were reported

3.4.3 DEVIATION FROM TEST STANDARD

No deviation

(A) Radiated Emission Test-Up Frequency Below 30MHz

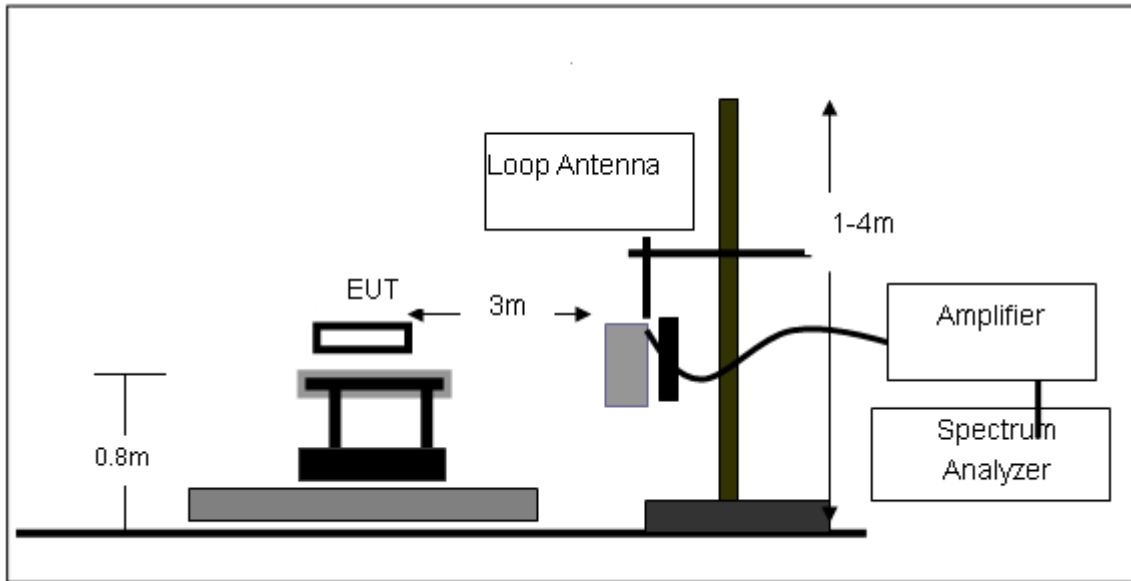

(B) Radiated Emission Test-Up Frequency 30MHz~1GHz

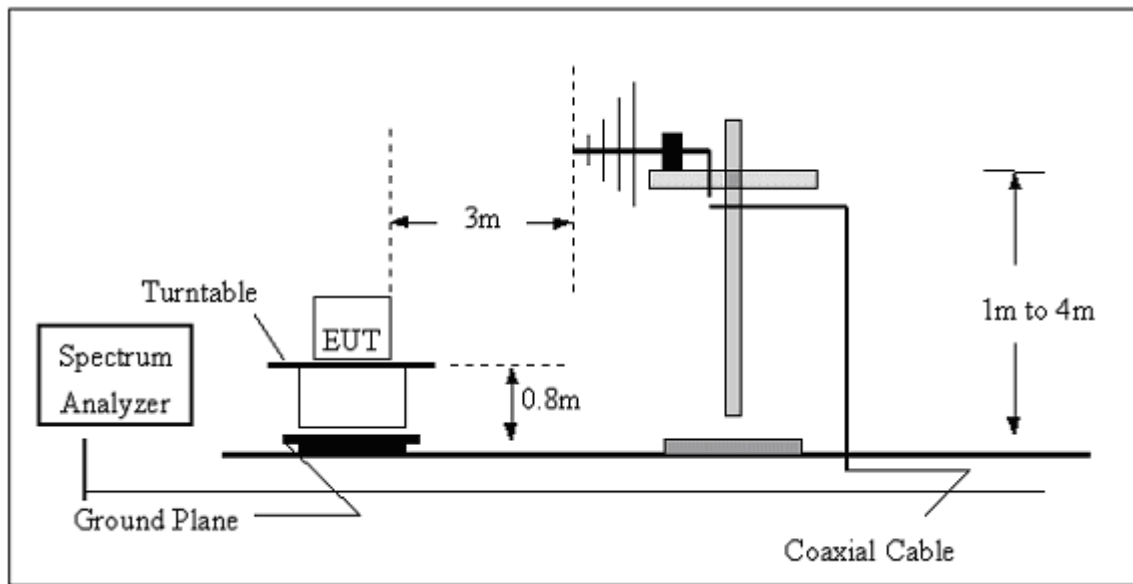

(C) Radiated Emission Test-Up Frequency Above 1GHz

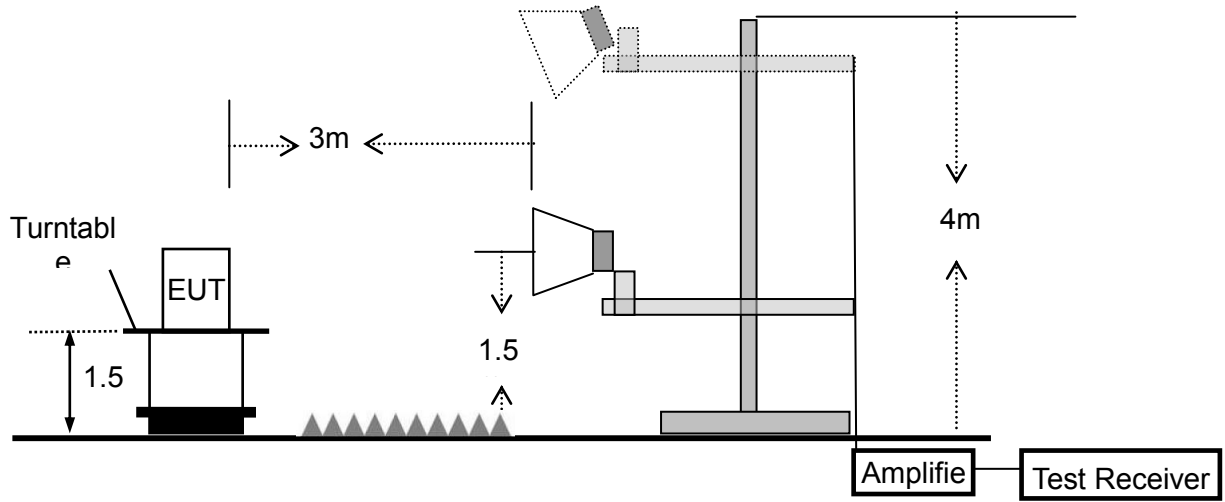

3.4.4 TEST RESULTS (BELOW 30MHz)

EUT :	Wireless microphone	Model Name. :	GDX-2000M
Temperature :	20 °C	Relative Humidity :	48%
Pressure :	1010 hPa	Test Voltage :	DC 3V from battery
Test Mode :	TX	Polarization :	--

Freq.	Reading	Limit	Margin	State
(MHz)	(dBuV/m)	(dBuV/m)	(dB)	P/F
--	--	--	--	PASS
--	--	--	--	PASS

NOTE:

The amplitude of spurious emissions which are attenuated by more than 20dB below the permissible value has no need to be reported.

Distance extrapolation factor = $20 \log(\text{specific distance}/\text{test distance})(\text{dB})$;

Limit line = specific limits(dBuv) + distance extrapolation factor.

3.4.5 TEST RESULTS (BELOW 1000 MHz)

EUT :	Wireless microphone	Model Name :	GDX-2000M
Temperature :	25 °C	Relative Humidity :	51%
Pressure :	1010 hPa	Test Voltage :	DC 3V from battery
Test Mode :	Model 1	Polarization :	Vertical

Frequency (MHz)	Meter Reading (dB μ V)	Factor (dB)	Emission Level (dB μ V/m)	Limits (dB μ V/m)	Margin (dB)	Detector Type
33.9174	5.48	19.41	24.89	40.00	-15.11	QP
144.8418	18.22	11.35	29.57	43.50	-13.93	QP
663.4728	6.59	20.94	27.53	46.00	-18.47	QP
768.7481	7.59	22.36	29.95	46.00	-16.05	QP
884.5027	6.69	25.29	31.98	46.00	-14.02	QP

Remark:

1. Factor = Antenna Factor + Cable Loss – Pre-amplifier.

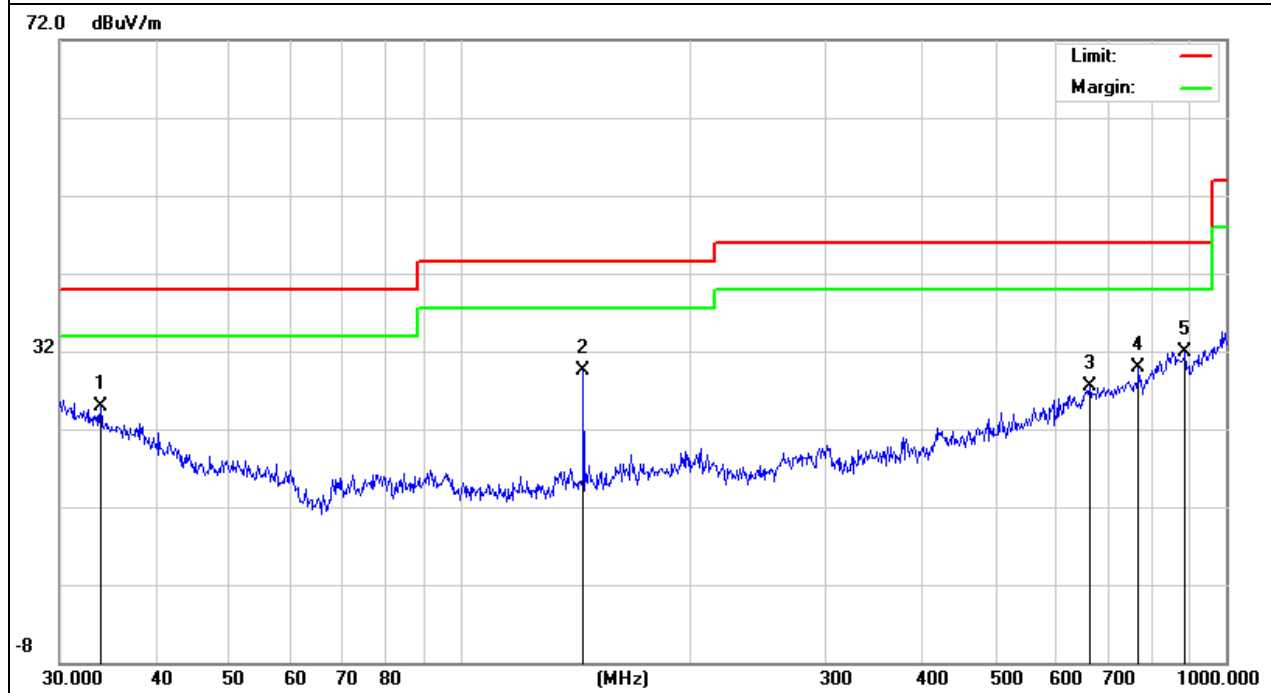

EUT :	Wireless microphone	Model Name :	GDX-2000M
Temperature :	25 °C	Relative Humidity :	51%
Pressure :	1010 hPa	Test Voltage :	DC 3V from battery
Test Mode :	Model 1	Polarization :	Horizontal

Frequency (MHz)	Meter Reading (dB μ V)	Factor (dB)	Emission Level (dB μ V/m)	Limits (dB μ V/m)	Margin (dB)	Detector Type
30.8535	5.05	20.84	25.89	40.00	-14.11	QP
284.9767	14.01	14.08	28.09	46.00	-17.91	QP
344.3855	15.69	14.30	29.99	46.00	-16.01	QP
364.2595	14.18	14.52	28.70	46.00	-17.30	QP
768.7481	9.72	22.36	32.08	46.00	-13.92	QP

Remark:

1. Factor = Antenna Factor + Cable Loss – Pre-amplifier.

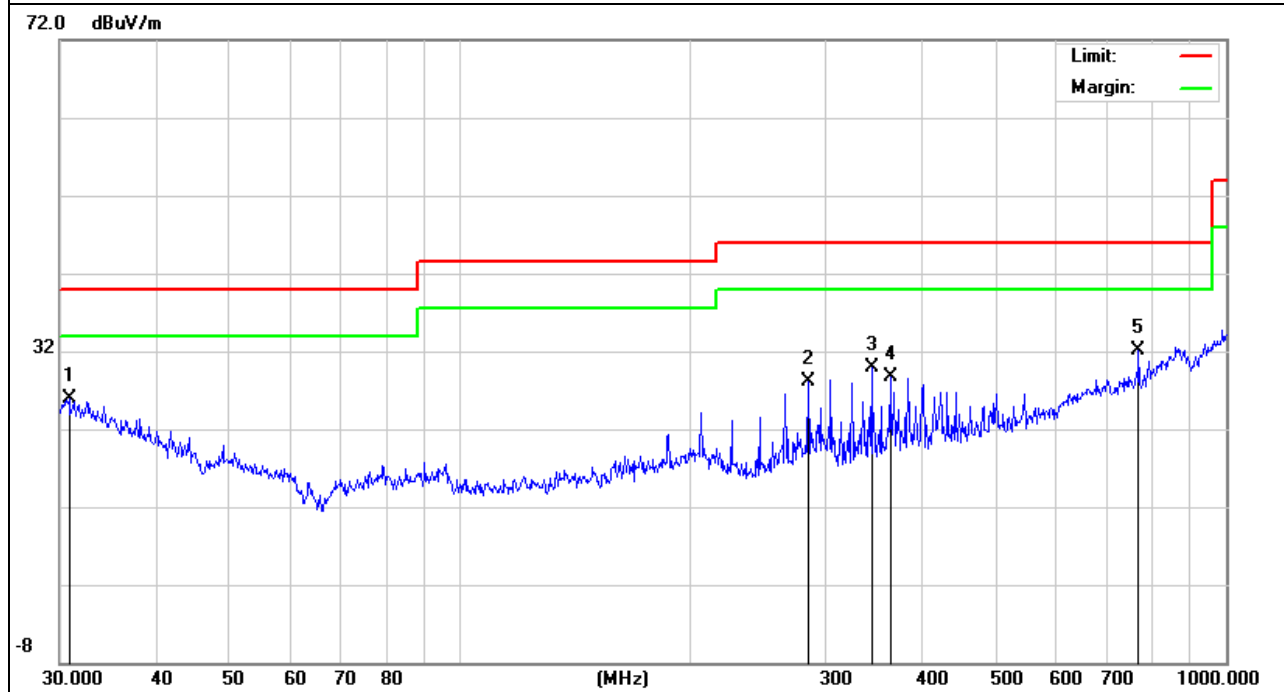

EUT :	Wireless microphone	Model Name :	GDX-2000M
Temperature :	25 °C	Relative Humidity :	51%
Pressure :	1010 hPa	Test Voltage :	DC 3V from battery
Test Mode :	Model 2	Polarization :	Vertical

Frequency (MHz)	Meter Reading (dBμV)	Factor (dB)	Emission Level (dBμV/m)	Limits (dBμV/m)	Margin (dB)	Detector Type
33.0949	6.00	19.81	25.81	40.00	-14.19	QP
206.3976	7.54	13.71	21.25	43.50	-22.25	QP
323.3204	18.20	13.57	31.77	46.00	-14.23	QP
768.7481	9.34	22.36	31.70	46.00	-14.30	QP
839.1816	7.16	25.58	32.74	46.00	-13.26	QP

Remark:

1. Factor = Antenna Factor + Cable Loss – Pre-amplifier.

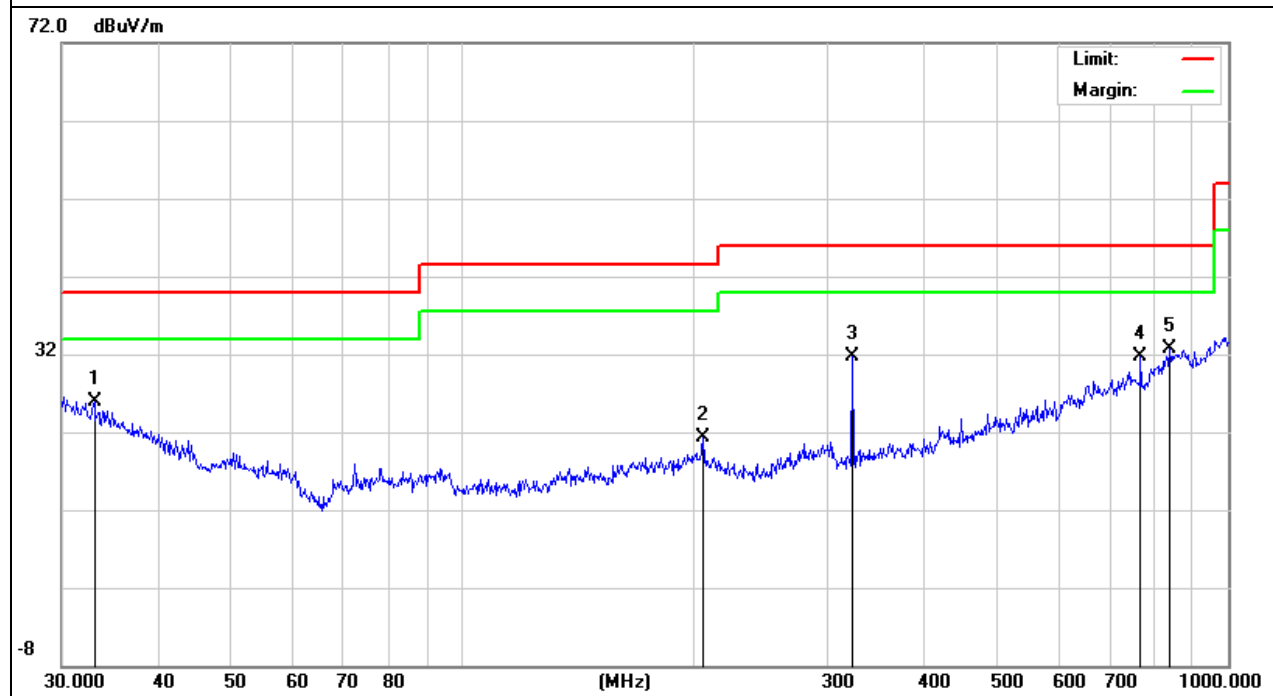

EUT :	Wireless microphone	Model Name :	GDX-2000M
Temperature :	25 °C	Relative Humidity :	51%
Pressure :	1010 hPa	Test Voltage :	DC 3V from battery
Test Mode :	Model 2	Polarization :	Horizontal

Frequency (MHz)	Meter Reading (dB μ V)	Factor (dB)	Emission Level (dB μ V/m)	Limits (dB μ V/m)	Margin (dB)	Detector Type
31.5095	6.20	20.55	26.75	40.00	-13.25	QP
304.6099	14.52	14.05	28.57	46.00	-17.43	QP
344.3855	15.51	14.30	29.81	46.00	-16.19	QP
383.9318	13.77	14.94	28.71	46.00	-17.29	QP
768.7481	9.14	22.36	31.50	46.00	-14.50	QP

Remark:

1. Factor = Antenna Factor + Cable Loss – Pre-amplifier.

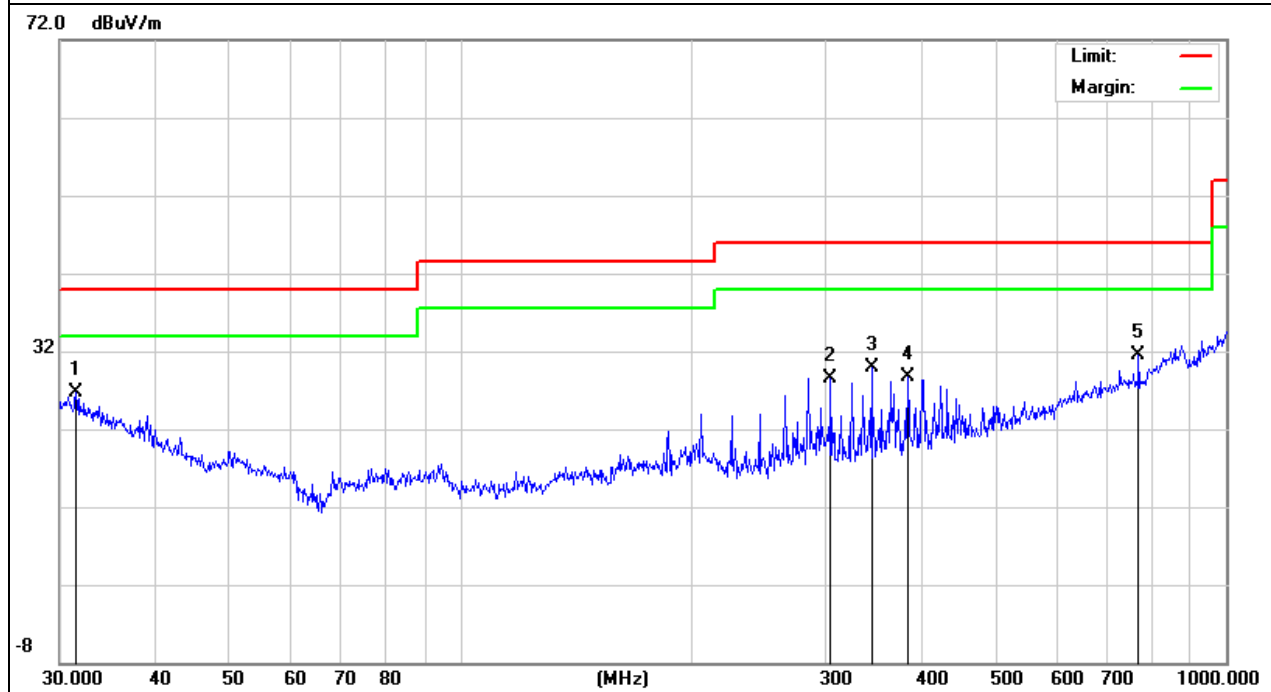

EUT :	Wireless microphone	Model Name :	GDX-2000M
Temperature :	25 °C	Relative Humidity :	51%
Pressure :	1010 hPa	Test Voltage :	DC 3V from battery
Test Mode :	Model 3	Polarization :	Vertical

Frequency (MHz)	Meter Reading (dBμV)	Factor (dB)	Emission Level (dBμV/m)	Limits (dBμV/m)	Margin (dB)	Detector Type
37.4165	5.44	17.76	23.20	40.00	-16.80	QP
90.2205	5.61	11.79	17.40	43.50	-26.10	QP
206.3976	6.15	13.71	19.86	43.50	-23.64	QP
265.6757	6.43	13.45	19.88	46.00	-26.12	QP
833.3170	7.30	24.90	32.20	46.00	-13.80	QP

Remark:

1. Factor = Antenna Factor + Cable Loss – Pre-amplifier.

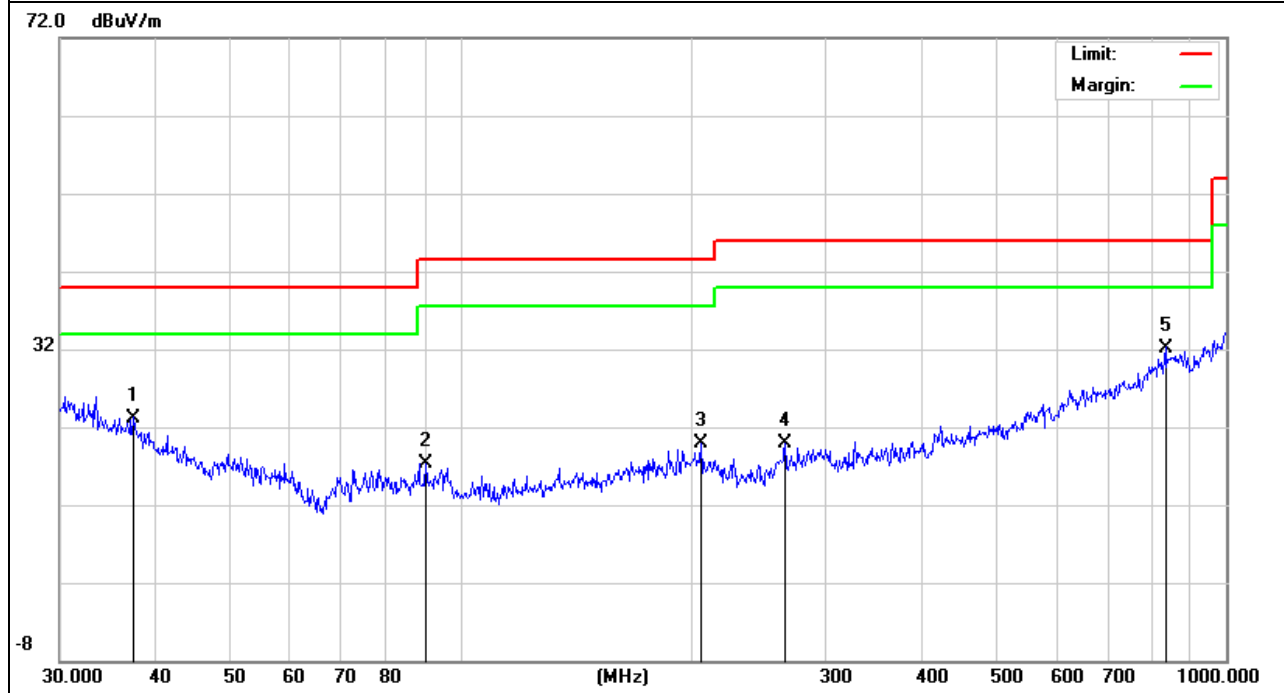

EUT :	Wireless microphone	Model Name :	GDX-2000M
Temperature :	25 °C	Relative Humidity :	51%
Pressure :	1010 hPa	Test Voltage :	DC 3V from battery
Test Mode :	Model 3	Polarization :	Horizontal

Frequency (MHz)	Meter Reading (dB μ V)	Factor (dB)	Emission Level (dB μ V/m)	Limits (dB μ V/m)	Margin (dB)	Detector Type
265.6757	13.41	13.45	26.86	46.00	-19.14	QP
304.6099	14.93	14.05	28.98	46.00	-17.02	QP
344.3855	16.06	14.30	30.36	46.00	-15.64	QP
383.9318	13.99	14.94	28.93	46.00	-17.07	QP
768.7481	9.56	22.36	31.92	46.00	-14.08	QP

Remark:

1. Factor = Antenna Factor + Cable Loss – Pre-amplifier.

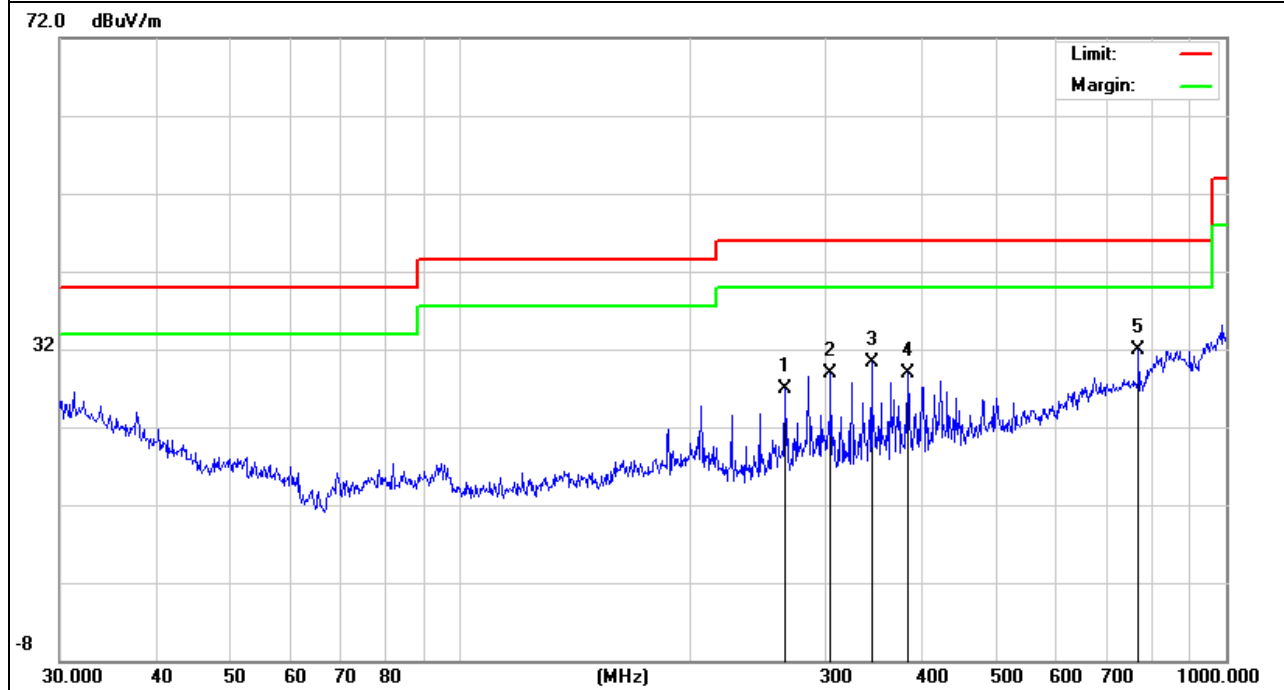

3.4.6 TEST RESULTS (ABOVE 1000 MHZ)

EUT :	Wireless microphone	Model Name :	GDX-2000M
Temperature :	25 °C	Relative Humidity :	51%
Pressure :	1010 hPa	Test Voltage :	DC 3V from battery
Test Mode :	Model 1	Polarization :	Horizontal

Frequency (MHz)	Meter Reading (dBμV)	Factor (dB)	Emission Level (dBμV/m)	Limits (dBμV/m)	Margin (dB)	Detector Type
4910.000	43.12	12.21	55.33	74.00	-18.67	peak
4910.000	28.15	12.21	40.36	54.00	-13.64	AVG
9670.000	3.78	51.09	54.87	74.00	-19.13	peak
9670.000	-13.60	51.09	37.49	54.00	-16.51	AVG
9840.000	5.04	51.70	56.74	74.00	-17.26	peak
9840.000	-11.13	51.70	40.57	54.00	-13.43	AVG

Remark:

Factor = Antenna Factor + Cable Loss – Pre-amplifier.

No emission above 18GHz.

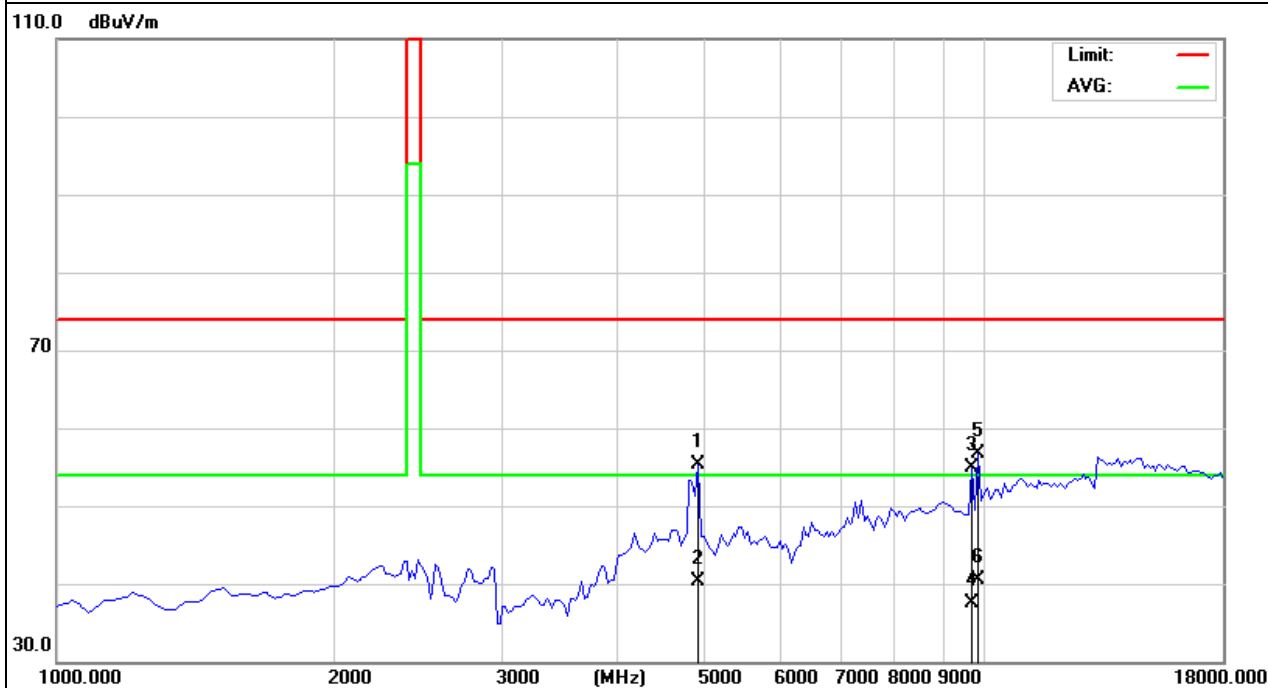

Frequency (MHz)	Meter Reading (dB μ V)	Factor (dB)	Emission Level (dB μ V/m)	Limits (dB μ V/m)	Margin (dB)	Detector Type
2404.000	85.52	1.98	87.50	114.00	-26.50	peak
2404.000	68.90	1.98	70.88	94.00	-23.12	AVG
2444.000	85.66	1.04	86.70	114.00	-27.30	peak
2444.000	68.20	1.04	69.24	94.00	-24.76	AVG

Remark:

Factor = Antenna Factor + Cable Loss – Pre-amplifier.

No emission above 18GHz.

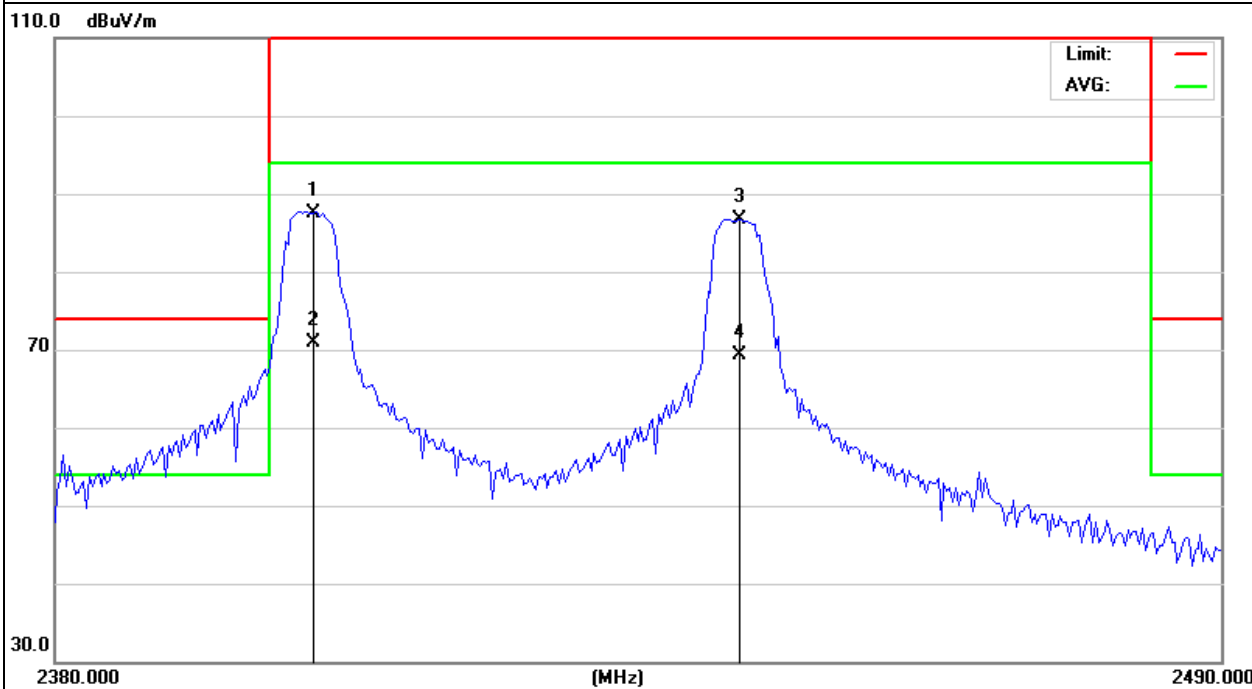

EUT :	Wireless microphone	Model Name :	GDX-2000M
Temperature :	25 °C	Relative Humidity :	51%
Pressure :	1010 hPa	Test Voltage :	DC 3V from battery
Test Mode :	Model 1	Polarization :	Vertical

Frequency (MHz)	Meter Reading (dB μ V)	Factor (dB)	Emission Level (dB μ V/m)	Limits (dB μ V/m)	Margin (dB)	Detector Type
4910.000	42.83	12.21	55.04	74.00	-18.96	peak
4910.000	29.30	12.21	41.51	54.00	-12.49	AVG
7205.000	6.95	48.98	55.93	74.00	-18.07	peak
7205.000	-10.40	48.98	38.58	54.00	-15.42	AVG
7332.500	7.33	49.20	56.53	74.00	-17.47	peak
7332.500	-9.80	49.20	39.40	54.00	-14.60	AVG
9627.500	3.86	50.92	54.78	74.00	-19.22	peak
9627.500	-12.40	50.92	38.52	54.00	-15.48	AVG

Remark:

Factor = Antenna Factor + Cable Loss – Pre-amplifier.

No emission above 18GHz.

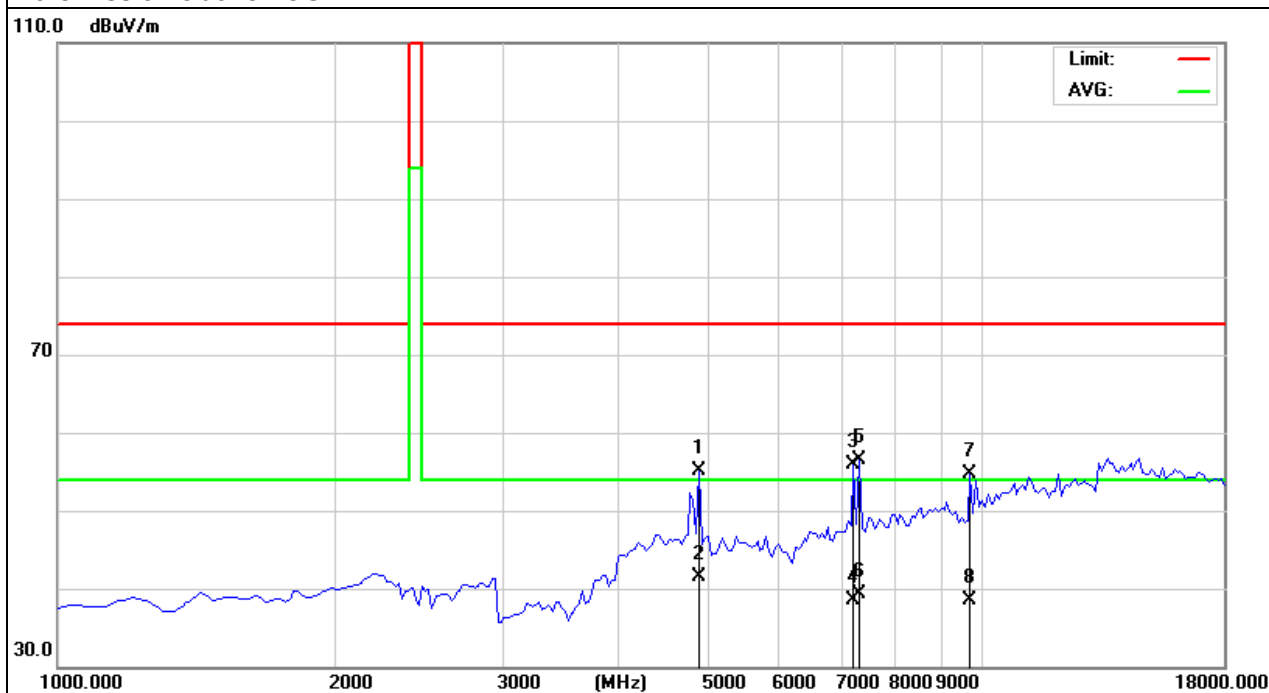

Frequency (MHz)	Meter Reading (dB μ V)	Factor (dB)	Emission Level (dB μ V/m)	Limits (dB μ V/m)	Margin (dB)	Detector Type
2404.000	81.26	1.98	83.24	114.00	-30.76	peak
2404.000	64.20	1.98	66.18	94.00	-27.82	AVG
2444.000	80.99	1.04	82.03	114.00	-31.97	peak
2444.000	63.60	1.04	64.64	94.00	-29.36	AVG

Remark:

Factor = Antenna Factor + Cable Loss – Pre-amplifier.

No emission above 18GHz.

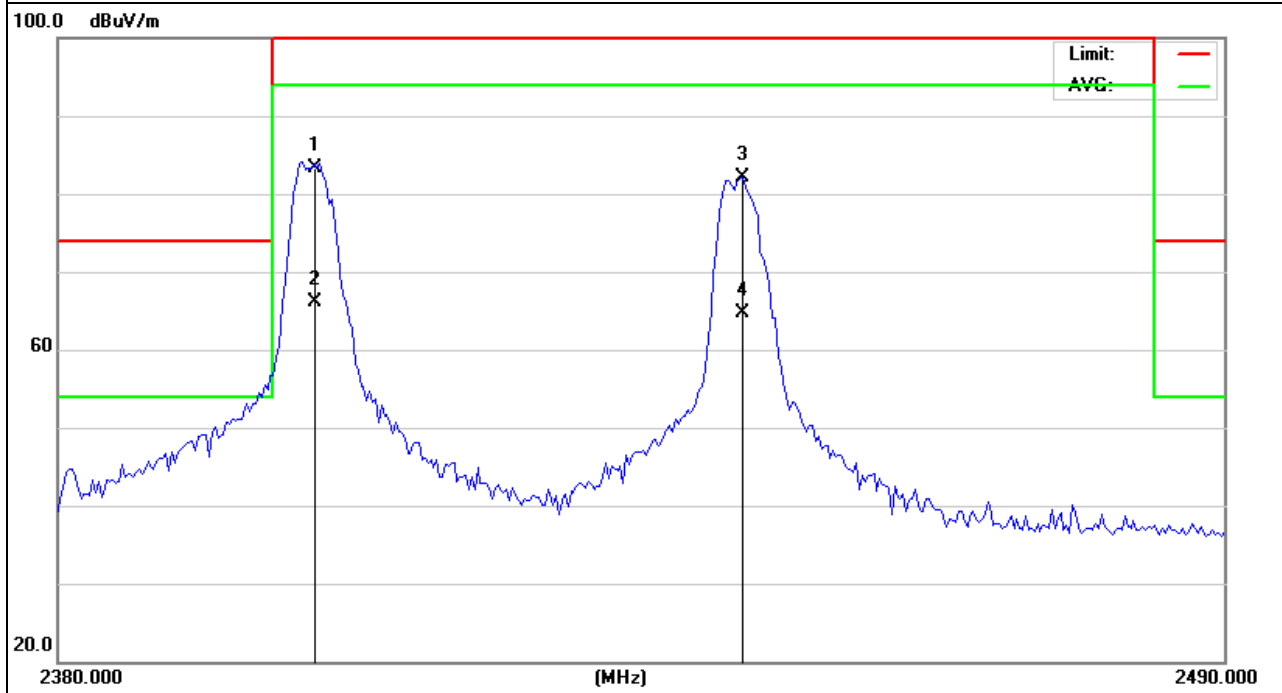

EUT :	Wireless microphone	Model Name :	GDX-2000M
Temperature :	25 °C	Relative Humidity :	51%
Pressure :	1010 hPa	Test Voltage :	DC 3V from battery
Test Mode :	Model 2	Polarization :	Horizontal

Frequency (MHz)	Meter Reading (dBμV)	Factor (dB)	Emission Level (dBμV/m)	Limits (dBμV/m)	Margin (dB)	Detector Type
4910.000	43.12	12.21	55.33	74.00	-18.67	peak
4910.000	28.15	12.21	40.36	54.00	-13.64	AVG
9840.000	5.04	51.70	56.74	74.00	-17.26	peak
9840.000	-11.13	51.70	40.57	54.00	-13.43	AVG

Remark:
 Factor = Antenna Factor + Cable Loss – Pre-amplifier.
 No emission above 18GHz.

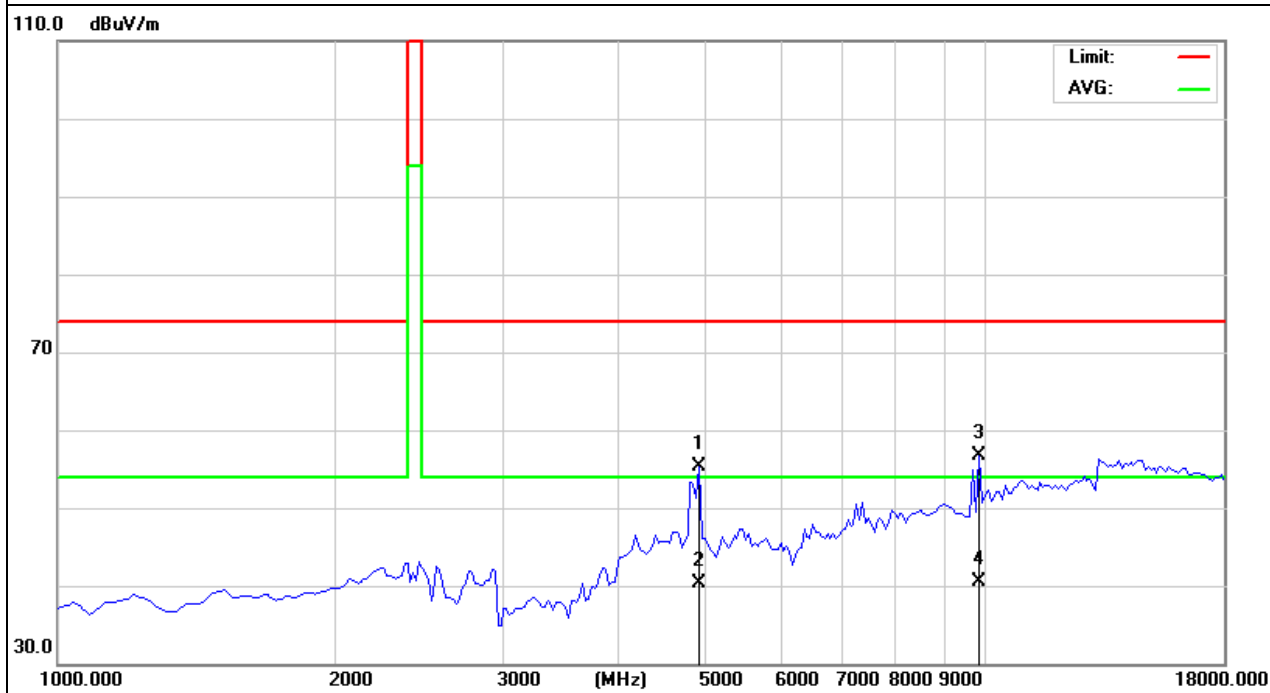

Frequency (MHz)	Meter Reading (dB μ V)	Factor (dB)	Emission Level (dB μ V/m)	Limits (dB μ V/m)	Margin (dB)	Detector Type
2420.000	86.68	1.60	88.28	114.00	-25.72	peak
2420.000	67.80	1.60	69.40	94.00	-24.60	AVG
2460.000	86.63	0.53	87.16	114.00	-26.84	peak
2460.000	67.40	0.53	67.93	94.00	-26.07	AVG

Remark:
 Factor = Antenna Factor + Cable Loss – Pre-amplifier.
 No emission above 18GHz.

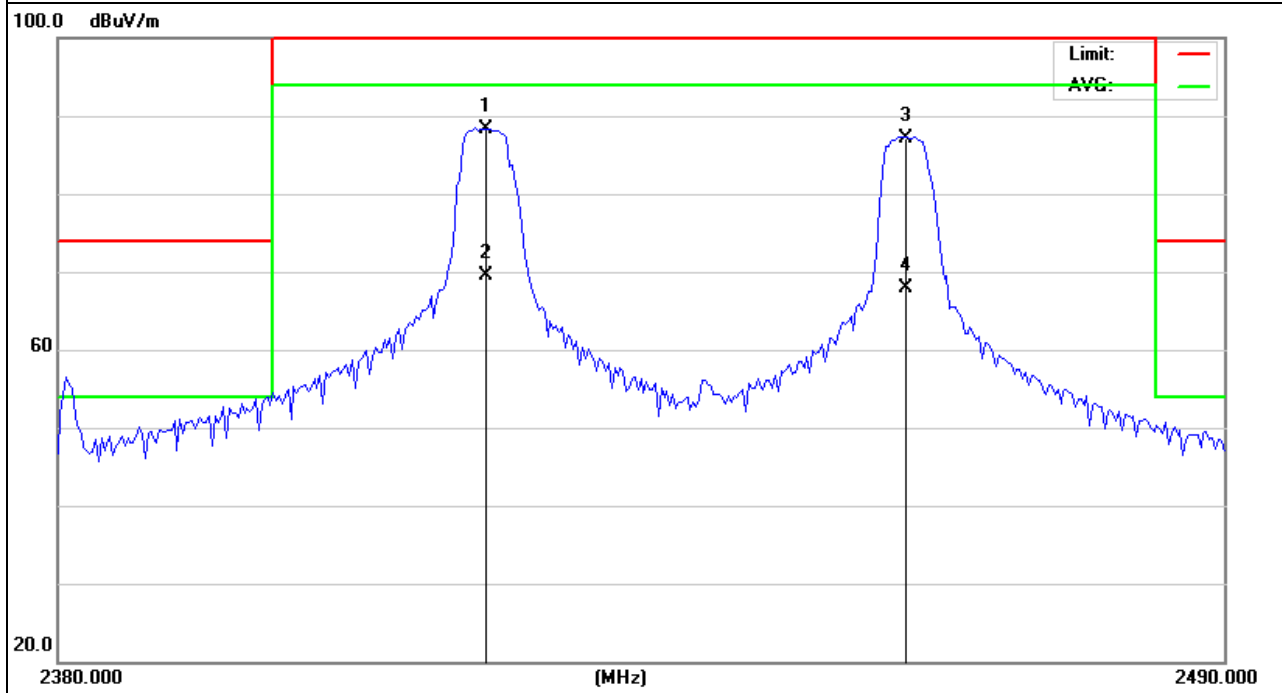

EUT :	Wireless microphone	Model Name :	GDX-2000M
Temperature :	25 °C	Relative Humidity :	51%
Pressure :	1010 hPa	Test Voltage :	DC 3V from battery
Test Mode :	Model 2	Polarization :	Vertical

Frequency (MHz)	Meter Reading (dB μ V)	Factor (dB)	Emission Level (dB μ V/m)	Limits (dB μ V/m)	Margin (dB)	Detector Type
4910.000	49.29	12.21	61.50	74.00	-12.50	peak
4910.000	36.36	12.21	48.57	54.00	-5.43	AVG
7247.500	11.75	49.06	60.81	74.00	-13.19	peak
7247.500	-9.61	49.06	39.45	54.00	-14.55	AVG
7375.000	9.16	49.28	58.44	74.00	-15.56	peak
7375.000	-9.40	49.28	39.88	54.00	-14.12	AVG
9840.000	3.98	51.70	55.68	74.00	-18.32	peak
9882.500	-10.29	51.84	41.55	54.00	-12.45	AVG

Remark:

Factor = Antenna Factor + Cable Loss – Pre-amplifier.

No emission above 18GHz.

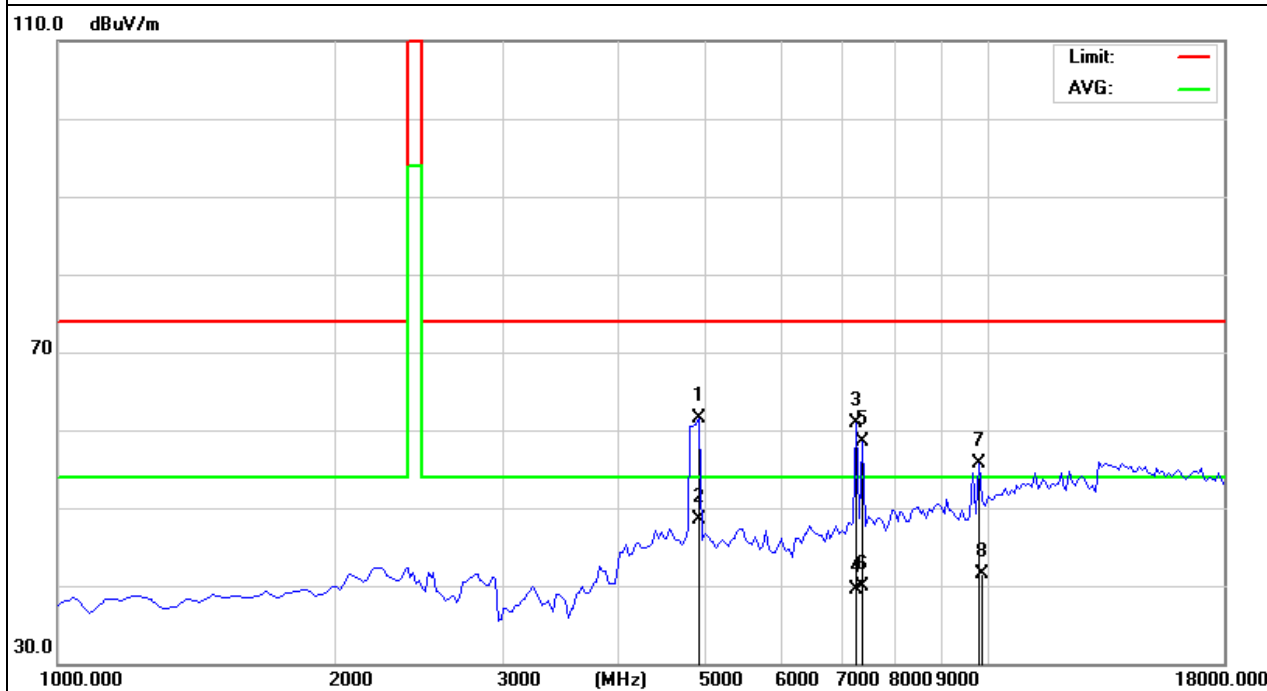

Frequency (MHz)	Meter Reading (dBμV)	Factor (dB)	Emission Level (dBμV/m)	Limits (dBμV/m)	Margin (dB)	Detector Type
2420.000	78.85	1.60	80.45	114.00	-33.55	peak
2420.000	63.70	1.60	65.30	94.00	-28.70	AVG
2460.000	79.49	0.53	80.02	114.00	-33.98	peak
2460.000	63.90	0.53	64.43	94.00	-29.57	AVG

Remark:
 Factor = Antenna Factor + Cable Loss – Pre-amplifier.
 No emission above 18GHz.

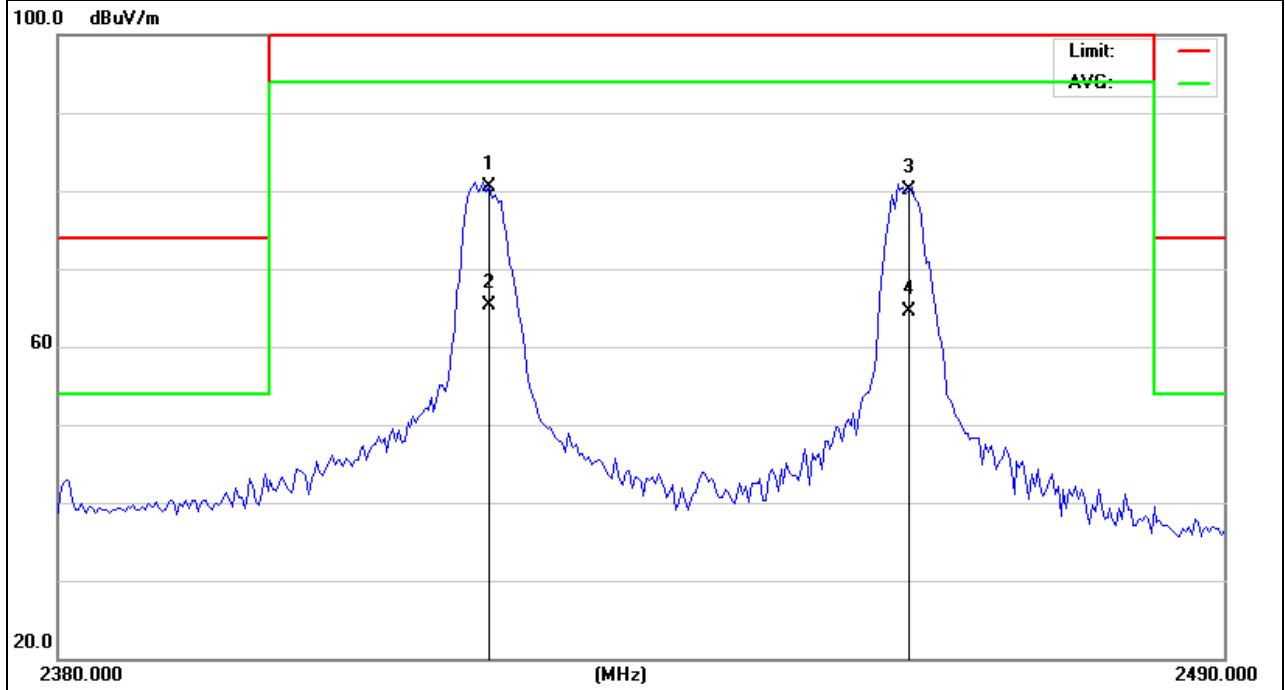

EUT :	Wireless microphone	Model Name :	GDX-2000M
Temperature :	20 °C	Relative Humidity :	48%
Pressure :	1010 hPa	Test Voltage :	DC 3V from battery
Test Mode :	Model 3	Polarization :	Horizontal

Frequency (MHz)	Meter Reading (dB μ V)	Factor (dB)	Emission Level (dB μ V/m)	Limits (dB μ V/m)	Margin (dB)	Detector Type
4867.500	41.28	12.13	53.41	74.00	-20.59	peak
4867.500	27.40	12.13	39.53	54.00	-14.47	AVG
4952.500	42.26	12.18	54.44	74.00	-19.56	peak
4952.500	26.60	12.18	38.78	54.00	-15.22	AVG
7290.000	2.47	49.13	51.60	74.00	-22.40	peak
7290.000	-10.50	49.13	38.63	54.00	-15.37	AVG
9882.500	4.53	51.84	56.37	74.00	-17.63	peak
9882.500	-13.25	51.84	38.59	54.00	-15.41	AVG

Remark:

Factor = Antenna Factor + Cable Loss – Pre-amplifier.

No emission above 18GHz.

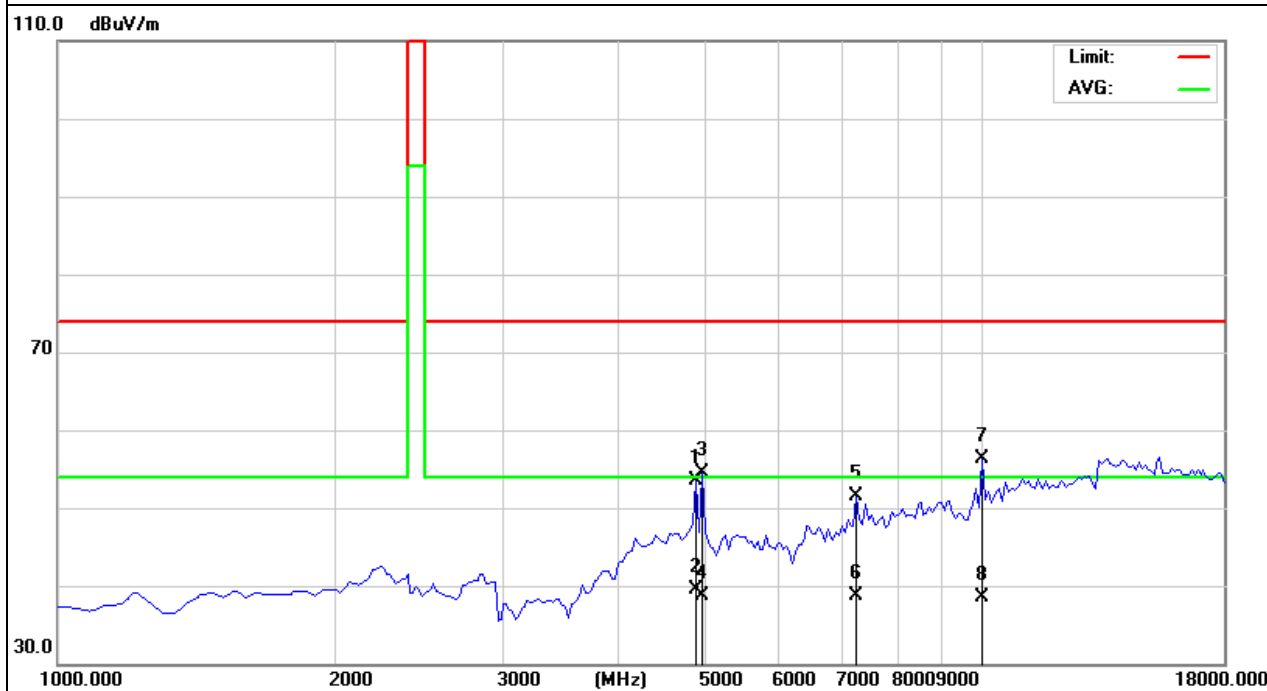

Frequency (MHz)	Meter Reading (dB μ V)	Factor (dB)	Emission Level (dB μ V/m)	Limits (dB μ V/m)	Margin (dB)	Detector Type
2434.000	85.65	1.27	86.92	114.00	-27.08	peak
2434.000	67.80	1.27	69.07	94.00	-24.93	AVG
2474.000	86.03	0.00	86.03	114.00	-27.97	peak
2474.000	66.50	0.00	66.50	94.00	-27.50	AVG

Remark:

Factor = Antenna Factor + Cable Loss – Pre-amplifier.

No emission above 18GHz.

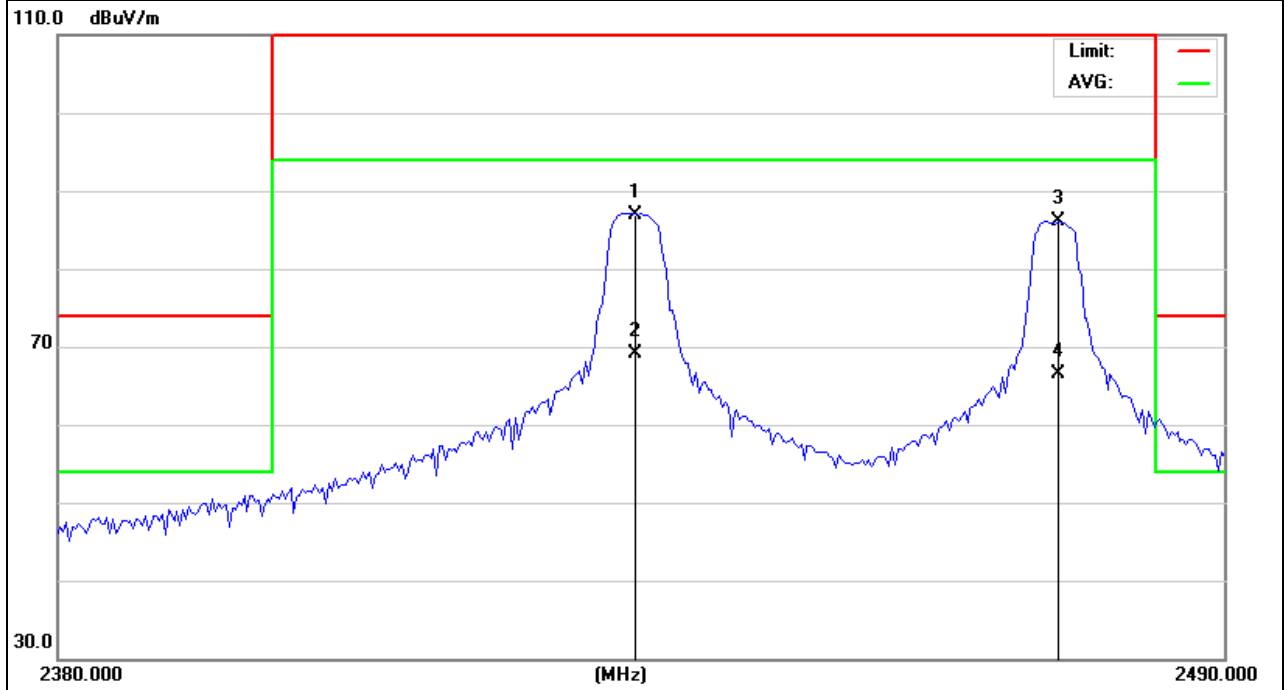

EUT :	Wireless microphone	Model Name :	GDX-2000M
Temperature :	25 °C	Relative Humidity :	51%
Pressure :	1010 hPa	Test Voltage :	DC 3V from battery
Test Mode :	Model 3	Polarization :	Vertical

Frequency (MHz)	Meter Reading (dB μ V)	Factor (dB)	Emission Level (dB μ V/m)	Limits (dB μ V/m)	Margin (dB)	Detector Type
4867.500	45.73	12.13	57.86	74.00	-16.14	peak
4867.500	28.55	12.13	40.68	54.00	-13.32	AVG
4952.500	44.49	12.18	56.67	74.00	-17.33	peak
4952.500	30.10	12.18	42.28	54.00	-11.72	AVG
7290.000	4.42	49.13	53.55	74.00	-20.45	peak
7290.000	-8.90	49.13	40.23	54.00	-13.77	AVG
9882.500	7.77	51.84	59.61	74.00	-14.39	peak
9882.500	-10.52	51.84	41.32	54.00	-12.68	AVG

Remark:

Factor = Antenna Factor + Cable Loss – Pre-amplifier.

No emission above 18GHz.

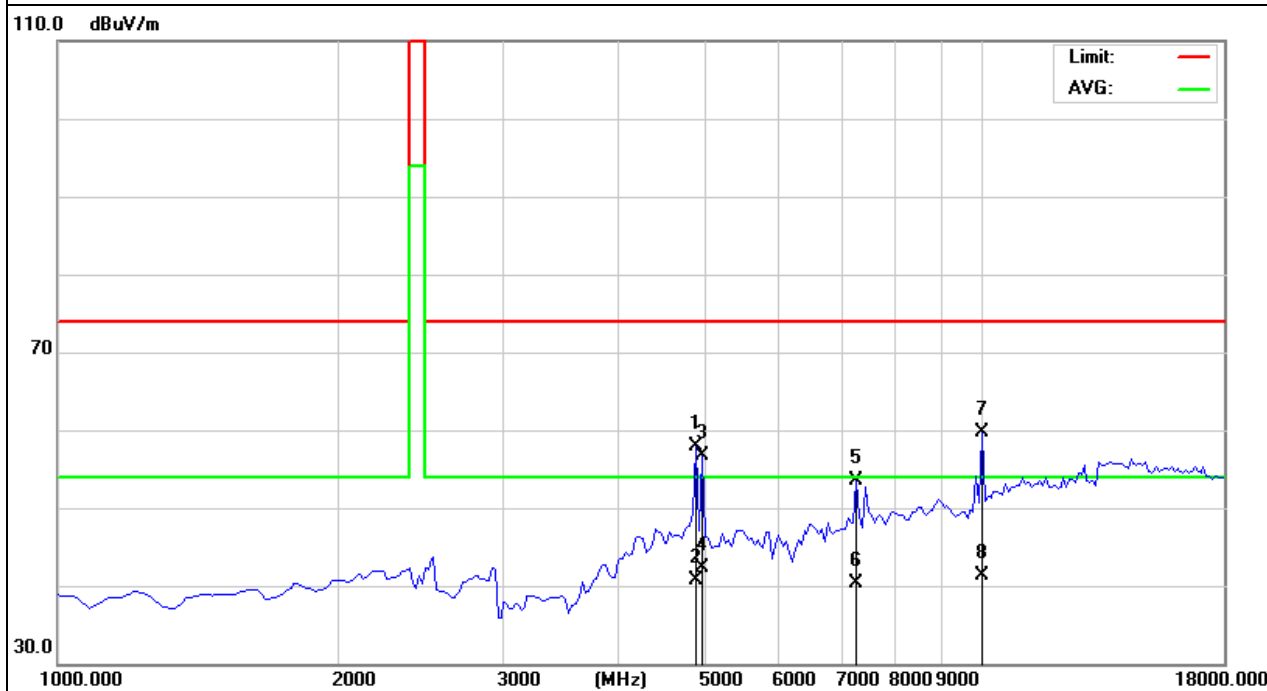

Frequency (MHz)	Meter Reading (dB μ V)	Factor (dB)	Emission Level (dB μ V/m)	Limits (dB μ V/m)	Margin (dB)	Detector Type
2434.000	79.97	1.27	81.24	114.00	-32.76	peak
2434.000	64.10	1.27	65.37	94.00	-28.63	AVG
2474.000	77.70	0.00	77.70	114.00	-36.30	peak
2474.000	62.80	0.00	62.80	94.00	-31.20	AVG

Remark:

Factor = Antenna Factor + Cable Loss – Pre-amplifier.

No emission above 18GHz.

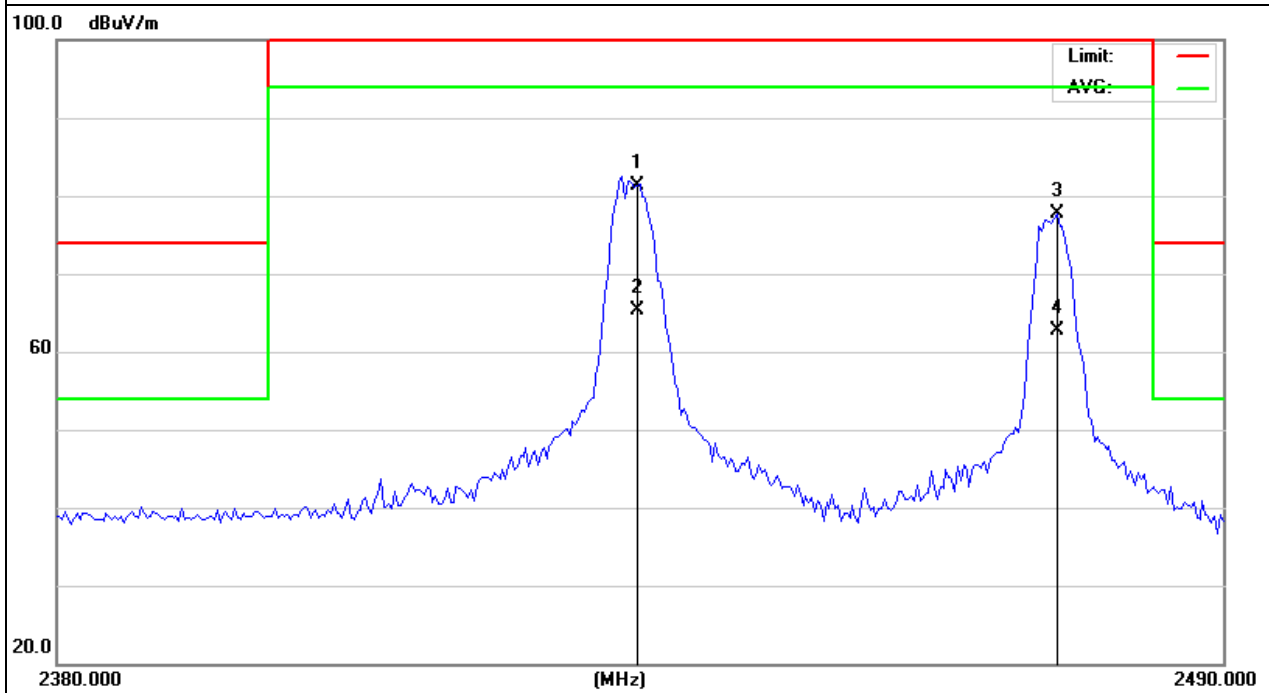

Note: EUT Pre-scan X/Y/Z orientation, only worst case is presented in the report(X orientation).

3.4.7 TEST RESULTS (RESTRICTED BANDS REQUIREMENTS)

EUT :	Wireless microphone	Model Name :	GDX-2000M
Temperature :	25 °C	Relative Humidity :	51%
Pressure :	1010 hPa	Test Voltage :	DC 3V from battery
Test Mode :	Mode 1	Polarization :	Horizontal

Frequency (MHz)	Meter Reading (dB μ V)	Factor (dB)	Emission Level (dB μ V/m)	Limits (dB μ V/m)	Margin (dB)	Detector Type
2381.800	51.05	1.89	52.94	74.00	-21.06	peak
2381.800	31.70	1.89	33.59	54.00	-20.41	AVG
2390.000	53.00	1.97	54.97	74.00	-19.03	peak
2390.000	33.90	1.97	35.87	54.00	-18.13	AVG

Remark:

Factor = Antenna Factor + Cable Loss – Pre-amplifier.

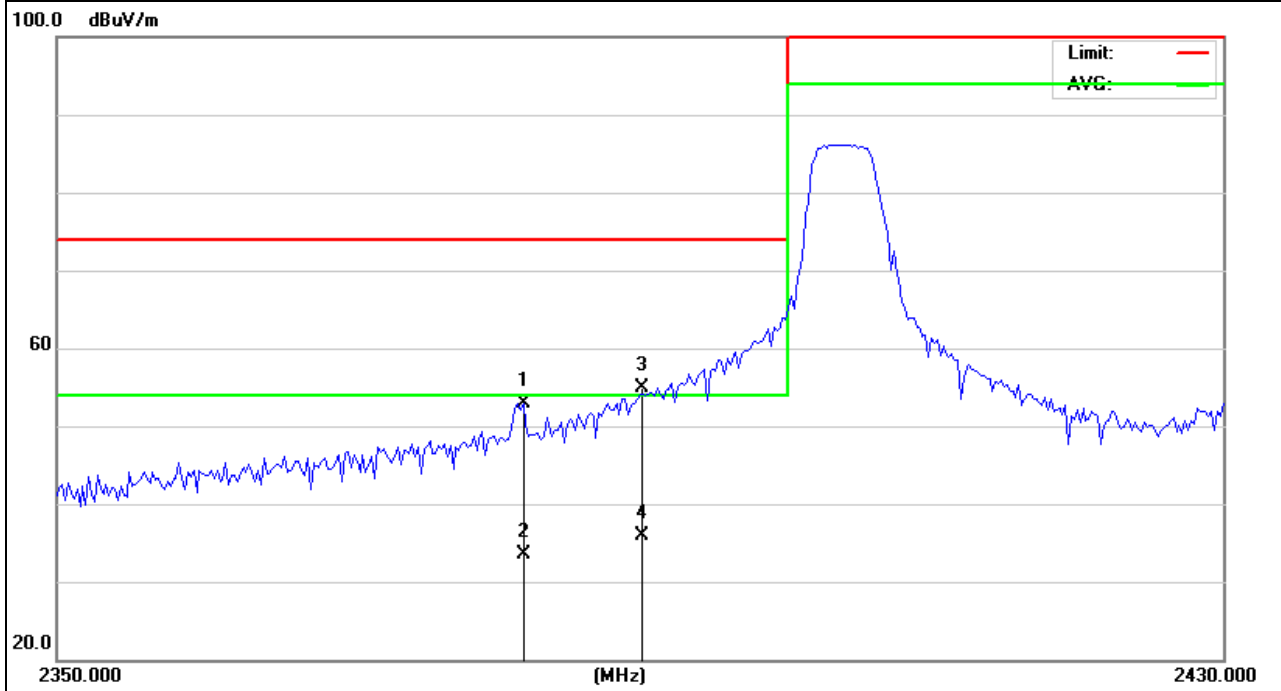

EUT :	Wireless microphone	Model Name :	GDX-2000M
Temperature :	25 °C	Relative Humidity :	51%
Pressure :	1010 hPa	Test Voltage :	DC 3V from battery
Test Mode :	Mode 1	Polarization :	Vertical

Frequency (MHz)	Meter Reading (dBμV)	Factor (dB)	Emission Level (dBμV/m)	Limits (dBμV/m)	Margin (dB)	Detector Type
2379.400	45.13	1.86	46.99	74.00	-27.01	peak
2379.400	30.10	1.86	31.96	54.00	-22.04	AVG
2390.000	44.24	1.97	46.21	74.00	-27.79	peak
2390.000	29.90	1.97	31.87	54.00	-22.13	AVG

Remark:
Factor = Antenna Factor + Cable Loss – Pre-amplifier.

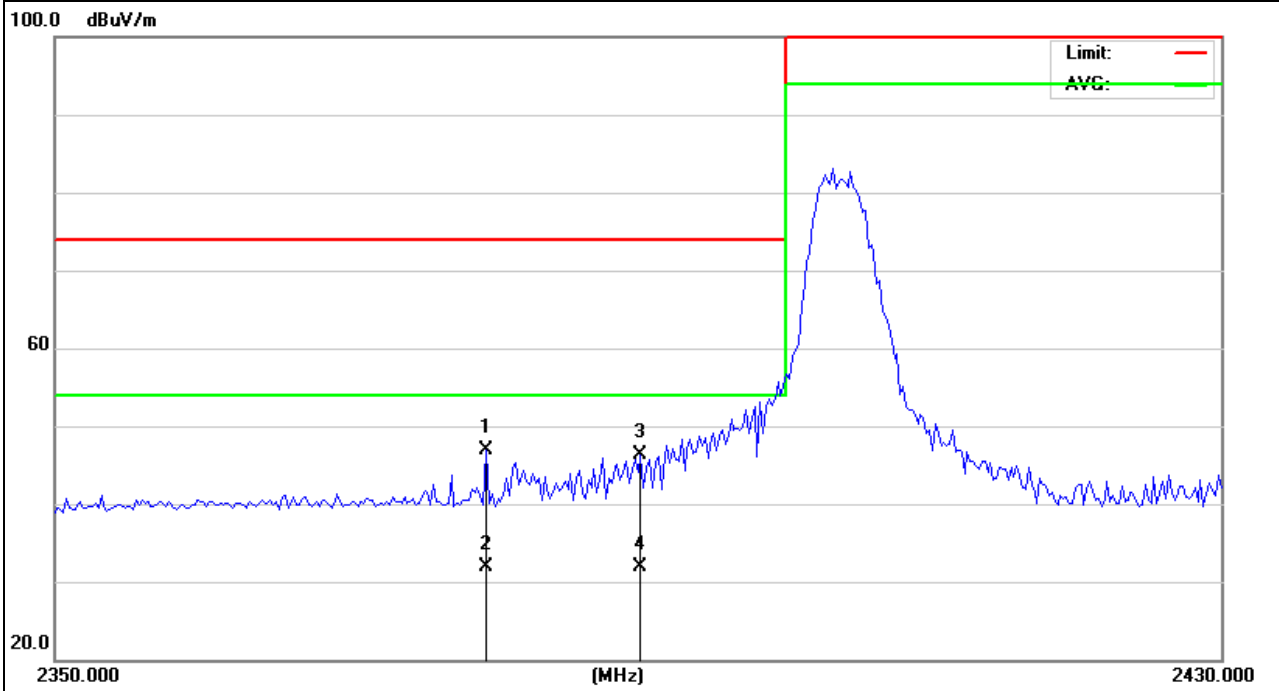

EUT :	Wireless microphone	Model Name :	GDX-2000M
Temperature :	25 °C	Relative Humidity :	51%
Pressure :	1010 hPa	Test Voltage :	DC 3V from battery
Test Mode :	Mode 3	Polarization :	Horizontal

Frequency (MHz)	Meter Reading (dB μ V)	Factor (dB)	Emission Level (dB μ V/m)	Limits (dB μ V/m)	Margin (dB)	Detector Type
2483.500	55.77	-0.34	55.43	74.00	-18.57	peak
2483.500	34.32	-0.34	33.98	54.00	-20.02	AVG
2500.000	52.47	-0.95	51.52	74.00	-22.48	peak
2500.000	32.10	-0.95	31.15	54.00	-22.85	AVG

Remark:
 Factor = Antenna Factor + Cable Loss – Pre-amplifier.

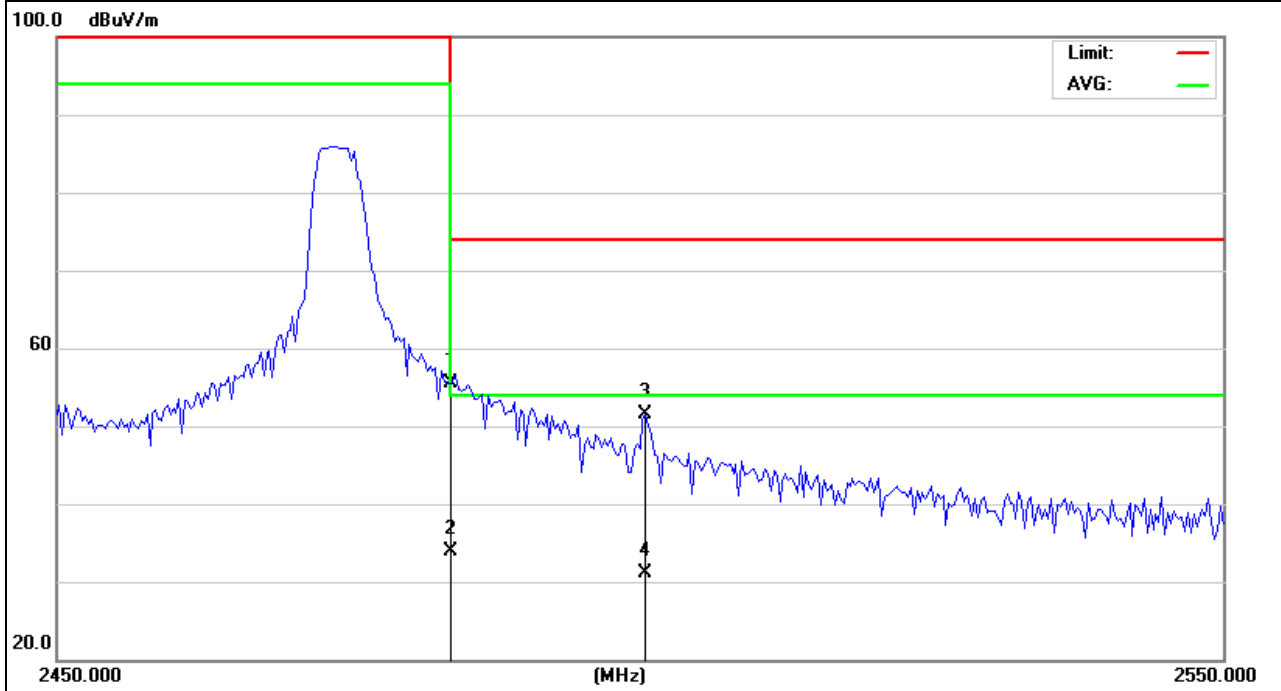

EUT :	Wireless microphone	Model Name :	GDX-2000M
Temperature :	25 °C	Relative Humidity :	51%
Pressure :	1010 hPa	Test Voltage :	DC 3V from battery
Test Mode :	Mode 3	Polarization :	Vertical

Frequency (MHz)	Meter Reading (dB μ V)	Factor (dB)	Emission Level (dB μ V/m)	Limits (dB μ V/m)	Margin (dB)	Detector Type
2483.500	44.57	-0.34	44.23	74.00	-29.77	peak
2483.500	32.50	-0.34	32.16	54.00	-21.84	AVG
2500.250	41.73	-0.96	40.77	74.00	-33.23	peak
2500.250	29.80	-0.96	28.84	54.00	-25.16	AVG

Remark:
Factor = Antenna Factor + Cable Loss – Pre-amplifier.

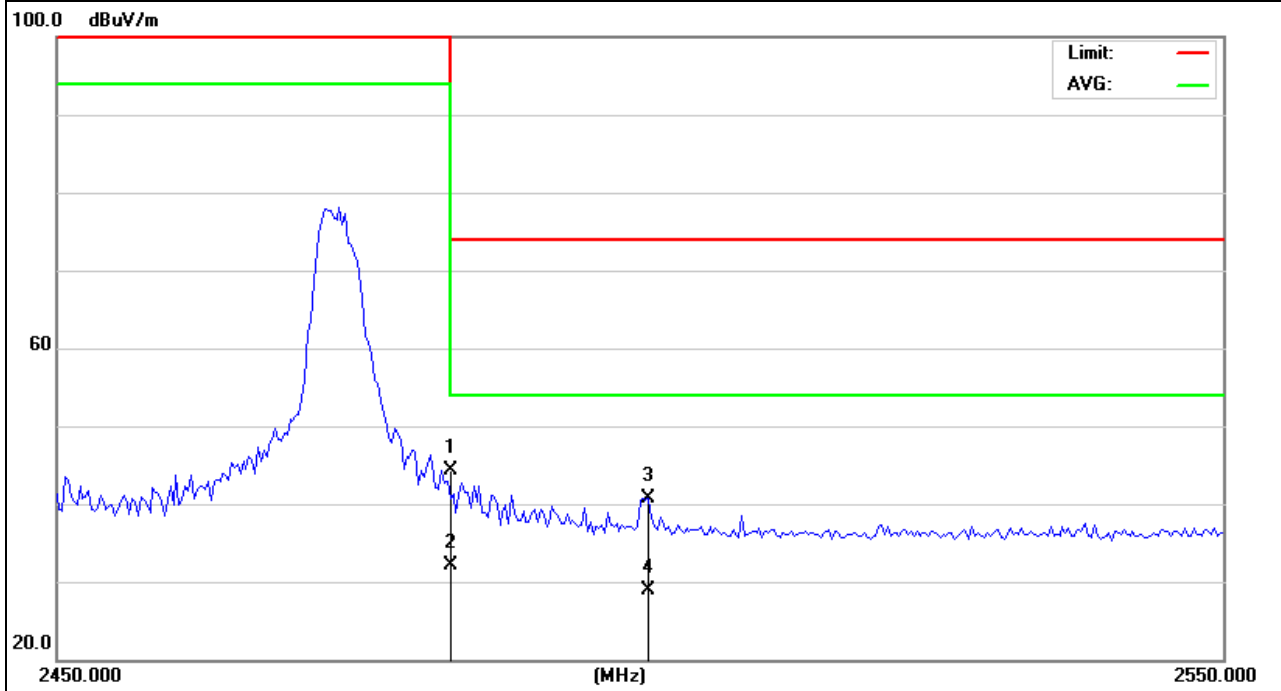

4. FREQUENCY TOLERANCE

4.1 FREQUENCY TOLERANCE LIMITS

The frequency tolerance of the carrier signal shall be maintained within $\pm 0.001\%$ of the operating frequency over a temperature variation of -20 degrees to $+50$ degrees C at normal supply voltage, and for a variation in the primary supply voltage from 85% to 115% of the rated supply voltage at a temperature of 20 degrees C.

4.2 TEST PROCEDURE

- a. The EUT was directly connected to the spectrum analyzer and antenna output port as show in the block diagram below,
- b. Spectrum Setting : RBW= 10KHz, VBW \geq RBW, Sweep time = Auto.

4.3 TEST SETUP

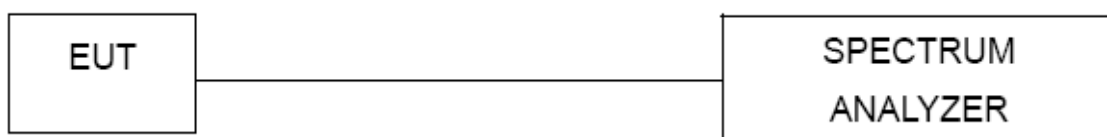

4.4 TEST RESULTS

EUT :	Wireless microphone	Model Name :	GDX-2000M
Temperature :	26 °C	Relative Humidity :	53%
Pressure :	1020 hPa	Test Power :	DC 3V from battery
Test Mode :	Model 1/2/3		

2404MHz

Voltage (V)	Frequency(MHz)	Reading(MHz)	Frequency Tolerance(ppm)	LIMIT(ppm)
2.55	2404	2404.0087	3.6190	± 10
3	2404	2404.0102	4.2429	± 10
3.45	2404	2404.0098	4.0765	± 10

Temperature (°C)	Frequency(MHz)	Reading(MHz)	Frequency Tolerance(ppm)	LIMIT(ppm)
-20	2404	2404.0116	4.8253	± 10
-10	2404	2404.0105	4.3677	± 10
0	2404	2404.0086	3.5774	± 10
10	2404	2404.0097	4.0349	± 10
20	2404	2404.0011	0.4409	± 10
30	2404	2404.0152	6.3228	± 10
40	2404	2404.0123	5.1165	± 10
50	2404	2404.0147	6.1148	± 10

2444MHz

Voltage (V)	Frequency(MHz)	Reading(MHz)	Frequency Tolerance(ppm)	LIMIT(ppm)
2.55	2444	2444.0112	4.5827	±10
3	2444	2444.0129	5.2782	±10
3.45	2444	2444.0095	3.8871	±10

Temperature (°C)	Frequency(MHz)	Reading(MHz)	Frequency Tolerance(ppm)	LIMIT(ppm)
-20	2444	2444.0089	3.6416	±10
-10	2444	2444.0093	3.8052	±10
0	2444	2444.0097	3.9689	±10
10	2444	2444.0104	4.2553	±10
20	2444	2444.0154	6.3011	±10
30	2444	2444.0117	4.7872	±10
40	2444	2444.0108	4.4190	±10
50	2444	2444.0132	5.4010	±10

2420MHz

Voltage (V)	Frequency(MHz)	Reading(MHz)	Frequency Tolerance(ppm)	LIMIT(ppm)
2.55	2420	2420.0165	6.8182	±10
3	2420	2420.0112	4.6281	±10
3.45	2420	2420.0098	4.0496	±10

Temperature (°C)	Frequency(MHz)	Reading(MHz)	Frequency Tolerance(ppm)	LIMIT(ppm)
-20	2420	2420.0132	5.4545	±10
-10	2420	2420.0111	4.5868	±10
0	2420	2420.0157	6.4876	±10
10	2420	2420.0136	5.6198	±10
20	2420	2420.0228	9.4215	±10
30	2420	2420.0197	8.1405	±10
40	2420	2420.0164	6.7769	±10
50	2420	2420.0137	5.6612	±10

2460MHz

Voltage (V)	Frequency(MHz)	Reading(MHz)	Frequency Tolerance(ppm)	LIMIT(ppm)
2.55	2460	2460.0069	2.8049	±10
3	2460	2460.0074	3.0081	±10
3.45	2460	2460.0085	3.4553	±10

Temperature (°C)	Frequency(MHz)	Reading(MHz)	Frequency Tolerance(ppm)	LIMIT(ppm)
-20	2460	2460.0092	3.7398	±10
-10	2460	2460.0090	3.6585	±10
0	2460	2460.0136	5.5285	±10
10	2460	2460.0103	4.1870	±10
20	2460	2460.0082	3.3333	±10
30	2460	2460.0079	3.2114	±10
40	2460	2460.0105	4.2683	±10
50	2460	2460.0135	5.4878	±10

2434MHz

Voltage (V)	Frequency(MHz)	Reading(MHz)	Frequency Tolerance(ppm)	LIMIT(ppm)
2.55	2434	2434.0096	3.9441	±10
3	2434	2434.0067	2.7527	±10
3.45	2434	2434.0078	3.2046	±10

Temperature (°C)	Frequency(MHz)	Reading(MHz)	Frequency Tolerance(ppm)	LIMIT(ppm)
-20	2434	2434.0098	4.0263	±10
-10	2434	2434.0085	3.4922	±10
0	2434	2434.0115	4.7247	±10
10	2434	2434.0104	4.2728	±10
20	2434	2434.0079	3.2457	±10
30	2434	2434.0103	4.2317	±10
40	2434	2434.0116	4.7658	±10
50	2434	2434.0107	4.3961	±10

2474MHz

Voltage (V)	Frequency(MHz)	Reading(MHz)	Frequency Tolerance(ppm)	LIMIT(ppm)
2.55	2474	2474.0085	3.4357	±10
3	2474	2474.0121	4.8909	±10
3.45	2474	2474.0198	8.0032	±10

Temperature (°C)	Frequency(MHz)	Reading(MHz)	Frequency Tolerance(ppm)	LIMIT(ppm)
-20	2474	2474.0158	6.3864	±10
-10	2474	2474.0142	5.7397	±10
0	2474	2474.0104	4.2037	±10
10	2474	2474.0145	5.8610	±10
20	2474	2474.0163	6.5885	±10
30	2474	2474.0142	5.7397	±10
40	2474	2474.0128	5.1738	±10
50	2474	2474.0109	4.4058	±10

5. BANDWIDTH TEST

5.1 TEST PROCEDURE

- a. The EUT was directly connected to the spectrum analyzer and antenna output port as show in the block diagram below,
- b. Spectrum Setting : RBW= 100KHz, VBW \geq RBW, Sweep time = Auto.

5.1 DEVIATION FROM STANDARD

No deviation.

5.1 TEST SETUP



6. TEST RESULTS

EUT :	Wireless microphone	Model Name :	GDX-2000M
Temperature :	26 °C	Relative Humidity :	53%
Pressure :	1020 hPa	Test Power :	DC 3V from battery
Test Mode :	Model 1/2/3		

Test Channel	Frequency (MHz)	20 dBc Bandwidth (MHz)
CH16	2404	2.827
	2444	2.843
CH08	2420	2.956
	2460	2.725
CH15	2434	2.855
	2474	2.596

2404 MHz

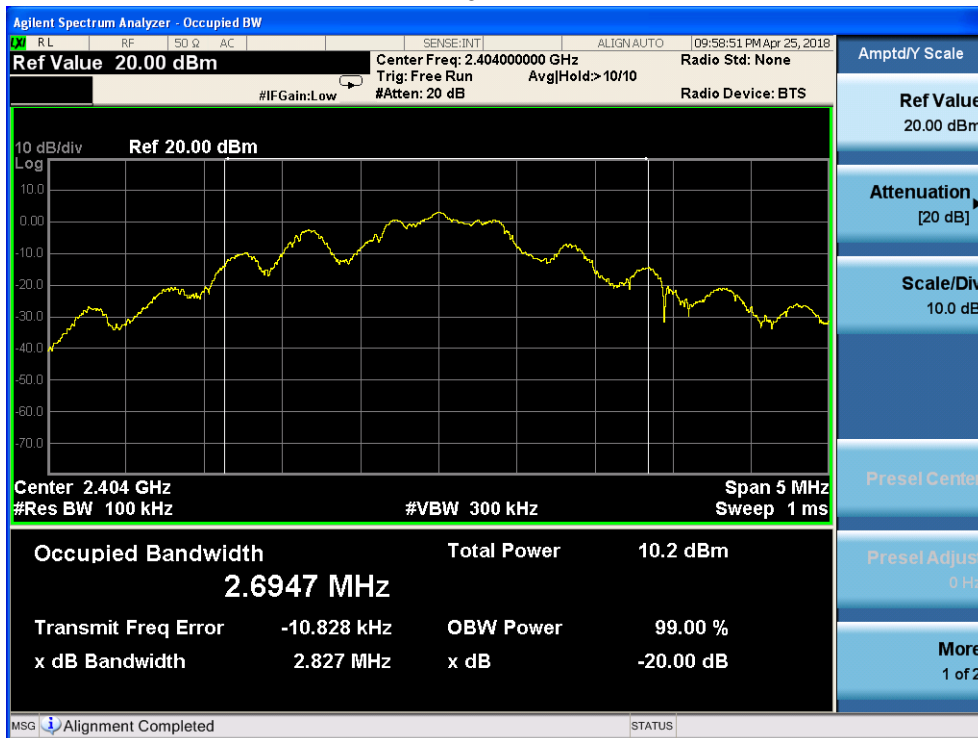

2444 MHz

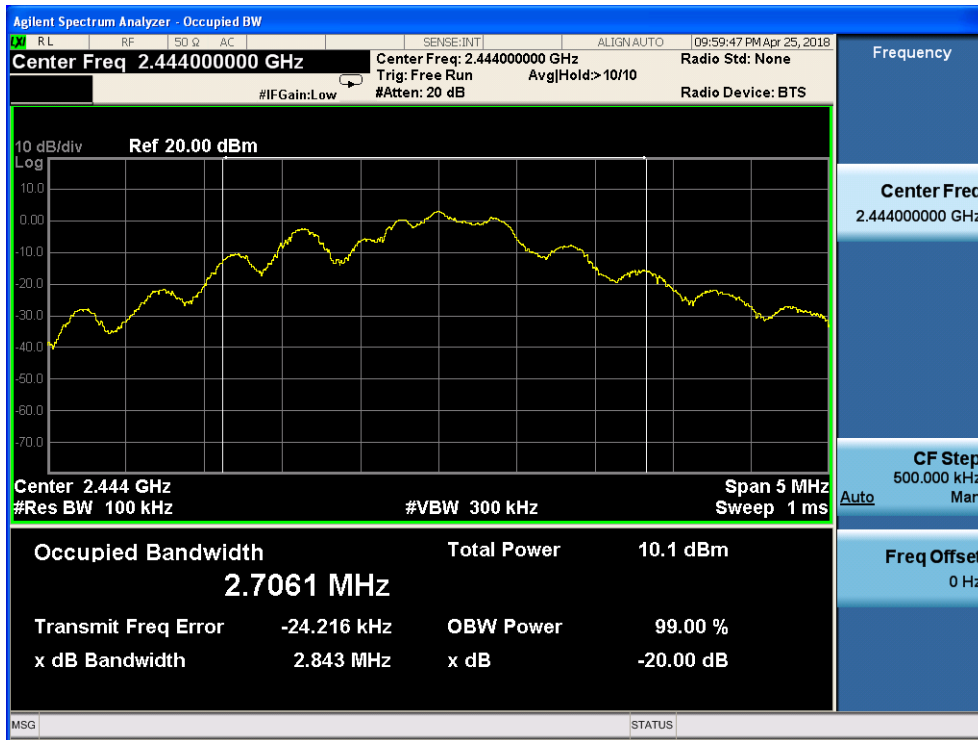

2420 MHz

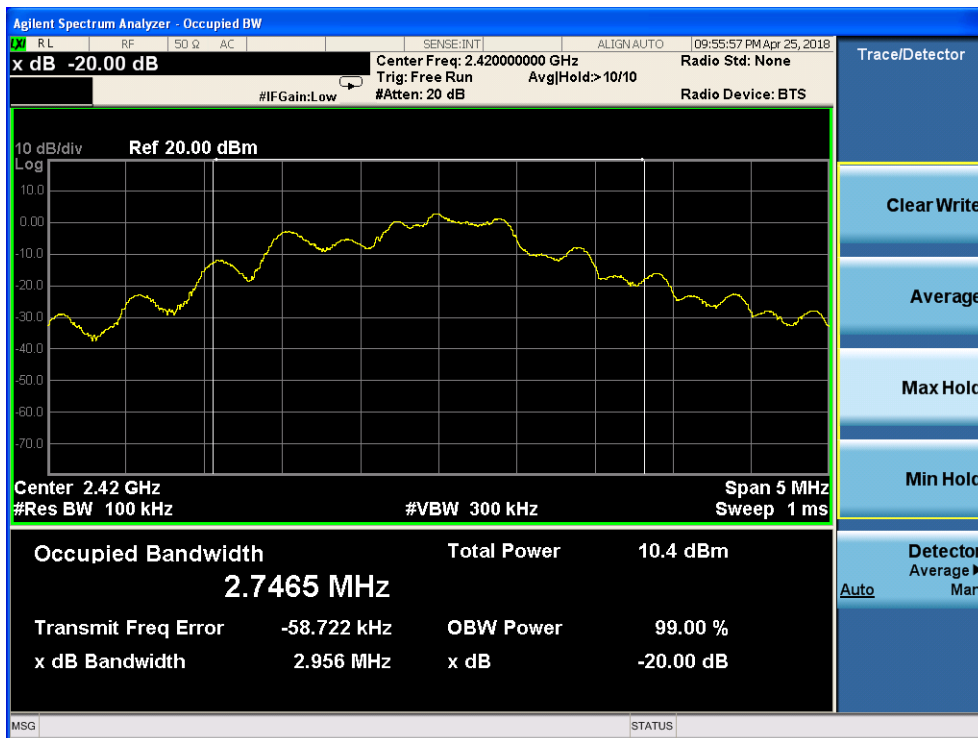

2460 MHz

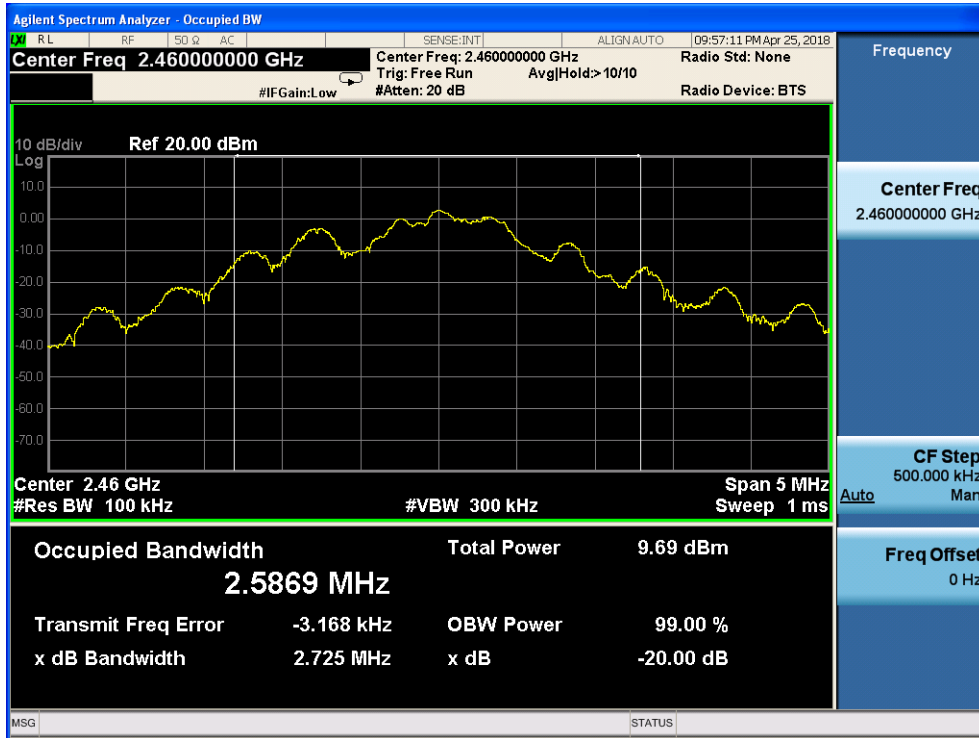

2434 MHz

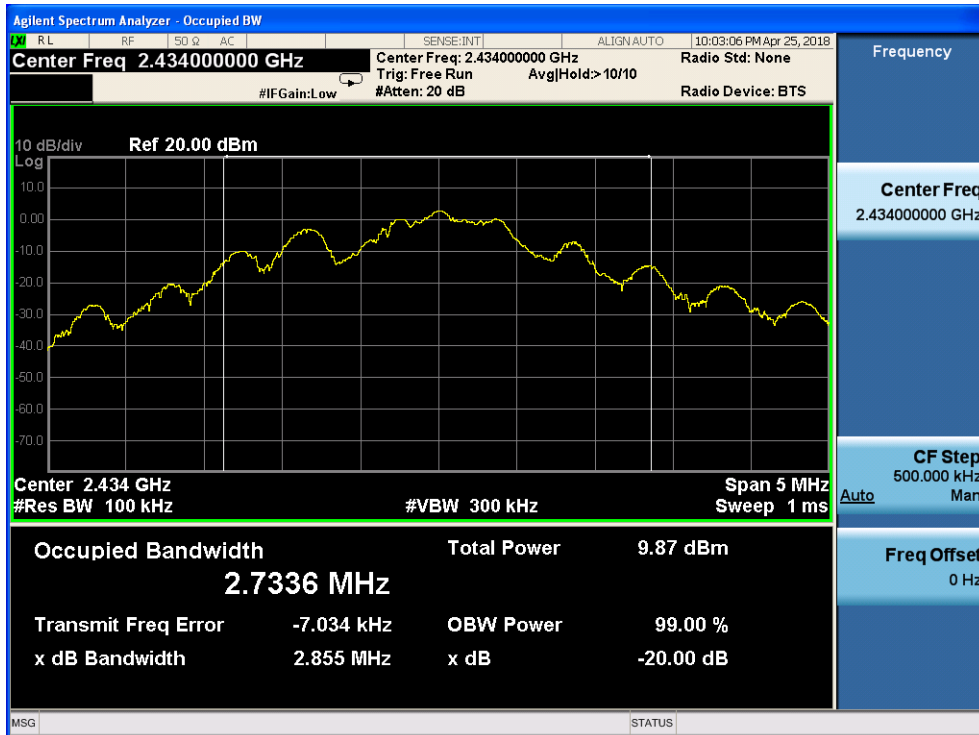

2474 MHz

