

成品尺寸：105x150mm
材质：105G双铜，4色印刷，
骑马钉 共20P

gemini[®]



Gemini BeatGrip

Magnetic Bluetooth Party Speaker

©2024 Innovative Concepts & Design LLC. All Right Reserved.
Bluetooth[®] is a registered trademark of Bluetooth SIG Inc.
Product Specifications and colors may vary from photo.

Manufactured and serviced by:
Innovative Concepts & Design LLC
458 Florida Grove Road
Perth Amboy, NJ 08861 USA
(732)587-5466

geminisound.com

INDEX

What's Included	2
Precautions	3
Features	4
Product Overview	5
Operations	7
Specifications	10
FCC Compliance Statement	11
Legality & Safety	12
Warranty Info	13
Manual en Español	14

What's Included

Please ensure that you find these accessories with your BeatGrip package

- Gemini BeatGrip
- USB-C Charging Cable
 - User Manual

PRECAUTIONS





PLEASE READ THESE INSTRUCTIONS GIVEN IN THIS MANUAL AND THOSE MARKED ON THE UNIT



This set has been designed and manufactured to assure personal safety. Improper use can result in electric shock or fire hazard. The safeguards incorporated in this unit will protect you if you observe the following procedures for installation, use and servicing. This unit is fully transistorized and does not contain any parts that can be repaired by the user.

WARNINGS

Fire and electric shock hazard

- 1 - Do not place any open flame sources, such as lighted candles, on or near the apparatus.
- 2 - Do not attempt to service the apparatus yourself.
- 3 - Opening or removing covers may expose you to dangerous voltages or other hazards and will void the manufacturer's warranty.
- 4 - To prevent risk of fire or electric shock, avoid overloading wall outlets, extension cords, or integral convenience receptacles.
- 5 - Lightning storms Unplug this apparatus during lightning storms.
- 6 - Object and liquid entry: Never insert objects of any kind through the openings of this apparatus, as it may touch dangerous voltage points or short-circuit parts that could result in a fire or electric shock. Care should be taken so that objects do not fall and liquids are not spilled into the apparatus through openings in the enclosure.

	CAUTION	
	RISK OF ELECTRIC SHOCK, DO NOT OPEN	
Caution: To reduce the risk of electric shock do not open this device, there are no serviceable parts for customers. Please refer any maintenance or repair to qualified personnel.		
	This sign means the existence of dangerous voltage inside the unit, which states a risk of electric shock.	
	This sign means that there are important instructions of operation and handling in the manual that comes with this device.	

	WARNING	
<p>THIS PRODUCT MAY CONTAIN MINISCULE AMOUNTS OF CHEMICALS INCLUDING DEHP. WHICH ARE KNOWN TO THE STATE OF CALIFORNIA TO CAUSE CANCER AND BIRTH DEFECTS OR OTHER REPRODUCTIVE HARM WWW.P65WARNINGS.CA.GOV</p>		

NOTE: This unit may be submitted for changes in specifications, characteristics and/or operation without prior notice to user, in order to continue improving and developing its technology.

FEATURES

Meet the Gemini BeatGrip Magnetic Bluetooth Speaker – a perfect blend of portability and performance. Crafted for modern lifestyles, this handheld speaker boasts a magnetic base for effortless attachment to any metal surface, offering you the freedom to enjoy music anywhere you go, rain or shine. With IPX6 weather-resistant design, it ensures durability even in wet conditions. Immerse yourself in high-quality audio, whether you're grooving to your favorite tunes or taking calls via the built-in speakerphone. The BeatGrip's 2600mAh battery ensures uninterrupted music with playtime up to 12 hours, making it your ideal companion for outdoor adventures or cozy indoor moments. Additionally, its vibrant LED party light sets the mood for any occasion. Elevate your audio experience with the Gemini BeatGrip Magnetic Bluetooth Speaker – where style meets functionality.

MAGNETIC DESIGN WITH LED LIGHT

Effortlessly attach to metallic surfaces for hands-free listening. The built-in LED light adds ambiance to your music experience.

WIRELESS CONNECTIVITY

Seamlessly connect with your devices via Bluetooth for up to 12 hours of continuous playback. Answer calls with the built-in microphone.

PREMIUM AUDIO PERFORMANCE

Enjoy crystal-clear sound quality with the BeatGrip's powerful speakers, perfect for music, podcasts, and calls.

WEATHER-RESISTANT

Designed to withstand outdoor elements, making it ideal for various activities and environments.







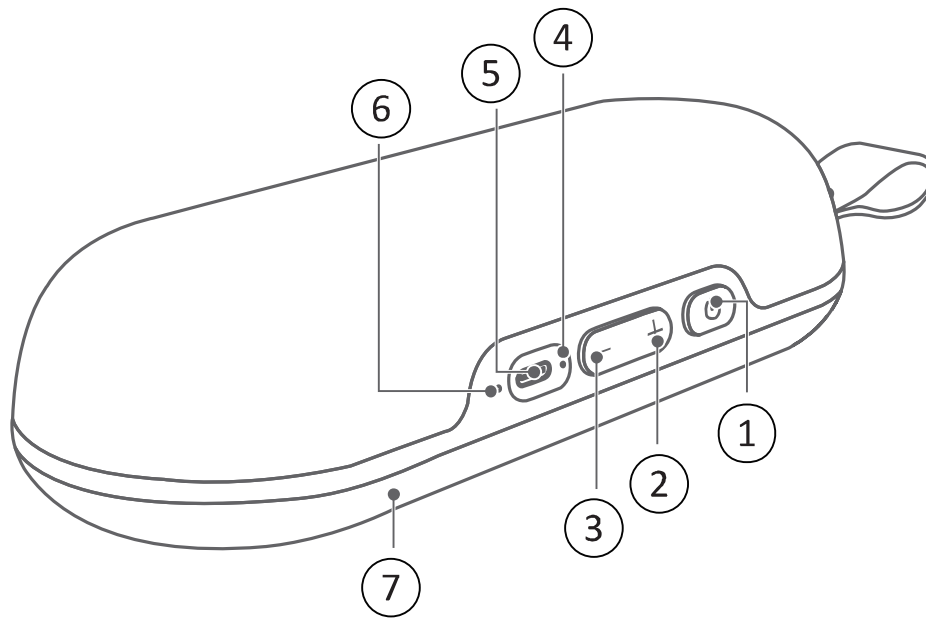

PORTABLE AND VERSATILE

Compact and lightweight design, perfect for on-the-go use. Features TWS Wireless Pairing between two units for an enhanced sound experience.

PRODUCT OVERVIEW



PRODUCT OVERVIEW

1		<p>Long press 2s: Power on/off</p> <p>Short press one time: Play/Pause; Pick up/Hang up call</p> <p>Short press twice: Switch LED lighting mode</p> <p>Short press 3 times: Protect call privacy; Reject incoming call; TWS connect/disconnect</p>
2		<p>Short press one time: Increase volume</p> <p>Long press 2s: Next song</p>
3		<p>Short press one time: Decrease Volume</p> <p>Long press 2s: Previous song</p>
2/3		<p>Short press at same time: Bluetooth disconnection</p> <p>Long press 2s at the same time: Turn on/off SOS light</p>
4		<p>LED Status indicator:</p> <p>Power on/ TWS = Blue LED on</p> <p>Bluetooth Search = Flashing Blue LED</p> <p>Low battery = Flashing Red LED</p> <p>Charging = Red LED on</p> <p>Fully charged = LED off</p>
5		USB Type-C Charging port
6		Telephone Microphone
7		<p>LED Party Light</p> <p>5 Modes</p>



OPERATIONS

1. Power On/Off

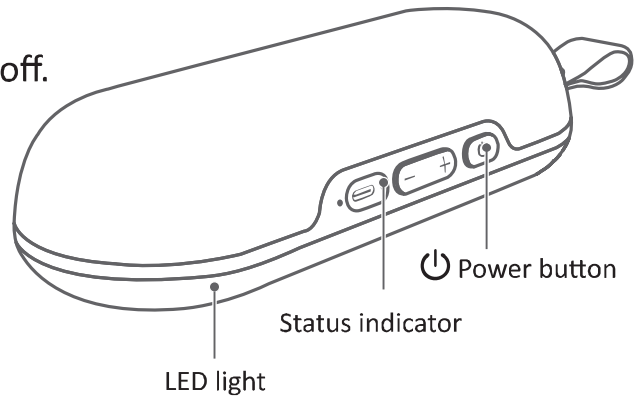
- Long press  button (1) 2s to power on/off.



2. Bluetooth Mode

- Long press  button (1) 2s to power on with tone, speaker will enter into bluetooth pairing mode,  indicator (4) will flash blue.
- Choose “Gemini BeatGrip” in your bluetooth list, there will be tone once connected successfully, and  indicator (4) will become solid blue. Now, you can play music.

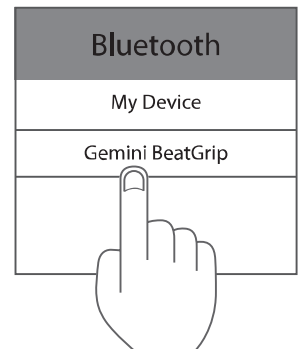

3. TWS Connection

- After power on but before connected with any device, short press  button (1) 3 times on either speaker to turn on TWS function, you will hear prompt tone and the blue indicator will flash.
- There will be beep once paired successfully, then the blue indicator of linked speaker will be solid on and the blue indicator of master speaker will flash, now you can connect speaker with Bluetooth device for stereo playback from both speakers.

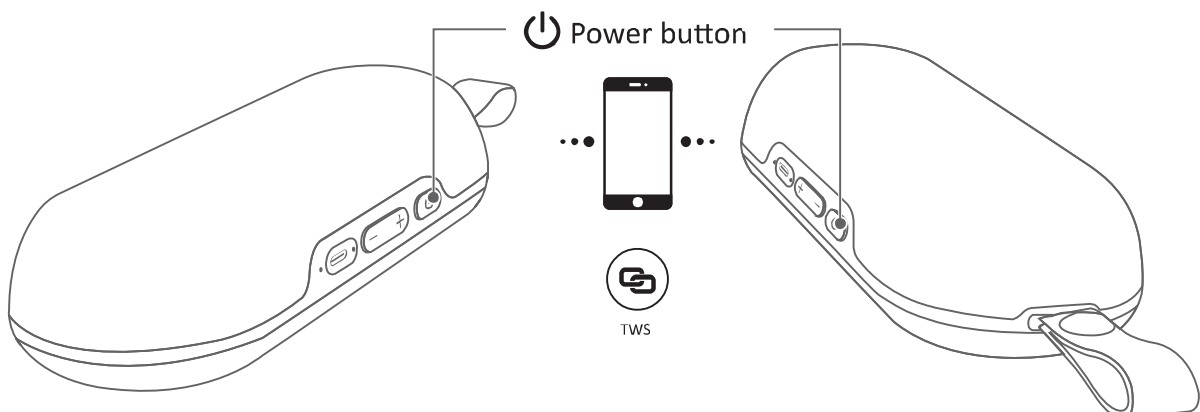

4. Volume Control

- Short press + button (2) one time for volume up, there will be beep when maximum volume is reached.
- Long press + button (2) 2s for next song.
- Short press — button (3) one time for volume down.
- Long press — button (3) 2s for previous song.

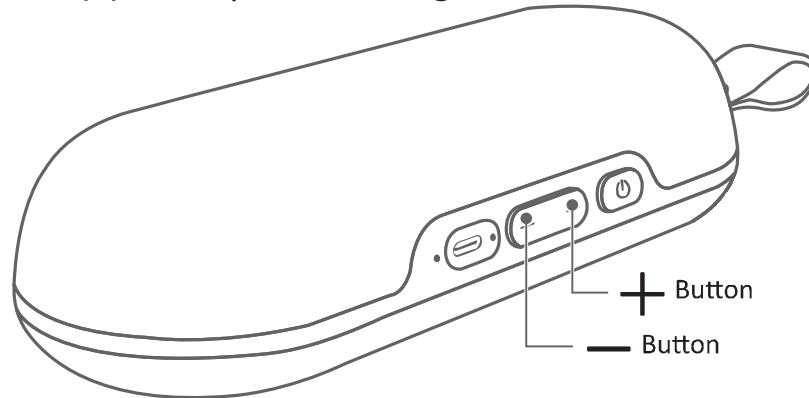

5. LED Lighting Mode

- After power on, double click ⏻ button (1) to switch LED lighting mode (Mode 1 / Mode 2 / Mode 3 / Mode 4 / Mode 5 / Off)
- Long press both + — buttons (2/3) at the same time for 3 seconds to turn on/off Lighting.

6. Calling

- When a call is incoming, short press ⏻ button (1) to answer.
- Short press ⏻ button (1) 3 times to hang up.
- During a call/conversation, short press ⏻ button (1) to hang up.
- Short press ⏻ button (1) 3 times to protect call privacy (move call to phone).

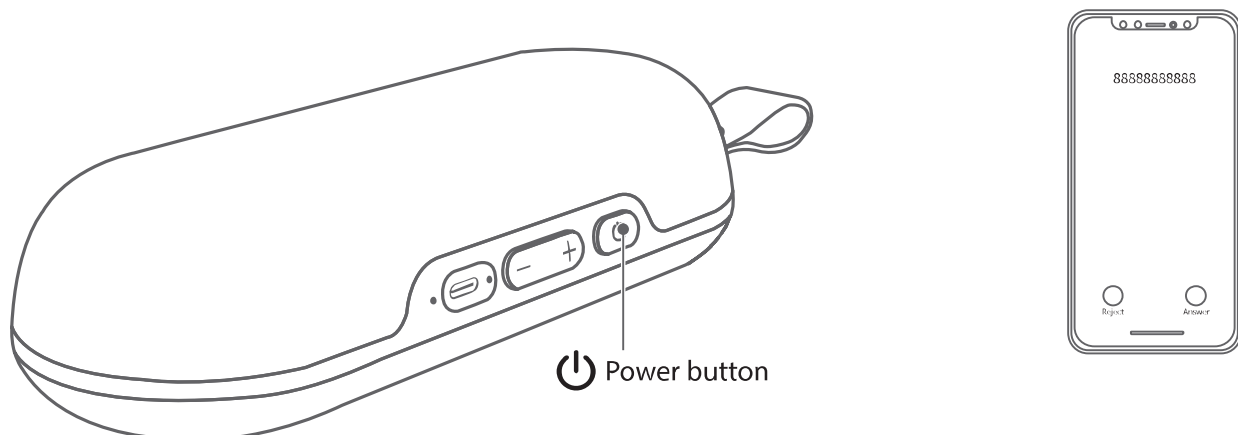

7. Power Saving

- Speaker will power off automatically to save battery when nothing is connected after 10 minutes.

8. Charging

Important note:

- Use supplied USB-C charging cable
- Use an output source 5V/2A (or above)
- Charge when you hear low battery prompt tone or the indicator flash red. The red indicator will be normally on while charging and switch off after fully charged.

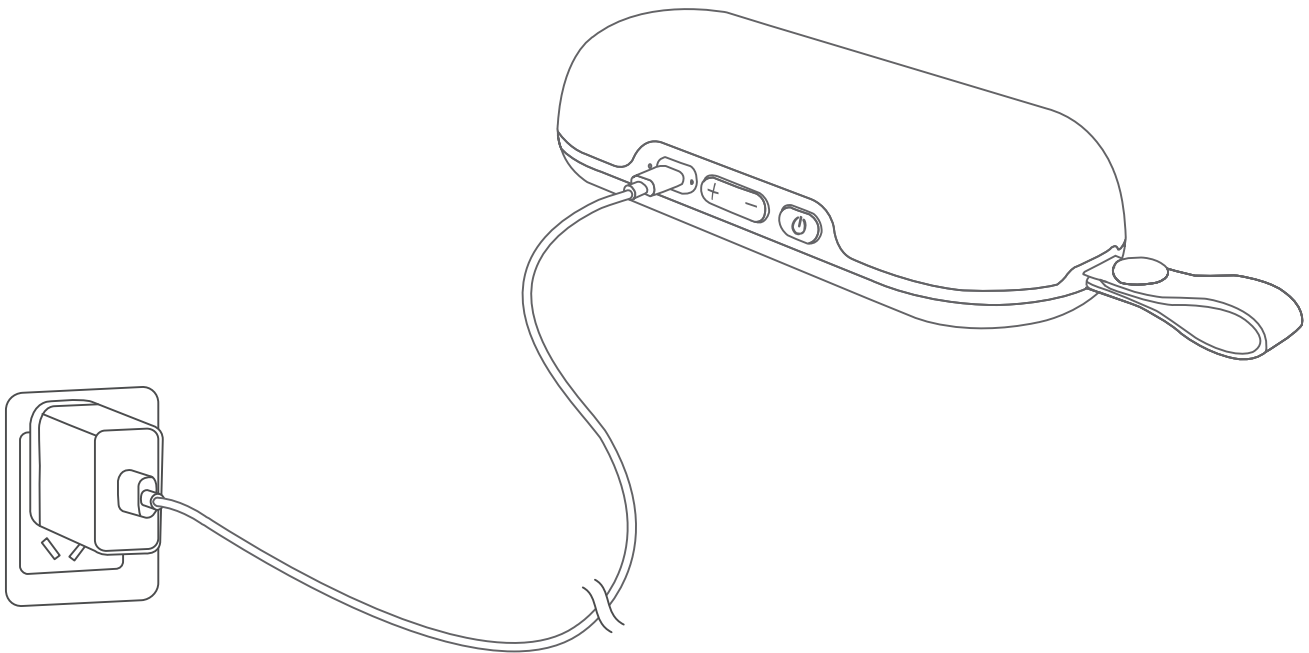

SPECIFICATIONS

Active/Passive	Active
Amplifier Type	Class D
Driver Size	2 x 2"
Total Power	30W Peak
Media Player	Bluetooth only
Bluetooth	BT V5.3 (AC6956F)
Lighting	RGB LED Party Light
Frequency Response	60Hz-18kHz
Max Peak SPL @ 1 Meter	85 dB
Enclosure Material	ABS + Plastic
Mounting Options	Magnetic mount
Battery Specifications	3.7V/2600mAh
Charging Current	5V / 1A
Battery Playtime	5-6 hours (70% volume, LED lighting off) 6-8 hours (50% volume, LED lighting off)
Battery Charge Time	3-4 hours
Talking Time	8-10 hours
Product Size	199 x 80 x 47.2mm
Product Weight	.43 Kg
Battery Specs	2600mAH Lithium-Ion Rechargeable Battery

Responsible Party Name:

Innovative Concepts & Designs LLC

Company address:

458 Florida Grove Road
Perth Amboy, NJ, 08861 USA

FCC Compliance Statement

This device complies with Part 15 of the FCC Rules. The operation is subject to the following two conditions:

- (1) This device may not cause harmful interference, and
- (2) This device must accept any interference received, including interference that may cause undesired operation.

Note: This equipment has been tested and found to comply with the limits for a class B digital device, pursuant to Part 15 of the FCC Rules. This equipment generates uses and can radiate radio frequency energy and if not installed and used in accordance with the instructions, may cause harmful interference to radio communications. However, there is no guarantee that interference will not occur in a particular installation. If this equipment does cause interference to radio or television reception, which can be determined by turning the equipment off and then on, the user is encouraged to try to correct the interference by one or more of the following measures:

- Reorient or relocate the receiving antenna.
- Increase the separation between the equipment and receiver.
- Connect the equipment to a different outlet so that the equipment and receiver are on different branch circuits.
- Consult the dealer or an experienced radio/TV technician for help.

Warning: Changes or modifications made to this device not expressly approved by **Innovative Concepts and Design LLC** may void the FCC authorization to operate this device. Note: The manufacturer is not responsible for any radio or TV interference caused by unauthorized modifications to this equipment. Such modifications could void the user's authority to operate the equipment.

RF exposure statement:

This device complies with FCC RF radiation exposure limits set forth for an uncontrolled environment. The device is installed and operated without restriction.

FCC ID: 2AE6G-BEATGRIP

LEGALITY & SAFETY

The device is not intended for use by people (including children) with reduced physical, sensory or mental capacity. People who have not read the manual, unless they have received an explanation by someone responsible for their safety, should not use this unit. Children should be monitored to ensure that they do not play with the device. The device should always be readily accessible. The device should not be exposed to water. No objects filled with liquids, such as vases, shall be placed on the device. Always leave a minimum distance of 10 cm around the unit to ensure sufficient ventilation. Open flame sources, such as candles, should not be placed on top of the device. The device is intended for use only in a temperate climate. At full volume, prolonged listening may damage your hearing and cause temporary or permanent deafness, hearing drone, tinnitus, or hyperacusis.

Listening at high volume is not recommended. One hour per day is not recommended either. Danger of explosion if battery is incorrectly replaced or not replaced by the same type or equivalent. The battery should not be exposed to excessive heat such as sunshine or fire. Different types of batteries, or new and used batteries, should not be mixed. The battery must be installed according to its polarity. If the battery is worn, it must be removed from the product. The battery must be disposed of safely. Always use collection bins to protect the environment.

The battery can only be replaced by the maker of this product, the sales department, or a qualified person. Switch the device off where the use of the device is not allowed or where there is a risk of causing interference or danger - for examples: on an aircraft, or near medical equipment, fuel, chemicals or blasting sites. Check the current laws and regulations regarding the use of this device in the areas where you drive. Do not handle the device when driving.

Concentrate fully on driving. All wireless devices are susceptible to interference which may affect their performance. All our devices conform to international/national standards and regulations, and we aim to limit user exposure to electromagnetic fields. These standards and regulations were adopted after the completion of extensive scientific research. This research established no link between the use of the mobile headset and any adverse effects on health if the device is used in accordance with standard practices. Only qualified people are authorized to install or repair this product. Only use batteries, chargers and other accessories which are compatible with this equipment. Do not connect incompatible products. This equipment is not waterproof. Keep it dry. Keep your device in a safe place, out of the reach of young children. The device contains small parts which may present a choking hazard to kids.

WARRANTY

A. Innovative Concepts & Designs LLC guarantees its products to be free from defects in materials and workmanship for one (1) year from the original purchase date.

Exceptions: Laser assemblies on CD Players, batteries, cartridges, and crossfaders are covered for 90 days.

B. This limited warranty does not cover damage or failure caused by abuse, misuse, abnormal use, faulty installation, improper maintenance, or any repairs other than those provided by an authorized Innovative Concepts & Designs Service Center.

C. There are no obligations of liability on the part of Innovative Concepts & Designs for consequential damages arising out of or in connection with the use or performance of the product or other indirect damages with respect to loss of property, revenues, of profit, or costs of removal, installation, or reinstallation. All implied warranties for Innovative Concepts & Designs, including implied warranties for fitness, are limited in duration to one (1) year from the original date of purchase, unless otherwise mandated by local statutes.

WELCOME TO THE GEMINI FAMILY!

At Gemini, our highest priority is making your experience unforgettable. Need help with setting up, troubleshooting, or looking for some tips? We're here for you, Monday through Friday 9AM-5PM EST.



hello@geminisound.com



1-844-GEMINI9



www.geminisound.com



FUNCIONES

Conoce el altavoz Bluetooth magnético Gemini BeatGrip, una combinación perfecta de portabilidad y rendimiento. Diseñado para estilos de vida modernos, este altavoz de mano cuenta con una base magnética para sujetarlo sin esfuerzo a cualquier superficie metálica, ofreciéndole la libertad de disfrutar de la música dondequiera que vaya, llueva o truene. Con un diseño resistente a la intemperie IPX6, garantiza la durabilidad incluso en condiciones húmedas. Sumérgete en audio de alta calidad, ya sea que estés bailando tus canciones favoritas o atendiendo llamadas a través del altavoz incorporado. La batería de 2600 mAh del BeatGrip garantiza música ininterrumpida con un tiempo de reproducción de hasta 12 horas, lo que lo convierte en su compañero ideal para aventuras al aire libre o momentos acogedores en interiores. Además, su vibrante luz LED para fiestas crea el ambiente para cualquier ocasión. Eleva tu experiencia de audio con el altavoz Bluetooth magnético Gemini BeatGrip, donde el estilo se une a la funcionalidad.

DISEÑO MAGNÉTICO CON LUZ LED

Se adhiere sin esfuerzo a superficies metálicas para escuchar con las manos libres. La luz LED incorporada agrega ambiente a su experiencia musical.

CONECTIVIDAD INALÁMBRICA

Conéctese sin problemas con sus dispositivos a través de Bluetooth para obtener hasta 12 horas de reproducción continua. Responde llamadas con el micrófono incorporado.

RENDIMIENTO DE AUDIO PREMIUM

Disfruta de una calidad de sonido nítida con los potentes altavoces del BeatGrip, perfectos para música, podcasts y llamadas.

RESISTENTE A LA INTEMPERIE







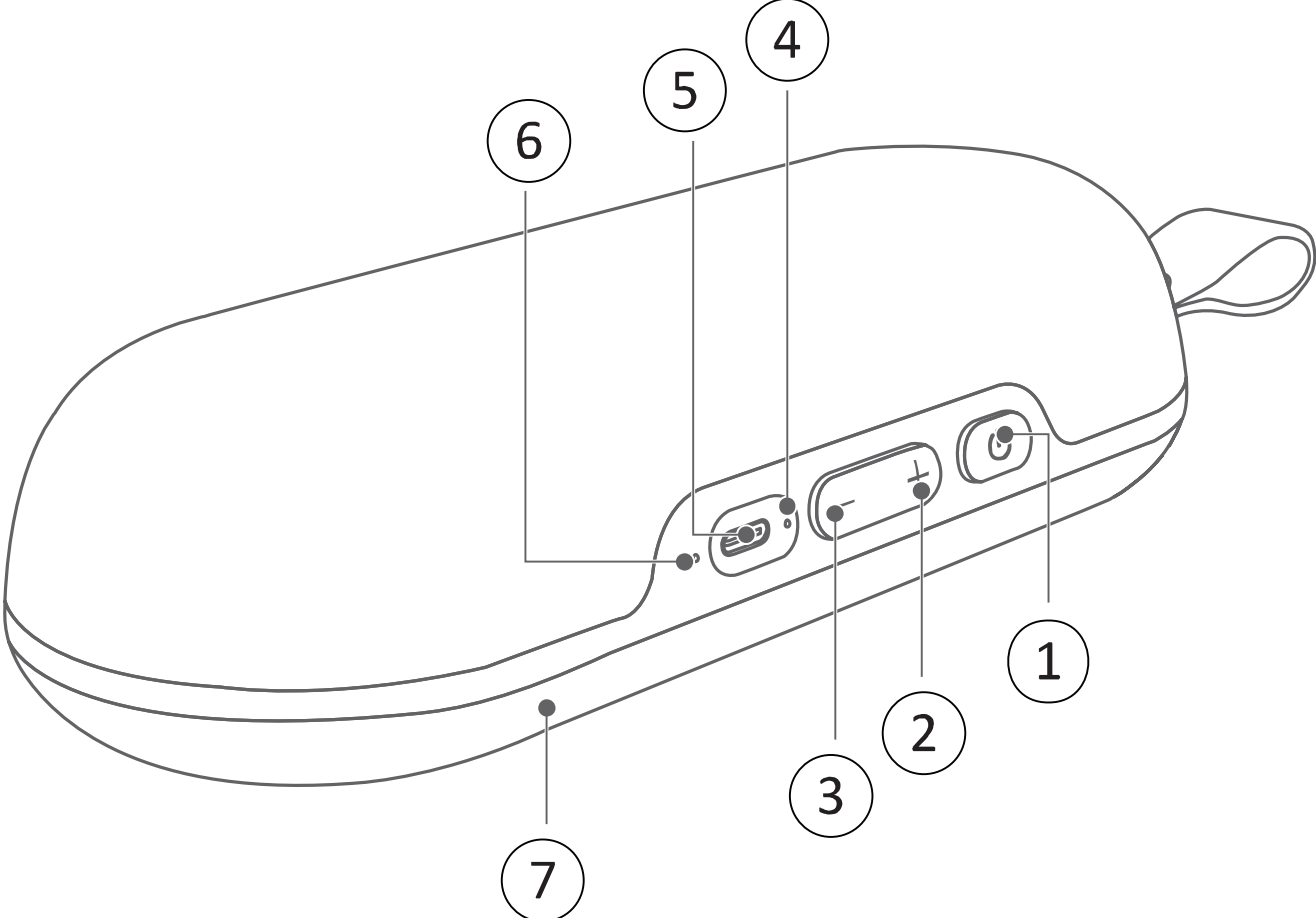

Diseñado para soportar los elementos exteriores, por lo que es ideal para diversas actividades y entornos.

PORTÁTIL Y VERSÁTIL

Diseño compacto y ligero, perfecto para su uso sobre la marcha. Cuenta con emparejamiento inalámbrico TWS entre dos unidades para una experiencia de sonido mejorada.

DESCRIPCIÓN GENERAL DEL PRODUCTO



1		<p>Pulsación larga 2 s: Encendido/apagado</p> <p>Pulsación corta una vez: Reproducir/Pausa; Contestar/Colgar llamada</p> <p>Pulsación corta dos veces: Cambiar el modo de iluminación LED</p> <p>Pulsación corta 3 veces: Proteger la privacidad de la llamada; Rechazar llamada entrante; Conexión/desconexión de TWS</p>
2		<p>Pulsación corta una vez: Aumentar el volumen</p> <p>Pulsación larga 2s: Siguiete canción</p>
3		<p>Pulsación corta una vez: Disminuir volumen</p> <p>Pulsación larga 2s: Canción anterior</p>
2/3		<p>Pulsación corta al mismo tiempo: desconexión Bluetooth</p> <p>Pulsación larga 2 segundos al mismo tiempo: Enciende / apaga la luz SOS</p>
4		<p>Indicador de estado LED:</p> <p>Encendido / TWS = LED azul encendido</p> <p>Búsqueda Bluetooth = LED azul intermitente</p> <p>Batería baja = LED rojo intermitente</p> <p>Carga = LED rojo encendido</p> <p>Completamente cargado = LED apagado</p>
5		<p>Puerto de carga USB tipo C</p>
6		<p>Micrófono telefónico</p>
7		<p>Luz LED para fiestas</p> <p>5 modos</p>



OPERATIONS

1. Encendido/apagado

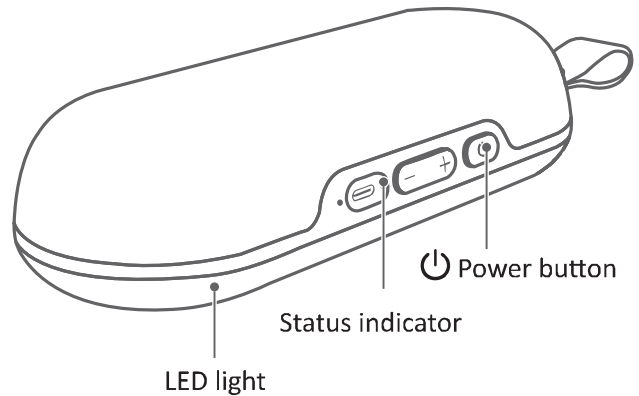
- Mantenga presionado  el botón (1) 2 segundos para encender / apagar.



2. Modo Bluetooth

- Mantenga presionado  el botón (1) 2 segundos para encender con tono, el altavoz entrará en modo de emparejamiento bluetooth,  el indicador (4) parpadeará en azul.
- Elija "Gemini BeatGrip" en su lista de bluetooth, habrá tono una vez que se conecte correctamente y el  indicador (4) se volverá azul fijo. Ahora, puedes reproducir música.

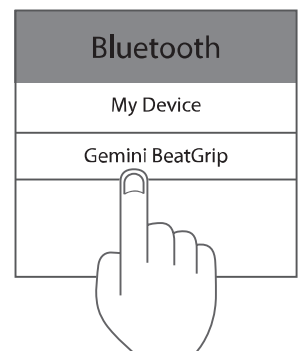

3. Conexión TWS

- Después de encender pero antes de conectarse con cualquier dispositivo, presione brevemente  el botón (1) 3 veces en cualquiera de los altavoces para activar la función TWS, escuchará el tono de aviso y el indicador azul parpadeará.
- Habrá un pitido una vez que se empareje correctamente, luego el indicador azul del altavoz vinculado se encenderá de forma fija y el indicador azul del altavoz principal parpadeará, ahora puede conectar el altavoz con el dispositivo Bluetooth para la reproducción estéreo desde ambos altavoces.

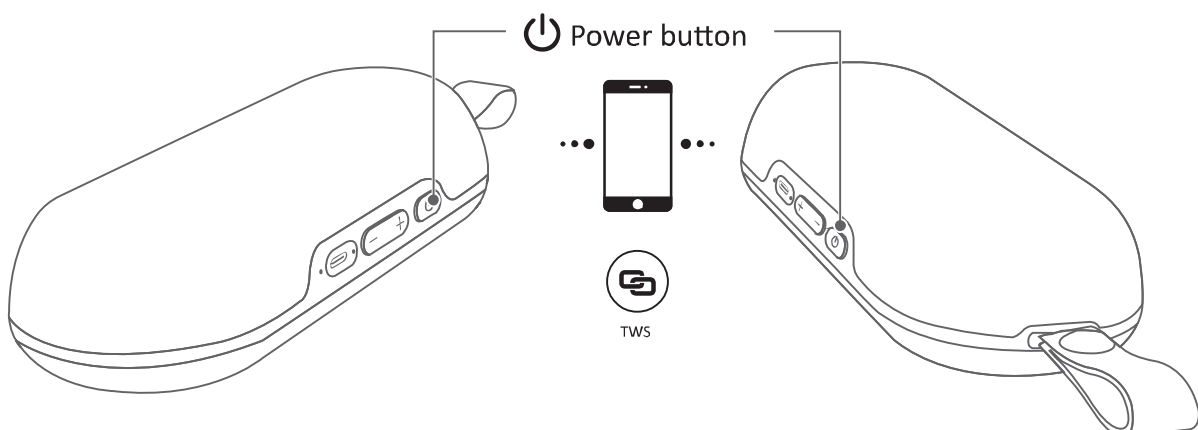

4. Control de volumen

- Presione brevemente el + botón (2) una vez para subir el volumen, habrá un pitido cuando se alcance el volumen máximo.
- Mantenga presionado + el botón (2) 2s para la siguiente canción.
- Presione brevemente el — botón (3) una vez para bajar el volumen.
- Mantenga presionado — el botón (3) 2s para la canción anterior.

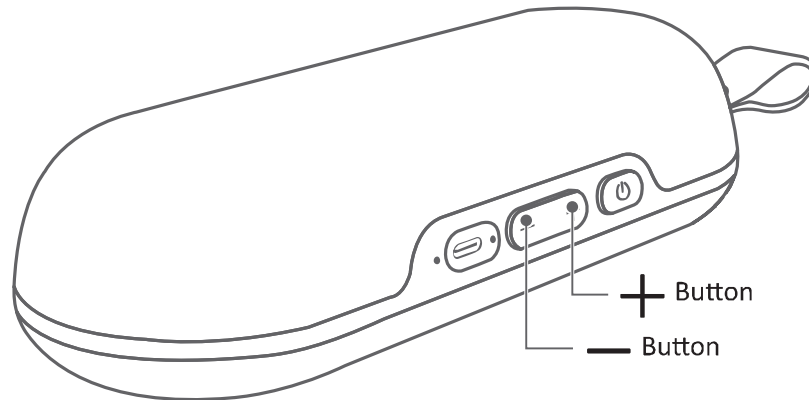

5. Modo de iluminación LED

- Después de encender, haga doble clic en ⏻ el botón (1) para cambiar el modo de iluminación LED (Modo 1 / Modo 2 / Modo 3 / Modo 4 / Modo 5 / Apagado)
- Mantenga presionados ambos + — botones (2/3) al mismo tiempo durante 3 segundos para encender / apagar la iluminación.

6. Llamadas

- Cuando se reciba una llamada, presione brevemente ⏻ el botón (1) para responder.
- Presione brevemente el ⏻ botón (1) 3 veces para colgar.
- Durante una llamada/conversación, presione brevemente ⏻ el botón (1) para colgar.
- Presione brevemente ⏻ el botón (1) 3 veces para proteger la privacidad de la llamada (mover la llamada al teléfono).

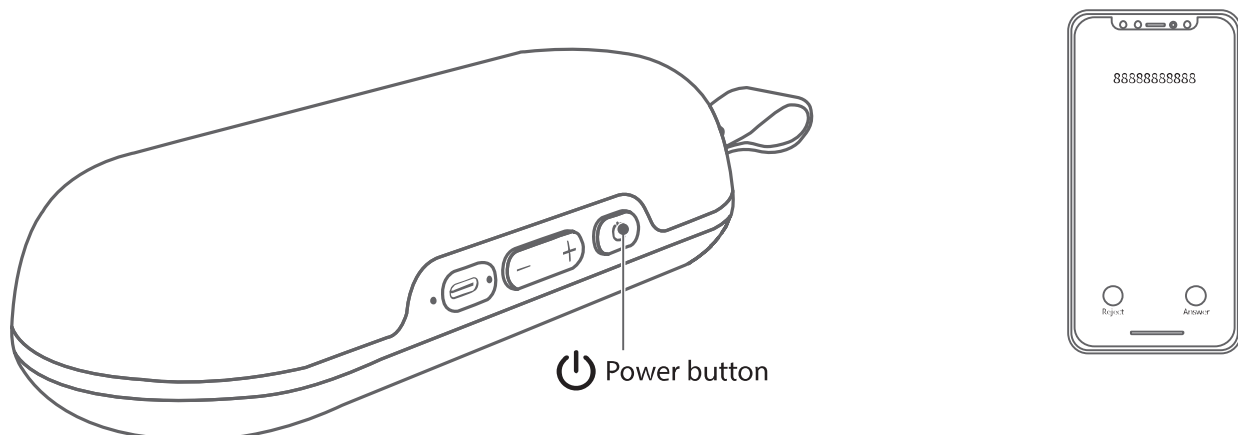

7. Ahorro de energía

- El altavoz se apagará automáticamente para ahorrar batería cuando no haya nada conectado después de 10 minutos.

8. Carga

Nota importante:

- Utilice el cable de carga USB-C suministrado
- Utilice una fuente de salida de 5 V/2 A (o superior)
- Cargue cuando escuche el tono de aviso de batería baja o el indicador parpadee en rojo. El indicador rojo estará normalmente encendido durante la carga y se apagará después de la carga completa.

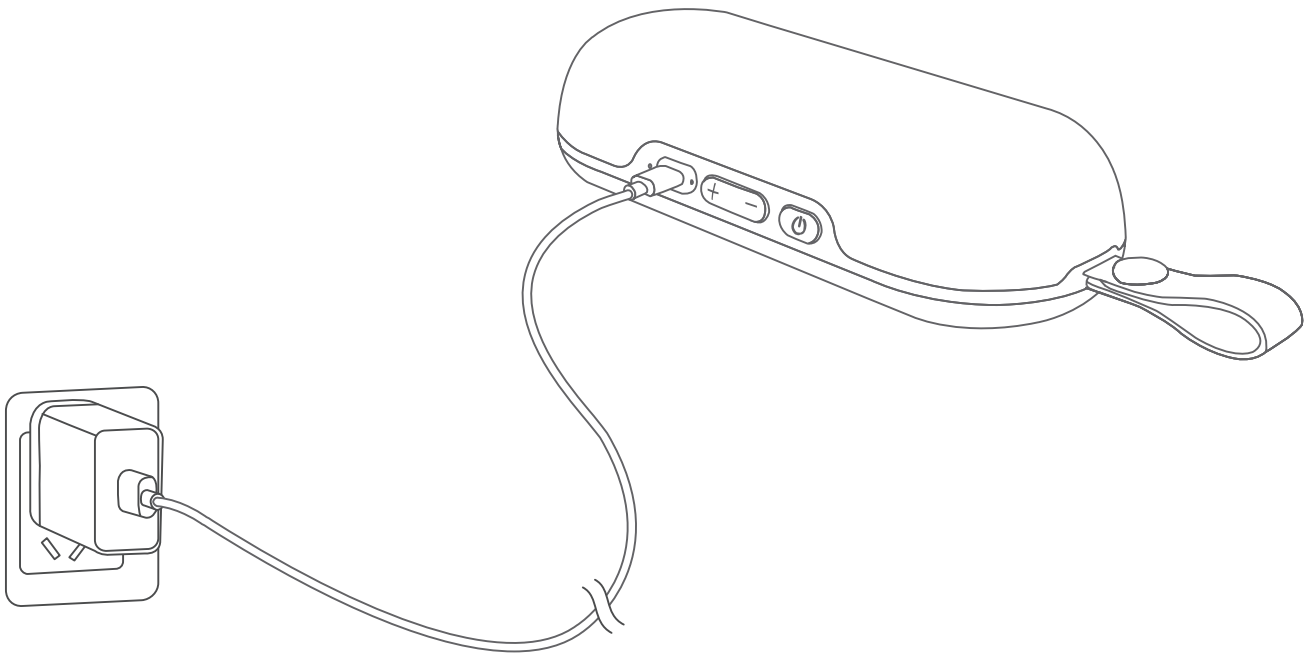

CARACTERÍSTICAS TÉCNICAS

Activo/Pasivo	Activo
Tipo de amplificador	Clase D
Tamaño del controlador	2 x 2"
Potencia total	Pico de 30 W
Reproductor multimedia	Solo Bluetooth
Bluetooth	BT V5.3 (AC6956F)
Iluminación	Luz de fiesta LED RBG
Respuesta de frecuencia	60Hz-18kHz
Pico máximo de SPL @ 1 metro	85 dB
Material de la carcasa	ABS + Plástico
Opciones de montaje	Montaje magnético
Especificaciones de la batería	3.7V/2600mAh
Corriente de carga	5V / 1A
Tiempo de reproducción de la batería	5-6 horas (70% de volumen, iluminación LED apagada) 6-8 horas (50% de volumen, iluminación LED apagada)
Tiempo de carga de la batería	3-4 horas
Tiempo de conversación	8-10 horas
Tamaño del producto	199 x 80 x 47,2 mm
Peso del producto	.43 Kg
Especificaciones de la batería	Batería recargable de iones de litio de 2600 mAH

封底