



TEST REPORT

Report No. : **CHTEW19100112** Report verification : 

Project No. : **SHT1906019001EW**

FCC ID : **2AE6CER9000U2**

Applicant's name : **Shenzhen Excera Technology Co., Ltd.**

Address : 3rd Floor, Jiada R&D Building, No.5 Songpingshan Road , Hi-Tech Park North, Nanshan District , Shenzhen , China

Manufacturer..... : Shenzhen Excera Technology Co., Ltd.

Address..... : 3rd Floor, Jiada R&D Building, No.5 Songpingshan Road , Hi-Tech Park North, Nanshan District , Shenzhen , China

Test item description : **Digital Repeater**

Trade Mark : EXCERA

Model/Type reference : ER9000 U2

Listed Model(s)..... : -

Standard..... : **FCC CFR Title 47 Part 2**
FCC CFR Title 47 Part 90

Date of receipt of test sample..... : Sept.17, 2019

Date of testing..... : Sept.17, 2019- Oct.22, 2019

Date of issue..... : Oct.23, 2019

Result : **PASS**

Compiled by
 (position+printed name+signature) . : File administrators Echo Wei 

Supervised by
 (position+printed name+signature) . : Project Engineer Gaosheng Pan 

Approved by
 (position+printed name+signature) . : RF Manager Hans Hu 

Testing Laboratory Name..... : **Shenzhen Huatongwei International Inspection Co., Ltd.**

Address : 1/F, Bldg 3, Hongfa Hi-tech Industrial Park, Genyu Road, Tianliao, Gongming, Shenzhen, China

Shenzhen Huatongwei International Inspection Co., Ltd. All rights reserved.

This publication may be reproduced in whole or in part for non-commercial purposes as long as the Shenzhen Huatongwei International Inspection Co., Ltd. is acknowledged as copyright owner and source of the material. Shenzhen Huatongwei International Inspection Co., Ltd. takes no responsibility for and will not assume liability for damages resulting from the reader's interpretation of the reproduced material due to its placement and context.

The test report merely correspond to the test sample.

Contents

1	<u>TEST STANDARDS AND REPORT VERSION</u>	3
1.1.	Test Standards	3
1.2.	Report revised information	3
2	<u>TEST DESCRIPTION</u>	4
3	<u>SUMMARY</u>	5
3.1	Client Information	5
3.2	Product Description	5
3.3	Test frequency list	6
3.4	Operation mode	7
3.5	EUT configuration	8
4	<u>TEST ENVIRONMENT</u>	9
4.1	Address of the test laboratory	9
4.2	Test Facility	9
4.3	Environmental conditions	10
4.4	Statement of the measurement uncertainty	10
4.5	Equipments Used during the Test	11
5	<u>TEST CONDITIONS AND RESULTS</u>	13
5.1	Conducted Carrier Output Power	13
5.2	99% Occupied Bandwidth & 26dB Bandwidth	14
5.3	Emission Mask	16
5.4	Modulation Limit	18
5.5	Audio Frequency Response	19
5.6	Frequency stability VS Temperature	21
5.7	Frequency stability VS Voltage	22
5.8	Transmitter Frequency Behavior	23
5.9	Transmit Conducted Spurious Emission	25
5.10	Transmitter Radiated Spurious Emission	26
5.11	AC Power Line Conducted Emission	39
5.12	Radiated Emission	42
6	<u>TEST SETUP PHOTOS OF THE EUT</u>	47
7	<u>EXTERNAL AND INTERNAL PHOTOS OF THE EUT</u>	50
8	<u>APPENDIX REPORT</u>	59

1 TEST STANDARDS AND REPORT VERSION

1.1. Test Standards

The tests were performed according to following standards:

[FCC Rules Part 2](#): Frequency allocations and radio treaty matters; General rules and regulations

[FCC Rules Part 90](#): Private land mobile radio services.

[ANSI C63.26-2015](#): American National Standard for Compliance Testing of Transmitters Used in Licensed Radio Services

[ANSI/TIA-603-E\(2016\)](#): Land Mobile FM or PM Communications Equipment and Performance Standards

[FCC Part 15 Subpart B](#): Unintentional Radiators.

[ANSI C63.4-2014](#): American National Standard for Methods of Measurement of Radio-Noise Emissions from Low-Voltage Electrical and Electronic Equipment in the Range of 9 kHz to 40 GHz

1.2. Report revised information

Revised No.	Date of issued	Description
N/A	2019-10-23	Original

2 TEST DESCRIPTION

Test Item	Section in CFR 47	Result	Test Engineer
Conducted Carrier Output Power	Part 90.205 Part 2.1046(a)	Pass	Linshuang Chen
99% Occupied Bandwidth & 26dB bandwidth	Part 90.209 & 210 Part 2.1049	Pass	Linshuang Chen
Emission Mask	Part 90.209 & 210 Part 2.1049	Pass	Linshuang Chen
Modulation Limit	Part 2.1047(b)	Pass	Linshuang Chen
Audio Frequency Response	Part 2.1047(a)	Pass	Linshuang Chen
Frequency Stability VS Temperature	Part 90.213 Part 2.1055	Pass	Linshuang Chen
Frequency Stability VS Voltage	Part 90.213 Part 2.1055	Pass	Linshuang Chen
Transient Frequency Behavior	Part 90.214	Pass	Linshuang Chen
Transmit Conducted Spurious Emission	Part 90.210 Part 2.1051	Pass	Linshuang Chen
Transmit Radiated Spurious Emission	Part 90.210 Part 2.1053	Pass	Linshuang Chen
AC Power Line Conducted Emission	Part 15.107	Pass	Linshuang Chen
Radiated Emission	Part 15.109	Pass	Linshuang Chen

3 SUMMARY

3.1 Client Information

Applicant:	Shenzhen Excera Technology Co., Ltd.
Address:	3rd Floor, Jiada R&D Building, No.5 Songpingshan Road , Hi-Tech Park North, Nanshan District , Shenzhen , China
Manufacturer:	Shenzhen Excera Technology Co., Ltd.
Address:	3rd Floor, Jiada R&D Building, No.5 Songpingshan Road , Hi-Tech Park North, Nanshan District , Shenzhen , China

3.2 Product Description

Name of EUT:	Digital Repeater	
Trade mark:	EXCERA	
Model/Type reference:	ER9000 U2	
Listed model(s):	-	
Power supply:	DC 13.6V	
Adapter information:	-	
Hardware version:	B	
Software version:	R1.4.04D	
RF Specification		
Support Frequency Range:	450MHz~520MHz	
Permitted frequency range: * ¹	450MHz~512MHz, 512 MHz~520MHz	
Rated Output Power:	<input checked="" type="checkbox"/> High Power: 50W <input checked="" type="checkbox"/> Low Power: 5W	
Modulation Type:	Analog:	FM
	Digital :	4FSK
Supported Digital Protocol: * ²	DMR	
Channel Separation:	Analog:	<input checked="" type="checkbox"/> 12.5kHz
	Digital :	<input type="checkbox"/> 6.25kHz <input checked="" type="checkbox"/> 12.5kHz
Emission Designator: * ³	Analog:	11K0F3E
	Digital:	7K60FXW, 7K60FXD
Support data rate:	9.6kbps	
Antenna Type:	External	

Note:

- (1) *¹ Listed frequency range 512MHz~520MHz for Federal use Only.
- (2) *² The DMR standard specifies two-slot Time Division Multiplexing Technology to split the 12.5 kHz channel into two virtual 6.25kHz communication paths. This equates to an efficiency of one voice channel per 6.25 kHz of bandwidth even though it operates in channels of 12.5 kHz

- (3) *³ According to FCC Part 2.202 requirements, the Necessary Bandwidth is calculated as follows:

- For FM Voice Modulation

Channel Spacing = 12.5 KHz, D = 2.5 KHz max, K = 1, M = 3 KHz

$B_n = 2M + 2DK = 2*3 + 2*2.5*1 = 11 \text{ KHz}$

Emission designation: 11K0F3E

- For FM Data Modulation

Channel Spacing = 12.5 KHz, R = 9600 bps, D = 1944Hz, S = 4, K = 0.72

$B_n = (R/\log_2 S) + 2DK \approx 7.6 \text{ KHz}$

Emission designation: 7K60FXW, 7K60FXD

3.3 Test frequency list

According to ANSI C63.26 section 5.1.2.1:

Measurements of transmitters shall be performed and, if required, reported for each frequency band in which the EUT can be operated with the device transmitting at the number of frequencies in each band specified in Table 2.

Frequency range over which EUT operates	Number of frequencies	Location in frequency range of operation
1 MHz or less	1	Middle
1 MHz to 10 MHz	2	1 near top and 1 near bottom
More than 10 MHz	3	1 near top, 1 near middle, and 1 near bottom

Frequency Bands (MHz)	Test Frequency (MHz)
450MHz ~ 512MHz	CH _L 450.0125
	CH _{M1} 481.0125
	CH _{M2} 511.9875
512MHz ~520MHz	CH _{M3} 512.0125
	CH _H 519.9875

3.4 Operation mode

Test Mode	Transmitting	Receiving	Digital	Analog	Power Level	
			12.5kHz	12.5kHz	High	Low
TX-DNH	■		■		■	
TX-DNL	■		■			■
TX-ANH	■			■	■	
TX-ANL	■			■		■
RX-DN		■	■			
RX-AN		■		■		

Note:

■: is operation mode.

Modulation Type	Description
UM	Un-modulation
AM2	Apply a 1000 Hz tone and adjust the audio frequency generator to produce 20% of the rated system deviation.
AM6	Apply a 1000 Hz modulating signal to the transmitter from the audio frequency generator, and adjust the level to obtain 60% of full rated system deviation, then increase the level from the audio generator by 20 dB
AM5	Modulate the transmitter with a 2500 Hz sine wave at an input level 16 dB greater than that necessary to produce 50% of rated system deviation.
DM	A 511 bit binary pseudo-random bit sequence based on ITU-T Rec. O.153

Pre-scan above all test mode, found below test mode which it was worse case mode, so only show the test data for worse case mode on the test report.

Test item	Modulation Type	Test mode (Worse case mode)
Conducted Output Power	UM	TX-DNH, TX-DNL, TX-ANH, TX-ANL
99% Occupied Bandwidth & 26dB bandwidth	AM6, DM	TX-DNH, TX-DNL, TX-ANH, TX-ANL
Emission Mask	AM5, DM	TX-DNH, TX-DNL, TX-ANH, TX-ANL
Modulation Limit	AM6	TX-ANH
Audio Frequency Response	AM2	TX-ANH
Frequency Stability VS Temperature	UM	TX-DNH, TX-DNL, TX-ANH, TX-ANL
Frequency Stability VS Voltage	UM	TX-DNH, TX-DNL, TX-ANH, TX-ANL
Transient Frequency Behavior	UM	TX-DNH, TX-ANH
Transmit Conducted Spurious Emission	AM5, DM	TX-DNH, TX-ANH
Transmit Radiated Spurious Emission	AM5, DM	TX-DNH, TX-ANH
AC Power Line Conducted Emission	-	RX-AN
Radiated Emission	-	RX-AN

3.5 EUT configuration

The following peripheral devices and interface cables were connected during the measurement:

- - supplied by the manufacturer
- - supplied by the lab

●	Power Cable	Length (m) :	/
		Shield :	Unshielded
		Detachable :	Undetachable
○	Multimeter	Manufacturer :	/
		Model No. :	/

4 TEST ENVIRONMENT

4.1 Address of the test laboratory

Laboratory: Shenzhen Huatongwei International Inspection Co., Ltd.

Address: 1/F, Bldg 3, Hongfa Hi-tech Industrial Park, Genyu Road, Tianliao, Gongming, Shenzhen, China

4.2 Test Facility

The test facility is recognized, certified, or accredited by the following organizations:

CNAS-Lab Code: L1225

Shenzhen Huatongwei International Inspection Co., Ltd. has been assessed and proved to be in compliance with CNAS-CL01 Accreditation Criteria for Testing and Calibration Laboratories (identical to ISO/IEC17025: 2005 General Requirements) for the Competence of Testing and Calibration Laboratories.

A2LA-Lab Cert. No. 3902.01

Shenzhen Huatongwei International Inspection Co., Ltd. EMC Laboratory has been accredited by A2LA for technical competence in the field of electrical testing, and proved to be in compliance with ISO/IEC 17025: 2005 General Requirements for the Competence of Testing and Calibration Laboratories and any additional program requirements in the identified field of testing.

FCC-Registration No.: 762235

Shenzhen Huatongwei International Inspection Co., Ltd. EMC Laboratory has been registered and fully described in a report filed with the FCC (Federal Communications Commission). The acceptance letter from the FCC is maintained in our files. Registration 762235.

IC-Registration No.: 5377A

Two 3m Alternate Test Site of Shenzhen Huatongwei International Inspection Co., Ltd. has been registered by Certification and Engineering Bureau of Industry Canada for the performance of radiated measurements with Registration No. 5377A.

ACA

Shenzhen Huatongwei International Inspection Co., Ltd. EMC Laboratory can also perform testing for the Australian C-Tick mark as a result of our A2LA accreditation.

4.3 Environmental conditions

Atmospheric Contions	
Temperature:	21°C to 25°C
Relative Humidity:	20 % to 75 %.
Atmospheric Pressure:	860 mbar to 1060 mbar
Norminal Test Voltage:	$V_N = DC 13.60V$
Norminal Test Voltage:	$V_N = AC 120V$
Extrem Test Voltage @115% V_N :	$V_H = DC 15.64V$
Extrem Test Voltage @110% V_N :	$V_H = AC 132V$
Extrem Test Voltage @85% V_N :	$V_L = DC 11.56V$
Extrem Test Voltage @90% V_N :	$V_L = AC 108V$

Note:

AC and DC power supply, the final voltage to the board is the same, so only one case was tested.

4.4 Statement of the measurement uncertainty

The data and results referenced in this document are true and accurate. The reader is cautioned that there may be errors within the calibration limits of the equipment and facilities. The measurement uncertainty was calculated for all measurements listed in this test report acc. to CISPR 16 - 4 „Specification for radio disturbance and immunity measuring apparatus and methods – Part 4: Uncertainty in EMC Measurements“ and is documented in the Shenzhen Huatongwei International Inspection Co., Ltd quality system acc. to DIN EN ISO/IEC 17025. Furthermore, component and process variability of devices similar to that tested may result in additional deviation. The manufacturer has the sole responsibility of continued compliance of the device.

Hereafter the best measurement capability for Shenzhen Huatongwei laboratory is reported:

Test Items	Measurement Uncertainty	Notes
Frequency stability & Occupied Bandwidth	15Hz for <1GHz 70Hz for >1GHz	(1)
Conducted Output Power	0.51dB	(1)
ERP / EIRP / RSE	2.66dB for <1GHz 3.44dB for >1GHz	(1)
Conducted Emission 9KHz-30MHz	3.02dB	(1)
Radiated Emission 30~1000MHz	4.90dB	(1)
Radiated Emission 1~18GHz	4.96dB	(1)
FM deviation	25 Hz	(1)
Audio level	0.62 dB	(1)
Low Pass Filter Response	0.76 dB	(1)
Modulation Limiting	0.42 %	(1)
Transient Frequency Behavior	6.8 %	(1)

(1) This uncertainty represents an expanded uncertainty expressed at approximately the 95% confidence level using a coverage factor of $k=1.96$.

4.5 Equipments Used during the Test

● TS8613 Test system						
Used	Test Equipment	Manufacturer	Model No.	Serial No.	Last Cal. Date (YY-MM-DD)	Next Cal. Date (YY-MM-DD)
●	Spectrum Analyzer	Agilent	N9020A	MY50510187	2019/09/29	2020/09/28
●	Signal & Spectrum Analyzer	R&S	FSW26	103440	2018/10/28	2019/10/27
●	RF Communication Test Set	HP	8920A	3813A10206	2018/10/28	2019/10/27
●	Digital intercom communication tester	Aeroflex	3920B	1001682041	2018/10/28	2019/10/27
●	Signal Generator	R&S	SML02	100507	2018/10/27	2019/10/26
●	Signal Generator	IFR	2032	203002\100	2018/11/11	2019/11/10
●	RF Control Unit	Tonscend	JS0806-2	N/A	N/A	N/A
○	Fliter-VHF	Microwave	N26460M1	498702	2019/03/19	2020/03/18
●	Fliter-UHF	Microwave	N25155M2	498704	2019/03/19	2020/03/18
○	Power Divider	Microwave	OPD1040-N-4	N/A	2018/11/15	2019/11/14
○	Attenuator	JFW	50FH-030-100	N/A	2018/11/15	2019/11/14
○	Attenuator	JFW	50-A-MFN-20	0322	2018/11/15	2019/11/14
●	Test software	HTW	Radio ATE	N/A	N/A	N/A

● Auxiliary Equipment						
Used	Test Equipment	Manufacturer	Model No.	Serial No.	Last Cal. Date (YY-MM-DD)	Next Cal. Date (YY-MM-DD)
●	Climate chamber	ESPEC	GPL-2	N/A	2018/11/08	2019/11/07
●	DC Power Supply	Gwinstek	SPS-2415	GER835793	2018/10/28	2019/10/27

● Radiated Spurious Emission						
Used	Test Equipment	Manufacturer	Model No.	Serial No.	Last Cal. Date (YY-MM-DD)	Next Cal. Date (YY-MM-DD)
●	Semi-Anechoic Chamber	Albatross projects	SAC-3m-01	N/A	2018/09/30	2021/09/29
●	Spectrum Analyzer	R&S	FSP40	100597	2018/10/27	2019/10/26
●	Loop Antenna	R&S	HFH2-Z2	100020	2017/11/20	2020/11/19
●	Ultra-Broadband Antenna	SCHWARZBECK	VULB9163	538	2017/04/05	2020/04/04
●	Horn Antenna	SCHWARZBECK	9120D	1011	2017/04/01	2020/03/31
○	Horn Antenna	SCHWARZBECK	BBHA9170	25841	2017/03/27	2020/03/26
○	Pre-amplifier	BONN	BLWA0160-2M	1811887	2018/11/14	2019/11/13
●	Pre-amplifier	CD	PAP-0102	12004	2018/11/14	2019/11/13
●	Broadband Preamplifier	SCHWARZBECK	BBV 9718	9718-248	2019/05/23	2020/05/22
●	RF Connection Cable	HUBER+SUHNER	RE-7-FH	N/A	2018/11/15	2019/11/14
●	RF Connection Cable	HUBER+SUHNER	RE-7-FL	N/A	2018/11/15	2019/11/14
●	EMI Test Software	Audix	E3	N/A	N/A	N/A
●	Turntable	MATURO	TT2.0	N/A	N/A	N/A
●	Antenna Mast	MATURO	TAM-4.0-P	N/A	N/A	N/A

● Conducted Emission						
Used	Test Equipment	Manufacturer	Model No.	Serial No.	Last Cal. Date (YY-MM-DD)	Next Cal. Date (YY-MM-DD)
●	Shielded Room	Albatross projects	N/A	N/A	2018/09/28	2023/09/27
●	EMI Test Receiver	R&S	ESCI	101247	2018/10/27	2019/10/26
●	Artificial Mains	SCHWARZBECK	NNLK 8121	573	2018/10/27	2019/10/26
●	Pulse Limiter	R&S	ESH3-Z2	100499	2018/10/27	2019/10/26
●	RF Connection Cable	HUBER+SUHNER	EF400	N/A	2018/11/15	2019/11/14
●	Test Software	R&S	ES-K1	N/A	N/A	N/A
○	Single Balanced Telecom Pair ISN	FCC	FCC-TLISN-T2-02	20371	2018/10/28	2019/10/27
○	Two Balanced Telecom Pairs ISN	FCC	FCC-TLISN-T4-02	20373	2018/10/28	2019/10/27
○	Four Balanced Telecom Pairs ISN	FCC	FCC-TLISN-T8-02	20375	2018/10/28	2019/10/27
○	V-Network	R&S	ESH3-Z6	100211	2018/10/27	2019/10/26
○	V-Network	R&S	ESH3-Z6	100210	2018/10/27	2019/10/26
○	2-Line V-Network	R&S	ESH3-Z5	100049	2018/10/27	2019/10/26

● Radiated Emission-6th test site						
Used	Test Equipment	Manufacturer	Model No.	Serial No.	Last Cal. Date (YY-MM-DD)	Next Cal. Date (YY-MM-DD)
●	Semi-Anechoic Chamber	Albatross projects	SAC-3m-02	N/A	2018/09/30	2021/09/29
●	EMI Test Receiver	R&S	ESCI	100900	2018/10/28	2019/10/27
○	Loop Antenna	R&S	HFH2-Z2	100020	2017/11/20	2020/11/19
●	Ultra-Broadband Antenna	SCHWARZBECK	VULB9163	546	2017/04/05	2020/04/04
●	Pre-Amplifier	SCHWARZBECK	BBV 9742	N/A	2018/11/15	2019/11/14
●	RF Connection Cable	HUBER+SUHNER	N/A	N/A	2019/09/28	2020/09/27
●	RF Connection Cable	HUBER+SUHNER	SUCOFLEX104	501184/4	2019/09/28	2020/09/27
●	Test Software	R&S	ES-K1	N/A	N/A	N/A
●	Turntable	Maturo Germany	TT2.0-1T	N/A	N/A	N/A
●	Antenna Mast	Maturo Germany	CAM-4.0-P-12	N/A	N/A	N/A

● Radiated emission-7th test site						
Used	Test Equipment	Manufacturer	Model No.	Serial No.	Last Cal. Date (YY-MM-DD)	Next Cal. Date (YY-MM-DD)
●	Semi-Anechoic Chamber	Albatross projects	SAC-3m-01	N/A	2018/09/30	2021/09/29
●	Spectrum Analyzer	R&S	FSP40	100597	2018/10/27	2019/10/26
●	Horn Antenna	SCHWARZBECK	9120D	1011	2017/03/27	2020/03/26
○	Pre-amplifier	BONN	BLWA0160-2M	1811887	2018/11/14	2019/11/13
●	Pre-amplifier	CD	PAP-0102	12004	2018/11/14	2019/11/13
●	Broadband Pre-amplifier	SCHWARZBECK	BBV 9718	9718-248	2019/05/23	2020/05/22
●	RF Connection Cable	HUBER+SUHNER	RE-7-FH	N/A	2018/11/15	2019/11/14
●	RF Connection Cable	HUBER+SUHNER	RE-7-FL	N/A	2018/11/15	2019/11/14
●	Test Software	Audix	E3	N/A	N/A	N/A
●	Turntable	Maturo Germany	TT2.0-1T	N/A	N/A	N/A
●	Antenna Mast	Maturo Germany	CAM-4.0-P-12	N/A	N/A	N/A

5 TEST CONDITIONS AND RESULTS

5.1 Conducted Carrier Output Power

LIMIT

FCC Part 90.205, FCC Part 2.1046

Applicants for licenses must request and use no more power than the actual power necessary for satisfactory operation.

TEST CONFIGURATION

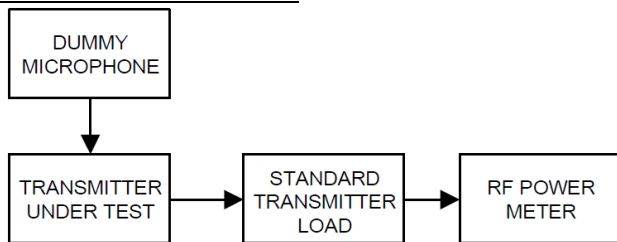

TEST PROCEDURE

- (1) Connect the equipment as illustrated
- (2) Correct for all losses in the RF path
- (3) Measure the transmitter output power
- (4) If the power output is adjustable, measurements shall be made for the highest and lowest power levels.

TEST MODE

Please reference to the section 3.4

TEST RESULTS

Passed **Not Applicable**

Please refer to appendix A on the section 8 appendix report

5.2 99% Occupied Bandwidth & 26dB Bandwidth

LIMIT

FCC Part 90.209, FCC Part 2.1049

Frequency band (MHz)	Channel spacing (kHz)	Authorized bandwidth (kHz)
Below 25 ²		
25-50	20	20
72-76	20	20
150-174	17.5	¹ 320/11.25/6
216-220 ⁵	6.25	20/11.25/6
220-222	5	4
406-512 ²	¹ 6.25	¹³⁶ 20/11.25/6
806-809/851-854	12.5	20
809-824/854-869	25	⁶ 20
896-901/935-940	12.5	13.6
902-928 ⁴		
929-930	25	20
1427-1432 ⁵	12.5	12.5
³ 2450-2483.5 ²		
Above 2500 ²		

TEST CONFIGURATION

Test setup for Analog:

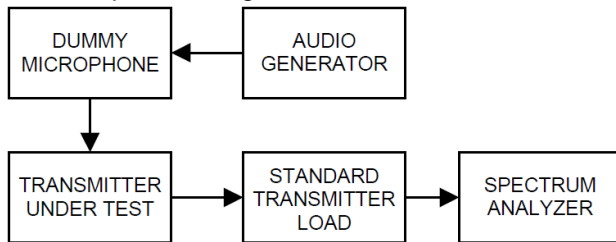

Test setup for Digital:

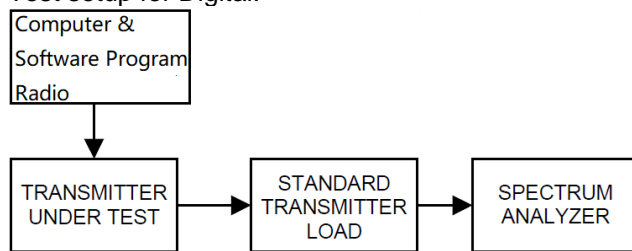

TEST PROCEDURE

- (1) Connect the equipment as illustrated
- (2) Spectrum set as follow:
 - Centre frequency = the nominal EUT channel center frequency,
 - The frequency span for the spectrum analyzer shall be set wide enough to capture all modulation products including the emission skirts (typically a span of 1.5 × OBW is sufficient)
 - RBW = 1% to 5% of the anticipated OBW, VBW ≥ 3 × RBW, Sweep = auto,
 - Detector function = peak, Trace = max hold
- (3) Set 99% Occupied Bandwidth and 26dB Bandwidth
- (4) Measure and record the results in the test report.

TEST MODE

Please reference to the section 3.4

TEST RESULTS

Passed **Not Applicable**

Please refer to appendix B on the section 8 appendix report

5.3 Emission Mask

LIMIT

FCC Part 90.210, FCC Part 2.1049

Frequency band (MHz)	Mask for equipment with audio low pass filter	Mask for equipment without audio low pass filter
Below 25 ¹	A or B	A or C
25-50	B	C
72-76	B	C
150-174 ²	B, D, or E	C, D or E
150 paging only	B	C
220-222	F	F
421-512 ^{2 5}	B, D, or E	C, D, or E
450 paging only	B	G
806-809/851-854 ⁶	B	H
809-824/854-869 ^{3 5}	B	G
896-901/935-940	I	J
902-928	K	K
929-930	B	G
4940-4990 MHz	L or M	L or M
5850-5925 ⁴		
All other bands	B	C

Emission Mask D — 12.5 kHz channel bandwidth equipment

For transmitters designed to operate with a 12.5 kHz channel bandwidth, any emission must be attenuated below the power (P) of the highest emission contained within the authorized bandwidth as follows:

- (1) On any frequency from the centre of the authorized bandwidth f_0 to 5.625 kHz removed from f_0 : 0dB
- (2) On any frequency removed from the centre of the authorized bandwidth by a displacement frequency (f_d in kHz) of more than 5.625 kHz but no more than 12.5 kHz: At least $7.27(f_d - 2.88 \text{ kHz})$ dB.
- (3) On any frequency removed from the centre of the authorized bandwidth by a displacement frequency (f_d in kHz) of more than 12.5 kHz: At least $50 + 10 \log(P)$ dB or 70 dB, whichever is the lesser attenuation.

TEST CONFIGURATION

Test setup for Analog:

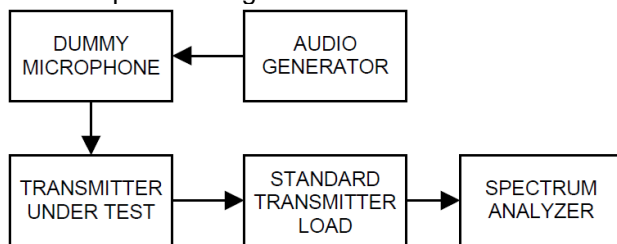

Test setup for Digital:

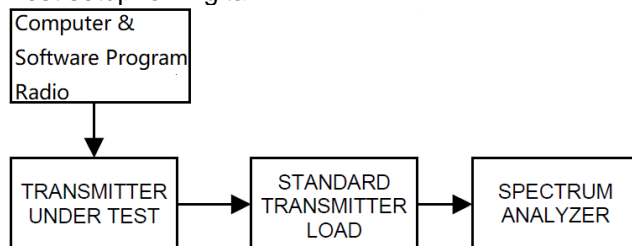

TEST PROCEDURE

- 1) Connect the equipment as illustrated.
- 2) Spectrum set as follow:
Centre frequency = fundamental frequency, span=120kHz for 12.5kHz channel spacing,
RBW=100Hz, VBW=1000Hz, Sweep = auto,
Detector function = peak, Trace = max hold
- 3) Key the transmitter, and set the level of the unmodulated carrier to a full scale reference line. This is the 0dB reference for the measurement.
- 4) Apply Input Modulation Signal to EUT according to Section 3.4
- 5) Measure and record the results in the test report.

TEST MODE

Please reference to the section 3.4

TEST RESULTS

Passed **Not Applicable**

Please refer to appendix C on the section 8 appendix report

5.4 Modulation Limit

LIMIT

FCC Part 2.1047(b)

2.5kHz for 12.5 KHz Channel Spacing System

TEST CONFIGURATION

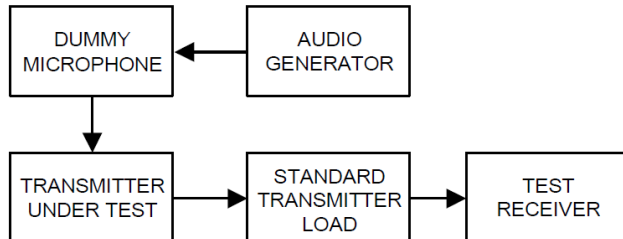

TEST PROCEDURE

- 1) Connect the equipment as illustrated.
- 2) Adjust the transmitter per the manufacturer's procedure for full rated system deviation.
- 3) Set the test receiver to measure peak positive deviation. Set the audio bandwidth for ≤ 0.25 Hz to $\geq 15,000$ Hz. Turn the de-emphasis function off.
- 4) Apply Input Modulation Signal to EUT according to Section 3.4 and vary the input level from -20 to $+20$ dB.
- 5) Measure both the instantaneous and steady-state deviation at and after the time of increasing the audio input level
- 6) Repeat step 4-5 with input frequency changing to 300Hz, 1004Hz, 1500Hz and 2500Hz in sequence.

TEST MODE

Please reference to the section 3.4

TEST RESULTS

Passed Not Applicable

Please refer to appendix D on the section 8 appendix report

5.5 Audio Frequency Response

LIMIT

2.1047(a): Voice modulated communication equipment. A curve or equivalent data showing the frequency response of the audio modulating circuit over a range of 100 to 5000 Hz shall be submitted. For equipment required to have an audio low-pass filter, a curve showing the frequency response of the filter or of all circuitry installed between the modulation limiter and the modulated stage shall be submitted.

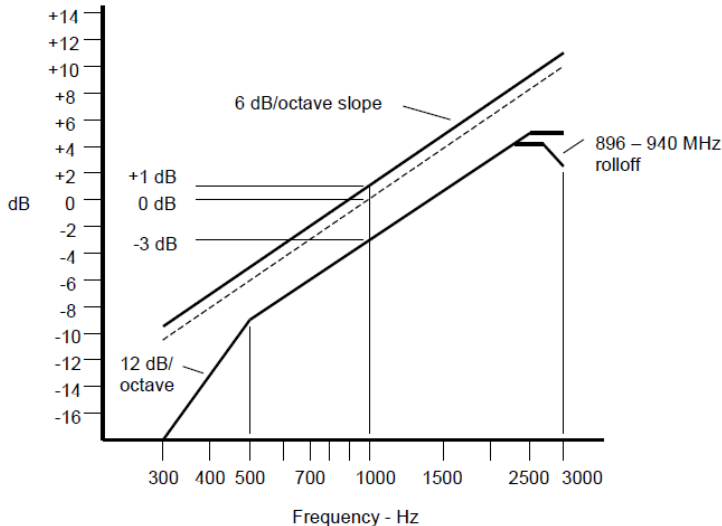

An additional 6 dB per octave attenuation is allowed from 2500 Hz to 3000 Hz in equipment operating in the 25 MHz to 869 MHz range.

TEST CONFIGURATION

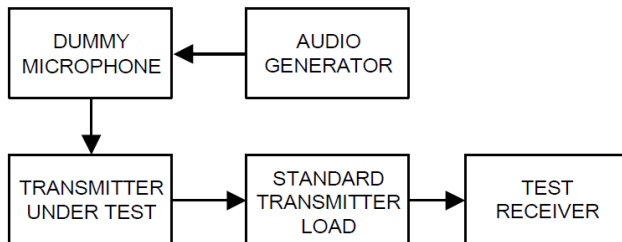

TEST PROCEDURE

- 1) Connect the equipment as illustrated.
- 2) Set the test receiver to measure peak positive deviation. Set the audio bandwidth for 50 Hz to 15,000 Hz. Turn the de-emphasis function off.
- 3) Set the DMM to measure rms voltage.
- 4) Adjust the transmitter per the manufacturer's procedure for full rated system deviation.
- 5) Apply Input Modulation Signal to EUT according to Section 3.4
- 6) Set the test receiver to measure rms deviation and record the deviation reading.
- 7) Record the DMM reading as V_{REF} .
- 8) Set the audio frequency generator to the desired test frequency between 300 Hz and 3000 Hz.
- 9) Vary the audio frequency generator output level until the deviation reading that was recorded in step 6) is obtained.
- 10) Record the DMM reading as V_{FREQ}
- 11) Calculate the audio frequency response at the present frequency as:
audio frequency response = $20 \log_{10} (V_{FREQ}/V_{REF})$.
- 12) Repeat steps 8) through 11) for all the desired test frequencies

TEST MODE

Please reference to the section 3.4

TEST RESULTS

Passed **Not Applicable**

Please refer to appendix E on the section 8 appendix report

5.6 Frequency stability VS Temperature

LIMIT

FCC Part 90.213, FCC Part 2.1055

Frequency range (MHz)	Fixed and base stations	Mobile stations	
		Over 2 watts output power	2 watts or less output power
Below 25	1 2 3 100	100	200
25-50	20	20	50
72-76	5		50
150-174	5 11 5	6 5	4 6 5 0
216-220	1.0		1.0
220-222 ¹²	0.1	1.5	1.5
421-512	7 11 14 2.5	8 5	8 5
806-809	14 1.0	1.5	1.5
809-824	14 1.5	2.5	2.5
851-854	1.0	1.5	1.5
854-869	1.5	2.5	2.5
896-901	14 0.1	1.5	1.5
902-928	2.5	2.5	2.5
902-928 ¹³	2.5	2.5	2.5
929-930	1.5		
935-940	0.1	1.5	1.5
1427-1435	9 300	300	300
Above 2450 ¹⁰			

TEST CONFIGURATION

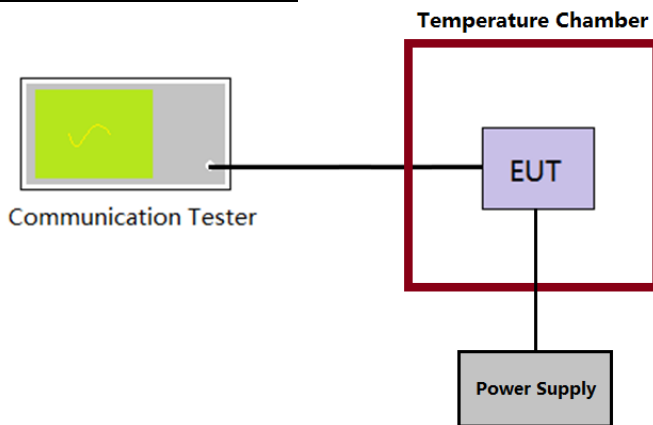

TEST PROCEDURE

- 1) The EUT output port was connected to communication tester.
- 2) The EUT was placed inside the temperature chamber.
- 3) Turn EUT off and set the chamber temperature to -30°C. After the temperature stabilized for approximately 30 minutes recorded the frequency as MCF_{MHz} .
- 4) Calculate the ppm frequency error by the following:
 $ppm\ error = (MCF_{MHz} / ACF_{MHz} - 1) * 10^6$
 where
 MCF_{MHz} is the Measured Carrier Frequency in MHz
 ACF_{MHz} is the Assigned Carrier Frequency in MHz
- 5) Repeat step 3 measure with 10°C increased per stage until the highest temperature of +50°C reached.

TEST MODE

Please reference to the section 3.4

TEST RESULTS

Passed Not Applicable

Please refer to appendix F on the section 8 appendix report

5.7 Frequency stability VS Voltage

LIMIT

FCC Part 90.213, FCC Part 2.1055

Frequency range (MHz)	Fixed and base stations	Mobile stations	
		Over 2 watts output power	2 watts or less output power
Below 25	1 2 3 100	100	200
25-50	20	20	50
72-76	5		50
150-174	5 11 5	6 5	4 6 5 0
216-220	1.0		1.0
220-222 ¹²	0.1	1.5	1.5
421-512	7 11 14 2.5	8 5	8 5
806-809	14 1.0	1.5	1.5
809-824	14 1.5	2.5	2.5
851-854	1.0	1.5	1.5
854-869	1.5	2.5	2.5
896-901	14 0.1	1.5	1.5
902-928	2.5	2.5	2.5
902-928 ¹³	2.5	2.5	2.5
929-930	1.5		
935-940	0.1	1.5	1.5
1427-1435	9 300	300	300
Above 2450 ¹⁰			

TEST CONFIGURATION

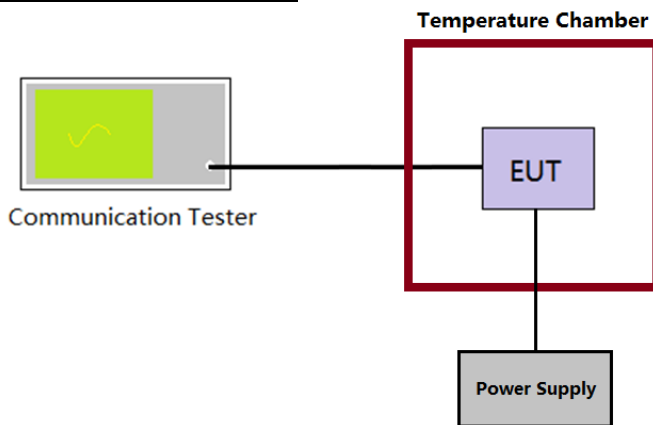

TEST PROCEDURE

- 1) The EUT output port was connected to communication tester.
- 2) The EUT was placed inside the temperature chamber at 25°C
- 3) Record the carrier frequency of the transmitter as MCF_{MHz}
- 4) Calculate the ppm frequency error by the following:

$$ppm\ error = (MCF_{MHz} / ACF_{MHz} - 1) * 10^6$$
 where
 MCF_{MHz} is the Measured Carrier Frequency in MHz
 ACF_{MHz} is the Assigned Carrier Frequency in MHz
- 5) Repeat step 3 measure with varied $\pm 15\%$ of the nominal value measured at the input to the EUT

TEST MODE

Please reference to the section 3.4

TEST RESULTS

Passed Not Applicable

Please refer to appendix G on the section 8 appendix report

5.8 Transmitter Frequency Behavior

LIMIT

FCC part 90.214

Transmitters designed to operate in the 150-174 MHz and 421-512 MHz frequency bands must maintain transient frequencies within the maximum frequency difference limits during the time intervals indicated:

Time intervals ^{1 2}	Maximum frequency difference ³	All equipment	
		150 to 174 MHz	421 to 512 MHz
Transient Frequency Behavior for Equipment Designed to Operate on 25 kHz Channels			
t_1 ⁴	±25.0 kHz	5.0 ms	10.0 ms
t_2	±12.5 kHz	20.0 ms	25.0 ms
t_3 ⁴	±25.0 kHz	5.0 ms	10.0 ms
Transient Frequency Behavior for Equipment Designed to Operate on 12.5 kHz Channels			
t_1 ⁴	±12.5 kHz	5.0 ms	10.0 ms
t_2	±6.25 kHz	20.0 ms	25.0 ms
t_3 ⁴	±12.5 kHz	5.0 ms	10.0 ms
Transient Frequency Behavior for Equipment Designed to Operate on 6.25 kHz Channels			
t_1 ⁴	±6.25 kHz	5.0 ms	10.0 ms
t_2	±3.125 kHz	20.0 ms	25.0 ms
t_3 ⁴	±6.25 kHz	5.0 ms	10.0 ms

Note:

- On is the instant when a 1 kHz test signal is completely suppressed, including any capture time due to phasing.
 - t_1 is the time period immediately following t_{on} .
 - t_2 is the time period immediately following t_1 .
 - t_3 is the time period from the instant when the transmitter is turned off until t_{off} .
 - t_{off} is the instant when the 1 kHz test signal starts to rise.
- During the time from the end of t_2 to the beginning of t_3 , the frequency difference must not exceed the limits specified in §90.213.
- Difference between the actual transmitter frequency and the assigned transmitter frequency.
- If the transmitter carrier output power rating is 6 watts or less, the frequency difference during this time period may exceed the maximum frequency difference for this time period.

TEST CONFIGURATION

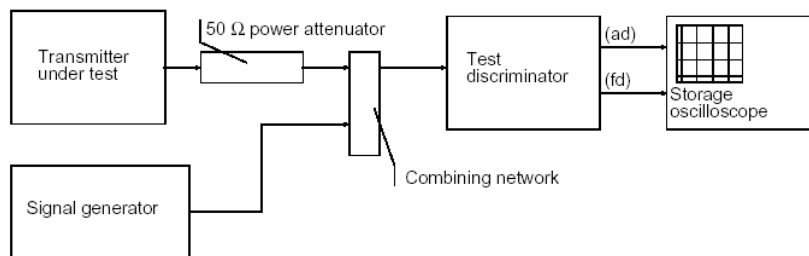

TEST PROCEDURE

- Connect DUT into Test discriminator and Storage Oscilloscope and keep DUT stats ON;
- Input 1kHz signal into DUT;
- Set the modulation domain analyzer to trigger on the rising edge of the waveform in order to capture a single-shot turn-on of the transmitter signals;
- Keep DUT in OFF state and Key the PTT;
- Observe the stored oscilloscope of modulation domain analyzer. The signal trace shall be maintained within the allowable limits during the periods t_1 and t_2 , and shall also remain within limits following t_2 ;
- Adjust the modulation domain analyzer to trigger on the falling edge of the transmitter waveform in order to capture a single-shot turn-off transmitter of the transmitter signal.
- Keep the digital portable radio in ON state and unkey the PTT;
- Observe the stored oscilloscope of modulation domain analyzer, The signal trace shall be maintained within the allowable limits during the period t_3 .
- Set the signal generator to the assigned transmitter frequency and modulate it with a 1 kHz tone at ±12.5 kHz deviation and set its output level to -100dBm.
- Turn on the transmitter.

- 11) Supply sufficient attenuation via the RF attenuator to provide an input level to the stored oscilloscope
- 12) that is 40 dB below the maximum allowed input power when the transmitter is operating at its rated power level. Note this power level on the stored oscilloscope as P_0 .
- 13) Turn off the transmitter.
- 14) Adjust the RF level of the signal generator to provide RF power equal to P_0 . This signal generator RF level shall be maintained throughout the rest of the measurement.
- 15) Remove the attenuation, so the input power to the stored oscilloscope is increased by 30 dB when the transmitter is turned on.
- 16) Adjust the vertical amplitude control of the stored oscilloscope to display the 1000 Hz at ± 4 divisions vertically centered on the display. Set trigger mode of the Spectrum Analyzer to "Video", and tune the "trigger level" on suitable level. Then set the "trigger offset" to -10ms for turn on and -15ms for turn off.
- 17) Turn on the transmitter and the transient wave will be captured on the screen of Spectrum Analyzer. Observe the stored display. The instant when the 1 kHz test signal is completely suppressed is considered to be t_1 . The trace should be maintained within the allowed divisions during the period t_1 and t_2 .
- 18) Then turn off the transmitter, and another transient wave will be captured on the screen of Spectrum
- 19) Analyzer. The trace should be maintained within the allowed divisions during the period t_3 .

TEST MODE

Please reference to the section 3.4

TEST RESULTS

Passed **Not Applicable**

Please refer to appendix H on the section 8 appendix report

5.9 Transmit Conducted Spurious Emission

LIMIT

FCC Part 90.210, FCC Part 2.1051

Emission Mask D—12.5 kHz channel bandwidth equipment. For transmitters designed to operate with a 12.5 kHz channel bandwidth, any emission must be attenuated below the power (P) of the highest emission contained within the authorized bandwidth as follows:

(3) On any frequency removed from the center of the authorized bandwidth by a displacement frequency (fd in kHz) of more than 12.5 kHz: At least 50 + 10 log (P) dB or 70 dB, whichever is the lesser attenuation.

In general, the worse case attenuation requirement shown above was applied.

Calculation: Limit (dBm) =EL-50-10log (P)

EL is the emission level of the Output Power expressed in dBm,

Limit (dBm) = P(dBm)-50-10 log (Pwatts) = -20dBm

TEST CONFIGURATION

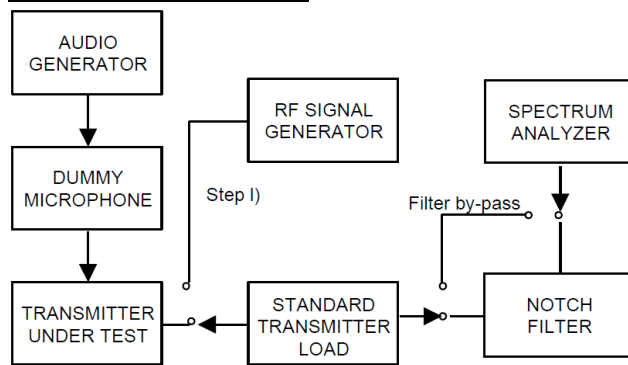

TEST PROCEDURE

1. Connect the equipment as illustrated, with the notch filter by-passed.
2. Apply Input Modulation Signal to EUT according to Section 3.4
3. Adjust the spectrum analyzer for the following settings:
 Below 1GHz: RBW=100kHz, VBW=300kHz
 Above 1GHz: RBW=1MHz, VBW=3MHz
 Detector=Peak, Sweep time=Auto, Trace=Max hold
4. Scan frequency range up to 10th harmonic.
5. Record the frequencies and levels of spurious emissions

TEST MODE

Please reference to the section 3.4

TEST RESULTS

Passed Not Applicable

Please refer to appendix I on the section 8 appendix report

5.10 Transmitter Radiated Spurious Emission

Radiated spurious emissions are emissions from the equipment when transmitting into a nonradiating load on a frequency or frequencies that are outside an occupied band sufficient to ensure transmission of information of required quality for the class of communications desired.

LIMIT

FCC Part 90.210, FCC Part 2.1051

Emission Mask D—12.5 kHz channel bandwidth equipment. For transmitters designed to operate with a 12.5 kHz channel bandwidth, any emission must be attenuated below the power (P) of the highest emission contained within the authorized bandwidth as follows:

(3) On any frequency removed from the center of the authorized bandwidth by a displacement frequency (fd in kHz) of more than 12.5 kHz: At least 50 + 10 log (P) dB or 70 dB, whichever is the lesser attenuation.

Emission Mask E—6.25 kHz or less channel bandwidth equipment. For transmitters designed to operate with a 6.25 kHz or less bandwidth, any emission must be attenuated below the power (P) of the highest emission contained within the authorized bandwidth as follows:

(3) On any frequency removed from the center of the authorized bandwidth by more than 4.6 kHz: At least 55 + 10 log (P) or 65 dB, whichever is the lesser attenuation.

In general, the worse case attenuation requirement shown above was applied.

Calculation: Limit (dBm) = EL - 50 - 10 log (P)

EL is the emission level of the Output Power expressed in dBm,

Limit (dBm) = P(dBm) - 50 - 10 log (Pwatts) = -20dBm

TEST CONFIGURATION

Below 1GHz:

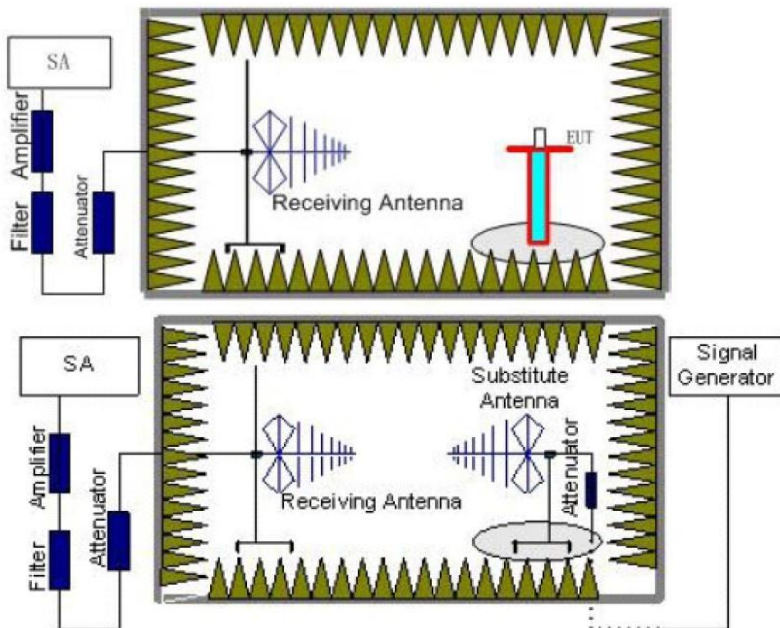

Above 1GHz:

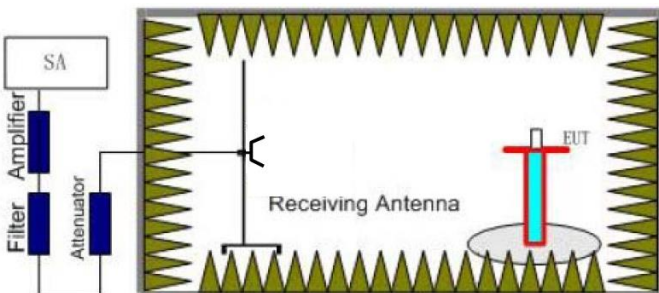

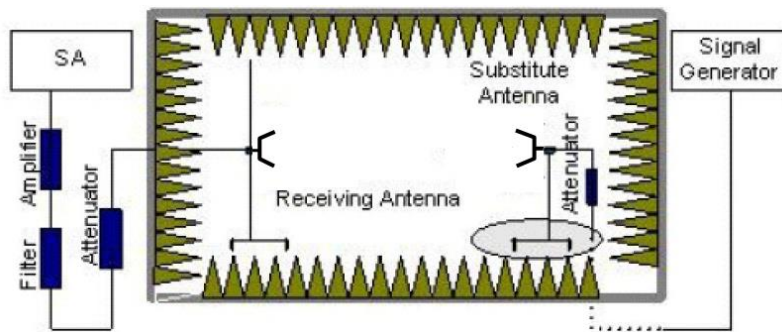

TEST PROCEDURE

1. Place the EUT in the center of the turntable.
 - a) For radiated emissions measurements performed at frequencies less than or equal to 1 GHz, the EUT shall be placed on a RF-transparent table at a nominal height of 80 cm above the reference ground plane
 - b) For radiated measurements performed at frequencies above 1 GHz, the EUT shall be placed on an RF transparent table at a nominal height of 1.5 m above the ground plane.
2. Unless the EUT uses an integral antenna, the EUT shall be terminated with a non-radiating transmitter load. In cases where the EUT uses an adjustable antenna, the antenna shall be adjusted through typical positions and lengths to maximize emissions levels.
3. The EUT shall be tested while operating on the frequency per manufacturer specification. Set the transmitter to operate in continuous transmit mode.
4. Receiver or Spectrum set as follow:
Below 1GHz, RBW=100kHz, VBW=300kHz, Detector=Peak, Sweep time=Auto
Above 1GHz, RBW=1MHz, VBW=3MHz, Detector=Peck, Sweep time=Auto
5. Each emission under consideration shall be evaluated:
 - a) Raise and lower the measurement antenna from 1 m to 4 m, as necessary to enable detection of the maximum emission amplitude relative to measurement antenna height.
 - b) Rotate the EUT through 360° to determine the maximum emission level relative to the axial position.
 - c) Return the turntable to the azimuth where the highest emission amplitude level was observed.
 - d) Vary the measurement antenna height again through 1 m to 4 m again to find the height associated with the maximum emission amplitude.
 - e) Record the measured emission amplitude level and frequency
6. Repeat step 5 for each emission frequency with the measurement antenna oriented in both the horizontal and vertical polarizations to determine the orientation that gives the maximum emissions amplitude.
7. Set-up the substitution measurement with the reference point of the substitution antenna located as near as possible to where the center of the EUT radiating element was located during the initial EUT measurement.
8. Maintain the previous measurement instrument settings and test set-up, with the exception that the EUT is removed and replaced by the substitution antenna.
9. Connect a signal generator to the substitution antenna; locate the signal generator so as to minimize any potential influences on the measurement results. Set the signal generator to the frequency where emissions are detected, and set an output power level such that the radiated signal can be detected by the measurement instrument, with sufficient dynamic range relative to the noise floor.
10. For each emission that was detected and measured in the initial test
 - a) Vary the measurement antenna height between 1 m to 4 m to maximize the received (measured) signal amplitude.
 - b) Adjust the signal generator output power level until the amplitude detected by the measurement instrument equals the amplitude level of the emission previously measured directly in step 5 and step 6.
 - c) Record the output power level of the signal generator when equivalence is achieved in step b).
11. Repeat step 8 through step 10 with the measurement antenna oriented in the opposite polarization.
12. Calculate the emission power in dBm referenced to a half-wave dipole using the following equation:

$$P_e = P_s(\text{dBm}) - \text{cable loss (dB)} + \text{antenna gain (dBd)}$$
 where
 P_e = equivalent emission power in dBm
 P_s = source (signal generator) power in dBm
 NOTE—dBd refers to the measured antenna gain in decibels relative to a half-wave dipole.
13. Correct the antenna gain of the substitution antenna if necessary to reference the emission power to a half-wave dipole. When using measurement antennas with the gain specified in dBi, the equivalent dipole-referenced gain can be determined from:

$$\text{gain (dBd)} = \text{gain (dBi)} - 2.15 \text{ dB.}$$

If necessary, the antenna gain can be calculated from calibrated antenna factor information
14. Provide the complete measurement results as a part of the test report.

TEST MODE

Please reference to the section 3.4

TEST RESULTS

Passed **Not Applicable**

TEST MODE	TX-DNH	Test Channel:	CH _L	Polarity:	Horizontal
-----------	--------	---------------	-----------------	-----------	------------

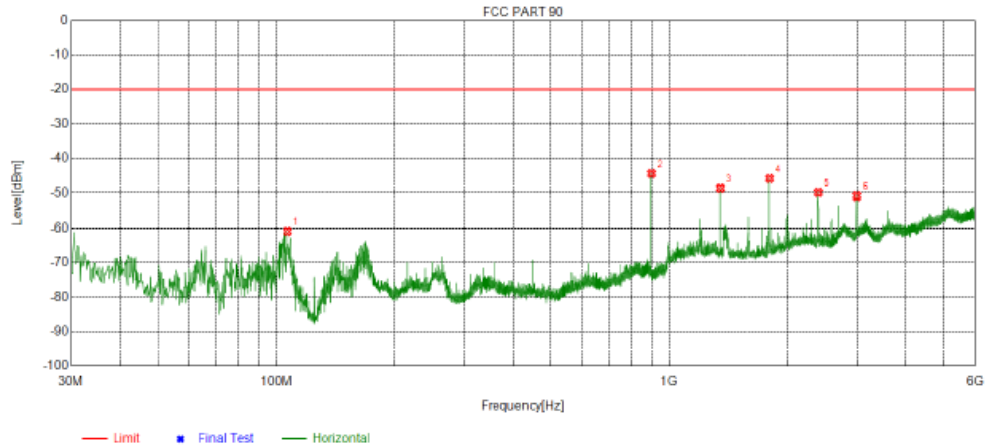

NO.	Freq. [MHz]	Reading [dBm]	Factor [dB]	Level [dBm]	Limit [dBm]	Margin [dB]	Polarity	Detector
1	106.7513	-54.48	-6.34	-60.82	-20.00	40.82	Horizontal	PK
2	900.0900	-54.19	9.75	-44.44	-20.00	24.44	Horizontal	PK
3	1350.000	-54.11	5.43	-48.68	-20.00	28.68	Horizontal	PK
4	1800.000	-51.42	5.52	-45.90	-20.00	25.90	Horizontal	PK
5	2392.500	-59.65	9.81	-49.84	-20.00	29.84	Horizontal	PK
6	2998.750	-63.09	12.33	-50.76	-20.00	30.76	Horizontal	PK

TEST MODE	TX-DNH	Test Channel:	CH _L	Polarity:	Vertical
-----------	--------	---------------	-----------------	-----------	----------

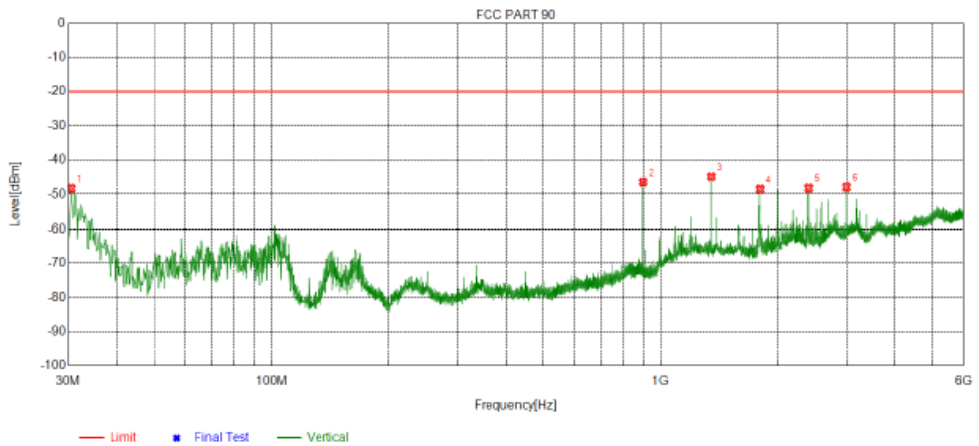

NO.	Freq. [MHz]	Reading [dBm]	Factor [dB]	Level [dBm]	Limit [dBm]	Margin [dB]	Polarity	Detector
1	30.6063	-44.67	-3.73	-48.40	-20.00	28.40	Vertical	PK
2	900.0900	-56.85	10.22	-46.63	-20.00	26.63	Vertical	PK
3	1350.000	-50.92	5.92	-45.00	-20.00	25.00	Vertical	PK
4	1800.000	-53.89	5.27	-48.62	-20.00	28.62	Vertical	PK
5	2397.500	-57.61	9.32	-48.29	-20.00	28.29	Vertical	PK
6	3000.625	-60.33	12.30	-48.03	-20.00	28.03	Vertical	PK

TEST MODE	TX-DNH	Test Channel:	CH _{M1}	Polarity:	Horizontal
-----------	--------	---------------	------------------	-----------	------------

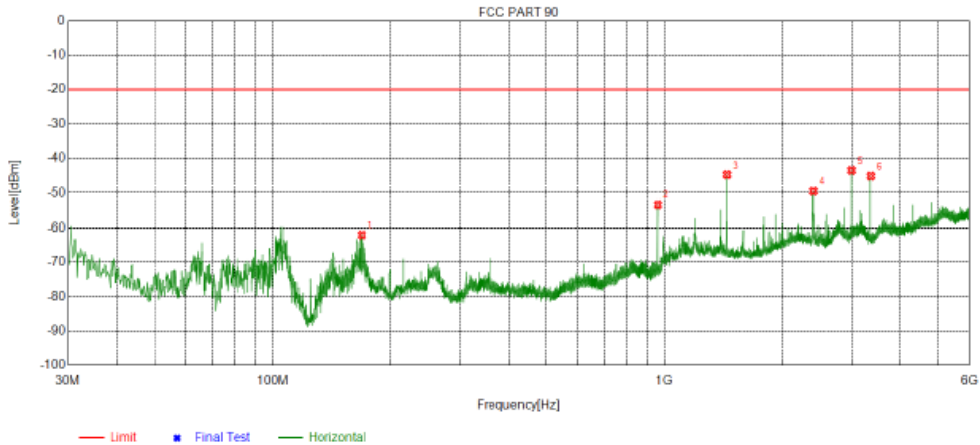

NO.	Freq. [MHz]	Reading [dBm]	Factor [dB]	Level [dBm]	Limit [dBm]	Margin [dB]	Polarity	Detector
1	168.8313	-60.43	-1.52	-61.95	-20.00	41.95	Horizontal	PK
2	962.1700	-63.74	10.57	-53.17	-20.00	33.17	Horizontal	PK
3	1443.125	-50.28	5.43	-44.85	-20.00	24.85	Horizontal	PK
4	2396.250	-59.31	9.81	-49.50	-20.00	29.50	Horizontal	PK
5	3000.000	-55.92	12.32	-43.60	-20.00	23.60	Horizontal	PK
6	3366.875	-56.73	11.46	-45.27	-20.00	25.27	Horizontal	PK

TEST MODE	TX-DNH	Test Channel:	CH _{M1}	Polarity:	Vertical
-----------	--------	---------------	------------------	-----------	----------

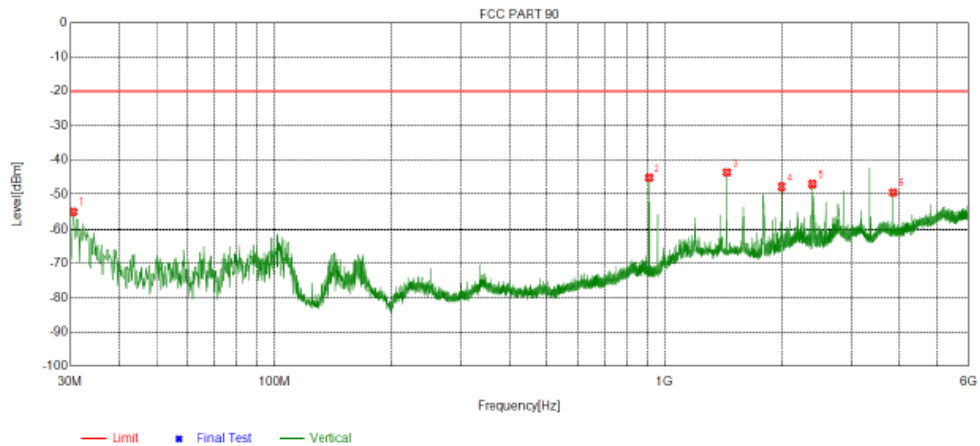

NO.	Freq. [MHz]	Reading [dBm]	Factor [dB]	Level [dBm]	Limit [dBm]	Margin [dB]	Polarity	Detector
1	30.6063	-51.08	-3.73	-54.81	-20.00	34.81	Vertical	PK
2	911.3663	-55.28	9.96	-45.32	-20.00	25.32	Vertical	PK
3	1443.125	-50.04	6.30	-43.74	-20.00	23.74	Vertical	PK
4	1994.375	-55.16	7.25	-47.91	-20.00	27.91	Vertical	PK
5	2388.750	-56.51	9.39	-47.12	-20.00	27.12	Vertical	PK
6	3848.125	-64.08	14.57	-49.51	-20.00	29.51	Vertical	PK

TEST MODE	TX-DNH	Test Channel:	CH _{M2}	Polarity:	Horizontal
-----------	--------	---------------	------------------	-----------	------------

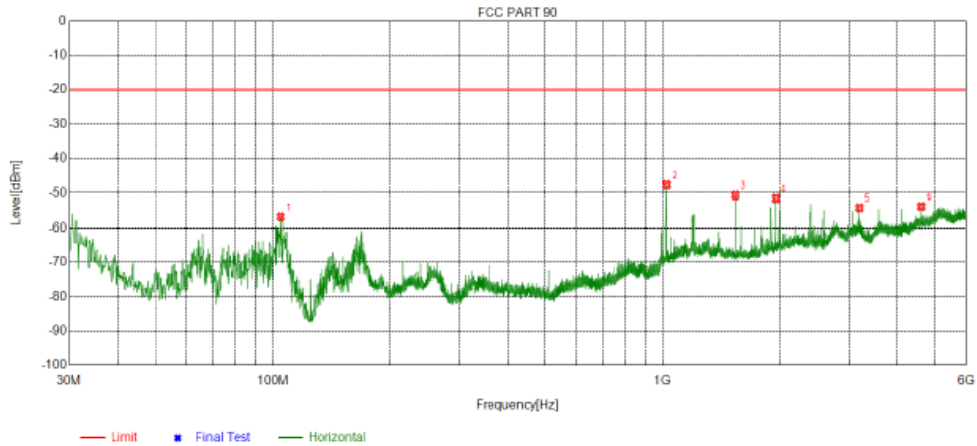

NO.	Freq. [MHz]	Reading [dBm]	Factor [dB]	Level [dBm]	Limit [dBm]	Margin [dB]	Polarity	Detector
1	104.6900	-50.38	-6.28	-56.66	-20.00	36.66	Horizontal	PK
2	1023.750	-48.66	0.98	-47.68	-20.00	27.68	Horizontal	PK
3	1535.625	-55.57	4.99	-50.58	-20.00	30.58	Horizontal	PK
4	1948.750	-58.89	7.45	-51.44	-20.00	31.44	Horizontal	PK
5	3192.500	-67.44	13.36	-54.08	-20.00	34.08	Horizontal	PK
6	4608.125	-72.03	18.36	-53.67	-20.00	33.67	Horizontal	PK

TEST MODE	TX-DNH	Test Channel:	CH _{M2}	Polarity:	Vertical
-----------	--------	---------------	------------------	-----------	----------

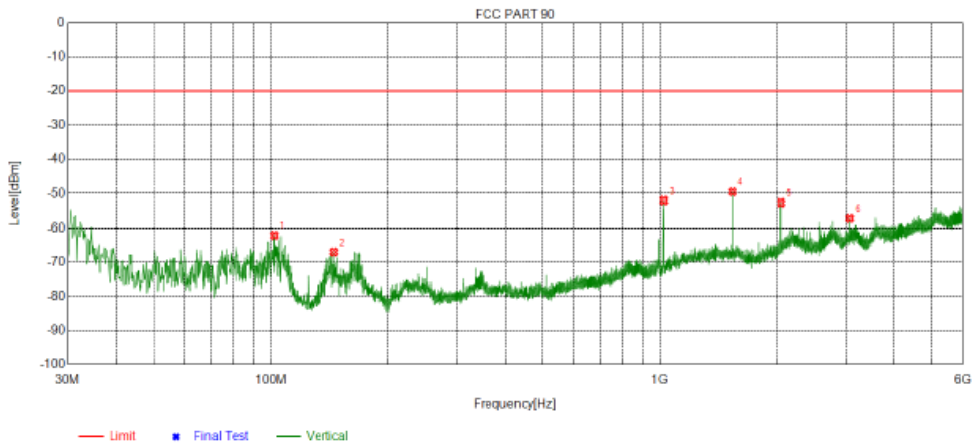

NO.	Freq. [MHz]	Reading [dBm]	Factor [dB]	Level [dBm]	Limit [dBm]	Margin [dB]	Polarity	Detector
1	101.9013	-62.99	1.01	-61.98	-20.00	41.98	Vertical	PK
2	145.1875	-65.05	-1.88	-66.93	-20.00	46.93	Vertical	PK
3	1023.750	-52.57	0.66	-51.91	-20.00	31.91	Vertical	PK
4	1535.625	-55.89	6.42	-49.47	-20.00	29.47	Vertical	PK
5	2048.125	-60.85	8.29	-52.56	-20.00	32.56	Vertical	PK
6	3071.875	-69.66	12.64	-57.02	-20.00	37.02	Vertical	PK

TEST MODE	TX-DNH	Test Channel:	CH _{M3}	Polarity:	Horizontal
-----------	--------	---------------	------------------	-----------	------------

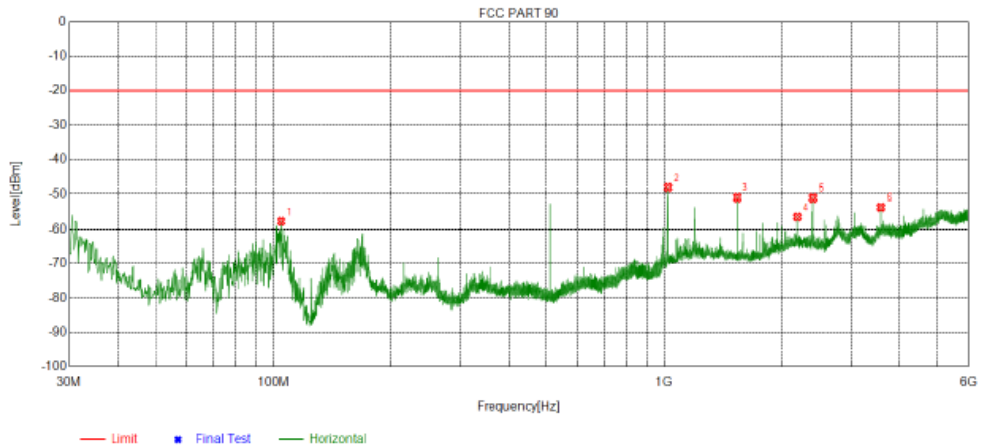

NO.	Freq. [MHz]	Reading [dBm]	Factor [dB]	Level [dBm]	Limit [dBm]	Margin [dB]	Polarity	Detector
1	104.6900	-51.35	-6.28	-57.63	-20.00	37.63	Horizontal	PK
2	1023.750	-49.12	0.98	-48.14	-20.00	28.14	Horizontal	PK
3	1535.625	-55.90	4.99	-50.91	-20.00	30.91	Horizontal	PK
4	2192.500	-66.75	10.41	-56.34	-20.00	36.34	Horizontal	PK
5	2398.125	-60.82	9.80	-51.02	-20.00	31.02	Horizontal	PK
6	3584.375	-67.86	14.31	-53.55	-20.00	33.55	Horizontal	PK

TEST MODE	TX-DNH	Test Channel:	CH _{M3}	Polarity:	Vertical
-----------	--------	---------------	------------------	-----------	----------

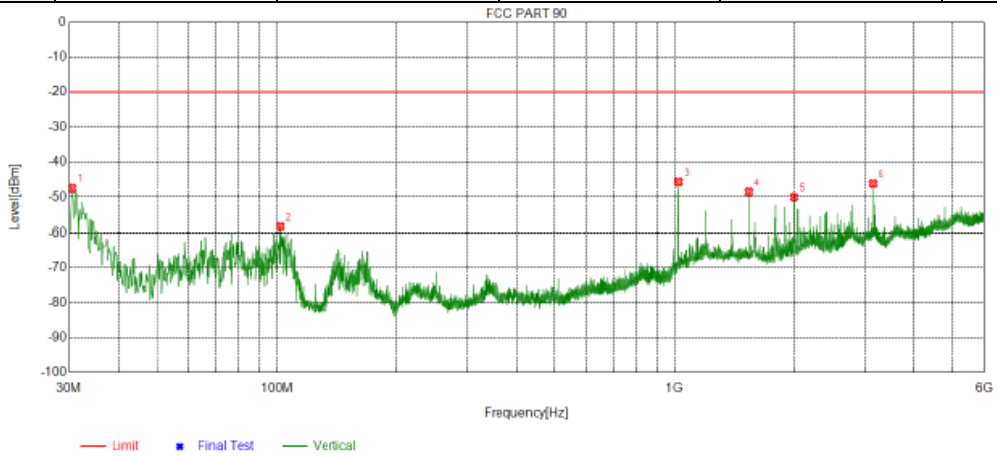

NO.	Freq. [MHz]	Reading [dBm]	Factor [dB]	Level [dBm]	Limit [dBm]	Margin [dB]	Polarity	Detector
1	30.6063	-43.85	-3.73	-47.58	-20.00	27.58	Vertical	PK
2	101.9013	-59.13	1.01	-58.12	-20.00	38.12	Vertical	PK
3	1023.750	-46.46	0.66	-45.80	-20.00	25.80	Vertical	PK
4	1535.625	-55.02	6.42	-48.60	-20.00	28.60	Vertical	PK
5	1996.250	-57.32	7.27	-50.05	-20.00	30.05	Vertical	PK
6	3148.750	-59.41	13.14	-46.27	-20.00	26.27	Vertical	PK

TEST MODE	TX-DNH	Test Channel:	CH _H	Polarity:	Horizontal
-----------	--------	---------------	-----------------	-----------	------------

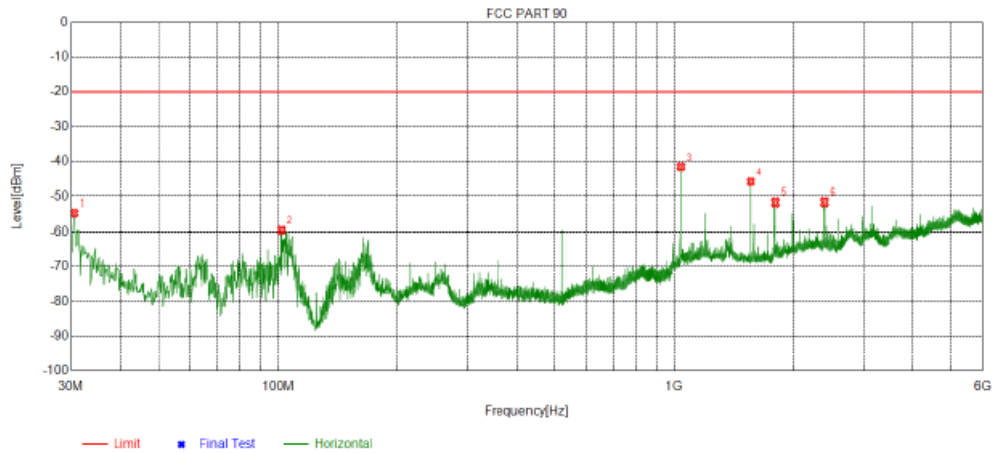

NO.	Freq. [MHz]	Reading [dBm]	Factor [dB]	Level [dBm]	Limit [dBm]	Margin [dB]	Polarity	Detector
1	30.6063	-58.95	4.44	-54.51	-20.00	34.51	Horizontal	PK
2	101.9013	-53.22	-6.20	-59.42	-20.00	39.42	Horizontal	PK
3	1040.000	-42.92	1.34	-41.58	-20.00	21.58	Horizontal	PK
4	1560.000	-50.81	4.91	-45.90	-20.00	25.90	Horizontal	PK
5	1799.375	-57.14	5.52	-51.62	-20.00	31.62	Horizontal	PK
6	2391.250	-61.35	9.81	-51.54	-20.00	31.54	Horizontal	PK

TEST MODE	TX-DNH	Test Channel:	CH _H	Polarity:	Vertical
-----------	--------	---------------	-----------------	-----------	----------

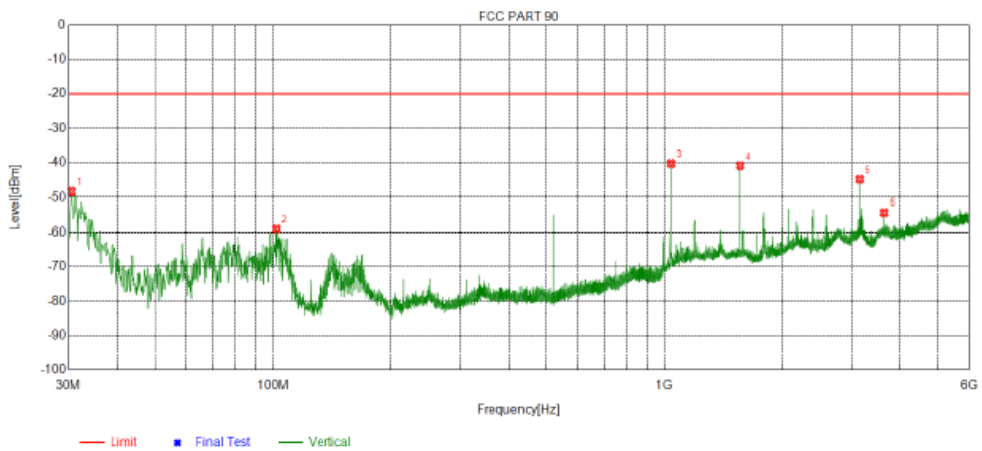

NO.	Freq. [MHz]	Reading [dBm]	Factor [dB]	Level [dBm]	Limit [dBm]	Margin [dB]	Polarity	Detector
1	30.6063	-44.67	-3.73	-48.40	-20.00	28.40	Vertical	PK
2	101.9013	-59.92	1.01	-58.91	-20.00	38.91	Vertical	PK
3	1040.000	-41.34	1.07	-40.27	-20.00	20.27	Vertical	PK
4	1560.000	-47.41	6.48	-40.93	-20.00	20.93	Vertical	PK
5	3149.375	-58.07	13.14	-44.93	-20.00	24.93	Vertical	PK
6	3640.000	-68.91	14.71	-54.20	-20.00	34.20	Vertical	PK

TEST MODE	TX-ANH	Test Channel:	CH _L	Polarity:	Horizontal
-----------	--------	---------------	-----------------	-----------	------------

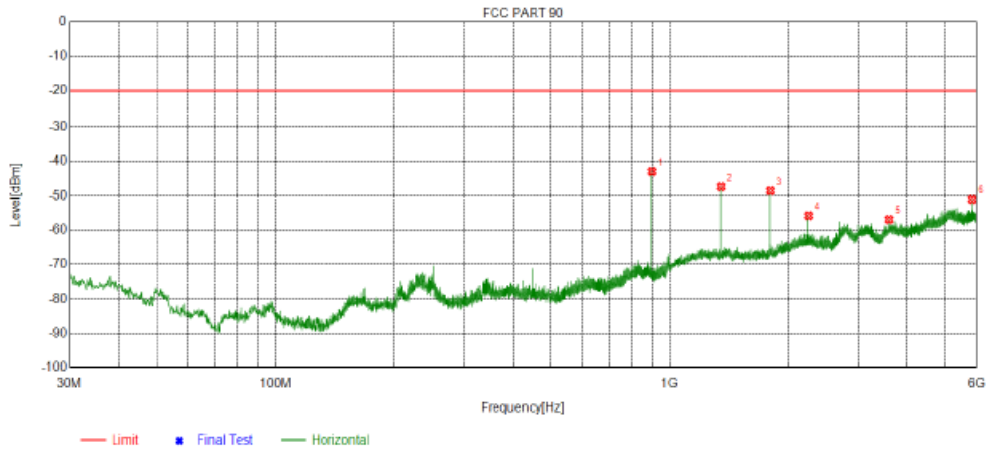

NO.	Freq. [MHz]	Reading [dBm]	Factor [dB]	Level [dBm]	Limit [dBm]	Margin [dB]	Polarity	Detector
1	900.0900	-52.71	9.75	-42.96	-20.00	22.96	Horizontal	PK
2	1350.000	-52.87	5.43	-47.44	-20.00	27.44	Horizontal	PK
3	1800.000	-54.13	5.52	-48.61	-20.00	28.61	Horizontal	PK
4	2250.000	-66.08	10.23	-55.85	-20.00	35.85	Horizontal	PK
5	3600.000	-71.51	14.54	-56.97	-20.00	36.97	Horizontal	PK
6	5850.000	-72.84	21.71	-51.13	-20.00	31.13	Horizontal	PK

TEST MODE	TX-ANH	Test Channel:	CH _L	Polarity:	Vertical
-----------	--------	---------------	-----------------	-----------	----------

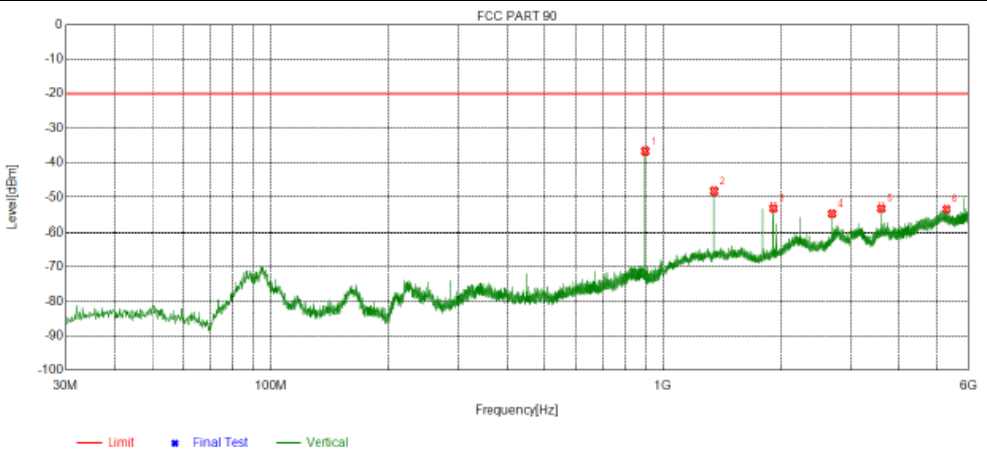

NO.	Freq. [MHz]	Reading [dBm]	Factor [dB]	Level [dBm]	Limit [dBm]	Margin [dB]	Polarity	Detector
1	900.0900	-46.93	10.22	-36.71	-20.00	16.71	Vertical	PK
2	1350.000	-54.22	5.92	-48.30	-20.00	28.30	Vertical	PK
3	1908.125	-59.21	6.36	-52.85	-20.00	32.85	Vertical	PK
4	2700.000	-66.87	12.42	-54.45	-20.00	34.45	Vertical	PK
5	3600.625	-67.68	14.77	-52.91	-20.00	32.91	Vertical	PK
6	5275.625	-74.36	21.23	-53.13	-20.00	33.13	Vertical	PK

TEST MODE	TX-ANH	Test Channel:	CH _{M1}	Polarity:	Horizontal
-----------	--------	---------------	------------------	-----------	------------

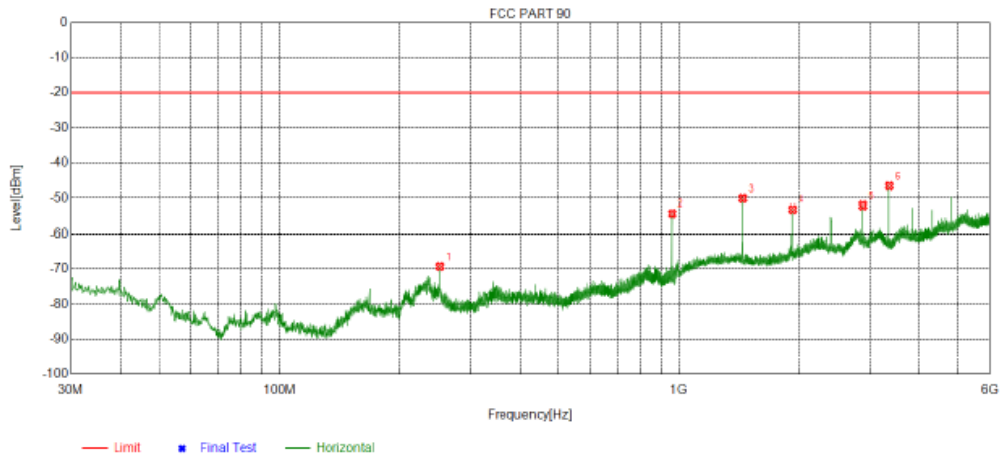

NO.	Freq. [MHz]	Reading [dBm]	Factor [dB]	Level [dBm]	Limit [dBm]	Margin [dB]	Polarity	Detector
1	252.0088	-69.97	0.71	-69.26	-20.00	49.26	Horizontal	PK
2	962.1700	-64.70	10.57	-54.13	-20.00	34.13	Horizontal	PK
3	1443.125	-55.50	5.43	-50.07	-20.00	30.07	Horizontal	PK
4	1923.750	-60.09	7.13	-52.96	-20.00	32.96	Horizontal	PK
5	2886.250	-65.05	13.11	-51.94	-20.00	31.94	Horizontal	PK
6	3367.500	-58.09	11.45	-46.64	-20.00	26.64	Horizontal	PK

TEST MODE	TX-ANH	Test Channel:	CH _{M1}	Polarity:	Vertical
-----------	--------	---------------	------------------	-----------	----------

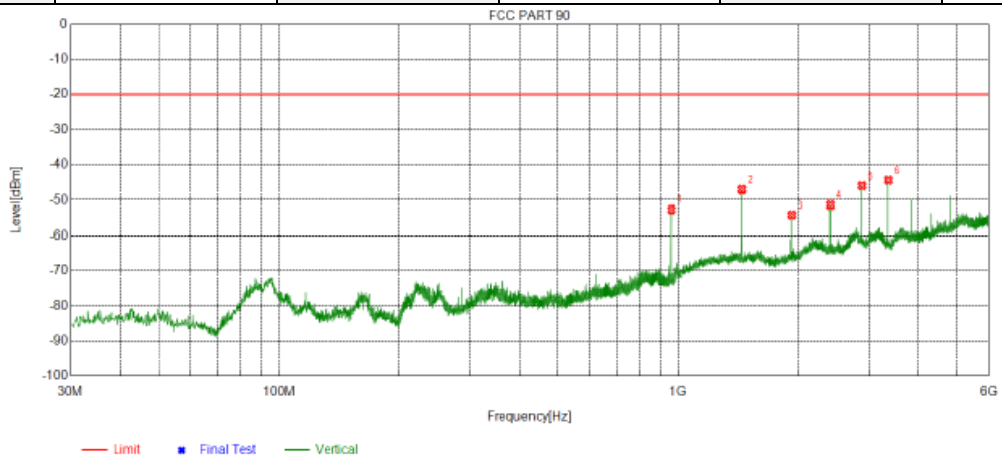

NO.	Freq. [MHz]	Reading [dBm]	Factor [dB]	Level [dBm]	Limit [dBm]	Margin [dB]	Polarity	Detector
1	962.1700	-62.93	10.35	-52.58	-20.00	32.58	Vertical	PK
2	1443.125	-53.42	6.30	-47.12	-20.00	27.12	Vertical	PK
3	1923.750	-60.56	6.52	-54.04	-20.00	34.04	Vertical	PK
4	2405.000	-60.63	9.33	-51.30	-20.00	31.30	Vertical	PK
5	2886.250	-59.19	13.07	-46.12	-20.00	26.12	Vertical	PK
6	3366.875	-55.97	11.47	-44.50	-20.00	24.50	Vertical	PK

TEST MODE	TX-ANH	Test Channel:	CH _{M2}	Polarity:	Horizontal
-----------	--------	---------------	------------------	-----------	------------

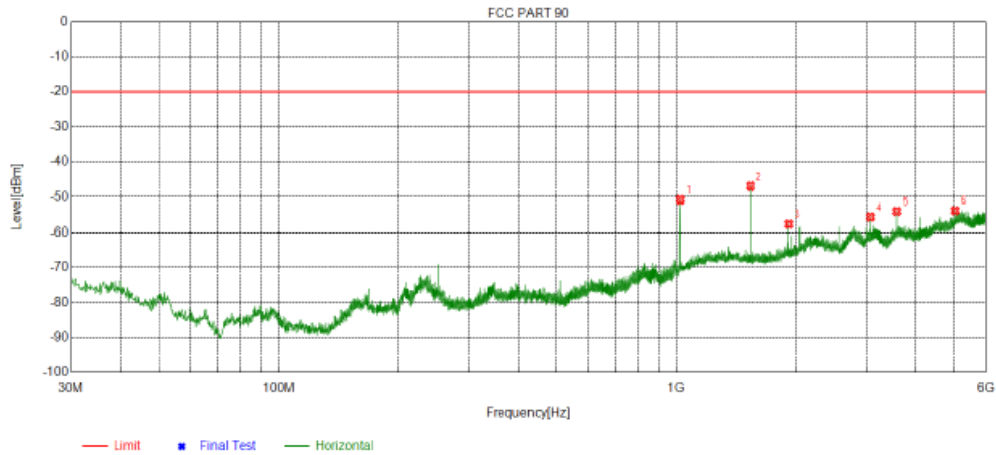

NO.	Freq. [MHz]	Reading [dBm]	Factor [dB]	Level [dBm]	Limit [dBm]	Margin [dB]	Polarity	Detector
1	1023.750	-51.68	0.98	-50.70	-20.00	30.70	Horizontal	PK
2	1535.625	-51.97	4.99	-46.98	-20.00	26.98	Horizontal	PK
3	1914.375	-64.47	7.01	-57.46	-20.00	37.46	Horizontal	PK
4	3072.500	-68.08	12.62	-55.46	-20.00	35.46	Horizontal	PK
5	3583.750	-68.17	14.30	-53.87	-20.00	33.87	Horizontal	PK
6	5016.875	-74.45	20.77	-53.68	-20.00	33.68	Horizontal	PK

TEST MODE	TX-ANH	Test Channel:	CH _{M2}	Polarity:	Vertical
-----------	--------	---------------	------------------	-----------	----------

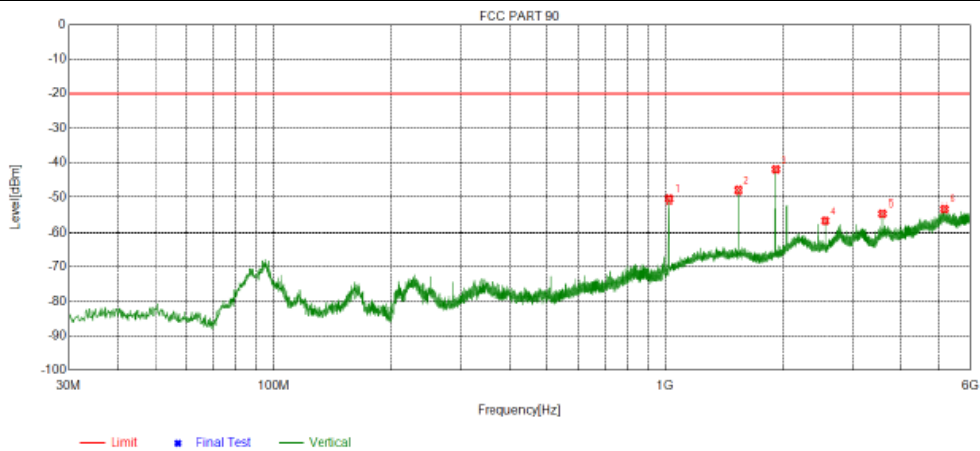

NO.	Freq. [MHz]	Reading [dBm]	Factor [dB]	Level [dBm]	Limit [dBm]	Margin [dB]	Polarity	Detector
1	1023.750	-51.12	0.66	-50.46	-20.00	30.46	Vertical	PK
2	1535.625	-54.46	6.42	-48.04	-20.00	28.04	Vertical	PK
3	1912.500	-48.41	6.41	-42.00	-20.00	22.00	Vertical	PK
4	2560.000	-66.53	9.98	-56.55	-20.00	36.55	Vertical	PK
5	3583.750	-68.98	14.51	-54.47	-20.00	34.47	Vertical	PK
6	5149.375	-74.33	21.25	-53.08	-20.00	33.08	Vertical	PK

TEST MODE	TX-ANH	Test Channel:	CH _{M3}	Polarity:	Horizontal
-----------	--------	---------------	------------------	-----------	------------

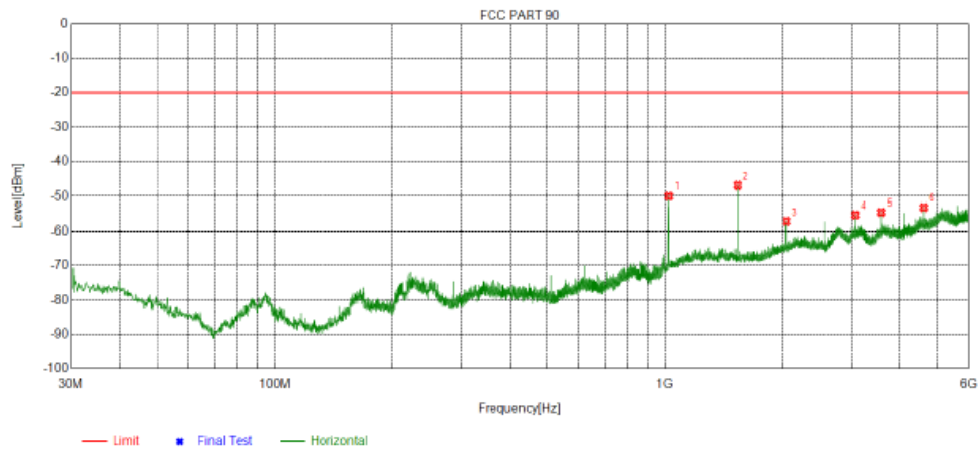

NO.	Freq. [MHz]	Reading [dBm]	Factor [dB]	Level [dBm]	Limit [dBm]	Margin [dB]	Polarity	Detector
1	1023.750	-50.94	0.98	-49.96	-20.00	29.96	Horizontal	PK
2	1535.625	-51.94	4.99	-46.95	-20.00	26.95	Horizontal	PK
3	2048.125	-65.78	8.71	-57.07	-20.00	37.07	Horizontal	PK
4	3071.875	-67.89	12.61	-55.28	-20.00	35.28	Horizontal	PK
5	3584.375	-68.83	14.31	-54.52	-20.00	34.52	Horizontal	PK
6	4608.125	-71.47	18.36	-53.11	-20.00	33.11	Horizontal	PK

TEST MODE	TX-ANH	Test Channel:	CH _{M3}	Polarity:	Vertical
-----------	--------	---------------	------------------	-----------	----------

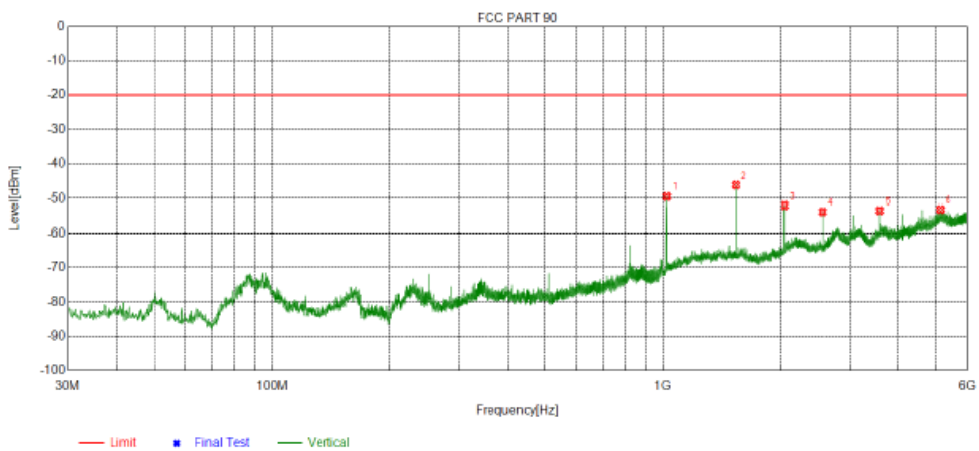

NO.	Freq. [MHz]	Reading [dBm]	Factor [dB]	Level [dBm]	Limit [dBm]	Margin [dB]	Polarity	Detector
1	1023.750	-50.08	0.66	-49.42	-20.00	29.42	Vertical	PK
2	1535.625	-52.69	6.42	-46.27	-20.00	26.27	Vertical	PK
3	2048.125	-60.23	8.29	-51.94	-20.00	31.94	Vertical	PK
4	2560.000	-63.71	9.98	-53.73	-20.00	33.73	Vertical	PK
5	3584.375	-67.90	14.52	-53.38	-20.00	33.38	Vertical	PK
6	5120.625	-74.24	21.17	-53.07	-20.00	33.07	Vertical	PK

TEST MODE	TX-ANH	Test Channel:	CH _H	Polarity:	Horizontal
-----------	--------	---------------	-----------------	-----------	------------

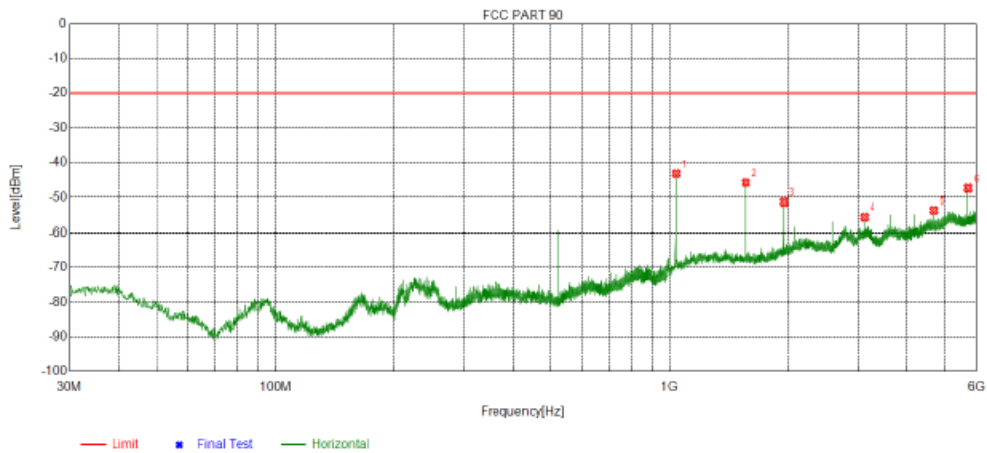

NO.	Freq. [MHz]	Reading [dBm]	Factor [dB]	Level [dBm]	Limit [dBm]	Margin [dB]	Polarity	Detector
1	1040.000	-44.57	1.34	-43.23	-20.00	23.23	Horizontal	PK
2	1560.000	-50.80	4.91	-45.89	-20.00	25.89	Horizontal	PK
3	1946.875	-58.61	7.42	-51.19	-20.00	31.19	Horizontal	PK
4	3120.000	-68.27	12.87	-55.40	-20.00	35.40	Horizontal	PK
5	4680.625	-72.11	18.66	-53.45	-20.00	33.45	Horizontal	PK
6	5720.000	-68.55	21.15	-47.40	-20.00	27.40	Horizontal	PK

TEST MODE	TX-ANH	Test Channel:	CH _H	Polarity:	Vertical
-----------	--------	---------------	-----------------	-----------	----------

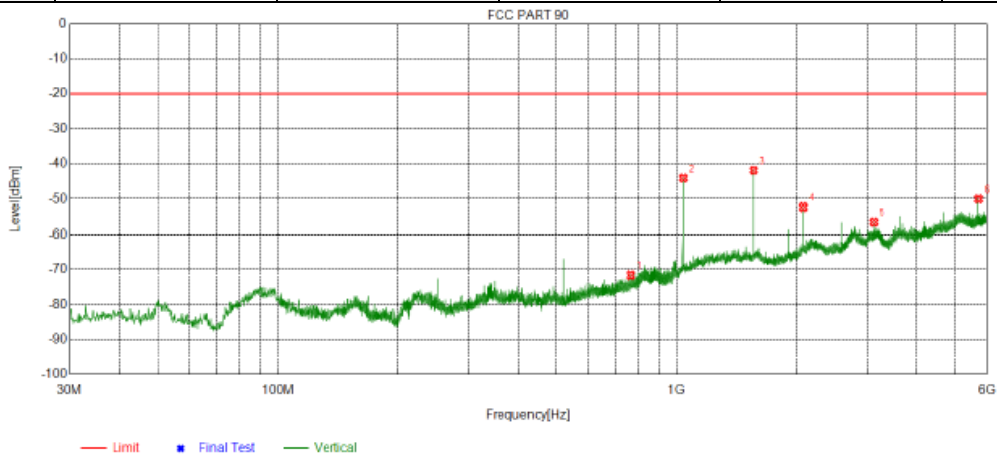

NO.	Freq. [MHz]	Reading [dBm]	Factor [dB]	Level [dBm]	Limit [dBm]	Margin [dB]	Polarity	Detector
1	767.6850	-79.37	7.83	-71.54	-20.00	51.54	Vertical	PK
2	1040.000	-45.23	1.07	-44.16	-20.00	24.16	Vertical	PK
3	1560.000	-48.40	6.48	-41.92	-20.00	21.92	Vertical	PK
4	2080.000	-61.13	8.94	-52.19	-20.00	32.19	Vertical	PK
5	3120.000	-69.28	12.92	-56.36	-20.00	36.36	Vertical	PK
6	5720.000	-71.31	21.31	-50.00	-20.00	30.00	Vertical	PK

5.11 AC Power Line Conducted Emission

The frequency spectrum from 0.15 MHz to 30 MHz was investigated. The LISN used was 50 ohm / 50 u Henry as specified by section 5.1 of ANSI C63.4. Cables and peripherals were moved to find the maximum emission levels for each frequency.

Limit

FCC part 15.107(a)

Frequency of emission (MHz)	Conducted limit (dBµV)	
	Quasi-peak	Average
0.15-0.5	66 to 56*	56 to 46*
0.5-5	56	46
5-30	60	50

TEST CONFIGURATION

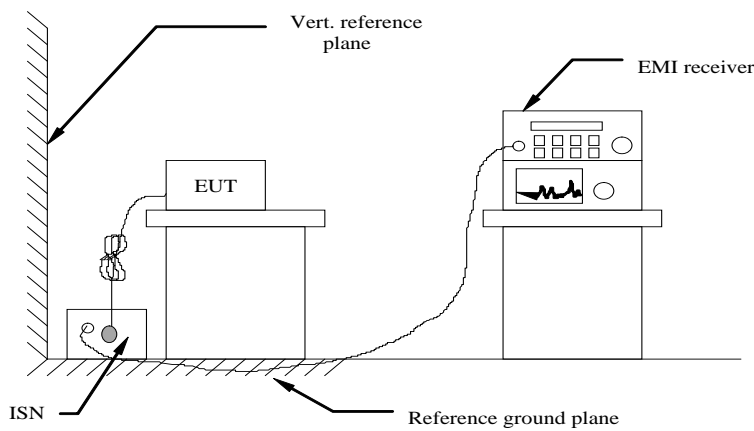

TEST PROCEDURE

- 1 The equipment was set up as per the test configuration to simulate typical actual usage per the user's manual. The EUT is a tabletop system; a wooden table with a height of 0.8 meters is used and is placed on the ground plane as per ANSI C63.4
- 2 Support equipment, if needed, was placed as per ANSI C63.4
- 3 All I/O cables were positioned to simulate typical actual usage as per ANSI C63.4.
- 4 If a EUT received AC120V/60Hz power through a Line Impedance Stabilization Network (LISN) which supplied power source and was grounded to the ground plane.
- 5 All support equipments received AC power from a second LISN, if any
- 6 The EUT test program was started. Emissions were measured on each current carrying line of the EUT using a spectrum Analyzer / Receiver connected to the LISN powering the EUT. The LISN has two monitoring points: Line 1 (Hot Side) and Line 2 (Neutral Side). Two scans were taken: one with Line 1 connected to Analyzer / Receiver and Line 2 connected to a 50 ohm load; the second scan had Line 1 connected to a 50 ohm load and Line 2 connected to the Analyzer / Receiver.
- 7 Analyzer / Receiver scanned from 150 kHz to 30MHz for emissions in each of the test modes.
- 8 During the above scans, the emissions were maximized by cable manipulation.

TEST MODE

Please reference to the section 3.4

TEST RESULTS

Passed Not Applicable

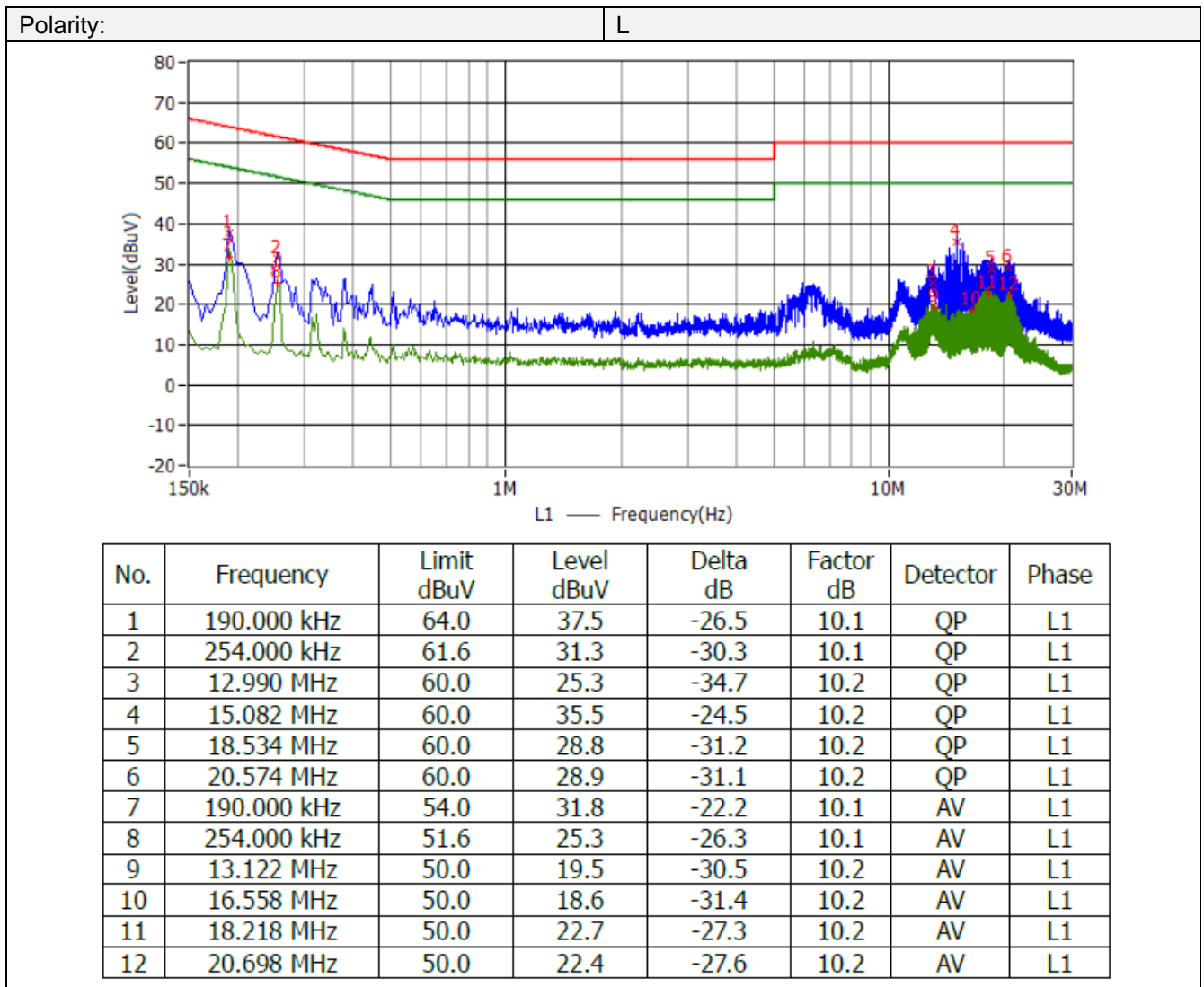

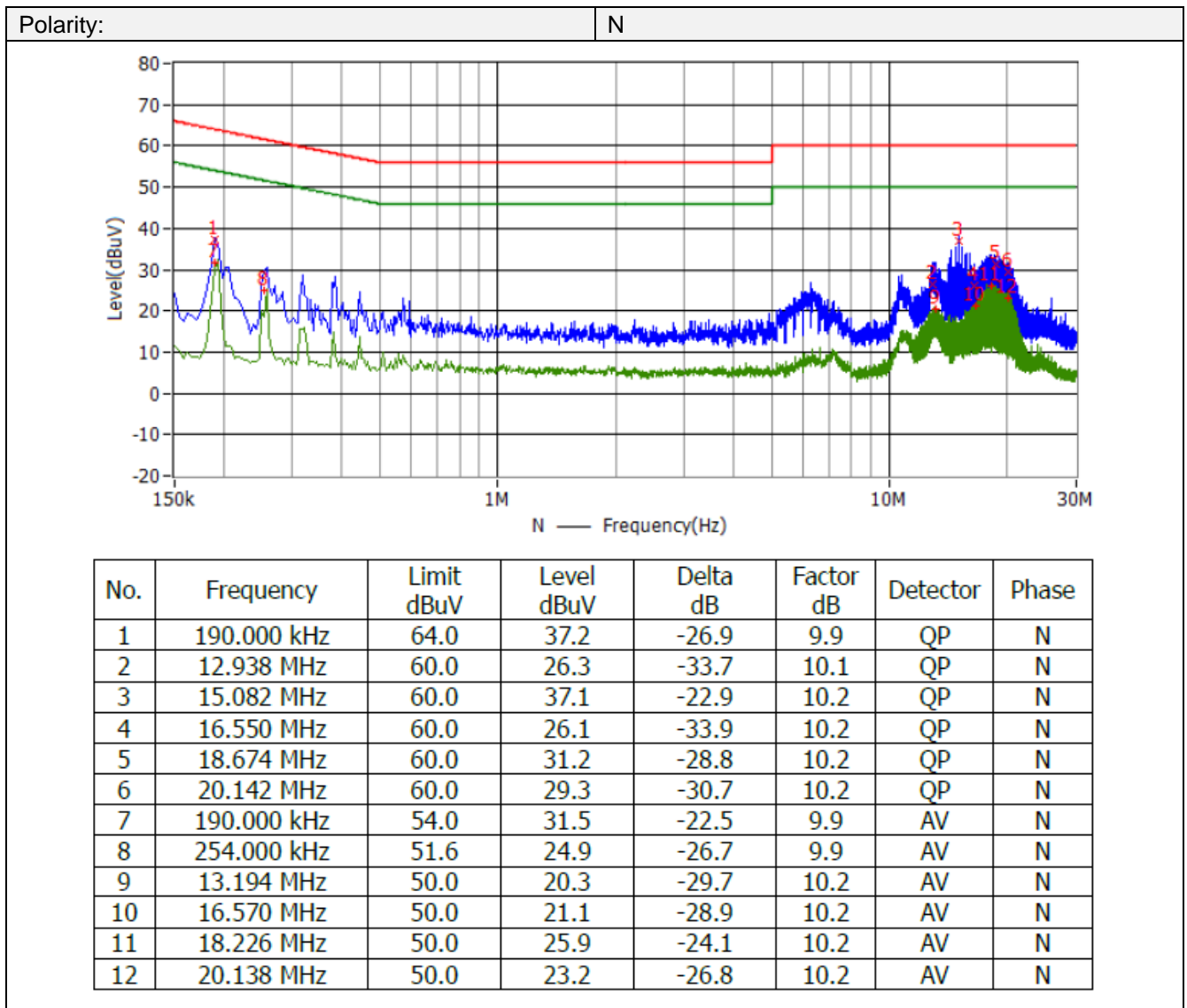

5.12 Radiated Emission

LIMIT

For unintentional device, according to § 15.109(a) except for Class A digital devices, the field strength of radiated emissions from unintentional radiators at a distance of 3 meters shall not exceed the following values:

Frequency of emission (MHz)	Field strength (microvolts/meter)
30-88	100
88-216	150
216-960	200
Above 960	500

For intentional device, according to § 15.209(a), the general requirement of field strength of radiated emissions from intentional radiators at a distance of 3 meters shall not exceed the above table.

TEST CONFIGURATION

(A) Radiated Emission Test Set-Up, Frequency below 1000MHz

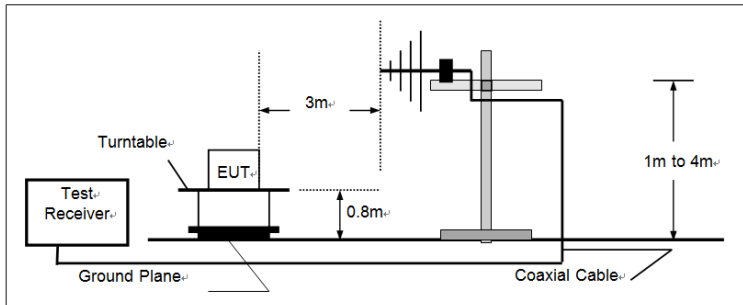

(B) Radiated Emission Test Set-Up, Frequency above 1000MHz

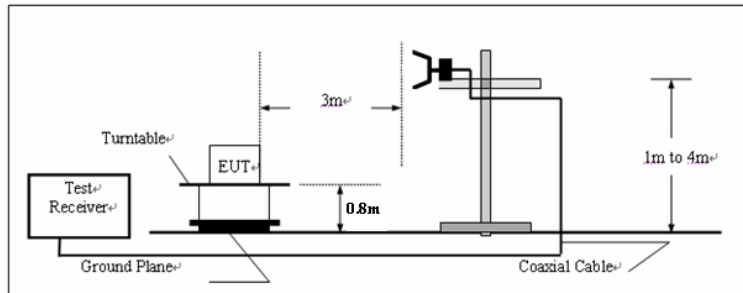

TEST PROCEDURE

- 1 The EUT was placed on a turn table which is 0.8m above ground plane.
- 2 Maximum procedure was performed by raising the receiving antenna from 1m to 4m and rotating the turn table from 0° to 360° to acquire the highest emissions from EUT
- 3 And also, each emission was to be maximized by changing the polarization of receiving antenna both horizontal and vertical.
- 4 Repeat above procedures until all frequency measurements have been completed.

TEST MODE

Please reference to the section 3.4

TEST RESULTS

Passed Not Applicable

Note:

The EUT shall be scanned from 30 MHz to the 5th harmonic of the highest oscillator frequency in the digital devices or 1 GHz whichever is higher.

AC

Polarity: Horizontal

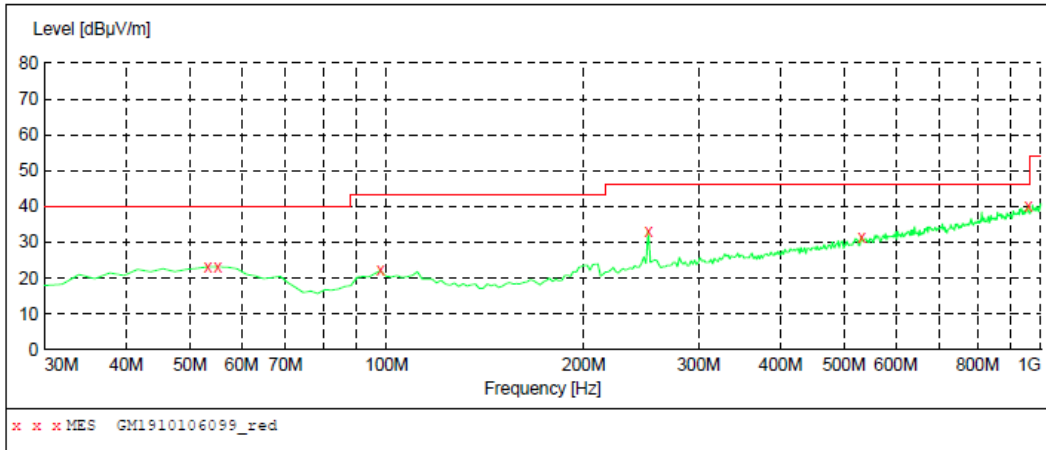

MEASUREMENT RESULT: "GM1910106099_red"

10/10/2019 8:46PM

Frequency MHz	Level dBµV/m	Transd dB	Limit dBµV/m	Margin dB	Det.	Height cm	Azimuth deg	Polarization
53.280000	23.20	-4.6	40.0	16.8	QP	300.0	354.00	HORIZONTAL
55.220000	23.20	-4.4	40.0	16.8	QP	100.0	157.00	HORIZONTAL
97.900000	22.20	-6.4	43.5	21.3	QP	300.0	345.00	HORIZONTAL
251.160000	33.20	-4.2	46.0	12.8	QP	100.0	86.00	HORIZONTAL
532.460000	31.60	3.6	46.0	14.4	QP	300.0	354.00	HORIZONTAL
957.320000	40.10	12.3	46.0	5.9	QP	300.0	73.00	HORIZONTAL

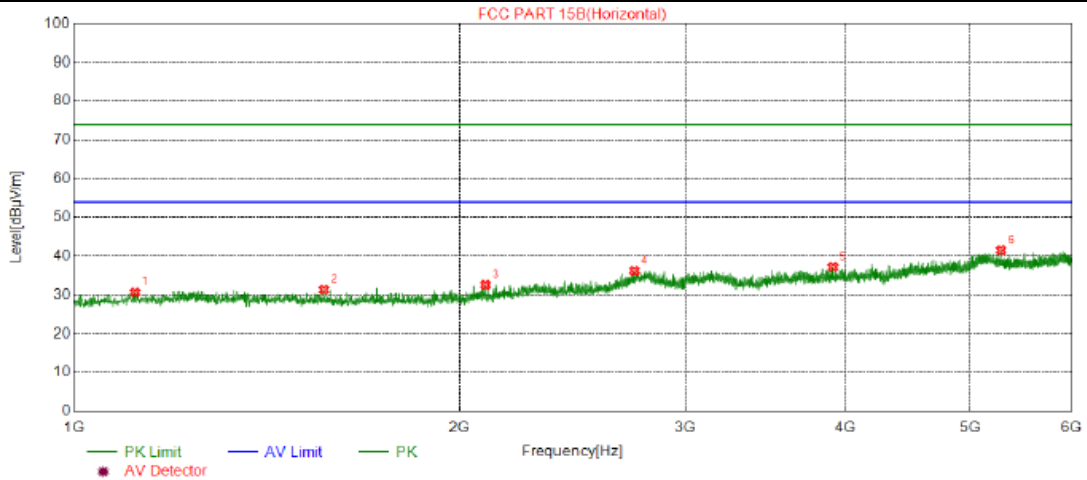

Suspected Data List

NO.	Freq. [MHz]	Reading [dBµV/m]	Factor [dB]	Level [dBµV/m]	Limit [dBµV/m]	Margin [dB]	Polarity	Detector
1	1116.250	37.38	-6.72	30.66	74.00	43.34	Horizontal	PK
2	1567.500	37.44	-6.07	31.37	74.00	42.63	Horizontal	PK
3	2094.375	36.67	-4.05	32.62	74.00	41.38	Horizontal	PK
4	2736.250	35.14	1.13	36.27	74.00	37.73	Horizontal	PK
5	3910.000	34.49	2.71	37.20	74.00	36.80	Horizontal	PK
6	5288.125	33.04	8.51	41.55	74.00	32.45	Horizontal	PK

Polarity: Vertical

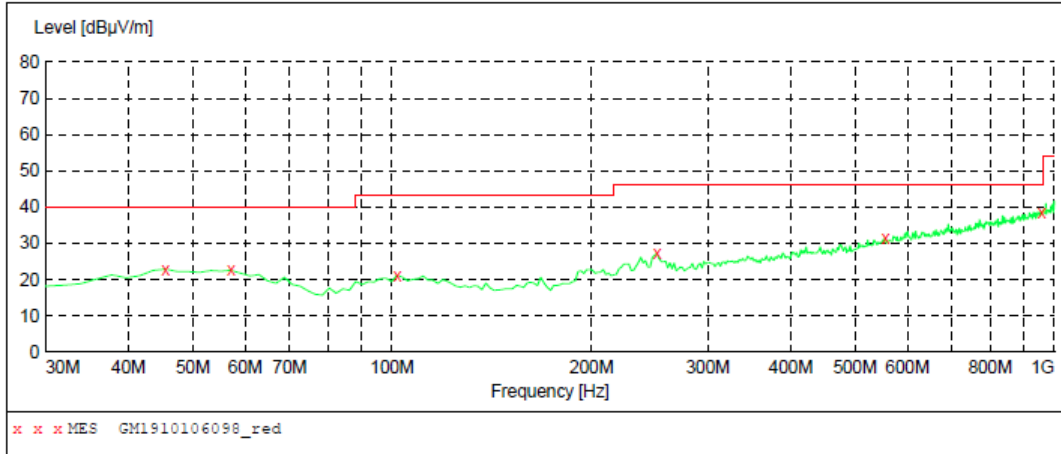

MEASUREMENT RESULT: "GM1910106098_red"

10/10/2019 8:41PM

Frequency MHz	Level dBµV/m	Transd dB	Limit dBµV/m	Margin dB	Det.	Height cm	Azimuth deg	Polarization
45.520000	22.90	-4.4	40.0	17.1	QP	100.0	178.00	VERTICAL
57.160000	22.60	-4.7	40.0	17.4	QP	100.0	249.00	VERTICAL
101.780000	21.20	-6.2	43.5	22.3	QP	100.0	63.00	VERTICAL
251.160000	27.10	-4.2	46.0	18.9	QP	100.0	332.00	VERTICAL
555.740000	31.30	4.3	46.0	14.7	QP	100.0	156.00	VERTICAL
957.320000	38.70	12.3	46.0	7.3	QP	100.0	38.00	VERTICAL

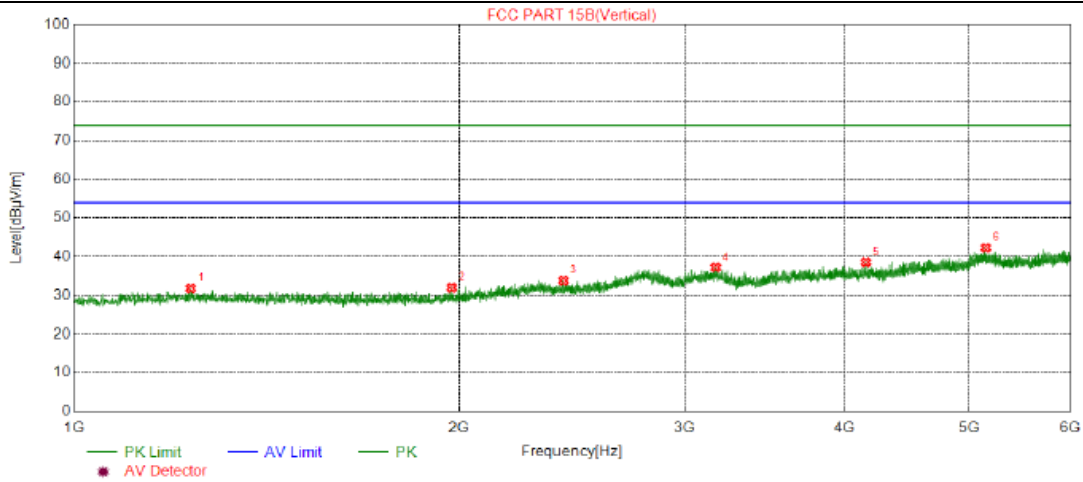

Suspected Data List								
NO.	Freq. [MHz]	Reading [dBµV/m]	Factor [dB]	Level [dBµV/m]	Limit [dBµV/m]	Margin [dB]	Polarity	Detector
1	1233.750	37.58	-5.74	31.84	74.00	42.16	Vertical	PK
2	1973.125	37.04	-5.00	32.04	74.00	41.96	Vertical	PK
3	2412.500	36.22	-2.38	33.84	74.00	40.16	Vertical	PK
4	3171.875	36.57	0.69	37.26	74.00	36.74	Vertical	PK
5	4153.750	35.04	3.56	38.60	74.00	35.40	Vertical	PK
6	5154.375	33.44	8.90	42.34	74.00	31.66	Vertical	PK

DC

Polarity: Horizontal

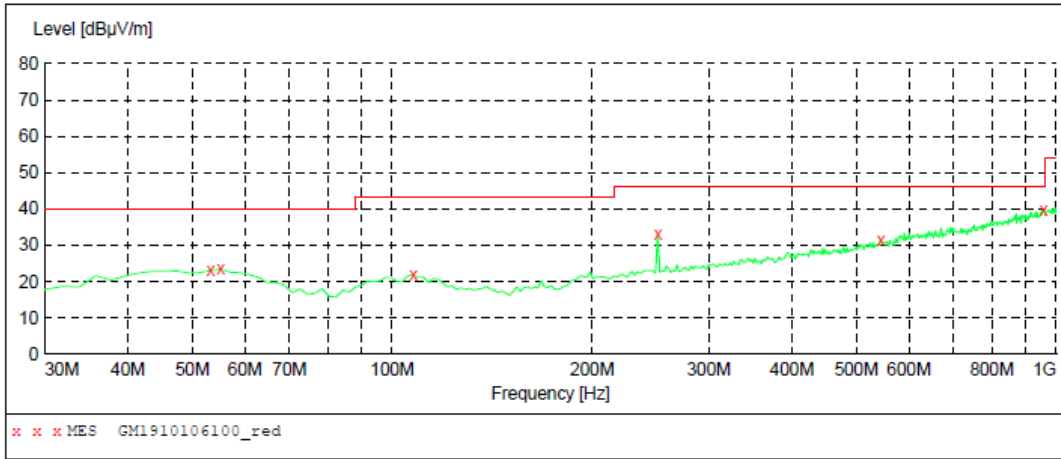

MEASUREMENT RESULT: "GM1910106100_red"

10/10/2019 8:53PM

Frequency MHz	Level dBµV/m	Transd dB	Limit dBµV/m	Margin dB	Det.	Height cm	Azimuth deg	Polarization
53.280000	23.10	-4.6	40.0	16.9	QP	100.0	259.00	HORIZONTAL
55.220000	23.40	-4.4	40.0	16.6	QP	100.0	166.00	HORIZONTAL
107.600000	21.90	-6.4	43.5	21.6	QP	100.0	248.00	HORIZONTAL
251.160000	33.00	-4.2	46.0	13.0	QP	100.0	259.00	HORIZONTAL
544.100000	31.30	4.0	46.0	14.7	QP	100.0	11.00	HORIZONTAL
957.320000	39.70	12.3	46.0	6.3	QP	300.0	131.00	HORIZONTAL

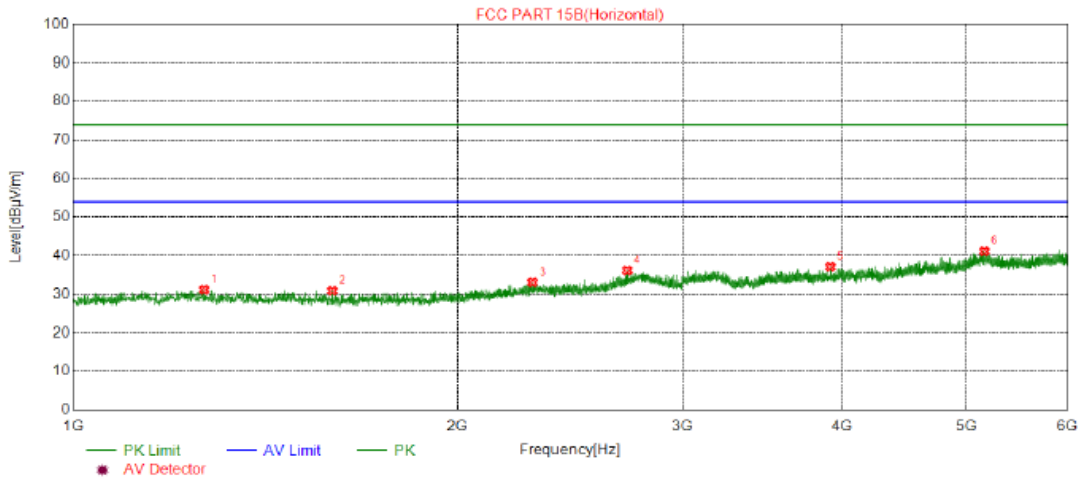

Suspected Data List

NO.	Freq. [MHz]	Reading [dBµV/m]	Factor [dB]	Level [dBµV/m]	Limit [dBµV/m]	Margin [dB]	Polarity	Detector
1	1266.250	36.82	-5.66	31.16	74.00	42.84	Horizontal	PK
2	1595.625	37.15	-6.25	30.90	74.00	43.10	Horizontal	PK
3	2288.125	35.51	-2.41	33.10	74.00	40.90	Horizontal	PK
4	2713.750	35.40	0.80	36.20	74.00	37.80	Horizontal	PK
5	3914.375	34.40	2.72	37.12	74.00	36.88	Horizontal	PK
6	5165.625	32.23	8.92	41.15	74.00	32.85	Horizontal	PK

Polarity: Vertical

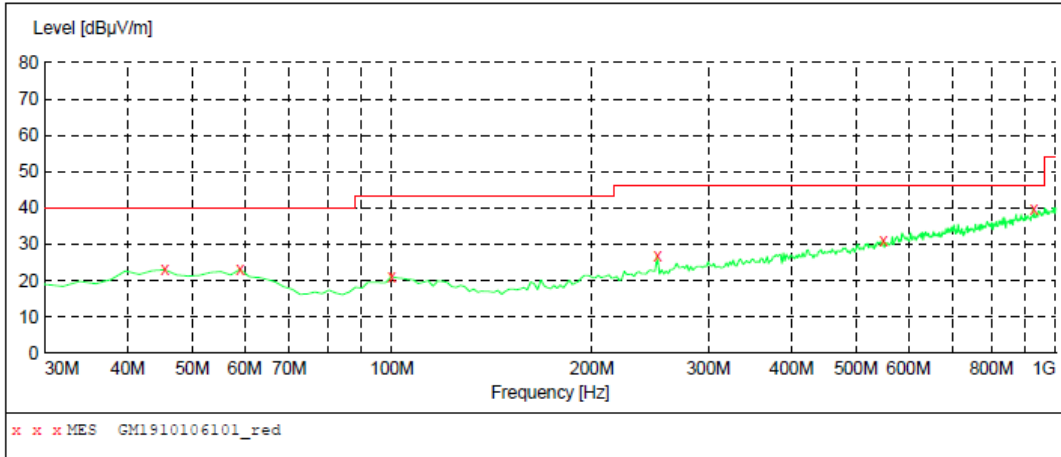

MEASUREMENT RESULT: "GM1910106101_red"

10/10/2019 8:55PM

Frequency MHz	Level dBµV/m	Transd dB	Limit dBµV/m	Margin dB	Det.	Height cm	Azimuth deg	Polarization
45.520000	23.00	-4.4	40.0	17.0	QP	100.0	359.00	VERTICAL
59.100000	23.10	-5.1	40.0	16.9	QP	100.0	155.00	VERTICAL
99.840000	21.10	-6.3	43.5	22.4	QP	100.0	238.00	VERTICAL
251.160000	26.70	-4.2	46.0	19.3	QP	100.0	0.00	VERTICAL
549.920000	31.00	4.2	46.0	15.0	QP	100.0	359.00	VERTICAL
926.280000	39.80	11.7	46.0	6.2	QP	100.0	359.00	VERTICAL

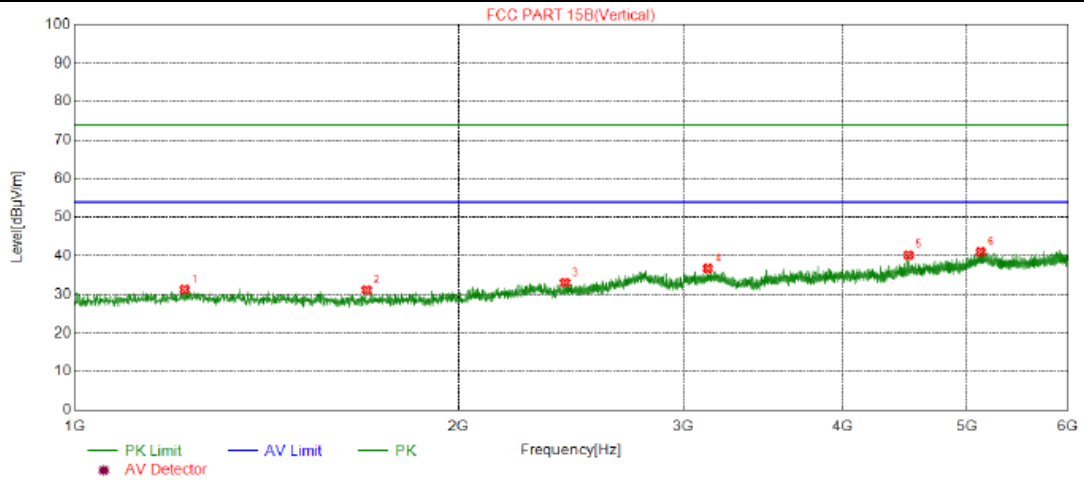

Suspected Data List								
NO.	Freq. [MHz]	Reading [dBµV/m]	Factor [dB]	Level [dBµV/m]	Limit [dBµV/m]	Margin [dB]	Polarity	Detector
1	1219.375	37.06	-5.78	31.28	74.00	42.72	Vertical	PK
2	1693.750	37.27	-6.11	31.16	74.00	42.84	Vertical	PK
3	2423.125	35.41	-2.35	33.06	74.00	40.94	Vertical	PK
4	3135.625	36.26	0.51	36.77	74.00	37.23	Vertical	PK
5	4503.750	34.88	5.37	40.25	74.00	33.75	Vertical	PK
6	5128.125	32.18	8.85	41.03	74.00	32.97	Vertical	PK

6 TEST SETUP PHOTOS OF THE EUT

Transmitter Radiated Spurious Emission:

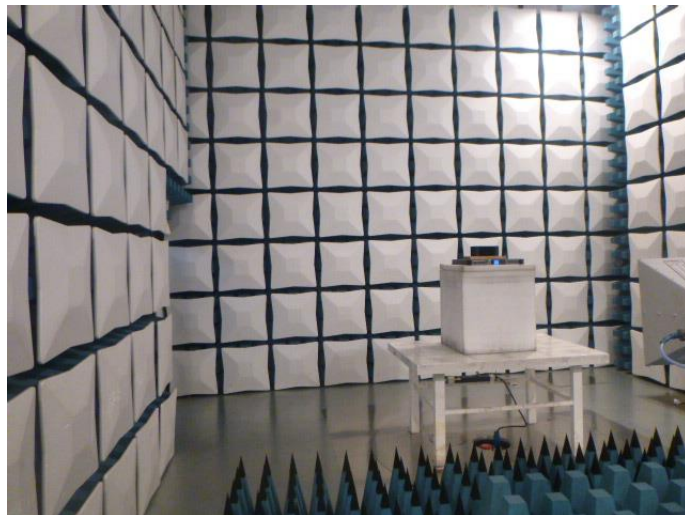
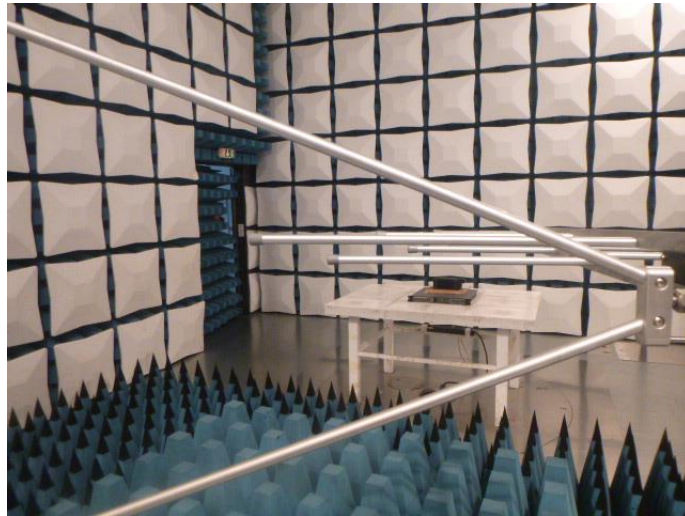

Frequency Stability:





Radiated Emission:

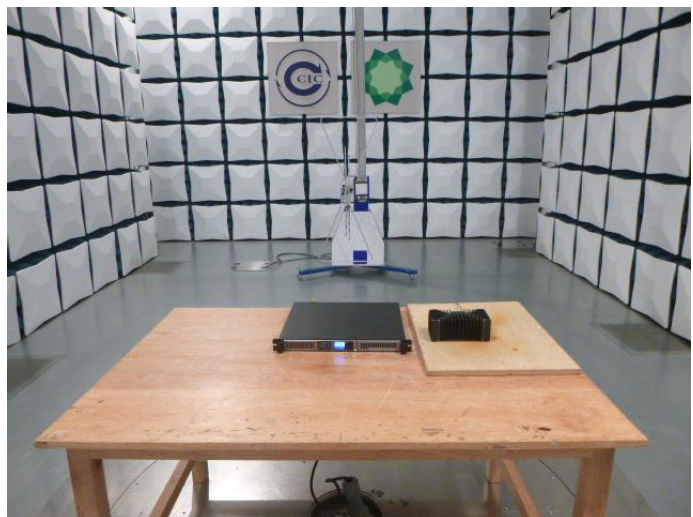

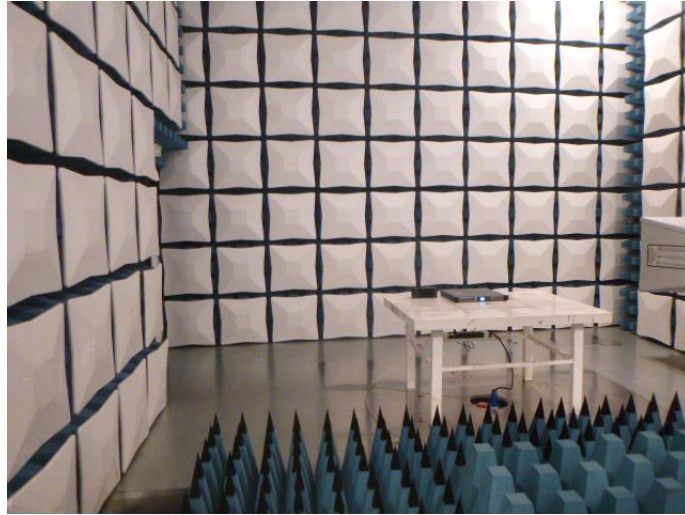

Conducted Emission:

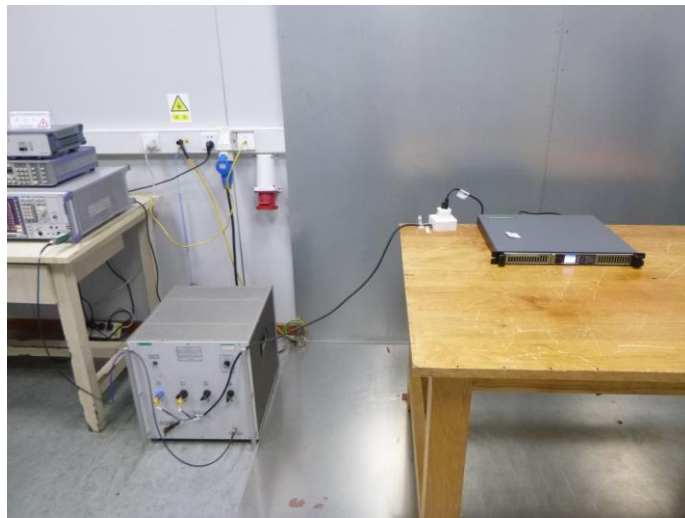

7 EXTERNAL AND INTERNAL PHOTOS OF THE EUT

External Photos of the EUT

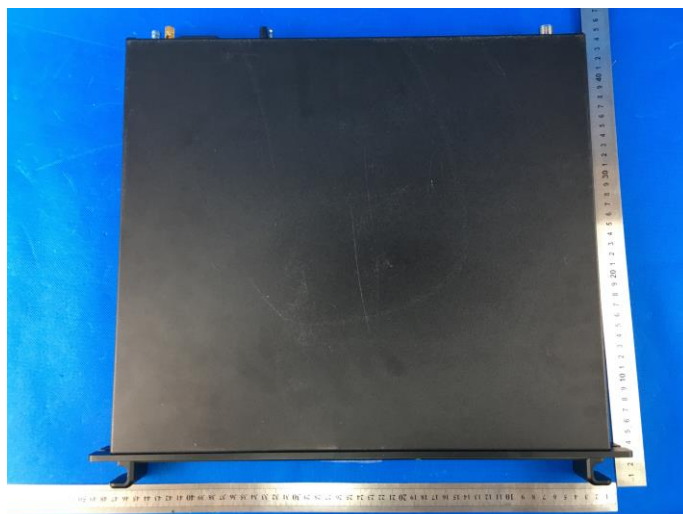
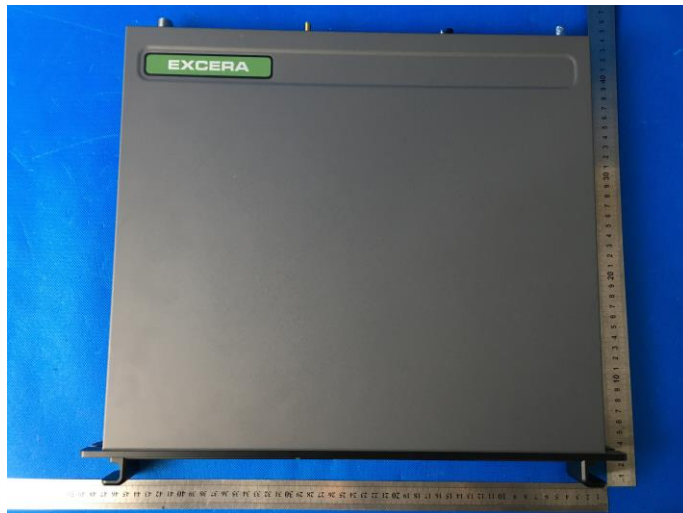

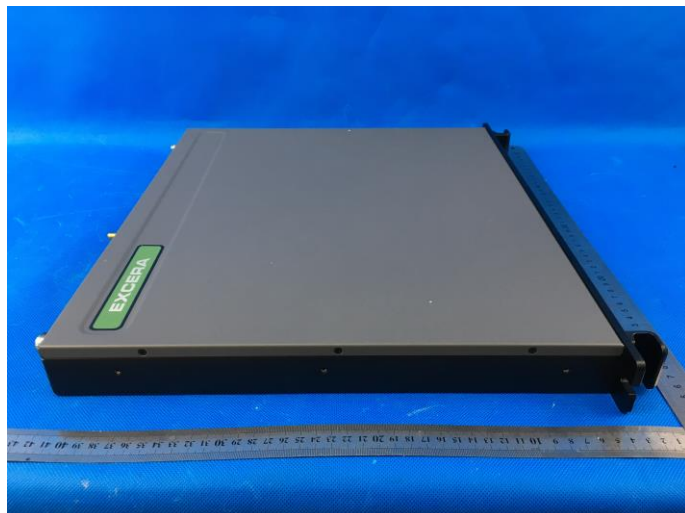

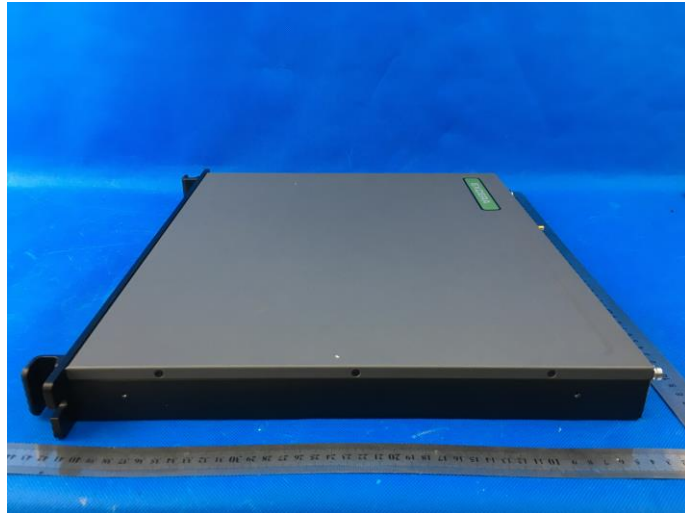

Internal Photos of the EUT

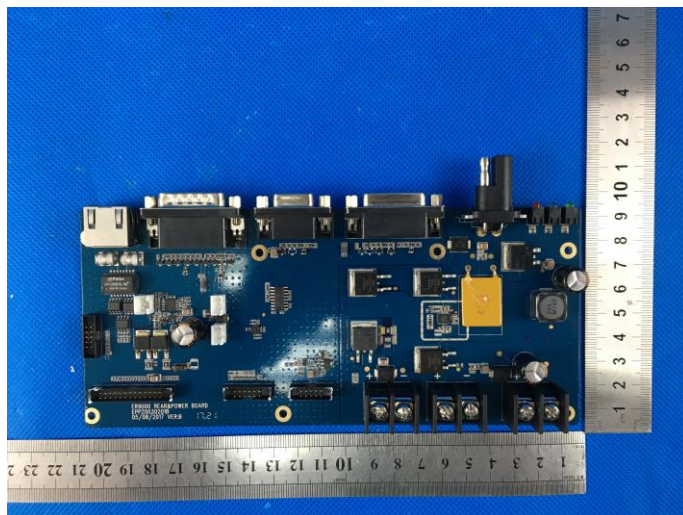
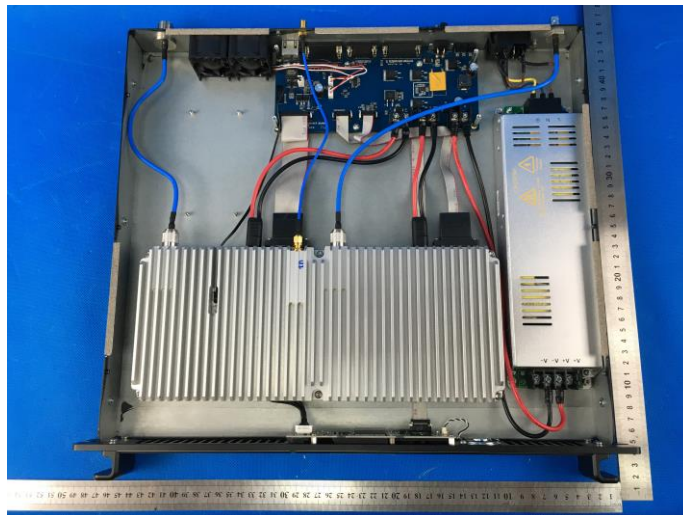
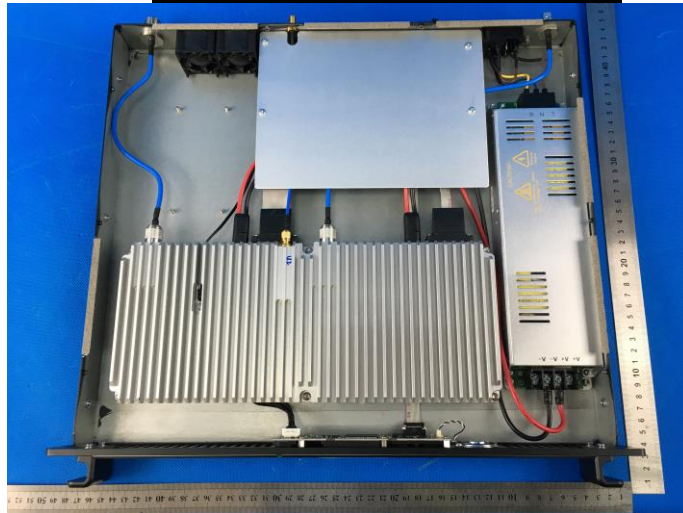

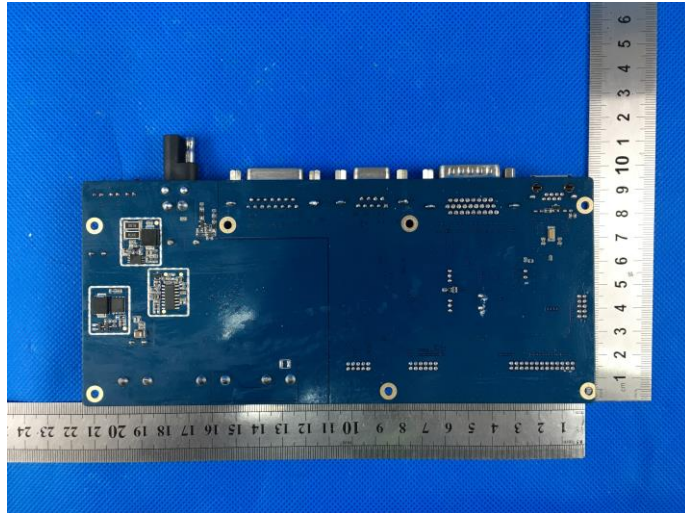

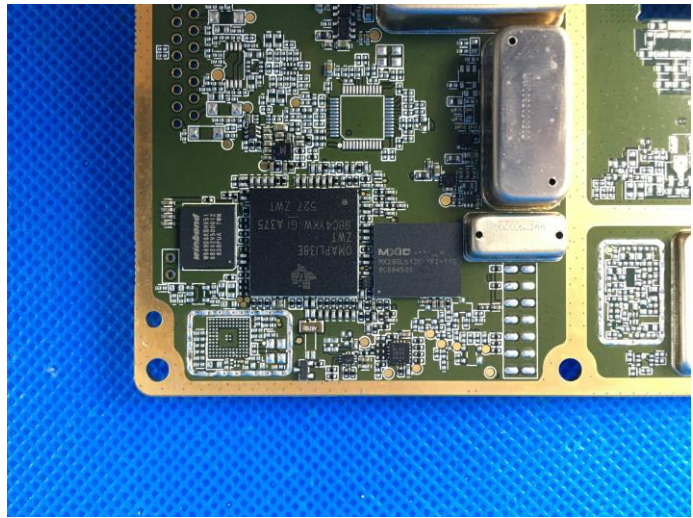
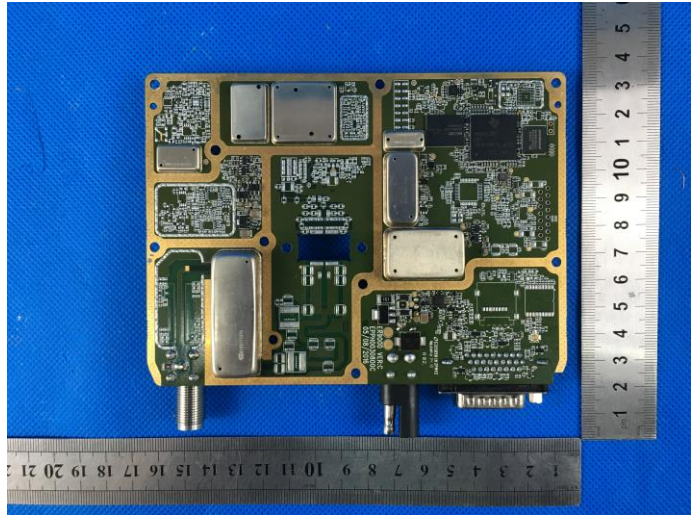

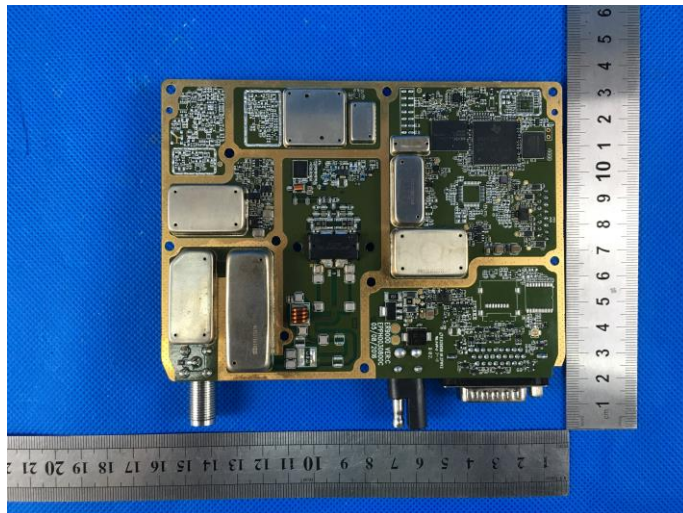

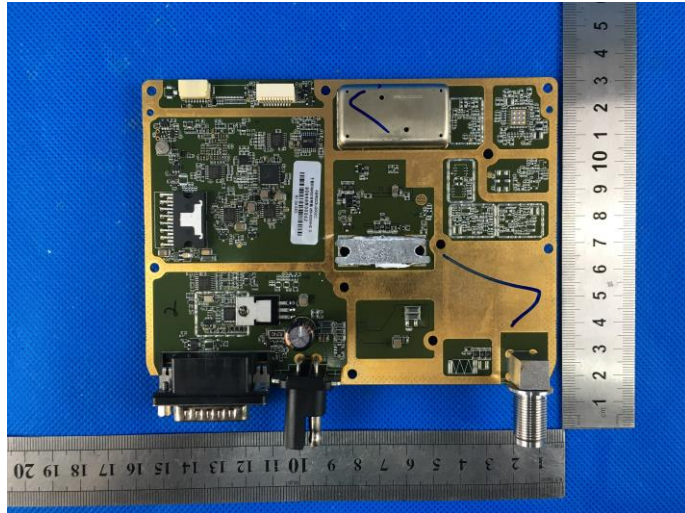

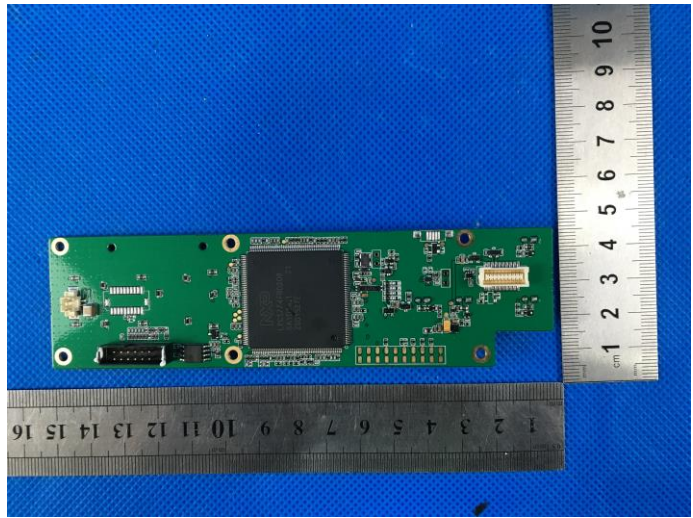
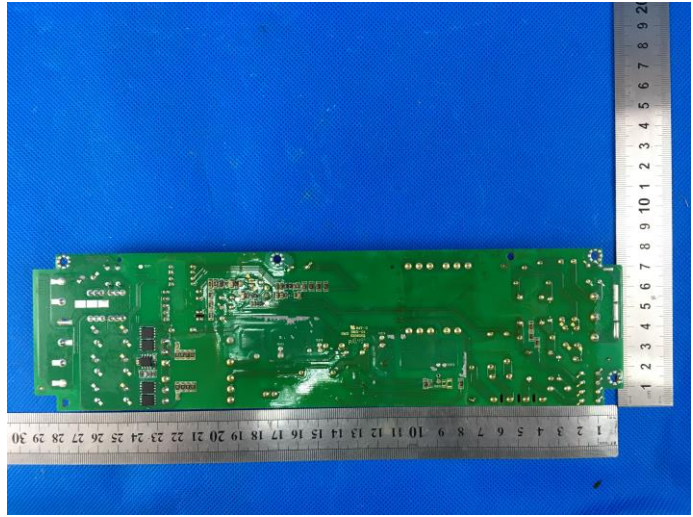

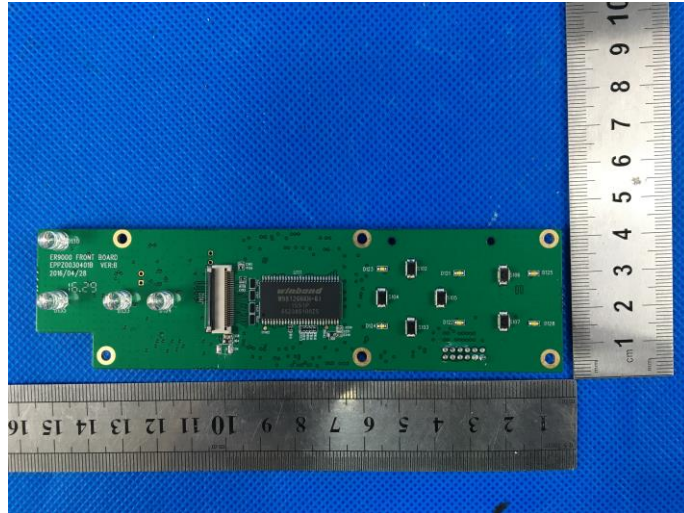

8 APPENDIX REPORT

**Appendix A:Maximum Transmitter Power**

Operation Mode	Modulation Type	Test Channel	Measured Power(dBm)	Measured Power(W)	Rated Power(W)	Percentage (%)	Limit (%)	Result
TX-DNH	4FSK	CH _L	46.6	45.71	50.00	-8.6	±20	PASS
TX-DNH	4FSK	CH _{M1}	46.5	44.67	50.00	-10.7	±20	PASS
TX-DNH	4FSK	CH _{M2}	46.4	43.65	50.00	-12.7	±20	PASS
TX-DNH	4FSK	CH _{M3}	46.3	42.66	50.00	-14.7	±20	PASS
TX-DNH	4FSK	CH _H	46.2	41.69	50.00	-16.6	±20	PASS
TX-DNL	4FSK	CH _L	36.8	4.79	5.00	-4.3	±20	PASS
TX-DNL	4FSK	CH _{M1}	37.0	5.01	5.00	0.2	±20	PASS
TX-DNL	4FSK	CH _{M2}	36.7	4.68	5.00	-6.5	±20	PASS
TX-DNL	4FSK	CH _{M3}	36.7	4.68	5.00	-6.5	±20	PASS
TX-DNL	4FSK	CH _H	36.6	4.57	5.00	-8.6	±20	PASS
TX-ANH	FM	CH _L	46.8	47.53	50.00	-4.9	±20	PASS
TX-ANH	FM	CH _{M1}	46.5	45.08	50.00	-9.8	±20	PASS
TX-ANH	FM	CH _{M2}	46.6	45.60	50.00	-8.8	±20	PASS
TX-ANH	FM	CH _{M3}	46.6	45.39	50.00	-9.2	±20	PASS
TX-ANH	FM	CH _H	46.6	45.19	50.00	-9.6	±20	PASS
TX-ANL	FM	CH _L	36.9	4.84	5.00	-3.2	±20	PASS
TX-ANL	FM	CH _{M1}	36.8	4.80	5.00	-4.1	±20	PASS
TX-ANL	FM	CH _{M2}	36.8	4.83	5.00	-3.4	±20	PASS
TX-ANL	FM	CH _{M3}	36.8	4.83	5.00	-3.4	±20	PASS
TX-ANL	FM	CH _H	36.8	4.80	5.00	-4.1	±20	PASS

**Appendix B:Occupied Bandwidth**

Operation Mode	Modulation Type	Test Channel	Occupied Bandwidth		99% Limit(kHz)	Result
			99%(kHz)	26dB(kHz)		
TX-DNH	4FSK	CH _L	7.360	9.186	≤11.25	PASS
TX-DNH	4FSK	CH _{M1}	7.060	9.087	≤11.25	PASS
TX-DNH	4FSK	CH _{M2}	7.373	9.182	≤11.25	PASS
TX-DNH	4FSK	CH _{M3}	7.355	9.143	≤11.25	PASS
TX-DNH	4FSK	CH _H	7.380	9.193	≤11.25	PASS
TX-DNL	4FSK	CH _L	7.411	9.182	≤11.25	PASS
TX-DNL	4FSK	CH _{M1}	7.042	9.115	≤11.25	PASS
TX-DNL	4FSK	CH _{M2}	7.405	9.193	≤11.25	PASS
TX-DNL	4FSK	CH _{M3}	7.414	9.170	≤11.25	PASS
TX-DNL	4FSK	CH _H	7.400	9.195	≤11.25	PASS
TX-ANH	FM	CH _L	9.947	10.150	≤11.25	PASS
TX-ANH	FM	CH _{M1}	9.960	10.160	≤11.25	PASS
TX-ANH	FM	CH _{M2}	9.970	10.160	≤11.25	PASS
TX-ANH	FM	CH _{M3}	9.977	10.170	≤11.25	PASS
TX-ANH	FM	CH _H	9.982	10.160	≤11.25	PASS
TX-ANL	FM	CH _L	9.952	10.150	≤11.25	PASS
TX-ANL	FM	CH _{M1}	9.967	10.160	≤11.25	PASS
TX-ANL	FM	CH _{M2}	9.970	10.160	≤11.25	PASS
TX-ANL	FM	CH _{M3}	9.971	10.160	≤11.25	PASS
TX-ANL	FM	CH _H	9.984	10.160	≤11.25	PASS