

EXCERA

EP8000 VHF

Digital Portable Radio
User Manual

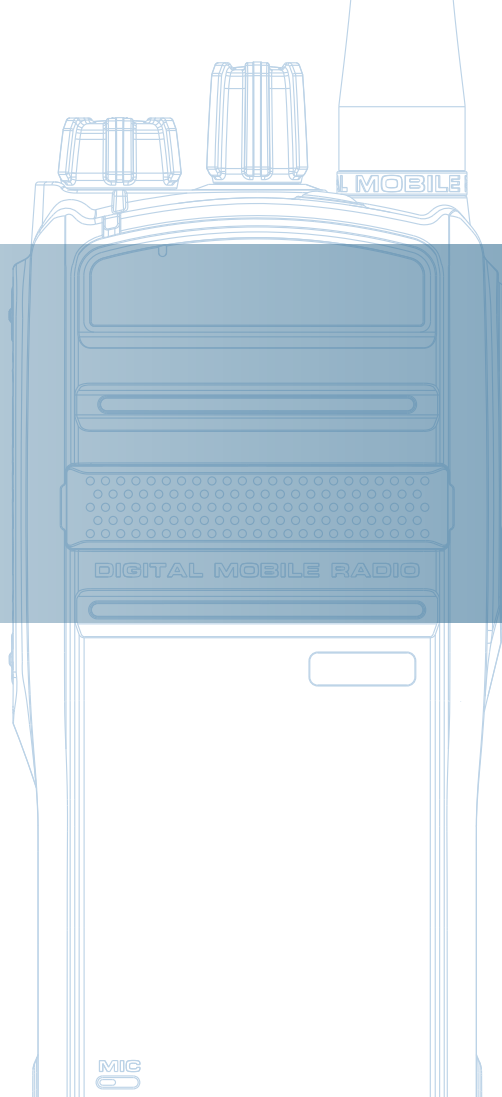

MIC

■ Contents

Important Information	1	Digital Conventional Functions and Operations	12
RF Energy Exposure Information	2	Call	12
Operation Safety Recommendations	3	Private Call	12
Radio Safety Information and RF Radiation Information	4	Group Call	12
Alert Icon	5	All Call	13
Disabled Frequencies	5	Color Code	13
Checking Items in the Package	6	Man Down	13
Getting Started	7	Analog Conventional Functions and Operations	14
Preparing Your Radio for Use	7	Calls on Analog Channels	14
Charging the Battery	7	CTCSS/CDCSS Type	14
Attaching the Battery	8	CTCSS	14
Attaching the Antenna	8	CDCSS	14
Attaching the Belt Clip	8	CDCSS Invert	14
Radio Controls	9	Optional Accessories	15
LED Indicator	10	Troubleshooting	16
Basic Operations	11	Limited Warranty	17
Switching the Channel Mode	11	Warranty Card	19
Setting the Programmable Buttons	11		
Adjusting the Volume	11		
Adjusting Power Level	11		
Selecting a Channel	11		
Selecting a Zone	11		
Transmit Time-Out	11		

■ Important Information



Note:

Le Fabricant N'est Pas Responsable Des Toutes Interférences Radio Ou Télévision Causées Par Des Modifications Non Autorisées Apportées À Cet Appareil. De Telles Modifications Peuvent Empêcher L'utilisateur D'utiliser L'appareil.

The Manufacturer Is Not Responsible For Any Radio Or Tv Interference Caused By Unauthorized Modifications Or Change To This Equipment. Such Modifications Or Change Could Void The User's Authority To Operate The Equipment.

The Users Manual Or Instruction Manual For An Intentional Or Unintentional Radiator Shall Caution The User That Changes Or Modifications Not Expressly Approved By The Party Responsible For Compliance Could Void The User's Authority To Operate The Equipment. In Cases Where The Manual Is Provided Only In A Form Other Than Paper, Such As On A Computer Disk Or Over The Internet, The Information Required By This Section May Be Included In The Manual In That Alternative Form, Provided The User Can Reasonably Be Expected To Have The Capability To Access Information In That Form.

Your EXCERA 2-wayradio is designed and tested to comply with a number of national and international standards and guidelines (listed below) for human exposure to radio frequency electromagnetic energy. This radio complies with the IEEE and ICNIRP exposure limits for occupational/controlled RF exposure environment at operating duty factors of up to 50 % transmitting and is authorized by the FCC for occupational use only. In terms of measuring RF energy for compliance with the FCC exposure guidelines, your radio radiates measurable RF energy only while it is transmitting (during talking), not when it is receiving (listening) or in standby mode. Note: The approved batteries supplied with this radio are rated for a 5-5-90 duty factor (5% talk-5% listen - 90% standby), even though this radio complies with the FCC occupational RF exposure limits and may operate at duty factors of up to 50 % talk.

Your EXCERA 2-way radio complies with the following RF energy exposure standards and guidelines:

- United States Federal Communications Commission, Code of Federal Regulations; 47 CFR §§ 1.1307, 1.1310, 2.1091 and 2.1093
- American National Standards Institute (ANSI) / Institute of Electrical and Electronic Engineers (IEEE) C95.1-1992
- Institute of Electrical and Electronic Engineers (IEEE) C95.1-1999 Edition

This equipment complies with FCC RF exposure guidelines. This equipment should be installed and operated with 0 cm separation from radiator and body for body-back mode. This transmitter must not be co-located or operating in conjunction with any other antenna or transmitter. Hold the radio in a vertical position in front of face with the microphone at least one inch(2.5cm)away from the nose.

Keeping the radio at the proper distance is important because RF exposures decrease with distance from the antenna. Antenna should be kept away from eyes.

■ Important Information

RF Energy Exposure Information

RF Energy Exposure Awareness And Control Information For Fcc Occupational Use Requirements

Before using the two-way portable radio, review the following important RF energy awareness and control information and operational instructions. Comply with this information and instructions in order to ensure compliance with RF exposure guidelines. e the capability to access information in that form.



WARNING

This radio is intended for use in occupational/controlled conditions, where users have full knowledge of their exposure and can exercise control over their exposure to remain below RF exposure limits. This radio is NOT authorized for general population, consumer, or any other use.



CAUTION

Changes or modifications not expressly approved by Shenzhen Excera Technology Co., Ltd. could void the user's authority to operate the equipment.

This two-way radio uses electromagnetic energy in the radio frequency (RF) spectrum to provide communications between two or more users over a distance. It uses RF energy or radio waves to send and receive calls. RF energy is one form of electromagnetic energy. Other forms include, but are not limited to, electric power, sunlight, and x-rays. RF energy, however, should not be confused with these other forms of electromagnetic energy, which, when used improperly, can cause biological damage. Very high levels of x-rays, for example, can damage tissues and genetic material.

Experts in science, engineering, medicine, health, and industry work with organizations to develop standards for exposure to RF energy. These standards provide recommended levels of RF exposure for both workers and the general public. These recommended RF exposure levels include substantial margins of protection. All two-way radios marketed in North America are designed, manufactured, and tested to ensure they meet government-established RF exposure levels. In addition, manufacturers also recommend specific operating instructions to users of two-way radios. These instructions are important because they inform users about RF energy exposure and provide simple procedures on how to control it. Refer to the following websites for more information on what RF energy exposure is and how to control exposure to assure compliance with established RF exposure limits:

<http://www.fcc.gov/oet/rfsafety/rf-faqs.html>

<http://www.osha.gov./SLTC/radiofrequencyradiation/index.html>

■ Important Information

Federal Communications Commission Regulations

Before it was marketed in the United States, the Digital portable radio was tested to ensure compliance with FCC RF energy exposure limits for two-way portable radios. When two-way radios are used as a consequence of employment, the FCC requires users to be fully aware of and able to control their exposure to meet occupational requirements. Exposure awareness can be facilitated by the use of a

label directing users to specific user awareness information. The radio has an RF exposure product label.

Also, the Product Safety Manual and this Operator's Manual include information and operating instructions required to control RF exposure and to satisfy compliance requirements.

Operation Safety Recommendations

Occupational Safety Guidelines And Safety Training Information

To ensure bodily exposure to RF electromagnetic energy is within the FCC allowable limits for occupational use. Always adhere to the following basic guidelines:

- The push-to-talk button should only be depressed when intending to send a voice message.
- The radio should only be used for necessary work-related communications.
- The radio should only be used by authorized and trained personnel. It should never be operated by children.
- Do not attempt any unauthorized modification to the radio. Changes or modifications to the radio may cause harmful interference and/or cause it to exceed FCC RF exposure limits. Only qualified personnel should service the radio.
- Always use only authorized accessories (antennas, control heads, speakers/mics, etc.). Use of unauthorized accessories can cause the FCC RF exposure compliance requirements to be exceeded.

The information listed above provides the user with information needed to make him or her aware of a RF exposure, and what to do to assure that this radio operates within the FCC exposure limits of this radio.

■ Important Information



Radio Frequency Interference

FCC Part 15

This device complies with Part 15 of the FCC Rules. Operation is subject to the following two conditions:

1. This device may not cause harmful interference; and,
2. This device must accept any interference received, including interference that may cause undesired operation.

Industry Canada

This device complies with Industry Canada license-exempt RSS standard(s). Operation is subject to the following two conditions: (1) this device may not cause interference, and (2) this device must accept any interference, including interference that may cause undesired operation of the device. Le présent appareil est conforme aux CNR d'Industrie Canada applicables aux appareils radio exempts de licence. L'exploitation est autorisée aux deux conditions suivantes : (1) l'appareil ne doit pas produire de brouillage, et (2) l'utilisateur de l'appareil doit accepter tout brouillage radioélectrique subi, même si le brouillage est susceptible d'en compromettre le fonctionnement.

CAUTION:

RISK OF EXPLOSION IF BATTERY IS REPLACED BY AN INCORRECT TYPE. DISPOSE OF USED BATTERIES ACCORDING TO THE INSTRUCTIONS.

Adapter shall be installed near the equipment and shall be easily accessible.

The max operating of the device is 55°C.

EU Regulatory Conformance

As certified by the qualified laboratory, the product is in compliance with the essential requirements and other relevant provisions of the Directive 199/5/EC. Please note that the above information is applicable to EU countries only.



■ Important Information



Before using this product, please read this user manual carefully.

■ **Alert Icon**



Caution:

Indicates situations that could cause human injury or damage to your products.



Note:

Indicates tips that can help you make better use of your products.

■ **Disabled Frequencies**

136 – 174 MHz	
No.	Frequency
1	148.8 MHz
2	153.6 MHz
3	172.8 MHz



Caution:

This radio is restricted to occupational use only to satisfy FCC RF energy exposure requirements.

■ Checking Items in the Package

Please unpack carefully and check that all items listed below are received. If any item is missing or damaged, please contact your dealer.



1 Radio



2 Battery



3 Charger

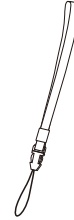

4 Strap

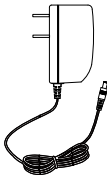

5 Power Adapter



6 Antenna

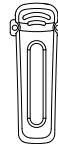

7 Belt Clip



8 User Manual

■ Getting Started

■ Preparing Your Radio for Use

Charging the Battery

For best performance, your radio is powered by an Excera manufactured Lithium-Ion (Li-Ion) battery. To avoid damage and comply with warranty terms, charge the battery using the charger contained in the package.

Charging Diagram

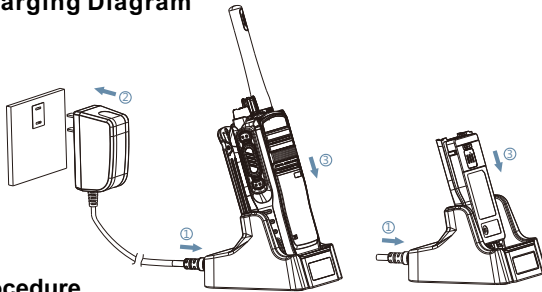





Procedure

1. Plug the power adapter into the rear jack of the charger.
See arrow ①.
2. Connect the power adapter to AC socket. See arrow ②.
3. Place the radio with the battery attached, or the battery alone, into the charger. See arrow ③.

The charging process begins when the charger LED glows red and is completed when the LED glows green.

LED Indicator

LED Indicator	Charger Status
 LED flashes red slowly.	Standby (no load)
 LED glows red.	Charging
 LED glows orange.	90% charged
 LED glows green.	Fully charged
 LED flashes red rapidly.	Failure

■ Getting Started

Attaching the Battery

1. Align the battery with the rails on the rear of the radio as shown by arrow ①.
2. Slide the battery upward to the top of the rails and snap the latch into place as shown by arrow ②.

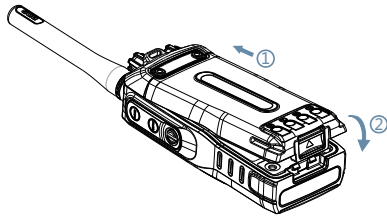

To remove the battery, turn off the radio first. Move the battery latch into unlock position and hold, and slide the battery down and off the rails.

Attaching the Antenna

To attach the antenna, set the antenna in its receptacle and turn clockwise.

To remove the antenna, turn the antenna counterclockwise.

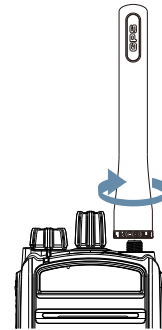

Note: You need to turn off the radio prior to attaching or removing the antenna.

Attaching the Belt Clip

1. Remove the screws.
2. Align the screw holes on the belt clip with those on the radio's body, and then tighten the screws.

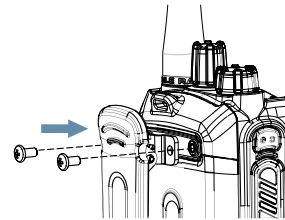

■ Getting Started

■ Radio Controls

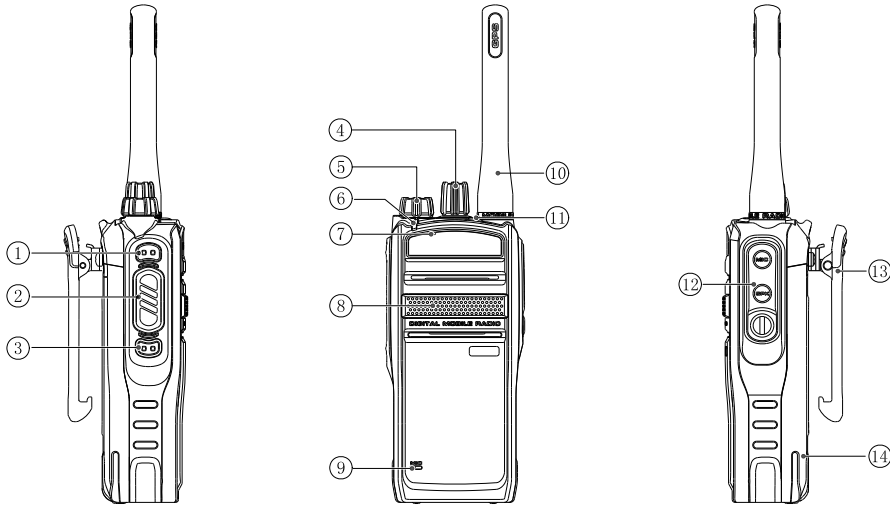

No.	Part Name	No.	Part Name	No.	Part Name
①	SK1 (Side Key 1)	⑥	LED Indicator	⑪	TK (Top Key)
②	PTT Key	⑦	Microphone (Half Duplex)	⑫	Accessory Jack
③	SK2 (Side Key 2)	⑧	Speaker	⑬	Belt Clip
④	Channel Selector Knob	⑨	Microphone (Full Duplex)	⑭	Battery
⑤	Radio On-Off/Volume Control Knob	⑩	Antenna		

■ Getting Started

■ *LED Indicator*

LED Indicator	Radio Status
LED flashes green rapidly.	Upgrading or powering on
LED glows green.	Receiving
LED flashes red slowly.	Low battery
LED flashes red rapidly.	None
LED glows red.	Transmitting
LED flashes orange slowly.	Scanning
LED flashes orange rapidly.	None
LED glows orange.	No voice is being transmitted or received on the traffic channel after a call is established. Within such period, you can hold down the PTT key to talk.

■ Basic Operations

■ *Switching the Channel Mode*

This radio can operate in either digital or analog conventional mode.

Each channel can be programmed as either analog or digital channel via the CPS. If the current zone includes a mixture of analog and digital channels, you may quickly switch between digital and analog through the **Channel Selector** knob.

■ *Setting the Programmable Buttons*

You may set the programmable buttons (SK1, SK2, and TK) as shortcuts to radio functions (such as power level switch, zone switch, or squelch level) using the CPS.

■ *Adjusting the Volume*

After turning the radio on or during a call, rotate the **Radio On-Off/Volume Control** knob clockwise to increase the call volume, or counterclockwise to decrease it.

■ *Adjusting Power Level*

With this option, you may toggle power levels quickly. We recommend you to adopt low power for battery

saving. However, if you cannot communicate with radios located at a distant place with low power, please select high power.

■ *Selecting a Channel*

After turning the radio on, rotate the **Channel Selector** knob to select a desired channel. In the process, you will hear the sequence number of the selected channel in the Zone Member list.

■ *Selecting a Zone*

A zone is a group of channels exhibiting the same property. The radio supports 32 zones and each zone contains 16 channels at most. You may quickly toggle to your desired zone by pressing the programmed **Zone Up** or **Zone Down** key.

■ *Transmit Time-Out*

The purpose of Transmit Time-Out is to prevent any user from occupying a channel for an extended period. If the preset time expires, the radio will automatically terminate the transmission. You may set the time via the CPS.

■ Digital Conventional Functions and Operations

■ *Call*

To ensure that your speech is clear, keep the microphone 2.5 to 5 cm from your mouth.

Private Call

A private call is a call from an individual radio to another individual radio.

Making a Private Call

In standby mode, hold down the **PTT** key to make a private call to the private call contact preset for the current channel.

Receiving and Responding to a Private Call

When a private call is received, you can listen to it without any operation and you may hold down the **PTT** key within the preset time period to call back.

Group Call

A group call refers to a call from an individual radio to a group of radios.

Making a Group Call

In standby mode, hold down the **PTT** key to make a group call to the group call contact preset for the current channel.

Receiving and Responding to a Group Call

When a group call is received, you can listen to it without any operation and you may hold down the **PTT** key within the preset time period to call back.

Late Entry

After a group call is established, it allows other group members to join this call.

Late entry may occur in any of the following situations:

- The radio is powered on.
- The **Channel Selector** knob is rotated to the channel in operation.
- The radio is within the communication coverage of this group call.

■ Digital Conventional Functions and Operations

Rx Group List

With this option, you can receive multiple group calls on a digital channel.

A Rx group list contains a maximum of 32 group contacts. You can set up to 32 Rx group lists using the CPS, each of which can be associated with a digital channel.

All Call

An all call is a call from an individual radio to every radio on the channel.



Note: The All Call ID is fixed and is set via the CPS.

Making An All Call

In standby mode, hold down the **PTT** key to make the all call to the all call contact preset for the current channel.

■ **Color Code**

Color code is used to identify a system. Users who wish to communicate with each other are assigned with the same color code. A radio ignores the channel activity which does not match the preset color code in this field, as it assumes the activity belongs to other systems. You may set this feature via the CPS.

■ **Man Down**

Once this feature is activated, if you radio tilts to a specified gradient and is not placed upright within Man Down Delay Time, it will enter the emergency mode. This feature will be valid if is checked in the CPS.

■ Analog Conventional Functions and Operations

■ *Calls on Analog Channels*

To transmit on an analog channel, hold down the **PTT** key and speak into the microphone. To receive, release the **PTT** key.

■ *CTCSS/CDCSS Type*

This option allows you to configure the current channel with a specific Rx CTCSS/CDCSS type. When the radio receives the signal, it will distinguish whether the received signal is CTCSS or CDCSS, and check out whether it matches the predefined CTCSS/CDCSS for the current channel before processing. Three types are available: CTCSS, CDCSS, and CDCSS Invert.



Note: CDCSS is also known as DCS.

CTCSS

The radio checks for CTCSS match when receiving a signal on the current channel. Follow the procedure below to set CTCSS/CDCSS Type to CTCSS.

Procedure:

1. Log in to the CPS.

2. Go to “Conventional -> Channel -> Analog Channel -> Selected Analog Channel” and set Rx/Tx CTCSS /CDCSS Type to CTCSS.

CDCSS

The radio checks for CDCSS match when receiving a signal on the current channel.

Follow the procedure below to set CTCSS/CDCSS Type to CDCSS.

Procedure:

1. Log in to the CPS.
2. Go to “Conventional -> Channel -> Analog Channel -> Selected Analog Channel” and set Rx/Tx CTCSS /CDCSS Type to CDCSS.

CDCSS Invert

The radio checks for an invert CDCSS match when receiving a signal on the current channel.

Follow the procedure below to set CTCSS/CDCSS Type to CDCSS Invert.

Procedure:

1. Log in to the CPS.
2. Go to “Conventional -> Channel -> Analog Channel -> Selected Analog Channel” and set Rx/Tx CTCSS /CDCSS Type to CDCSS Invert.

■ Optional Accessories



The following items are the main optional accessories for the product. Consult your local dealer for more other accessories.



Programming Cable
EPC01



Wireless PTT
EPTTB01



Bluetooth Headset
EEWB03E



Remote Speaker
Microphone
EMRN01 1



C-Shell Earset
EEHN01



Police Full Bone
Conduction Headset
EEBN011



Fireman Full Bone
Conduction Headset
EEBN021



1-Wire Earpiece with
Transparent Acoustic Tube
EEAN011



2-Wire Earpiece with
Transparent Acoustic Tube
EEAN021



Multi-unit Charger
EMC702L



Caution: Use the accessories specified by the Company only. Otherwise, the Company shall not be liable for losses or damages arising out of use of unauthorized accessories.

Troubleshooting

Phenomena	Analysis	Solution
The radio cannot be powered on.	The battery may be improperly installed.	Remove the battery and attach it again.
	The battery may run out.	Recharge or replace the battery.
	The battery may suffer from poor contact caused by dirty or damaged battery contacts.	Clean the battery contacts. If the problem cannot be solved, contact your dealer or authorized service center for inspection and repair.
The radio cannot register successfully.	The radio may not detect signals from the base station.	Make sure you are within the coverage of the base station.
	The radio may not be authorized.	Contact the base station manager to check whether you are an authorized subscriber in the network management system.
The radio registers repeatedly.	The signal is discontinuous.	Make sure you are within the coverage of the base station.
The radio cannot establish a call.	The signal is poor.	Make sure you are within the coverage of the base station.
No voice is heard after a call is established.	Your ID may be repeated.	Contact the base station manager to check whether your ID is repeated in the network management system.
The called party disconnects repeatedly during communication.	The signal is discontinuous.	Make sure you are within the coverage of the base station.
During receiving, the voice is weak, discontinuous, or totally inactive.	Low battery	Recharge or replace the battery.
	The volume may be set to a low level.	Increase the volume by rotating the Volume Control knob clockwise.
	The antenna may get loose or improperly installed.	Power off the radio, reinstall the antenna and power on the radio again.
	The speaker may be blocked or damaged.	Clean surface of the speaker. If the problem cannot be solved, contact your local dealer or authorized service center for inspection and repair.
You cannot communicate with other members.	The signal is poor.	Make sure you are within the communication range.
The voice is unclear.	The signal is poor.	Make sure you are within the communication range.
The noise is too loud.	The signal is poor.	Make sure you are within the communication range.
	You may be at an unfavorable position. For example, your communication may be blocked by high buildings or frustrated in the underground areas.	Move to an open and flat area and restart the radio.
	You may suffer from external disturbance (such as electromagnetic interference).	Stay away from equipment that may cause interference.

If the above solutions cannot fix your problems, or you may have some other queries, please contact us or your local dealer for more technical support.

■ Limited Warranty

What This Warranty Covers and for How Long

Shenzhen Excera Technology Co., Ltd. warrants the Excera manufactured products listed below against defects in material and workmanship under normal use and service for a period of time from the date of purchase as scheduled below:

EP8000 Digital Portable Radios	Two Years
Accessories	Six Months

How to Get Warranty Service

You must provide a completely filled warranty card, purchase invoice, and receipt in order to get warranty services. The purchase invoice or receipt should indicate the radio, accessories, radio serial number, purchase date, and purchase amount.

What This Warranty Does Not Cover

1. Defect or damage resulting from use of the product in other than its normal and customary manner
2. Defect or damage caused by unauthorized product disassembly, repair, or modification
3. Damage due to force majeure, such as flood, lightning strike, earthquake, tsunami, fire, and abnormal voltage
4. Product that does not have a valid warranty certificate, such as warranty card, purchase invoice, or receipt
5. Product which has had the serial number and the tamper-proof label removed or made illegible
6. Normal and customary wear and tear
7. Rechargeable batteries if:
 - (1) any of the seals on the battery enclosure of cells is broken or shows evidence of tampering.
 - (2) the damage or defect is caused by charging or using the battery in equipment or service other than the product for which it is specified.

Warranty Card

Purchase Information

Customer Name: _____

Customer Phone: _____

Customer Address: _____

Purchase Date: _____

Radio Information

Model Number: _____

Serial Number: _____



Note:

- This warranty card applies to after-sale and maintenance services for the product and accessories described above.
- You must provide this warranty card and purchase invoice in order to get warranty services.
- The Company does not assume liability for damages caused by human factors. For more details, contact your local dealer.



Please tear from the Dotted line



SHENZHEN EXCERA TECHNOLOGY CO.,LTD.

**Address: 3rd Floor, Block B, Jiada R&D Building, No.5 Songpingshan
Road, Hi-Tech Park North, Nanshan District , Shenzhen**

Postal Code: 518057

Web: www.excera.com.cn

Tel: +86-755-33010298