

EXCERA

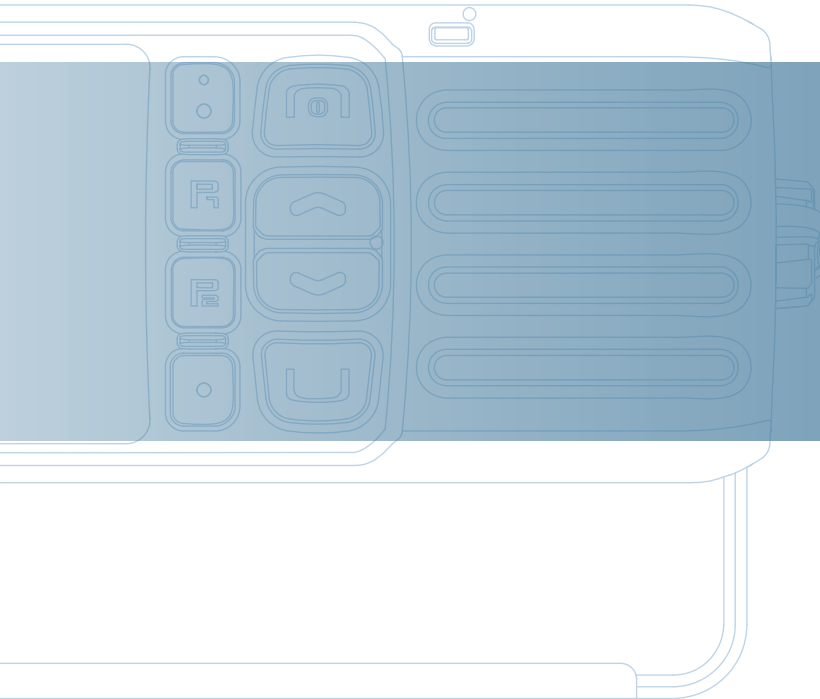

EM8100 U2

Digital Mobile Radio
User Manual



■ Contents

Important Information	1	Bluetooth	9
Alert Icon	1	GPS	10
Disabled Frequencies	1	Digital Conventional Functions and Operations ..	11
Checking Items in the Package	2	Call	11
Getting Started	3	Private Call	11
Installation	3	Group Call	11
Installation Diagram	3	All Call	12
Product Overview	4	Scan	12
Radio Controls	4	Scan Start Condition	12
Palm Microphone	5	Scan List	12
LED Indicator	6	Scan Tx Mode	12
LCD Icon	6	Priority Channel 1	13
Menu Navigation	7	Priority Channel 2	13
Mode	7	Talkback	13
Device Information	7	Scan Delay	13
Date and Time	7	Emergency	14
Tone	7	Emergency Call	14
LED	7	Emergency Alarm	14
Display	8	Message	15
Menu Reset	8	Inbox	15
Programmable Buttons	8	Outbox	15
Noise Reduction	8	Drafts	15
Transmit Time-Out	8	New Msg	15

Contents

Preset Msg	15	Contact	25
Status Msg	15	Private Call Contact	25
Color Code	16	Group Call Contact	25
Call Log	16	New Contact	25
Zone	16	Message	26
Analog Conventional Functions and Operations ..	17	Inbox	26
DMO and RMO	17	Outbox	26
CTCSS/CDCSS Type	17	Drafts	26
CTCSS	17	New Msg	26
CDCSS	18	Preset Msg	26
CDCSS Invert	18	Status Msg	26
Squelch Level	18	Call Log	27
DMR Trunking Functions and Operations	19	Redial or Backdial List	27
Registering	19	Redial List	27
Making a Registration	19	Backdial List	28
Making a Deregistration	19	Hunt	28
Call	19	Short Hunt	28
Private Call	19	Comprehensive Hunt	28
Group Call	21	Team Hunt	29
Emergency Call	24	Background Hunt	29
Broadcast Call	24	Team Hunt List	29
Priority Call	24	Fixed TSCC List	29
Forced Group Call	24	TSCC Hunt	29

Contents

Channel Information	29	Hunt	39
Subgroup	30	Short Hunt	39
Authentication	30	Comprehensive Hunt	39
Remote Remove Radio Service	30	Team Hunt	39
Remote Change Radio Service	30	Background Hunt	39
Emergency	31	Team Hunt List	40
Emergency Call	31	Fixed TSCC List	40
Emergency Alarm	31	TSCC Hunt	40
MPT Trunking Functions and Operations	32	Channel Information	40
Registering	32	Subgroup	41
Making a Registration	32	Emergency	41
Making a Deregistration	32	Optional Accessories	42
Call	32	Troubleshooting	43
Private Call	32	Limited Warranty	44
Group Call	34	Warranty Card	45
All Call	36		
Emergency Call	36		
Broadcast Call	37		
Priority Call	37		
Call Log	37		
Redial or Backdial List	38		
Redial List	38		
Backdial List	38		

■ Important Information

Before using this product, please read this user manual carefully.

■ **Alert Icon**



Caution:

Indicates situations that could cause human injury or damage to your products.



Note:

Indicates tips that can help you make better use of your products.



Caution:

This radio is restricted to occupational use only to satisfy FCC RF energy exposure requirements.

■ Checking Items in the Package

Please unpack carefully and check that all items listed below are received. If any item is missing or damaged, please contact your dealer.

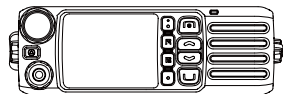

1 Radio



2 Palm Microphone



3 Fuse



4 Microphone Hanger and Screws

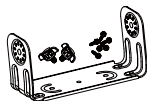

5 Mounting Bracket Kit



6 Power Cord



7 User Manual

■ Getting Started

■ Installation

Installation Diagram

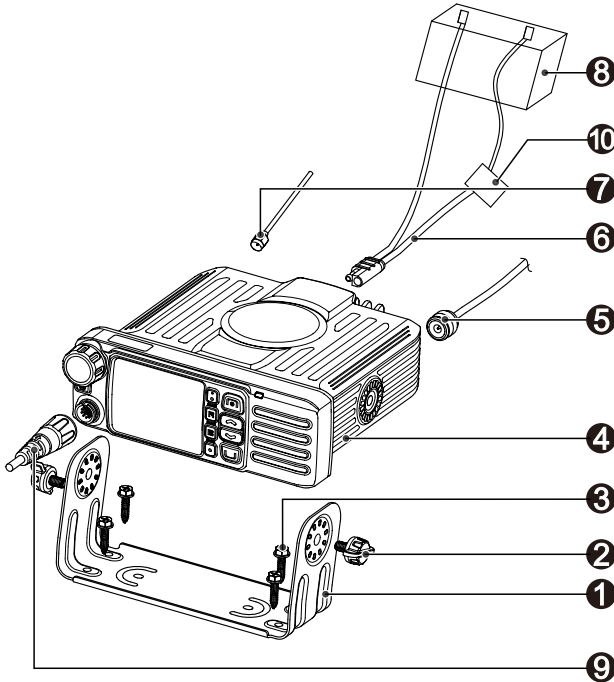

No.	Part Name
①	Bracket
②	Locking Knob
③	Screws
④	Radio
⑤	RF Antenna
⑥	Power Inlet
⑦	GPS Antenna
⑧	Power Supply
⑨	Microphone Jack
⑩	Fuse

1. Slide the radio into the mounting bracket and secure it using the locking knobs.
2. Connect the palm microphone to the radio.
3. Connect the RF antenna to the radio.
4. Connect the GPS antenna to the radio.
5. Connect the power cord to the radio.
6. The Max antenna gain is 3.5dBi.

■ Getting Started

■ Product Overview

Radio Controls

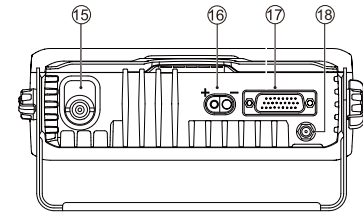
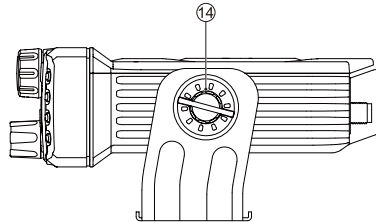
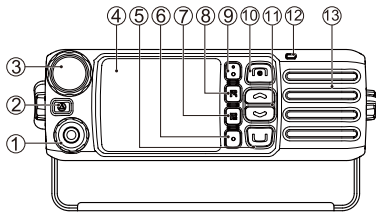

No.	Part Name	No.	Part Name	No.	Part Name
①	Microphone Jack	⑦	P2 Key	⑭	Locking Knob
②	TK (Top Key)	⑧	P1 Key	⑮	RF Antenna Connector
③	Volume Control /Channel Selector /Group Call Selector Knob	⑨	Setting Key	⑯	Power Inlet
		⑩	P4/End/Home Key	⑰	Accessory Jack
④	LCD Display	⑪	Up/Down Key	⑱	GPS Antenna Connector
⑤	P3/Answer/Call Key	⑫	LED Indicator		
⑥	Menu/OK Key	⑬	Speaker		

Palm Microphone

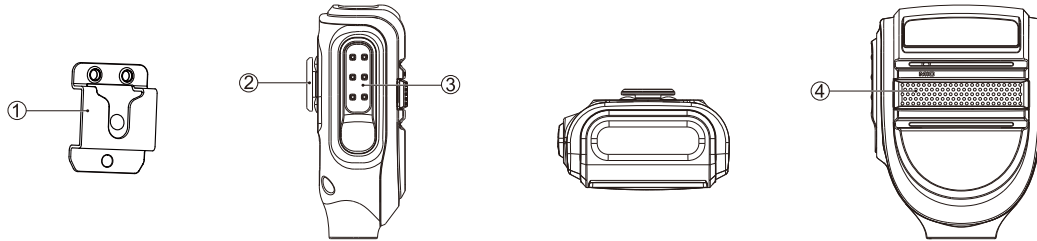





No.	Part Name	No.	Part Name
①	Microphone Hanger	③	PTT Key
②	Microphone Fixing Button	④	Microphone















■ Getting Started

■ LED Indicator

LED Indicator	Radio Status
LED flashes green slowly.	None
LED flashes green rapidly.	Upgrading or powering on
LED glows green.	Receiving
LED flashes red rapidly.	None
LED glows red.	Transmitting
LED flashes orange slowly.	Scanning
LED flashes orange rapidly.	None

■ LCD Icon

Icon	Icon Name
	Received Signal Strength Indicator (RSSI)
	New Message Icon/Full Inbox
	Scanning
	Scan Paused (Conventional)
	High Power

Icon	Icon Name
	Medium Power
	Low Power
	Roam
	GPS
	Glonass
	Missed Call
	Bluetooth
	Wireless PTT Connected
	Bluetooth Headset Connected
	Wireless PTT and Bluetooth Headset Connected
	Emergency Alarm
	Encrypt
	Full Duplex
	Squelch
	VOX

 Note: The above icons may vary with radio configuration. If any change happens, no notice is given due to continuous technology development.

■ Menu Navigation

■ *Mode*

Your radio can operate in either of these modes: Conventional (digital and analog), DMR Trunking, and MPT Trunking.

To access this item, press the **Setting** key in home screen and then select "Function -> Mode".

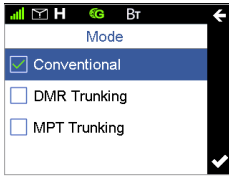

Note: Select "Conventional" to access digital or analog conventional mode.

■ *Device Information*

With this option, you can view basic information of your radio, including radio alias, radio ID, serial number, model name, model number, frequency range, firmware version, front board version, data version, vocoder version, and last programmed date.

To access this item, press the **Setting** key in the home screen and then select "Device Information".

■ *Date and Time*

You can set date and time for your radio.

To access this item, press the **Setting** key in the home screen and then select "General Setting -> Date and Time".

■ *Tone*

This function enables you to set the following tones for your radio: keypad tone, talk permit tone, incoming call tone, function tone, warning tone, low battery tone, emergency alarm tone, and message tone.

To access this item, press the **Setting** key in the home screen and then select "General Setting -> Tone".



Note: If Function Tone is checked, tone indication will be given when you enable or switch some functions (such as toggling power between high, medium, and low, and switching zones) by pressing the programmed buttons.

■ *LED*

This option allows you to decide whether to enable LED indications. You can set the following LEDs for your radio: Tx LED, Rx LED, Scan LED, Low Battery LED, Incoming Call LED, and Call Hold LED.

To access this item, press the **Setting** key in the home screen and then select "General Setting -> LED".

■ Menu Navigation

■ *Display*

This option allows you to set display parameters, including Backlight Off Time, Display Off Mode, and Brightness.

To access this item, press the **Setting** key in the home screen and then select "General Setting -> Display".

■ *Menu Reset*

Your radio supports the menu reset feature. If you do not operate the menu for a predefined time period, the radio will automatically return to the home screen.

To access this item, press the **Setting** key in the home screen and then select "General Setting -> Menu Reset".

■ *Programmable Buttons*

You may set the programmable buttons (P1, P2, P3, P4, Up, Down, and TK) as shortcuts to radio functions (such as power level switch, zone switch, and squelch off) using the CPS.

■ *Noise Reduction*

This option can reduce background noise during communication so as to enhance voice clarity.

You can set this function via the CPS or the radio menu.



Note:

- This feature is off by default. Keep the microphone closer to your mouth with this option enabled because your sound volume will be lower in that condition.
- This feature is applicable to some radios. For details, contact your local dealer.

■ *Transmit Time-Out*

The purpose of Transmit Time-Out is to prevent any user from occupying a channel for an extended period. If the preset time expires, the radio will automatically terminate transmission.

You may set the time via the CPS.

Menu Navigation

Bluetooth

This feature allows you to use your radio with a Bluetooth-enabled device (such as Bluetooth headset and Wireless PTT) via a Bluetooth connection.





Note: This function is applicable to some radios. For details, contact your local dealer.

To access this item, press the **Setting** key in the home screen and then select "Accessories -> Bluetooth".



When the Bluetooth feature is enabled, the Bluetooth icon appears on the status bar. You can find a Bluetooth device by using the Search Devices menu and connect it to your radio.

- When your radio is successfully connected to a Bluetooth headset, the Bluetooth headset connected icon  appears on the status bar.
- When your radio is successfully connected to a Wireless PTT, the Wireless PTT connected icon  appears on the status bar.

- When your radio is successfully connected to a Bluetooth headset and a Wireless PTT, the Bluetooth headset and Wireless PTT connected icon  appears on the status bar.



Note:

- If your radio cannot connect to the Bluetooth device, make sure the device is in pairing mode and then try to connect your radio to the Bluetooth device via the radio menu.
- If your radio fails to connect to the Bluetooth device and the device is in pairing mode, disable and then enable the Bluetooth feature via the radio menu, and search a Bluetooth device and connect your radio to this device via the radio menu.

With the Bluetooth Information option, you can view Bluetooth headset connection status, Wireless PTT connection status, local Bluetooth address, Bluetooth name, and Bluetooth version.

■ Menu Navigation

■ GPS

With this option, you can allow your radio to receive its GPS information from the GPS chipset and upload the information to the system after receiving GPS upload request.

To enable or disable this feature, press the **Setting** key in the home screen and then select "Accessories -> GPS -> Position On/Off".



When the GPS feature is enabled, the icon  appears on the status bar.

If the accurate position of your radio is fixed, the icon  appears on the status bar.

You can check GPS information of your radio by selecting "GPS -> Radio Position".

■ Digital Conventional Functions and Operations

■ *Call*

To ensure that your speech is clear, keep the microphone 2.5 to 5 cm from your mouth.

Private Call

A private call is a call from an individual radio to another individual radio.

You can make a private call through any of the following methods.

- Making a Call through Contact or Call Log

Procedure:

1. Press the **Menu** key to enter the main menu.
2. Go to "Contact -> Private Call Contact", or go to "Call Log" and access the Missed/Incoming/Outgoing Call list.
3. Use the **Up/Down** key to select a private call contact you want to call.
4. Press the **PTT** key to make the private call.

- Making a Call via Manual Dial

Procedure:

1. Press the **Menu** key to enter the main menu.
2. Go to "Contact -> Manual Dial" .
3. Input a private call number using the keypad.
4. Press the **PTT** key to make the private call.

Late Entry

After a private call is established, it allows other radios to join this private call on this channel.

Late Entry may occur in any of the following situations:

- The radio is powered on.
- The **Channel Selector** knob is rotated to the channel in operation.
- Your radio is within the communication coverage of this private call on this channel.

Group Call

A group call refers to a call from an individual radio to a group of radios.

You can make a group call through Contact.

Procedure:

1. Press the **Menu** key to enter the main menu.
2. Go to "Contact -> Group Call Contact".
3. Use the **Up/Down** key to select a group call contact you want to call.
4. Press the **PTT** key to make the group call.

Late Entry

After a group call is established, it allows other group members to join this call.

Late Entry may occur in any of the following situations:

■ Digital Conventional Functions and Operations

- The radio is powered on.
- The **Channel Selector** knob is rotated to the channel in operation.
- The radio exits from another group call.
- The radio is within the communication coverage of this group call.

Rx Group List

With this option, you can receive multiple group calls on a digital channel.

A Rx group list contains a maximum of 64 group calls. You can set up to 32 Rx group lists using the CPS, each of which can be associated with a digital channel.

All Call

An all call is a call from an individual radio to every radio on the channel.



Note: The All Call ID is fixed.

You can make an all call through Contact.

Procedure:

1. Press the **Menu** key to enter the main menu.
2. Go to "Contact -> Group Call Contact".
3. Use the **Up/Down** key to select the All Call contact.
4. Press the **PTT** key to make the all call.

■ Scan

Scan Start Condition

You can start scan only when more than one channel contained in the scan list.

Scan List

For the current scan list, you can choose to perform any of these operations using the Scan List menu: Set as Default, Set Priority, Add a Channel, and Delete.

To access this item, press the **Setting** key in the home screen and then select "Scan -> Scan List".

- If a scan list is checked, you can choose to perform any of these operations in the scan list: Add a Channel, Delete, and Set Priority.
- If None is checked, the scan feature is disabled.

Scan Tx Mode

This option allows you to choose a channel on which the radio will transmit if you press the **PTT** key during scanning. If the Talkback option is disabled (unchecked), the radio will also transmit on this channel if you press the **PTT** key during scan stop.



Note: You can set and view this feature via the CPS.

■ Digital Conventional Functions and Operations

Priority Channel 1

This option allows you to select a channel in the scan list as Priority Channel 1. If only Priority Channel 1 is set, 50% of a radio's scans are on Priority Channel 1 during scanning. If Priority Channel 2 is set as well, scans for Priority Channel 1 and Priority Channel 2 are 25% respectively.



Note: You can set and view this option using the CPS.

Priority Channel 2

This option allows you to select a channel as Priority Channel 2. During scanning, 25% of a radio's scans are on Priority Channel 2 if you have also defined Priority Channel 1. However, if Priority Channel 1 is set to None, scans for Priority Channel 2 will be increased to 50%.



Note: You can set and view this option using the CPS.

Talkback

With this option enabled, your radio will transmit on the current channel if you press the **PTT** key during scan stop.



Note: You can set and view this feature using the CPS.

Scan Delay

This option enables you to set the time that the radio will resume scanning after the end of a valid channel activity. This prevents the radio from resuming a scan immediately upon the loss of activity.



Note: You can set and view this feature via the CPS.

■ Digital Conventional Functions and Operations

■ *Emergency*

Emergency is used to summon help in emergency situations. Your radio supports two types of emergency modes: Emergency Call and Emergency Alarm.

Emergency Call

If the Emergency Call option is selected, your radio only transmits emergency call upon emergency activation. You may follow the procedure below to initiate an emergency call.

Procedure:

1. Log in to the CPS.
2. Go to “Conventional -> General Setting” and associate Emergency On with a programmable button.
3. Go to “Conventional -> Emergency -> Digital Emergency -> Selected Digital System” and set Emergency Type to Regular and Emergency Mode to Emergency Call.
4. Press the programmable button to initiate an emergency call. For example, you can short press the **TK** on your radio to initiate an emergency call if you have associated **TK Short** with Emergency On.

Emergency Alarm

If the Emergency Alarm option is selected, your radio only sends emergency alarm requests upon emergency activation. You may follow the procedure below to initiate an emergency alarm.

Procedure:

1. Log in to the CPS.
2. Go to “Conventional -> General Setting” and associate Emergency On with a programmable button.
3. Go to “Conventional -> Emergency -> Digital Emergency -> Selected Digital System” and set Emergency Type to Regular and Emergency Mode to Emergency Alarm.
4. Press the programmable button to initiate an emergency alarm. For example, you can short press the **TK** on your radio to initiate an emergency alarm if you have associated **TK Short** with Emergency On.

■ Digital Conventional Functions and Operations

■ Message

To access this item, press the **Menu** key in the home screen and then select "Message".

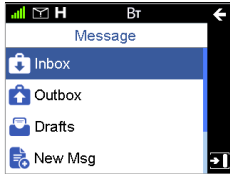

Inbox



The Inbox can save up to 100 received messages.

The prompt "The Inbox will be full, please delete messages!" appears if a new message is received when 90 messages are available in the Inbox. When the Inbox is full, the oldest message will be overwritten by the latest one automatically.

Outbox

The Outbox can save up to 100 sent messages.

The following icons will appear to indicate whether the message is sent successfully.

-  : The message is sent successfully.
-  : The message is not sent successfully. In this case, you can resend it.

When the Outbox is full, the oldest message will be overwritten by the latest one automatically.

Drafts

The Drafts can save up to 100 draft messages.

When the Drafts is full, the oldest message will be overwritten by the latest one automatically.

New Msg

You can create a new text message (179 characters at most) and save it to Drafts, or send it to a private or group call contact.

Preset Msg

Under this option there are some text messages (10 entries at most) preset by your dealer. You can choose to send any entry to a private or group call contact.

Status Msg

Under this option there are some status messages (95 entries at most) preset by your dealer. Only the status code is displayed and so the content of the message is not able to be viewed during transmission. You can choose to send any entry to a private or group call contact.

■ Digital Conventional Functions and Operations

■ Color Code

Color code is used to identify a system. Users who wish to communicate with each other are assigned with the same color code. A radio ignores the channel activity which does not match the preset color code in this field, as it assumes the activity belongs to other systems.

■ Call Log

To access this item, press the **Menu** key in the home screen and then select "Call Log", or press the shortcut key for Call Log directly.

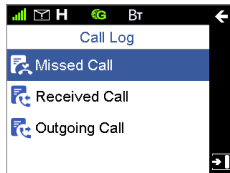

The radio can save up to 200 call entries under this option. When the Call Log is full, the oldest entry will be overwritten by the latest one automatically.

- For each call entry, you can choose to perform any of these operations: Initiate a Call through PTT Press, View, and Delete.

- To delete all call entries in the Missed/Incoming/Outgoing Call list, select "Call Log -> Missed/Incoming/Outgoing Call -> Selected Call -> Delete All".

■ Zone

A zone is a group of channels. Your radio supports up to 2048 channels and 32 zones, with a maximum of 64 channels per zone.

You may select a zone through any of the following methods.

- Selecting a Zone through the Zone Menu

Procedure:

1. Press the **Setting** key in the home screen.
2. Go to "Zone".
3. Use the **Up/Down** key to select a desired zone.
4. Press the **OK** key to switch to the selected zone.

- Selecting a Zone through the Programmable Button
If you set shortcut for Zone Up/Down, press the shortcut key to turn to the desired zone.

■ Analog Conventional Functions and Operations

■ *DMO and RMO*

Your radio supports both DMO and RMO modes.

- **DMO:** You can set the Rx frequency of your radio to be consistent with the Tx frequency using the CPS. In DMO mode, your radio can communicate directly with another radio.
- **RMO:** You can set the Rx frequency of your radio to be different from the Tx frequency via the CPS. In this mode, your radio can communicate with another radio of the same frequency configuration via a repeater.

■ *CTCSS/CDCSS Type*

This option allows you to configure the current channel with a specific Rx CTCSS/CDCSS type. When the radio receives the signal, it will distinguish whether the received signal is CTCSS or CDCSS, and check out whether it matches the predefined CTCSS/CDCSS for the current channel before processing.

Three types are available: CTCSS, CDCSS, and CDCSS Invert.



Note: CDCSS is also known as DCS.

CTCSS

The radio checks for CTCSS match when receiving a signal on the current channel.

Follow the procedure below to set CTCSS/CDCSS Type to CTCSS.

Procedure:

1. Log in to the CPS.
2. Go to “Conventional -> Channel -> Analog Channel -> Selected Analog Channel” and set Rx/Tx CTCSS/CDCSS Type to CTCSS.

■ Analog Conventional Functions and Operations

CDCSS

The radio checks for CDCSS match when receiving a signal on the current channel.

Follow the procedure below to set CTCSS/CDCSS Type to CDCSS.

Procedure:

1. Log in to the CPS.
2. Go to “Conventional -> Channel -> Analog Channel -> Selected Analog Channel” and set Rx/Tx CTCSS/CDCSS Type to CDCSS.

CDCSS Invert

The radio checks for an invert CDCSS match when receiving a signal on the current channel.

Follow the procedure below to set CTCSS/CDCSS Type to CDCSS Invert.

Procedure:

1. Log in to the CPS.
2. Go to “Conventional -> Channel -> Analog Channel -> Selected Analog Channel” and set Rx/Tx CTCSS/CDCSS Type to CDCSS Invert.

■ *Squelch Level*

This option can reduce background noise by adjusting the squelch level when the radio is receiving signals. You may set the squelch level to Tight, Normal, or Open using the CPS. Normal squelch level is the default. Tight squelch level can filter weak signals, and allow only strong signals to be received. If the squelch level is set to Open (This parameter value is 0), the radio will turn on the speaker and background noise will be heard.

■ DMR Trunking Functions and Operations



Note: A license is required for accessing the DMR trunking system. Contact your dealer for details.

■ **Registering**

The radio will register with a proper base station automatically according to CPS configuration after power-on.

Making a Registration

For correct operation, the radio will register with an appropriate base station automatically through any of these methods after power-on.

- After being programmed, the radio will register for the first time by hunting the Fixed TSCC List. See Hunt for more details.
- The radio will hunt for the last 10 control channels on which it has worked after power-on. See Hunt for more details.
- You may allow your radio to register with another base station by inputting the ID of an available control channel. See Hunt for more details.

Making a Deregistration

Your radio will cancel the registration with a base station through any of these methods.

- The radio is powered off.

- The radio registers with another base station.

■ **Call**

To ensure that your speech is clear, keep the microphone 2.5 to 5 cm from your mouth.

Private Call

You can set the type of private call to FOACSU or OACSU via base station.

- FOACSU: During call setup, the calling radio rings. The called party answers a call manually.
- OACSU: During call setup, the calling radio does not ring. The called party answers a call automatically.

Making a Private Call

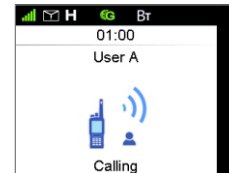

You can make a private call through any of the following methods.

DMR Trunking Functions and Operations



● Making a Call through Contact or Call Log

Procedure:

1. Press the **Menu** key to enter the main menu.
2. Go to "Contact -> Private Call Contact", or go to "Call Log" and access the Missed/Incoming/Outgoing Call list.
3. Use the **Up/Down** key to select the private call contact you want to call.
4. Press the  or **PTT** key to make the private call.



● Making a Call via Manual Dial

Procedure:

1. In the home screen, input a private call number using the keypad.
2. Press the , **PTT**, or  key to make the private call.

● Making a Call through Redial or Backdial List

Procedure:

1. In the home screen, press the  or  key to access the Redial or Backdial List.
2. Use the **Up/Down** key to select the private call contact you want to call.
3. Press the  or **PTT** key to make the private call.



Note: The private call cannot be made if the radio has not registered.

Receiving a Private Call

When a private call is received, the alert tone is given and the incoming call icon is displayed on the LCD display.



Note: Ring tones will be available if FOACSU is checked in the system for the base station with which your radio registers.

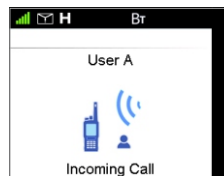

The first text line displays the caller alias or ID.



Note: You may answer the call without any operation if this private call is set as OACSU.

Voice Communication

After a private call is established, either the calling party or the called party can make a voice call only if the **PTT** key is free with both parties staying on the PTT admit screen (Appearing after a call is established with no talks of either party within a preset time and remaining until the preset time expires).

■ DMR Trunking Functions and Operations

Conversation Limit

When a private call is established, both the calling party and the called party will display the call duration in real time.



- At the Calling Party

A countdown timer is displayed to the calling party to show the remaining time for a call. The time period is programmed by your dealer. The private call will be terminated automatically when the preset time expires.

- At the Called Party

The called party displays the actual communication time.

Ending a Call

The voice communication will be terminated when one of the following situations occurs:



- No operation (PTT key press) is performed within the preset time (programmable).
- The preset time expires.

- The calling party ends the ongoing call.
- Signal of base station is missing.

Group Call

Making a Group Call



You can make a group call through any of the following methods.

- Making a Call to the Preset Contact
In the home screen, press the **PTT** key to make a group call to the group call contact preset for the **Group Call Selector** knob.
- Making a Call through Group Call Contact
Procedure:
 1. Press the **Menu** key to enter the main menu.
 2. Go to "Contact -> Group Call Contact".
 3. Use the **Up/Down** key to select the group call contact you want to call.
 4. Press the  or **PTT** key to make the group call.
- Making a Call via Manual Dial
Procedure:
 1. In the home screen, input a group call number using the keypad.
 2. Press the , **PTT**, or  key to make the group call.

■ DMR Trunking Functions and Operations

- Making a Call through Redial or Backdial List

Procedure:

1. In the home screen, press the  or  key to access the Redial or Backdial List.
2. Use the **Up/Down** key to select the group call contact you want to call.
3. Press the  or **PTT** key to make the group call.

Receiving a Group Call

You can receive the call without any operation. The alert tone is given and the incoming call icon is displayed on the LCD display.

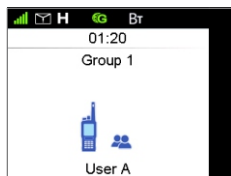

Late Entry

After a group call is established, it allows other group members to join this call.

Late Entry may occur in any of the following situations:

- The radio is powered on.

- The **Group Call Selector** knob is rotated to the group in operation.
- The radio exits from another group call.
- The called party ends the ongoing call and rejoins it later.
- The radio is within the communication coverage of this group call.

Group Call Combination

After a group call is established, you can input the group ID or select the group from Group Call Contact to join the current group call.

Voice Communication

After a group call is established, either the calling party or the called party can make a voice call only if the **PTT** key is free with both parties staying on the PTT admit screen.

■ DMR Trunking Functions and Operations

Conversation Limit

When a group call is established, both the calling party and the called party will display the call duration in real time.



- At the Calling Party

A countdown timer is displayed to the calling party to show the remaining time for a call. The time period is programmed by your dealer. The group call will be terminated automatically when the preset time expires.

- At the Called Party

The called party displays the actual communication time. The timer starts counting once the called party joins the group call. If the called party takes the initiative to exit from this call and then rejoins it later through the late entry method, the counter restarts.

Ending a Call

The voice communication will be terminated when one of the following situations occurs:

- No operation (**PTT** key press) is performed within the preset time (programmable).
- The preset time expires.
- The calling party ends the ongoing call.
- Signal of base station is missing.

■ DMR Trunking Functions and Operations

Emergency Call

Emergency Call can be either emergency private or group call.

You may make an emergency call through any of these methods.



- Making a Call through the TK

Press and hold the **TK** to initiate an emergency call.

In the DMR system, you should set the called number using the CPS.

- Making a Call via Manual Dial

Procedure:



1. In the home screen, input “#9* + called number” using the keypad.
2. Press the  , **PTT** , or  key to make the call.

Broadcast Call

Broadcast call can only be a broadcast group call. In a broadcast call, the calling party can only transmit voice signals and the called party can only receive them.

Follow the procedure below to make a broadcast call.

Procedure:

1. In the home screen, input “#1* + called number” using the keypad.
2. Press the  , **PTT** , or  key to make the call.

Priority Call

In the normal voice calls, priority call has the highest priority. You may follow the procedure below to make a priority call.



Procedure:

1. In the home screen, input “#8* + called number” using the keypad.
2. Press the  , **PTT** , or  key to make the call.

Forced Group Call

Private call manual dial is available in the home screen by default. You can switch the private call manual dial to the group call manual dial and make a group call as follows.

Procedure:

1. In the home screen, input “#6* + called number” using the keypad.
2. Press the  , **PTT** , or  key to make the call.

■ DMR Trunking Functions and Operations

■ Contact

To access this item, press the **Menu** key in the home screen and then select "Contact".

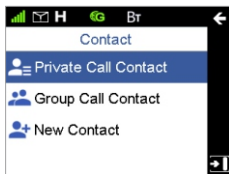

Private Call Contact

You can save up to 256 entries of private call contact information in the list. To access this item, select "Contact -> Private Call Contact", or press the shortcut key programmed via the CPS for Contact and then select "Private Call Contact".

- For each private call contact, you can choose to perform any of these operations: View, Edit, and Delete.
- To delete all private call contacts in the list, select "Contact -> Private Call Contact -> Selected Contact -> Delete All".

Group Call Contact

You can save up to 256 entries of group call contact information in the list. To access this list, select "Contact -> Group Call Contact".

For each group call contact, you can choose to perform any of these operations: View, Edit, and Delete.

New Contact

You can add a new contact to the Private or Group Call Contact list.

- The ID of each private call contact must be unique.
- The alias of each private call contact can contain 16 characters at most and the ID is made up of 8 digits. Set the ID according to the dial rules.



Note: You can press the **#*** key on the keypad to switch the input method when editing the alias.

■ DMR Trunking Functions and Operations

■ Message

To access this item, press the **Menu** key in the home screen and then select “Message”.

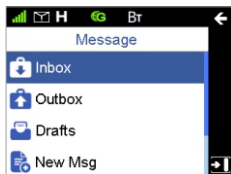

Inbox



The Inbox can save up to 100 received messages.

The prompt “The Inbox will be full, please delete messages!” will appear if a new message is received when 90 messages are available in the Inbox. When the Inbox is full, the oldest message will be overwritten by the latest one automatically.

Outbox

The Outbox can save up to 100 sent messages.

The following icons will appear to indicate whether the message is sent successfully.

-  : The message is sent successfully.
-  : The message is not sent successfully. In this case, you can resend it.

When the Outbox is full, the oldest message will be overwritten by the latest one automatically.

Drafts

The Drafts can save up to 100 draft messages.

When the Drafts is full, the oldest message will be overwritten by the latest one automatically.

New Msg

You can create a new text message (179 characters at most) and save it to Drafts, or send it to a private or group call contact.

Preset Msg

Under this option there are some text messages (10 entries at most) preset by your dealer. You can choose to send any entry to a private or group call contact.

Status Msg

Under this option there are some status messages (95 entries at most) preset by your dealer. Only the status code is displayed and so the content of the message is not able to be viewed during transmission. You can choose to send any entry to a private or group call contact.

■ DMR Trunking Functions and Operations

■ Call Log

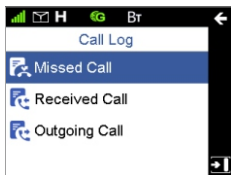

To access this item, press the **Menu** key in the home screen and then select "Call Log".



The radio can save up to 200 call entries under this option. When the Call Log is full, the oldest entry will be overwritten by the latest one automatically.

- For each call entry, you can choose to perform any of these operations: View and Delete.
- To delete all call entries in the Missed/Incoming/Outgoing Call list, select "Call Log -> Missed/Incoming/Outgoing Call-> Selected Call -> Delete All".

■ Redial or Backdial List

To access the Redial or Backdial List, press the  or  key in the home screen.

Either of the two lists can save up to 10 entries. When the list is full, the oldest entry will be overwritten by the latest one automatically.

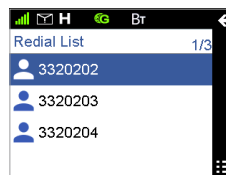

Redial List

All outgoing calls are saved in the Redial List.



You may follow the procedure below to make a call through the Redial List.

Procedure:

1. In the home screen, press the  key to access the Redial List.
 2. Press the **Up/Down** key to select an entry you want to call.
 3. Press the  or **PTT** key to make the call.
- For each call entry, you can choose to perform any of these operations: View and Delete.
 - To delete all call entries in the list, select "Redial List -> Selected Call -> Delete All".

■ DMR Trunking Functions and Operations



Backdial List

All incoming calls are saved in the Backdial List.



You may follow the procedure below to make a call through the Backdial List.

Procedure:

1. In the home screen, press the  key to access the Backdial List.
 2. Press the **Up/Down** key to select an entry you want to call.
 3. Press the  or **PTT** key to make the call.
- For each call entry, you can choose to perform any of these operations: View and Delete.
 - To delete all call entries in the list, select "Backdial List -> Selected Call -> Delete All".

■ Hunt

In the DMR system, the terminal is required to register with a base station for normal work. Before registering, the terminal will hunt through the control channels for available base stations. The system provides multiple hunt policies for the registered terminals to ensure normal communications.

Last Registered List: This list saves the last 10 control channels on which the radio has worked prior to power-off.



Note: You cannot view the Last Registered List on the UI because it runs in the background.

Short Hunt

The radio will hunt for the last 10 control channels on which it has worked. If the radio fails to register on all the 10 channels, it will go on with the Fixed TSCC List. The hunt process will cycle until the radio successfully registers with a base station.

Comprehensive Hunt

Short hunt would be performed preferentially. If short hunt brings no successful registration, comprehensive hunt will go from the channel defined at Minimum. Every 100 channels are hunted during comprehensive hunt, the previously said 10 channels will be hunted again. If no successful registration

■ DMR Trunking Functions and Operations

is achieved after comprehensive hunt, the hunt will go on with the Fixed TSCC List. The hunt process will cycle until the radio successfully registers with a base station.

Team Hunt

The radio will hunt for the last 10 control channels on which it has worked. If the radio fails to register on all the 10 channels, it will go on to hunt the channel team available in the Team Hunt List. The hunt process will cycle until the radio successfully registers with a base station.

Background Hunt

This option allows you to determine whether to enable the background hunt feature.

To access this item, press the **Setting** key in the home screen and then select "Hunt - > Background Hunt", or press the shortcut for Background Hunt directly in the home screen.

Team Hunt List

This option is used to determine whether a selected channel team to be searched repeatedly during radio registration.

- **Fixed:** After an available control channel is found during scanning and you select Fixed, the radio will register with this channel and save the channel team which the registered channel belongs to. When the signal of the

channel on which the radio currently registers is lost, it will hunt through the channels available in the saved channel team.

- **Temporary:** After an available control channel is found during scanning and you select Temporary, the radio will register with this channel and will not save the channel team which the registered channel belongs to. When the signal of the current channel on which the radio currently registers is lost, it will hunt according to power-on hunt policies.

Fixed TSCC List

This list shows all the control channels set via the CPS. Your radio may hunt through the control channels for available base stations.

TSCC Hunt

With this option, you can enable your radio to register with a base station by inputting the ID of an available control channel.

Channel Information

With this option, you can view information about the channel on which your radio registers, including channel ID, time slot, RSSI, and system code.

■ DMR Trunking Functions and Operations

■ *Subgroup*

A subgroup is a group of group call contacts. Your radio supports up to 2048 group call contacts and 32 subgroups, with a maximum of 64 group call contacts per subgroup.

You can view members in each subgroup and set a desired subgroup as the default one.

You may select a subgroup through any of the following methods.

- Selecting a Subgroup through the Subgroup Menu

Procedure:

1. Press the **Setting** key in the home screen.
2. Go to "Subgroup".
3. Use the **Up/Down** key to select a desired subgroup.
4. Press the **OK** key to switch to the selected subgroup.

- Selecting a Subgroup through the Programmable Button

If you set shortcut for Subgroup Up/Down, press the shortcut key to turn to the desired subgroup.

■ *Authentication*

Authentication is used to ensure the validity of user accounts in the network. It operates in a way that the base station authenticates the validity of the radio. After the radio passes the authentication by the base station, the services can be processed.

■ *Remote Remove Radio Service*

The authorized dispatcher is able to permanently disable a radio remotely. The disabled radio cannot perform any operation (including requesting or receiving calls or SMSs) and can be revived only by your dealer or system administrator.

■ *Remote Change Radio Service*

The authorized dispatcher is able to temporarily disable a radio remotely. The disabled radio cannot request or receive any user initiated services (such as call and SMS). However, registration and report services remain active. If necessary, the dispatcher can enable the disabled radio to recover its normal services (such as call and SMS).

■ DMR Trunking Functions and Operations

■ *Emergency*

Emergency Call

If the Emergency Call option is selected, your radio only transmits emergency call upon emergency activation. You may follow the procedure below to initiate an emergency call.

Procedure:

1. Log in to the CPS.
2. Go to “DMR Trunking -> General Setting” and associate Emergency On with a programmable button.
3. Go to “DMR Trunking -> Security” and set Emergency Mode to Emergency Call and input the emergency number.
4. Press the programmable button to initiate an emergency call. For example, you can short press the **TK** on your radio to initiate an emergency call if you have associated **TK Short** with Emergency On.

Emergency Alarm

If the Emergency Alarm option is selected, your radio only sends emergency alarm requests upon emergency activation. You may follow the procedure below to initiate an emergency alarm.

Procedure:

1. Log in to the CPS.
2. Go to “DMR Trunking -> General Setting” and associate Emergency On with a programmable button.
3. Go to “DMR Trunking -> Security” and set Emergency Mode to Emergency Alarm and input the emergency number.
4. Press the programmable button to initiate an emergency alarm. For example, you can short press the **TK** on your radio to initiate an emergency alarm if you have associated **TK Short** with Emergency On.

■ MPT Trunking Functions and Operations



Note: A license is required for accessing the MPT trunking system. Contact your dealer for details.

■ **Registering**

The radio will register with a proper base station automatically according to CPS configuration after power-on.

Making a Registration

For correct operation, the radio will register with an appropriate base station automatically through any of these methods after power-on.

- After being programmed, the radio will register for the first time by hunting the Fixed TSCC List. See Hunt for more details.
- The radio will hunt for the last 10 control channels on which it has worked after power-on. See Hunt for more details.
- You may allow your radio to register with another base station by inputting the ID of an available control channel. See Hunt for more details.

Making a Deregistration

Your radio will cancel the registration with a base station when one of the following situations occurs.

- The radio is powered off.
- The radio registers with another base station.

■ **Call**

To ensure that your speech is clear, keep the microphone 2.5 to 5 cm from your mouth.

Private Call

Making a Private Call

You can make a private call through any of the following methods.



- Making a Call through Contact or Call Log

Procedure:

1. Press the **Menu** key to enter the main menu.
2. Go to "Contact -> Private Call Contact", or go to "Call Log" and access the Missed/Incoming/Outgoing Call list.
3. Use the **Up/Down** key to select the private call contact you want to call.
4. Press the  or **PTT** key to make the private call.

- Making a Call via Manual Dial



Procedure:

1. In the home screen, input a private call number using the keypad.
2. Press the , **PTT**, or  key to make the private call.

MPT Trunking Functions and Operations

- Making a Call through Redial or Backdial List

Procedure:

1. In the home screen, press the  or  key to access the Redial or Backdial List.
2. Use the **Up/Down** key to select the private call contact you want to call.
3. Press the  or **PTT** key to make the private call.



Note: The private call cannot be made if the radio has not registered.

Receiving a Private Call

When a private call is received, the alert tone is given.



Note: Ring tones will be available if FOACSU is checked in the system for the base station with which your radio registers.

The first text line displays the caller alias or ID.

Voice Communication

After a private call is established, either the calling party or the called party can make a voice call only if the **PTT** key is free with both parties staying on the PTT admit screen (Appearing after a call is established and remaining until the call is terminated).

Conversation Limit

When a private call is established, both the calling party and the called party will display the call duration in real time.

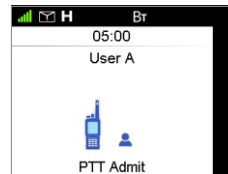

- At the Calling Party
A countdown timer is displayed to the calling party to show the remaining time for a call. The time period is programmed by your dealer. The private call will be terminated automatically when the preset time expires.
- At the Called Party
The called party displays the actual communication time.

■ MPT Trunking Functions and Operations

Ending a Call

The voice communication will be terminated when one of the following situations occurs:

- The preset time expires.
- The calling party ends the ongoing call.
- Signal of base station is missing.

Group Call



Making a Group Call

You can make a group call through any of the following methods.

- Making a Call to the Preset Contact
In the home screen, press the **PTT** key to make a group call to the group call contact preset for the **Group Call Selector** knob.
- Making a Call through Group Call Contact
Procedure:
 1. Press the **Menu** key to enter the main menu.
 2. Go to "Contact -> Group Call Contact".
 3. Use the **Up/Down** key to select the group call contact you want to call.
 4. Press the  or **PTT** key to make the group call.



- Making a Call via Manual Dial

Procedure:

1. In the home screen, input a group call number using the keypad.
2. Press the , **PTT**, or  key to make the group call.

- Making a Call through Redial or Backdial List

Procedure:

1. In the home screen, press the  or  key to access the Redial or Backdial List.
2. Use the **Up/Down** key to select the group call contact you want to call.
3. Press the  or **PTT** key to make the group call.

Receiving a Group Call

You can receive the call without any operation. The alert tone is given and the incoming call icon is displayed on the LCD display. The first text line displays the group caller alias or ID that is programmed via the CPS.

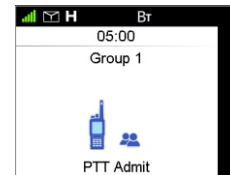

■ MPT Trunking Functions and Operations

Late Entry

After a group call is established, it allows other group members to join this call.

Late Entry may occur in any of the following situations:

- The radio is powered on.
- The **Group Call Selector** knob is rotated to the group in operation.
- The radio exits from another group call.
- The called party ends the ongoing call and rejoins it later.
- The radio is within the communication coverage of this group call.

Group Call Combination

After a group call is established, you can input the group ID or select the group from Group Call Contact to join the current group call.

Number Prefix Ignored During Group Call

You can make a call to a group of users no matter their number prefixes are the same or not.

Join a Group Call via Manual Dial

You can initiate a group call by inputting the group ID that is not covered in Group Call Contact using the keypad. After the group call ends, this group will be added into Group Call Contact and will not be available in Group Call Contact after you restart your radio.

Voice Communication

After a group call is established, either the calling party or the called party can make a voice call only if the **PTT** key is free with both parties staying on the PTT admit screen.

Conversation Limit

When a group call is established, both the calling party and the called party will display the call duration in real time.

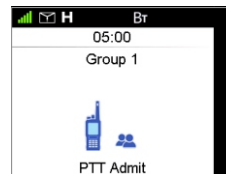

- At the Calling Party
A countdown timer is displayed to the calling party to show the remaining time for a call. The time period is

■ MPT Trunking Functions and Operations

programmed by your dealer. The group call will be terminated automatically when the preset time expires.

- **At the Called Party**

The called party displays the actual communication time. The timer starts counting once the called party joins the group call. If the called party takes the initiative to exit from this call and then rejoins it later through the late entry method, the counter restarts.

Ending a Call

The voice communication will be terminated when one of the following situations occurs:

- The preset time expires.
- The calling party ends the ongoing call.
- Signal of base station is missing.

All Call

All Call in System is available in the MPT system.



All Call in System

1981 is the All Call in System number. When you make an All Call in System by dialing "**1981", all members in this system will join this call.

You can make an All Call in System through one of the following methods: making a call to the preset contact, making a call through group call contact, and making a call via manual dial. The operations are the same as those in Group Call. For details, see Group Call.

Emergency Call

Emergency call can be either emergency group or private call. You may make an emergency call through any of the following methods:

- **Making a Call through the TK**
Press and hold the **TK** to initiate an emergency call. In the MPT system, you should set the called number using the CPS.
- **Making a Call via Manual Dial**
Procedure:
 1. In the home screen, input "**9* + called number" using the keypad.
 2. Press the  , **PTT**, or  key to make the call.



■ MPT Trunking Functions and Operations

Broadcast Call

Broadcast call can only be broadcast group call. In a broadcast call, the calling party can only transmit voice signals and the called party can only receive them.

Follow the procedure below to make a broadcast call.

Procedure:



1. In the home screen, input "*11* + called number" using the keypad.
2. Press the  , PTT, or  key to make the call.

Priority Call

You may set the call priority level to low, medium, high, or preemption via the CPS. Preemption call has the highest priority.

Follow the procedure below to make a priority call.

Procedure:

1. In the home screen, input "*8* + called number" using the keypad.
2. Press the  , PTT, or  key to make the call.

■ Call Log

To access this item, press the **Menu** key in the home screen and then select "Call Log".

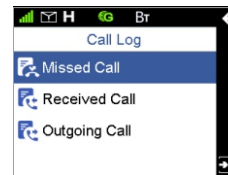



This radio can save up to 200 call entries under this option. When the Call Log is full, the oldest entry will be overwritten by the latest one automatically.

- For each call entry, you can choose to perform any of these operations: View and Delete.
- To delete all call entries in the Missed/Incoming/Outgoing Call list, select "Call Log -> Missed/Incoming/Outgoing Call -> Selected Call -> Delete All".

■ MPT Trunking Functions and Operations

■ *Redial or Backdial List*

To access the Redial or Backdial List, press the  or  key in the home screen. Either of the two lists can save up to 10 entries. When the lists are full, the oldest entry will be overwritten by the latest one automatically.



Redial List

All outgoing calls are saved in the Redial List.



You may follow the procedure below to make a call through the Redial List.

Procedure:

1. In the home screen, press the  key to access the Redial List.
 2. Press the **Up/Down** key to select an entry you want to call.
 3. Press the , **PTT**, or  key to make the call.
- For each call entry, you can choose to perform any of these operations: View and Delete.

- To delete all call entries in the list, select "Redial List -> Selected Call -> Delete All".



Backdial List

All incoming calls are saved in the Backdial List.



You may follow the procedure below to make a call through the Backdial List.

Procedure:

1. In the home screen, press the  key to access the Backdial List.
 2. Press the **Up/Down** key to select an entry you want to call.
 3. Press the  or **PTT** key to make the call.
- For each call entry, you can choose to perform any of these operations: View and Delete.
 - To delete all call entries in the list, select "Backdial List -> Selected Call -> Delete All".

■ MPT Trunking Functions and Operations

■ *Hunt*

In the MPT system, the terminal is required to register with a base station for normal work. Before registering, the terminal will hunt through the control channels for available base stations. The system provides multiple hunt policies for the registered terminals to ensure normal communications.

Last Registered List: This list saves the last 10 control channels on which it has worked prior to power-off.



Note: You cannot view the Last Registered List on the UI because it runs in the background.

Short Hunt

The radio will hunt for the last 10 control channels on which it has worked. If the radio fails to register on all the 10 channels, it will go on with the Fixed TSCC List. The hunt process will cycle until the radio successfully registers with a base station.

Comprehensive Hunt

Short hunt would be performed preferentially. If short hunt brings no successful registration, comprehensive hunt will go from the channel defined at Minimum. Every 100 channels are hunted during comprehensive hunt, the previously said 10 channels will be hunted again. If no successful registration is achieved after comprehensive hunt, the hunt will go on

with the Fixed TSCC List. The hunt process will cycle until the radio successfully registers with a base station.

Team Hunt

The radio will hunt for the last 10 control channels on which it has worked. If the radio fails to register on all the 10 channels, it will go on to hunt the channel team available in the Team Hunt List. The hunt process will cycle until the radio successfully registers with a base station.

Background Hunt

This option allows you to determine whether to enable the background hunt feature.

To access this item, press the **Setting** key in the home screen and then select "Hunt - > Background Hunt", or press the shortcut for Background Hunt directly in the home screen.

■ MPT Trunking Functions and Operations

Team Hunt List

This option is used to determine whether a selected channel team to be searched repeatedly during radio registration.

- **Fixed:** After an available control channel is found during scanning and you select Fixed, the radio will register with this channel and save the channel team which the registered channel belongs to. When the signal of the channel on which the radio currently registers is lost, it will hunt through the channels available in the saved channel team.
- **Temporary:** After an available control channel is found during scanning and you select Temporary, the radio will register with this channel and will not save the channel team which the registered channel belongs to. When the signal of the current channel on which the radio currently registers is lost, it will hunt according to power-on hunt policies.

Fixed TSCC List

This list shows all the control channels set via the CPS. Your radio may hunt through the control channels for available base stations.

TSCC Hunt

With this option, you can enable your radio to register with a base station by inputting the ID of an available control channel.

Channel Information

With this option, you can view information about the channel on which your radio registers, including channel ID, time slot, RSSI, and system code.

■ MPT Trunking Functions and Operations

■ *Subgroup*

A subgroup is a group of group call contacts. Your radio supports up to 2048 group call contacts and 32 subgroups, with a maximum of 64 group call contacts per subgroup.

You can view members in each subgroup and set a desired subgroup as the default one.

You may select a subgroup through any of the following methods.

- Selecting a Subgroup through the Subgroup Menu

Procedure:

1. Press the **Setting** key in the home screen.
2. Go to "Subgroup".
3. Use the **Up/Down** key to select a desired subgroup.
4. Press the **OK** key to switch to the selected subgroup.

- Selecting a Subgroup through the Programmable Button

If you set shortcut for Subgroup Up/Down, press the shortcut key to turn to the desired subgroup.

■ *Emergency*

Your radio supports one emergency mode: Emergency Call. You may follow the procedure below to initiate an emergency call.

Procedure:

1. Log in to the CPS.
2. Go to "MPT Trunking -> General Setting" and associate Emergency On with a programmable button.
3. Go to "MPT Trunking -> Security" and set Emergency Mode to Emergency Call and input the emergency number.
4. Press the programmable button to initiate an emergency call. For example, you can short press the **TK** on your radio to initiate an emergency call if you have associated **TK Short** with Emergency On.

Optional Accessories

The following items are the main optional accessories for the product. Consult your local dealer for more other accessories.



GPS Antenna
EAS157501



Sucker Antenna



Wireless PTT
EPTTB01



Bluetooth Headset
EEWB03E



Programming Cable
EPC02



Keypad Microphone
EMKA011



Power Supply
EEPS01



Vehicle Remote Control
Head Mount Kit
ERC01



Motorcycle Remote Control
Head Mount Kit
ERC02



Caution: Use the accessories specified by the Company only. Otherwise, the Company shall not be liable for losses or damages arising out of use of unauthorized accessories.

Troubleshooting

Phenomena	Analysis	Solution
The radio cannot be powered on.	The battery may be improperly installed.	Remove the battery and attach it again.
	The battery may run out.	Recharge or replace the battery.
	The battery may suffer from poor contact caused by dirty or damaged battery contacts.	Clean the battery contacts. If the problem cannot be solved, contact your dealer or authorized service center for inspection and repair.
The radio cannot register successfully.	The radio may not detect signals from the base station.	Make sure you are within the coverage of the base station.
	The radio may not be authorized.	Contact the base station manager to check whether you are an authorized subscriber in the network management system.
The radio registers repeatedly.	The signal is discontinuous.	Make sure you are within the coverage of the base station.
The radio cannot establish a call.	The signal is poor.	Make sure you are within the coverage of the base station.
No voice is heard after a call is established.	Your ID may be repeated.	Contact the base station manager to check whether your ID is repeated in the network management system.
The called party disconnects repeatedly during communication.	The signal is discontinuous.	Make sure you are within the coverage of the base station.
During receiving, the voice is weak, discontinuous, or totally inactive.	Low battery	Recharge or replace the battery.
	The volume may be set to a low level.	Increase the volume by rotating the Volume Control knob clockwise.
	The antenna may get loose or improperly installed.	Power off the radio, reinstall the antenna and power on the radio again.
	The speaker may be blocked or damaged.	Clean surface of the speaker. If the problem cannot be solved, contact your local dealer or authorized service center for inspection and repair.
You cannot communicate with other members.	The signal is poor.	Make sure you are within the communication range.
The voice is unclear.	The signal is poor.	Make sure you are within the communication range.
The noise is too loud.	The signal is poor.	Make sure you are within the communication range.
	You may be at an unfavorable position. For example, your communication may be blocked by high buildings or frustrated in the underground areas.	Move to an open and flat area and restart the radio.
	You may suffer from external disturbance (such as electromagnetic interference).	Stay away from equipment that may cause interference.

If the above solutions cannot fix your problems, or you may have some other queries, please contact us or your local dealer for more technical support.

■ Limited Warranty

What This Warranty Covers and for How Long

Shenzhen Excera Technology Co., Ltd. warrants the Excera manufactured products listed below against defects in material and workmanship under normal use and service for a period of time from the date of purchase as scheduled below:

EM8100 U2 Digital Mobile Radios	Two Years
Accessories	Six Months

How to Get Warranty Service

You must provide a completely filled warranty card, purchase invoice, and receipt in order to get warranty services. The purchase invoice or receipt should indicate the radio, accessories, radio serial number, purchase date, and purchase amount.

What This Warranty Does Not Cover

1. Defect or damage resulting from use of the product in other than its normal and customary manner
2. Defect or damage caused by unauthorized product disassembly, repair, or modification
3. Damage due to force majeure, such as flood, lightning strike, earthquake, tsunami, fire, and abnormal voltage
4. Product that does not have a valid warranty certificate, such as warranty card, purchase invoice, or receipt
5. Product which has had the serial number and the tamper-proof label removed or made illegible
6. Normal and customary wear and tear
7. Rechargeable batteries if:
 - (1) any of the seals on the battery enclosure of cells is broken or shows evidence of tampering.
 - (2) the damage or defect is caused by charging or using the battery in equipment or service other than the product for which it is specified.

Warranty Card

Purchase Information

Customer Name: _____

Customer Phone: _____

Customer Address: _____

Purchase Date: _____

Radio Information

Model Number: _____

Serial Number: _____



Note:

- This warranty card applies to after-sale and maintenance services for the product and accessories described above.
- You must provide this warranty card and purchase invoice in order to get warranty services.
- The Company does not assume liability for damages caused by human factors. For more details, contact your local dealer.



Please tear from the Dotted line



FCC Statement

Your EXCERA 2-wayradio is designed and tested to comply with a number of national and international standards and guidelines (listed below) for human exposure to radio frequency electromagnetic energy. This radio complies with the IEEE and ICNIRP exposure limits for occupational/controlled RF exposure environment at operating duty factors of up to 50 % transmitting and is authorized by the FCC for occupational use only. In terms of measuring RF energy for compliance with the FCC exposure guidelines, your radio radiates measurable RF energy only while it is transmitting (during talking), not when it is receiving (listening) or in standby mode. Note: The approved batteries supplied with this radio are rated for a 5-5-90 duty factor (5% talk-5% listen - 90% standby), even though this radio complies with the FCC occupational RF exposure limits and may operate at duty factors of up to 50 % talk.

This equipment complies with FCC RF exposure guidelines. This equipment should be installed and operated with minimum distance 60cm between the radiator & your body. This transmitter must not be co-located or operating in conjunction with any other antenna or transmitter.

This radio transmitter has been approved by FCC to operate with the antenna types listed below with the maximum permissible gain(3.5dBi) and required antenna impedance for each antenna type indicated. Antenna types not included in this list, having a gain greater than the maximum gain indicated(3.5dBi) for that type, are strictly prohibited for use with this device.

ISED statement

This device complies with Innovation, Science, and Economic Development Canada licence-exempt RSS standard(s). Operation is subject to the following two conditions:

- (1) this device may not cause interference, and
- (2) this device must accept any interference, including interference that may cause undesired operation of the device.

Le présent appareil est conforme aux CNR d'Innovation, Sciences et Développement économique Canada (Innovation, Sciences et Développement économique Canada) applicables aux appareils radio exempts de licence. L'exploitation est autorisée aux deux conditions suivantes :

- (1) l'appareil ne doit pas produire de brouillage, et*
- (2) l'utilisateur de l'appareil doit accepter tout brouillage radioélectrique subi, même si le brouillage est susceptible d'en compromettre le fonctionnement.*

This radio transmitter has been approved by Innovation, Science, and Economic Development Canada to operate with the antenna types listed below with the maximum permissible gain(3.5dBi) and required antenna impedance for each antenna type indicated. Antenna types not included in this list, having a gain greater than the maximum gain indicated(3.5dBi) for that type, are strictly prohibited for use with this device.

Le présent émetteur radio a été approuvé par Innovation, Sciences et Développement économique Canada pour fonctionner avec les types d'antenne énumérés ci-dessous et ayant un gain admissible maximal et l'impédance(3.5dBi) requise pour chaque type d'antenne. Les types d'antenne non inclus dans cette liste, ou dont le gain est supérieur au gain maximal indiqué(3.5dBi), sont strictement interdits pour l'exploitation de l'émetteur.