



天线规格书
(Antenna specification)

公司名称 (company name)	明添五金弹簧厂 (Ming tian hardware spring factory)
地址 (address)	广东省汕头市澄海区凤翔街道凤仙一路田心七路西二号 (No. 2 West Tianxin Seventh Road, Fengxian 1st Road, Fengxiang Street, Chenghai District, Shantou City, Guangdong Province)
弹簧天线尺寸 (Spring antenna size): 长 (Length): 225mm	
	
外径 (External diameter): 4mm	
	
线径 (diameter of line): 0.8mm	
	

连接线尺寸如下 (The cable dimensions are as follows):

长度 (length): 41mm, 线径 (diameter of line): 1.2mm (带胶皮 (balata belt)), 0.35mm (铜芯 (copper core))。

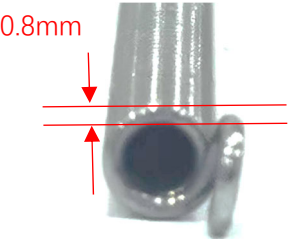
圆环尺寸 (Ring size): 外径 (external diameter): 5mm, 宽度 (breadth): 1mm, 厚度 (breadth): 0.2mm。

