



EUROFINS ELECTRICAL TESTING SERVICE (SHENZHEN) Co., LTD.

RADIO TEST - REPORT

FCC& Compliance Test Report for

Product name: RC Drifter

Model name: KR-2412

FCC ID: 2AE67-KR2412

IC: 24386-KR2412

Test Report Number: EFGX22070239-IE-01-E01

| | | |
|----------|---|-----------|
| 1 | General Information | 3 |
| 1.1 | Notes | 3 |
| 1.2 | Testing laboratory | 4 |
| 1.3 | Details of applicant | 4 |
| 1.4 | Details of manufacturer | 4 |
| 1.5 | Application details | 5 |
| 1.6 | Test item | 5 |
| 1.7 | Test standards | 5 |
| 2 | Technical test | 6 |
| 2.1 | Summary of test results | 6 |
| 2.2 | Test environment | 6 |
| 2.3 | Measurement uncertainty | 6 |
| 2.4 | Test mode | 7 |
| 2.5 | Test equipment utilized | 8 |
| 2.6 | Auxiliary Equipment Used during Test: | 8 |
| 2.7 | Test software information: | 8 |
| 2.8 | Test setup | 9 |
| 2.9 | Test results | 11 |
| 3 | Technical requirement and result | 12 |
| 3.1 | 20 dB bandwidth | 12 |
| 3.2 | 99% Occupied Bandwidth | 16 |
| 3.3 | Radiated emission | 19 |

1 General Information

1.1 Notes

The results of this test report relate exclusively to the item tested as specified in chapter “Description of test item” and are not transferable to any other test items.

Eurofins Electrical Testing Service (Shenzhen) Co., Ltd. is not responsible for any generalisations and conclusions drawn from this report. Any modification of the test item can lead to invalidity of test results and this test report may therefore be not applicable to the modified test item.

The test report may only be reproduced or published in full. Reproducing or publishing extracts of the report requires the prior written approval of the Eurofins Electrical Testing Service (Shenzhen) Co., Ltd. This document is subject to the General Terms and Conditions and the Testing and Certification System of Eurofins Electrical Testing Service (Shenzhen) Co., Ltd., available on request or accessible at www.eurofins.com.

Operator:

2022-09-21

Bruce Zheng / Project Engineer



Date

Eurofins-Lab.

Name / Title

Signature

Technical responsibility for area of testing:

2022-09-21

Albert Xu / Lab Manager

Date

Eurofins

Name / Title

Signature

1.2 Testing laboratory

Eurofins Electrical Testing Service (Shenzhen) Co., Ltd.

1st Floor, Building 2, Chungu, Meisheng Huigu Science and Technology Park, No. 83 Dabao Road, Bao'an District, Shenzhen. P.R.China.

Telephone : +86-755-82911867

Fax : +86-755-82910749

The Laboratory has passed the Accreditation by the American Association for Laboratory Accreditation (A2LA). The Accreditation number is 5376.01

The Laboratory has been listed by industry Canada to perform electromagnetic emission measurements, The CAB identifier is CN0088

1.3 Details of applicant

FCC

Name : Bulk Unlimited Corp
Address : 801 Barton Springs Road, Austin, TX 78704, USA
Telephone : ./.
Fax : ./.

ISED

Name : Bulk Unlimited Corp DBA NessToy
Address : 801 Barton Springs Road, Austin, TX 78704, USA
Telephone : ./.
Fax : ./.

1.4 Details of manufacturer

Name : Bulk Unlimited Corp
Address : 801 Barton Springs Road, Austin, TX 78704, USA
Telephone : ./.
Fax : ./.

1.5 Application details

Date of receipt of application : 2022-07-19
 Date of receipt of test item : 2022-07-19
 Date of test : 2022-07-19 to 2022-08-16
 Date of issue : 2022-09-21

1.6 Test item

Product type : RC Drifter
 Model name : KR-2412
 Brand : ./.
 Serial number : ./.
 Ratings : 3Vdc supplied by 2*1.5Vdc "AA"batteries
 Test voltage : 3Vdc
 FCC ID : 2AE67-KR2412
 IC : 24386-KR2412
 Hardware Version : HD-270-2.4G-01
 Software / Firmware Version : HD-05RX
 PMN : KidiRace
 HVIN : KR-2412
 Additional information : ./.

RadioTechnical data
 Frequency range : 2410MHz – 2473MHz
 Radio Tech. : 2.4G SRD
 Frequency channel : 32
 Modulation : GFSK
 Antenna type : wire antenna
 Antenna gain : 0 dBi

1.7 Test standards

| Test Standards | |
|--|--|
| FCC Part 15 Subpart C December 16, 2020 | PART 15 - RADIO FREQUENCY DEVICES Subpart C - Intentional Radiators |
| RSS-210 Issue 10 December 2019 | RSS-210 — Licence-Exempt Radio Apparatus: Category I Equipment |

Test Method

- 1: ANSI C63.4-2014, American National Standard for Methods of Measurement of Radio-Noise Emissions from Low-Voltage Electrical and Electronic Equipment in the Range of 9 kHz to 40 GHz.
- 2: ANSI C63.10-2013, American National Standard for Testing Unlicensed Wireless Devices.

2 Technical test

2.1 Summary of test results

No deviations from the technical specification(s) were ascertained in the course of the tests performed.

or

The deviations as specified were ascertained in the course of the tests performed.

2.2 Test environment

RF Conducted

| Environment Parameter | Temperature | Relative Humidity |
|-----------------------|-------------|-------------------|
| 101.2Kpa | 24.6 | 62.6% |

Radiated

| Environment Parameter | Temperature | Relative Humidity |
|-----------------------|-------------|-------------------|
| 101.2Kpa | 23.7 | 51.7% |

2.3 Measurement uncertainty

The uncertainty is calculated using the methods suggested in the "Guide to the Expression of Uncertainty in Measurement" (GUM) published by ISO.

| System Measurement Uncertainty | |
|--|---|
| Test Items | Extended Uncertainty |
| Uncertainty in conducted measurements | 1.96dB |
| Uncertainty for Conducted RF test | RF Power Conducted: 1.16dB Frequency test involved: 1.05x10 ⁻⁷ or 1% |
| Uncertainty for Radiated Spurious Emission 25MHz-3000MHz | Horizontal: 4.46dB; Vertical: 4.54dB; |
| Uncertainty for Radiated Spurious Emission 3000MHz-18000MHz | Horizontal: 4.42dB; Vertical: 4.41dB; |
| Uncertainty for Radiated Spurious Emission 18000MHz-40000MHz | Horizontal: 4.63dB; Vertical: 4.62dB; |

2.4 Test mode

The EUT was set at continuously transmitting mode (CH1, CH18, CH32) during the test.

Channel List

| Chan- nel | Frequency (MHz) | Chan- nel | Frequency (MHz) | Channel | Fre- quency (MHz) | Chan- nel | Fre- quency (MHz) |
|--------------|--------------------|--------------|--------------------|-----------|-------------------------|--------------|-------------------------|
| 1 | 2410 | 11 | 2429 | 21 | 2450 | 31 | 2469 |
| 2 | 2414 | 12 | 2430 | 22 | 2452 | 32 | 2473 |
| 3 | 2415 | 13 | 2431 | 23 | 2454 | | |
| 4 | 2416 | 14 | 2433 | 24 | 2456 | | |
| 5 | 2417 | 15 | 2434 | 25 | 2458 | | |
| 6 | 2418 | 16 | 2439 | 26 | 2462 | | |
| 7 | 2419 | 17 | 2441 | 27 | 2464 | | |
| 8 | 2421 | 18 | 2442 | 28 | 2465 | | |
| 9 | 2426 | 19 | 2444 | 29 | 2466 | | |
| 10 | 2428 | 20 | 2446 | 30 | 2467 | | |

2.5 Test equipment utilized

| EQUIPMENT ID | EQUIPMENT NAME | MODEL NO. | CAL. DUE DATE |
|--------------|--------------------------|-------------------|---------------|
| 23-2-13-05 | EMI Test Receiver | ESR3 | 2023-04-24 |
| 23-2-13-06 | LISN | NNLK 8127 RC | 2023-04-23 |
| 23-2-10-16 | Attenuator | VTSD 9561-F | 2023-04-24 |
| 23-2-13-12 | Signal Analyzer | N9010B-544 | 2023-04-24 |
| 23-2-13-13 | BT/WLAN Tester | CMW270 | 2023-04-23 |
| 23-2-13-14 | Signal Generator | N5183B-520 | 2023-04-23 |
| 23-2-13-15 | Vector Signal Generator | N5182B-506 | 2023-04-23 |
| 23-2-10-43 | Switch and Control Unit | ERIT-E-JS0806-2 | 2023-06-17 |
| 23-2-10-44 | DC power supply | E3642A | 2023-06-03 |
| 23-2-10-45 | Temperature test chamber | SG-80-CC-2 | 2023-04-23 |
| 23-2-13-01 | EMI Test Receiver | ESR7 | 2023-04-24 |
| 23-2-13-02 | Signal Analyzer | N9020B-544 | 2023-04-24 |
| 23-2-12-01 | Active Loop Antenna | FMZB 1519B | 2024-05-05 |
| 23-2-12-02 | TRILOG Broadband Antenna | VULB9168 | 2024-05-05 |
| 23-2-12-03 | Horn Antenna | 3117 | 2024-05-05 |
| 23-2-12-04 | Horn Antenna | BBHA 9170 | 2024-05-05 |
| 23-2-10-01 | Preamplifier | BBV9745 | 2023-04-23 |
| 23-2-10-02 | Preamplifier | TAP01018048 | 2023-04-24 |
| 23-2-10-03 | Preamplifier | TAP18040048 | 2023-04-24 |
| 23-2-10-14 | Switch and Control Unit | ERIT-E-JS0806-SF1 | N/A |

2.6 Auxiliary Equipment Used during Test:

| DESCRIPTION | MANUFACTURER | MODEL NO. | S/N |
|-------------|--------------|-----------|-----------|
| Laptop | LENOVO | TP00096A | PF-1QH0LV |

2.7 Test software information:

| | | | |
|-----------------------|------------------|------------|-------------|
| Test Software Version | N/A | | |
| Modulation | Setting TX Power | TX Pattern | Packet Type |
| N/A | N/A | TX Packet | N/A |

2.8 Test setup

Setup diagram for conducted tests

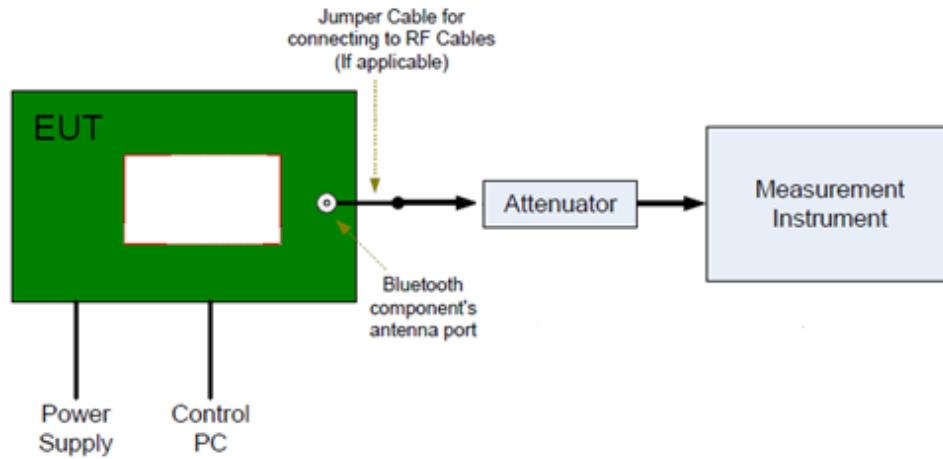

Setup diagram for radiated tests below 30MHz

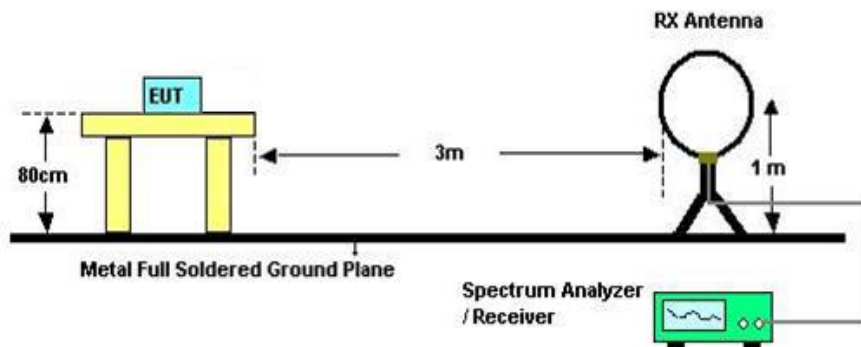

Setup diagram for radiated tests below 1GHz

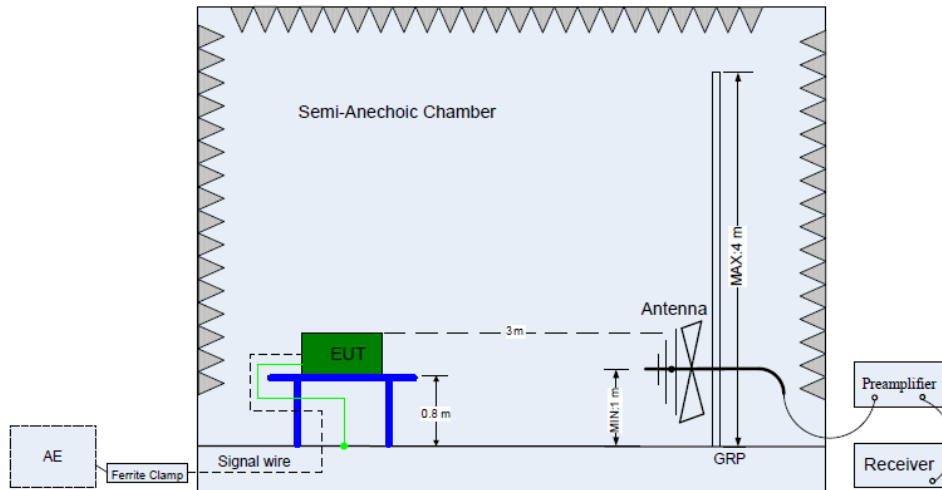

(Below 1 GHz)

Setup diagram for radiated tests above 1GHz

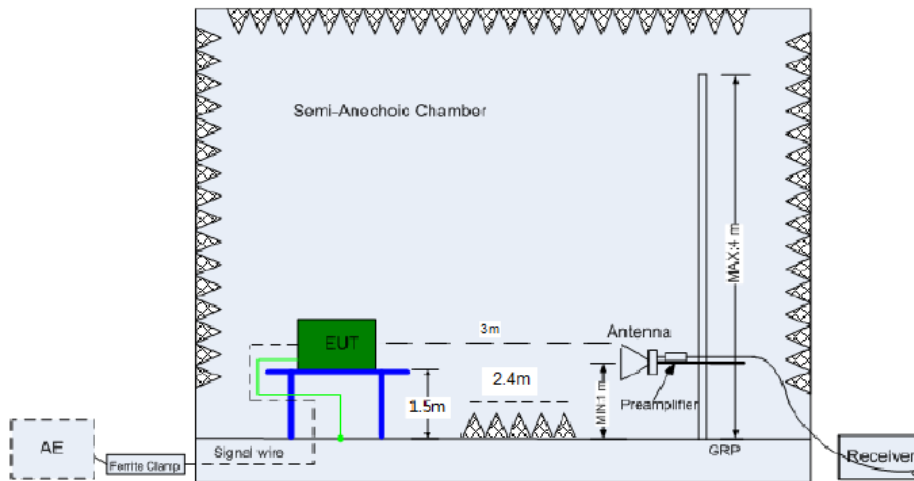

(Above 1 GHz)

2.9 Test results

 1st test

 test after modification

 production test

| Technical Requirements | | | | | |
|--|-----------------|-----------------------------|-------------|---------|-----------|
| FCC Part 15 Subpart C/RSS-210 Issue 10/RSS-Gen Issue 5 | | | | | |
| Test Condition | | | Test Result | Verdict | Test Site |
| §15.215(c)(1) | -- | 20dB bandwidth | See page 13 | Pass | Site 1 |
| -- | RSS-GEN 6.7 | 99% Occupied Band- width | See page 17 | Pass | Site 1 |
| §15.249(a)&(d)&§15.209 &§15.205 | RSS-210 B.10 | Radiated emission | See page 22 | Pass | Site 1 |
| §15.203 | RSS-GEN 6.8 | Antenna requirement | See note 1 | Pass | -- |

Remark 1: N/A – Not Applicable.

Note 1: The EUT uses a internal antenna, the gain: 0 dBi. According to §15.203, it is considered sufficiently to comply with the provisions of this section.

3 Technical requirement and result

3.1 20 dB bandwidth

Test Method:

The test method was referred to the subclause 6.9.2 of ANSI C63.10-2013.

The occupied bandwidth is measured as the width of the spectral envelope of the modulated signal, at an amplitude level reduced from a reference value by a specified ratio (or in decibels, a specified number of dB down from the reference value). Typical ratios, expressed in dB, are -6 dB, -20 dB, and -26 dB, corresponding to 6 dB BW, 20 dB BW, and 26 dB BW, respectively. In this subclause, the ratio is designated by “-xx dB.” The reference value is either the level of the unmodulated carrier or the highest level of the spectral envelope of the modulated signal, as stated by the applicable requirement. Some requirements might specify a specific maximum or minimum value for the “-xx dB” bandwidth; other requirements might specify that the “-xx dB” bandwidth be entirely contained within the authorized or designated frequency band.

- a) The spectrum analyzer center frequency is set to the nominal EUT channel center frequency. The span range for the EMI receiver or spectrum analyzer shall be between two times and five times the OBW.
- b) The nominal IF filter bandwidth (3 dB RBW) shall be in the range of 1% to 5% of the OBW and video bandwidth (VBW) shall be approximately three times RBW, unless otherwise specified by the applicable requirement.
- c) Set the reference level of the instrument as required, keeping the signal from exceeding the maximum input mixer level for linear operation. In general, the peak of the spectral envelope shall be more than $[10 \log (OBW/RBW)]$ below the reference level. Specific guidance is given in 4.1.5.2.
- d) Steps a) through c) might require iteration to adjust within the specified tolerances.
- e) The dynamic range of the instrument at the selected RBW shall be more than 10 dB below the target “-xx dB down” requirement; that is, if the requirement calls for measuring the -20 dB OBW, the instrument noise floor at the selected RBW shall be at least 30 dB below the reference value.
- f) Set detection mode to peak and trace mode to max hold.
- g) Determine the reference value: Set the EUT to transmit an unmodulated carrier or modulated signal, as applicable. Allow the trace to stabilize. Set the spectrum analyzer marker to the highest level of the displayed trace (this is the reference value).
- h) Determine the “-xx dB down amplitude” using $[(\text{reference value}) - xx]$. Alternatively, this calculation may be made by using the marker-delta function of the instrument.
- i) If the reference value is determined by an unmodulated carrier, then turn the EUT modulation ON, and either clear the existing trace or start a new trace on the spectrum analyzer and allow the new trace to stabilize. Otherwise, the trace from step g) shall be used for step j).
- j) Place two markers, one at the lowest frequency and the other at the highest frequency of the envelope of the spectral display, such that each marker is at or slightly below the “ixx dB down amplitude” determined in step h). If a marker is below this “-xx dB down amplitude” value, then it shall be as close as possible to this value. The occupied bandwidth is the frequency difference between the two markers. Alternatively, set a marker at the lowest frequency of the envelope of the spectral display, such that the marker is at or slightly below the “ixx dB down amplitude” determined in step h). Reset the marker-delta function and move the marker to the other side of the emission until the delta marker amplitude is at the same level as the reference marker amplitude. The marker-delta frequency reading at this point is the specified emission bandwidth.
- k) The occupied bandwidth shall be reported by providing plot(s) of the measuring instrument display; the plot axes and the scale units per division shall be clearly labeled. Tabular data may be reported in addition to the plot(s).

Limit:

None; for reporting purposes only.

Test Result:

| Channel | 20db EBW[MHz] | FL[MHz] | FH[MHz] | Verdict |
|---------|---------------|----------|-----------|---------|
| 2410 | 2.585 | 2408.855 | 2,411.440 | PASS |
| 2442 | 2.605 | 2440.850 | 2,443.455 | PASS |
| 2473 | 2.555 | 2471.895 | 2,474.450 | PASS |

3.1.1 Test Graphs





3.2 99% Occupied Bandwidth

Test Method:

The test method was referred to the subclause 6.9.3 of ANSI C63.10-2013.

The occupied bandwidth is the frequency bandwidth such that, below its lower and above its upper frequency limits, the mean powers are each equal to 0.5% of the total mean power of the given emission. The following procedure shall be used for measuring 99% power bandwidth:

- a) The instrument center frequency is set to the nominal EUT channel center frequency. The frequency span for the spectrum analyzer shall be between 1.5 times and 5.0 times the OBW.
- b) The nominal IF filter bandwidth (3 dB RBW) shall be in the range of 1% to 5% of the OBW, and VBW shall be approximately three times the RBW, unless otherwise specified by the applicable requirement.
- c) Set the reference level of the instrument as required, keeping the signal from exceeding the maximum input mixer level for linear operation. In general, the peak of the spectral envelope shall be more than $[10 \log (OBW/RBW)]$ below the reference level. Specific guidance is given in 4.1.5.2.
- d) Step a) through step c) might require iteration to adjust within the specified range.
- e) Video averaging is not permitted. Where practical, a sample detection and single sweep mode shall be used. Otherwise, peak detection and max hold mode (until the trace stabilizes) shall be used.
- f) Use the 99% power bandwidth function of the instrument (if available) and report the measured bandwidth.
- g) If the instrument does not have a 99% power bandwidth function, then the trace data points are recovered and directly summed in linear power terms. The recovered amplitude data points, beginning at the lowest frequency, are placed in a running sum until 0.5% of the total is reached; that frequency is recorded as the lower frequency. The process is repeated until 99.5% of the total is reached; that frequency is recorded as the upper frequency. The 99% power bandwidth is the difference between these two frequencies.
- h) The occupied bandwidth shall be reported by providing plot(s) of the measuring instrument display; the plot axes and the scale units per division shall be clearly labeled. Tabular data may be reported in addition to the plot(s).

Limit:

None; for reporting purposes only.

Test Result:

| Channel | 99% EBW[MHz] | Verdict |
|---------|--------------|---------|
| 2410 | 2.6947 | PASS |
| 2442 | 2.5381 | PASS |
| 2473 | 2.3532 | PASS |

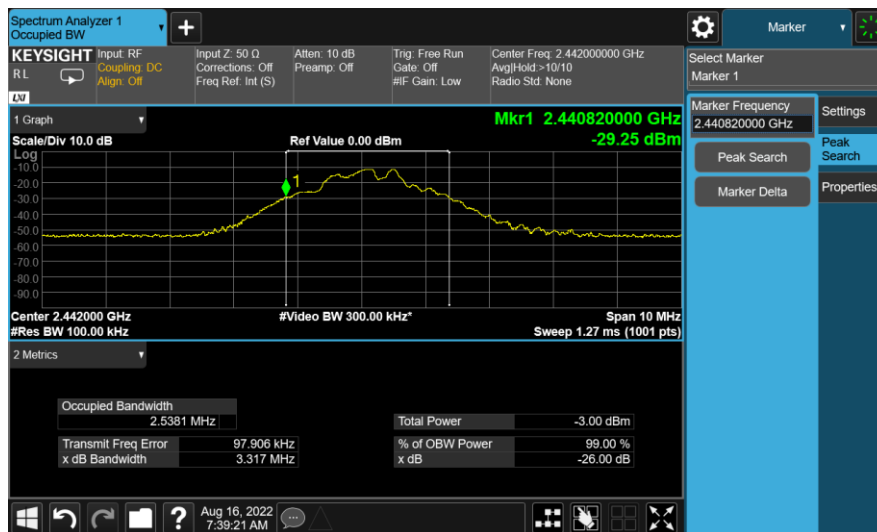
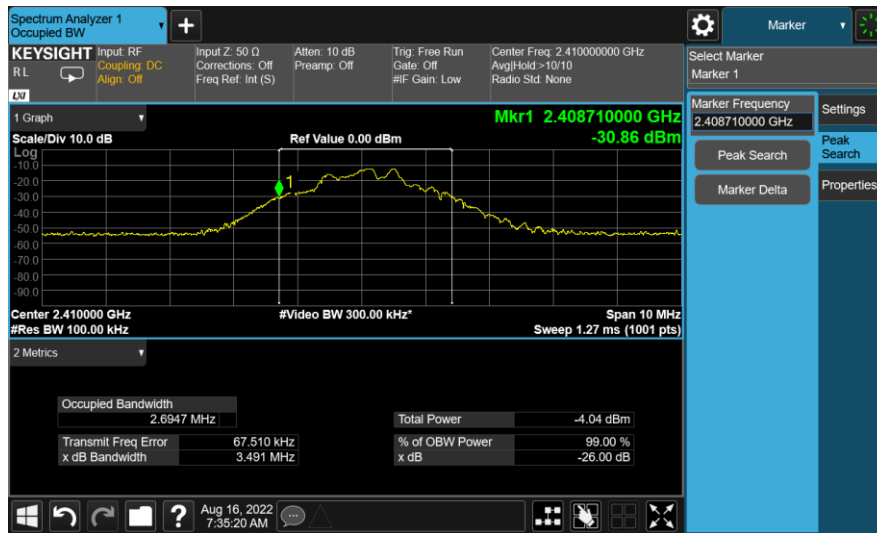

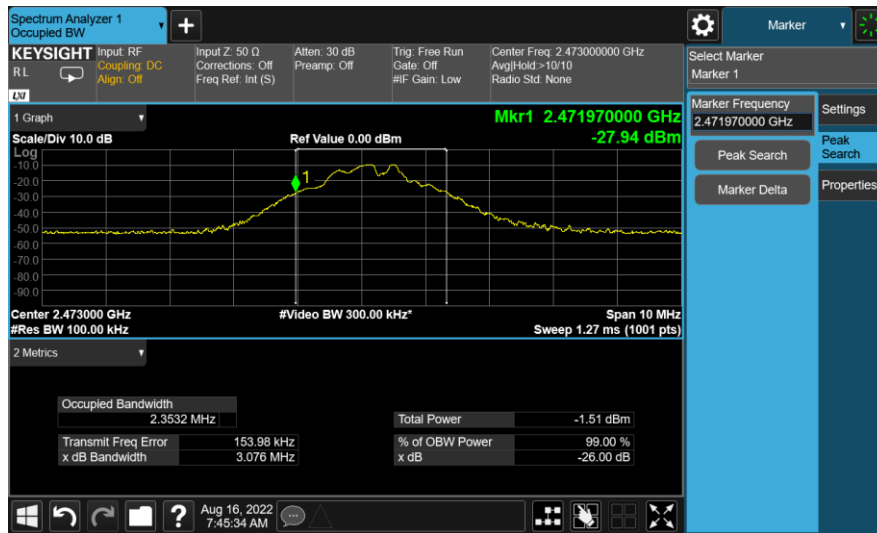

3.3 Radiated emission

Test Method:

The test method was referred to the subclause 11.11/11.12 of ANSI C63.10-2013.

- 1: The EUT was placed on a turn table which is 1.5m above ground plane for above 1GHz and 0.8m above ground for below 1GHz at 3 meter chamber room for test. The table was rotated 360 degrees to determine the position of the highest radiation.
- 2: The EUT was set 3 meters away from the interference – receiving antenna, which was mounted on the top of a variable – height antenna tower.
- 3: The height of antenna is varied from one meter to four meters above the ground to determine the maximum value of the field strength. Both horizontal and vertical polarizations of the antenna are set to make the measurement.
- 4: For each suspected emission, the EUT was arranged to its worst case and then the antenna was tuned to heights from 1 meter to 4 meters and the rotatable table was turned from 0 degrees to 360 degrees to find the maximum reading.
- 5: Use the following spectrum analyzer settings According to C63.10:
For Above 1GHz
Span = wide enough to capture the peak level of the in-band emission and all spurious
RBW = 1MHz, VBW \geq RBW for peak measurement and VBW = 10Hz for average measurement, Sweep = auto, Detector function = peak, Trace = max hold.
For Below 1GHz
Use the following spectrum analyzer settings:
Span = wide enough to capture the peak level of the in-band emission and all spurious
RBW = 100 KHz, VBW \geq RBW for peak measurement, Sweep = auto, Detector function = peak, Trace = max hold.
For Below 30MHz
Use the following spectrum analyzer settings:
Span = wide enough to capture the peak level of the in-band emission and all spurious
RBW = 200 Hz, VBW \geq RBW from 9KHz to 0.15MHz, RBW 9KHz VBW \geq RBW from 0.15MHz to 30MHz for peak measurement, Sweep = auto, Detector function = peak, Trace = max hold.

Note:

- 1: The resolution bandwidth and video bandwidth of test receiver/spectrum analyzer is 120 KHz for Quasi-peak detection (QP) at frequency below 1GHz.
- 2: The resolution bandwidth of test receiver/spectrum analyzer is 1MHz and the video bandwidth is 3MHz for peak detection (PK) at frequency above 1GHz.
- 3: The resolution bandwidth of test receiver/spectrum analyzer is 1MHz and the video bandwidth is 3MHz for RMS Average ((duty cycle < 98%) for Average detection (AV) at frequency above 1GHz, then the measurement results was added to a correction factor (20log(1/duty cycle)).
- 4: The resolution bandwidth of test receiver/spectrum analyzer is 1MHz and the video bandwidth is 10Hz (duty cycle > 98%) for Average detection (AV) at frequency above 1GHz.
- 5: When duty cycle <98%, The resolution bandwidth of test receiver/spectrum analyzer is 1MHz and the video bandwidth is VBW \geq 1 / T, the T is transmission duration (T).

Limit:

FCC §15.209

RSS-GEN, Section 8.9

| Frequency Range (MHz) | Field Strength Limit ($\mu\text{V/m}$) at 3 m | Field Strength Limit (dB $\mu\text{V/m}$) at 3 m |
|--------------------------|--|--|
| 0.009-0.490 | 2400/F(kHz) @ 300 m | - |
| 0.490-1.705 | 24000/F(kHz) @ 30 m | - |
| 1.705 - 30 | 30 @ 30m | - |
| 30 - 88 | 100 | 40 |
| 88 - 216 | 150 | 43.5 |
| 216 - 960 | 200 | 46 |
| Above 960 | 500 | 54 |

§15.205 Restricted bands of operation

| MHz | MHz | MHz | GHz |
|-------------------|---------------------|---------------|-------------|
| 0.090-0.110 | 16.42-16.423 | 399.9-410 | 4.5-5.15 |
| 0.495-0.505 | 16.69475-16.69525 | 608-614 | 5.35-5.46 |
| 2.1735-2.1905 | 16.80425-16.80475 | 960-1240 | 7.25-7.75 |
| 4.125-4.128 | 25.5-25.67 | 1300-1427 | 8.025-8.5 |
| 4.17725-4.17775 | 37.5-38.25 | 1435-1626.5 | 9.0-9.2 |
| 4.20725-4.20775 | 73-74.6 | 1645.5-1646.5 | 9.3-9.5 |
| 6.215-6.218 | 74.8-75.2 | 1660-1710 | 10.6-12.7 |
| 6.26775-6.26825 | 108-121.94 | 1718.8-1722.2 | 13.25-13.4 |
| 6.31175-6.31225 | 123-138 | 2200-2300 | 14.47-14.5 |
| 8.291-8.294 | 149.9-150.05 | 2310-2390 | 15.35-16.2 |
| 8.362-8.366 | 156.52475-156.52525 | 2483.5-2500 | 17.7-21.4 |
| 8.37625-8.38675 | 156.7-156.9 | 2690-2900 | 22.01-23.12 |
| 8.41425-8.41475 | 162.0125-167.17 | 3260-3267 | 23.6-24.0 |
| 12.29-12.293 | 167.72-173.2 | 3332-3339 | 31.2-31.8 |
| 12.51975-12.52025 | 240-285 | 3345.8-3358 | 36.43-36.5 |
| 12.57675-12.57725 | 322-335.4 | 3600-4400 | |
| 13.36-13.41 | | | |

RSS-GEN 8.10

| MHz | MHz | MHz | GHz |
|---------------------|-----------------------|-----------------|---------------|
| 0.090 - 0.110 | 16.42 - 16.423 | 1660 - 1710 | 9.0 - 9.2 |
| 0.495 - 0.505 | 16.69475 - 16.69525 | 1718.8 - 1722.2 | 9.3 - 9.5 |
| 2.1735 - 2.1905 | 25.5 - 25.67 | 2200 - 2300 | 10.6 - 12.7 |
| 3.020 - 3.026 | 37.5 - 38.25 | 2310 - 2390 | 13.25 - 13.4 |
| 4.125 - 4.128 | 73 - 74.6 | 2483.5 - 2500 | 14.47 - 14.5 |
| 4.17725 - 4.17775 | 74.8 - 75.2 | 2655 - 2900 | 15.35 - 16.2 |
| 4.20725 - 4.20775 | 108 - 138 | 3260 - 3267 | 17.7 - 21.4 |
| 5.677 - 5.683 | 149.9 - 150.05 | 3332 - 3339 | 22.01 - 23.12 |
| 6.215 - 6.218 | 156.52475 - 156.52525 | 3345.8 - 3358 | 23.6 - 24.0 |
| 6.26775 - 6.26825 | 156.7 - 156.9 | 3500 - 4400 | 31.2 - 31.8 |
| 6.31175 - 6.31225 | 162.0125 - 167.17 | 4500 - 5150 | 36.43 - 36.5 |
| 8.291 - 8.294 | 167.72 - 173.2 | 5350 - 5460 | Above 38.6 |
| 8.362 - 8.366 | 240 - 285 | 7250 - 7750 | |
| 8.37625 - 8.38675 | 322 - 335.4 | 8025 - 8500 | |
| 8.41425 - 8.41475 | 399.9 - 410 | | |
| 12.29 - 12.293 | 608 - 614 | | |
| 12.51975 - 12.52025 | 960 - 1427 | | |
| 12.57675 - 12.57725 | 1435 - 1626.5 | | |
| 13.36 - 13.41 | 1645.5 - 1646.5 | | |

FCC §15.249(a)

RSS-210 B.10

| Fundamental frequency | Field strength of fundamental (mV/m) | Field strength of fundamental (dB μ V/m) | Field strength of harmonics (μ V/m) | Field strength of harmonics (dB μ V/m) |
|-----------------------|--------------------------------------|--|--|--|
| 902-928 MHz | 50 | 94 | 500 | 54 |
| 2400-2483.5 MHz | 50 | 94 | 500 | 54 |
| 5725-5875 MHz | 50 | 94 | 500 | 54 |
| 24.0-24.25 GHz | 250 | 128 | 2500 | 68 |

Test Result:
2410MHz Test Result

30-1000MHz

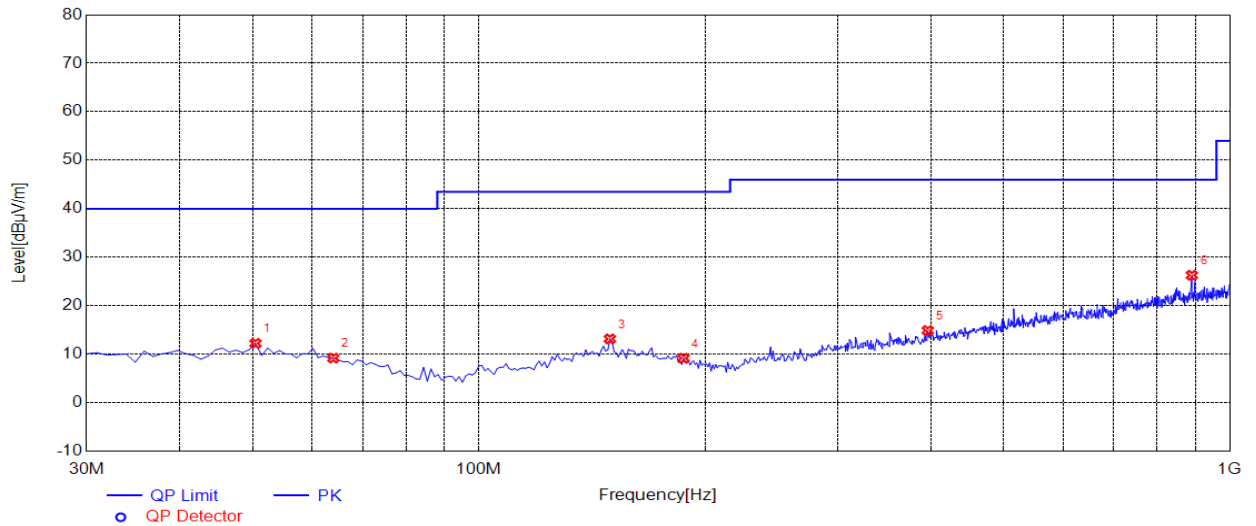

| NO. | Freq. [MHz] | Level [dBµV/m] | Factor [dB/m] | Limit [dBµV/m] | Margin [dB] | Height [cm] | Angle [°] | Polarity |
|-----|-------------|----------------|---------------|----------------|-------------|-------------|-----------|------------|
| 1 | 50.3904 | 12.24 | -15.50 | 40.00 | 27.76 | 100 | 180 | Horizontal |
| 2 | 63.9840 | 9.20 | -17.03 | 40.00 | 30.80 | 100 | 80 | Horizontal |
| 3 | 149.429 | 13.16 | -15.89 | 43.50 | 30.34 | 100 | 220 | Horizontal |
| 4 | 187.297 | 9.16 | -17.94 | 43.50 | 34.34 | 100 | 160 | Horizontal |
| 5 | 396.056 | 14.89 | -13.64 | 46.00 | 31.11 | 100 | 340 | Horizontal |
| 6 | 890.280 | 26.29 | -5.76 | 46.00 | 19.71 | 100 | 130 | Horizontal |

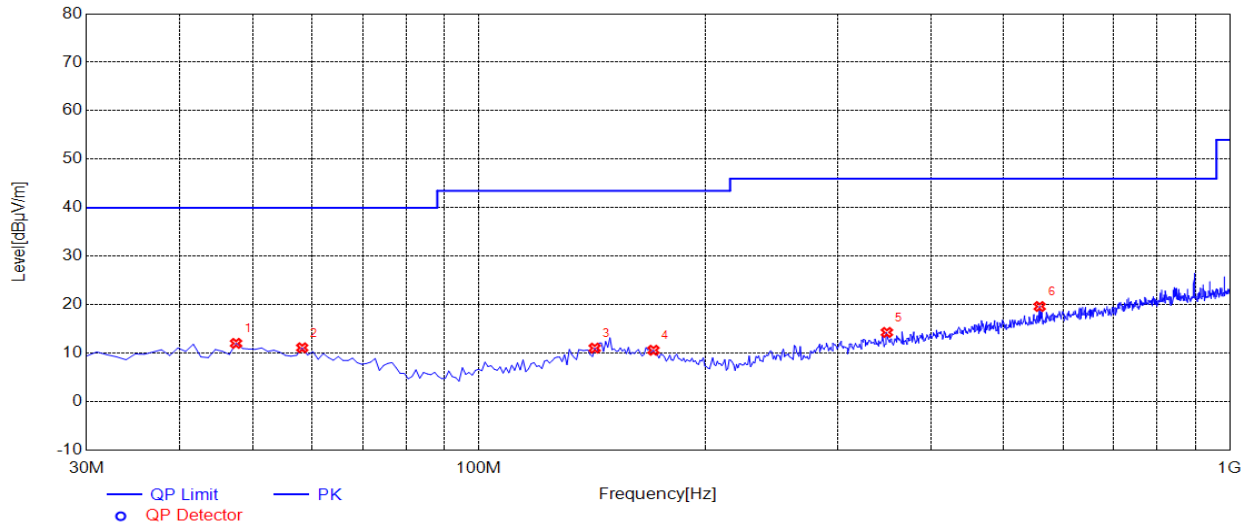

| NO. | Freq. [MHz] | Level [dBµV/m] | Factor [dB/m] | Limit [dBµV/m] | Margin [dB] | Height [cm] | Angle [°] | Polarity |
|-----|-------------|----------------|---------------|----------------|-------------|-------------|-----------|----------|
| 1 | 47.4775 | 12.03 | -15.56 | 40.00 | 27.97 | 100 | 100 | Vertical |
| 2 | 58.1582 | 11.12 | -16.10 | 40.00 | 28.88 | 100 | 100 | Vertical |
| 3 | 142.632 | 11.05 | -16.07 | 43.50 | 32.45 | 100 | 10 | Vertical |
| 4 | 170.790 | 10.61 | -16.54 | 43.50 | 32.89 | 100 | 270 | Vertical |
| 5 | 349.449 | 14.29 | -14.62 | 46.00 | 31.71 | 100 | 110 | Vertical |
| 6 | 558.208 | 19.63 | -10.25 | 46.00 | 26.37 | 100 | 10 | Vertical |

| Freq. [MHz] | PK Reading [dB μ V/m] | Factor [dB/m] | PK Value [dB μ V/m] | PK Limit [dB μ V/m] | PK Margin [dB] | Polarity | Verdict |
|-------------|---------------------------|---------------|-------------------------|-------------------------|----------------|------------|---------|
| 1340.0000 | 63.98 | -25.14 | 38.84 | 74.00 | 35.16 | Horizontal | PASS |
| 3879.4137 | 62.69 | -18.07 | 44.62 | 74.00 | 29.38 | Horizontal | PASS |
| 4818.7875 | 66.24 | -16.42 | 49.82 | 74.00 | 24.18 | Horizontal | PASS |
| 7232.1785 | 63.5 | -12.72 | 50.78 | 74.00 | 23.22 | Horizontal | PASS |
| 9090.9394 | 60.94 | -10.86 | 50.08 | 74.00 | 23.92 | Horizontal | PASS |

| Freq. [MHz] | PK Reading [dB μ V/m] | Factor [dB/m] | PK Value [dB μ V/m] | PK Limit [dB μ V/m] | PK Margin [dB] | Polarity | Verdict |
|-------------|---------------------------|---------------|-------------------------|-------------------------|----------------|----------|---------|
| 4820.4741 | 77.36 | -16.42 | 60.94 | 74.00 | 13.06 | Vertical | PASS |
| 1472.0000 | 63.5 | -24.92 | 38.58 | 74.00 | 35.42 | Vertical | PASS |
| 3759.4937 | 62.74 | -18.55 | 44.19 | 74.00 | 29.81 | Vertical | PASS |
| 7202.1985 | 61.14 | -12.76 | 48.38 | 74.00 | 25.62 | Vertical | PASS |
| 9640.5730 | 62.41 | -9.79 | 52.62 | 74.00 | 21.38 | Vertical | PASS |

| AV Final Data List | | | | | | | | |
|--------------------|-------------|---------------------------|---------------|-------------------------|-------------------------|----------------|----------|---------|
| NO. | Freq. [MHz] | AV Reading [dB μ V/m] | Factor [dB/m] | AV Value [dB μ V/m] | AV Limit [dB μ V/m] | AV Margin [dB] | Polarity | Verdict |
| 1 | 4820.4741 | 65.1 | -16.42 | 48.68 | 54.00 | 5.32 | Vertical | PASS |

According to C63.10, if the peak (or quasi-peak) measured value complies with the average limit, it is unnecessary to perform an average measurement, so AV emission value did not show in below table if the peak value complies with average limit.

2442MHz Test Result

30-1000MHz

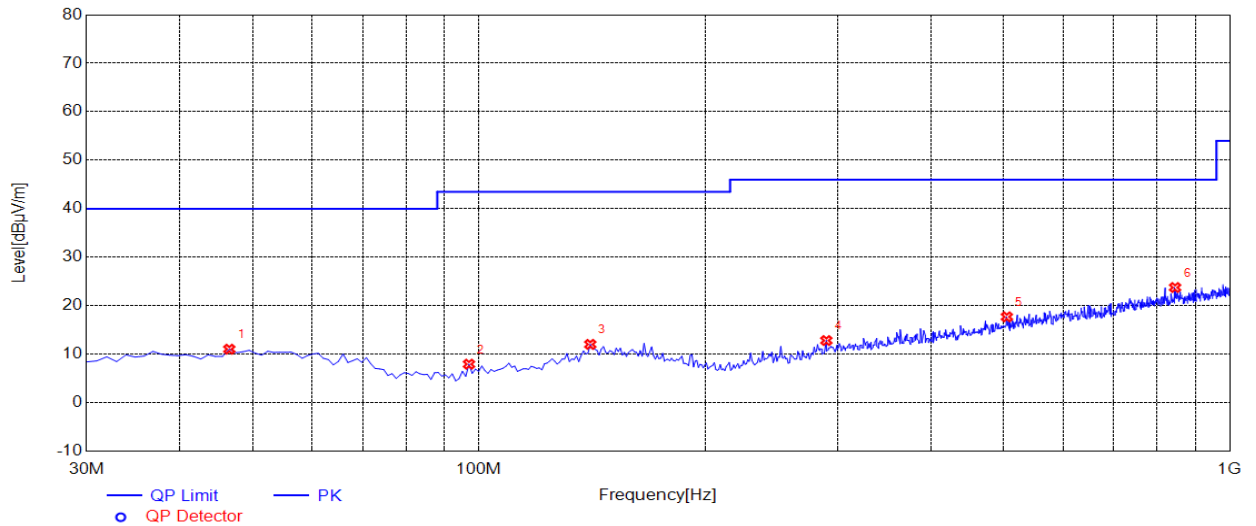

| Freq. [MHz] | Level [dBµV/m] | Factor [dB/m] | Limit [dBµV/m] | Margin [dB] | Height [cm] | Angle [°] | Polarity |
|-------------|----------------|---------------|----------------|-------------|-------------|-----------|------------|
| 46.5065 | 11.04 | -15.59 | 40.00 | 28.96 | 100 | 90 | Horizontal |
| 96.9970 | 7.95 | -20.52 | 43.50 | 35.55 | 100 | 30 | Horizontal |
| 140.690 | 12.03 | -16.13 | 43.50 | 31.47 | 100 | 330 | Horizontal |
| 290.220 | 12.82 | -15.86 | 46.00 | 33.18 | 100 | 240 | Horizontal |
| 504.804 | 17.71 | -11.35 | 46.00 | 28.29 | 100 | 310 | Horizontal |
| 845.615 | 23.76 | -6.10 | 46.00 | 22.24 | 100 | 220 | Horizontal |

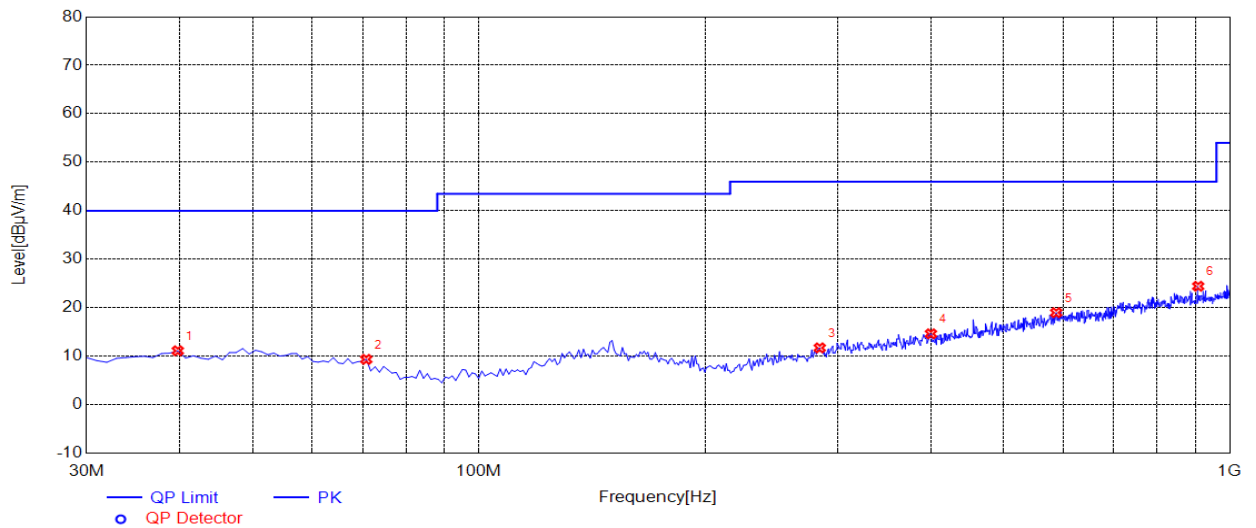

| Freq. [MHz] | Level [dBµV/m] | Factor [dB/m] | Limit [dBµV/m] | Margin [dB] | Height [cm] | Angle [°] | Polarity |
|-------------|----------------|---------------|----------------|-------------|-------------|-----------|----------|
| 39.7097 | 11.12 | -15.87 | 40.00 | 28.88 | 100 | 160 | Vertical |
| 70.7808 | 9.35 | -18.41 | 40.00 | 30.65 | 100 | 190 | Vertical |
| 284.394 | 11.72 | -15.98 | 46.00 | 34.28 | 100 | 130 | Vertical |
| 399.939 | 14.62 | -13.56 | 46.00 | 31.38 | 100 | 170 | Vertical |
| 587.337 | 18.98 | -9.64 | 46.00 | 27.02 | 100 | 150 | Vertical |
| 907.757 | 24.43 | -5.59 | 46.00 | 21.57 | 100 | 40 | Vertical |

| Freq. [MHz] | PK Reading [dB μ V/m] | Factor [dB/m] | PK Value [dB μ V/m] | PK Limit [dB μ V/m] | PK Margin [dB] | Polarity | Verdict |
|-------------|---------------------------|---------------|-------------------------|-------------------------|----------------|------------|---------|
| 1470.0000 | 63.95 | -24.92 | 39.03 | 74.00 | 34.97 | Horizontal | PASS |
| 3819.4537 | 62.72 | -18.18 | 44.54 | 74.00 | 29.46 | Horizontal | PASS |
| 4883.7442 | 64.69 | -16.32 | 48.37 | 74.00 | 25.63 | Horizontal | PASS |
| 7327.1153 | 64.56 | -12.85 | 51.71 | 74.00 | 22.29 | Horizontal | PASS |
| 10130.2465 | 60 | -8.76 | 51.24 | 74.00 | 22.76 | Horizontal | PASS |

| Freq. [MHz] | PK Reading [dB μ V/m] | Factor [dB/m] | PK Value [dB μ V/m] | PK Limit [dB μ V/m] | PK Margin [dB] | Polarity | Verdict |
|-------------|---------------------------|---------------|-------------------------|-------------------------|----------------|----------|---------|
| 4884.5256 | 75.23 | -16.31 | 58.92 | 74.00 | 15.08 | Vertical | PASS |
| 3819.4537 | 62.72 | -18.18 | 44.54 | 74.00 | 29.46 | Vertical | PASS |
| 2104.0000 | 62.68 | -20.29 | 42.39 | 74.00 | 31.61 | Vertical | PASS |
| 6842.4384 | 60.78 | -12.44 | 48.34 | 74.00 | 25.66 | Vertical | PASS |
| 9770.4863 | 62.03 | -9.38 | 52.65 | 74.00 | 21.35 | Vertical | PASS |

| AV Final Data List | | | | | | | | |
|--------------------|-------------|---------------------------|---------------|-------------------------|-------------------------|----------------|----------|---------|
| NO. | Freq. [MHz] | AV Reading [dB μ V/m] | Factor [dB/m] | AV Value [dB μ V/m] | AV Limit [dB μ V/m] | AV Margin [dB] | Polarity | Verdict |
| 1 | 4884.5256 | 69.29 | -16.31 | 52.98 | 54.00 | 1.02 | Vertical | PASS |

According to C63.10, if the peak (or quasi-peak) measured value complies with the average limit, it is unnecessary to perform an average measurement, so AV emission value did not show in below table if the peak value complies with average limit.

2473MHz Test Result

30-1000MHz

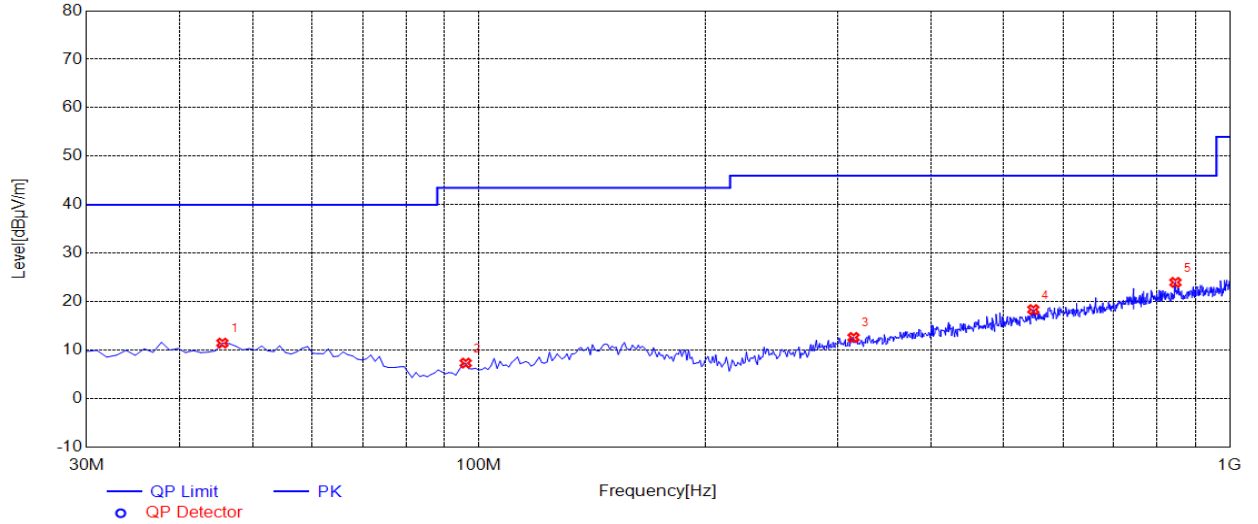

| Freq. [MHz] | Level [dBµV/m] | Factor [dB/m] | Limit [dBµV/m] | Margin [dB] | Height [cm] | Angle [°] | Polarity |
|-------------|----------------|---------------|----------------|-------------|-------------|-----------|------------|
| 45.5355 | 11.47 | -15.63 | 40.00 | 28.53 | 100 | 210 | Horizontal |
| 96.0260 | 7.35 | -20.64 | 43.50 | 36.15 | 100 | 10 | Horizontal |
| 315.465 | 12.63 | -15.34 | 46.00 | 33.37 | 100 | 170 | Horizontal |
| 547.527 | 18.38 | -10.47 | 46.00 | 27.62 | 100 | 50 | Horizontal |
| 846.586 | 23.99 | -6.10 | 46.00 | 22.01 | 100 | 50 | Horizontal |

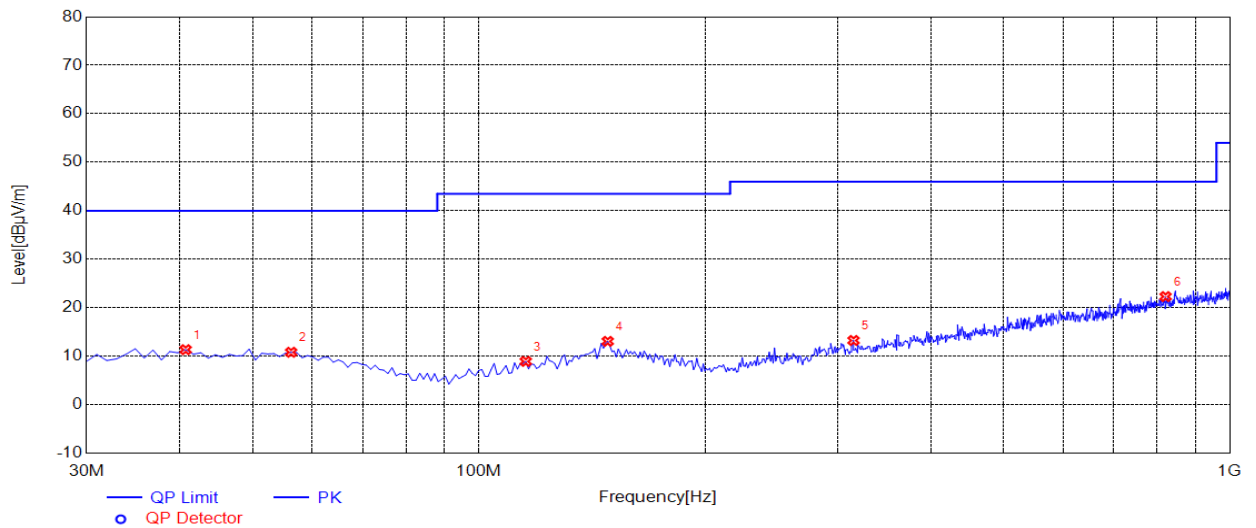

| Freq. [MHz] | Level [dBµV/m] | Factor [dB/m] | Limit [dBµV/m] | Margin [dB] | Height [cm] | Angle [°] | Polarity |
|-------------|----------------|---------------|----------------|-------------|-------------|-----------|----------|
| 40.6807 | 11.35 | -15.80 | 40.00 | 28.65 | 100 | 350 | Vertical |
| 56.2162 | 10.82 | -15.95 | 40.00 | 29.18 | 100 | 270 | Vertical |
| 115.445 | 8.93 | -19.03 | 43.50 | 34.57 | 100 | 360 | Vertical |
| 148.458 | 13.07 | -15.91 | 43.50 | 30.43 | 100 | 350 | Vertical |
| 315.465 | 13.25 | -15.34 | 46.00 | 32.75 | 100 | 260 | Vertical |
| 821.341 | 22.30 | -6.29 | 46.00 | 23.70 | 100 | 30 | Vertical |

| Freq. [MHz] | PK Reading [dB μ V/m] | Factor [dB/m] | PK Value [dB μ V/m] | PK Limit [dB μ V/m] | PK Margin [dB] | Polarity | Verdict |
|-------------|---------------------------|---------------|-------------------------|-------------------------|----------------|------------|---------|
| 4946.3738 | 71.62 | -16.46 | 55.16 | 74.00 | 18.84 | Horizontal | PASS |
| 7420.8645 | 72.26 | -12.66 | 59.60 | 74.00 | 14.40 | Horizontal | PASS |
| 1350.0000 | 64.1 | -25.07 | 39.03 | 74.00 | 34.97 | Horizontal | PASS |
| 3829.4470 | 63.73 | -18.21 | 45.52 | 74.00 | 28.48 | Horizontal | PASS |
| 10115.2565 | 61.12 | -8.93 | 52.19 | 74.00 | 21.81 | Horizontal | PASS |

| Freq. [MHz] | PK Reading [dB μ V/m] | Factor [dB/m] | PK Value [dB μ V/m] | PK Limit [dB μ V/m] | PK Margin [dB] | Polarity | Verdict |
|-------------|---------------------------|---------------|-------------------------|-------------------------|----------------|----------|---------|
| 4946.5730 | 75.66 | -16.46 | 59.20 | 74.00 | 14.80 | Vertical | PASS |
| 7419.4658 | 71.87 | -12.66 | 59.21 | 74.00 | 14.79 | Vertical | PASS |
| 1398.0000 | 63.88 | -25.13 | 38.75 | 74.00 | 35.25 | Vertical | PASS |
| 3914.3904 | 62.33 | -17.90 | 44.43 | 74.00 | 29.57 | Vertical | PASS |
| 9215.8561 | 61.04 | -10.52 | 50.52 | 74.00 | 23.48 | Vertical | PASS |

| AV Final Data List | | | | | | | | |
|--------------------|-------------|---------------------------|---------------|-------------------------|-------------------------|----------------|----------|---------|
| NO. | Freq. [MHz] | AV Reading [dB μ V/m] | Factor [dB/m] | AV Value [dB μ V/m] | AV Limit [dB μ V/m] | AV Margin [dB] | Polarity | Verdict |
| 1 | 4946.5730 | 69.45 | -16.46 | 52.99 | 54.00 | 1.01 | Vertical | PASS |
| 2 | 7419.4658 | 57.70 | -12.66 | 45.04 | 54.00 | 8.96 | Vertical | PASS |

According to C63.10, if the peak (or quasi-peak) measured value complies with the average limit, it is unnecessary to perform an average measurement, so AV emission value did not show in below table if the peak value complies with average limit.

Band-edge (Radiated)

2410MHz Test Result

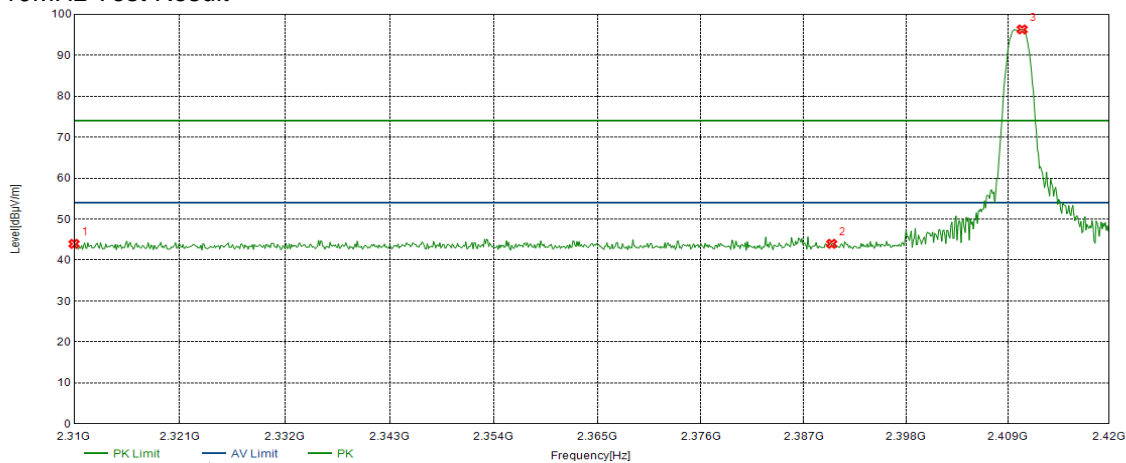

| Freq. [MHz] | PK Reading [dBµV/m] | Level [dBµV/m] | Factor [dB/m] | Limit [dBµV/m] | Margin [dB] | Polarity |
|-------------|---------------------|----------------|---------------|----------------|-------------|----------|
| 2310.00 | 65.08 | 43.96 | -21.12 | 74.00 | 30.04 | Horizon- |
| 2390.00 | 64.94 | 43.97 | -20.97 | 74.00 | 30.03 | Horizon- |

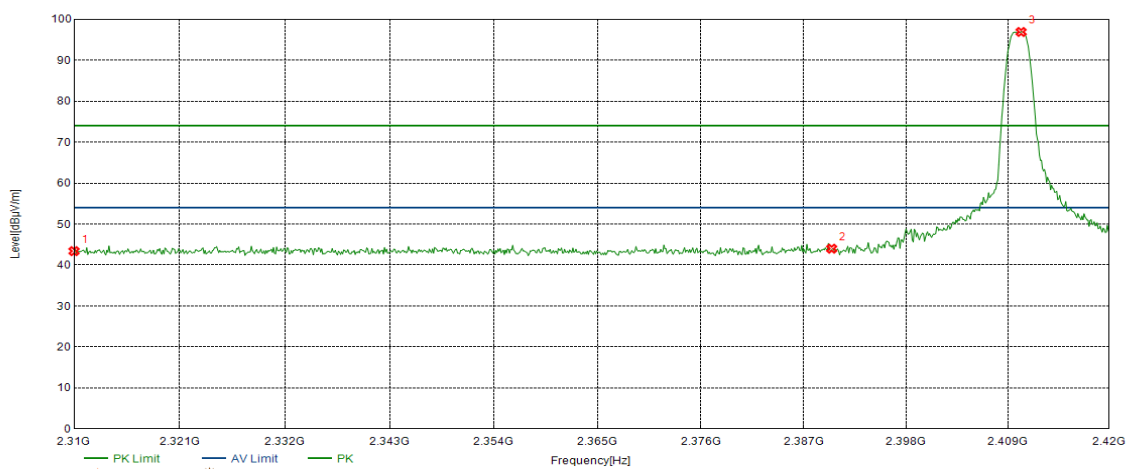

| Freq. [MHz] | PK Reading [dBµV/m] | Level [dBµV/m] | Factor [dB/m] | Limit [dBµV/m] | Margin [dB] | Polarity |
|-------------|---------------------|----------------|---------------|----------------|-------------|----------|
| 2310.00 | 64.52 | 43.40 | -21.12 | 74.00 | 30.60 | Vertical |
| 2390.00 | 64.97 | 44.00 | -20.97 | 74.00 | 30.00 | Vertical |

Level = Read level + Factor

Factor = Antenna Factor + Cable loss – Preamp Factor

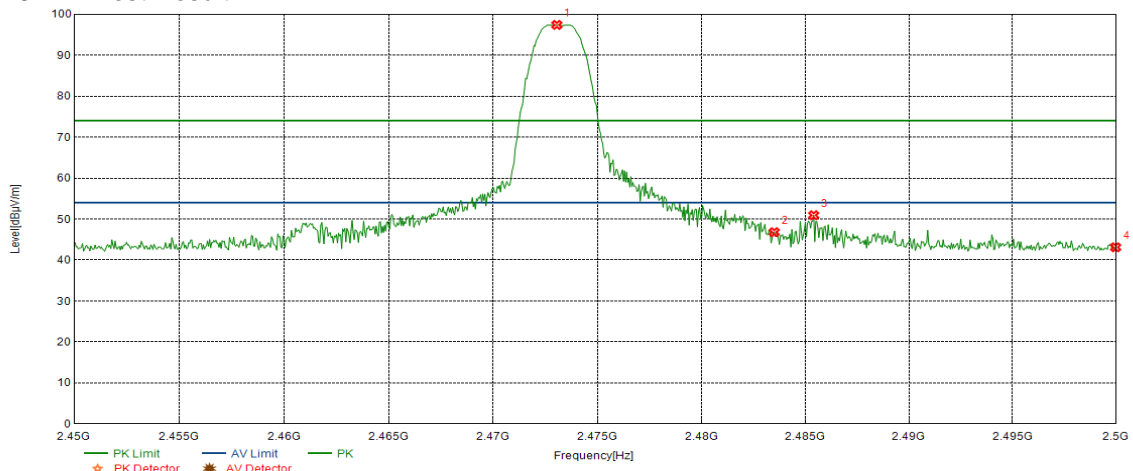
2473MHz Test Result

| Freq. [MHz] | PK Reading [dBµV/m] | Level [dBµV/m] | Factor [dB/m] | Limit [dBµV/m] | Margin [dB] | Polarity |
|-------------|---------------------|----------------|---------------|----------------|-------------|----------|
| 2483.50 | 67.60 | 46.80 | -20.80 | 74.00 | 27.20 | Horizon- |
| 2485.40 | 71.73 | 50.93 | -20.80 | 74.00 | 23.07 | Horizon- |
| 2500.00 | 63.88 | 43.11 | -20.77 | 74.00 | 30.89 | Horizon- |

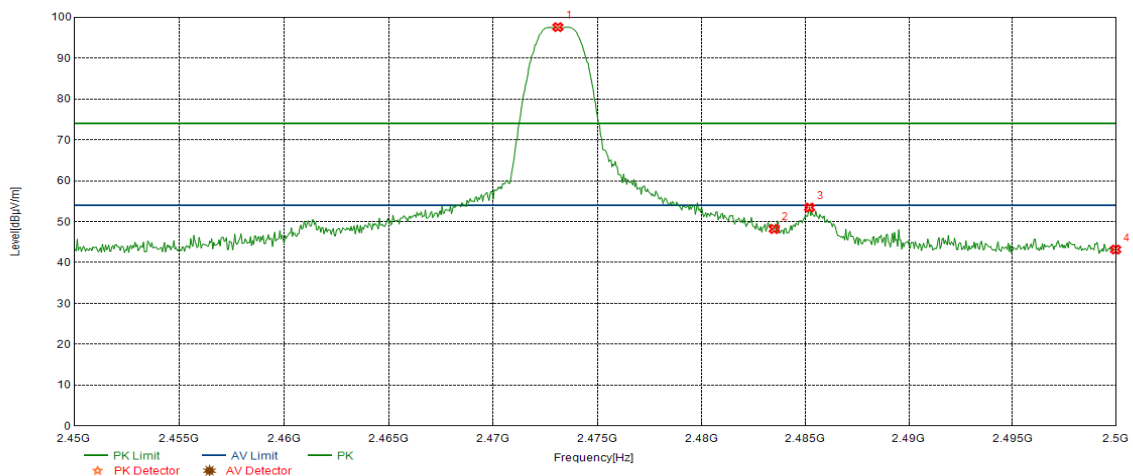

| Freq. [MHz] | PK Reading [dBµV/m] | Level [dBµV/m] | Factor [dB/m] | Limit [dBµV/m] | Margin [dB] | Polarity |
|-------------|---------------------|----------------|---------------|----------------|-------------|----------|
| 2483.50 | 69.00 | 48.20 | -20.80 | 74.00 | 25.80 | Vertical |
| 2485.20 | 74.25 | 53.45 | -20.80 | 74.00 | 20.55 | Vertical |
| 2500.00 | 63.94 | 43.17 | -20.77 | 74.00 | 30.83 | Vertical |

Level = Read level + Factor

Factor= Antenna Factor + Cable loss – Preamp Factor

Field strength of fundamental

| PK Final Data List | | | | | | | | |
|--------------------|-------------|---------------------------|---------------|-------------------------|-------------------------|----------------|------------|---------|
| NO. | Freq. [MHz] | PK Reading [dB μ V/m] | Factor [dB/m] | PK Value [dB μ V/m] | PK Limit [dB μ V/m] | PK Margin [dB] | Polarity | Verdict |
| 1 | 2410.5163 | 99.80 | -0.52 | 99.28 | 113.98 | 14.70 | Horizontal | PASS |

| AV Final Data List | | | | | | | | |
|--------------------|-------------|---------------------------|---------------|-------------------------|-------------------------|----------------|------------|---------|
| NO. | Freq. [MHz] | AV Reading [dB μ V/m] | Factor [dB/m] | AV Value [dB μ V/m] | AV Limit [dB μ V/m] | AV Margin [dB] | Polarity | Verdict |
| 1 | 2410.5163 | 93.56 | -0.52 | 93.04 | 93.98 | 0.94 | Horizontal | PASS |

| PK Final Data List | | | | | | | | |
|--------------------|-------------|---------------------------|---------------|-------------------------|-------------------------|----------------|----------|---------|
| NO. | Freq. [MHz] | PK Reading [dB μ V/m] | Factor [dB/m] | PK Value [dB μ V/m] | PK Limit [dB μ V/m] | PK Margin [dB] | Polarity | Verdict |
| 1 | 2410.1303 | 97.92 | -0.52 | 97.40 | 113.98 | 16.58 | Vertical | PASS |

| AV Final Data List | | | | | | | | |
|--------------------|-------------|---------------------------|---------------|-------------------------|-------------------------|----------------|----------|---------|
| NO. | Freq. [MHz] | AV Reading [dB μ V/m] | Factor [dB/m] | AV Value [dB μ V/m] | AV Limit [dB μ V/m] | AV Margin [dB] | Polarity | Verdict |
| 1 | 2410.1303 | 93.86 | -0.52 | 93.34 | 93.98 | 0.64 | Vertical | PASS |

| PK Final Data List | | | | | | | | |
|--------------------|-------------|---------------------------|---------------|-------------------------|-------------------------|----------------|------------|---------|
| NO. | Freq. [MHz] | PK Reading [dB μ V/m] | Factor [dB/m] | PK Value [dB μ V/m] | PK Limit [dB μ V/m] | PK Margin [dB] | Polarity | Verdict |
| 1 | 2442.5445 | 100.31 | -0.49 | 99.82 | 113.98 | 14.16 | Horizontal | PASS |

| AV Final Data List | | | | | | | | |
|--------------------|-------------|---------------------------|---------------|-------------------------|-------------------------|----------------|------------|---------|
| NO. | Freq. [MHz] | AV Reading [dB μ V/m] | Factor [dB/m] | AV Value [dB μ V/m] | AV Limit [dB μ V/m] | AV Margin [dB] | Polarity | Verdict |
| 1 | 2442.5445 | 94.05 | -0.49 | 93.56 | 93.98 | 0.42 | Horizontal | PASS |

| PK Final Data List | | | | | | | | |
|--------------------|-------------|---------------------------|---------------|-------------------------|-------------------------|----------------|----------|---------|
| NO. | Freq. [MHz] | PK Reading [dB μ V/m] | Factor [dB/m] | PK Value [dB μ V/m] | PK Limit [dB μ V/m] | PK Margin [dB] | Polarity | Verdict |
| 1 | 2442.2168 | 98.54 | -0.49 | 98.05 | 113.98 | 15.93 | Vertical | PASS |

| AV Final Data List | | | | | | | | |
|--------------------|-------------|---------------------------|---------------|-------------------------|-------------------------|----------------|----------|---------|
| NO. | Freq. [MHz] | AV Reading [dB μ V/m] | Factor [dB/m] | AV Value [dB μ V/m] | AV Limit [dB μ V/m] | AV Margin [dB] | Polarity | Verdict |
| 1 | 2442.2168 | 93.36 | -0.49 | 92.87 | 93.98 | 1.11 | Vertical | PASS |

| PK Final Data List | | | | | | | | |
|--------------------|-------------|---------------------------|---------------|-------------------------|-------------------------|----------------|------------|---------|
| NO. | Freq. [MHz] | PK Reading [dB μ V/m] | Factor [dB/m] | PK Value [dB μ V/m] | PK Limit [dB μ V/m] | PK Margin [dB] | Polarity | Verdict |
| 1 | 2472.7208 | 101.18 | -0.47 | 100.71 | 113.98 | 13.27 | Horizontal | PASS |

| AV Final Data List | | | | | | | | |
|--------------------|-------------|---------------------------|---------------|-------------------------|-------------------------|----------------|------------|---------|
| NO. | Freq. [MHz] | AV Reading [dB μ V/m] | Factor [dB/m] | AV Value [dB μ V/m] | AV Limit [dB μ V/m] | AV Margin [dB] | Polarity | Verdict |
| 1 | 2472.7208 | 92.73 | -0.47 | 92.26 | 93.98 | 1.72 | Horizontal | PASS |

| PK Final Data List | | | | | | | | |
|--------------------|-------------|---------------------------|---------------|-------------------------|-------------------------|----------------|----------|---------|
| NO. | Freq. [MHz] | PK Reading [dB μ V/m] | Factor [dB/m] | PK Value [dB μ V/m] | PK Limit [dB μ V/m] | PK Margin [dB] | Polarity | Verdict |
| 1 | 2473.5108 | 98.98 | -0.47 | 98.51 | 113.98 | 15.47 | Vertical | PASS |

| AV Final Data List | | | | | | | | |
|--------------------|-------------|---------------------------|---------------|-------------------------|-------------------------|----------------|----------|---------|
| NO. | Freq. [MHz] | AV Reading [dB μ V/m] | Factor [dB/m] | AV Value [dB μ V/m] | AV Limit [dB μ V/m] | AV Margin [dB] | Polarity | Verdict |
| 1 | 2473.5108 | 92.91 | -0.47 | 92.44 | 93.98 | 1.54 | Vertical | PASS |

-END OF REPORT-