

Do not mix old and new batteries.
Do not mix alkaline, standard carbon-zinc or rechargeable nickel-cadmium batteries.
Non-rechargeable batteries are not to be recharged.
Rechargeable batteries are to be removed from the toy before being charged.
Rechargeable batteries are only to be charged under adult supervision.
Exhausted batteries are to be removed from the toy.
Not suitable for children under 3 years.
Remove all packaging before giving to child.
Packaging should be kept since it contains important information.
Colors and contents may vary from illustration.

This device complies with Part 15 of the FCC Rules. Operation is subject to the following two conditions:

(1) this device may not cause harmful interference, and (2) this device must accept any interference received, including interference that may cause undesired operation.

FCC ID: 2AE67-2114

Warning: Changes or modifications to this unit not expressly approved by the party responsible for compliance could void the user's authority to operate the equipment.

NOTE: This equipment has been tested and found to comply with the limits for a Class B digital device, pursuant to Part 15 of the FCC Rules. These limits are designed to provide reasonable protection against harmful interference in a residential installation. This equipment generates, uses and can radiate radio frequency energy and, if not installed and used in accordance with the instructions, may cause harmful interference to radio communications. However, there is no guarantee that interference will not occur in a particular installation. If this equipment does cause harmful interference to radio or television reception, which can be determined by turning the equipment off and on, the user is encouraged to try to correct the interference by one or more of the following measures:

- Reorient or relocate the receiving antenna.
- Increase the separation between the equipment and receiver.
- Connect the equipment into an outlet on a circuit different from that to which the receiver is connected.
- Consult the dealer or an experienced radio/TV technician for help.

"This device complies with FCC radiation exposure limits set forth for general population (uncontrolled exposure).

This device must not be collocated or operating in conjunction with any other antenna or transmitter."



Please read
entire manual
prior to operation

For Ages
5+

Please
keep these
instructions

REMOTE CONTROL
ROCK CLIMBER

Owner's Manual
ITEM # KL-2114

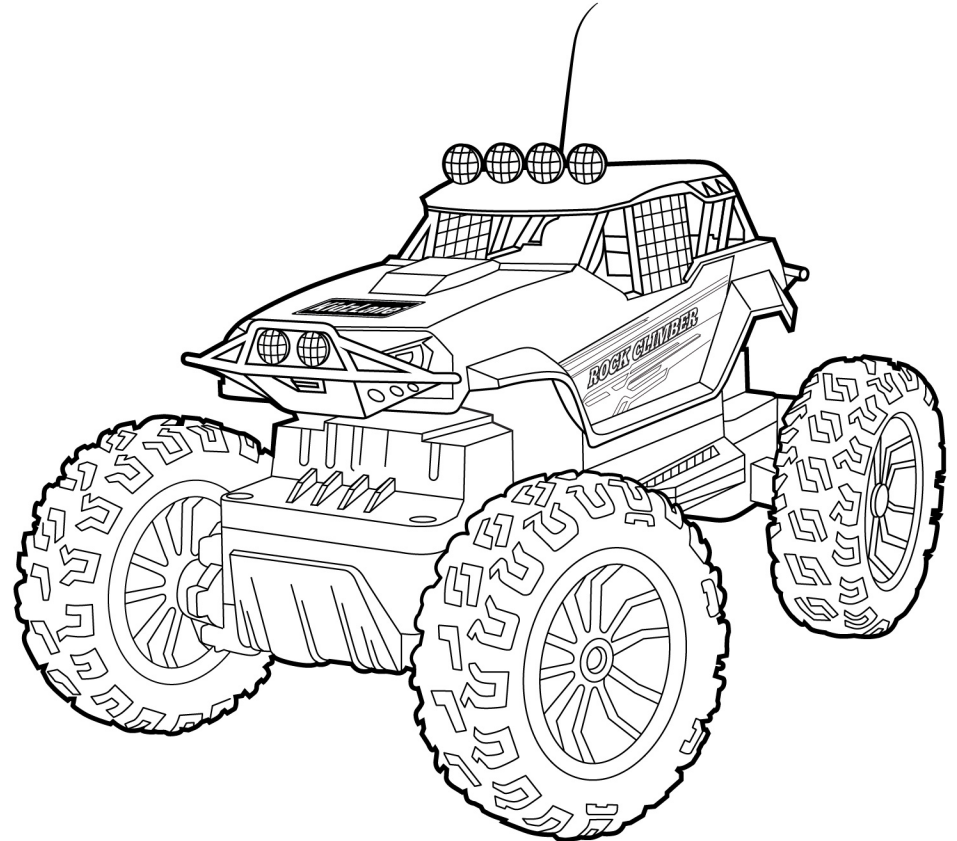

Manufactured and
Imported by



BROOKLYN, NY 11205
www.kidzlane.com
© 2019 KIDZLANE

WHAT'S INCLUDED

1. Rock Climber Car
2. All Direction Controller

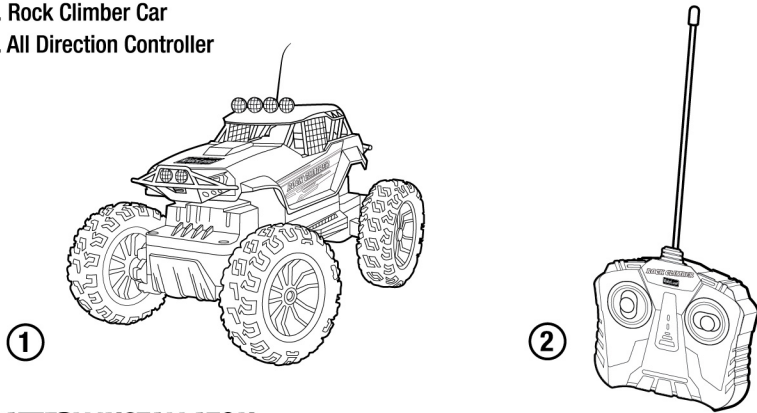

BATTERY INSTALLATION

STEP 1:

Note: Carefully remove all content from the packaging.

1. Make sure the power switch on the car is set to the OFF position.
2. Locate the battery compartment on the bottom of the car, and loosen the screw on the battery cover.
3. Remove the battery cover and insert 4 AA Batteries correctly by matching the + and - polarity markings as indicated.
4. Replace the battery compartment cover and tighten screw.

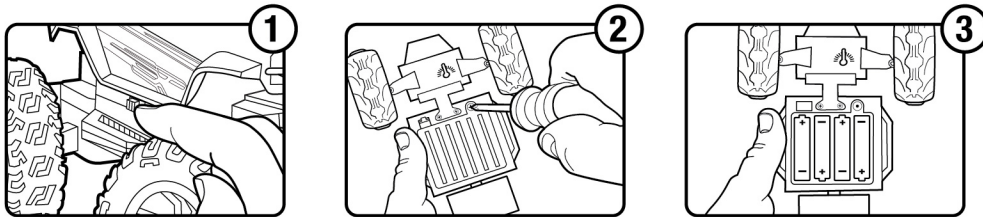

STEP 2:

1. Locate the battery compartment on the back of the remote, and loosen the screw on the battery cover.
2. Remove the battery cover and insert 2 AA Batteries correctly by matching the + and - polarity markings as indicated.
3. Replace the battery compartment cover and tighten screw.

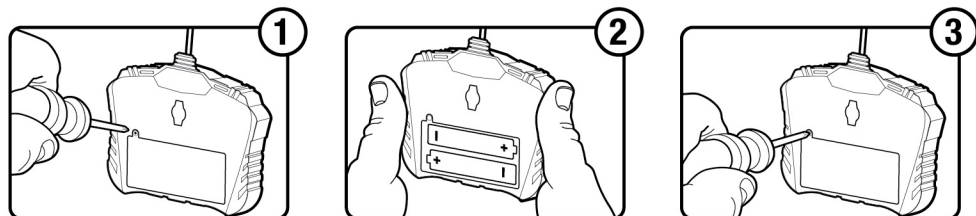

RC CONTROLLER

Turn the power switch on the car to the ON position.

How to Move Forward:

Press the (Arrow Up Image) button on the remote to move the car FORWARD.

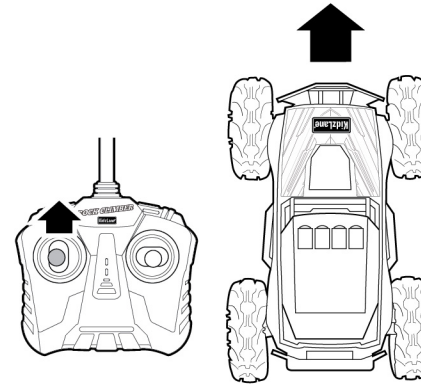

How to Move Backwards:

Press the (Arrow Down Image) button on the remote to move the car BACKWARD.

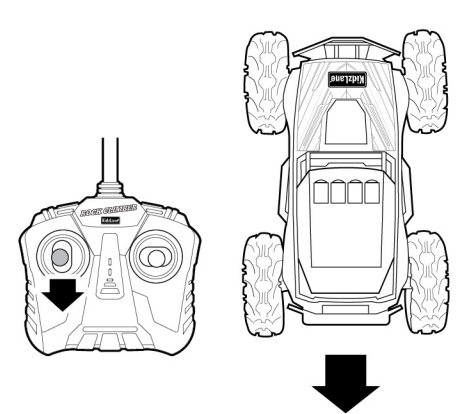

How to Turn Right:

Press the (Arrow Up Image) button and the (Arrow Right Image) on the remote at the same time to TURN RIGHT while going forward.

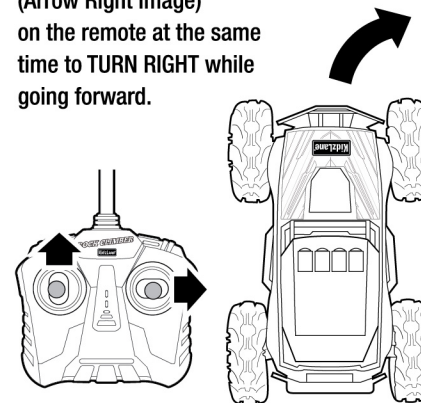

How to Turn Left:

Press the (Arrow Up Image) button and the (Arrow Left Image) on the remote at the same time to TURN LEFT while going forward.

