



# FCC Part 15C Test Report

## FCC ID: 2AE53NC-25

Product Name:	<b>Active Noise Cancelling Wireless Bluetooth Headphone</b>
Trademark:	<b>N/A</b>
Model Name :	<b>NC-25 NC-35, NC-45, NC-55, NC-65, NC-75, NC-85, NC-95, NC-26, NC-36.</b>
Prepared For :	<b>Lighkeep Limited</b>
Address :	401 Room, 4th Floor, B Block, No. 37 Dequan Road, 228 Industrial Zone, Henggang Town, Longgang District, Shenzhen City, China
Prepared By :	<b>Shenzhen BCTC Technology Co., Ltd.</b>
Address :	No.101, Yousong Road, Longhua New District, Shenzhen, China
Test Date:	<b>Dec. 28, 2016 - Jan. 06, 2017</b>
Date of Report :	<b>Jan. 06, 2017</b>
Report No.:	<b>BCTC-FY161206912E</b>



### CERTIFICATION

**Applicant's name** ..... : Lighkeep Limited  
**Address**..... : 401 Room, 4th Floor, B Block, No. 37 Dequan Road, 228 Industrial Zone, Henggang Town, Longgang District, Shenzhen City, China  
**Manufacture's Name** ..... : Lighkeep Limited  
**Address**..... : 401 Room, 4th Floor, B Block, No. 37 Dequan Road, 228 Industrial Zone, Henggang Town, Longgang District, Shenzhen City, China

#### Product description

**Product name** ..... : Active Noise Cancelling Wireless Bluetooth Headphone  
**Trademark:** N/A  
**Model Name:** NC-25  
**Test Standards:** ANSI C63.4-2014, ANSI C63.10-2013  
 FCC Part15.249

This device described above has been tested by BCTC, and the test results show that the equipment under test (EUT) is in compliance with the FCC requirements. And it is applicable only to the tested sample identified in the report.

This report shall not be reproduced except in full, without the written approval of BCTC, this document may be altered or revised by BCTC, personal only, and shall be noted in the revision of the document.

Test Result ..... : **Pass**

Testing Engineer :   
 \_\_\_\_\_  
 Eric Yang

Reviewer (Supervisor) :   
 \_\_\_\_\_  
 Jade Yang

Approved & Authorized Signer(Manager) :   
 \_\_\_\_\_  
 Carson Zhang





<b>Table of Contents</b>	<b>Page</b>
<b>1 . SUMMARY OF TEST RESULTS</b>	<b>5</b>
1.1 TEST FACILITY	5
1.2 MEASUREMENT UNCERTAINTY	5
<b>2 . GENERAL INFORMATION</b>	<b>6</b>
2.1 GENERAL DESCRIPTION OF EUT	6
2.2 DESCRIPTION OF TEST MODES	7
2.3 TABLE OF PARAMETERS OF TEXT SOFTWARE SETTING	7
2.4 BLOCK DIGRAM SHOWING THE CONFIGURATION OF SYSTEM TESTED	7
2.5 DESCRIPTION OF SUPPORT UNITS(CONDUCTED MODE)	8
2.6 EQUIPMENTS LIST FOR ALL TEST ITEMS	9
<b>3 . EMC EMISSION TEST</b>	<b>10</b>
3.1 CONDUCTED EMISSION MEASUREMENT	10
3.1.1 POWER LINE CONDUCTED EMISSION LIMITS	10
3.1.2 TEST PROCEDURE	11
3.1.3 DEVIATION FROM TEST STANDARD	11
3.1.4 TEST SETUP	11
3.1.5 EUT OPERATING CONDITIONS	11
3.1.6 TEST RESULTS	12
3.2 RADIATED EMISSION MEASUREMENT	14
3.2.1 RADIATED EMISSION LIMITS	14
3.2.2 TEST PROCEDURE	15
3.2.3 DEVIATION FROM TEST STANDARD	15
3.2.4 TEST SETUP	16
3.2.5 EUT OPERATING CONDITIONS	17
3.2.6 TEST RESULTS	18
<b>4 . BANDWIDTH TEST</b>	<b>22</b>
4.1 APPLIED PROCEDURES / LIMIT	22
4.1.1 TEST PROCEDURE	22
4.1.2 DEVIATION FROM STANDARD	22
4.1.3 TEST SETUP	22
4.1.4 EUT OPERATION CONDITIONS	22
4.1.5 TEST RESULTS	23
<b>5 . BAND EDGE EMISSION</b>	<b>25</b>
5.1 DEVIATION FROM STANDARD	25
5.2 EUT OPERATION CONDITIONS	25
5.3 TEST RESULTS	26



<b>Table of Contents</b>	<b>Page</b>
<b>6 . ANTENNA REQUIREMENT</b>	<b>29</b>
<b>6.1 STANDARD REQUIREMENT</b>	<b>29</b>
<b>6.2 EUT ANTENNA</b>	<b>29</b>
<b>7 . EUT TEST PHOTO</b>	<b>30</b>
<b>8 . PHOTOS OF THE EUT</b>	<b>32</b>



## 1. SUMMARY OF TEST RESULTS

Test procedures according to the technical standards:

FCC Part15 (15.249) , Subpart C			
Standard Section	Test Item	Judgment	Remark
15.207	Conducted Emission	PASS	
15.249	Fundamental & Radiated Spurious Emission Measurement	PASS	
15.249	Bandwidth	PASS	
15.205	Band Edge Emission	PASS	
15.203	Antenna Requirement	PASS	

NOTE:

(1) "N/A" denotes test is not applicable in this Test Report

### 1.1 TEST FACILITY

Shenzhen BCTC Technology Co., Ltd.  
Add.: No.101, Yousong Road, Longhua New District, Shenzhen, China  
FCC Registration No.: 187086

### 1.2 MEASUREMENT UNCERTAINTY

The reported uncertainty of measurement  $y \pm U$ , where expanded uncertainty  $U$  is based on a standard uncertainty multiplied by a coverage factor of  $k=2$ , providing a level of confidence of approximately 95 %.

No.	Item	Uncertainty
1	Conducted Emission Test	$\pm 1.38\text{dB}$
2	RF power, conducted	$\pm 0.16\text{dB}$
3	Spurious emissions, conducted	$\pm 0.21\text{dB}$
4	All emissions, radiated (<1G)	$\pm 4.68\text{dB}$
5	All emissions, radiated (>1G)	$\pm 4.89\text{dB}$
6	Temperature	$\pm 0.5^\circ\text{C}$
7	Humidity	$\pm 2\%$



## 2. GENERAL INFORMATION

### 2.1 GENERAL DESCRIPTION OF EUT

Equipment	Active Noise Cancelling Wireless Bluetooth Headphone	
Trademark	N/A	
Model Name	NC-25	
Serial Model	NC-35, NC-45, NC-55, NC-65, NC-75, NC-85, NC-95, NC-26, NC-36.	
Model Difference	All the model are the same circuit and RF module, except model names and color.	
Product Description	Operation Frequency:	2402~2480 MHz
	Modulation Type:	GFSK
	Bit Rate of Transmitter	2M
	Number Of Channel	40 CH
	Antenna Designation:	Please see Note 3.
Based on the application, features, or specification exhibited in User's Manual, the EUT is considered as an ITE/Computing Device. More details of EUT technical specification, please refer to the User's Manual.		
Channel List	Please refer to the Note 2.	
Battery	DC 3.7V From Battery	
Adapter	Adapter Model: CA05-050100U AC Power Input: 100-240V~ 50/60Hz 0.15A Output: 5V--- 1.0A	
Connecting I/O Port(s)	Please refer to the User's Manual	
hardware version	--	
Software version	--	
Serial number	--	

Note:

1. For a more detailed features description, please refer to the manufacturer's specifications or the User's Manual.

2

Channel List					
Channel	Frequency (MHz)	Channel	Frequency (MHz)	Channel	Frequency (MHz)
01	2402	11	2422	21	2442
02	2404	12	2424	22	2444
03	2406	13	2426	23	2446
~	~	~	~	~	~
09	2418	19	2438	39	2478
10	2420	20	2440	40	2480



3. Table for Filed Antenna

Ant.	Brand	Model Name	Antenna Type	Gain (dBi)	NOTE
1	N/A	N/A	PCB Antenna	0	

2.2 DESCRIPTION OF TEST MODES

To investigate the maximum EMI emission characteristics generates from EUT, the test system was pre-scanning tested base on the consideration of following EUT operation mode or test configuration mode which possible have effect on EMI emission level. Each of these EUT operation mode(s) or test configuration mode(s) mentioned above was evaluated respectively.

For Conducted & Radiated Emission	
Final Test Mode	Description
Mode 1	CH01
Mode 2	CH20
Mode 3	CH40
Mode 4	Link Mode

Note:

- (1) The measurements are performed at the highest, middle, lowest available channels.
- (2) Fully-charged battery is used during the test

2.3 TABLE OF PARAMETERS OF TEXT SOFTWARE SETTING

During testing channel & power controlling software provided by the customer was used to control the operating channel as well as the output power level. The RF output power selection is for the setting of RF output power expected by the customer and is going to be fixed on the firmware of the final end product power parameters of FHSS

Frequency	2402 MHz	2440 MHz	2480 MHz
Channel	Low	Middle	High

2.4 BLOCK DIGRAM SHOWING THE CONFIGURATION OF SYSTEM TESTED

Radiated Spurious Emission Test

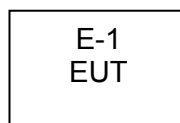



### Conducted Emission Test

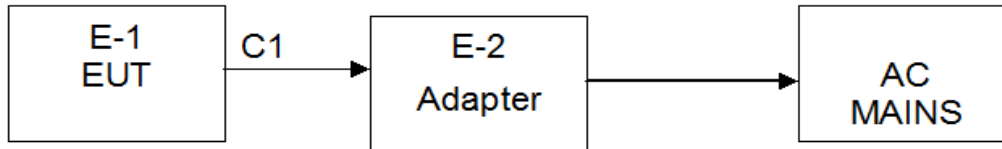

### 2.5 DESCRIPTION OF SUPPORT UNITS(CONDUCTED MODE)

The EUT has been tested as an independent unit together with other necessary accessories or support units. The following support units or accessories were used to form a representative test configuration during the tests.

Item	Equipment	Mfr/Brand	Model/Type No.	Series No.	Note
E-1	Active Noise Cancelling Wireless Bluetooth Headphone	N/A	NC-25	N/A	EUT
E-2	Adapter	N/A	CA05-050100U	N/A	Lab Provide

Item	Shielded Type	Ferrite Core	Length	Note
C1	NO	NO	1.0M	USB cable unshielded

Note:

- (1) The support equipment was authorized by Declaration of Confirmation.
- (2) For detachable type I/O cable should be specified the length in cm in 『Length』 column.
- (3) “YES” is means “shielded” “with core”; “NO” is means “unshielded” “without core”.





## 2.6 EQUIPMENTS LIST FOR ALL TEST ITEMS

### Conduction Test equipment

Item	Kind of Equipment	Manufacturer	Type No.	Serial No.	Last calibration	Calibrated until	Calibration period
1	Test Receiver	R&S	ESCI	1166.5950K03-101165-ha	2016.06.05	2017.06.04	1 year
2	LISN	R&S	NSLK8126	8126466	2016.08.24	2017.08.23	1 year
3	LISN	R&S	NSLK8126	8126487	2016.08.24	2017.08.23	1 year
4	50Ω Coaxial Switch	Anritsu	MP59B	6200264417	2016.06.05	2017.06.04	1 year
5	RF cables	R&S	R204	R20X	2016.06.05	2017.06.04	1 year

### Radiation test, Band-edge test and 20db bandwidth test equipment

Item	Kind of Equipment	Manufacturer	Type No.	Serial No.	Last calibration	Calibrated until	Calibration period
1	Spectrum Analyzer	Agilent	E4407B	MY45108040	2016.06.05	2017.06.04	1 year
2	Test Receiver	R&S	ESPI	101318	2016.06.05	2017.06.04	1 year
3	Bilog Antenna	R&S	VULB9168	VULB9168-438	2016.06.05	2017.06.04	1 year
4	50Ω Coaxial Switch	Anritsu	MP59B	6200264416	2016.06.05	2017.06.04	1 year
5	Spectrum Analyzer	ADVANTEST	R3132	150900201	2016.06.05	2017.06.04	1 year
6	Horn Antenna	R&S	HF906	10027	2016.06.05	2017.06.04	1 year
7	Horn Ant	Schwarzbeck	BBHA 9170	9170-181	2016.06.05	2017.06.04	1 year
8	Amplifier	R&S	BBV9743	9743-019	2016.06.05	2017.08.23	1 year
9	Loop Antenna	ARA	PLA-1030/B	1029	2016.06.05	2017.06.04	1 year
10	RF cables	R&S	R203	R20X	2016.06.05	2017.06.04	1 year
11	Antenna connector	Florida RFLabs	Lab-Fle	RF 01#	2016.06.05	2017.06.04	1 year



### 3. EMC EMISSION TEST

#### 3.1 CONDUCTED EMISSION MEASUREMENT

##### 3.1.1 POWER LINE CONDUCTED EMISSION Limits (Frequency Range 150KHz-30MHz)

FREQUENCY (MHz)	dBuV		Standard
	Quasi-peak	Average	
0.15 -0.5	66 - 56 *	56 - 46 *	CISPR
0.50 -5.0	56.00	46.00	CISPR
5.0 -30.0	60.00	50.00	CISPR

0.15 -0.5	66 - 56 *	56 - 46 *	FCC
0.50 -5.0	56.00	46.00	FCC
5.0 -30.0	60.00	50.00	FCC

Note:

- (1) The tighter limit applies at the band edges.
- (2) The limit of " \* " marked band means the limitation decreases linearly with the logarithm of the frequency in the range.

The following table is the setting of the receiver

Receiver Parameters	Setting
Attenuation	10 dB
Start Frequency	0.15 MHz
Stop Frequency	30 MHz
IF Bandwidth	9 kHz

### 3.1.2 TEST PROCEDURE

- The EUT was placed 0.8 meters from the horizontal ground plane with EUT being connected to the power mains through a line impedance stabilization network (LISN). All other support equipments powered from additional LISN(s). The LISN provide 50 Ohm/ 50uH of coupling impedance for the measuring instrument.
- Interconnecting cables that hang closer than 40 cm to the ground plane shall be folded back and forth in the center forming a bundle 30 to 40 cm long.
- I/O cables that are not connected to a peripheral shall be bundled in the center. The end of the cable may be terminated, if required, using the correct terminating impedance. The overall length shall not exceed 1 m.
- LISN at least 80 cm from nearest part of EUT chassis.
- For the actual test configuration, please refer to the related Item –EUT Test Photos.

### 3.1.3 DEVIATION FROM TEST STANDARD

No deviation

### 3.1.4 TEST SETUP

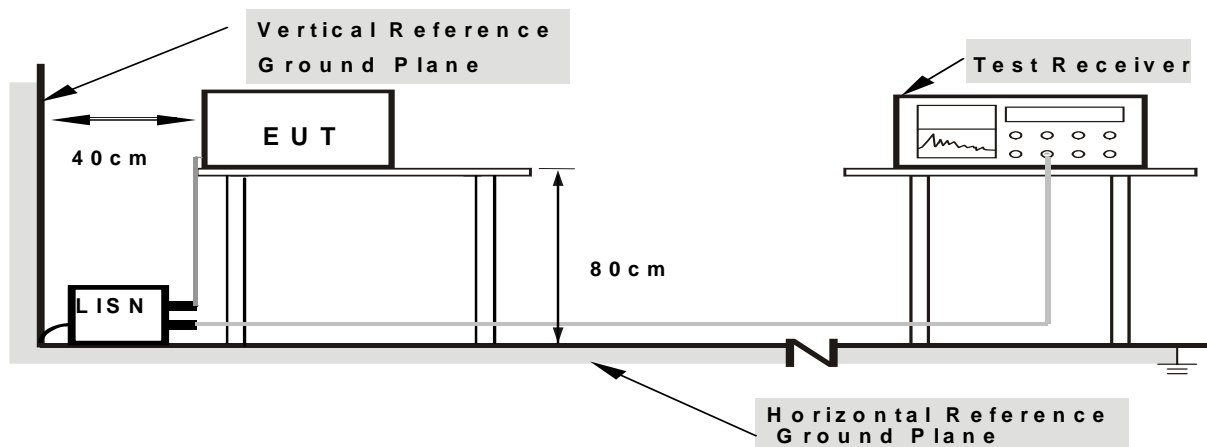

- Note: 1.Support units were connected to second LISN.  
2.Both of LISNs (AMN) are 80 cm from EUT and at least 80 from other units and other metal planes

### 3.1.5 EUT OPERATING CONDITIONS

The EUT was configured for testing in a typical fashion (as a customer would normally use it). The EUT has been programmed to continuously transmit during test. This operating condition was tested and used to collect the included data.

We pretest AC 120V and AC 240V, the worst voltage was AC 120V and the data recording in the report.



**3.1.6 TEST RESULTS**

Temperature :	25°C	Relative Humidity :	54%
Pressure :	1010hPa	Phase :	L
Test Voltage :	AC120V/60Hz	Test Mode :	Mode 4

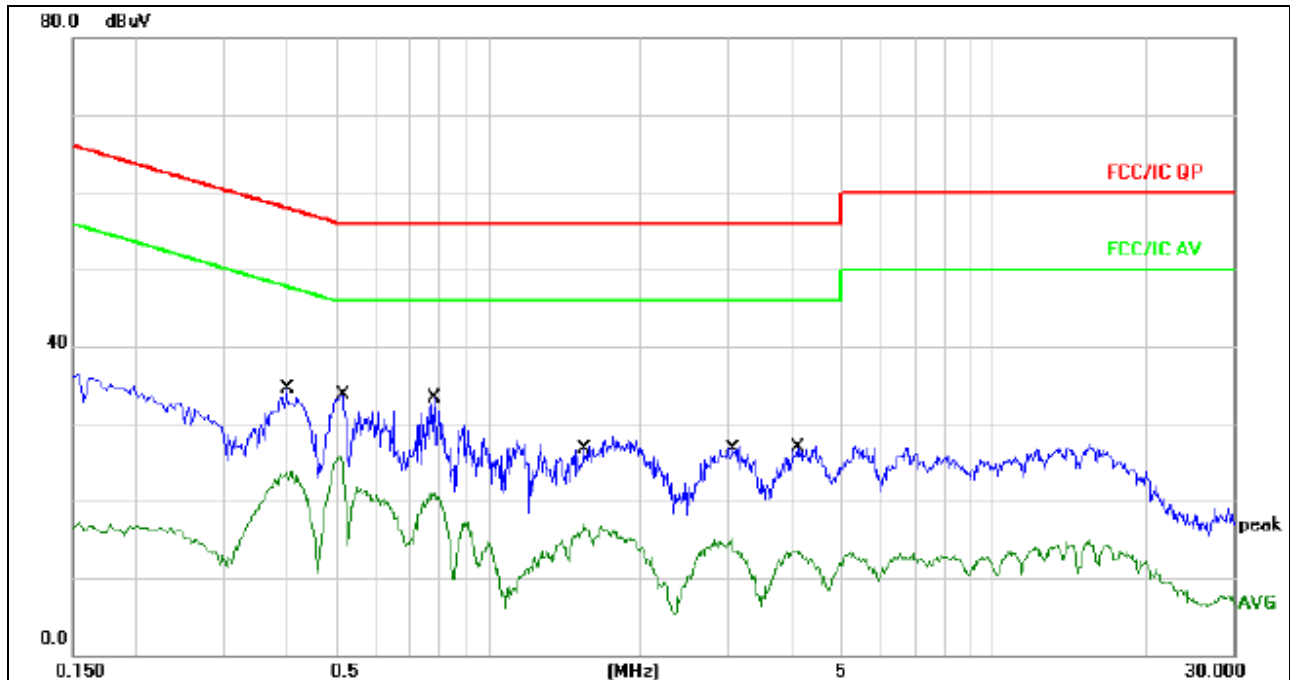

Remark:

1. All readings are Quasi-Peak and Average values.
2. Factor = Insertion Loss + Cable Loss.

No. Mk.	Freq. MHz	Reading Level dBuV	Correct Factor dB	Measure- ment dBuV	Limit dBuV	Over dB	Detector	Comment
1	0.3980	24.87	9.66	34.53	57.89	-23.36	QP	
2	0.3980	14.11	9.66	23.77	47.89	-24.12	AVG	
3	0.5100	24.07	9.68	33.75	56.00	-22.25	QP	
4 *	0.5100	16.00	9.68	25.68	46.00	-20.32	AVG	
5	0.7820	23.52	9.68	33.20	56.00	-22.80	QP	
6	0.7820	11.51	9.68	21.19	46.00	-24.81	AVG	
7	1.5500	18.67	9.71	28.38	56.00	-27.62	QP	
8	1.5500	7.13	9.71	16.84	46.00	-29.16	AVG	
9	3.0260	17.30	9.72	27.02	56.00	-28.98	QP	
10	3.0260	5.29	9.72	15.01	46.00	-30.99	AVG	
11	4.0580	17.35	9.73	27.08	56.00	-28.92	QP	
12	4.0580	3.81	9.73	13.54	46.00	-32.46	AVG	



Temperature :	25°C	Relative Humidity :	54%
Pressure :	1010hPa	Phase :	N
Test Voltage :	AC120V/60Hz	Test Mode :	Mode 4

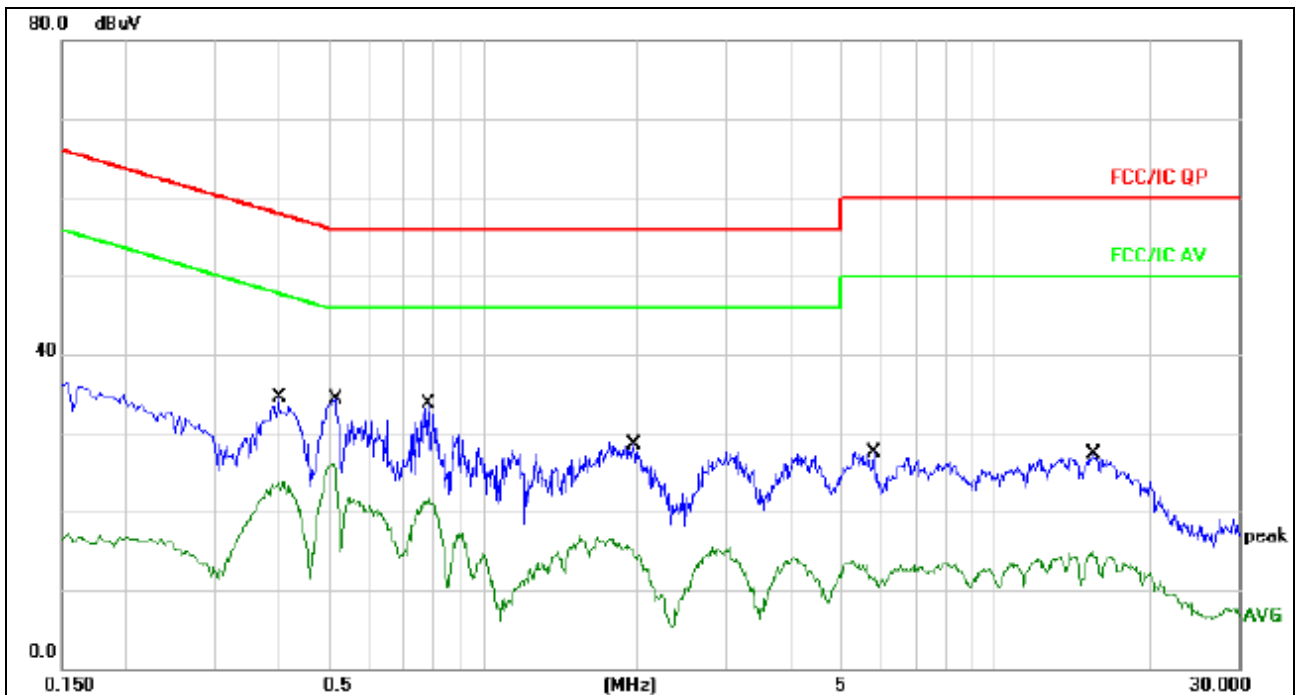

Remark:

1. All readings are Quasi-Peak and Average values.
2. Factor = Insertion Loss + Cable Loss.

No.	Mk.	Freq. MHz	Reading Level dBuV	Correct Factor dB	Measure- ment dBuV	Limit dBuV	Over dB	Detector	Comment
1		0.3976	24.87	9.66	34.53	57.90	-23.37	QP	
2		0.3976	14.11	9.66	23.77	47.90	-24.13	AVG	
3		0.5128	24.57	9.68	34.25	56.00	-21.75	QP	
4	*	0.5128	16.50	9.68	26.18	46.00	-19.82	AVG	
5		0.7792	24.02	9.68	33.70	56.00	-22.30	QP	
6		0.7792	12.01	9.68	21.69	46.00	-24.31	AVG	
7		1.9697	18.72	9.71	28.43	56.00	-27.57	QP	
8		1.9697	6.20	9.71	15.91	46.00	-30.09	AVG	
9		5.8049	17.72	9.76	27.48	60.00	-32.52	QP	
10		5.8049	3.99	9.76	13.75	50.00	-36.25	AVG	
11		15.6349	17.30	9.93	27.23	60.00	-32.77	QP	
12		15.6349	4.91	9.93	14.84	50.00	-35.16	AVG	



### 3.2 RADIATED EMISSION MEASUREMENT

#### 3.2.1 RADIATED EMISSION LIMITS (Frequency Range 9kHz-1000MHz)

20dBc in any 100 kHz bandwidth outside the operating frequency band. In case the emission fall within the restricted band specified on 15.205(a), then the 15.209(a) limit in the table below has to be followed.

Frequencies (MHz)	Field Strength (micorvolts/meter)	Measurement Distance (meters)
0.009~0.490	2400/F(KHz)	300
0.490~1.705	24000/F(KHz)	30
1.705~30.0	30	30
30~88	100	3
88~216	150	3
216~960	200	3
Above 960	500	3

#### LIMITS OF RADIATED EMISSION MEASUREMENT (Above 1000MHz)

FREQUENCY (MHz)	dBuV/m (at 3M)	
	PEAK	AVERAGE
Above 1000	74	54

Notes:

- (1) The limit for radiated test was performed according to FCC PART 15C.
- (2) The tighter limit applies at the band edges.
- (3) Emission level (dBuV/m)=20log Emission level (uV/m).

#### FREQUENCY RANGE OF RADIATED MEASUREMENT (For unintentional radiators)

Highest frequency generated or Upper frequency of measurement used in the device or on which the device operates or tunes (MHz)	Range (MHz)
Below 1.705	30
1.705 – 108	1000
108 – 500	2000
500 – 1000	5000
Above 1000	5 <sup>th</sup> harmonic of the highest frequency or 40 GHz, whichever is lower

Spectrum Parameter	Setting
--------------------	---------



Attenuation	Auto
Start Frequency	1000 MHz
Stop Frequency	10th carrier harmonic
RB / VB (emission in restricted band)	1 MHz / 1 MHz for Peak, 1 MHz / 10Hz for Average

Receiver Parameter	Setting
Attenuation	Auto
Start ~ Stop Frequency	9kHz~150kHz / RB 200Hz for QP
Start ~ Stop Frequency	150kHz~30MHz / RB 9kHz for QP
Start ~ Stop Frequency	30MHz~1000MHz / RB 120kHz for QP

**3.2.2 TEST PROCEDURE**

- a. The measuring distance of at 3 m shall be used for measurements at frequency up to 25GHz. For frequencies above 1GHz, any suitable measuring distance may be used.
- b. The EUT was placed on the top of a rotating table 0.8 and 1.5 meters above the ground at a 3 meter semi-chamber test. The table was rotated 360 degrees to determine the position of the highest radiation.
- c. The height of the equipment or of the substitution antenna shall be 0.8 m; above 1GHz, the height was 1.5m, the height of the test antenna shall vary between 1 m to 4 m. Both horizontal and vertical polarizations of the antenna are set to make the measurement.
- d. The initial step in collecting conducted emission data is a spectrum analyzer peak detector mode pre-scanning the measurement frequency range. Significant peaks are then marked and then Quasi Peak detector mode re-measured.
- e. If the Peak Mode measured value compliance with and lower than Quasi Peak Mode Limit, the EUT shall be deemed to meet QP Limits and then no additional QP Mode measurement performed.
- f. For the actual test configuration, please refer to the related Item –EUT Test Photos.
- g. For the radiated emission test above 1GHz:  
Place the measurement antenna away from each area of the EUT determined to be a source of emissions at the specified measurement distance, while keeping the measurement antenna aimed at the source of emissions at each frequency of significant emissions, with polarization oriented for maximum response.

The measurement antenna may have to be higher or lower than the EUT, depending on the radiation pattern of the emission and staying aimed at the emission source for receiving the maximum signal. The final measurement antenna elevation shall be that which maximizes the emissions. The measurement antenna elevation for maximum emissions shall be restricted to a range of heights of from 1 m to 4 m above the ground or reference ground plane.

Note:

Both horizontal and vertical antenna polarities were tested and performed pretest to three orthogonal axis. The worst case emissions were reported

**3.2.3 DEVIATION FROM TEST STANDARD**

No deviation

### 3.2.4 TEST SETUP

(A) Radiated Emission Test-Up Frequency Below 30MHz

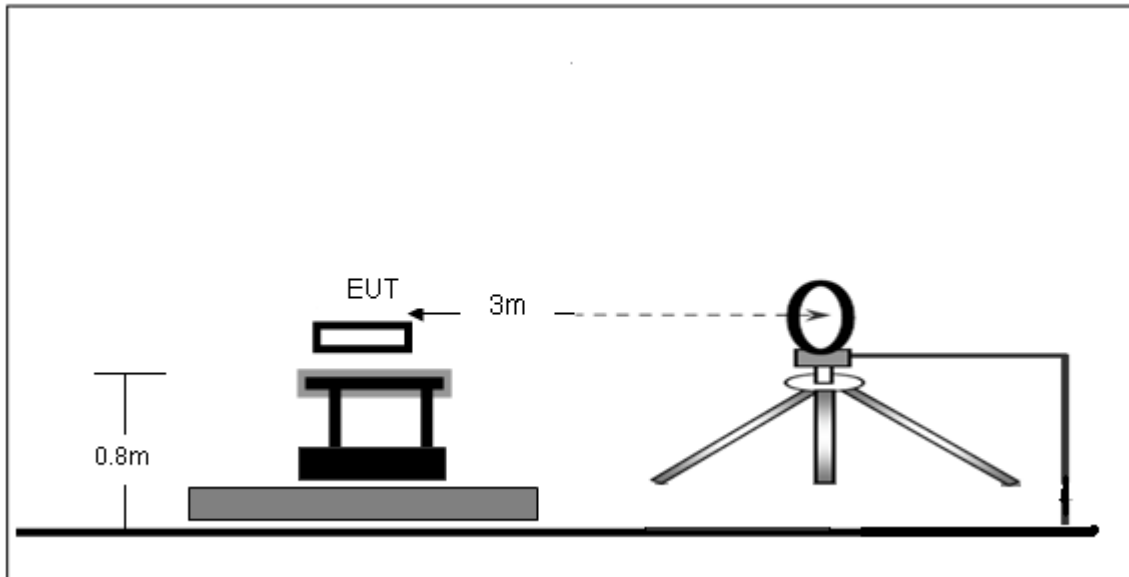

(B) Radiated Emission Test-Up Frequency 30MHz~1GHz

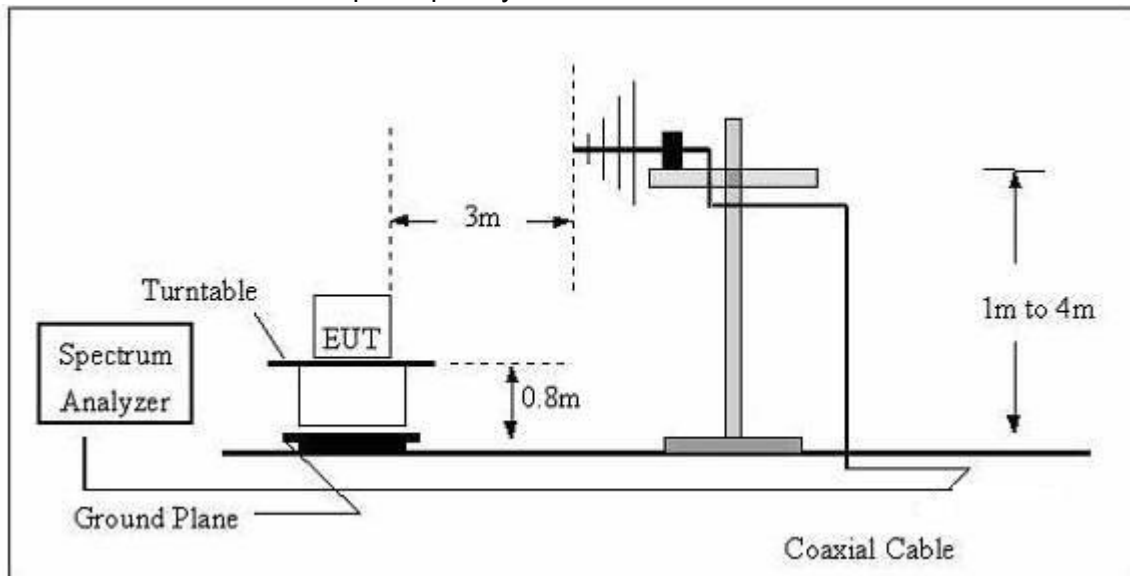



(C) Radiated Emission Test-Up Frequency Above 1GHz

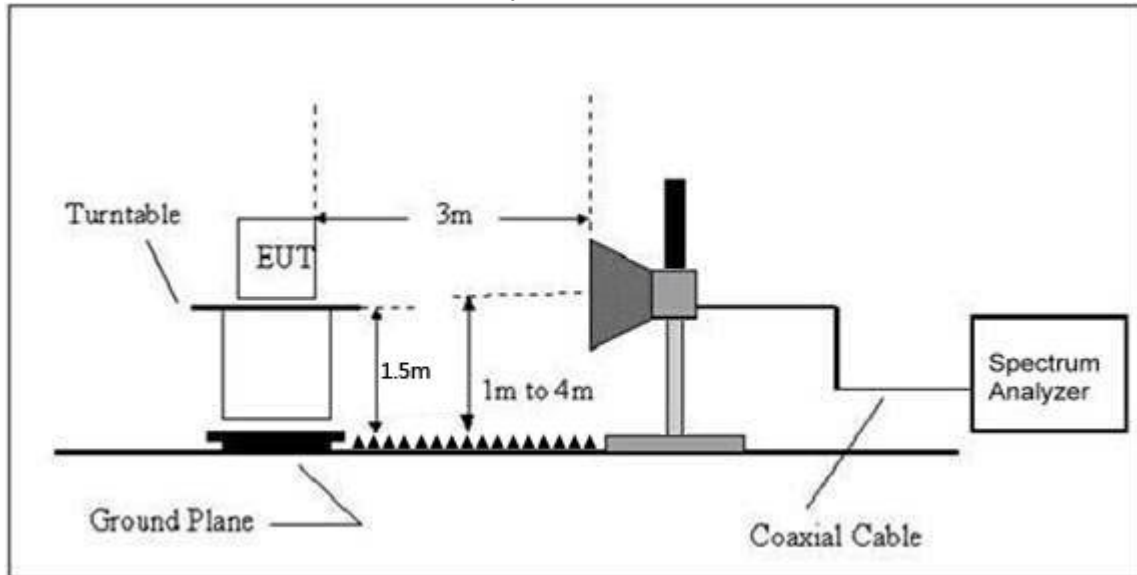

### 3.2.5 EUT OPERATING CONDITIONS

The EUT tested system was configured as the statements of 2.4 Unless otherwise a special operating condition is specified in the follows during the testing.



### 3.2.6 TEST RESULTS

Radiated Spurious Emission (Below 30MHz )

Temperature :	20 °C	Relative Humidity :	48%
Pressure :	1010 hPa	Polarization :	---
Test Voltage :	DC 3.7V From Battery		
Test Mode :	Link Mode		

Freq.	Reading	Limit	Margin	State
(MHz)	(dBuV/m)	(dBuV/m)	(dB)	P/F
--	--	--	--	PASS
--	--	--	--	PASS

**NOTE:**

The amplitude of spurious emissions which are attenuated by more than 20dB below the permissible value has no need to be reported.

Distance extrapolation factor =  $40 \log(\text{specific distance}/\text{test distance})$ (dB);

Limit line = specific limits(dBuv) + distance extrapolation factor.



Radiated Spurious Emission (Between 30MHz – 1GHz)

Temperature :	26 °C	Relative Humidity :	54%
Pressure :	1010 hPa	Polarization :	Horizontal
Test Voltage :	DC 3.7V From Battery		
Test Mode : (Worst)	Link Mode		

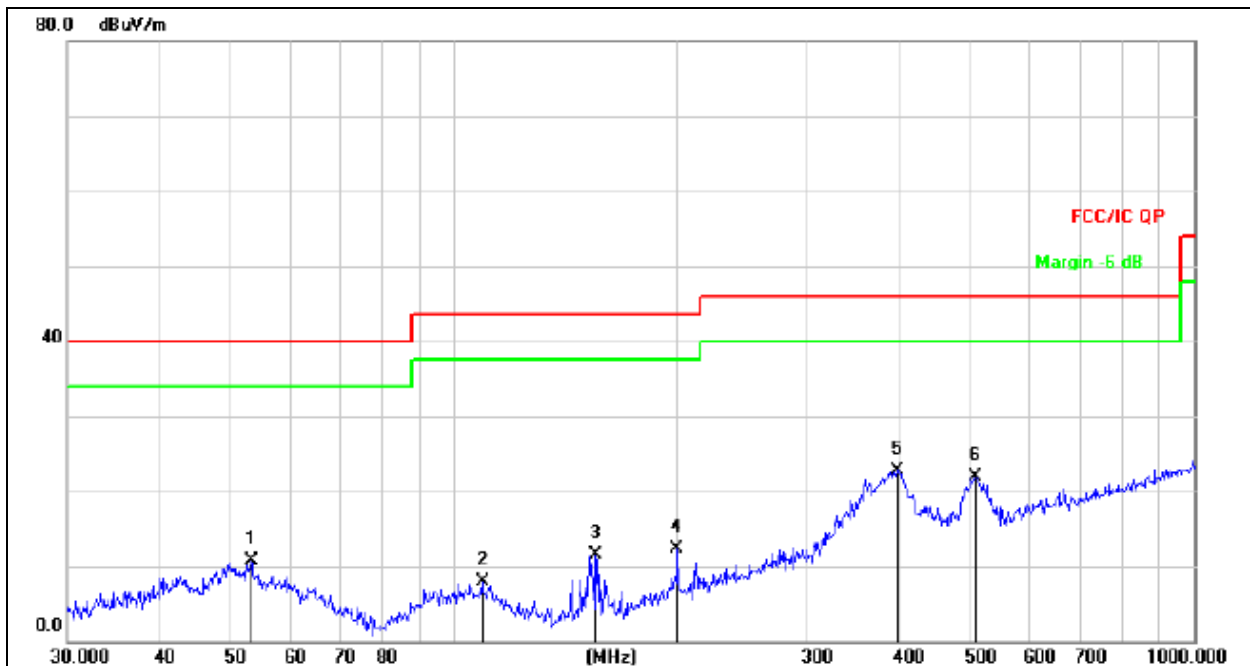

Remark:  
Factor = Antenna Factor + Cable Loss – Pre-amplifier.

No.	Mk.	Freq. MHz	Reading Level dBuV	Correct Factor dB	Measure- ment dBuV/m	Limit dB/m	Over dB	Detector
1		53.1313	25.55	-14.82	10.73	40.00	-29.27	QP
2		109.0286	24.24	-16.41	7.83	43.50	-35.67	QP
3		154.8204	30.93	-19.36	11.57	43.50	-31.93	QP
4		199.9856	28.00	-15.63	12.37	43.50	-31.13	QP
5	*	397.6334	32.29	-9.49	22.80	46.00	-23.20	QP
6		506.4791	28.91	-7.03	21.88	46.00	-24.12	QP

Temperature :	26 °C	Relative Humidity :	54%
---------------	-------	---------------------	-----



Pressure :	1010 hPa	Polarization :	Vertical
Test Voltage :	DC 3.7V From Battery		
Test Mode : (Worst)	Link Mode		

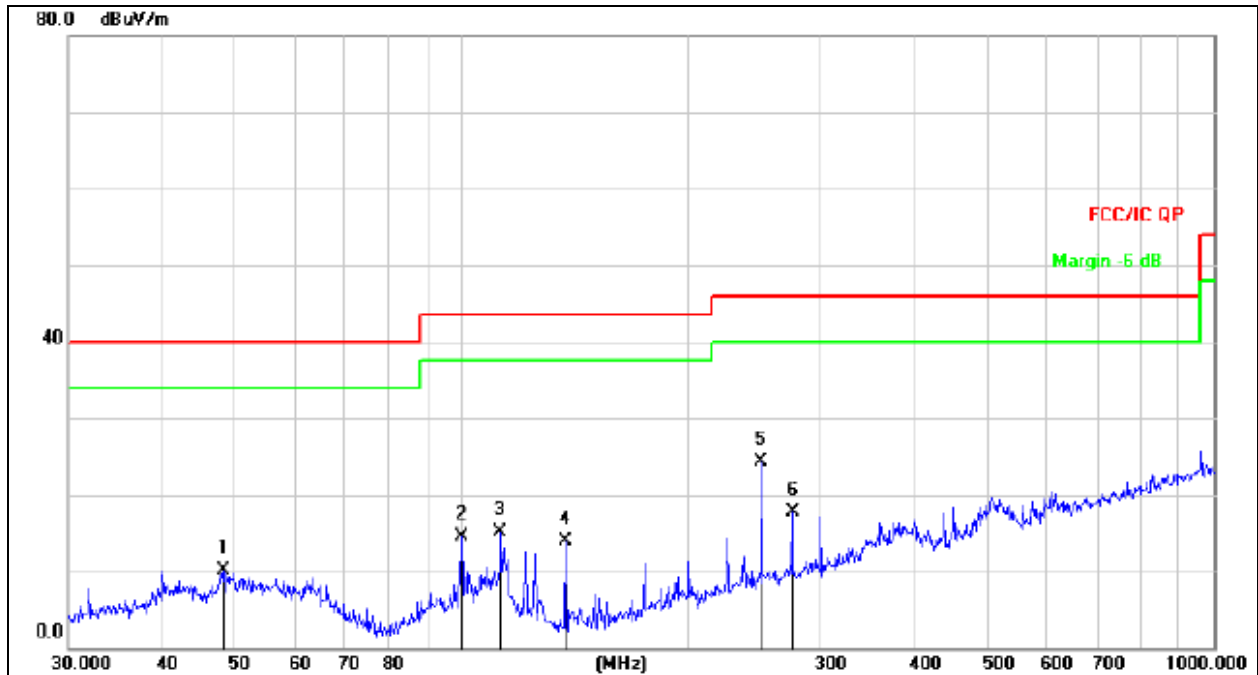

Remark:  
Factor = Antenna Factor + Cable Loss – Pre-amplifier.

No.	Mk.	Freq.	Reading Level	Correct Factor	Measurement	Limit	Over	Detector
		MHz	dBuV	dB	dBuV/m	dB/m	dB	
1		48.1626	24.75	-14.71	10.04	40.00	-29.96	QP
2		99.8777	30.97	-16.51	14.46	43.50	-29.04	QP
3		112.5244	31.89	-16.85	15.04	43.50	-28.46	QP
4		137.4202	33.80	-19.83	13.97	43.50	-29.53	QP
5	*	250.3012	38.10	-13.75	24.35	46.00	-21.65	QP
6		275.1570	30.54	-12.89	17.65	46.00	-28.35	QP



Radiated Spurious Emission ( 1GHz to 10<sup>th</sup> harmonics)

GFSK

Polar (H/V)	Frequency	Meter Reading	Pre-amplifier	Cable Loss	Antenna Factor	Emission Level	Limits	Margin	Detector Type
	(MHz)	(dBuV)	(dB)	(dB)	(dB/m)	(dBuV/m)	(dBuV/m)	(dB)	
<b>Low Channel 2402MHz</b>									
V	2402.00	110.40	38.06	7.42	20.15	99.91	114.00	-14.09	PK
V	2402.00	97.24	38.06	7.42	20.15	86.75	94.00	-7.25	AV
V	4804.00	59.01	38.53	7.78	23.25	51.51	74.00	-22.49	PK
V	4804.00	45.46	38.53	7.78	23.25	37.96	54.00	-16.04	AV
V	16132.00	49.65	38.75	10.36	26.57	47.83	74.00	-26.17	PK
H	2402.00	110.37	38.06	7.42	20.15	99.88	114.00	-14.12	PK
H	2402.00	97.83	38.06	7.42	20.15	87.34	94.00	-6.66	AV
H	4804.00	59.83	38.53	7.78	23.25	52.33	74.00	-21.67	PK
H	4804.00	45.34	38.53	7.78	23.25	37.84	54.00	-16.16	AV
H	16132.00	49.39	38.75	10.36	26.57	47.57	74.00	-26.43	PK
<b>Middle Channel 2440MHz</b>									
V	2440.00	110.90	38.11	7.42	20.36	100.57	114.00	-13.43	PK
V	2440.00	97.38	38.11	7.42	20.36	87.05	94.00	-6.95	AV
V	4880.00	59.93	38.65	7.78	23.61	52.67	74.00	-21.33	PK
V	4880.00	45.50	38.65	7.78	23.61	38.24	54.00	-15.76	AV
V	16132.00	47.91	38.75	10.36	26.57	46.09	74.00	-27.91	PK
H	2440.00	110.92	38.11	7.42	20.36	100.59	114.00	-13.41	PK
H	2440.00	98.25	38.11	7.42	20.36	87.92	94.00	-6.08	AV
H	4880.00	60.98	38.65	7.78	23.61	53.72	74.00	-20.28	PK
H	4880.00	46.22	38.65	7.78	23.61	38.96	54.00	-15.04	AV
H	16132.00	49.56	38.75	10.36	26.57	47.74	74.00	-26.26	PK
<b>High Channel 2480MHz</b>									
V	2480.00	110.95	38.17	7.42	20.51	100.71	114.00	-13.29	PK
V	2480.00	92.45	38.17	7.42	20.51	82.21	94.00	-11.79	AV
V	4960.00	60.74	38.69	7.78	23.83	53.66	74.00	-20.34	PK
V	4960.00	45.78	38.69	7.78	23.83	38.7	54.00	-15.30	AV
V	16132.00	49.78	38.75	10.36	26.57	47.96	74.00	-26.04	PK
H	2480.00	110.98	38.17	7.42	20.51	100.74	114.00	-13.26	PK
H	2480.00	98.34	38.17	7.42	20.51	88.1	94.00	-5.90	AV
H	4960.00	60.93	38.69	7.78	23.83	53.85	74.00	-20.15	PK
H	4960.00	45.81	38.69	7.78	23.83	38.73	54.00	-15.27	AV
H	16132.00	50.09	38.75	10.36	26.57	48.27	74.00	-25.73	PK

**Remark:**

1. Emission Level = Meter Reading + Antenna Factor + Cable Loss – Pre-amplifier,  
Margin= Emission Level - Limit
2. If peak below the average limit, the average emission was no test.
3. The amplitude of spurious emissions which are attenuated by more than 20dB below the permissible value has no need to be reported.



#### 4. BANDWIDTH TEST

##### 4.1 APPLIED PROCEDURES / LIMIT

FCC Part15 (15.249) , Subpart C				
Section	Test Item	Limit	Frequency Range (MHz)	Result
15.249	Bandwidth	(20dB bandwidth)	2400-2483.5	PASS

Spectrum Parameter	Setting
Attenuation	Auto
Span Frequency	> Measurement Bandwidth or Channel Separation
RB	100KHz
VB	≥RBW
Detector	Peak
Trace	Max Hold
Sweep Time	Auto

##### 4.1.1 TEST PROCEDURE

- a. The EUT was directly connected to the spectrum analyzer and antenna output port as show in the block diagram below,
- b. Spectrum Setting : RBW= 100KHz, VBW≥ RBW, Sweep time = Auto.

##### 4.1.2 DEVIATION FROM STANDARD

No deviation.

##### 4.1.3 TEST SETUP

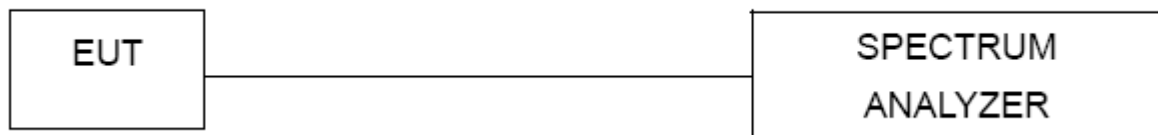

##### 4.1.4 EUT OPERATION CONDITIONS

The EUT tested system was configured as the statements of 2.4 Unless otherwise a special operating condition is specified in the follows during the testing.



**4.1.5 TEST RESULTS**

Temperature :	25 °C	Relative Humidity :	54%
Pressure :	1012 hPa	Test Voltage :	DC 3.7V From Battery
Test Mode :	CH01 / CH20 /CH40		

	Frequency	20dB Bandwidth (MHz)	Result
GFSK	2402 MHz	1.175	<b>PASS</b>
	2440 MHz	1.169	<b>PASS</b>
	2480 MHz	1.174	<b>PASS</b>

GFSK

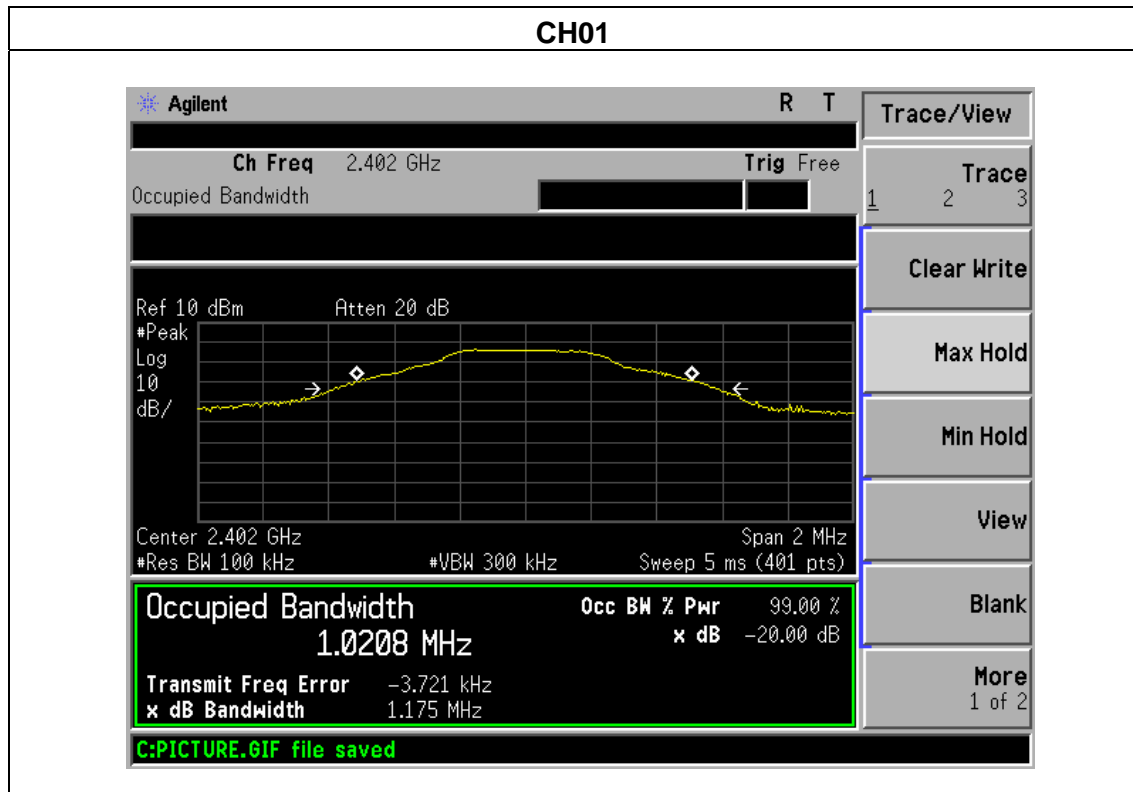

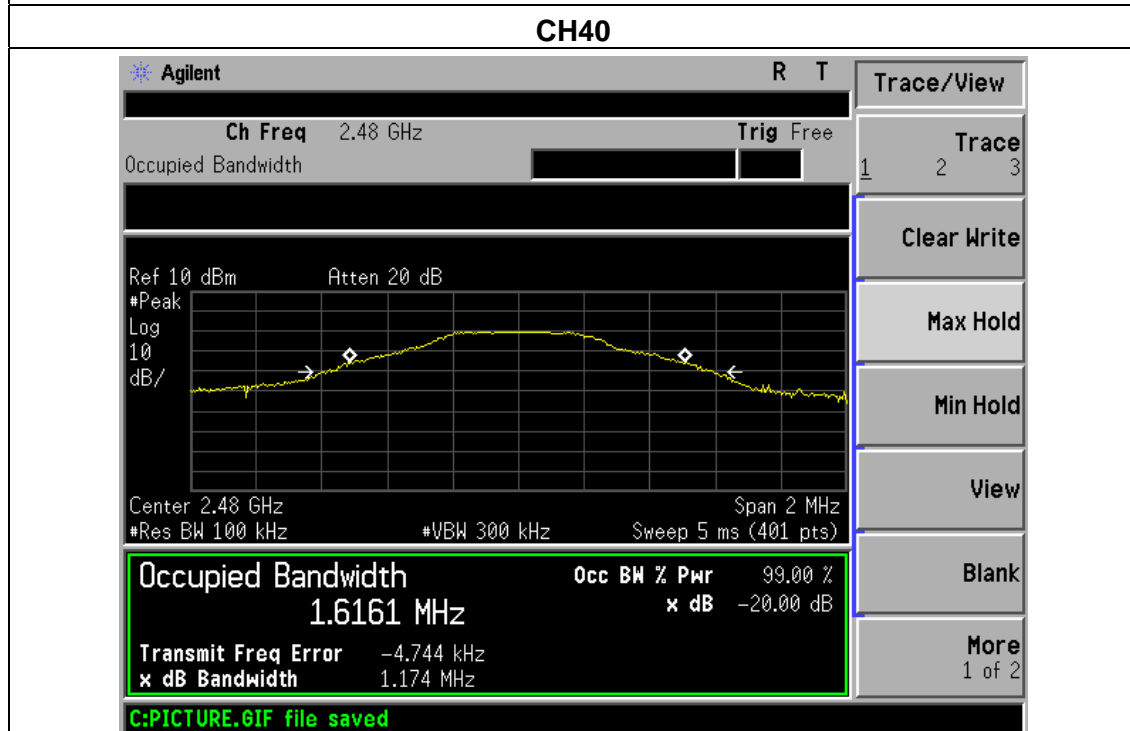
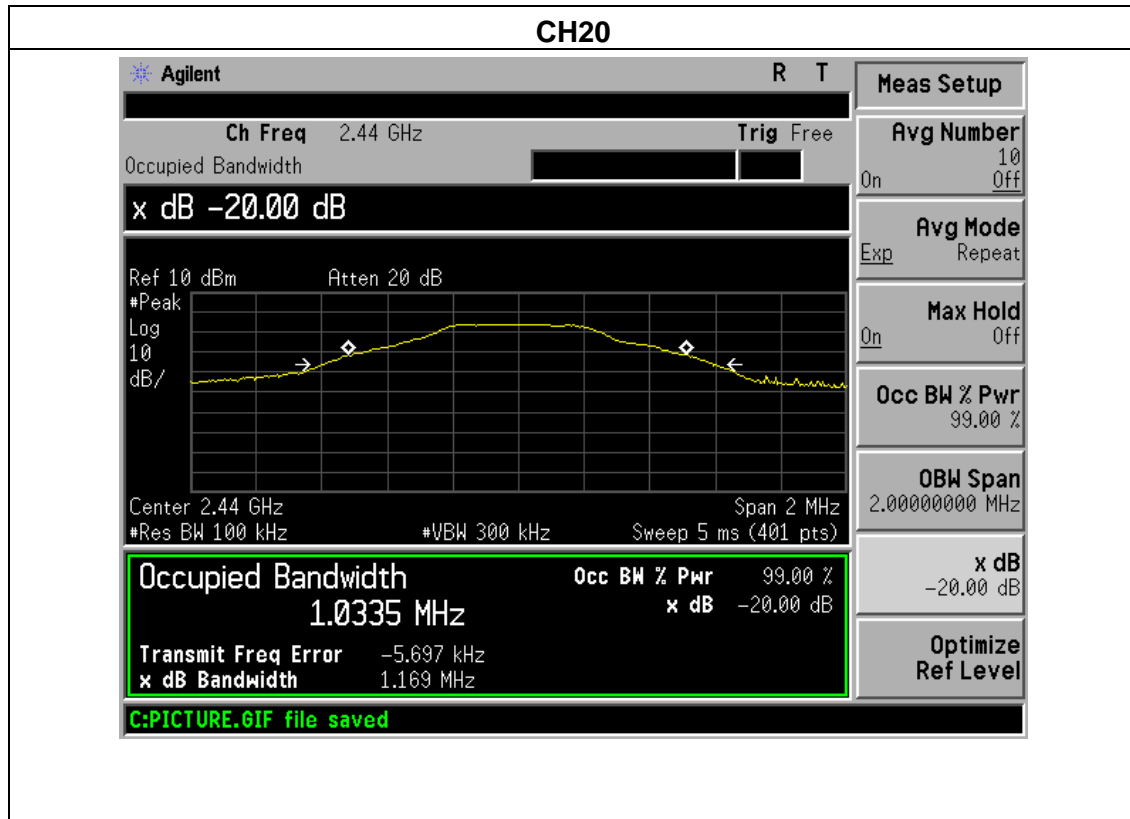





## 5. BAND EDGE EMISSION

Emissions radiated outside of the specified frequency bands, except for harmonics, shall be attenuated by at least 50 dB below the level of the fundamental or to the general radiated emission limits in §15.209, whichever is the lesser attenuation.

### TEST PROCEDURE

- a. The measuring distance of at 3 m shall be used for measurements at frequency up to 25GHz. For frequencies above 1GHz, any suitable measuring distance may be used.
- b. The EUT was placed on the top of a rotating table 1.5 meters above the ground at a 3 meter open area test site. The table was rotated 360 degrees to determine the position of the highest radiation.
- c. The height of the equipment or of the substitution antenna shall be 1.5 m; the height of the test antenna shall vary between 1 m to 4 m. Both horizontal and vertical polarizations of the antenna are set to make the measurement.
- d. If the Peak Mode measured value compliance with and lower than Quasi Peak Mode Limit, the EUT shall be deemed to meet QP Limits and then no additional QP Mode measurement performed.
- e. For the actual test configuration, please refer to the related Item –EUT Test Photos.
- f. For the radiated emission test above 1GHz:  
Place the measurement antenna away from each area of the EUT determined to be a source of emissions at the specified measurement distance, while keeping the measurement antenna aimed at the source of emissions at each frequency of significant emissions, with polarization oriented for maximum response.  
The measurement antenna may have to be higher or lower than the EUT, depending on the radiation pattern of the emission and staying aimed at the emission source for receiving the maximum signal. The final measurement antenna elevation shall be that which maximizes the emissions. The measurement antenna elevation for maximum emissions shall be restricted to a range of heights of from 1 m to 4 m above the ground or reference ground plane.
- g Spectrum Setting : RBW= 1MHz, VBW=3MHz, Sweep time = Auto for peak  
RBW= 1MHz, VBW=10Hz, Sweep time = Auto for average

Note:

Both horizontal and vertical antenna polarities were tested and performed pretest to three orthogonal axis. The worst case emissions were reported

### 5.1 DEVIATION FROM STANDARD

No deviation.

### 5.2 EUT OPERATION CONDITIONS

The EUT tested system was configured as the statements of 2.4 Unless otherwise a special operating condition is specified in the follows during the testing.



### 5.3 TEST RESULTS

Temperature :	25 °C	Relative Humidity :	54%
Pressure :	1012 hPa	Test Voltage :	DC 3.7V From Battery
Test Mode :	CH01/CH40		

Polar (H/V)	Frequency (MHz)	Meter Reading (dBuV)	Pre-amplifier (dB)	Cable Loss (dB)	Antenna Factor (dB/m)	Emission evel (dBuV/m)	Limits (dBuV/m)		Result
						PK	PK	AV	
<b>Low Channel 2402MHz</b>									
H	2370.00	60.56	38.06	7.42	20.15	50.07	74.00	54.00	PASS
H	2390.00	59.25	38.06	7.42	20.15	48.76	74.00	54.00	PASS
H	2400.00	59.33	38.06	7.42	20.15	48.84	74.00	54.00	PASS
V	2338.00	58.41	38.06	7.42	20.15	47.92	74.00	54.00	PASS
V	2390.00	59.79	38.06	7.42	20.15	49.30	74.00	54.00	PASS
V	2400.00	59.28	38.06	7.42	20.15	48.79	74.00	54.00	PASS
<b>High Channel 2480MHz</b>									
H	2483.50	58.33	38.17	7.42	20.51	48.09	74.00	54.00	PASS
H	2483.50	59.15	38.17	7.42	20.51	48.91	74.00	54.00	PASS
V	2500.00	58.29	38.2	7.45	20.54	48.08	74.00	54.00	PASS
V	2500.00	57.79	38.2	7.45	20.54	47.58	74.00	54.00	PASS

**Remark:**

1. Emission Level = Meter Reading + Antenna Factor + Cable Loss – Pre-amplifier, Margin= Emission Level - Limit
2. If the PK measured levels comply with average limit, then the average level were deemed to comply with average limit.



### 2402MHz Horizontal

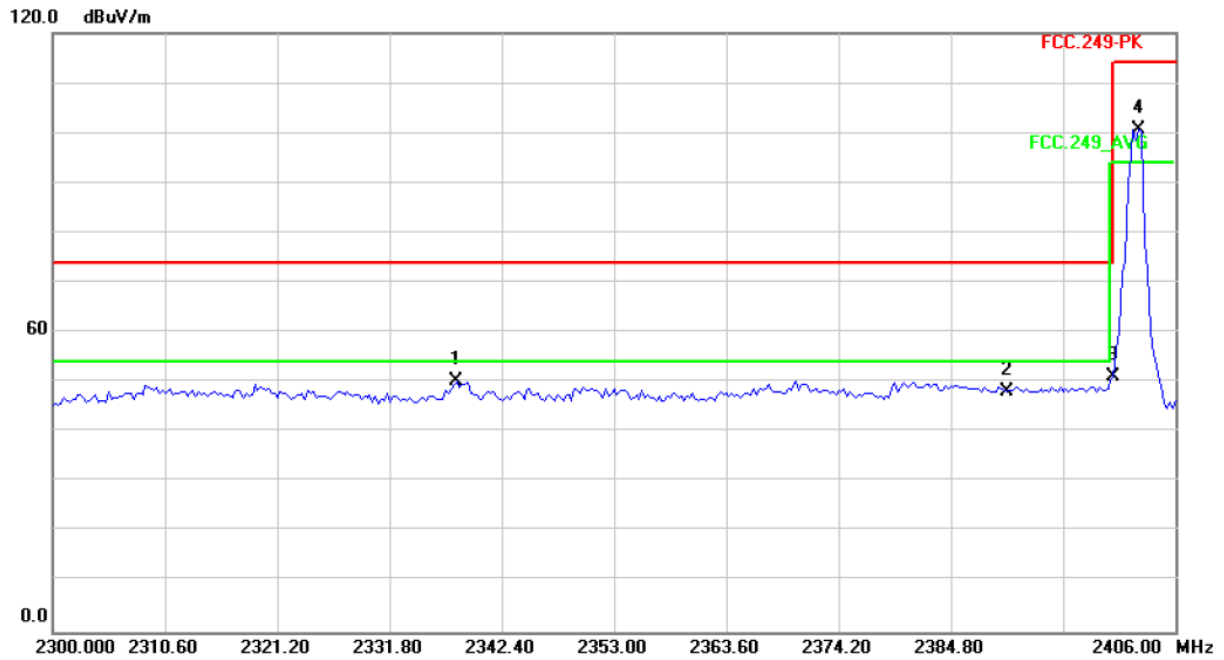

### 2402MHz Vertical

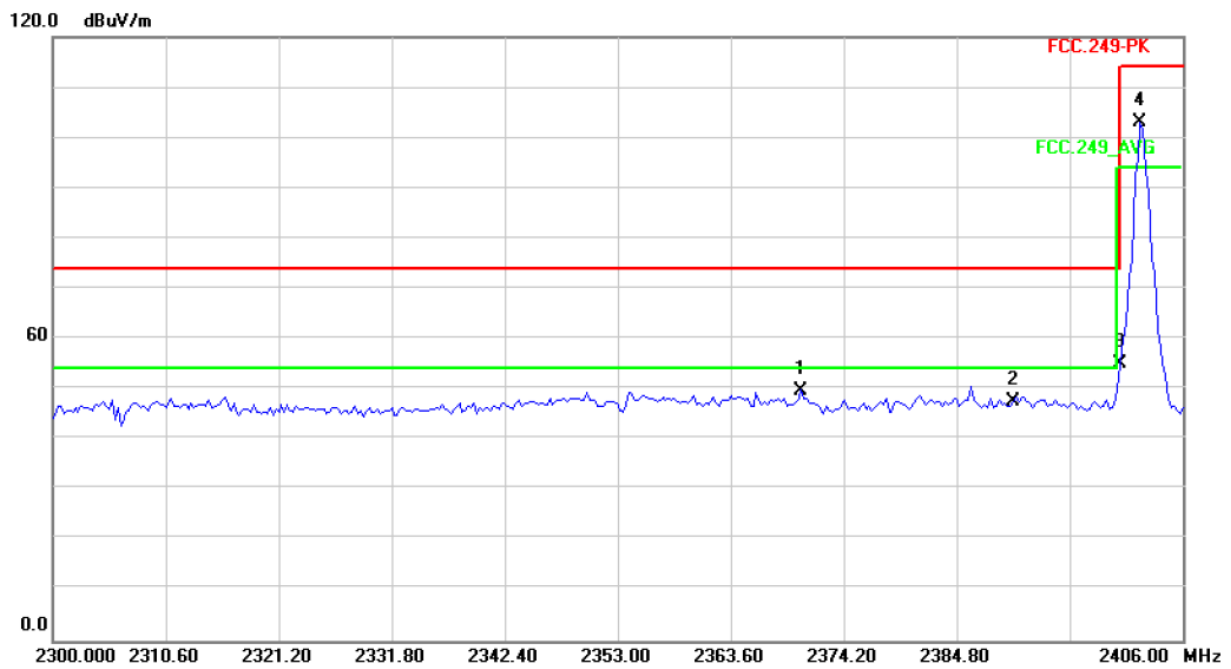



### 2480MHz Horizontal

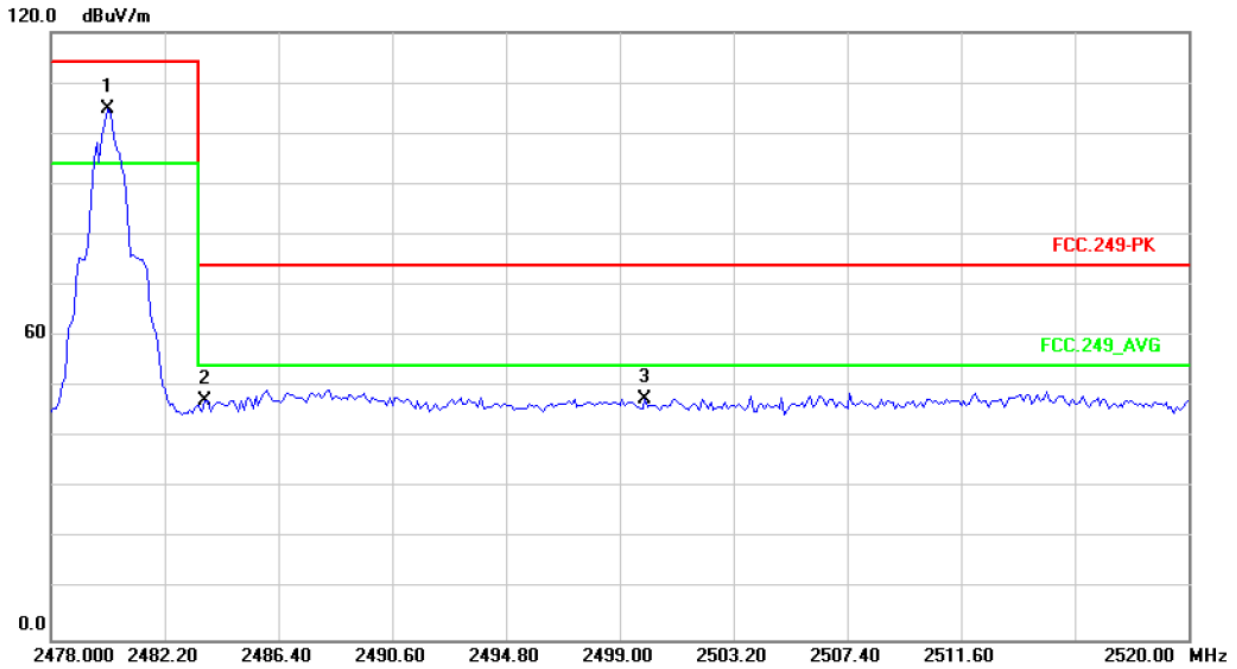

### 2480MHz Vertical

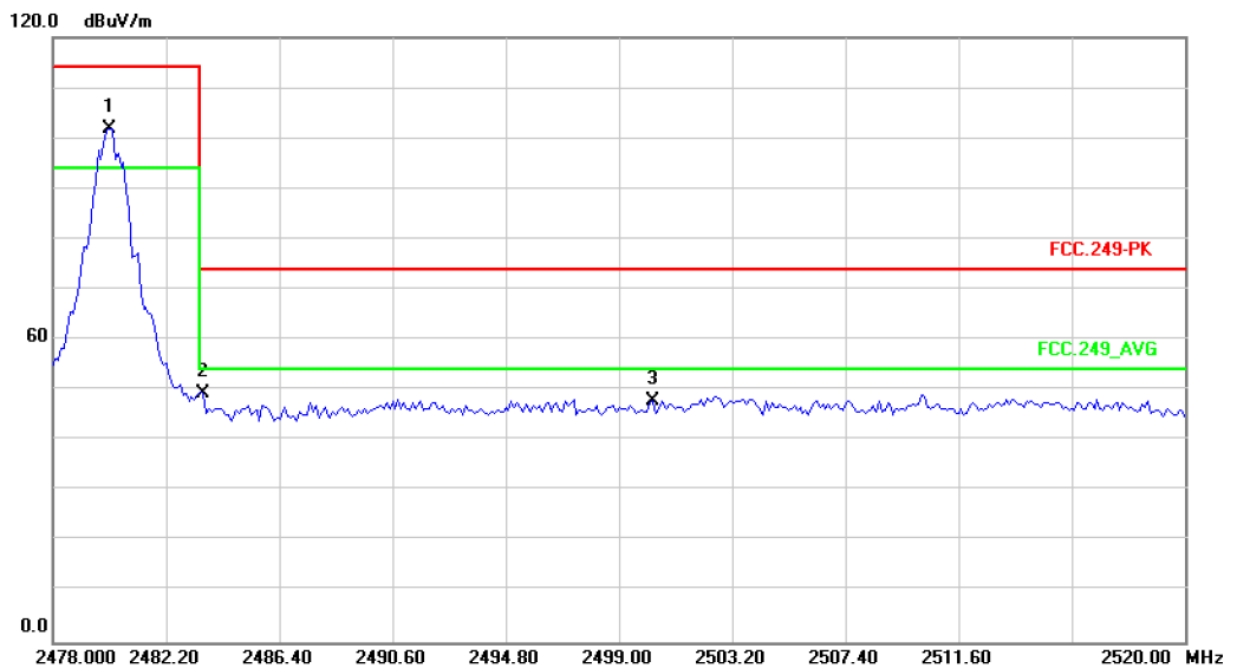



## **6. ANTENNA REQUIREMENT**

### **6.1 STANDARD REQUIREMENT**

15.203 requirement: For intentional device, according to 15.203: an intentional radiator shall be designed to ensure that no antenna other than that furnished by the responsible party shall be used with the device.

### **6.2 EUT ANTENNA**

The EUT antenna is Integral PCB antenna. It complies with the standard requirement.

## 7. EUT TEST PHOTO

**conducted Emission**





### Radiated Measurement Photos





## 8. PHOTOS OF THE EUT

