

APPLICATION CERTIFICATION FCC Part 15C
On Behalf of
Shenzhen Kinlan Technology Company Limited

True Wireless Earbuds
Model No.: BE1018, IAEBTW59B

FCC ID: 2AE3CBE1018

Prepared for : Shenzhen Kinlan Technology Company Limited
Address : West of 3F, Building A4, Yinlong Industrial Park, No.292 Shenshan Road, Longgang District, Shenzhen, Guangdong, China

Prepared by : Shenzhen Accurate Technology Co., Ltd.
Address : 1/F., Building A, Changyuan New Material Port, Science & Industry Park, Nanshan District, Shenzhen, Guangdong, P.R. China

Tel: (0755) 26503290
Fax: (0755) 26503396

Report No. : ATE20181915
Date of Test : November 2-7, 2018
Date of Report : November 9, 2018

TABLE OF CONTENTS

Description	Page
Test Report Certification	
TABLE OF CONTENTS	2
1. GENERAL INFORMATION	5
1.1. Description of Device (EUT).....	5
1.2. Accessory and Auxiliary Equipment	5
1.3. Description of Test Facility	6
1.4. Measurement Uncertainty	6
2. MEASURING DEVICE AND TEST EQUIPMENT	7
3. OPERATION OF EUT DURING TESTING	8
3.1. Operating Mode	8
3.2. Configuration and peripherals	8
4. TEST PROCEDURES AND RESULTS	9
5. 20DB BANDWIDTH TEST	10
5.1. Block Diagram of Test Setup.....	10
5.2. The Requirement For Section 15.247(a)(1).....	10
5.3. EUT Configuration on Measurement	10
5.4. Operating Condition of EUT	10
5.5. Test Procedure	10
5.6. Test Result	11
6. CARRIER FREQUENCY SEPARATION TEST	16
6.1. Block Diagram of Test Setup.....	16
6.2. The Requirement For Section 15.247(a)(1).....	16
6.3. EUT Configuration on Measurement	16
6.4. Operating Condition of EUT	16
6.5. Test Procedure	17
6.6. Test Result	17
7. NUMBER OF HOPPING FREQUENCY TEST	23
7.1. Block Diagram of Test Setup.....	23
7.2. The Requirement For Section 15.247(a)(1)(iii).....	23
7.3. EUT Configuration on Measurement	23
7.4. Operating Condition of EUT	23
7.5. Test Procedure	23
7.6. Test Result	24
8. DWELL TIME TEST	26
8.1. Block Diagram of Test Setup.....	26
8.2. The Requirement For Section 15.247(a)(1)(iii).....	26
8.3. EUT Configuration on Measurement	26
8.4. Operating Condition of EUT	26
8.5. Test Procedure	26
8.6. Test Result	27
9. MAXIMUM PEAK OUTPUT POWER TEST	33
9.1. Block Diagram of Test Setup.....	33

- 9.2. The Requirement For Section 15.247(b)(1)..... 33
- 9.3. EUT Configuration on Measurement 33
- 9.4. Operating Condition of EUT 33
- 9.5. Test Procedure 33
- 9.6. Test Result 34
- 10. RADIATED EMISSION TEST 40**
- 10.1. Block Diagram of Test Setup..... 40
- 10.2. The Limit For Section 15.247(d) 41
- 10.3. Restricted bands of operation 42
- 10.4. Configuration of EUT on Measurement 42
- 10.5. Operating Condition of EUT 43
- 10.6. Test Procedure 43
- 10.7. Data Sample..... 44
- 10.8. The Field Strength of Radiation Emission Measurement Results 44
- 11. BAND EDGE COMPLIANCE TEST 57**
- 11.1. Block Diagram of Test Setup..... 57
- 11.2. The Requirement For Section 15.247(d) 57
- 11.3. EUT Configuration on Measurement 57
- 11.4. Operating Condition of EUT 57
- 11.5. Test Procedure 58
- 11.6. Test Result 58
- 12. AC POWER LINE CONDUCTED EMISSION FOR FCC PART 15 SECTION 15.207(A) .. 69**
- 12.1. Block Diagram of Test Setup..... 69
- 12.2. Power Line Conducted Emission Measurement Limits..... 70
- 12.3. Configuration of EUT on Measurement 70
- 12.4. Operating Condition of EUT 70
- 12.5. Test Procedure 70
- 12.6. Data Sample..... 71
- 12.7. Power Line Conducted Emission Measurement Results 71
- 13. ANTENNA REQUIREMENT..... 74**
- 13.1. The Requirement 74
- 13.2. Antenna Construction 74

Test Report Certification

Applicant : Shenzhen Kinlan Technology Company Limited
Manufacturer : Shenzhen Kinlan Technology Company Limited
EUT Description : True Wireless Earbuds
Model No. : BE1018, IAEBTW59B
Brand Name : n.a.

Measurement Procedure Used:

**FCC Rules and Regulations Part 15 Subpart C Section 15.247: 2018
ANSI C63.10: 2013**

The device described above is tested by Shenzhen Accurate Technology Co., Ltd. to determine the maximum emission levels emanating from the device. The maximum emission levels are compared to the FCC Part 15 Subpart C Section 15.247 limits. The measurement results are contained in this test report and Shenzhen Accurate Technology Co., Ltd. is assumed full responsibility for the accuracy and completeness of these measurements. Also, this report shows that the Equipment Under Test (EUT) is to be technically compliant with the FCC requirements.

This report applies to above tested sample only. This report shall not be reproduced in part without written approval of Shenzhen Accurate Technology Co., Ltd.

Date of Test : November 2-7, 2018
Date of Report : November 9, 2018

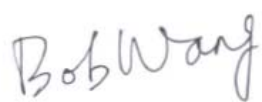
Test Engineer : 
(Bob Wang, Engineer)

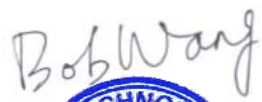
Prepared by : 
(Bob Wang, Engineer)

Approved & Authorized Signer : 
(Sean Liu, Manager)



1. GENERAL INFORMATION

1.1. Description of Device (EUT)

Model Number	: BE1018, IAEBTW59B (Note: These samples are same except their appearance color is different. So we prepare BE1018 for test only.)
Bluetooth version	: V 5.0
Frequency Range	: 2402MHz-2480MHz
Number of Channels	: 79
Antenna Gain(Max)	: -1dBi
Antenna type	: Integral Antenna
Adapter Input Voltage	: DC 3.7V (Powered by Lithium battery) or DC 5V (Powered by USB port)
Modulation mode	: GFSK, $\pi/4$ DQPSK, 8DPSK
Hardware version	: V1.0
Software version	: V1.0
Applicant	: Shenzhen Kinlan Technology Company Limited
Address	: West of 3F, Building A4, Yinlong Industrial Park, No.292 Shenshan Road, Longgang District, Shenzhen, Guangdong, China
Manufacturer	: Shenzhen Kinlan Technology Company Limited
Address	: West of 3F, Building A4, Yinlong Industrial Park, No.292 Shenshan Road, Longgang District, Shenzhen, Guangdong, China

1.2. Accessory and Auxiliary Equipment

Adapter:	Model:BEK-QC-001 INPUT: 120V~60Hz OUTPUT:5V/1A
----------	--

1.3. Description of Test Facility

EMC Lab	:	Recognition of accreditation by Federal Communications Commission (FCC) The Designation Number is CN1189 The Registration Number is 708358
		Listed by Innovation, Science and Economic Development Canada (ISED) The Registration Number is 5077A-2
		Accredited by China National Accreditation Service for Conformity Assessment (CNAS) The Registration Number is CNAS L3193
		Accredited by American Association for Laboratory Accreditation (A2LA) The Certificate Number is 4297.01
Name of Firm	:	Shenzhen Accurate Technology Co., Ltd.
Site Location	:	1/F., Building A, Changyuan New Material Port, Science & Industry Park, Nanshan District, Shenzhen, Guangdong, P.R. China

1.4. Measurement Uncertainty

Conducted Emission Expanded Uncertainty	=	2.23dB, k=2
Radiated emission expanded uncertainty (9kHz-30MHz)	=	3.08dB, k=2
Radiated emission expanded uncertainty (30MHz-1000MHz)	=	4.42dB, k=2
Radiated emission expanded uncertainty (Above 1GHz)	=	4.06dB, k=2

2. MEASURING DEVICE AND TEST EQUIPMENT

Table 1: List of Test and Measurement Equipment

Kind of equipment	Manufacturer	Type	S/N	Calibrated dates	Calibrated until
EMI Test Receiver	Rohde&Schwarz	ESCS30	100307	Jan. 06, 2018	1 Year
EMI Test Receiver	Rohde&Schwarz	ESPI3	101526/003	Jan. 06, 2018	1 Year
Spectrum Analyzer	Agilent	E7405A	MY45115511	Jan. 06, 2018	1 Year
Pre-Amplifier	Rohde&Schwarz	CBLU1183540-01	3791	Jan. 06, 2018	1 Year
Loop Antenna	Schwarzbeck	FMZB1516	1516131	Jan. 06, 2018	1 Year
Bilog Antenna	Schwarzbeck	VULB9163	9163-323	Jan. 06, 2018	1 Year
Horn Antenna	Schwarzbeck	BBHA9120D	9120D-655	Jan. 06, 2018	1 Year
Horn Antenna	Schwarzbeck	BBHA9170	9170-359	Jan. 06, 2018	1 Year
LISN	Rohde&Schwarz	ESH3-Z5	100305	Jan. 06, 2018	1 Year
LISN	Schwarzbeck	NSLK8126	8126431	Jan. 06, 2018	1 Year
Highpass Filter	Wainwright Instruments	WHKX3.6/18G-10SS	N/A	Jan. 06, 2018	1 Year
Band Reject Filter	Wainwright Instruments	WRCG2400/2485-2375/2510-60/11SS	N/A	Jan. 06, 2018	1 Year
RF COAXIAL CABLE	SUHNER	N-5m(Frequency range:9KHz-26.5GHz)	NO.3	Jan. 06, 2018	1 Year
RF COAXIAL CABLE	SUHNER	N-5m(Frequency range:9KHz-26.5GHz)	NO.4	Jan. 06, 2018	1 Year
RF COAXIAL CABLE	SUHNER	N-1m(Frequency range:9KHz-26.5GHz)	NO.5	Jan. 06, 2018	1 Year
RF COAXIAL CABLE	SUHNER	N-1m(Frequency range:9KHz-26.5GHz)	NO.6	Jan. 06, 2018	1 Year
Temporary antenna connector	NTGS	14AE	N/A	March 21, 2018	N/A

Note: The temporary antenna connector is soldered on the PCB board in order to perform conducted tests and this temporary antenna connector is listed in the equipment list.

3. OPERATION OF EUT DURING TESTING

3.1. Operating Mode

The mode is used: Transmitting mode

Low Channel: 2402MHz

Middle Channel: 2441MHz

High Channel: 2480MHz

Hopping

Note: The equipment under test (EUT) was tested under fully-charged battery.
The Bluetooth has been tested under continuous transmission mode.

3.2. Configuration and peripherals

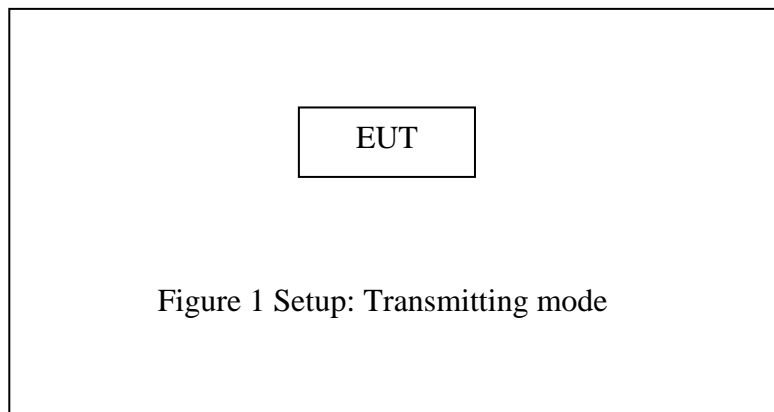

4. TEST PROCEDURES AND RESULTS

FCC Rules	Description of Test	Result
Section 15.207	Conducted Emission Test	Compliant
Section 15.247(a)(1)	20dB Bandwidth Test	Compliant
Section 15.247(a)(1)	Carrier Frequency Separation Test	Compliant
Section 15.247(a)(1)(iii)	Number Of Hopping Frequency Test	Compliant
Section 15.247(a)(1)(iii)	Dwell Time Test	Compliant
Section 15.247(b)(1)	Maximum Peak Output Power Test	Compliant
Section 15.247(d) Section 15.209	Radiated Emission Test	Compliant
Section 15.247(d)	Band Edge Compliance Test	Compliant
Section 15.203	Antenna Requirement	Compliant

5. 20DB BANDWIDTH TEST

5.1. Block Diagram of Test Setup

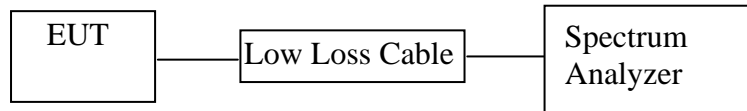

(EUT: True Wireless Earbuds)

5.2. The Requirement For Section 15.247(a)(1)

Section 15.247(a)(1): Frequency hopping systems shall have hopping channel carrier frequencies separated by a minimum of 25 kHz or the 20 dB bandwidth of the hopping channel, whichever is greater.

5.3. EUT Configuration on Measurement

The equipment are installed on the emission measurement to meet the commission requirements and operating regulations in a manner which tends to maximize its emission characteristics in normal application.

5.4. Operating Condition of EUT

5.4.1. Setup the EUT and simulator as shown as Section 5.1.

5.4.2. Turn on the power of all equipment.

5.4.3. Let the EUT work in TX (Hopping off) modes measure it. The transmit frequency are 2402-2480MHz. We select 2402MHz, 2441MHz, and 2480MHz TX frequency to transmit.

5.5. Test Procedure

5.5.1. The transmitter output was connected to the spectrum analyzer through a low loss cable.

5.5.2. Set RBW of spectrum analyzer to 100 kHz and VBW to 300 kHz.

5.5.3. The 20dB bandwidth is defined as the total spectrum the power of which is higher than peak power minus 20dB.

5.6. Test Result

Test Lab: Shielding room
Test Engineer: Bob

Channel	Frequency (MHz)	GFSK 20dB Bandwidth (MHz)	$\Pi/4$ -DQPSK 20dB Bandwidth (MHz)	8DPSK 20dB Bandwidth (MHz)	Result
Low	2402	1.11	1.374	1.338	Pass
Middle	2441	1.11	1.368	1.338	Pass
High	2480	1.116	1.374	1.344	Pass

The spectrum analyzer plots are attached as below.

GFSK Mode

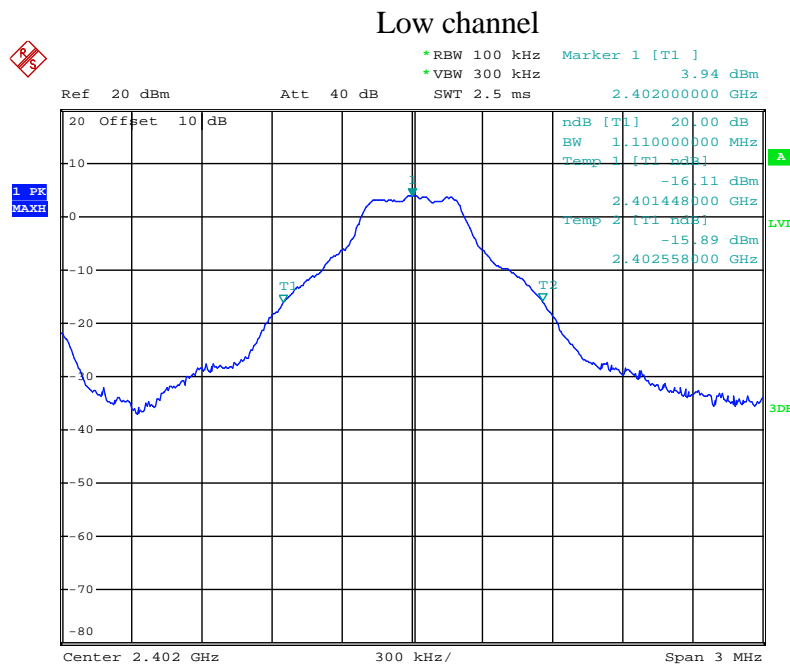

Date: 7.NOV.2018 09:52:20

Middle channel

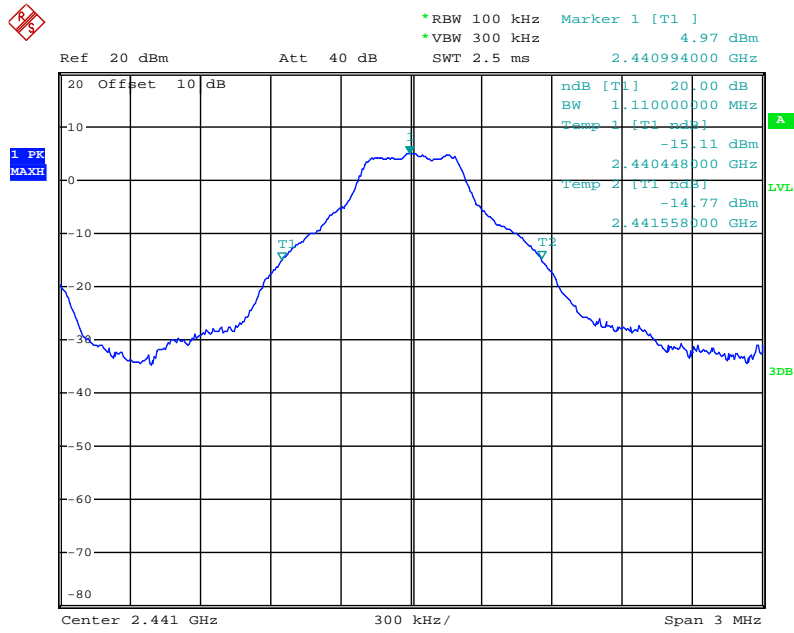

Date: 7.NOV.2018 09:51:44

High channel

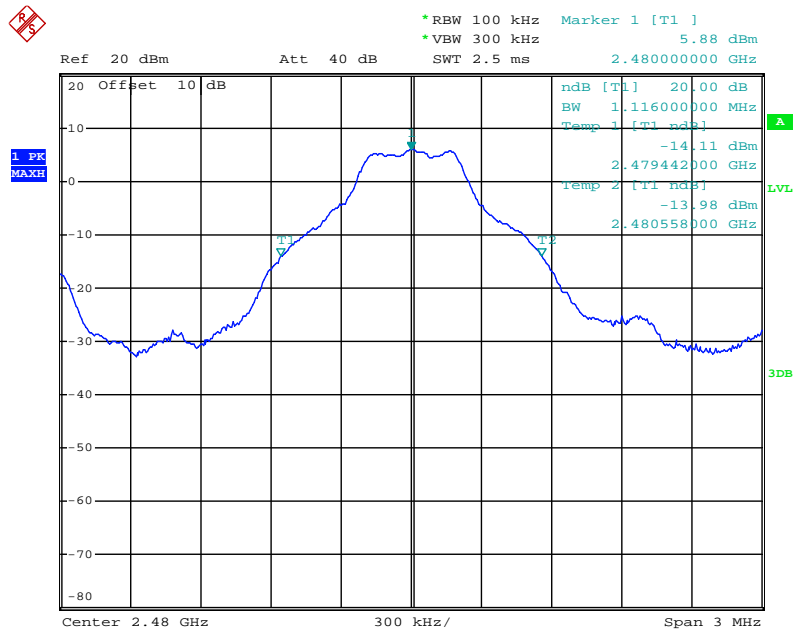

Date: 7.NOV.2018 09:51:13

Π/4-DQPSK Mode

Low channel

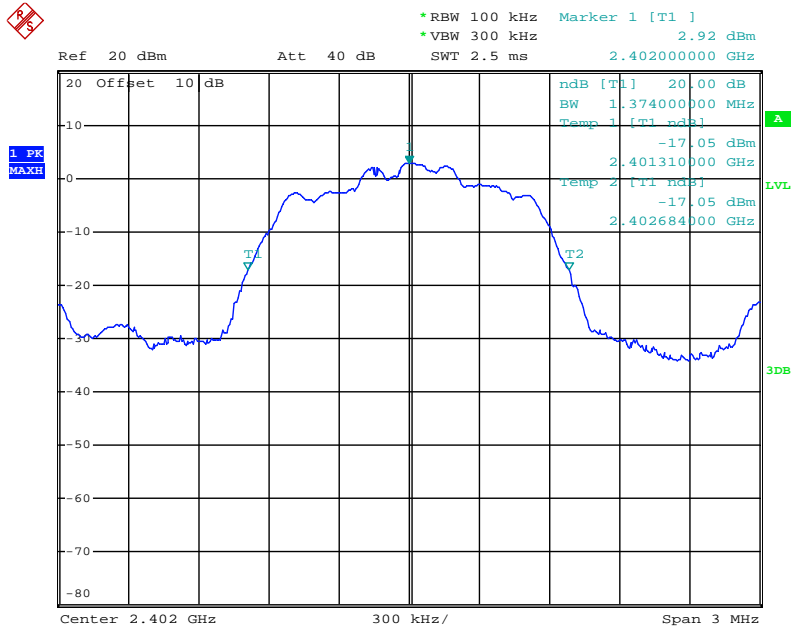

Date: 7.NOV.2018 09:49:27

Middle channel

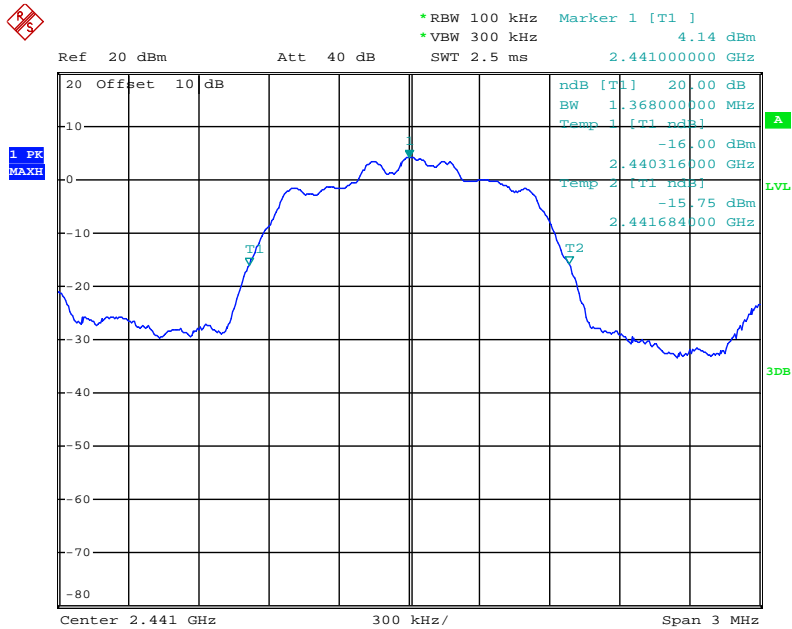

Date: 7.NOV.2018 09:50:02

High channel

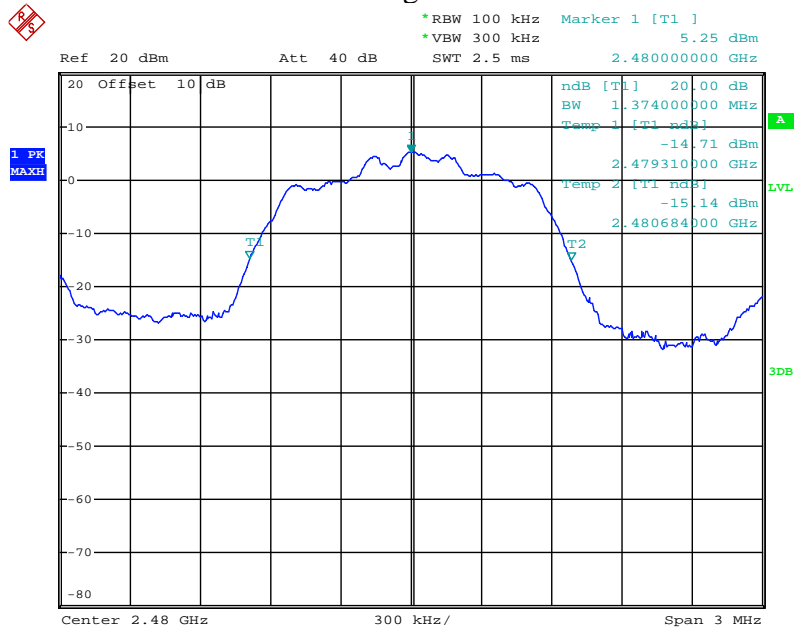

Date: 7.NOV.2018 09:50:31

8DPSK Mode

Low channel

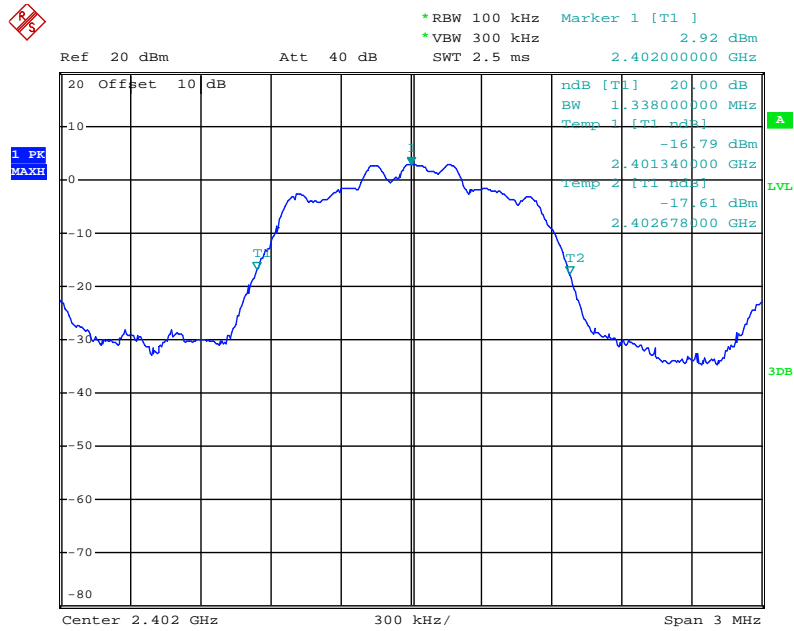

Date: 7.NOV.2018 09:48:46

Middle channel

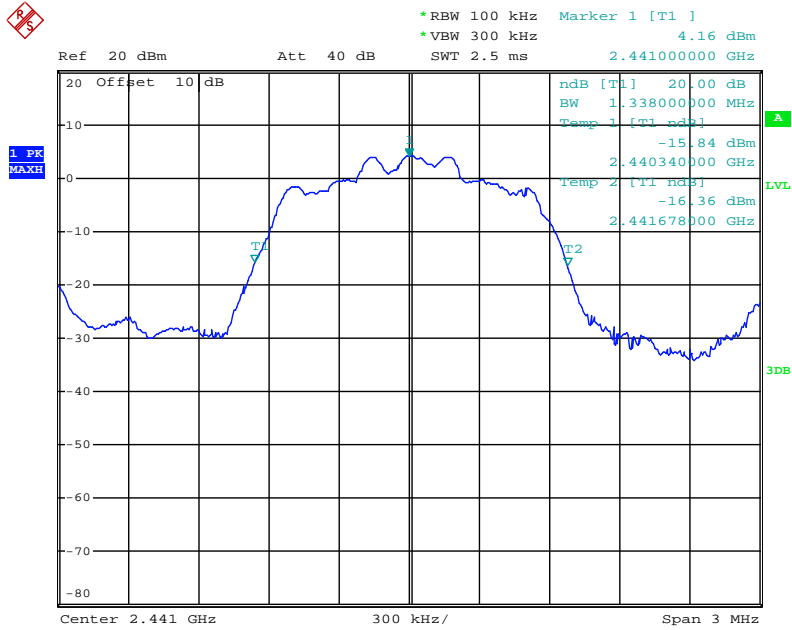

Date: 7.NOV.2018 09:48:09

High channel

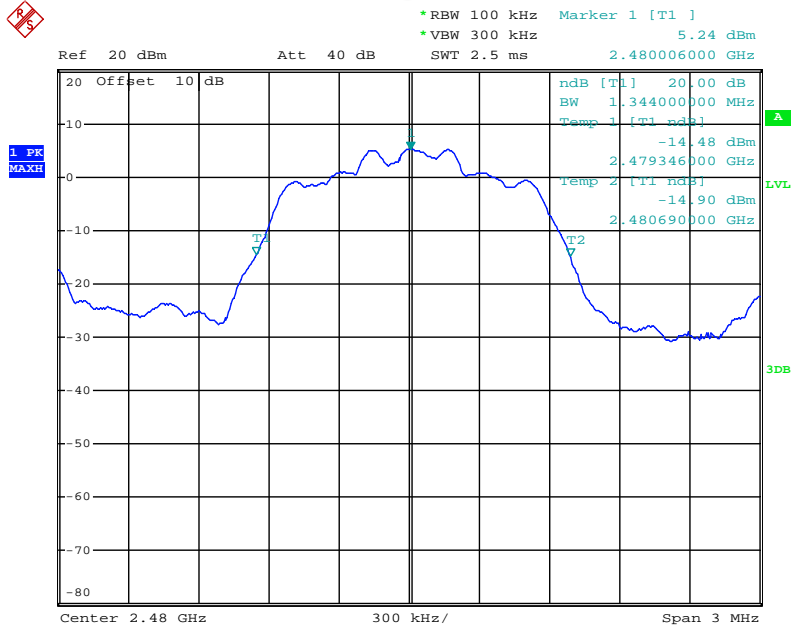

Date: 7.NOV.2018 09:47:38

6. CARRIER FREQUENCY SEPARATION TEST

6.1. Block Diagram of Test Setup

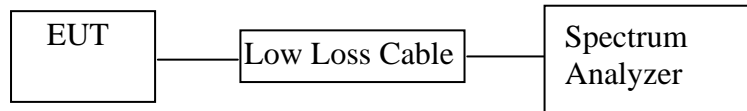

(EUT: True Wireless Earbuds)

6.2. The Requirement For Section 15.247(a)(1)

Section 15.247(a)(1): Frequency hopping systems shall have hopping channel carrier frequencies separated by a minimum of 25 kHz or the 20 dB bandwidth of the hopping channel, whichever is greater. Alternatively, frequency hopping systems operating in the 2400-2483.5 MHz band may have hopping channel carrier frequencies that are separated by 25 kHz or two-thirds of the 20 dB bandwidth of the hopping channel, whichever is greater, provided the systems operate with an output power no greater than 125 mW. The system shall hop to channel frequencies that are selected at the system hopping rate from a pseudorandomly ordered list of hopping frequencies. Each frequency must be used equally on the average by each transmitter. The system receivers shall have input bandwidths that match the hopping channel bandwidths of their corresponding transmitters and shall shift frequencies in synchronization with the transmitted signals.

6.3. EUT Configuration on Measurement

The equipment are installed on the emission measurement to meet the commission requirements and operating regulations in a manner which tends to maximize its emission characteristics in normal application.

6.4. Operating Condition of EUT

6.4.1. Setup the EUT and simulator as shown as Section 6.1.

6.4.2. Turn on the power of all equipment.

6.4.3. Let the EUT work in TX (Hopping on) modes measure it. The transmit frequency are 2402-2480MHz. We select 2402MHz, 2441MHz, and 2480MHz TX frequency to transmit.

6.5. Test Procedure

6.5.1. The transmitter output was connected to the spectrum analyzer through a low loss cable.

6.5.2. Set RBW of spectrum analyzer to 30 kHz and VBW to 100 kHz. Adjust Span to 2MHz.

6.5.3. Set the adjacent channel of the EUT Maxhold another trace.

6.5.4. Measurement the channel separation

6.6. Test Result

Test Lab: Shielding room

Test Engineer: Bob

GFSK

Channel	Frequency (MHz)	Channel Separation(MHz)	Limit (MHz)	Result
Low	2402	0.996	25KHz or 2/3*20dB bandwidth	PASS
	2403			
Middle	2440	1.002	25KHz or 2/3*20dB bandwidth	PASS
	2441			
High	2479	0.996	25KHz or 2/3*20dB bandwidth	PASS
	2480			

Π/4-DQPSK

Channel	Frequency (MHz)	Channel Separation(MHz)	Limit (MHz)	Result
Low	2402	1.002	25KHz or 2/3*20dB bandwidth	PASS
	2403			
Middle	2440	1.002	25KHz or 2/3*20dB bandwidth	PASS
	2441			
High	2479	0.996	25KHz or 2/3*20dB bandwidth	PASS
	2480			

8DPSK

Channel	Frequency (MHz)	Channel Separation(MHz)	Limit (MHz)	Result
Low	2402	1.002	25KHz or 2/3*20dB bandwidth	PASS
	2403			
Middle	2440	1.002	25KHz or 2/3*20dB bandwidth	PASS
	2441			
High	2479	1.002	25KHz or 2/3*20dB bandwidth	PASS
	2480			

GFSK Mode

Low channel

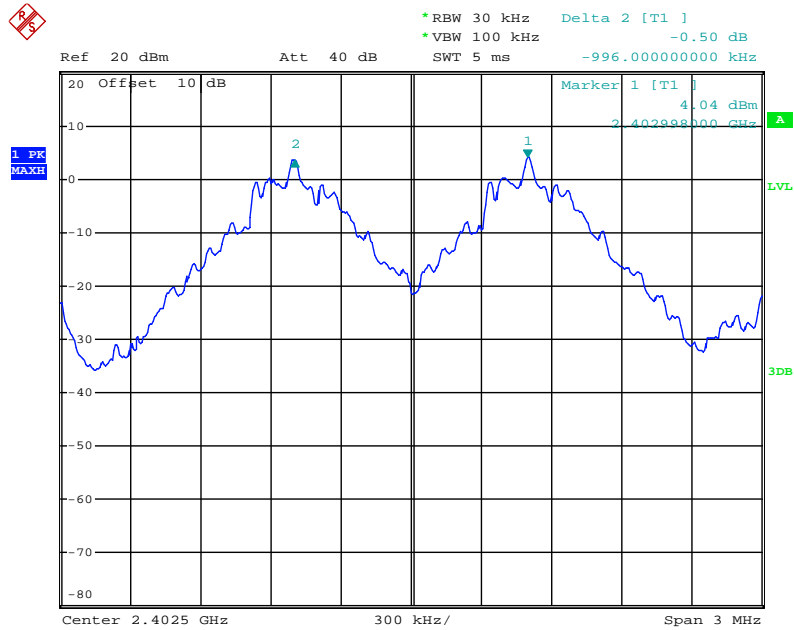

Date: 7.NOV.2018 10:39:03

Middle channel

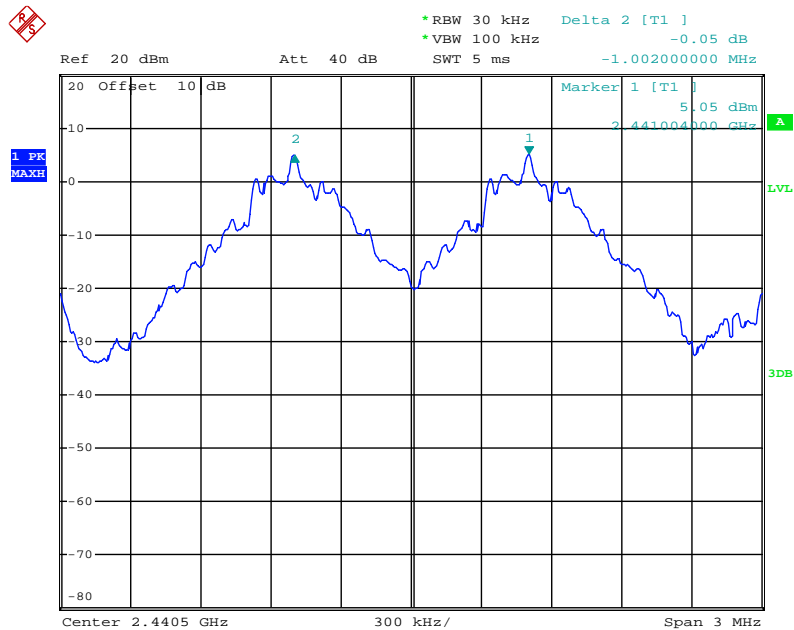

Date: 7.NOV.2018 10:39:37

High channel

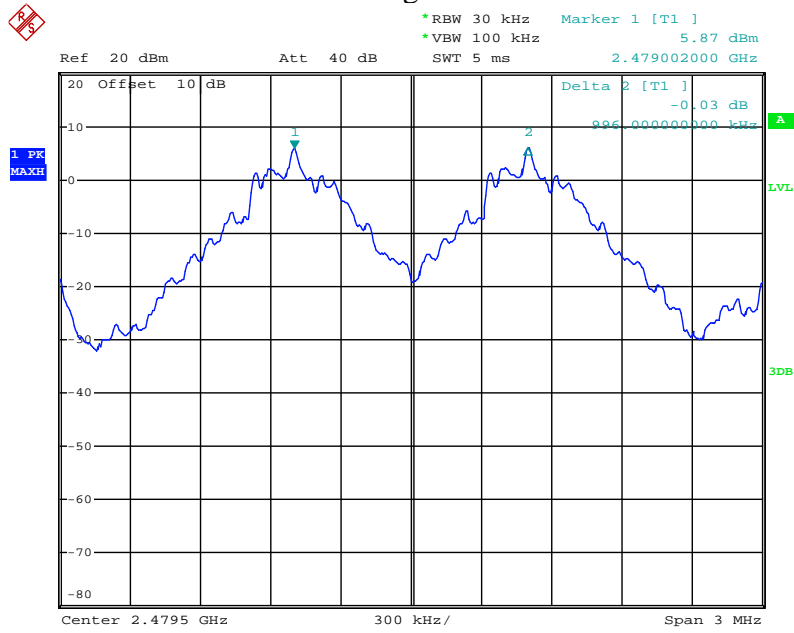

Date: 7.NOV.2018 10:40:10

Π/4-DQPSK Mode

Low channel

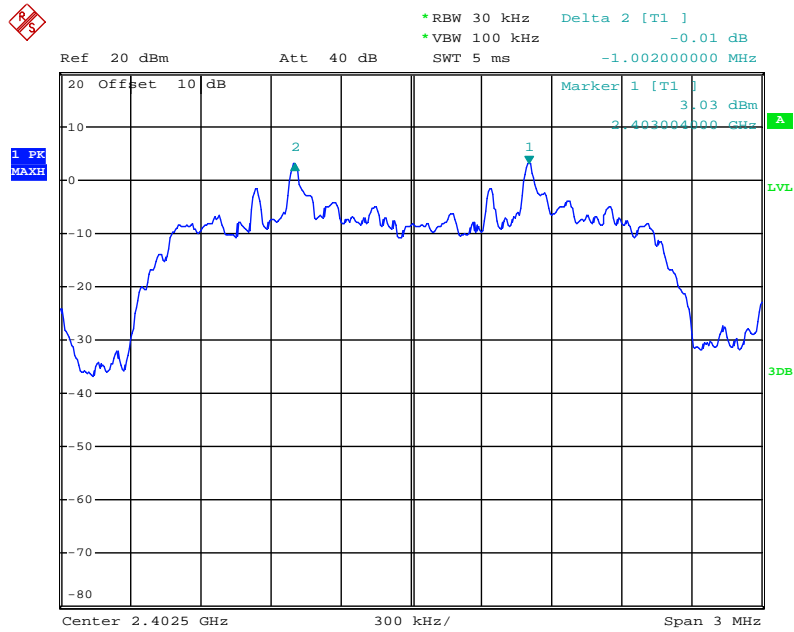

Date: 7.NOV.2018 10:42:20

Middle channel

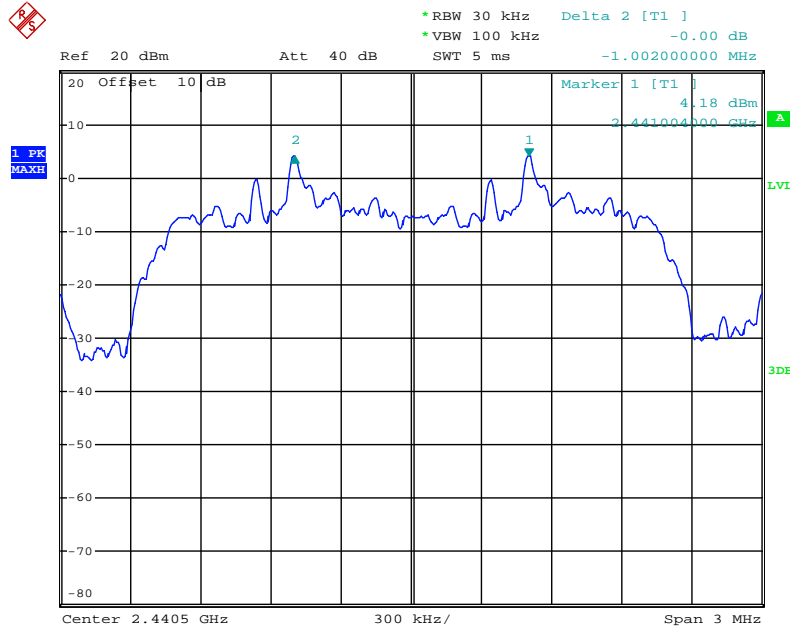

Date: 7.NOV.2018 10:41:33

High channel

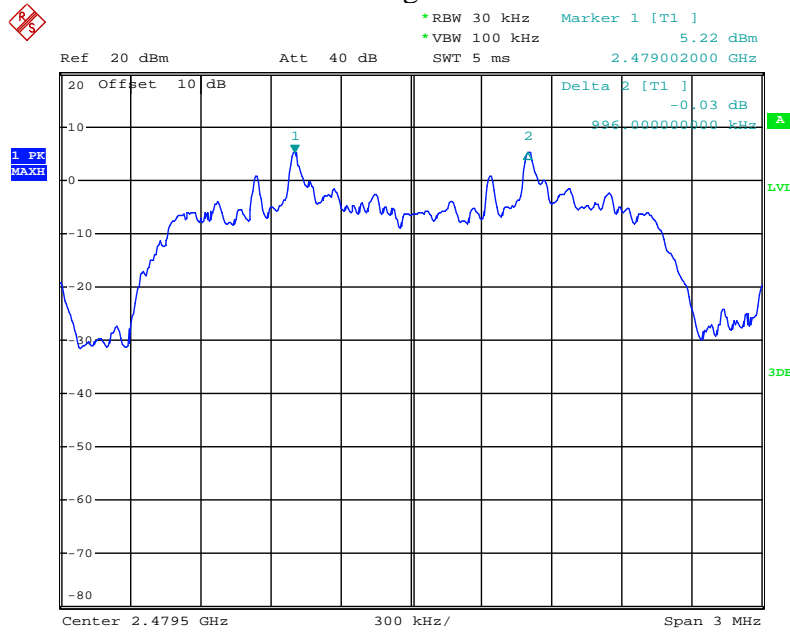

Date: 7.NOV.2018 10:40:54

8DPSK Mode

Low channel

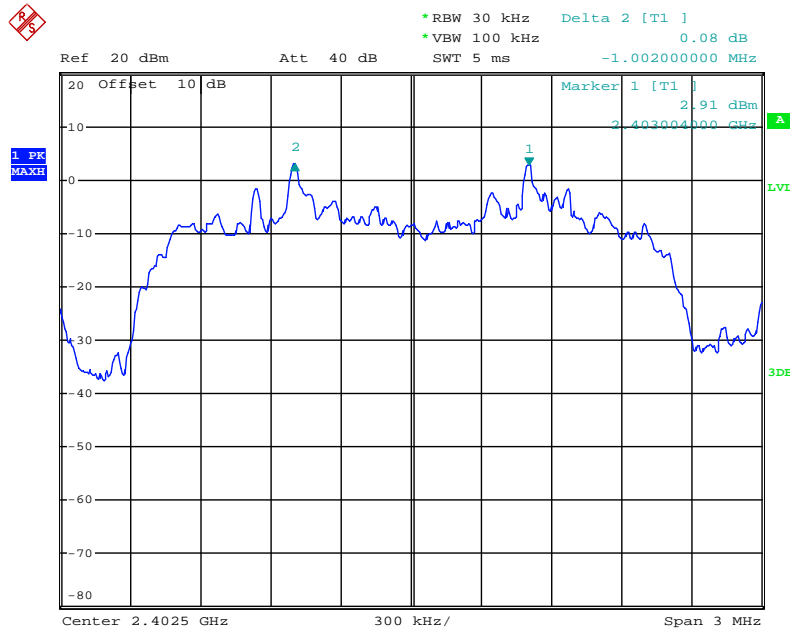

Date: 7.NOV.2018 10:42:53

Middle channel

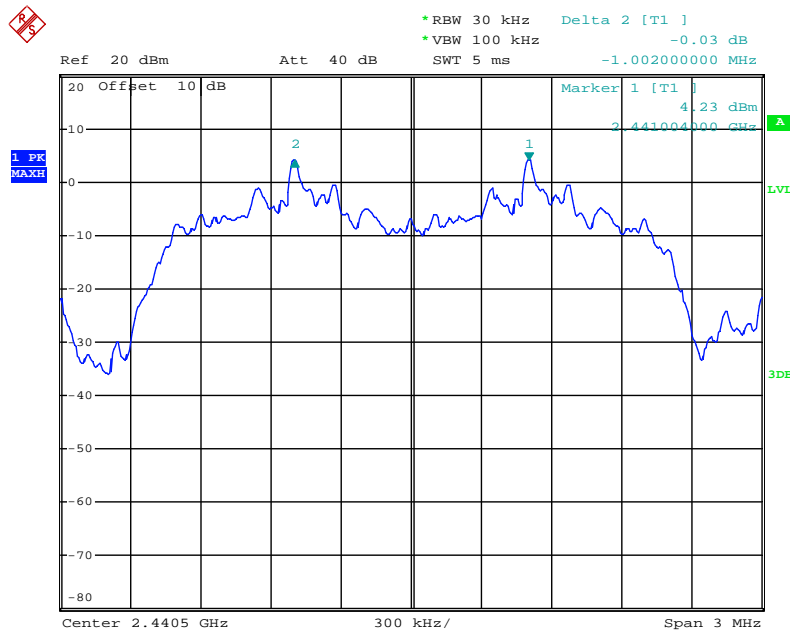

Date: 7.NOV.2018 10:43:27

High channel

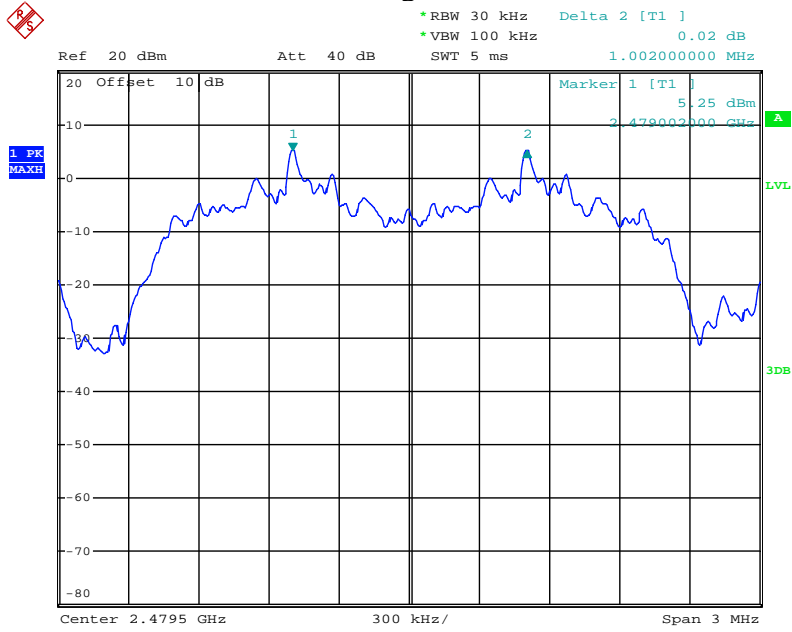

Date: 7.NOV.2018 10:44:01

7. NUMBER OF HOPPING FREQUENCY TEST

7.1. Block Diagram of Test Setup

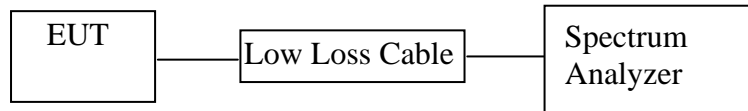

(EUT: True Wireless Earbuds)

7.2. The Requirement For Section 15.247(a)(1)(iii)

Section 15.247(a)(1)(iii): Frequency hopping systems in the 2400-2483.5 MHz band shall use at least 15 channels.

7.3. EUT Configuration on Measurement

The equipment are installed on the emission measurement to meet the commission requirements and operating regulations in a manner which tends to maximize its emission characteristics in normal application.

7.4. Operating Condition of EUT

7.4.1. Setup the EUT and simulator as shown as Section 7.1.

7.4.2. Turn on the power of all equipment.

7.4.3. Let the EUT work in TX (Hopping on) modes measure it.

7.5. Test Procedure

7.5.1. The transmitter output was connected to the spectrum analyzer through a low loss cable.

7.5.2. Set the spectrum analyzer as RBW=100 kHz, VBW=300 kHz.

7.5.3. Max hold, view and count how many channel in the band.

7.6. Test Result

Test Lab: Shielding room
Test Engineer: Bob

Total number of hopping channel	Measurement result(CH)	Limit(CH)
	79	≥ 15

Number of hopping channels(GFSK)

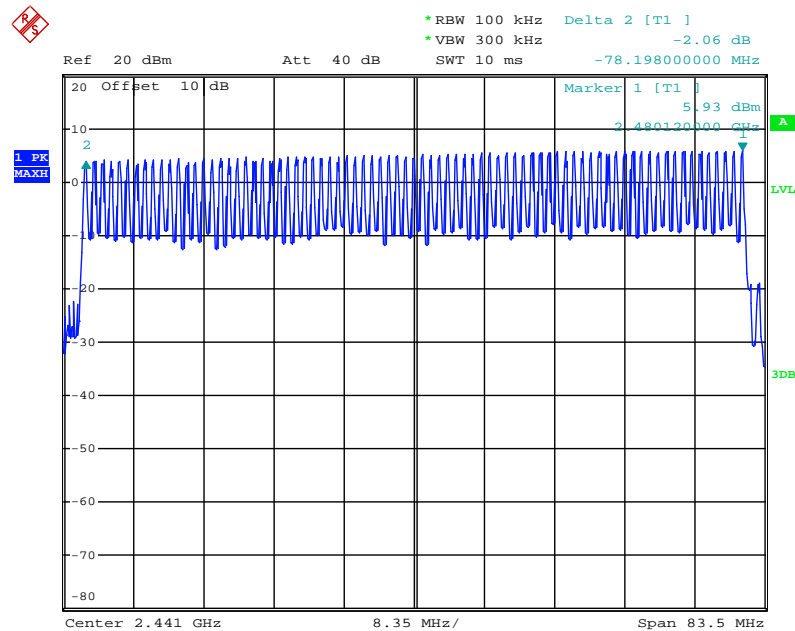

Date: 7.NOV.2018 10:21:40

Number of hopping channels($\Pi/4$ -DQPSK)

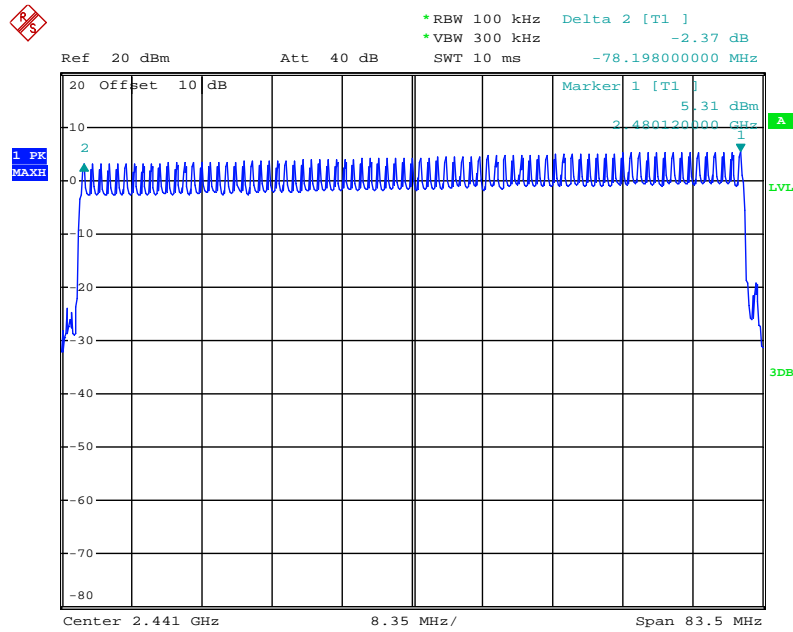

Date: 7.NOV.2018 10:18:05

Number of hopping channels(8DPSK)

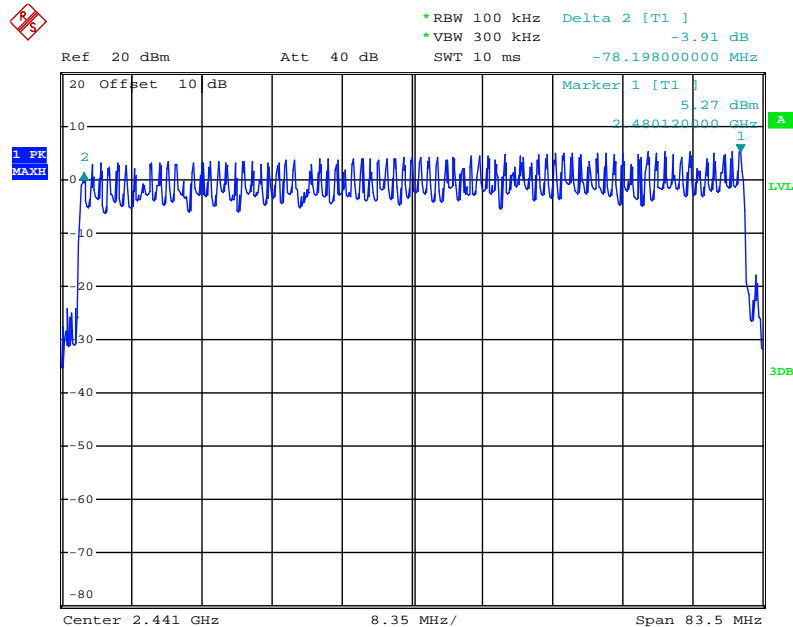

Date: 7.NOV.2018 10:00:47

8. DWELL TIME TEST

8.1. Block Diagram of Test Setup

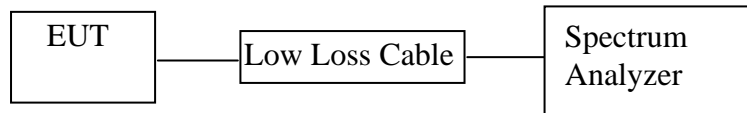

(EUT: True Wireless Earbuds)

8.2. The Requirement For Section 15.247(a)(1)(iii)

Section 15.247(a)(1)(iii): Frequency hopping systems in the 2400-2483.5 MHz band shall use at least 15 channels. The average time of occupancy on any channel shall not be greater than 0.4 seconds within a period of 0.4 seconds multiplied by the number of hopping channels employed. Frequency hopping systems may avoid or suppress transmissions on a particular hopping frequency provided that a minimum of 15 channels are used.

8.3. EUT Configuration on Measurement

The equipment are installed on the emission measurement to meet the commission requirements and operating regulations in a manner which tends to maximize its emission characteristics in normal application.

8.4. Operating Condition of EUT

8.4.1. Setup the EUT and simulator as shown as Section 8.1.

8.4.2. Turn on the power of all equipment.

8.4.3. Let the EUT work in TX (Hopping on) modes measure it. The transmit frequency are 2402-2480MHz. We select 2402MHz, 2441MHz, and 2480MHz TX frequency to transmit.

8.5. Test Procedure

8.5.1. The transmitter output was connected to the spectrum analyzer through a low loss cable.

8.5.2. Set center frequency of spectrum analyzer = operating frequency.

8.5.3. Set the spectrum analyzer as RBW=1MHz, VBW=3MHz, Span=0Hz, Adjust Sweep=5ms, 10ms, 15ms. Get the pulse time.

8.5.4. Repeat above procedures until all frequency measured were complete.

8.6. Test Result

Test Lab: Shielding room

Test Engineer: Bob

GFSK Mode (Worst case)

Mode	Channel Frequency (MHz)	Pulse Time (ms)	Dwell Time (ms)	Limit (ms)
DH1	2441	0.44	140.8	400
A period transmit time = $0.4 \times 79 = 31.6$ Dwell time = pulse time $\times (1600/(2*79)) \times 31.6$				
DH3	2441	1.71	273.6	400
A period transmit time = $0.4 \times 79 = 31.6$ Dwell time = pulse time $\times (1600/(4*79)) \times 31.6$				
DH5	2441	3.01	321.1	400
A period transmit time = $0.4 \times 79 = 31.6$ Dwell time = pulse time $\times (1600/(6*79)) \times 31.6$				

$\Pi/4$ -DQPSK (Worst case)

Mode	Channel Frequency (MHz)	Pulse Time (ms)	Dwell Time (ms)	Limit (ms)
DH1	2441	0.45	144.0	400
A period transmit time = $0.4 \times 79 = 31.6$ Dwell time = pulse time $\times (1600/(2*79)) \times 31.6$				
DH3	2441	1.73	276.8	400
A period transmit time = $0.4 \times 79 = 31.6$ Dwell time = pulse time $\times (1600/(4*79)) \times 31.6$				
DH5	2441	3.02	322.1	400
A period transmit time = $0.4 \times 79 = 31.6$ Dwell time = pulse time $\times (1600/(6*79)) \times 31.6$				

8DPSK (Worst case)

Mode	Channel Frequency (MHz)	Pulse Time (ms)	Dwell Time (ms)	Limit (ms)
DH1	2441	0.45	144.0	400
A period transmit time = $0.4 \times 79 = 31.6$ Dwell time = pulse time $\times (1600/(2*79)) \times 31.6$				
DH3	2441	1.73	276.8	400
A period transmit time = $0.4 \times 79 = 31.6$ Dwell time = pulse time $\times (1600/(4*79)) \times 31.6$				
DH5	2441	2.99	318.9	400
A period transmit time = $0.4 \times 79 = 31.6$ Dwell time = pulse time $\times (1600/(6*79)) \times 31.6$				

Note: We tested GFSK mode and $\Pi/4$ -DQPSK & 8DPSK mode the low, middle and high channel and recorded the worst case data for all test mode.

The spectrum analyzer plots are attached as below.

GFSK Mode

DH1 Middle channel

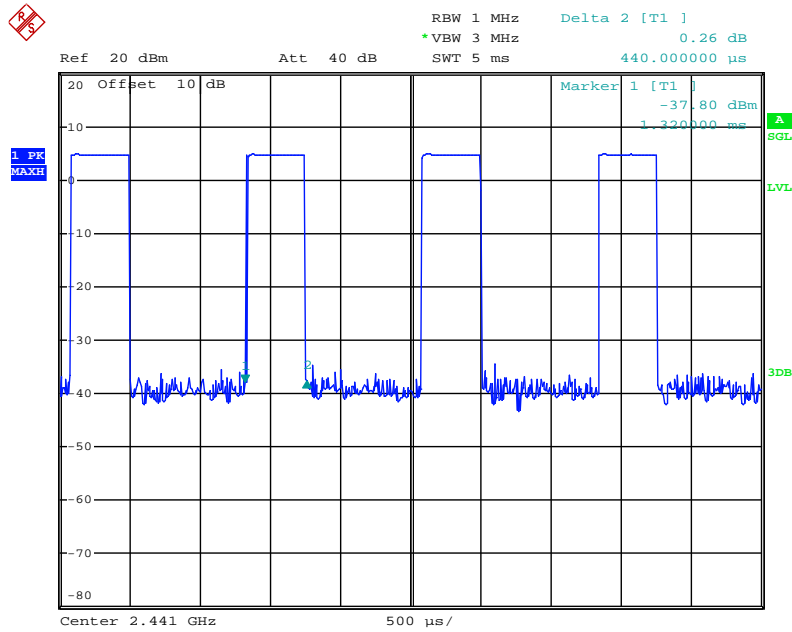

Date: 7.NOV.2018 10:54:23

DH3 Middle channel

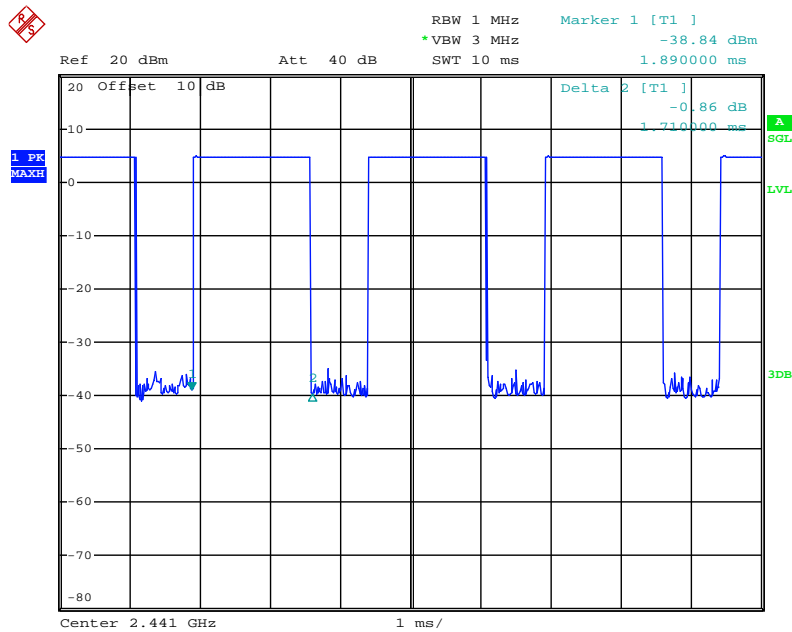

Date: 7.NOV.2018 10:53:52

DH5 Middle channel

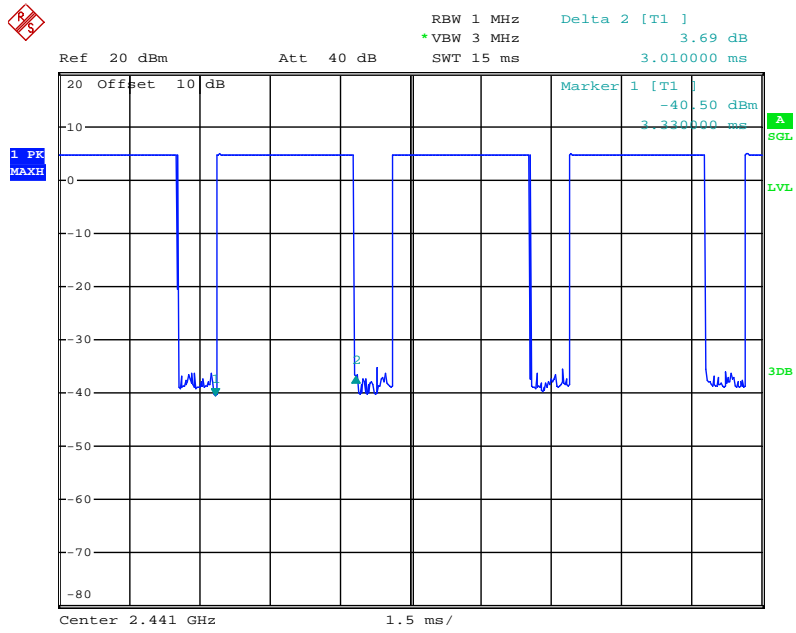

Date: 7.NOV.2018 10:53:22

Π/4-DQPSK

2DH1 Middle channel

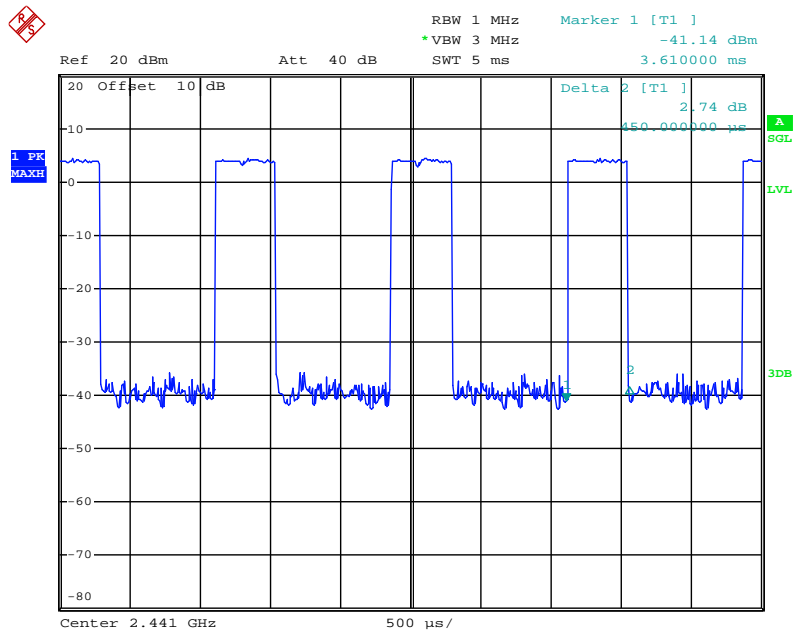

Date: 7.NOV.2018 10:57:49

2DH3 Middle channel

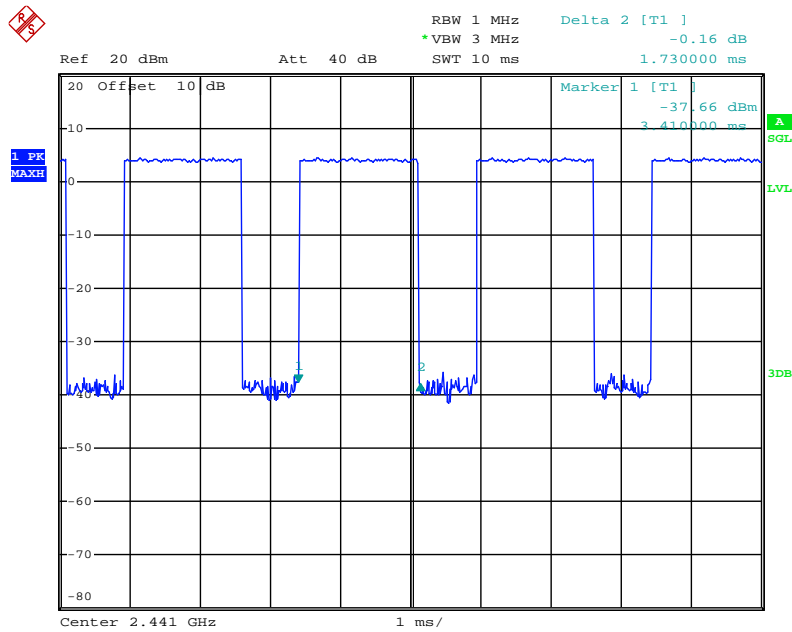

Date: 7.NOV.2018 10:58:26

2DH5 Middle channel

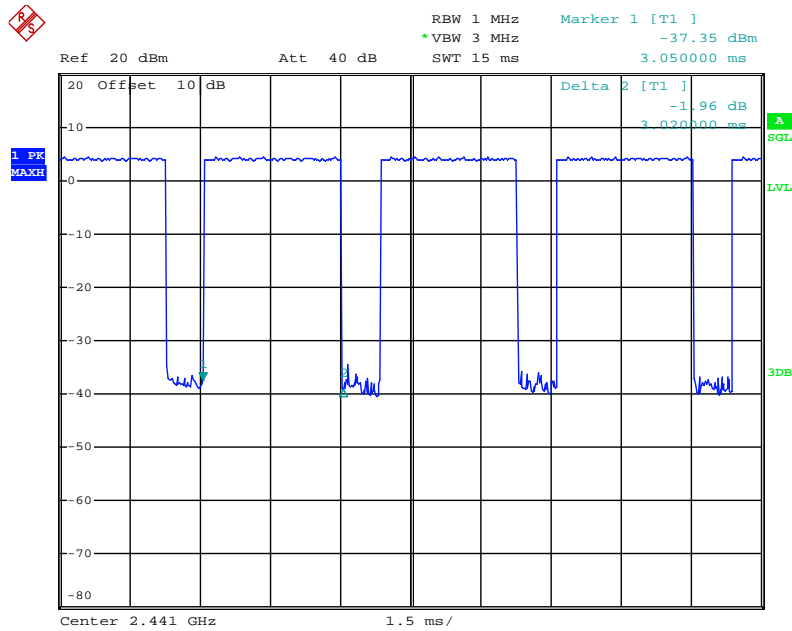

Date: 7.NOV.2018 10:59:00

8DPSK

3DH1 Middle channel

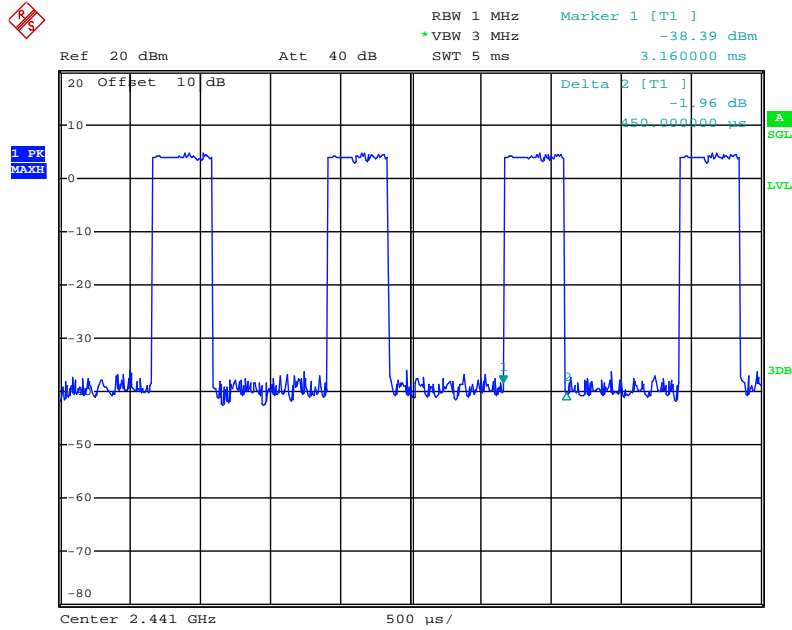

Date: 7.NOV.2018 11:04:33

3DH3 Middle channel

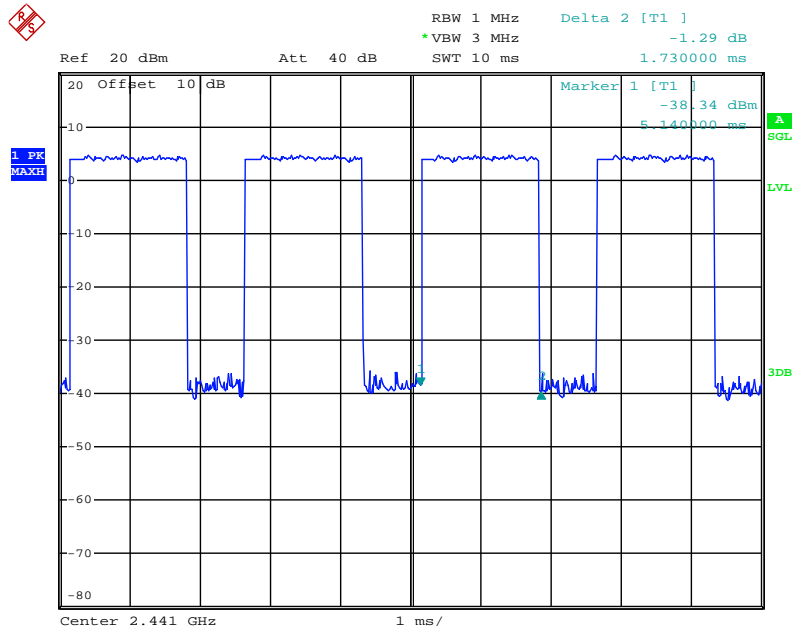

Date: 7.NOV.2018 11:03:59

3DH5 Middle channel

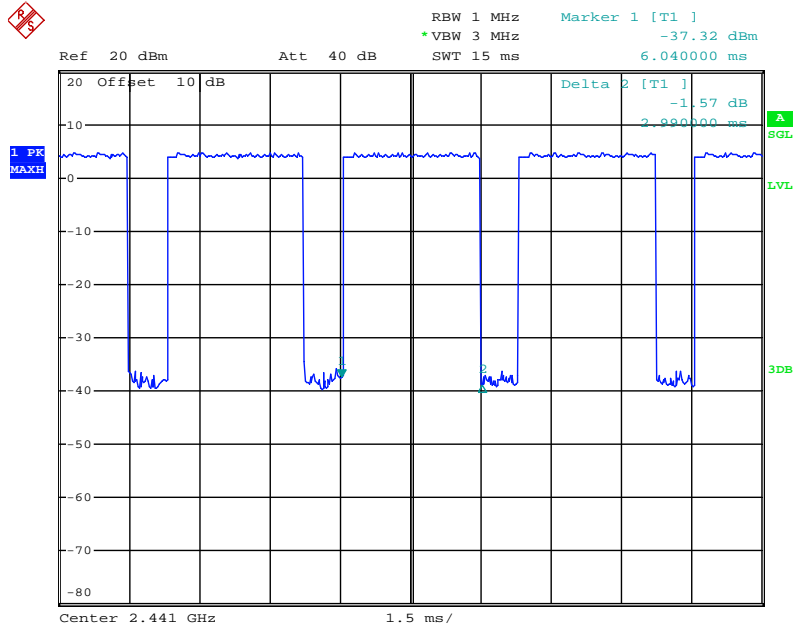

Date: 7.NOV.2018 11:03:24

9. MAXIMUM PEAK OUTPUT POWER TEST

9.1. Block Diagram of Test Setup

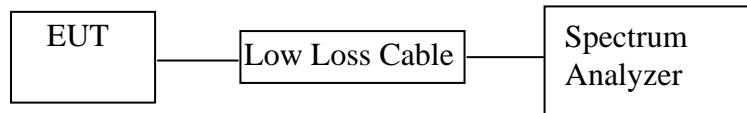

(EUT: True Wireless Earbuds)

9.2. The Requirement For Section 15.247(b)(1)

Section 15.247(b)(1): For frequency hopping systems operating in the 2400-2483.5 MHz band employing at least 75 non-overlapping hopping channels, and all frequency hopping systems in the 5725-5850 MHz band: 1 watt. For all other frequency hopping systems in the 2400-2483.5 MHz band: 0.125 watts.

9.3. EUT Configuration on Measurement

The equipment are installed on the emission Measurement to meet the commission requirements and operating regulations in a manner which tends to maximize its emission characteristics in normal application.

9.4. Operating Condition of EUT

9.4.1. Setup the EUT and simulator as shown as Section 9.1.

9.4.2. Turn on the power of all equipment.

9.4.3. Let the EUT work in TX (Hopping off) modes measure it. The transmit frequency are 2402-2480MHz. We select 2402MHz, 2441MHz, and 2480MHz TX frequency to transmit.

9.5. Test Procedure

9.5.1. The transmitter output was connected to the spectrum analyzer through a low loss cable.

9.5.2. Set RBW of spectrum analyzer to 3MHz and VBW to 10MHz.

9.5.3. Measurement the maximum peak output power.

9.6. Test Result

Test Lab: Shielding room

Test Engineer: Bob

GFSK Mode

Channel	Frequency (MHz)	Peak Output Power (dBm/W)	Limits dBm / W
Low	2402	4.07/0.0026	21 / 0.125
Middle	2441	5.11/0.0032	21 / 0.125
High	2480	5.90/0.0039	21 / 0.125

Π/4-DQPSK Mode

Channel	Frequency (MHz)	Peak Output Power (dBm/W)	Limits dBm / W
Low	2402	3.86/0.0024	21 / 0.125
Middle	2441	5.05/0.0032	21 / 0.125
High	2480	5.75/0.0038	21 / 0.125

8DPSK

Channel	Frequency (MHz)	Peak Output Power (dBm/W)	Limits dBm / W
Low	2402	4.23/0.0026	21 / 0.125
Middle	2441	5.32/0.0034	21 / 0.125
High	2480	6.03/0.0040	21 / 0.125

The spectrum analyzer plots are attached as below.

GFSK Mode

Low channel

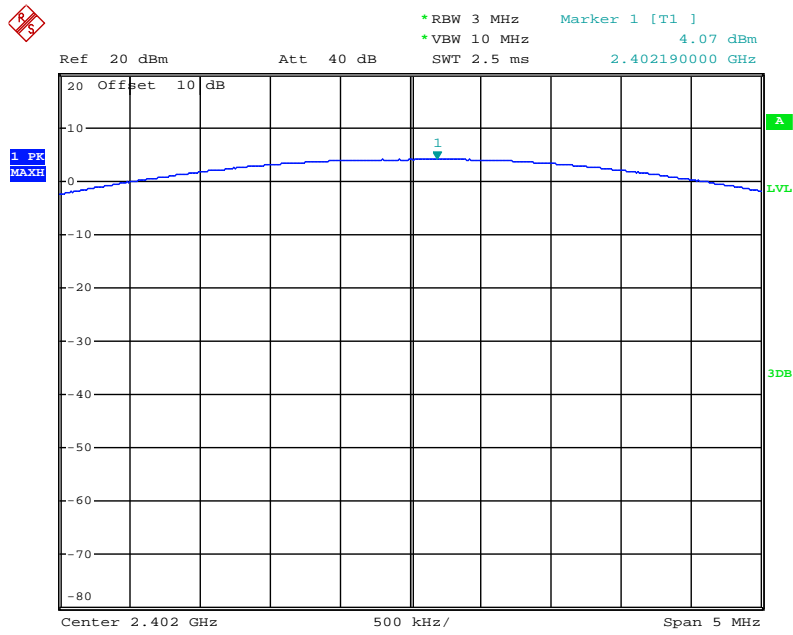

Date: 7.NOV.2018 09:53:59

Middle channel

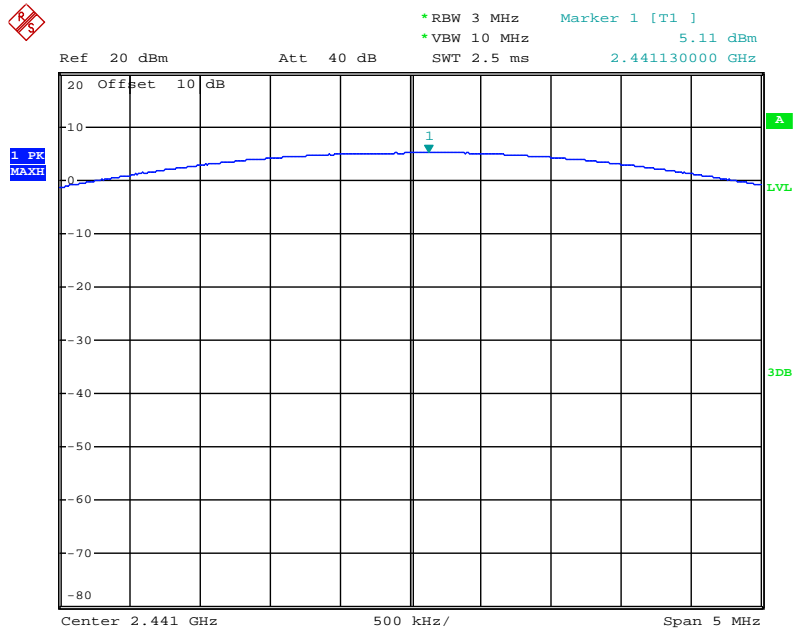

Date: 7.NOV.2018 09:54:24

High channel

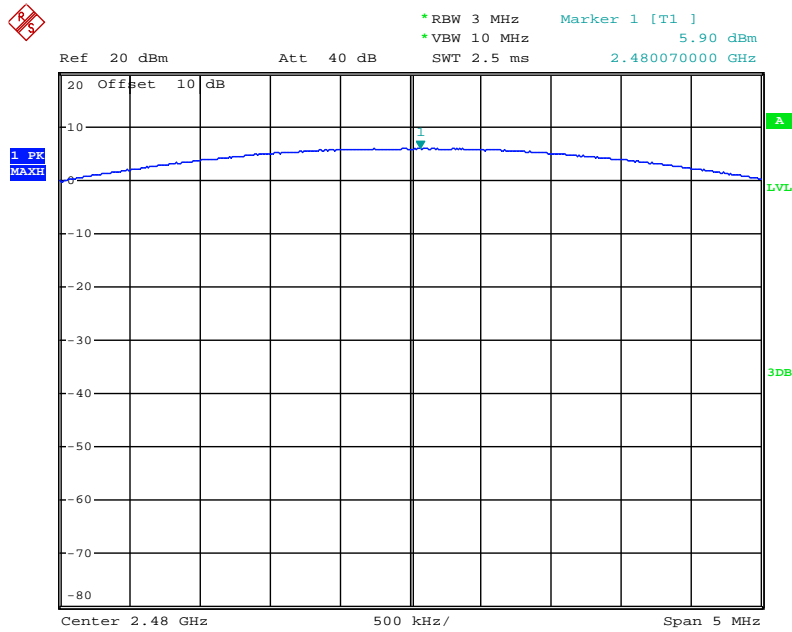

Date: 7.NOV.2018 09:55:12

Π/4-DQPSK Mode

Low channel

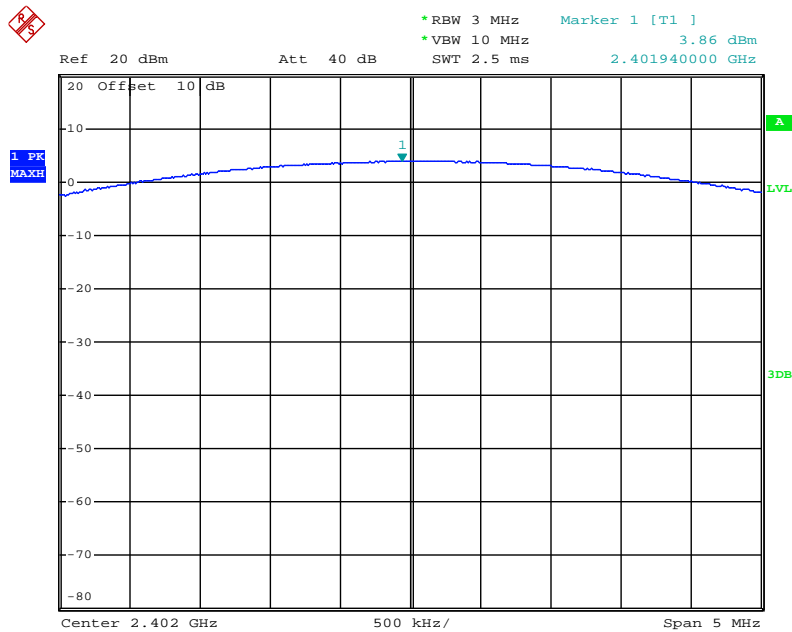

Date: 7.NOV.2018 09:56:44

Middle channel

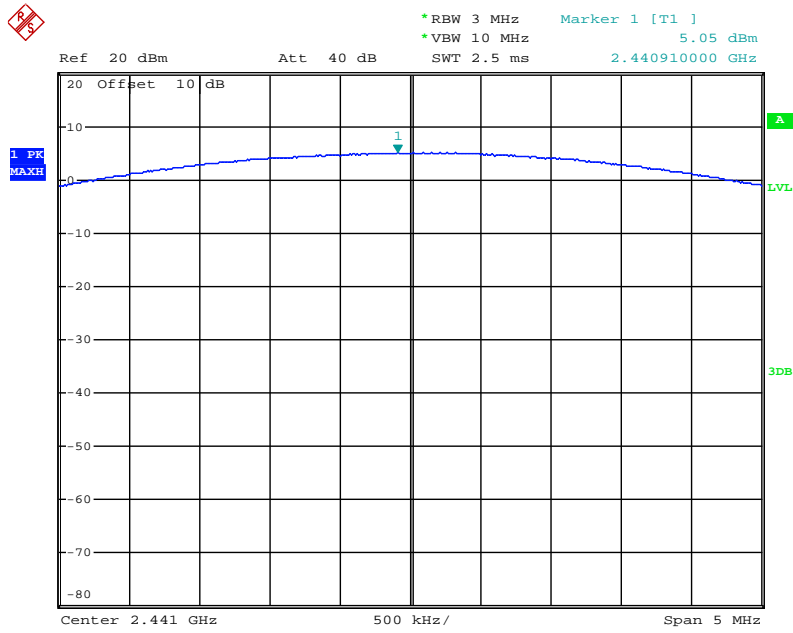

Date: 7.NOV.2018 09:56:17

High channel

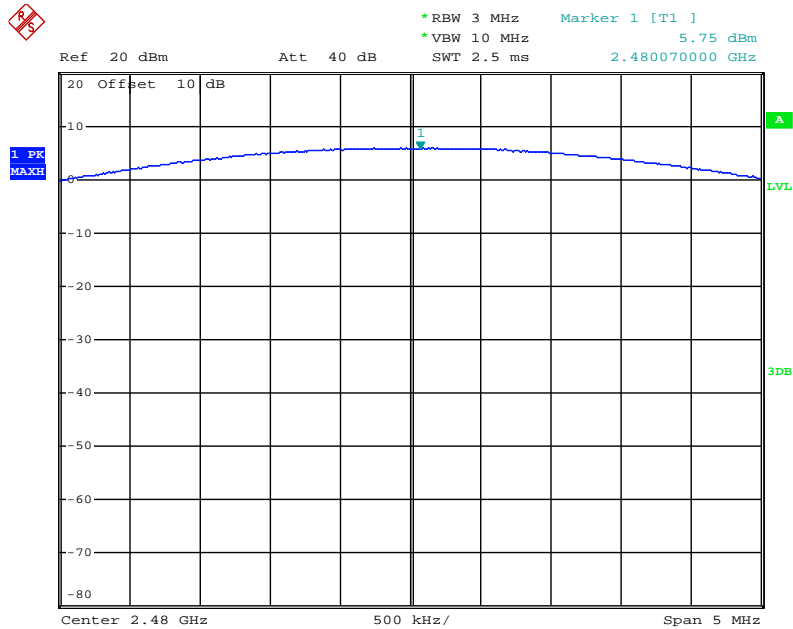

Date: 7.NOV.2018 09:55:27

8DPSK Mode

Low channel

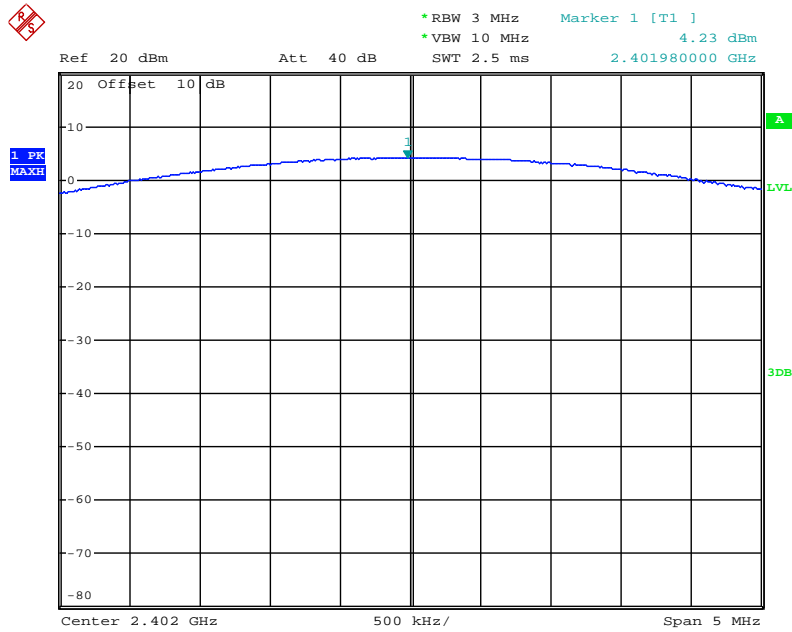

Date: 7.NOV.2018 09:57:19

Middle channel

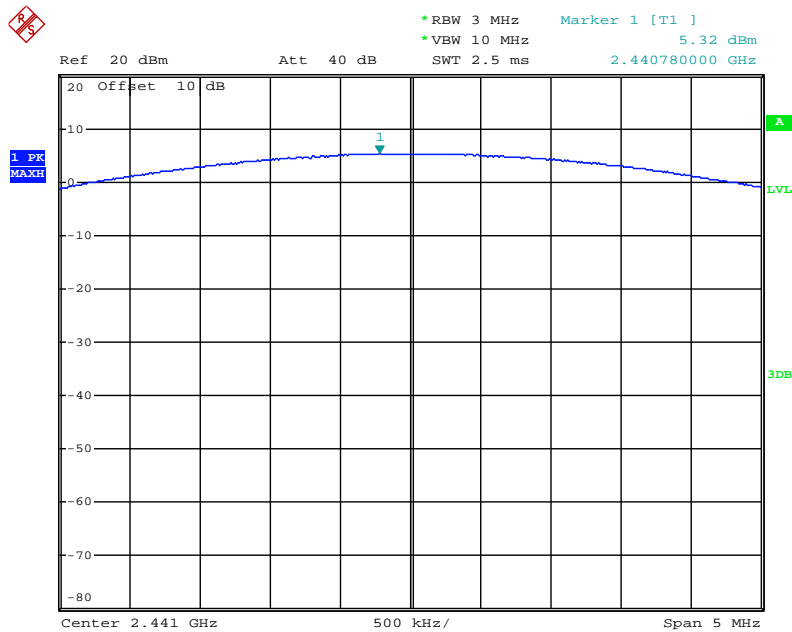

Date: 7.NOV.2018 09:57:50

High channel

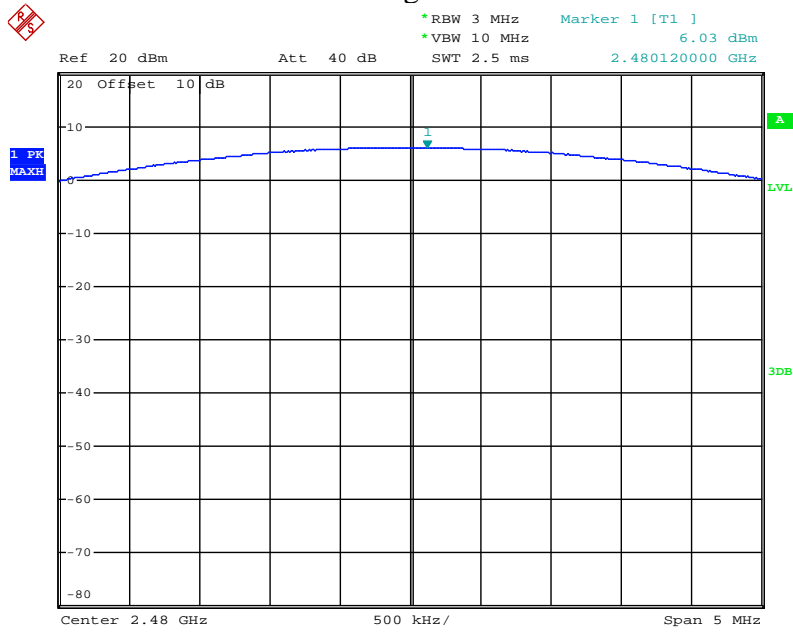

Date: 7.NOV.2018 09:58:20

10. RADIATED EMISSION TEST

10.1. Block Diagram of Test Setup

10.1.1. Block diagram of connection between the EUT and peripherals

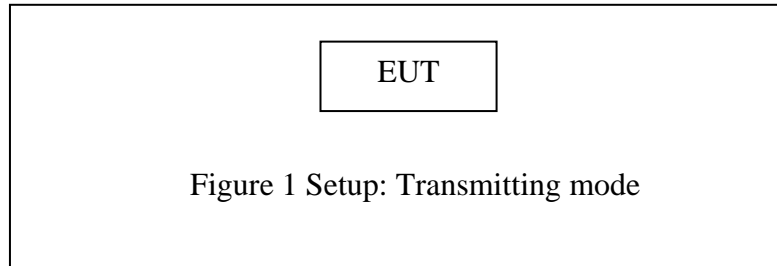

10.1.2. Semi-Anechoic Chamber Test Setup Diagram

(A) Radiated Emission Test Set-Up, Frequency below 30MHz

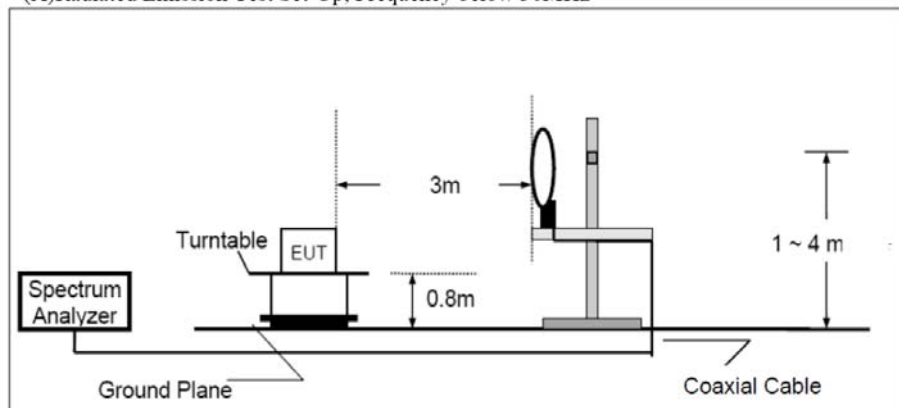

(B) Radiated Emission Test Set-Up, Frequency 30MHz-1GHz

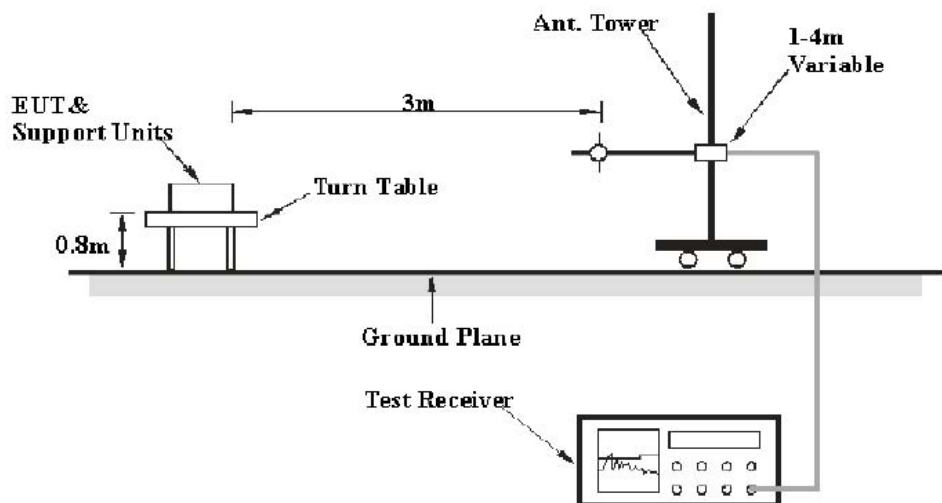

(C) Radiated Emission Test Set-Up, Frequency above 1GHz

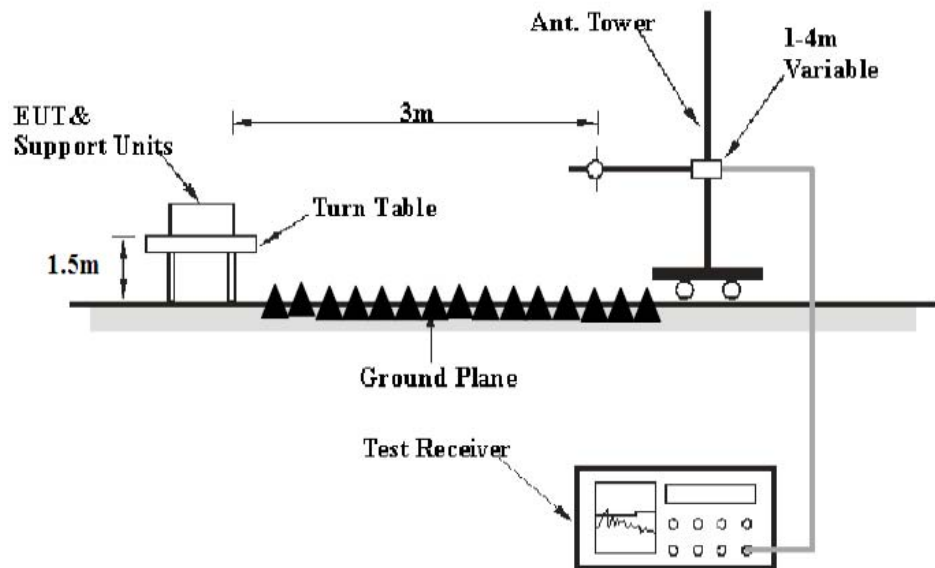

10.2. The Limit For Section 15.247(d)

Section 15.247(d): In any 100 kHz bandwidth outside the frequency band in which the spread spectrum or digitally modulated intentional radiator is operating, the radio frequency power that is produced by the intentional radiator shall be at least 20 dB below that in the 100 kHz bandwidth within the band that contains the highest level of the desired power, based on either an RF conducted or a radiated measurement, provided the transmitter demonstrates compliance with the peak conducted power limits. If the transmitter complies with the conducted power limits based on the use of RMS averaging over a time interval, as permitted under paragraph (b)(3) of this section, the attenuation required under this paragraph shall be 30 dB instead of 20 dB. Attenuation below the general limits specified in Section 15.209(a) is not required. In addition, radiated emissions which fall in the restricted bands, as defined in Section 15.205(a), must also comply with the radiated emission limits specified in Section 15.209(a).

10.3.Restricted bands of operation

10.3.1.FCC Part 15.205 Restricted bands of operation

(a) Except as shown in paragraph (d) of this section, Only spurious emissions are permitted in any of the frequency bands listed below:

MHz	MHz	MHz	GHz
0.090-0.110	16.42-16.423	399.9-410	4.5-5.15
¹ 0.495-0.505	16.69475-16.69525	608-614	5.35-5.46
2.1735-2.1905	16.80425-16.80475	960-1240	7.25-7.75
4.125-4.128	25.5-25.67	1300-1427	8.025-8.5
4.17725-4.17775	37.5-38.25	1435-1626.5	9.0-9.2
4.20725-4.20775	73-74.6	1645.5-1646.5	9.3-9.5
6.215-6.218	74.8-75.2	1660-1710	10.6-12.7
6.26775-6.26825	108-121.94	1718.8-1722.2	13.25-13.4
6.31175-6.31225	123-138	2200-2300	14.47-14.5
8.291-8.294	149.9-150.05	2310-2390	15.35-16.2
8.362-8.366	156.52475-156.52525	2483.5-2500	17.7-21.4
8.37625-8.38675	156.7-156.9	2690-2900	22.01-23.12
8.41425-8.41475	162.0125-167.17	3260-3267	23.6-24.0
12.29-12.293	167.72-173.2	3332-3339	31.2-31.8
12.51975-12.52025	240-285	3345.8-3358	36.43-36.5
12.57675-12.57725	322-335.4	3600-4400	(²)
13.36-13.41			

¹Until February 1, 1999, this restricted band shall be 0.490-0.510

²Above 38.6

(b) Except as provided in paragraphs (d) and (e), the field strength of emission appearing within these frequency bands shall not exceed the limits shown in Section 15.209. At frequencies equal to or less than 1000MHz, Compliance with the limits in Section 15.209 shall be demonstrated using measurement instrumentation employing a CISPR quasi-peak detector. Above 1000MHz, compliance with the emission limits in Section 15.209 shall be demonstrated based on the average value of the measured emissions. The provisions in Section 15.35 apply to these measurements.

10.4.Configuration of EUT on Measurement

The equipment is installed on Radiated Emission Measurement to meet the commission requirements and operating regulations in a manner which tends to maximize its emission characteristics in normal application.

10.5. Operating Condition of EUT

10.5.1. Setup the EUT and simulator as shown as Section 10.1.

10.5.2. Turn on the power of all equipment.

10.5.3. Let the EUT work in TX modes measure it. The transmit frequency are 2402-2480MHz. We select 2402MHz, 2441MHz, and 2480MHz TX frequency to transmit.

10.6. Test Procedure

The EUT and its simulators are placed on a turntable, which is 0.8 meter high above ground (Below 1GHz). The EUT and its simulators are placed on a turntable, which is 1.5 meter high above ground (Above 1GHz). The turntable can rotate 360 degrees to determine the position of the maximum emission level. EUT is set 3.0 meters away from the receiving antenna, which is mounted on an antenna tower. The antenna can be moved up and down between 1.0 meter and 4 meters to find out the maximum emission level. Broadband antenna (calibrated bi-log antenna) is used as receiving antenna. Both horizontal and vertical polarizations of the antenna are set on measurement. In order to find the maximum emission levels, all of the EUT location must be manipulated according to ANSI C63.10:2013 on radiated emission measurement. This EUT was tested in 3 orthogonal positions and the worst case position data was reported.

During the radiated emission test, the spectrum analyzer was set with the following configurations:

1. The resolution bandwidth and video bandwidth of test receiver/spectrum analyzer is 120kHz for Quasi-peak at frequency below 1GHz.
2. The resolution bandwidth of test receiver/spectrum analyzer is 1MHz and video bandwidth is 3MHz for peak measurement with peak detector at frequency above 1GHz.
3. The resolution bandwidth of test receiver/spectrum analyzer is 1MHz and video bandwidth is 10Hz for Average measurement with peak detection at frequency above 1GHz.
4. All modes of operation were investigated and the worst-case emissions are reported.

10.7.Data Sample

Frequency (MHz)	Reading (dB μ v)	Factor (dB/m)	Result (dB μ v/m)	Limit (dB μ v/m)	Margin (dB)	Remark
X.XX	48.69	-13.35	35.34	46	-10.66	QP

Frequency(MHz) = Emission frequency in MHz

Reading(dB μ v) = Uncorrected Analyzer/Receiver reading

Factor (dB/m) = Antenna factor + Cable Loss – Amplifier gain

Result(dB μ v/m) = Reading(dB μ v) + Factor(dB/m)

Limit (dB μ v/m) = Limit stated in standard

Margin (dB) = Result(dB μ v/m) - Limit (dB μ v/m)

QP = Quasi-peak Reading

Calculation Formula:

Margin(dB) = Result (dB μ V/m)–Limit(dB μ V/m)

Result(dB μ V/m)= Reading(dB μ V)+ Factor(dB/m)

The “Margin” column of the following data tables indicates the degree of compliance with the applicable limit. For example, a margin of -7dB means the emission is 7dB below the limit.

10.8.The Field Strength of Radiation Emission Measurement Results

PASS.

Test Lab: 3m Anechoic chamber

Test Engineer: Bob

Note: 1.We tested GFSK mode, $\Pi/4$ -DQPSK & 8DPSK Mode and recorded the worst case data (GFSK mode) for all test mode.

2. Testing is carried out with frequency rang 9kHz to the tenth harmonics, which above 3th Harmonics are attenuated more than 20dB below the permissible limits or the field strength is too small to be measured. The measurements greater than 20dB below the limit from 9kHz to 30MHz and 18 to 26.5GHz.

The spectrum analyzer plots are attached as below.

Below 1GHz



ACCURATE TECHNOLOGY CO., LTD.

F1,Bldg,A,Changyuan New Material Port Keyuan Rd,
Science & Industry Park,Nanshan Shenzhen,P.R.China

Site: 1# Chamber

Tel:+86-0755-26503290

Fax:+86-0755-26503396

Job No.: frank2017 #466	Polarization: Horizontal
Standard: FCC Class B 3M Radiated	Power Source: DC 3.7V
Test item: Radiation Test	Date: 18/11/05/
Temp.(C)/Hum.(%) 25 C / 55 %	Time: 14/40/23
EUT: True Wireless Earbuds	Engineer Signature: Bob
Mode: TX2402MHz	Distance: 3m
Model: BE1018	
Manufacturer: Shenzhen Kinlan Technology Company Limited	

Note: Report NO.:ATE20181915

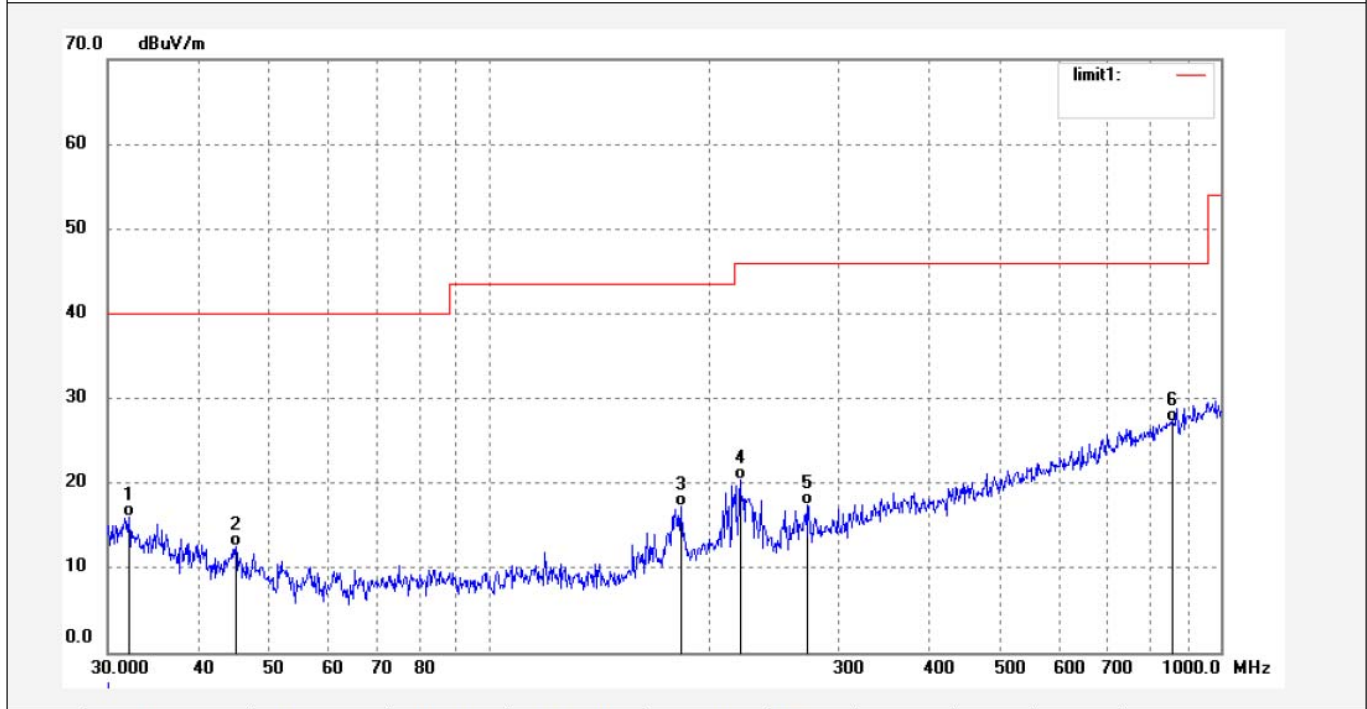

No.	Freq. (MHz)	Reading (dBuV/m)	Factor (dB)	Result (dBuV/m)	Limit (dBuV/m)	Margin (dB)	Detector	Height (cm)	Degree (deg.)	Remark
1	32.0711	31.28	-15.22	16.06	40.00	-23.94	QP	100	145	
2	44.9369	31.36	-18.91	12.45	40.00	-27.55	QP	100	246	
3	182.5784	37.26	-20.08	17.18	43.50	-26.32	QP	100	320	
4	219.9499	38.84	-18.40	20.44	46.00	-25.56	QP	100	110	
5	272.5246	34.45	-16.98	17.47	46.00	-28.53	QP	100	154	
6	853.7546	30.48	-3.18	27.30	46.00	-18.70	QP	100	211	



ACCURATE TECHNOLOGY CO., LTD.

F1,Bldg,A,Changyuan New Material Port Keyuan Rd,
Science & Industry Park,Nanshan Shenzhen,P.R.China

Site: 1# Chamber
Tel:+86-0755-26503290
Fax:+86-0755-26503396

Job No.: frank2017 #467

Standard: FCC Class B 3M Radiated

Test item: Radiation Test

Temp.(C)/Hum.(%) 25 C / 55 %

EUT: True Wireless Earbuds

Mode: TX2402MHz

Model: BE1018

Manufacturer: Shenzhen Kinlan Technology Company Limited

Polarization: Vertical

Power Source: DC 3.7V

Date: 18/11/05/

Time: 14/44/28

Engineer Signature: Bob

Distance: 3m

Note: Report NO.:ATE20181915

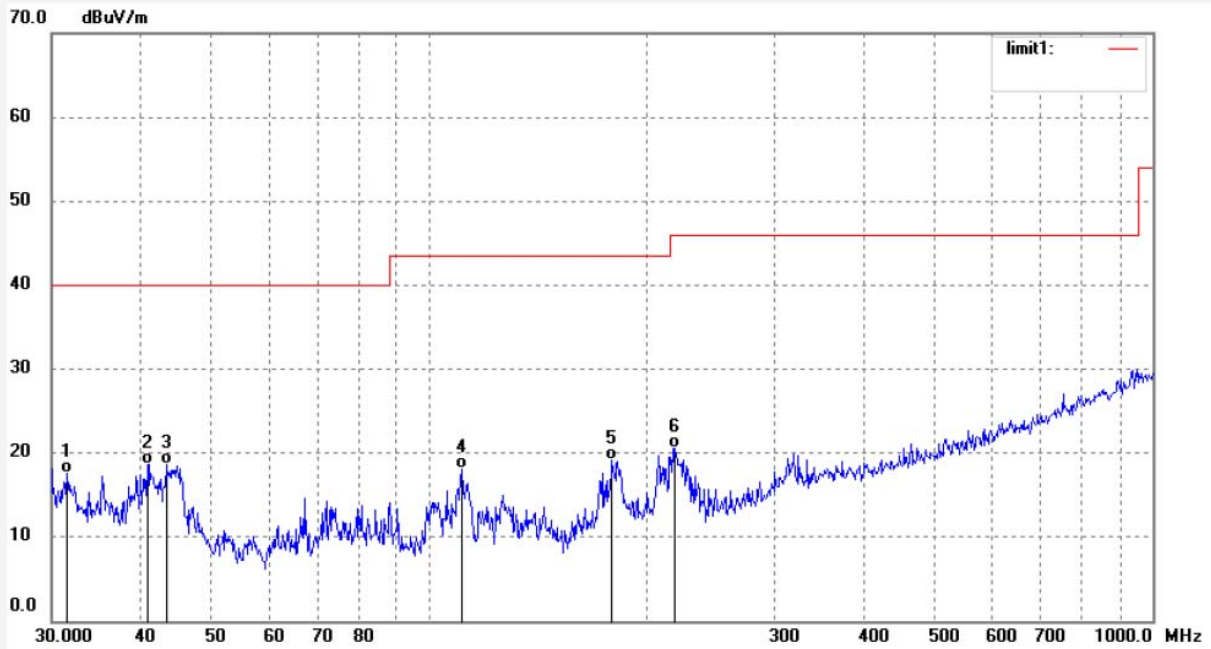

No.	Freq. (MHz)	Reading (dBuV/m)	Factor (dB)	Result (dBuV/m)	Limit (dBuV/m)	Margin (dB)	Detector	Height (cm)	Degree (deg.)	Remark
1	31.5125	32.71	-15.07	17.64	40.00	-22.36	QP	100	154	
2	40.7265	36.94	-18.22	18.72	40.00	-21.28	QP	100	113	
3	43.2332	37.26	-18.63	18.63	40.00	-21.37	QP	100	254	
4	110.8580	40.01	-21.83	18.18	43.50	-25.32	QP	100	306	
5	178.7697	39.69	-20.45	19.24	43.50	-24.26	QP	100	245	
6	218.4097	38.91	-18.40	20.51	46.00	-25.49	QP	100	257	



ACCURATE TECHNOLOGY CO., LTD.

F1,Bldg,A,Changyuan New Material Port Keyuan Rd,
Science & Industry Park,Nanshan Shenzhen,P.R.China

Site: 1# Chamber
Tel:+86-0755-26503290
Fax:+86-0755-26503396

Job No.: frank2017 #468	Polarization: Vertical
Standard: FCC Class B 3M Radiated	Power Source: DC 3.7V
Test item: Radiation Test	Date: 18/11/05/
Temp.(C)/Hum.(%) 25 C / 55 %	Time: 14/47/38
EUT: True Wireless Earbuds	Engineer Signature: Bob
Mode: TX2440MHz	Distance: 3m
Model: BE1018	
Manufacturer: Shenzhen Kinlan Technology Company Limited	

Note: Report NO.:ATE20181915

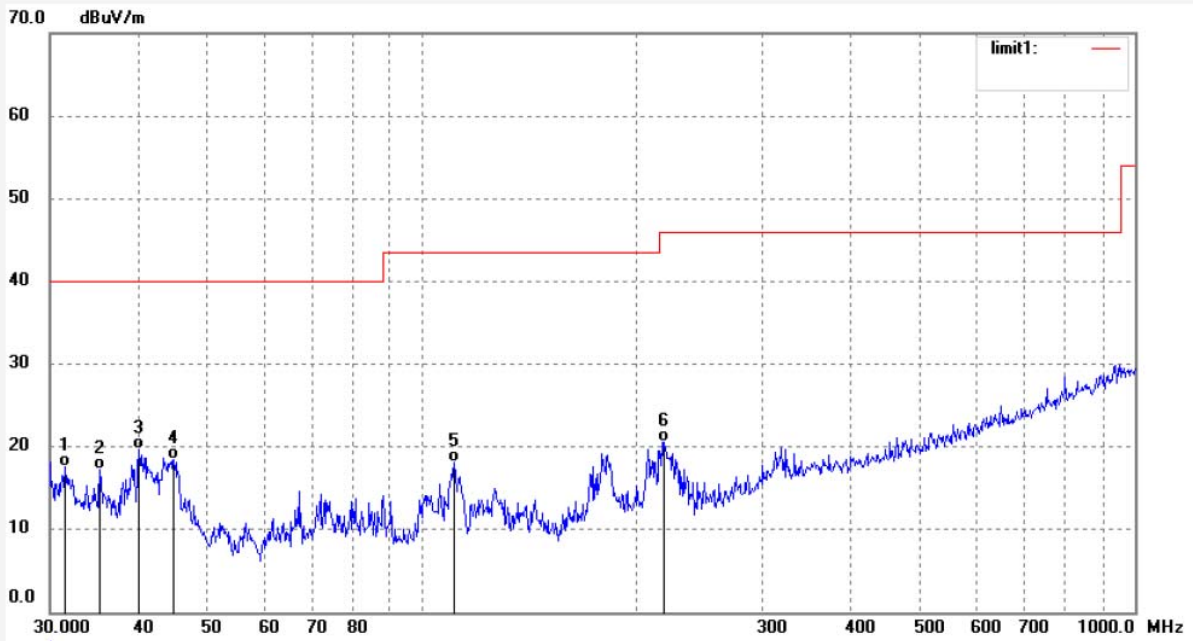

No.	Freq. (MHz)	Reading (dBuV/m)	Factor (dB)	Result (dBuV/m)	Limit (dBuV/m)	Margin (dB)	Detector	Height (cm)	Degree (deg.)	Remark
1	31.5125	32.71	-15.07	17.64	40.00	-22.36	QP	100	76	
2	35.2625	33.22	-16.05	17.17	40.00	-22.83	QP	100	103	
3	40.0172	37.85	-18.10	19.75	40.00	-20.25	QP	100	251	
4	44.7792	37.36	-18.88	18.48	40.00	-21.52	QP	100	241	
5	110.8580	40.01	-21.83	18.18	43.50	-25.32	QP	100	136	
6	218.4097	38.91	-18.40	20.51	46.00	-25.49	QP	100	26	



ACCURATE TECHNOLOGY CO., LTD.

F1,Bldg,A,Changyuan New Material Port Keyuan Rd,
Science & Industry Park,Nanshan Shenzhen,P.R.China

Site: 1# Chamber
Tel:+86-0755-26503290
Fax:+86-0755-26503396

Job No.: frank2017 #469	Polarization: Horizontal
Standard: FCC Class B 3M Radiated	Power Source: DC 3.7V
Test item: Radiation Test	Date: 18/11/05/
Temp.(C)/Hum.(%) 25 C / 55 %	Time: 14/50/11
EUT: True Wireless Earbuds	Engineer Signature: Bob
Mode: TX2440MHz	Distance: 3m
Model: BE1018	
Manufacturer: Shenzhen Kinlan Technology Company Limited	

Note: Report NO.:ATE20181915

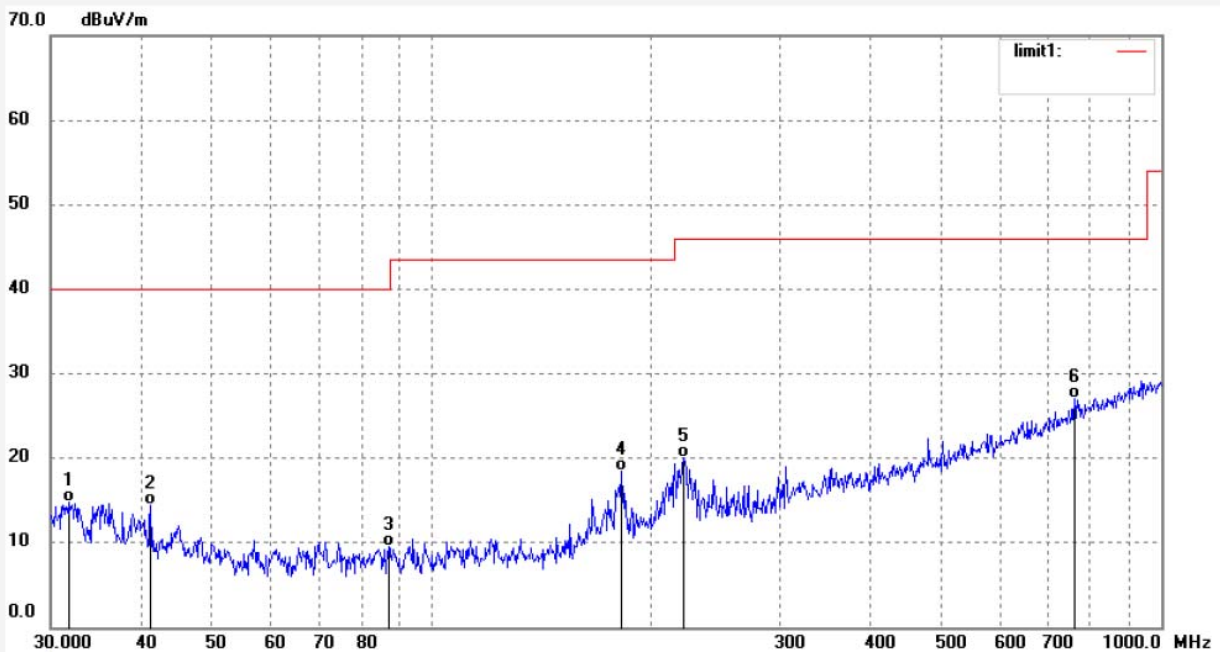

No.	Freq. (MHz)	Reading (dBuV/m)	Factor (dB)	Result (dBuV/m)	Limit (dBuV/m)	Margin (dB)	Detector	Height (cm)	Degree (deg.)	Remark
1	31.7347	29.93	-15.14	14.79	40.00	-25.21	QP	100	119	
2	41.1580	32.75	-18.30	14.45	40.00	-25.55	QP	100	210	
3	87.2980	31.51	-21.94	9.57	40.00	-30.43	QP	100	151	
4	181.9380	38.60	-20.14	18.46	43.50	-25.04	QP	100	310	
5	221.5010	38.39	-18.37	20.02	46.00	-25.98	QP	100	230	
6	760.2866	31.90	-4.91	26.99	46.00	-19.01	QP	100	115	



ACCURATE TECHNOLOGY CO., LTD.

F1,Bldg,A,Changyuan New Material Port Keyuan Rd,
Science & Industry Park,Nanshan Shenzhen,P.R.China

Site: 1# Chamber
Tel:+86-0755-26503290
Fax:+86-0755-26503396

Job No.: frank2017 #470	Polarization: Horizontal
Standard: FCC Class B 3M Radiated	Power Source: DC 3.7V
Test item: Radiation Test	Date: 18/11/05/
Temp.(C)/Hum.(%) 25 C / 55 %	Time: 14/53/20
EUT: True Wireless Earbuds	Engineer Signature: Bob
Mode: TX2480MHz	Distance: 3m
Model: BE1018	
Manufacturer: Shenzhen Kinlan Technology Company Limited	

Note: Report NO.:ATE20181915

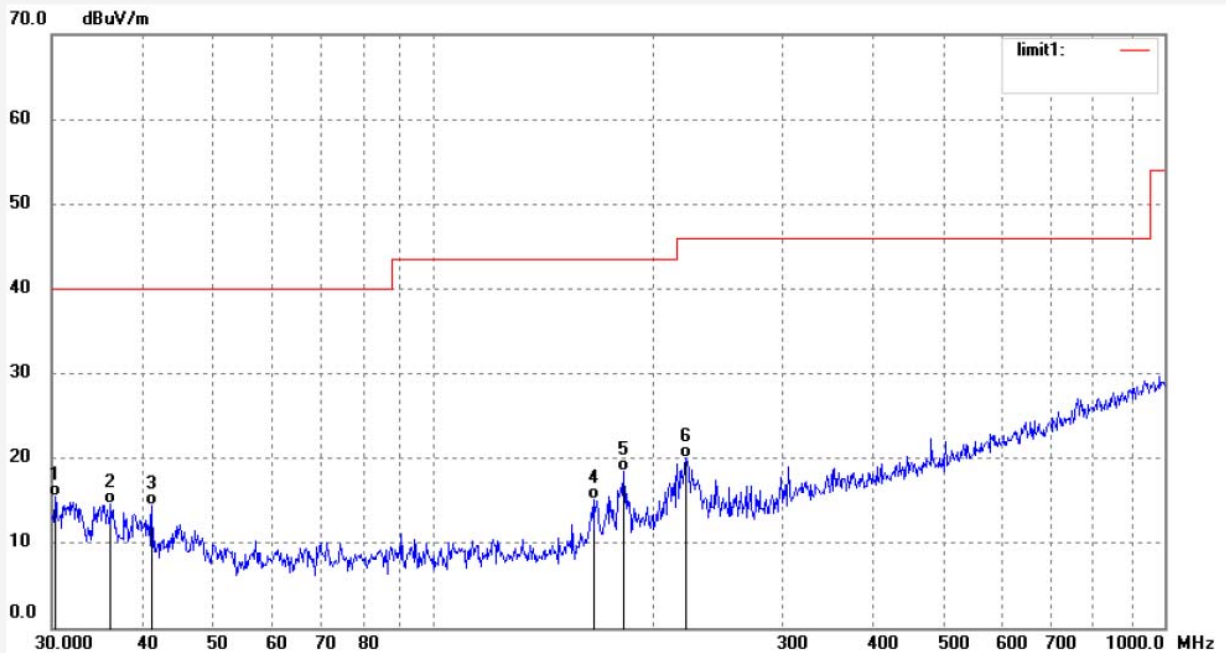

No.	Freq. (MHz)	Reading (dBuV/m)	Factor (dB)	Result (dBuV/m)	Limit (dBuV/m)	Margin (dB)	Detector	Height (cm)	Degree (deg.)	Remark
1	30.3179	30.19	-14.78	15.41	40.00	-24.59	QP	100	251	
2	36.1405	31.04	-16.45	14.59	40.00	-25.41	QP	100	135	
3	41.1580	32.75	-18.30	14.45	40.00	-25.55	QP	100	121	
4	166.0540	35.81	-20.72	15.09	43.50	-28.41	QP	100	102	
5	181.9380	38.60	-20.14	18.46	43.50	-25.04	QP	100	201	
6	221.5010	38.39	-18.37	20.02	46.00	-25.98	QP	100	322	



ACCURATE TECHNOLOGY CO., LTD.

F1,Bldg,A,Changyuan New Material Port Keyuan Rd,
Science & Industry Park,Nanshan Shenzhen,P.R.China

Site: 1# Chamber
Tel:+86-0755-26503290
Fax:+86-0755-26503396

Job No.: frank2017 #471	Polarization: Vertical
Standard: FCC Class B 3M Radiated	Power Source: DC 3.7V
Test item: Radiation Test	Date: 18/11/05/
Temp.(C)/Hum.(%) 25 C / 55 %	Time: 14/57/06
EUT: True Wireless Earbuds	Engineer Signature: Bob
Mode: TX2480MHz	Distance: 3m
Model: BE1018	
Manufacturer: Shenzhen Kinlan Technology Company Limited	

Note: Report NO.:ATE20181915

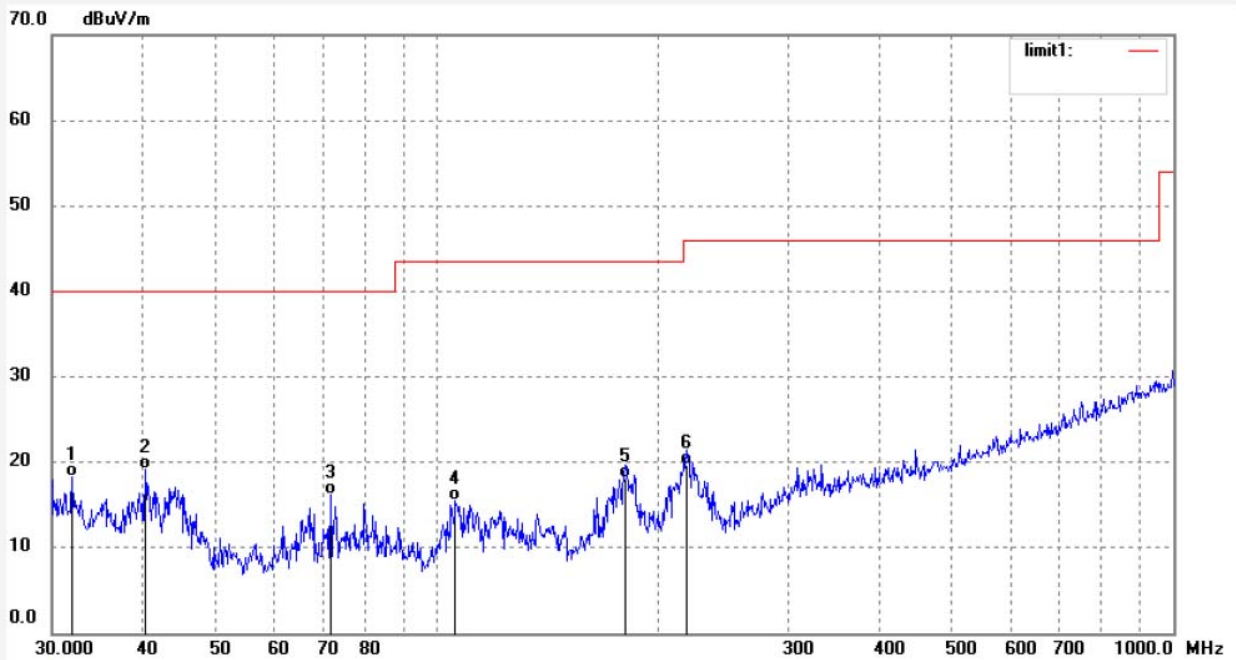

No.	Freq. (MHz)	Reading (dBuV/m)	Factor (dB)	Result (dBuV/m)	Limit (dBuV/m)	Margin (dB)	Detector	Height (cm)	Degree (deg.)	Remark
1	31.9586	33.55	-15.19	18.36	40.00	-21.64	QP	100	135	
2	40.1580	37.25	-18.13	19.12	40.00	-20.88	QP	100	210	
3	71.7053	38.33	-22.16	16.17	40.00	-23.83	QP	100	115	
4	105.9084	38.12	-22.56	15.56	43.50	-27.94	QP	100	302	
5	180.0302	38.45	-20.33	18.12	43.50	-25.38	QP	100	135	
6	218.4097	38.15	-18.40	19.75	46.00	-26.25	QP	100	222	

Above 1GHz



ACCURATE TECHNOLOGY CO., LTD.

F1,Bldg,A,Changyuan New Material Port Keyuan Rd,
Science & Industry Park,Nanshan Shenzhen,P.R.China

Site: 1# Chamber

Tel:+86-0755-26503290

Fax:+86-0755-26503396

Job No.: frank test #360

Standard: FCC PK

Test item: Radiation Test

Temp.(C)/Hum.(%) 25 C / 55 %

EUT: True Wireless Earbuds

Mode: TX2402MHz(GFSK)

Model: BE1018

Manufacturer: Shenzhen Kinlan Technology Company Limited

Polarization: Horizontal

Power Source: DC 3.7V

Date: 18/11/05/

Time: 14/01/12

Engineer Signature: Bob

Distance: 3m

Note: Report NO.:ATE20181915

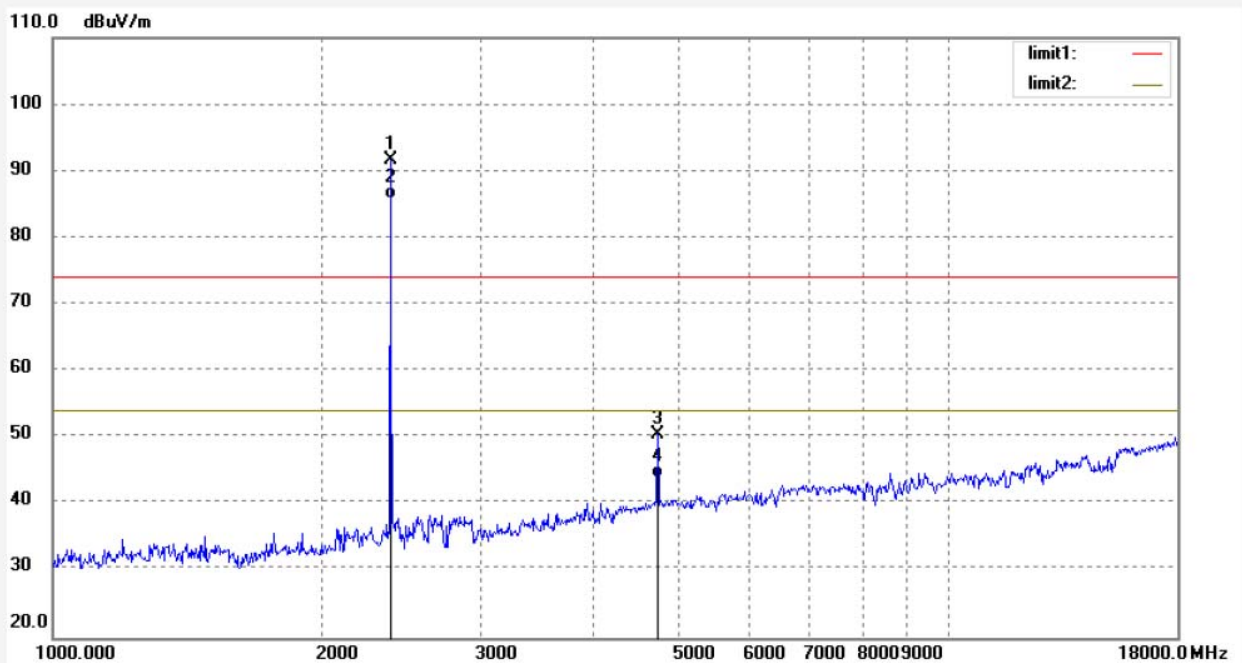

No.	Freq. (MHz)	Reading (dBuV/m)	Factor (dB)	Result (dBuV/m)	Limit (dBuV/m)	Margin (dB)	Detector	Height (cm)	Degree (deg.)	Remark
1	2402.000	95.93	-4.37	91.56			peak	200	138	
2	2402.000	90.12	-4.37	85.75			AVG	200	152	
3	4804.000	47.78	2.70	50.48	74.00	-23.52	peak	200	214	
4	4804.000	41.15	2.70	43.85	54.00	-10.15	AVG	200	103	



ACCURATE TECHNOLOGY CO., LTD.

F1,Bldg,A,Changyuan New Material Port Keyuan Rd,
Science & Industry Park,Nanshan Shenzhen,P.R.China

Site: 1# Chamber

Tel:+86-0755-26503290

Fax:+86-0755-26503396

Job No.: frank test #361	Polarization: Vertical
Standard: FCC PK	Power Source: DC 3.7V
Test item: Radiation Test	Date: 18/11/05/
Temp.(C)/Hum.(%) 25 C / 55 %	Time: 14/07/12
EUT: True Wireless Earbuds	Engineer Signature: Bob
Mode: TX2402MHz(GFSK)	Distance: 3m
Model: BE1018	
Manufacturer: Shenzhen Kinlan Technology Company Limited	

Note: Report NO.:ATE20181915

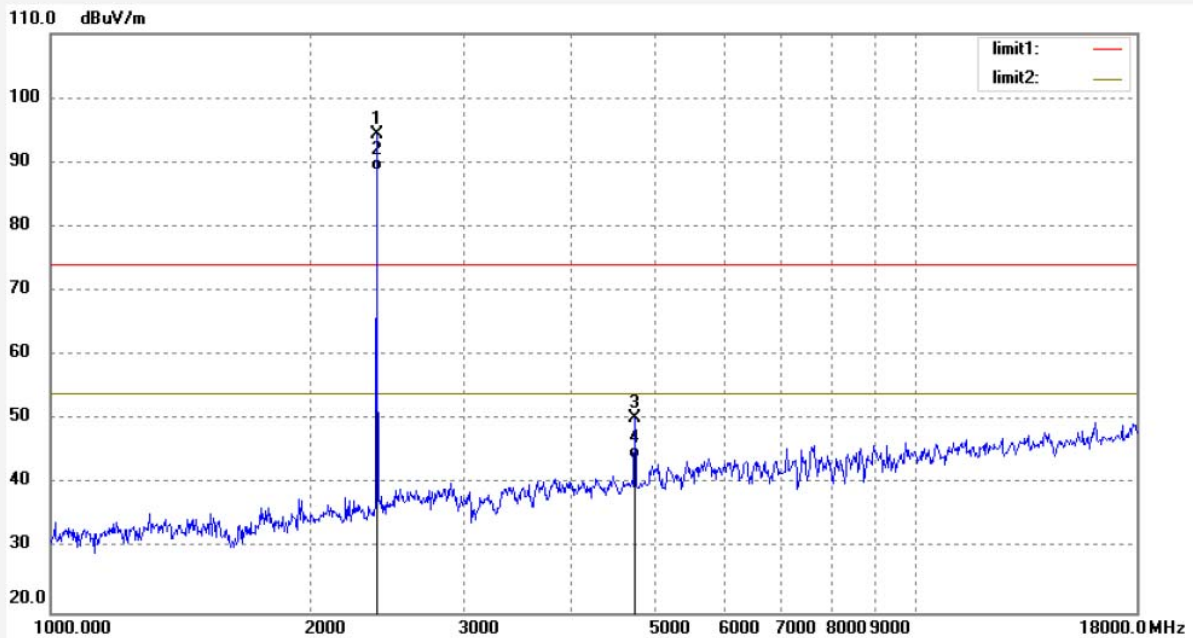

No.	Freq. (MHz)	Reading (dBuV/m)	Factor (dB)	Result (dBuV/m)	Limit (dBuV/m)	Margin (dB)	Detector	Height (cm)	Degree (deg.)	Remark
1	2402.000	98.77	-4.37	94.40			peak	250	122	
2	2402.000	93.13	-4.37	88.76			AVG	250	211	
3	4804.000	47.55	2.70	50.25	74.00	-23.75	peak	250	81	
4	4804.000	41.15	2.70	43.85	54.00	-10.15	AVG	250	247	



ACCURATE TECHNOLOGY CO., LTD.

F1,Bldg,A,Changyuan New Material Port Keyuan Rd,
Science & Industry Park,Nanshan Shenzhen,P.R.China

Site: 1# Chamber
Tel:+86-0755-26503290
Fax:+86-0755-26503396

Job No.: frank test #362	Polarization: Vertical
Standard: FCC PK	Power Source: DC 3.7V
Test item: Radiation Test	Date: 18/11/05/
Temp.(C)/Hum.(%) 25 C / 55 %	Time: 14/11/19
EUT: True Wireless Earbuds	Engineer Signature: Bob
Mode: TX2441MHz(GFSK)	Distance: 3m
Model: BE1018	
Manufacturer: Shenzhen Kinlan Technology Company Limited	

Note: Report NO.:ATE20181915

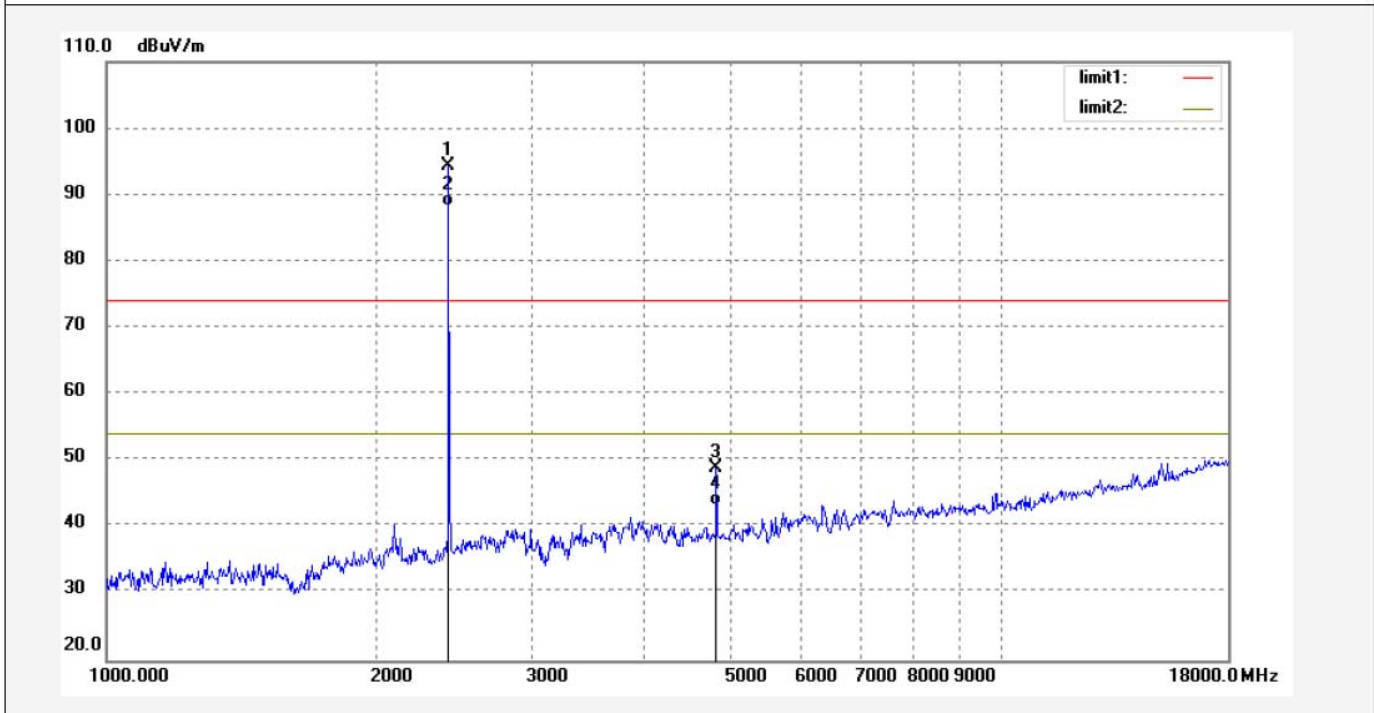

No.	Freq. (MHz)	Reading (dBuV/m)	Factor (dB)	Result (dBuV/m)	Limit (dBuV/m)	Margin (dB)	Detector	Height (cm)	Degree (deg.)	Remark
1	2441.000	98.62	-4.20	94.42			peak	250	132	
2	2441.000	92.50	-4.20	88.30			AVG	200	222	
3	4882.000	45.81	3.07	48.88	74.00	-25.12	peak	250	94	
4	4882.000	40.12	3.07	43.19	54.00	-10.81	AVG	200	201	



ACCURATE TECHNOLOGY CO., LTD.

F1,Bldg,A,Changyuan New Material Port Keyuan Rd,
Science & Industry Park,Nanshan Shenzhen,P.R.China

Site: 1# Chamber
Tel:+86-0755-26503290
Fax:+86-0755-26503396

Job No.: frank test #363
Standard: FCC PK
Test item: Radiation Test
Temp.(C)/Hum.(%) 25 C / 55 %
EUT: True Wireless Earbuds
Mode: TX2441MHz(GFSK)
Model: BE1018
Manufacturer: Shenzhen Kinlan Technology Company Limited

Polarization: Horizontal
Power Source: DC 3.7V
Date: 18/11/05/
Time: 14/16/33
Engineer Signature: Bob
Distance: 3m

Note: Report NO.:ATE20181915

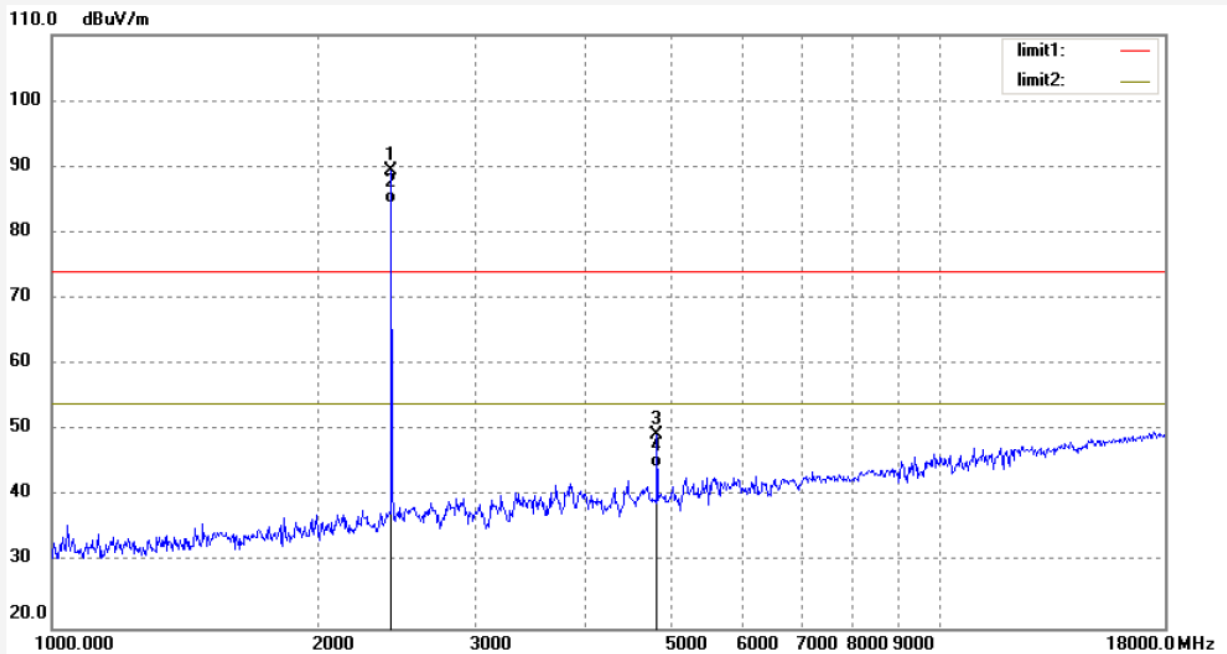

No.	Freq. (MHz)	Reading (dBuV/m)	Factor (dB)	Result (dBuV/m)	Limit (dBuV/m)	Margin (dB)	Detector	Height (cm)	Degree (deg.)	Remark
1	2441.000	93.68	-4.20	89.48			peak	200	315	
2	2441.000	88.65	-4.20	84.45			AVG	200	93	
3	4882.000	46.37	3.07	49.44	74.00	-24.56	peak	200	61	
4	4882.000	41.32	3.07	44.39	54.00	-9.61	AVG	250	109	



ACCURATE TECHNOLOGY CO., LTD.

F1,Bldg,A,Changyuan New Material Port Keyuan Rd,
Science & Industry Park,Nanshan Shenzhen,P.R.China

Site: 1# Chamber
Tel:+86-0755-26503290
Fax:+86-0755-26503396

Job No.: frank test #364	Polarization: Horizontal
Standard: FCC PK	Power Source: DC 3.7V
Test item: Radiation Test	Date: 18/11/05/
Temp.(C)/Hum.(%) 25 C / 55 %	Time: 14/21/17
EUT: True Wireless Earbuds	Engineer Signature: Bob
Mode: TX2480MHz(GFSK)	Distance: 3m
Model: BE1018	
Manufacturer: Shenzhen Kinlan Technology Company Limited	

Note: Report NO.:ATE20181915

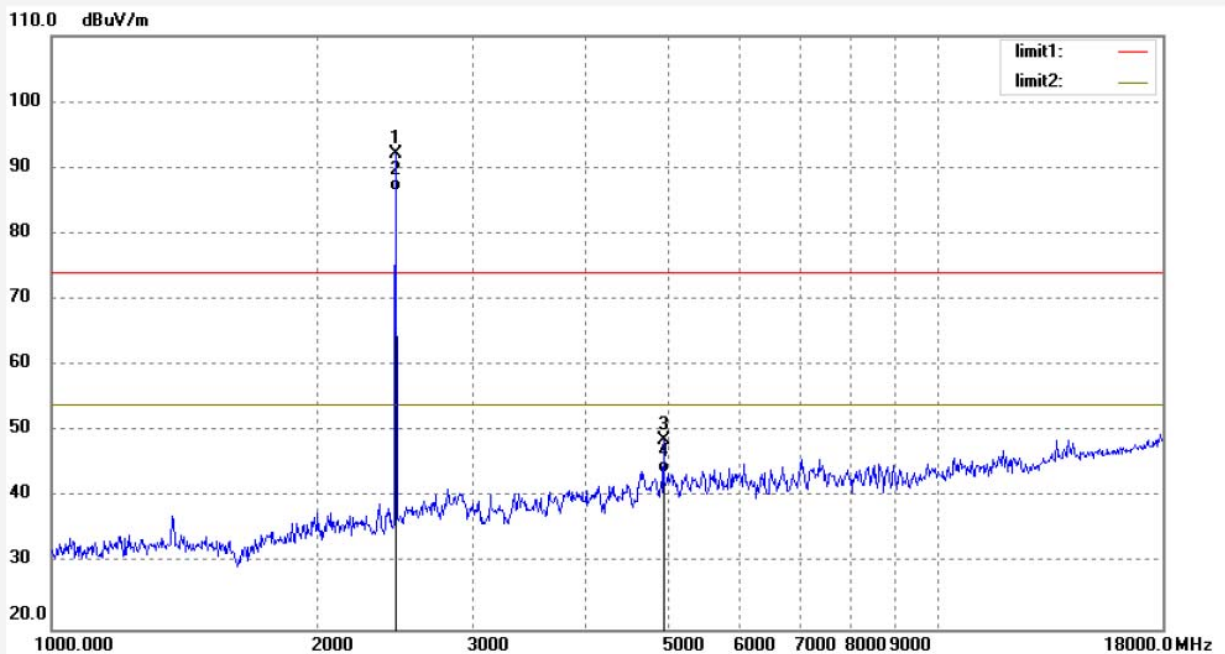

No.	Freq. (MHz)	Reading (dBuV/m)	Factor (dB)	Result (dBuV/m)	Limit (dBuV/m)	Margin (dB)	Detector	Height (cm)	Degree (deg.)	Remark
1	2480.000	96.25	-4.04	92.21			peak	200	130	
2	2480.000	90.50	-4.04	86.46			AVG	200	208	
3	4960.000	45.11	3.50	48.61	74.00	-25.39	peak	250	69	
4	4960.000	40.21	3.50	43.71	54.00	-10.29	AVG	250	341	



ACCURATE TECHNOLOGY CO., LTD.

F1,Bldg,A,Changyuan New Material Port Keyuan Rd,
Science & Industry Park,Nanshan Shenzhen,P.R.China

Site: 1# Chamber

Tel:+86-0755-26503290

Fax:+86-0755-26503396

Job No.: frank test #365
 Standard: FCC PK
 Test item: Radiation Test
 Temp.(C)/Hum.(%) 25 C / 55 %
 EUT: True Wireless Earbuds
 Mode: TX2480MHz(GFSK)
 Model: BE1018
 Manufacturer: Shenzhen Kinlan Technology Company Limited

Polarization: Vertical
 Power Source: DC 3.7V
 Date: 18/11/05/
 Time: 14/25/12
 Engineer Signature: Bob
 Distance: 3m

Note: Report NO.:ATE20181915

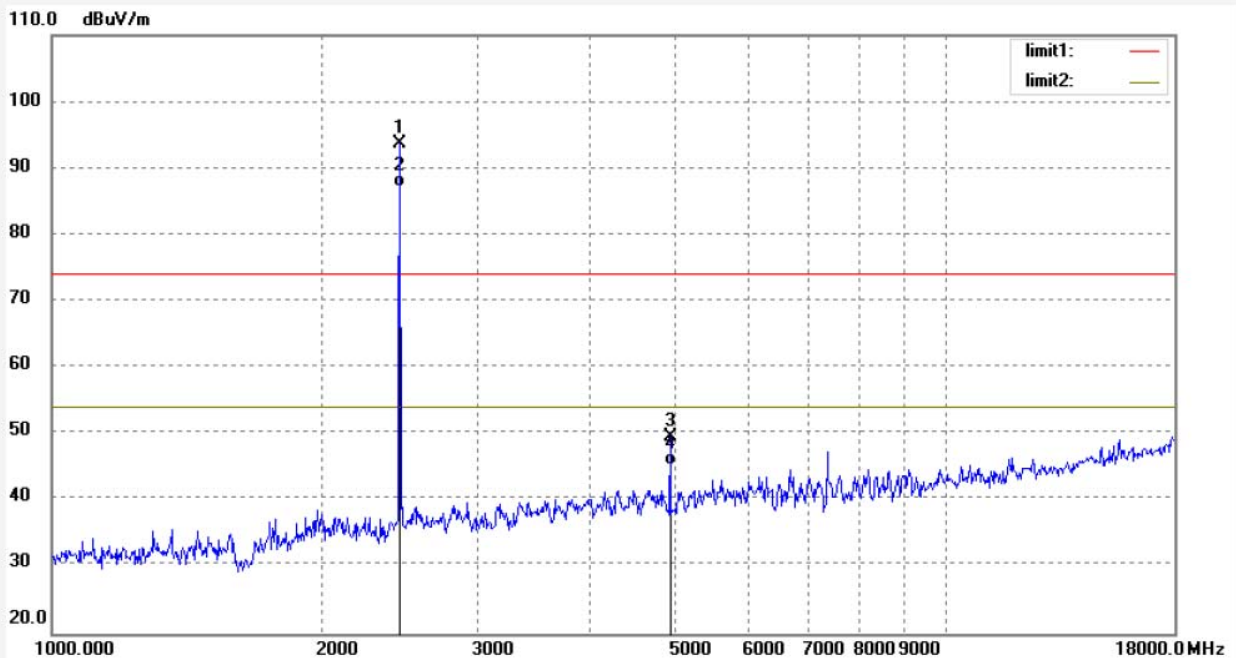

No.	Freq. (MHz)	Reading (dBuV/m)	Factor (dB)	Result (dBuV/m)	Limit (dBuV/m)	Margin (dB)	Detector	Height (cm)	Degree (deg.)	Remark
1	2480.000	97.75	-4.04	93.71			peak	250	197	
2	2480.000	91.15	-4.04	87.11			AVG	250	93	
3	4960.000	46.10	3.50	49.60	74.00	-24.40	peak	150	123	
4	4960.000	41.80	3.50	45.30	54.00	-8.70	AVG	200	48	

11. BAND EDGE COMPLIANCE TEST

11.1. Block Diagram of Test Setup

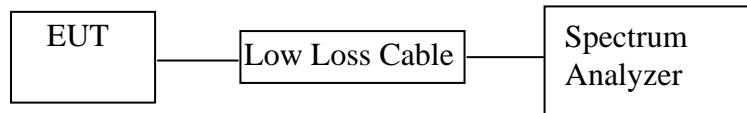

(EUT: True Wireless Earbuds)

11.2. The Requirement For Section 15.247(d)

Section 15.247(d): In any 100 kHz bandwidth outside the frequency band in which the spread spectrum or digitally modulated intentional radiator is operating, the radio frequency power that is produced by the intentional radiator shall be at least 20 dB below that in the 100 kHz bandwidth within the band that contains the highest level of the desired power, based on either an RF conducted or a radiated measurement, provided the transmitter demonstrates compliance with the peak conducted power limits. If the transmitter complies with the conducted power limits based on the use of RMS averaging over a time interval, as permitted under paragraph (b)(3) of this section, the attenuation required under this paragraph shall be 30 dB instead of 20 dB. Attenuation below the general limits specified in Section 15.209(a) is not required. In addition, radiated emissions which fall in the restricted bands, as defined in Section 15.205(a), must also comply with the radiated emission limits specified in Section 15.209(a).

11.3. EUT Configuration on Measurement

The equipment are installed on the emission Measurement to meet the commission requirements and operating regulations in a manner which tends to maximize its emission characteristics in normal application.

11.4. Operating Condition of EUT

11.4.1. Setup the EUT and simulator as shown as Section 11.1.

11.4.2. Turn on the power of all equipment.

11.4.3. Let the EUT work in TX (Hopping off, Hopping on) modes measure it. The transmit frequency are 2402-2480MHz. We select 2402MHz, 2480MHz TX frequency to transmit.

11.5. Test Procedure

11.5.1. The transmitter output was connected to the spectrum analyzer via a low loss cable.

11.5.2. Set RBW of spectrum analyzer to 100 kHz and VBW to 300 kHz with convenient frequency span including 100 kHz bandwidth from band edge.

11.5.3. The band edges was measured and recorded.

11.6. Test Result

Test Lab: Shielding room

Test Engineer: Bob

Note: Both hopping-on mode and hopping-off mode had been pre-tested, and only the worst case was recorded in the test report.

Frequency (MHz)	Result of Band Edge (dBc)	Limit of Band Edge (dBc)
GFSK Mode		
2400.00	18.99	> 20dBc
2483.50	24.65	> 20dBc
Π/4-DQPSK Mode		
2400.00	20.96	> 20dBc
2483.50	26.35	> 20dBc
8DPSK Mode		
2400.00	21.23	> 20dBc
2483.50	25.12	> 20dBc

The spectrum analyzer plots are attached as below.

GFSK Mode

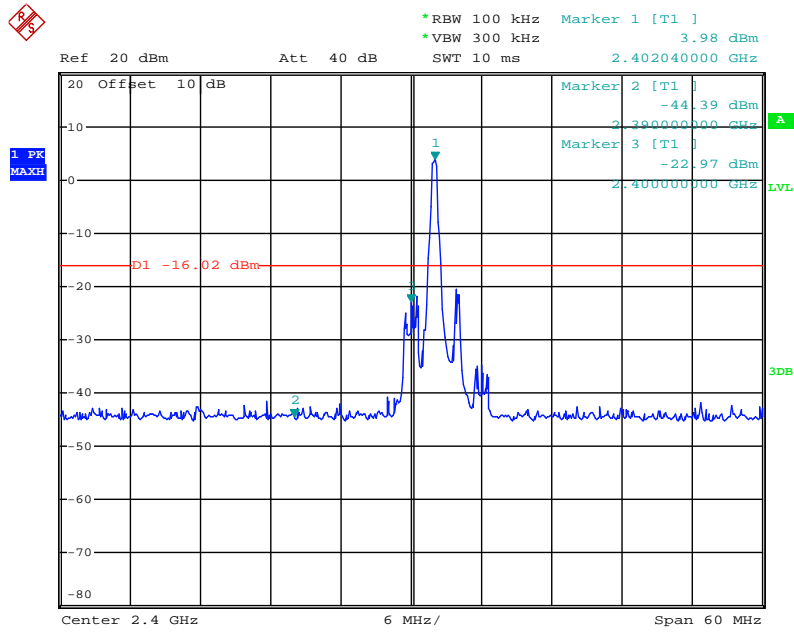

Date: 7.NOV.2018 10:48:03

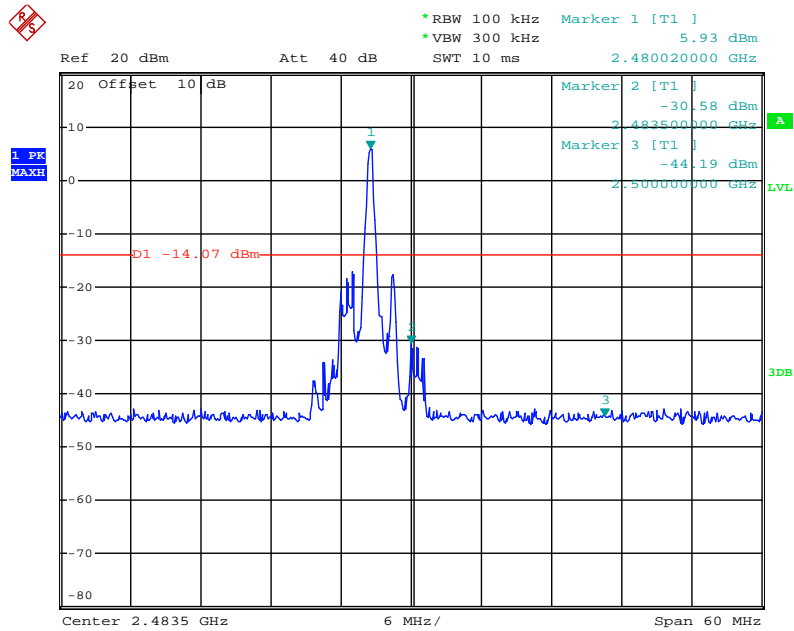

Date: 7.NOV.2018 10:47:05

Π/4-DQPSK Mode

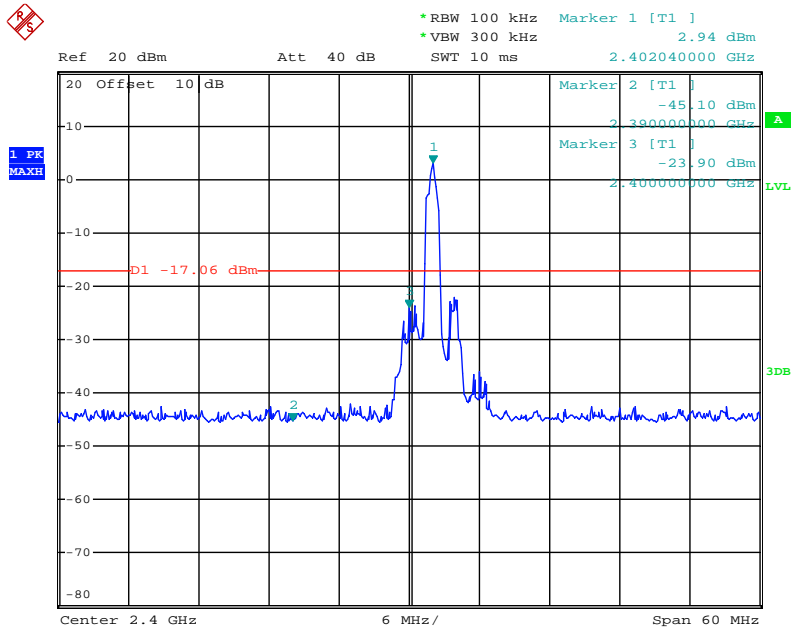

Date: 7.NOV.2018 10:48:34

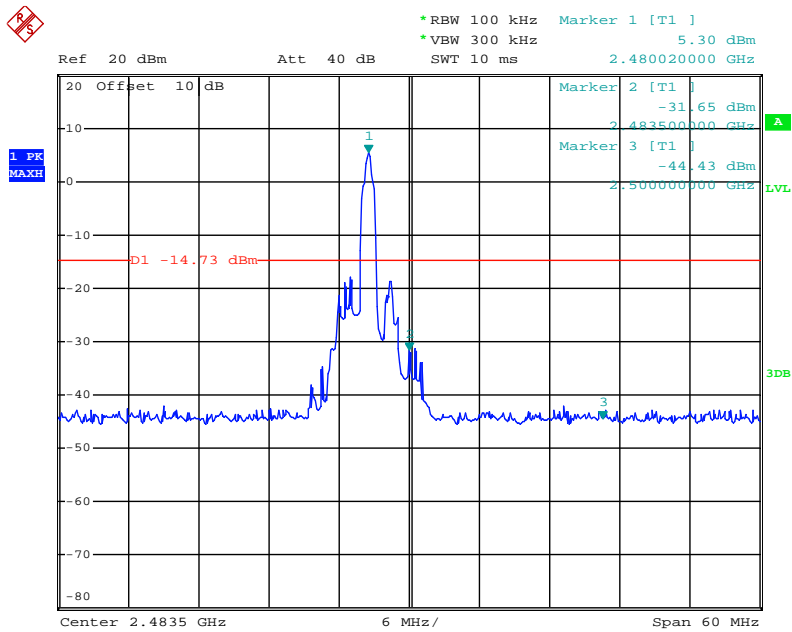

Date: 7.NOV.2018 10:46:27

8DPSK Mode

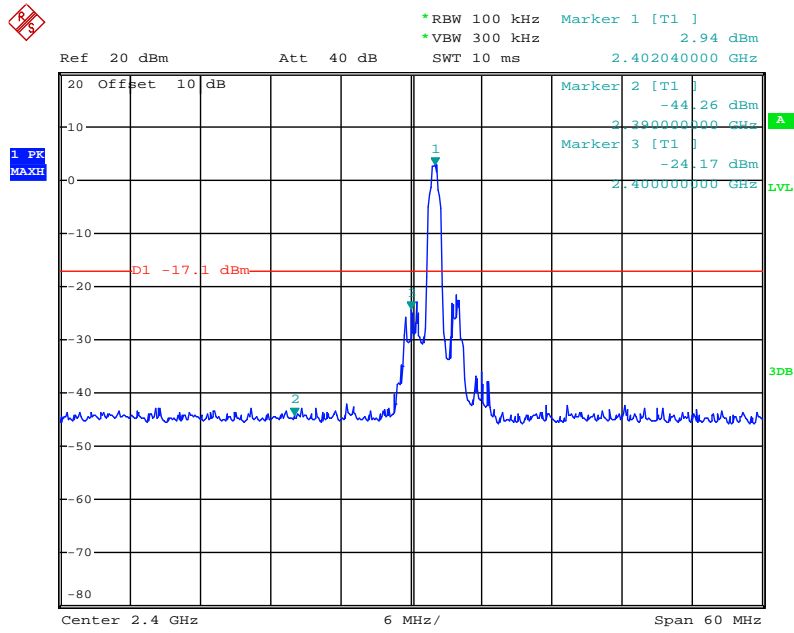

Date: 7.NOV.2018 10:49:07

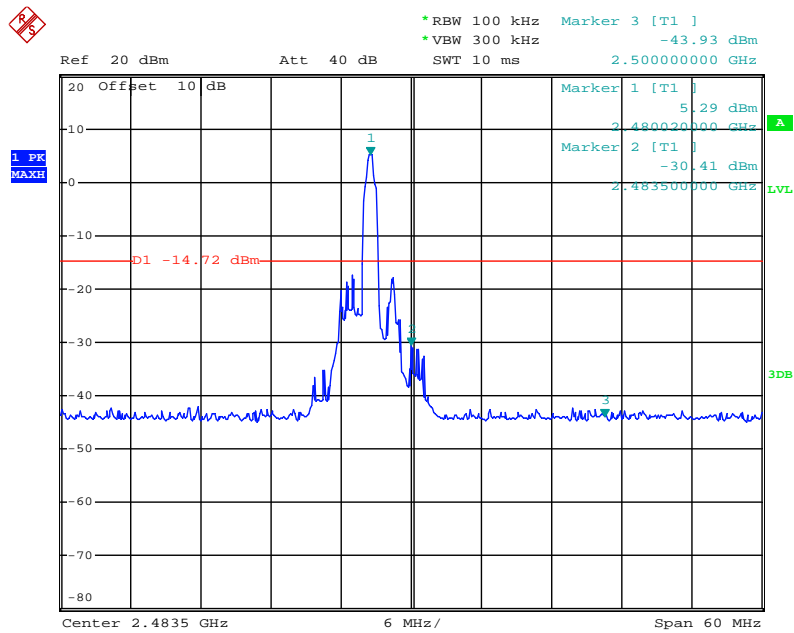

Date: 7.NOV.2018 10:45:34

Radiated Band Edge Result

Note:

1. Emissions attenuated more than 20 dB below the permissible value are not reported.
2. The field strength is calculated by adding the antenna factor, high pass filter loss(if used) and cable loss, and subtracting the amplifier gain(if any)from the measured reading. The basic equation calculation is as follows:

Result = Reading + Corrected Factor

3. Display the measurement of peak values.

Test Procedure:

The EUT and its simulators are placed on a turntable, which is 1.5 meter high above ground(Above 1GHz). The turntable can rotate 360 degrees to determine the position of the maximum emission level. EUT is set 3.0 meters away from the receiving antenna, which is mounted on an antenna tower. The antenna can be moved up and down between 1.0 meter and 4 meters to find out the maximum emission level. Broadband antenna (calibrated bi-log antenna) is used as receiving antenna. Both horizontal and vertical polarizations of the antenna are set on measurement. In order to find the maximum emission levels, all of the EUT location must be manipulated according to ANSI C63.10:2013 on radiated emission measurement. The EUT was tested in 3 orthogonal planes.

Let the EUT work in TX (Hopping off, Hopping on) modes measure it.
We select 2402MHz, 2480MHz TX frequency to transmit(Hopping off mode).
We select 2402-2480MHz TX frequency to transmit(Hopping on mode).

During the radiated emission test, the spectrum analyzer was set with the following configurations:

- 1.The resolution bandwidth of test receiver/spectrum analyzer is 1MHz and video bandwidth is 3MHz for peak measurement with peak detector at frequency above 1GHz.
- 2.The resolution bandwidth of test receiver/spectrum analyzer is 1MHz and video bandwidth is 10Hz for Average measurement with peak detection at frequency above 1GHz.
- 3.All modes of operation were investigated and the worst case (GFSK mode) emissions are reported.

Test Lab: 3m Anechoic chamber

Test Engineer: Bob

Non-hopping mode



ACCURATE TECHNOLOGY CO., LTD.

F1,Bldg,A,Changyuan New Material Port Keyuan Rd,
Science & Industry Park,Nanshan Shenzhen,P.R.China

Site: 1# Chamber
Tel:+86-0755-26503290
Fax:+86-0755-26503396

Job No.: frank test #382	Polarization: Vertical
Standard: FCC PK	Power Source: DC 3.7V
Test item: Radiation Test	Date: 18/11/05/
Temp.(C)/Hum.(%) 25 C / 55 %	Time: 16/11/35
EUT: True Wireless Earbuds	Engineer Signature: Bob
Mode: TX2402MHz(GFSK)	Distance: 3m
Model: BE1018	
Manufacturer: Shenzhen Kinlan Technology Company Limited	

Note: Report NO.:ATE20181915

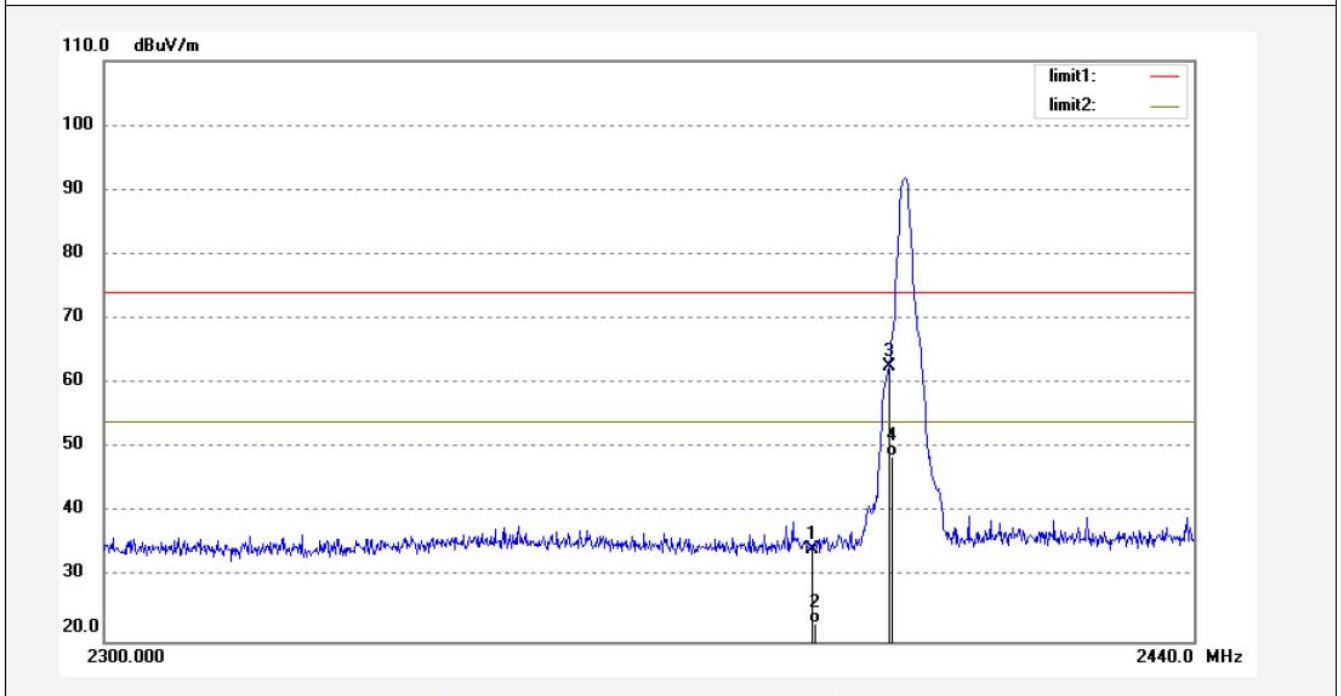

No.	Freq. (MHz)	Reading (dBuV/m)	Factor (dB)	Result (dBuV/m)	Limit (dBuV/m)	Margin (dB)	Detector	Height (cm)	Degree (deg.)	Remark
1	2390.000	38.70	-4.32	34.38	74.00	-39.62	peak	250	132	
2	2390.000	27.15	-4.32	22.83	54.00	-31.17	AVG	250	97	
3	2400.000	66.96	-4.27	62.69	74.00	-11.31	peak	250	45	
4	2400.000	53.00	-4.27	48.73	54.00	-5.27	AVG	250	102	

Note: Average measurement with peak detection at No.2&4



ACCURATE TECHNOLOGY CO., LTD.

F1,Bldg,A,Changyuan New Material Port Keyuan Rd,
Science & Industry Park,Nanshan Shenzhen,P.R.China

Site: 1# Chamber
Tel:+86-0755-26503290
Fax:+86-0755-26503396

Job No.: frank test #384	Polarization: Horizontal
Standard: FCC PK	Power Source: DC 3.7V
Test item: Radiation Test	Date: 18/11/05/
Temp.(C)/Hum.(%) 25 C / 55 %	Time: 16/15/28
EUT: True Wireless Earbuds	Engineer Signature: Bob
Mode: TX2402MHz(GFSK)	Distance: 3m
Model: BE1018	
Manufacturer: Shenzhen Kinlan Technology Company Limited	

Note: Report NO.:ATE20181915

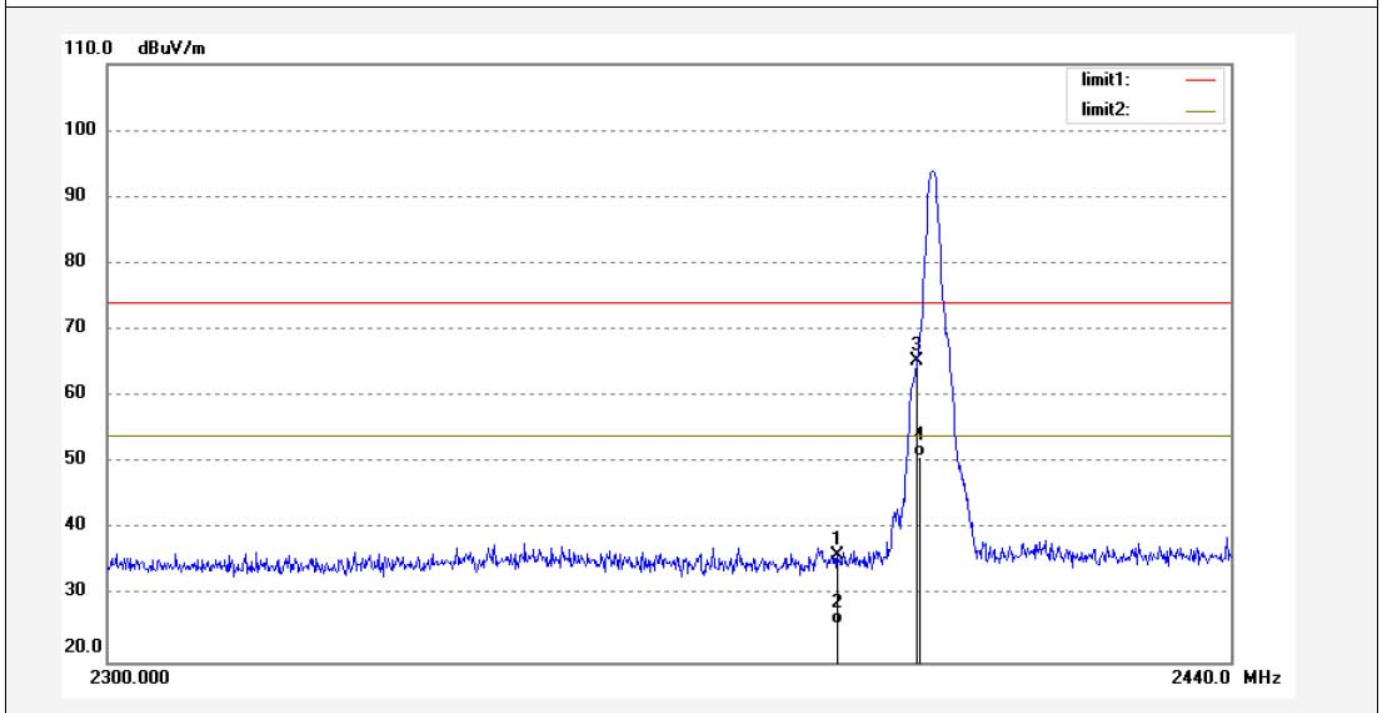

No.	Freq. (MHz)	Reading (dBuV/m)	Factor (dB)	Result (dBuV/m)	Limit (dBuV/m)	Margin (dB)	Detector	Height (cm)	Degree (deg.)	Remark
1	2390.000	40.31	-4.32	35.99	74.00	-38.01	peak	250	132	
2	2390.000	30.12	-4.32	25.80	54.00	-28.20	AVG	250	185	
3	2400.000	69.53	-4.27	65.26	74.00	-8.74	peak	250	58	
4	2400.000	55.15	-4.27	50.88	54.00	-3.12	AVG	250	241	

Note: Average measurement with peak detection at No.2&4



ACCURATE TECHNOLOGY CO., LTD.

F1,Bldg,A,Changyuan New Material Port Keyuan Rd,
Science & Industry Park,Nanshan Shenzhen,P.R.China

Site: 1# Chamber
Tel:+86-0755-26503290
Fax:+86-0755-26503396

Job No.: frank test #385	Polarization: Horizontal
Standard: FCC PK	Power Source: DC 3.7V
Test item: Radiation Test	Date: 18/11/05/
Temp.(C)/Hum.(%) 25 C / 55 %	Time: 16/20/51
EUT: True Wireless Earbuds	Engineer Signature: Bob
Mode: TX2480MHz(GFSK)	Distance: 3m
Model: BE1018	
Manufacturer: Shenzhen Kinlan Technology Company Limited	

Note: Report NO.:ATE20181915

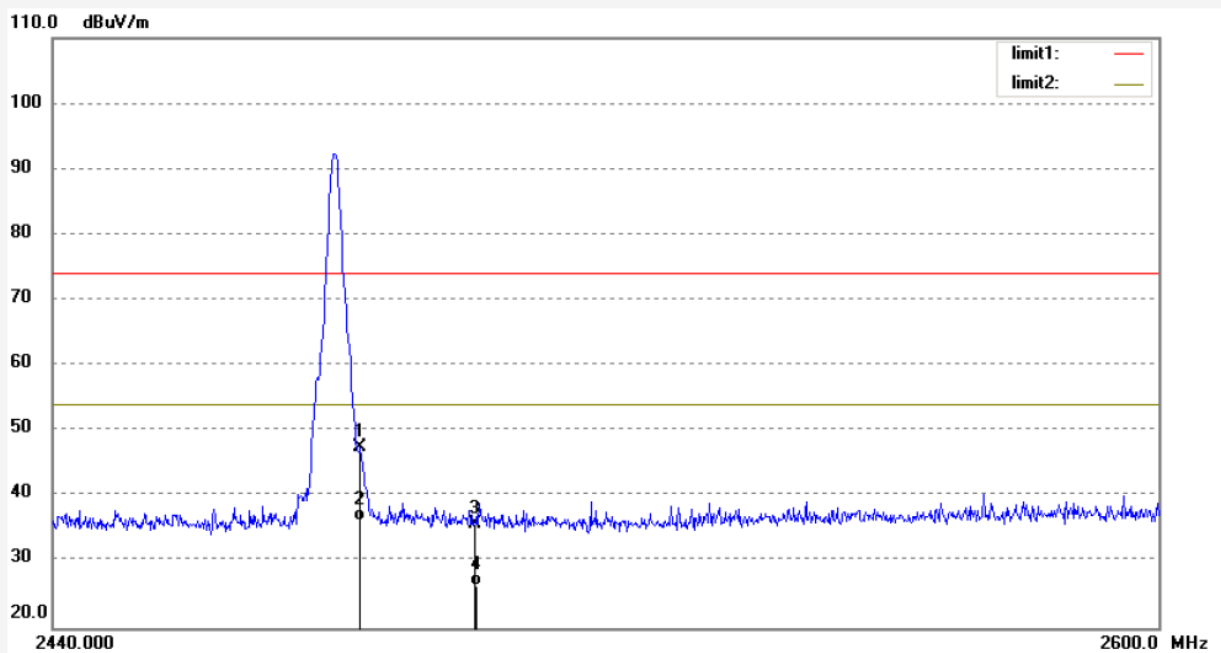

No.	Freq. (MHz)	Reading (dBuV/m)	Factor (dB)	Result (dBuV/m)	Limit (dBuV/m)	Margin (dB)	Detector	Height (cm)	Degree (deg.)	Remark
1	2483.500	51.44	-3.89	47.55	74.00	-26.45	peak	250	194	
2	2483.500	40.30	-3.89	36.41	54.00	-17.59	AVG	250	259	
3	2500.000	39.66	-3.81	35.85	74.00	-38.15	peak	250	94	
4	2500.000	30.12	-3.81	26.31	54.00	-27.69	AVG	250	267	

Note: Average measurement with peak detection at No.2&4



ACCURATE TECHNOLOGY CO., LTD.

F1,Bldg,A,Changyuan New Material Port Keyuan Rd,
Science & Industry Park,Nanshan Shenzhen,P.R.China

Site: 1# Chamber
Tel:+86-0755-26503290
Fax:+86-0755-26503396

Job No.: frank test #386	Polarization: Vertical
Standard: FCC PK	Power Source: DC 3.7V
Test item: Radiation Test	Date: 18/11/05/
Temp.(C)/Hum.(%) 25 C / 55 %	Time: 16/24/56
EUT: True Wireless Earbuds	Engineer Signature: Bob
Mode: TX2480MHz(GFSK)	Distance: 3m
Model: BE1018	
Manufacturer: Shenzhen Kinlan Technology Company Limited	

Note: Report NO.:ATE20181915

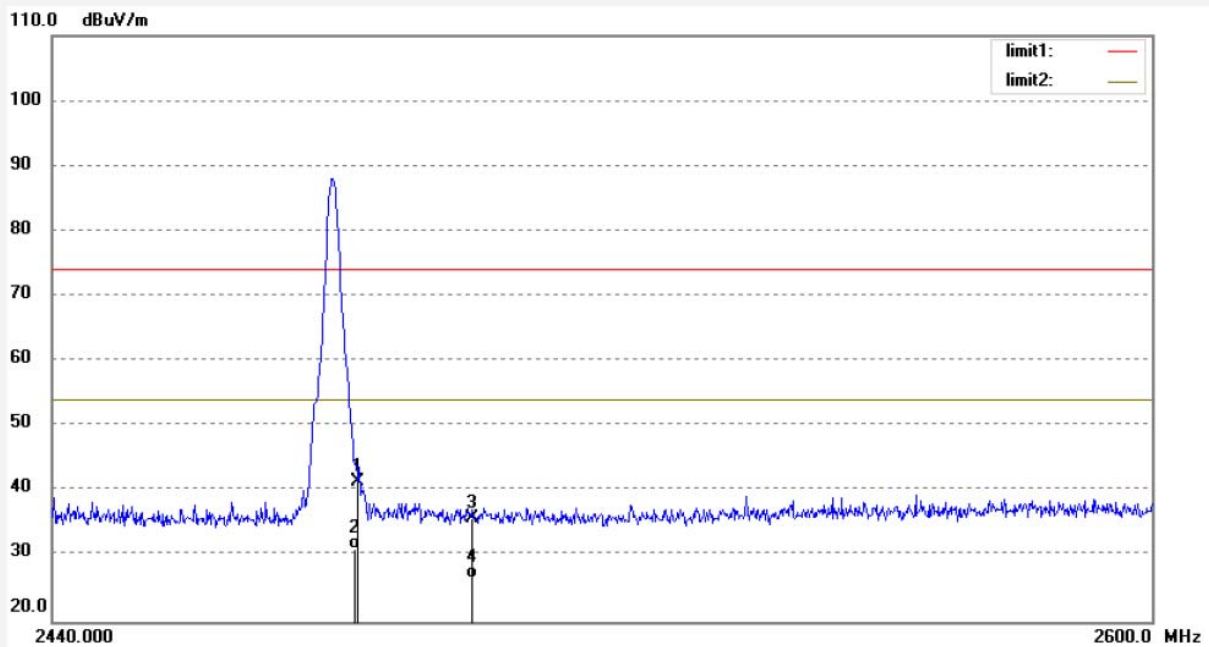

No.	Freq. (MHz)	Reading (dBuV/m)	Factor (dB)	Result (dBuV/m)	Limit (dBuV/m)	Margin (dB)	Detector	Height (cm)	Degree (deg.)	Remark
1	2483.500	45.27	-3.89	41.38	74.00	-32.62	peak	250	121	
2	2483.500	35.12	-3.89	31.23	54.00	-22.77	AVG	250	321	
3	2500.000	39.66	-3.81	35.85	74.00	-38.15	peak	250	94	
4	2500.000	30.45	-3.81	26.64	54.00	-27.36	AVG	250	204	

Note: Average measurement with peak detection at No.2&4

Hopping mode



ACCURATE TECHNOLOGY CO., LTD.

F1,Bldg,A,Changyuan New Material Port Keyuan Rd,
Science & Industry Park,Nanshan Shenzhen,P.R.China

Site: 1# Chamber
Tel:+86-0755-26503290
Fax:+86-0755-26503396

Job No.: frank test #391	Polarization: Vertical
Standard: FCC PK	Power Source: DC 3.7V
Test item: Radiation Test	Date: 18/11/05/
Temp.(C)/Hum.(%) 25 C / 55 %	Time: 16/45/55
EUT: True Wireless Earbuds	Engineer Signature: Bob
Mode: HOPPING(GFSK)	Distance: 3m
Model: BE1018	
Manufacturer: Shenzhen Kinlan Technology Company Limited	

Note: Report NO.:ATE20181915

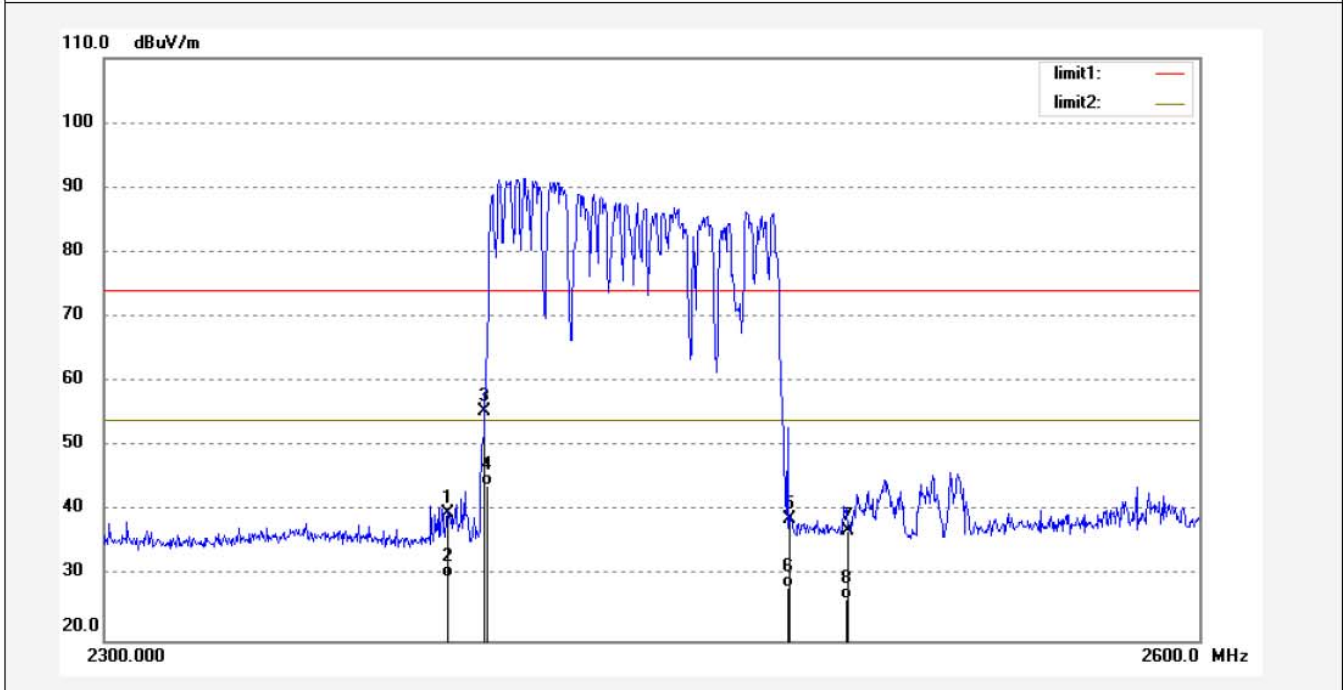

No.	Freq. (MHz)	Reading (dBuV/m)	Factor (dB)	Result (dBuV/m)	Limit (dBuV/m)	Margin (dB)	Detector	Height (cm)	Degree (deg.)	Remark
1	2390.000	43.95	-4.32	39.63	74.00	-34.37	peak	250	121	
2	2390.000	34.12	-4.32	29.80	54.00	-24.20	AVG	250	13	
3	2400.000	59.68	-4.27	55.41	74.00	-18.59	peak	250	101	
4	2400.000	48.15	-4.27	43.88	54.00	-10.12	AVG	200	127	
5	2483.500	42.62	-3.89	38.73	74.00	-35.27	peak	200	195	
6	2483.500	32.15	-3.89	28.26	54.00	-25.74	AVG	200	125	
7	2500.000	40.83	-3.81	37.02	74.00	-36.98	peak	200	111	
8	2500.000	30.12	-3.81	26.31	54.00	-27.69	AVG	250	320	

Note: Average measurement with peak detection at No.2&4&6&8



ACCURATE TECHNOLOGY CO., LTD.

F1,Bldg,A,Changyuan New Material Port Keyuan Rd,
Science & Industry Park,Nanshan Shenzhen,P.R.China

Site: 1# Chamber
Tel:+86-0755-26503290
Fax:+86-0755-26503396

Job No.: frank test #392	Polarization: Horizontal
Standard: FCC PK	Power Source: DC 3.7V
Test item: Radiation Test	Date: 18/11/05/
Temp.(C)/Hum.(%) 25 C / 55 %	Time: 16/50/13
EUT: True Wireless Earbuds	Engineer Signature: Bob
Mode: HOPPING(GFSK)	Distance: 3m
Model: BE1018	
Manufacturer: Shenzhen Kinlan Technology Company Limited	

Note: Report NO.:ATE20181915

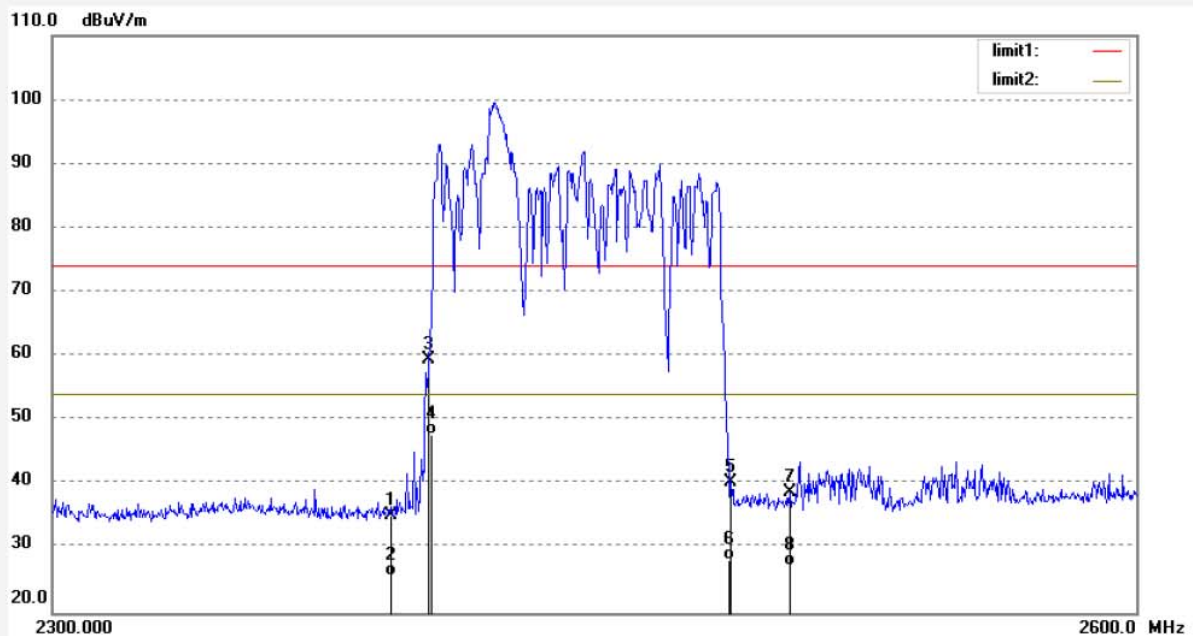

No.	Freq. (MHz)	Reading (dBuV/m)	Factor (dB)	Result (dBuV/m)	Limit (dBuV/m)	Margin (dB)	Detector	Height (cm)	Degree (deg.)	Remark
1	2390.000	39.40	-4.32	35.08	74.00	-38.92	peak	200	138	
2	2390.000	30.12	-4.32	25.80	54.00	-28.20	AVG	200	94	
3	2400.000	63.70	-4.27	59.43	74.00	-14.57	peak	200	251	
4	2400.000	52.12	-4.27	47.85	54.00	-6.15	AVG	200	103	
5	2483.500	44.19	-3.89	40.30	74.00	-33.70	peak	250	158	
6	2483.500	32.12	-3.89	28.23	54.00	-25.77	AVG	250	149	
7	2500.000	42.57	-3.81	38.76	74.00	-35.24	peak	250	201	
8	2500.000	31.15	-3.81	27.34	54.00	-26.66	AVG	200	321	

Note: Average measurement with peak detection at No.2&4&6&8

12.AC POWER LINE CONDUCTED EMISSION FOR FCC PART

15 SECTION 15.207(A)

12.1.Block Diagram of Test Setup

12.1.1.Block diagram of connection between the EUT and simulators

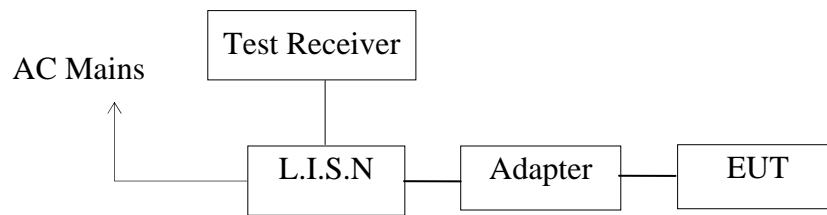

(EUT: True Wireless Earbuds)

12.1.2.Test System Setup

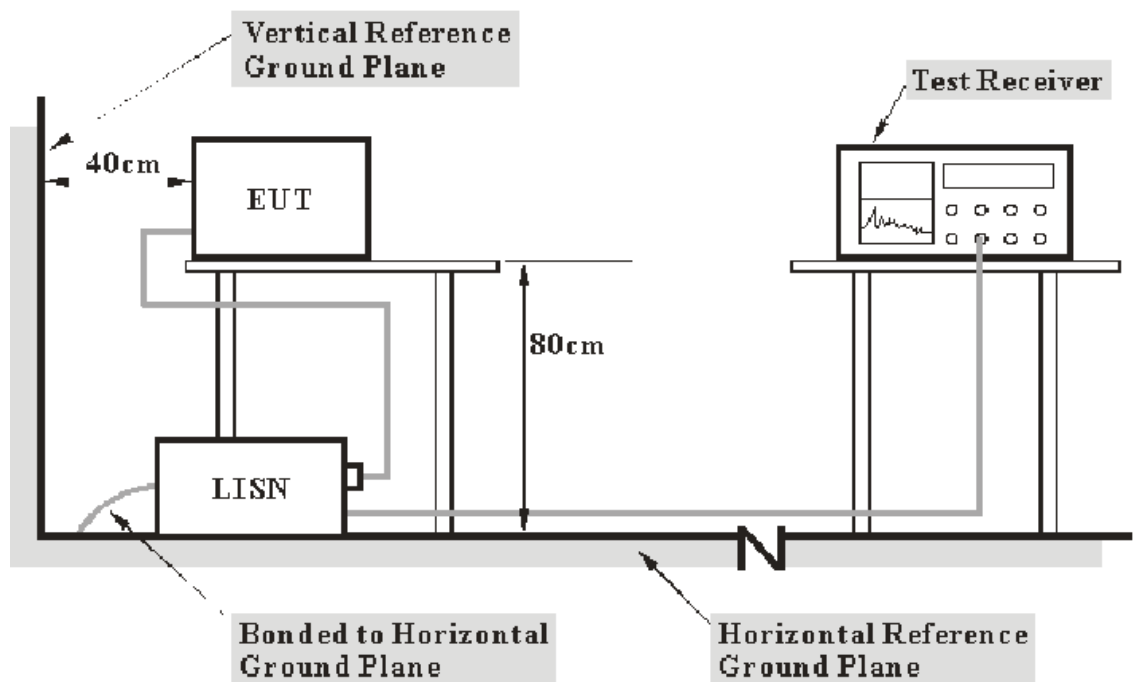

- Note: 1. Support units were connected to second LISN.
2. Both of LISNs (AMN) 80 cm from EUT and at the least 80 cm from other units and other metal planes support units.

12.2. Power Line Conducted Emission Measurement Limits

Frequency (MHz)	Limit dB(μV)	
	Quasi-peak Level	Average Level
0.15 - 0.50	66.0 – 56.0 *	56.0 – 46.0 *
0.50 - 5.00	56.0	46.0
5.00 - 30.00	60.0	50.0

NOTE1: The lower limit shall apply at the transition frequencies.
 NOTE2: The limit decreases linearly with the logarithm of the frequency in the range 0.15MHz to 0.50MHz.

12.3. Configuration of EUT on Measurement

The equipments are installed on Power Line Conducted Emission Measurement to meet the commission requirement and operating regulations in a manner, which tends to maximize its emission characteristics in a normal application.

12.4. Operating Condition of EUT

12.4.1. Setup the EUT and simulator as shown as Section 12.1.

12.4.2. Turn on the power of all equipment.

12.4.3. Let the EUT work in test mode and measure it.

12.5. Test Procedure

The EUT is put on the plane 0.8m high above the ground by insulating support and is connected to the power mains through a line impedance stabilization network (L.I.S.N.). This provides a 50ohm coupling impedance for the EUT system. Please refer the block diagram of the test setup and photographs. Both sides of AC lines are checked to find out the maximum conducted emission. In order to find the maximum emission levels, the relative positions of equipment and all of the interface cables shall be changed according to ANSI C63.10: 2013 on Conducted Emission Measurement. The bandwidth of test receiver (R & S ESCS30) is set at 9kHz.

The frequency range from 150kHz to 30MHz is checked.

12.6.Data Sample

Frequency (MHz)	Transducer value (dB)	QuasiPeak Level (dBμV)	Average Level (dBμV)	QuasiPeak Limit (dBμV)	Average Limit (dBμV)	QuasiPeak Margin (dB)	Average Margin (dB)	Remark (Pass/Fail)
X.XX	10.5	51.1	34.2	56.0	46.0	4.9	11.8	Pass

Frequency(MHz) = Emission frequency in MHz

Transducer value(dB) = Insertion loss of LISN + Cable Loss

Level(dBμV) = Quasi-peak Reading/Average Reading + Transducer value

Limit (dBμV) = Limit stated in standard

Margin = Limit (dBμV) - Level (dBμV)

Calculation Formula:

Margin = Limit (dBμV) - Level (dBμV)

12.7.Power Line Conducted Emission Measurement Results

PASS.

Test Lab: Shielding room

Test Engineer: Bob

The frequency range from 150kHz to 30MHz is checked.

Maximizing procedure was performed on the six (6) highest emissions of the EUT. Emissions attenuated more than 20 dB below the permissible value are not reported.

All data was recorded in the Quasi-peak and average detection mode.

The spectral diagrams are attached as below.

ACCURATE TECHNOLOGY CO., LTD

CONDUCTED EMISSION STANDARD FCC PART15B

EUT: True Wireless Earbuds M/N:BE1018
 Manufacturer: Shenzhen Kinlan Technology Company Limited
 Operating Condition: Charging and operating
 Test Site: 2#Shielding Room
 Operator: Bob
 Test Specification: L 120V/60Hz
 Comment: Report No.: ATE20181915
 Start of Test: 2018-11-2 / 9:18:07

SCAN TABLE: "V 150K-30MHz fin"

Short Description: _SUB_STD_VTERM2 1.70
 Start Stop Step Detector Meas. IF Transducer
 Frequency Frequency Width Time Bandw.
 150.0 kHz 30.0 MHz 4.5 kHz QuasiPeak 1.0 s 9 kHz NSLK8126 2008
 Average

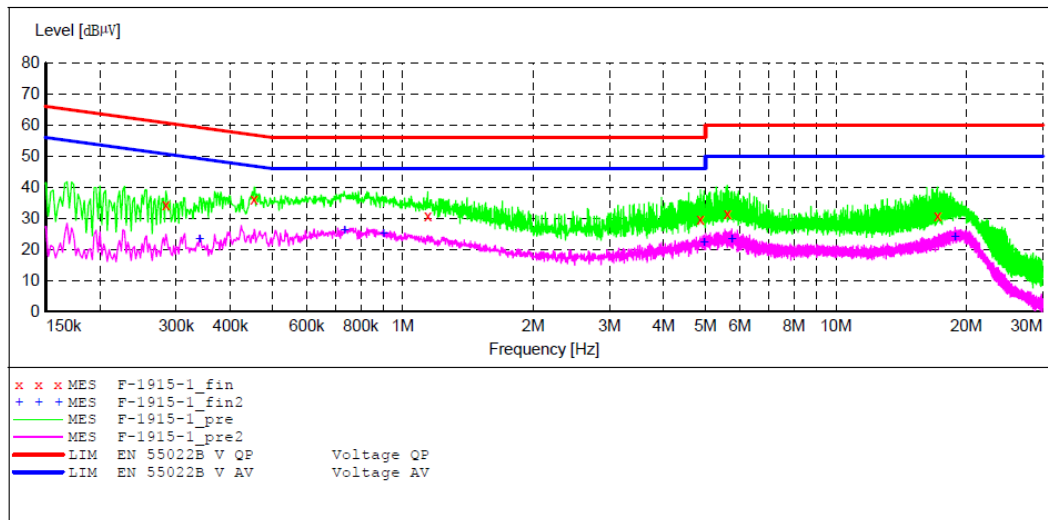

MEASUREMENT RESULT: "F-1915-1_fin"

2018-11-2 9:19

Frequency MHz	Level dBµV	Transd dB	Limit dBµV	Margin dB	Detector	Line	PE
0.284000	34.50	10.9	61	26.2	QP	L1	GND
0.454000	36.30	11.0	57	20.5	QP	L1	GND
1.142000	30.70	11.2	56	25.3	QP	L1	GND
4.865000	29.80	11.4	56	26.2	QP	L1	GND
5.610000	31.50	11.5	60	28.5	QP	L1	GND
17.165000	30.70	11.7	60	29.3	QP	L1	GND

MEASUREMENT RESULT: "F-1915-1_fin2"

2018-11-2 9:19

Frequency MHz	Level dBµV	Transd dB	Limit dBµV	Margin dB	Detector	Line	PE
0.340000	23.50	10.9	49	25.7	AV	L1	GND
0.734000	26.40	11.1	46	19.6	AV	L1	GND
0.902000	25.20	11.1	46	20.8	AV	L1	GND
4.960000	22.20	11.4	46	23.8	AV	L1	GND
5.745000	23.50	11.5	50	26.5	AV	L1	GND
18.830000	24.10	11.7	50	25.9	AV	L1	GND

ACCURATE TECHNOLOGY CO., LTD

CONDUCTED EMISSION STANDARD FCC PART15B

EUT: True Wireless Earbuds M/N:BE1018
 Manufacturer: Shenzhen Kinlan Technology Company Limited
 Operating Condition: Charging and operating
 Test Site: 2#Shielding Room
 Operator: Bob
 Test Specification: N 120V/60Hz
 Comment: Report No.: ATE20181915
 Start of Test: 2018-11-2 / 9:20:17

SCAN TABLE: "V 150K-30MHz fin"

Short Description: _SUB_STD_VTERM2 1.70
 Start Stop Step Detector Meas. IF Transducer
 Frequency Frequency Width Time Bandw.
 150.0 kHz 30.0 MHz 4.5 kHz QuasiPeak 1.0 s 9 kHz NSLK8126 2008
 Average

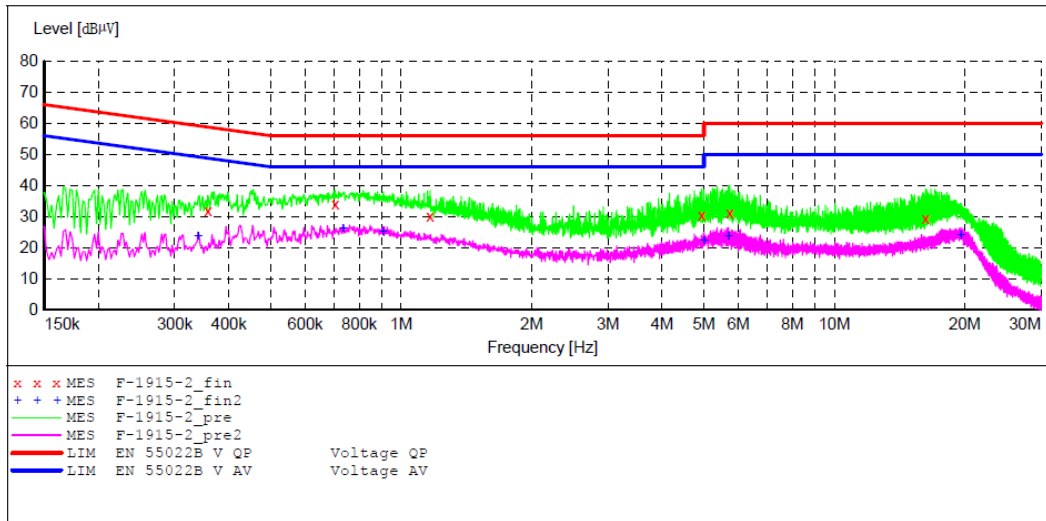

MEASUREMENT RESULT: "F-1915-2_fin"

2018-11-2 9:22

Frequency MHz	Level dBµV	Transd dB	Limit dBµV	Margin dB	Detector	Line	PE
0.358000	31.80	10.9	59	27.0	QP	N	GND
0.704000	34.20	11.1	56	21.8	QP	N	GND
1.166000	30.30	11.2	56	25.7	QP	N	GND
4.935000	30.50	11.4	56	25.5	QP	N	GND
5.735000	31.10	11.5	60	28.9	QP	N	GND
16.250000	29.40	11.7	60	30.6	QP	N	GND

MEASUREMENT RESULT: "F-1915-2_fin2"

2018-11-2 9:22

Frequency MHz	Level dBµV	Transd dB	Limit dBµV	Margin dB	Detector	Line	PE
0.340000	23.70	10.9	49	25.5	AV	N	GND
0.734000	26.40	11.1	46	19.6	AV	N	GND
0.908000	25.20	11.1	46	20.8	AV	N	GND
5.000000	22.20	11.4	46	23.8	AV	N	GND
5.695000	23.60	11.5	50	26.4	AV	N	GND
19.600000	24.10	11.7	50	25.9	AV	N	GND

13. ANTENNA REQUIREMENT

13.1. The Requirement

According to Section 15.203, an intentional radiator shall be designed to ensure that no antenna other than that furnished by the responsible party shall be used with the device.

13.2. Antenna Construction

Device is equipped with permanent attached antenna, which isn't displaced by other antenna. The Max Antenna gain of EUT is -1dBi. Therefore, the equipment complies with the antenna requirement of Section 15.203.

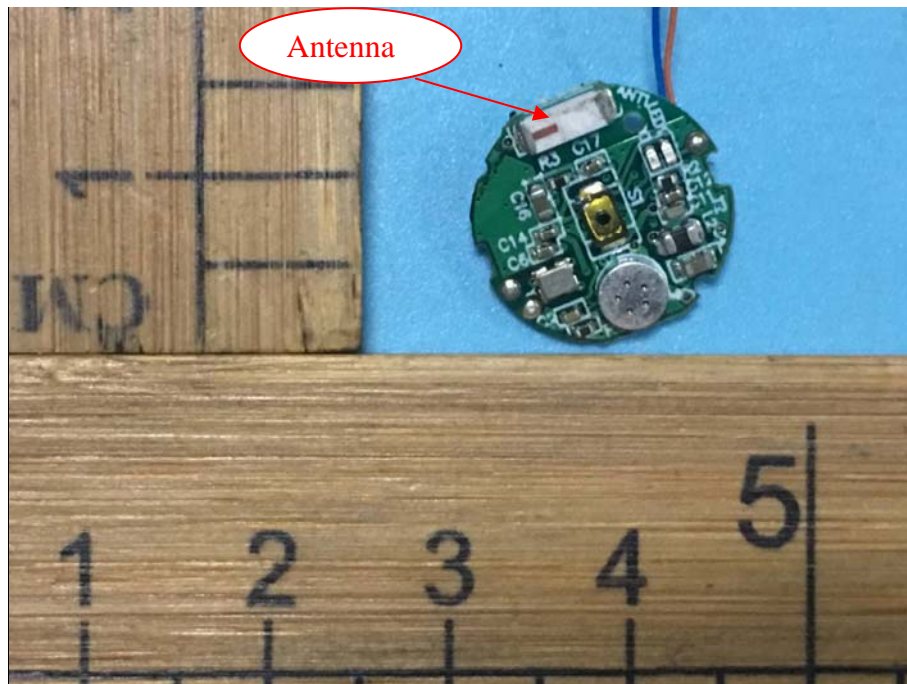

***** End of Test Report *****