

FCC PART 15E DFS TEST REPORT FOR CERTIFICATION
On Behalf of

Chunghsin Technology Group CO.,LTD

10.1" Android Tablet

Model Number: ONA19TB003

FCC ID: 2AE2WT1015M



Prepared for:	Chunghsin Technology Group CO.,LTD
	No. 618-2 GONGREN WEST ROAD, JIAOJIANG AREA, TAIZHOU CITY,
	ZHEJIANG, CHINA
Prepared By:	EST Technology Co., Ltd.
	Chilingxiang, Qishantou, Santun, Houjie, Dongguan, Guangdong, China
	Tel: 86-769-83081888-808

Report Number:	ESTE-R1901048
Date of Test:	Dec. 11, 2018~Jan. 17, 2019
Date of Report:	Jan. 17, 2019

TABLE OF CONTENTS

Description	Page
TEST REPORT VERIFICATION	3
1. GENERAL INFORMATION.....	4
1.1. Description of Device (EUT)	4
2. SUMMARY OF TEST	6
2.1. Test methodology.....	6
2.2. Summary of test result.....	6
2.3. Test Facilities.....	7
2.4. Measurement uncertainty	8
2.5. Assistant equipment used for test.....	8
2.6. Test mode	9
2.7. Test Equipment.....	9
3. SETUP OF EQUIPMENT UNDER TEST	10
3.1. Setup Configuration Of EUT.....	10
3.2. Setup Configuration Of TS8997.....	11
4. DYNAMIC FREQUENCY SELECTION REQUIREMENTS	12
4.1. Applicable standard	12
4.2. Operation Modes and Requirement Test Item.....	12
4.3. Conformance Limit	13
4.4. Transmitter Output Power	15
4.5. Operation Modes and Requirement Test Item.....	15
4.6. Test Result	16
5. TEST SETUP PHOTOS	40
6. PHOTOS OF EUT	41

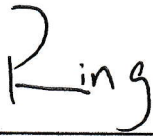
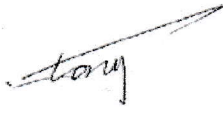
EST Technology Co., Ltd.

Applicant:	Chunghsin Technology Group CO.,LTD	
Address:	No. 618-2 GONGREN WEST ROAD, JIAOJIANG AREA, TAIZHOU CITY, ZHEJIANG, CHINA	
Manufacturer:	Chunghsin Technology Group CO.,LTD	
Address:	No. 618-2 GONGREN WEST ROAD, JIAOJIANG AREA, TAIZHOU CITY, ZHEJIANG, CHINA	
E.U.T:	10.1" Android Tablet	
Model Number:	ONA19TB003	
Power Supply:	DC 5V From Adapter Input AC 100~240V, 50/60Hz, 0.3A DC 3.7V From battery	
Test Voltage:	DC 5V From Adapter Input AC 120V/60Hz, 0.3A DC 5V From Adapter Input AC 240V/50Hz, 0.3A	
Trade Name:	onn	Serial No.: -----
Date of Receipt:	Dec. 11, 2018	Date of Test: Dec. 11, 2018~Jan. 17, 2019
Test Specification:	FCC Rules and Regulations Part 15 Subpart E:2018 ANSI C63.10:2013	
Test Result:	<p>The device described above is tested by EST Technology Co., Ltd. The measurement results were contained in this test report and EST Technology Co., Ltd. was assumed full responsibility for the accuracy and completeness of these measurements. Also, this report shows that the EUT to be technically compliance with the FCC Rules and Regulations Part 15 Subpart E requirements.</p> <p style="text-align: center;">This report applies to above tested sample only and shall not be reproduced in part without written approval of EST Technology Co., Ltd.</p> <p style="text-align: right;">Date: Jan. 17, 2019</p>	
Prepared by:	Reviewed by:	Approved by:
 <hr/> Ring / Assistant	 <hr/> Tony / Engineer	 <hr/> Iceman Hu / Manager
Other Aspects:	None.	
Abbreviations: OK/P=passed fail/F=failed n.a/N=not applicable E.U.T=equipment under tested		
This test report is based on a single evaluation of one sample of above mentioned products ,It is not permitted to be duplicated in extracts without written approval of EST Technology Co., Ltd.		

1. GENERAL INFORMATION

1.1. Description of Device (EUT)

Product Name	:	10.1" ANDROID TABLET WITH DETACHABLE KEYBOARD	
FCC ID	:	2AE2WT1015M	
Model Number	:	ONA19TB003	
Operation frequency	:	UNII Band I: IEEE 802.11a: 5180 ~ 5240MHz; IEEE 802.11n HT20: 5180 ~ 5240MHz; IEEE 802.11n HT40: 5190 ~ 5230MHz; UNII Band II: IEEE 802.11a: 5260 ~ 5320MHz; IEEE 802.11n HT20: 5260 ~ 5320MHz; IEEE 802.11n HT40: 5270 ~ 5310MHz; UNII Band III: IEEE 802.11a: 5500 ~ 5700MHz; IEEE 802.11n HT20: 5500 ~ 5700MHz; IEEE 802.11n HT40: 5510 ~ 5670MHz; UNII Band IV: IEEE 802.11a: 5745 ~ 5825MHz; IEEE 802.11n HT20: 5745 ~ 5825MHz; IEEE 802.11n HT40: 5755 ~ 5795MHz;	
Modulation	:	OFDM(QPSK, BPSK, 16-QAM, 64-QAM,256-QAM)	
Transmit Data Rate	:	IEEE 802.11a: 54, 48, 36, 24, 18, 12, 9, 6Mbps; IEEE 802.11n HT20: 14.4, 28.9, 43.3, 57.8, 86.7, 115.6, 130.0, 144.4 Mbps; IEEE 802.11n HT40: 30, 60, 90, 120, 180, 240, 270, 300 Mbps;	
Channels Spacing	:	IEEE 802.11a: 20MHz; IEEE 802.11n HT20: 20MHz; IEEE 802.11n HT40: 40MHz;	
Antenna	:	Internal antenna	
		Frequency Range	Antenna
		5150~5875 MHz	1.32 dBi
		Note: Bluetooth uses Antenna 11a,b,g,n, uses Antenna	
Sample Type	:	Prototype production	

Number of channel	Band	Mode	Channel	Frequency (MHz)	
	UNII Band I	IEEE 802.11a & n HT20: 5180-5240MHz		36	5180
40				5200	
44				5220	
48				5240	
IEEE 802.11n HT40: 5180-5240MHz			38	5190	
			46	5230	
UNII Band II		IEEE 802.11a & n HT20: 5260-5320MHz		52	5260
				56	5280
				60	5300
	64			5320	
	IEEE 802.11n HT40: 5270-5310MHz		54	5270	
			62	5310	
UNII Band III	IEEE 802.11a & n HT20: 5500-5700MHz		100	5500	
			104	5520	
			108	5540	
			112	5560	
			116	5580	
			132	5660	
			136	5680	
			140	5700	
	IEEE 802.11n HT40: 5510-5670		102	5510	
			110	5550	
UNII Band IV	IEEE 802.11a & n HT20: 5745-5825MHz		149	5745	
			153	5765	
			157	5785	
			161	5805	
			165	5825	
	IEEE 802.11n HT40: 5755-5795MHz		151	5755	
			159	5795	

2. SUMMARY OF TEST

2.1. Test methodology.

According to its specifications, the EUT must comply with the requirements of the following standards:

FCC 06-96

FCC 47 CFR Part 15, Subpart E

FCC KDB 905462 D02 UNII DFS Compliance Procedures New Rules v02

FCC KDB 905462 D03 Client Without DFS New Rules v01r02

2.2. Summary of test result

Description of Test Item	Standard	Results
Dynamic Frequency Selection	FCC Part 15:407 (h) (i) (j)	PASS

2.3. Test Facilities

- EMC Lab : Certificated by CNAS, CHINA
Registration No.: L5288
Date of registration: November 13, 2017
- Certificated by FCC, USA
Designation Number: CN1215
Test Firm Registration Number: 722932
Date of registration: November 21, 2017
- Certificated by A2LA, USA
Registration No.: 4366.01
Date of registration: November 07, 2017
- Certificated by Industry Canada
CAB identifier No.: CN0035
Date of registration: January 04, 2019
- Certificated by VCCI, Japan
Registration No.: R-13663; C-14103
Date of registration: July 25, 2017
This Certificate is valid until: July 24, 2020
- Certificated by TUV Rheinland, Germany
Registration No.: UA 50413872 0001
Date of registration: July 31, 2018
- Certificated by TUV/PS, Shenzhen
Registration No.: SCN1017
Date of registration: January 27, 2011
- Certificated by Intertek ETL SEMKO
Registration No.: 2011-RTL-L2-64
Date of registration: April 28, 2011
- Certificated by Nemko, Hong Kong
Registration No.: 175193
Date of registration: May 4, 2011
- Name of Firm : EST Technology Co., Ltd.
- Site Location : Chilingxiang, Qishantou, Santun, Houjie, Dongguan, Guangdong, China

2.4. Measurement uncertainty

Test Item	Uncertainty
Uncertainty for Conduction emission test	2.54dB
Uncertainty for Radiation Emission test (9Khz-30MHz)	3.11
Uncertainty for Radiation Emission test (30MHz-1GHz)	3.62
Uncertainty for Radiation Emission test (1GHz to 18GHz)	4.86
Uncertainty for spurious emissions test (18GHz to 40GHz)	4.67
Uncertainty for radio frequency	7×10^{-8}
Uncertainty for conducted RF Power	0.20dB
Uncertainty for Power density test	0.26dB
Temperature	$\pm 0.6^{\circ}\text{C}$
Humidity	$\pm 4.0\%$
Volatage DC	$\pm 1.0\%$
Volatage (AC, <10KHz)	$\pm 1.5\%$

Note: This uncertainty represents an expanded uncertainty expressed at approximately the 95% confidence level using a coverage factor of k=2.

2.5. Assistant equipment used for test

2.5.1. Adapter

M/N : BSY01J3050200U U
 Input : AC 100-240V, 50/60Hz, 0.3A
 Output : DC 5.0V, 2.0A

2.5.2. Router (Master)

Manufacturer : LINKSYS
 M/N : WRT3200ACM
 FCC ID : Q87-WRT3200ACM
 IC : 3839A-WRT3200ACM
 S/N : 1981060A621419
 MAC : 6038E0B87B20
 Max Gain : 3.81 dBi

2.5.3. Notebook

Manufacturer : Lenovo
 M/N : Thinkpad X250
 S/N : 2014AP6082

2.6. Test mode

The EUT has been tested under its typical operating condition.

The EUT configuration for testing is installed on RF field strength measurement to meet the Commissions requirement and operating in a manner which intends to maximize its emission characteristics in a continuous normal application.

The Transmitter was operated in the normal operating mode. The TX frequency was fixed which was for the purpose of the measurements.

Test of channel included the lowest and middle and highest frequency to perform the test, then record on this report.

Band	Mode	Frequency (MHz)
UNII Band II	IEEE 802.11a	5260
	IEEE 802.11a	5320
	IEEE 802.11n HT40	5270
	IEEE 802.11n HT40	5310
UNII Band III	IEEE 802.11a	5500
	IEEE 802.11a	5700
	IEEE 802.11n HT40	5510
	IEEE 802.11n HT40	5670

2.7. Test Equipment

2.7.1. Measurement equipment used.

Equipment	Manufacturer	Model No.	Serial No.	Calibration Body	Last Cal.	Next Cal.
TS 8997	Rohde & Schwarz	/	/	/	/	/
Open Switch and Control Unit	Rohde & Schwarz	OSP-B157WB	101309	CEPREI	June 15,18	1 Year
Signal and Spectrum Analyzer	Rohde & Schwarz	FSV	103173	CEPREI	June 15,18	1 Year
Signal Generator	Rohde & Schwarz	SMB100A	108752	CEPREI	June 15,18	1 Year
Vector Signal Generator	Rohde & Schwarz	SMBV100A	260753	CEPREI	June 15,18	1 Year
Test Software	Rohde & Schwarz	WMS32	V10.40.00	N/A	N/A	N/A

3. SETUP OF EQUIPMENT UNDER TEST

3.1. Setup Configuration Of EUT

Setup for Master with injection at the Master

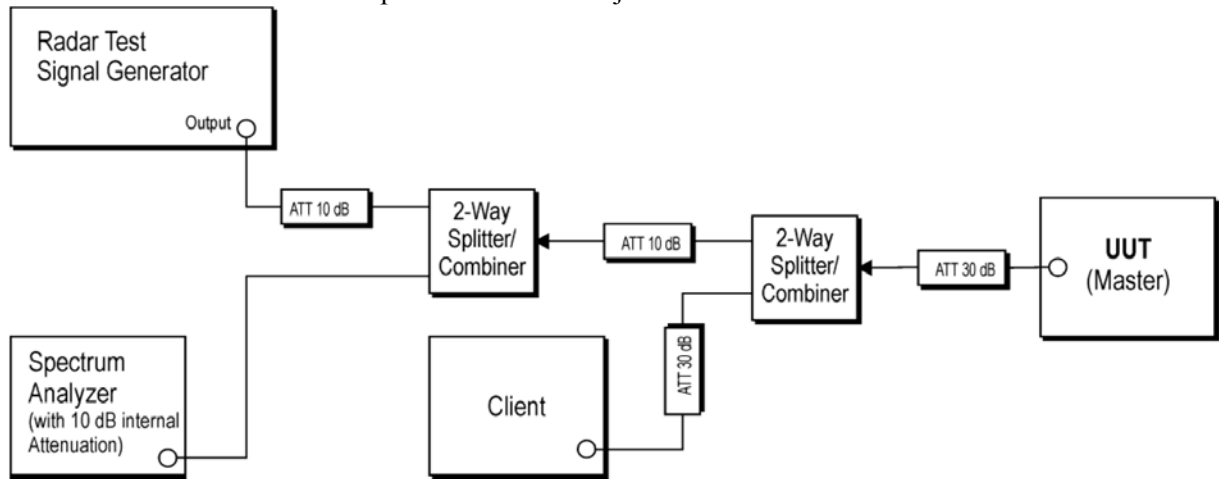

Setup for Client with injection at the Master

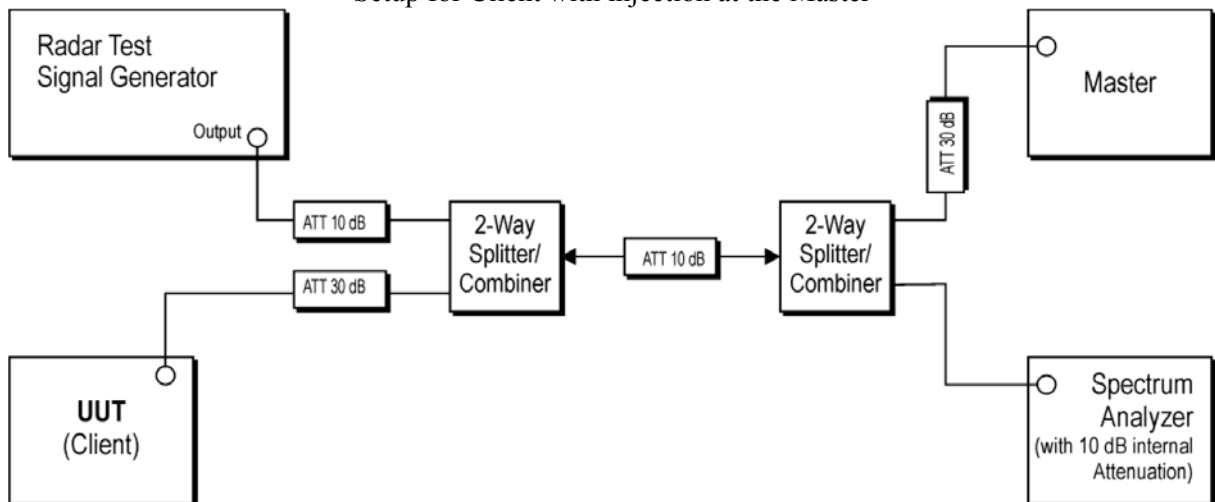

Setup for Client with injection at the Client

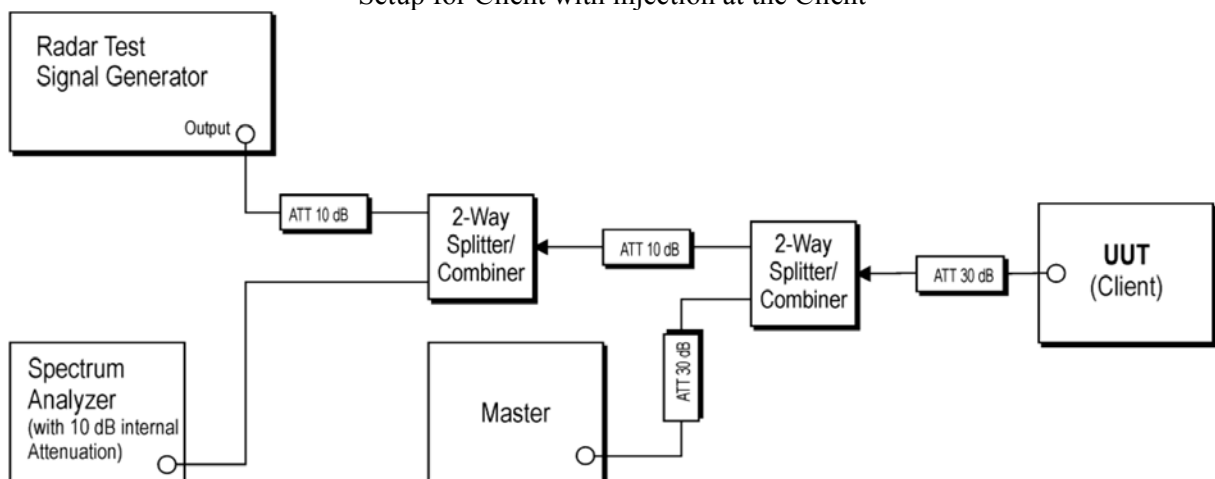

3.2. Setup Configuration Of TS8997

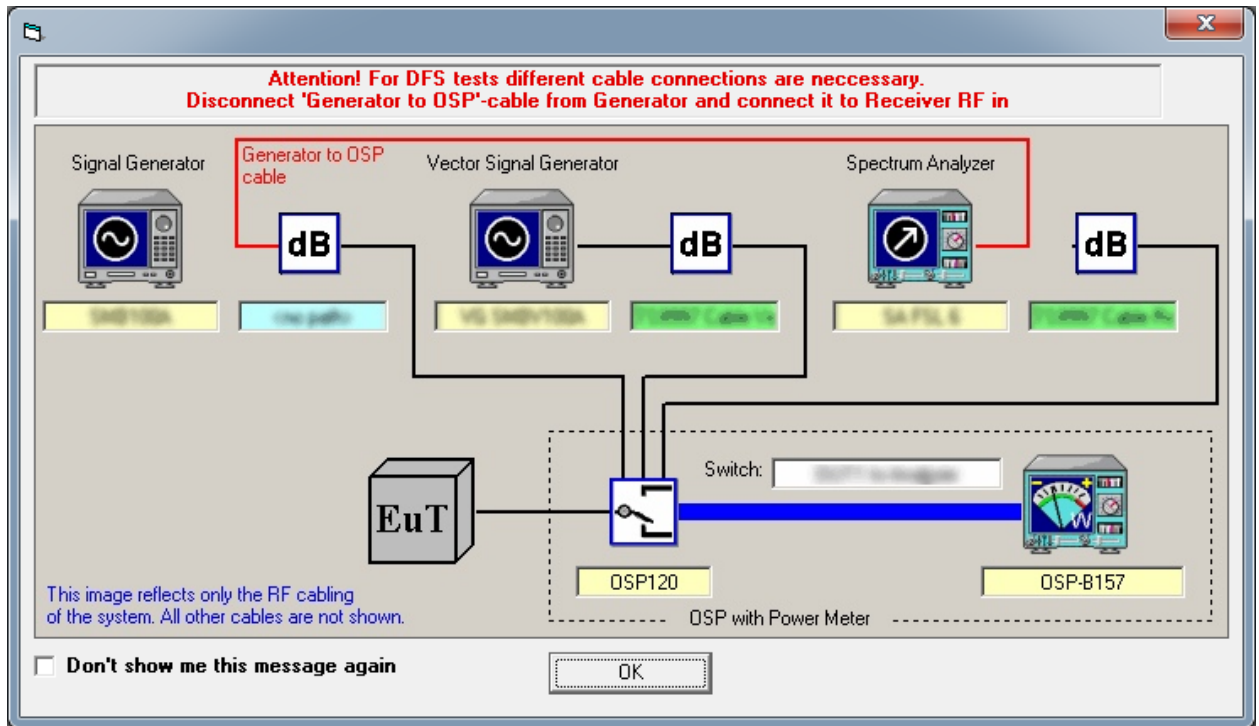

4. DYNAMIC FREQUENCY SELECTION REQUIREMENTS

4.1. Applicable standard

According to 15.407

4.2. Operation Modes and Requirement Test Item.

The manufacturer shall state whether the EUT is capable of operating as a Master or a Slave modes, if the EUT is capable of operating in more than one operational mode then every operating mode shall be assessed separately.

Table 1: Applicability of DFS Requirements Prior to Use of a Channel

Requirement	Operational Mode		
	Master	Client Without Radar Detection	Client With Radar Detection
<i>Non-Occupancy Period</i>	Yes	Not required	Yes
<i>DFS Detection Threshold</i>	Yes	Not required	Yes
<i>Channel Availability Check Time</i>	Yes	Not required	Not required
<i>U-NII Detection Bandwidth</i>	Yes	Not required	Yes

Table 2: Applicability of DFS requirements during normal operation

Requirement	Operational Mode	
	Master Device or Client with Radar Detection	Client Without Radar Detection
<i>DFS Detection Threshold</i>	Yes	Not required
<i>Channel Closing Transmission Time</i>	Yes	Yes
<i>Channel Move Time</i>	Yes	Yes
<i>U-NII Detection Bandwidth</i>	Yes	Not required

Additional requirements for devices with multiple bandwidth modes	Master Device or Client with Radar Detection	Client Without Radar Detection
<i>U-NII Detection Bandwidth and Statistical Performance Check</i>	All BW modes must be tested	Not required
<i>Channel Move Time and Channel Closing Transmission Time</i>	Test using widest BW mode available	Test using the widest BW mode available for the link
<i>All other tests</i>	Any single BW mode	Not required
Note: Frequencies selected for statistical performance check (Section 7.8.4) should include several frequencies within the radar detection bandwidth and frequencies near the edge of the radar detection bandwidth. For 802.11 devices it is suggested to select frequencies in each of the bonded 20 MHz channels and the channel center frequency.		

4.3. Conformance Limit

Table 3: DFS Detection Thresholds for Master Devices and Client Devices with Radar Detection

Maximum Transmit Power	Value (See Notes 1, 2, and 3)
EIRP \geq 200 milliwatt	-64 dBm
EIRP < 200 milliwatt and power spectral density < 10 dBm/MHz	-62 dBm
EIRP < 200 milliwatt that do not meet the power spectral density requirement	-64 dBm
<p>Note 1: This is the level at the input of the receiver assuming a 0 dBi receive antenna.</p> <p>Note 2: Throughout these test procedures an additional 1 dB has been added to the amplitude of the test transmission waveforms to account for variations in measurement equipment. This will ensure that the test signal is at or above the detection threshold level to trigger a DFS response.</p> <p>Note 3: EIRP is based on the highest antenna gain. For MIMO devices refer to KDB Publication 662911 D01.</p>	

Table 4: DFS Response Requirement Values

Parameter	Value
<i>Non-occupancy period</i>	Minimum 30 minutes
<i>Channel Availability Check Time</i>	60 seconds
<i>Channel Move Time</i>	10 seconds See Note 1.
<i>Channel Closing Transmission Time</i>	200 milliseconds + an aggregate of 60 milliseconds over remaining 10 second period. See Notes 1 and 2.
<i>U-NII Detection Bandwidth</i>	Minimum 100% of the U-NII 99% transmission power bandwidth. See Note 3.
<p>Note 1: <i>Channel Move Time</i> and the <i>Channel Closing Transmission Time</i> should be performed with Radar Type 0. The measurement timing begins at the end of the Radar Type 0 burst.</p> <p>Note 2: The <i>Channel Closing Transmission Time</i> is comprised of 200 milliseconds starting at the beginning of the <i>Channel Move Time</i> plus any additional intermittent control signals required to facilitate a <i>Channel</i> move (an aggregate of 60 milliseconds) during the remainder of the 10 second period. The aggregate duration of control signals will not count quiet periods in between transmissions.</p> <p>Note 3: During the <i>U-NII Detection Bandwidth</i> detection test, radar type 0 should be used. For each frequency step the minimum percentage of detection is 90 percent. Measurements are performed with no data traffic.</p>	

Table 5 – Short Pulse Radar Test Waveforms

Radar Type	Pulse Width (μsec)	PRI (μsec)	Number of Pulses	Minimum Percentage of Successful Detection	Minimum Number of Trials
0	1	1428	18	See Note 1	See Note 1
1	1	Test A: 15 unique PRI values randomly selected from the list of 23 PRI values in Table 5a	Roundup $\left\{ \begin{matrix} \left(\frac{1}{360} \right) \cdot \\ \left(\frac{19 \cdot 10^6}{PRI_{\mu sec}} \right) \end{matrix} \right\}$	60%	30
		Test B: 15 unique PRI values randomly selected within the range of 518-3066 μsec, with a minimum increment of 1 μsec, excluding PRI values selected in Test A			
2	1-5	150-230	23-29	60%	30
3	6-10	200-500	16-18	60%	30
4	11-20	200-500	12-16	60%	30
Aggregate (Radar Types 1-4)				80%	120
Note 1: Short Pulse Radar Type 0 should be used for the detection bandwidth test, channel move time, and channel closing time tests.					

Table 6 – Long Pulse Radar Test Waveform

Radar Type	Pulse Width (μsec)	Chirp Width (MHz)	PRI (μsec)	Number of Pulses per Burst	Number of Bursts	Minimum Percentage of Successful Detection	Minimum Number of Trials
5	50-100	5-20	1000-2000	1-3	8-20	80%	30

Table 7 – Frequency Hopping Radar Test Waveform

Radar Type	Pulse Width (μsec)	PRI (μsec)	Pulses per Hop	Hopping Rate (kHz)	Hopping Sequence Length (msec)	Minimum Percentage of Successful Detection	Minimum Number of Trials
6	1	333	9	0.333	300	70%	30

4.4. Transmitter Output Power

Band	Mode	Max Output Power (dBm)	Antenna Gain (dBi)	Max Eirp	
				dBm	mW
UNII Band II	IEEE 802.11a	13.957	1.32	15.277	33.705
	IEEE 802.11n HT40	14.032	1.32	15.352	34.293
UNII Band III	IEEE 802.11a	11.732	1.32	13.052	20.193
	IEEE 802.11n HT40	12.377	1.32	13.697	23.426

4.5. Operation Modes and Requirement Test Item.

The manufacture shall state whether the EUT is capable of operating as a Master or a Slave modes, if the EUT is capable of operating in more than one operational mode then every operating mode shall be assessed separately.

Applicability of DFS Requirements Prior to Use of a Channel

4.6. Test Result

DFS In-Service Monitoring (5260 MHz; 20 MHz) Measurement Summary

DUT Frequency (MHz)	Radar Type No.	Type of Measurement value	Overall Result
5260.000000	0	First of all Transmitt Test	PASS
5260.000000	0	Channel Move Time	PASS
5260.000000	0	Channel Closing Transmission Time	PASS
5260.000000	0	Non-occupancy period	PASS

Channel Move Time Detailed Results

DUT Frequency (MHz)	Radar Type No.	CMT Tx Time (s)	CMT Limit (s)	CMT Result
5260.000000	0	2.145	10.000	PASS

(continuation of the "Channel Move Time Detailed Results" table from column 5 ...)

DUT Frequency (MHz)	CMT Comment
5260.000000	Tx Time value is last trailing edge found within sweep. See Note 1.

Channel Closing Transmission Time Detailed Results

DUT Frequency (MHz)	Radar Type No.	CCTT Type of Value	CCTT No. of Pulses found	CCTT Tx Time (ms)
5260.000000	0	first 200 ms	99	3.040
5260.000000	0	remaining 10.0 second(s) period	104	6.232

(continuation of the "Channel Closing Transmission Time Detailed Results" table from column 5 ...)

DUT Frequency (MHz)	CCTT Tx Time Limit (ms)	CCTT Result	CCTT Comment
5260.000000	200.000	PASS	See Note 1.
5260.000000	60.000	PASS	See Note 1.

Non-occupancy period Detailed Results

DUT Frequency (MHz)	Radar Type No.	NOP No. of Pulses found	NOP No. of Pulses Limit	NOP Tx Time (s)	NOP Tx Time Limit (s)
5260.000000	0	0	0	0.000	0.000

(continuation of the "Non-occupancy period Detailed Results" table from column 6 ...)

DUT Frequency (MHz)	NOP Result
5260.000000	PASS

Transmitting Test Detailed Results

DUT Frequency (MHz)	Tx-Test DutyCycle (%)	Tx-Test DutyCycle Limit	Tx-Test No. of Pulses found	Tx-Test Result	Tx-Test Comment
5260.000000	62.287	>=17 %	436	PASS	

Additional Information

Note	Description
Note 1:	Because of the radar pulse event at the beginning, the investigation of the trace begins with an offset of 26.7 ms conforming to the end of the Radar burst.
Note 2:	Channel move time (CMT) / channel closing transmission time (CCTT) measurement was made with hi resolution video sweep using OSP DAQ channel
Note 3:	Because of the substantially higher sampling rate of the video signal the results for CCTT and CMT are more accurate than in the graphics visible. Reached timing accuracy of the video trace: approx 4
Note 4:	The Non-Occupancy Period trace starts at the end of the Channel move time trace (20.000 secs.) Labeling of the x-axis (time) is relative to its beginning (0 secs.)

Radar level verification

Description	Value	Unit
Configured DUT EIRP:	31.62	mW
Configured DUT PSD:	5.00	dBm/MHz
Requirement of the Detection threshold value for this given values acc. to FCC clause 5.2 / Table 3	-62	dBm
Vector Generator level setting	11.22	dBm
Configured overall pathlost from Vector Generator RF out to DUT connector of 'DUT to OSP'-cable	70.85	dB
Given additional level added to the amplitude of the waveform to account for variations in measurement equipment acc. to FCC clause 5.2 / Table 3 / Note 2	1.00	dB
This results in the following radar signal level at the DUT	-59.63	dBm

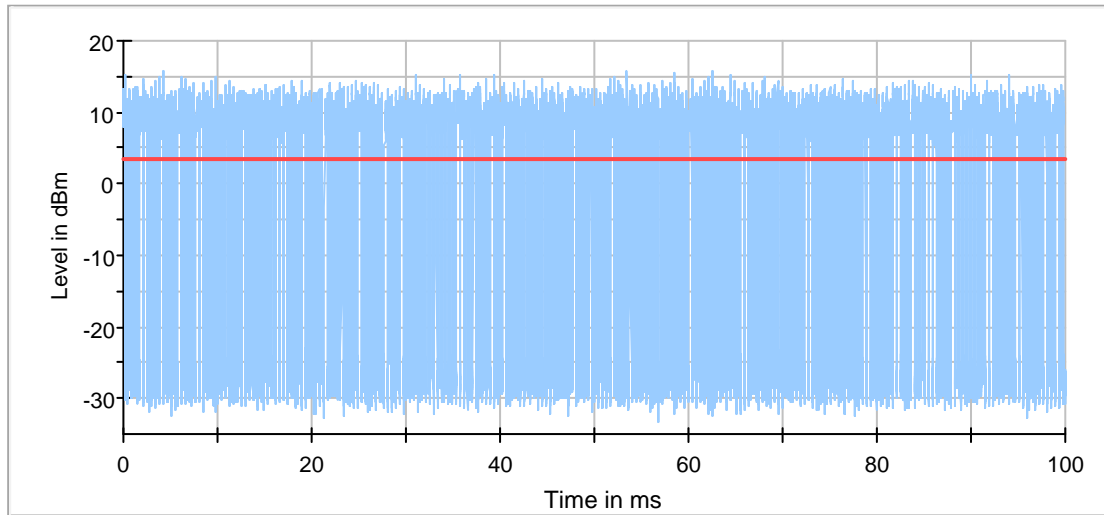

— In-Service Monitoring Transmitt Test Sweep — Threshold

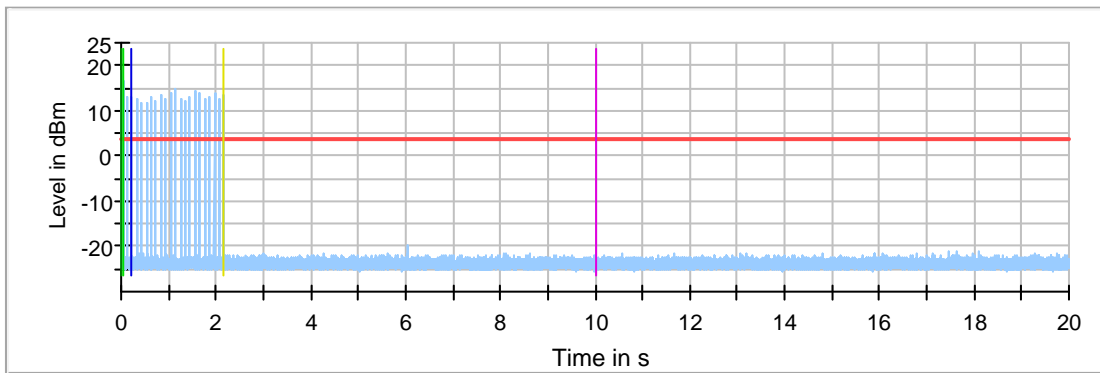

— In-Service Monitoring Channel Move Time
 — Threshold
 — Start of Radar
 — Trigger at end of Radar
 — First 200ms of Channel Closing Tx Time
 — 10sec Channel Move Time Limit
 — Last measured edge of Channel Closing Tx Time

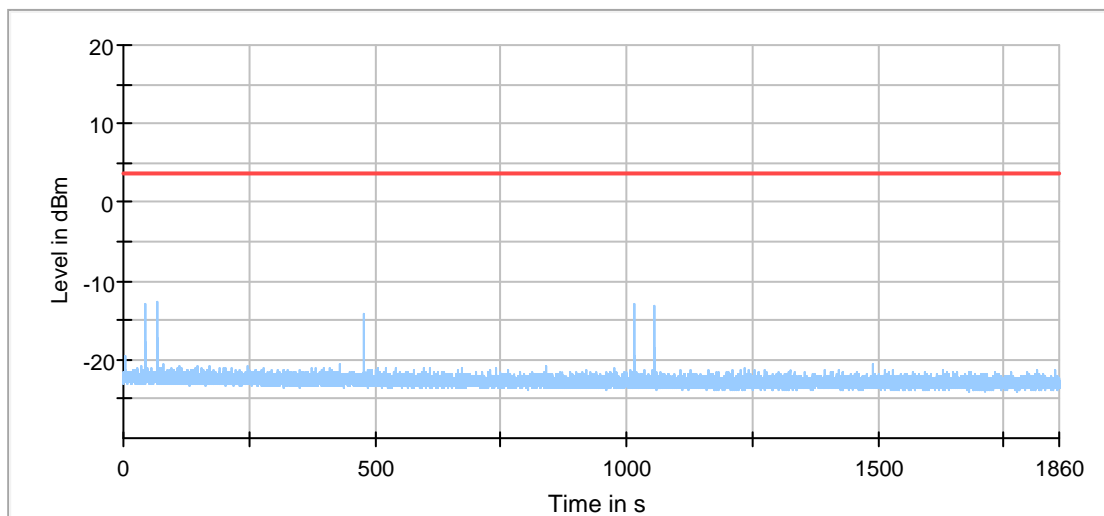

— In-Service Monitoring Non-occupancy period — Threshold

DFS In-Service Monitoring (5320 MHz; 20 MHz)

Measurement Summary

DUT Frequency (MHz)	Radar Type No.	Type of Measurement value	Overall Result
5320.000000	0	First of all Transmitt Test	PASS
5320.000000	0	Channel Move Time	PASS
5320.000000	0	Channel Closing Transmission Time	PASS
5320.000000	0	Non-occupancy period	PASS

Channel Move Time Detailed Results

DUT Frequency (MHz)	Radar Type No.	CMT Tx Time (s)	CMT Limit (s)	CMT Result
5320.000000	0	2.071	10.000	PASS

(continuation of the "Channel Move Time Detailed Results" table from column 5 ...)

DUT Frequency (MHz)	CMT Comment
5320.000000	Tx Time value is last trailing edge found within sweep. See Note 1.

Channel Closing Transmission Time Detailed Results

DUT Frequency (MHz)	Radar Type No.	CCTT Type of Value	CCTT No. of Pulses found	CCTT Tx Time (ms)
5320.000000	0	first 200 ms	30	0.592
5320.000000	0	remaining 10.0 second(s) period	297	5.672

(continuation of the "Channel Closing Transmission Time Detailed Results" table from column 5 ...)

DUT Frequency (MHz)	CCTT Tx Time Limit (ms)	CCTT Result	CCTT Comment
5320.000000	200.000	PASS	See Note 1.
5320.000000	60.000	PASS	See Note 1.

Non-occupancy period Detailed Results

DUT Frequency (MHz)	Radar Type No.	NOP No. of Pulses found	NOP No. of Pulses Limit	NOP Tx Time (s)	NOP Tx Time Limit (s)
5320.000000	0	0	0	0.000	0.000

(continuation of the "Non-occupancy period Detailed Results" table from column 6 ...)

DUT Frequency (MHz)	NOP Result
5320.000000	PASS

Transmitting Test Detailed Results

DUT Frequency (MHz)	Tx-Test DutyCycle (%)	Tx-Test DutyCycle Limit	Tx-Test No. of Pulses found	Tx-Test Result	Tx-Test Comment
5320.000000	41.073	>=17 %	287	PASS	

Additional Information

Note	Description
Note 1:	Because of the radar pulse event at the beginning, the investigation of the trace begins with an offset of 26.7 ms conforming to the end of the Radar burst.
Note 2:	Channel move time (CMT) / channel closing transmission time (CCTT) measurement was made with hi resolution video sweep using OSP DAQ channel
Note 3:	Because of the substantially higher sampling rate of the video signal the results for CCTT and CMT are more accurate than in the graphics visible. Reached timing accuracy of the video trace: approx 4
Note 4:	The Non-Occupancy Period trace starts at the end of the Channel move time trace (20.000 secs.) Labeling of the x-axis (time) is relative to its beginning (0 secs.)

Radar level verification

Description	Value	Unit
Configured DUT EIRP:	31.62	mW
Configured DUT PSD:	5.00	dBm/MHz
Requirement of the Detection threshold value for this given values acc. to FCC clause 5.2 / Table 3	-62	dBm
Vector Generator level setting	11.93	dBm
Configured overall pathlost from Vector Generator RF out to DUT connector of 'DUT to OSP'-cable	71.22	dB
Given additional level added to the amplitude of the waveform to account for variations in measurement equipment acc. to FCC clause 5.2 / Table 3 / Note 2	1.00	dB
This results in the following radar signal level at the DUT	-59.29	dBm

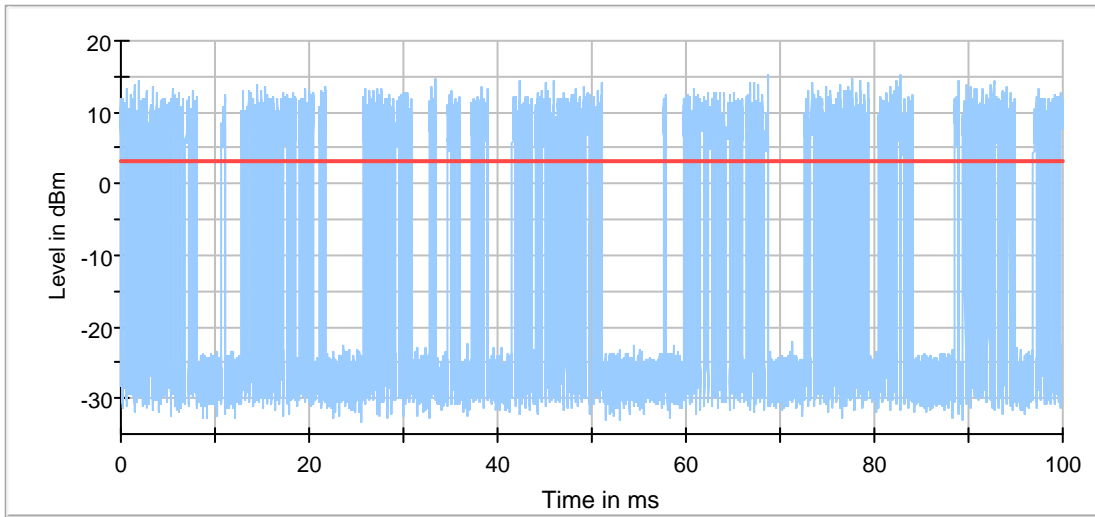

— In-Service Monitoring Transmitt Test Sweep — Threshold

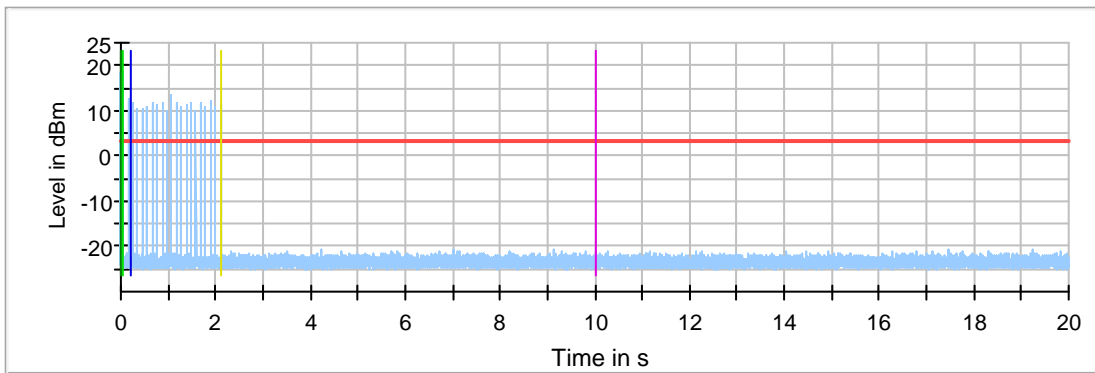

— In-Service Monitoring Channel Move Time
 — Threshold
 — Start of Radar
 — Trigger at end of Radar
 — First 200ms of Channel Closing Tx Time
 — 10sec Channel Move Time Limit
 — Last measured edge of Channel Closing Tx Time

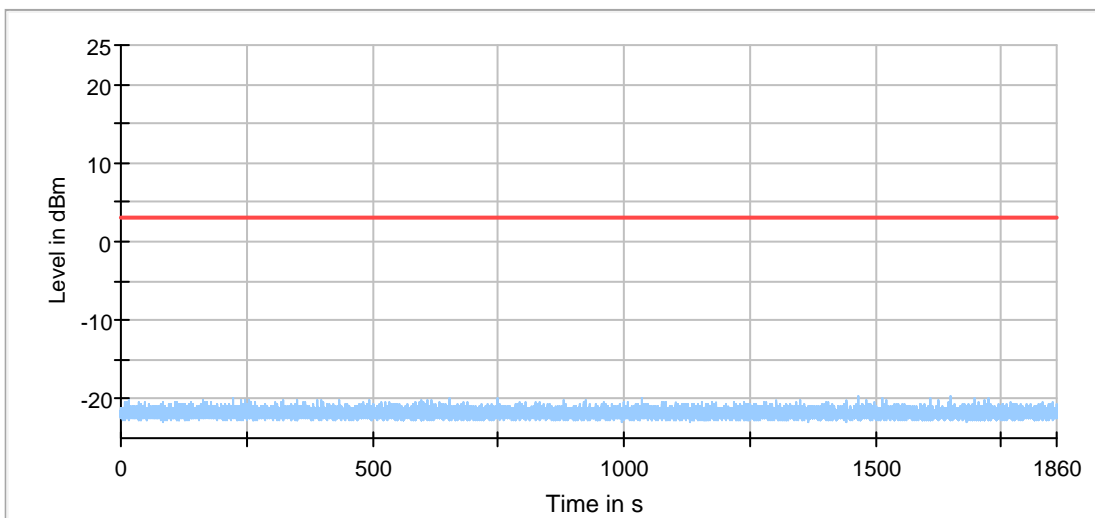

— In-Service Monitoring Non-occupancy period — Threshold

DFS In-Service Monitoring (5500 MHz; 20 MHz)

Measurement Summary

DUT Frequency (MHz)	Radar Type No.	Type of Measurement value	Overall Result
5500.000000	0	First of all Transmitt Test	PASS
5500.000000	0	Channel Move Time	PASS
5500.000000	0	Channel Closing Transmission Time	PASS
5500.000000	0	Non-occupancy period	PASS

Channel Move Time Detailed Results

DUT Frequency (MHz)	Radar Type No.	CMT Tx Time (s)	CMT Limit (s)	CMT Result
5500.000000	0	2.139	10.000	PASS

(continuation of the "Channel Move Time Detailed Results" table from column 5 ...)

DUT Frequency (MHz)	CMT Comment
5500.000000	Tx Time value is last trailing edge found within sweep. See Note 1.

Channel Closing Transmission Time Detailed Results

DUT Frequency (MHz)	Radar Type No.	CCTT Type of Value	CCTT No. of Pulses found	CCTT Tx Time (ms)
5500.000000	0	first 200 ms	46	1.784
5500.000000	0	remaining 10.0 second(s) period	67	6.284

(continuation of the "Channel Closing Transmission Time Detailed Results" table from column 5 ...)

DUT Frequency (MHz)	CCTT Tx Time Limit (ms)	CCTT Result	CCTT Comment
5500.000000	200.000	PASS	See Note 1.
5500.000000	60.000	PASS	See Note 1.

Non-occupancy period Detailed Results

DUT Frequency (MHz)	Radar Type No.	NOP No. of Pulses found	NOP No. of Pulses Limit	NOP Tx Time (s)	NOP Tx Time Limit (s)
5500.000000	0	0	0	0.000	0.000

(continuation of the "Non-occupancy period Detailed Results" table from column 6 ...)

DUT Frequency (MHz)	NOP Result
5500.000000	PASS

Transmitting Test Detailed Results

DUT Frequency (MHz)	Tx-Test DutyCycle (%)	Tx-Test DutyCycle Limit	Tx-Test No. of Pulses found	Tx-Test Result	Tx-Test Comment
5500.000000	26.750	>=17 %	183	PASS	

Additional Information

Note	Description
Note 1:	Because of the radar pulse event at the beginning, the investigation of the trace begins with an offset of 26.7 ms conforming to the end of the Radar burst.
Note 2:	Channel move time (CMT) / channel closing transmission time (CCTT) measurement was made with hi resolution video sweep using OSP DAQ channel
Note 3:	Because of the substantially higher sampling rate of the video signal the results for CCTT and CMT are more accurate than in the graphics visible. Reached timing accuracy of the video trace: approx 4 µs
Note 4:	The Non-Occupancy Period trace starts at the end of the Channel move time trace (20.000 secs.) Labeling of the x-axis (time) is relative to its beginning (0 secs.)

Radar level verification

Description	Value	Unit
Configured DUT EIRP:	31.62	mW
Configured DUT PSD:	3.00	dBm/MHz
Requirement of the Detection threshold value for this given values acc. to FCC clause 5.2 / Table 3	-62	dBm
Vector Generator level setting	10.80	dBm
Configured overall pathlost from Vector Generator RF out to DUT connector of 'DUT to OSP'-cable	71.23	dB
Given additional level added to the amplitude of the waveform to account for variations in measurement equipment acc. to FCC clause 5.2 / Table 3 / Note 2	1.00	dB
This results in the following radar signal level at the DUT	-60.43	dBm

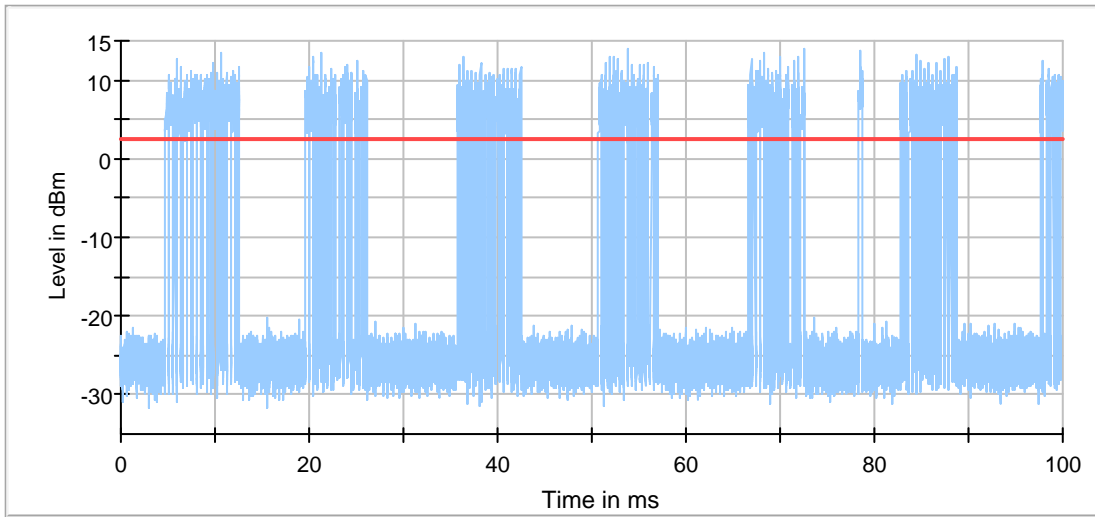

— In-Service Monitoring Transmitt Test Sweep — Threshold

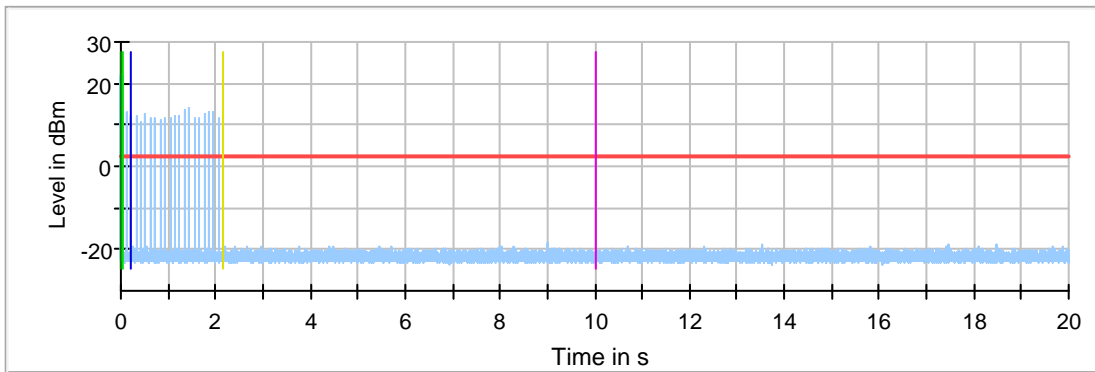

— In-Service Monitoring Channel Move Time
 — Threshold
 — Start of Radar
 — Trigger at end of Radar
 — First 200ms of Channel Closing Tx Time
 — 10sec Channel Move Time Limit
 — Last measured edge of Channel Closing Tx Time

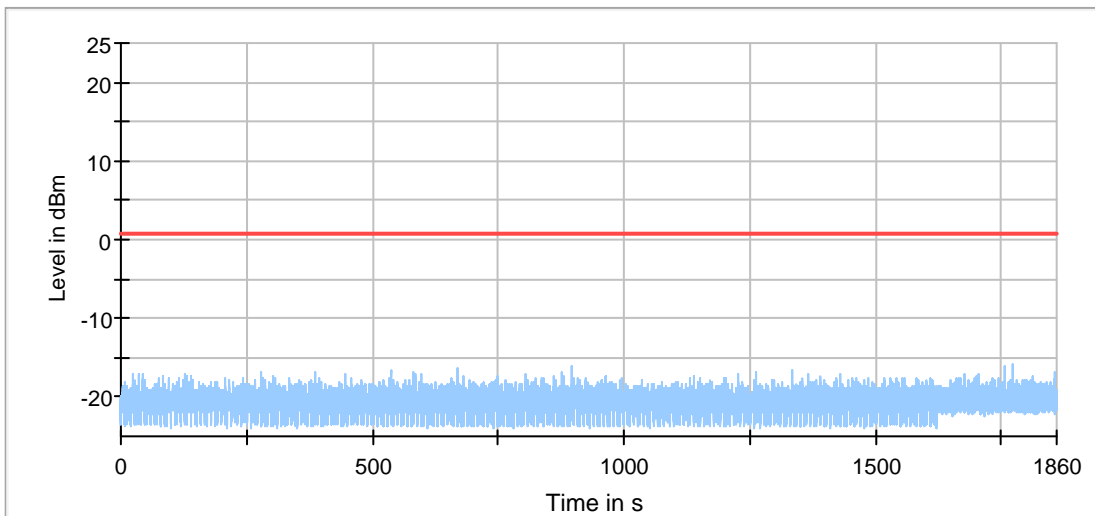

— In-Service Monitoring Non-occupancy period — Threshold

DFS In-Service Monitoring (5700 MHz;20 MHz)

Measurement Summary

DUT Frequency (MHz)	Radar Type No.	Type of Measurement value	Overall Result
5700.000000	0	First of all Transmitt Test	PASS
5700.000000	0	Channel Move Time	PASS
5700.000000	0	Channel Closing Transmission Time	PASS
5700.000000	0	Non-occupancy period	PASS

Channel Move Time Detailed Results

DUT Frequency (MHz)	Radar Type No.	CMT Tx Time (s)	CMT Limit (s)	CMT Result
5700.000000	0	2.118	10.000	PASS

(continuation of the "Channel Move Time Detailed Results" table from column 5 ...)

DUT Frequency (MHz)	CMT Comment
5700.000000	Tx Time value is last trailing edge found within sweep. See Note 1.

Channel Closing Transmission Time Detailed Results

DUT Frequency (MHz)	Radar Type No.	CCTT Type of Value	CCTT No. of Pulses found	CCTT Tx Time (ms)
5700.000000	0	first 200 ms	1498	78.428
5700.000000	0	remaining 10.0 second(s) period	36	6.280

(continuation of the "Channel Closing Transmission Time Detailed Results" table from column 5 ...)

DUT Frequency (MHz)	CCTT Tx Time Limit (ms)	CCTT Result	CCTT Comment
5700.000000	200.000	PASS	See Note 1.
5700.000000	60.000	PASS	See Note 1.

Non-occupancy period Detailed Results

DUT Frequency (MHz)	Radar Type No.	NOP No. of Pulses found	NOP No. of Pulses Limit	NOP Tx Time (s)	NOP Tx Time Limit (s)
5700.000000	0	0	0	0.000	0.000

(continuation of the "Non-occupancy period Detailed Results" table from column 6 ...)

DUT Frequency (MHz)	NOP Result
5700.000000	PASS

Transmitting Test Detailed Results

DUT Frequency (MHz)	Tx-Test DutyCycle (%)	Tx-Test DutyCycle Limit	Tx-Test No. of Pulses found	Tx-Test Result	Tx-Test Comment
5700.000000	24.827	>=17 %	174	PASS	

Additional Information

Note	Description
Note 1:	Because of the radar pulse event at the beginning, the investigation of the trace begins with an offset of 26.7 ms conforming to the end of the Radar burst.
Note 2:	Channel move time (CMT) / channel closing transmission time (CCTT) measurement was made with hi resolution video sweep using OSP DAQ channel
Note 3:	Because of the substantially higher sampling rate of the video signal the results for CCTT and CMT are more accurate than in the graphics visible. Reached timing accuracy of the video trace: approx 4
Note 4:	The Non-Occupancy Period trace starts at the end of the Channel move time trace (20.000 secs.) Labeling of the x-axis (time) is relative to its beginning (0 secs.)

Radar level verification

Description	Value	Unit
Configured DUT EIRP:	31.62	mW
Configured DUT PSD:	3.00	dBm/MHz
Requirement of the Detection threshold value for this given values acc. to FCC clause 5.2 / Table 3	-62	dBm
Vector Generator level setting	12.43	dBm
Configured overall pathlost from Vector Generator RF out to DUT connector of 'DUT to OSP'-cable	72.09	dB
Given additional level added to the amplitude of the waveform to account for variations in measurement	1.00	dB
This results in the following radar signal level at the DUT	-59.67	dBm

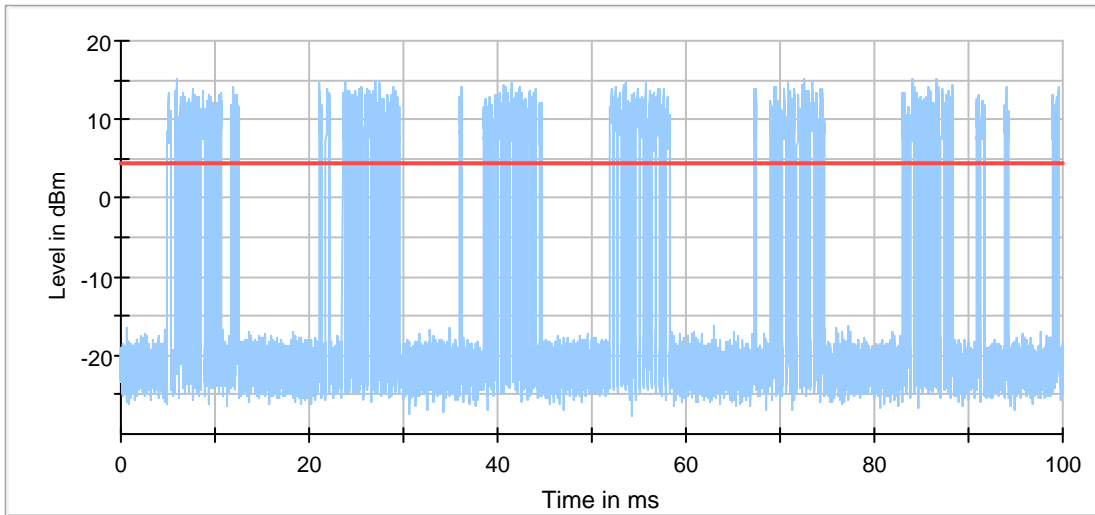

— In-Service Monitoring Transmitt Test Sweep — Threshold

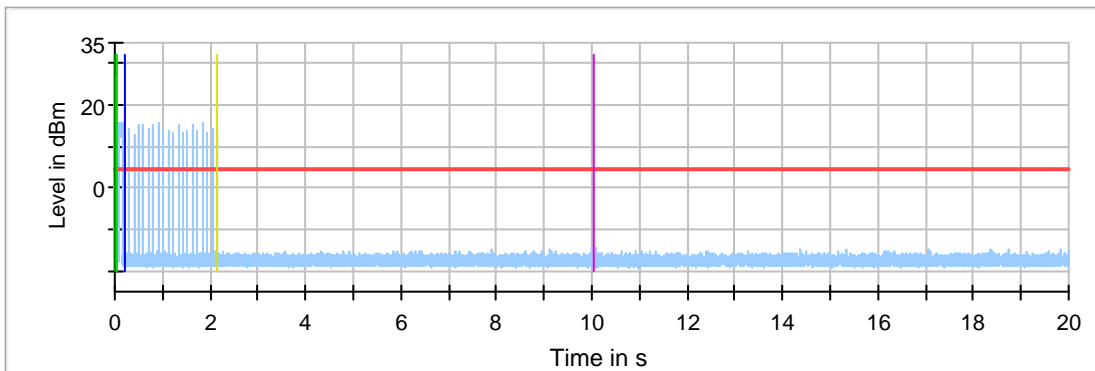

— In-Service Monitoring Channel Move Time
 — Threshold
 — Start of Radar
 — Trigger at end of Radar
 — First 200ms of Channel Closing Tx Time
 — 10sec Channel Move Time Limit
 — Last measured edge of Channel Closing Tx Time

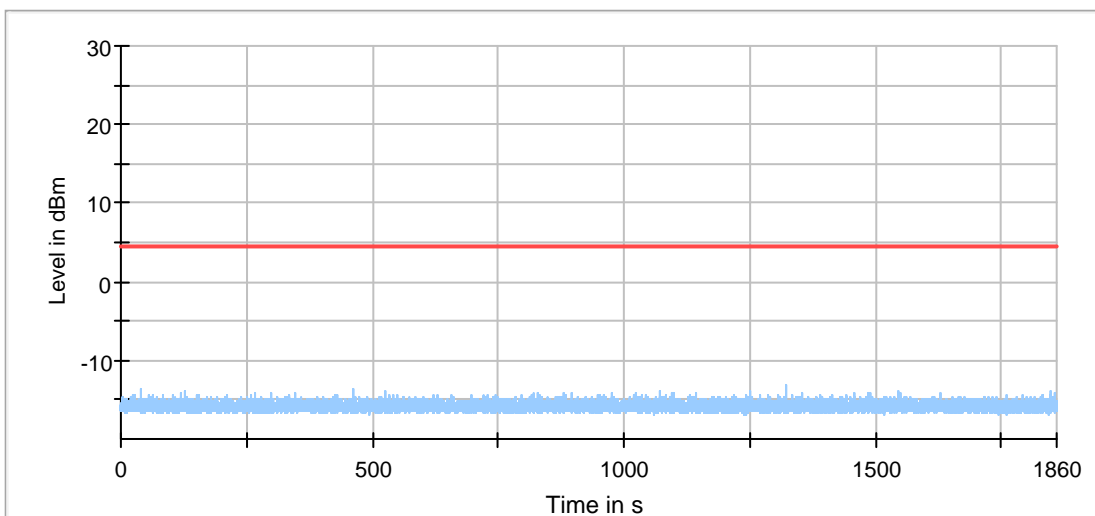

— In-Service Monitoring Non-occupancy period — Threshold

DFS In-Service Monitoring (5270 MHz; 40 MHz)

Measurement Summary

DUT Frequency (MHz)	Radar Type No.	Type of Measurement value	Overall Result
5270.000000	0	First of all Transmitt Test	PASS
5270.000000	0	Channel Move Time	PASS
5270.000000	0	Channel Closing Transmission Time	PASS
5270.000000	0	Non-occupancy period	PASS

(continuation of the "Measurement Summary" table from column 4 ...)

Channel Move Time Detailed Results

DUT Frequency (MHz)	Radar Type No.	CMT Tx Time (s)	CMT Limit (s)	CMT Result
5270.000000	0	0.000	10.000	PASS

(continuation of the "Channel Move Time Detailed Results" table from column 5 ...)

DUT Frequency (MHz)	CMT Comment
5270.000000	Tx Time value is last trailing edge found within sweep. See Note 1.

Channel Closing Transmission Time Detailed Results

DUT Frequency (MHz)	Radar Type No.	CCTT Type of Value	CCTT No. of Pulses found	CCTT Tx Time
5270.000000	0	first 200 ms	0	0.000
5270.000000	0	remaining 10.0 second(s) period	0	0.000

(continuation of the "Channel Closing Transmission Time Detailed Results" table from column 5 ...)

DUT Frequency (MHz)	CCTT Tx Time Limit	CCTT Result	CCTT Comment
5270.000000	200.000	PASS	See Note 1.
5270.000000	60.000	PASS	See Note 1.

Non-occupancy period Detailed Results

DUT Frequency (MHz)	Radar Type No.	NOP No. of Pulses found	NOP No. of Pulses Limit	NOP Tx Time (s)	NOP Tx Time Limit (s)
5270.000000	0	0	0	0.000	0.000

(continuation of the "Non-occupancy period Detailed Results" table from column 6 ...)

DUT Frequency (MHz)	NOP Result
5270.000000	PASS

Transmitting Test Detailed Results

DUT Frequency (MHz)	Tx-Test DutyCycle (%)	Tx-Test DutyCycle Limit	Tx-Test No. of Pulses found	Tx-Test Result	Tx-Test Comment
5700.000000	24.827	>=17 %	174	PASS	

Additional Information

Note	Description
Note 1:	Because of the radar pulse event at the beginning, the investigation of the trace begins with an offset of 26.7 ms conforming to the end of the Radar burst.
Note 2:	Channel move time (CMT) / channel closing transmission time (CCTT) measurement was made with hi resolution video sweep using OSP DAQ channel
Note 3:	Because of the substantially higher sampling rate of the video signal the results for CCTT and CMT are more accurate than in the graphics visible. Reached timing accuracy of the video trace: approx 4
Note 4:	The Non-Occupancy Period trace starts at the end of the Channel move time trace (20.000 secs.) Labeling of the x-axis (time) is relative to its beginning (0 secs.)

Radar level verification

Description	Value	Unit
Configured DUT EIRP:	31.62	mW
Configured DUT PSD:	3.00	dBm/MHz
Requirement of the Detection threshold value for this given values acc. to FCC clause 5.2 / Table 3	-62	dBm
Vector Generator level setting	11.23	dBm
Configured overall pathlost from Vector Generator RF out to DUT connector of 'DUT to OSP'-cable	70.91	dB
Given additional level added to the amplitude of the waveform to account for variations in measurement equipment acc. to FCC clause 5.2 / Table 3 / Note 2	1.00	dB
This results in the following radar signal level at the DUT	-59.68	dBm

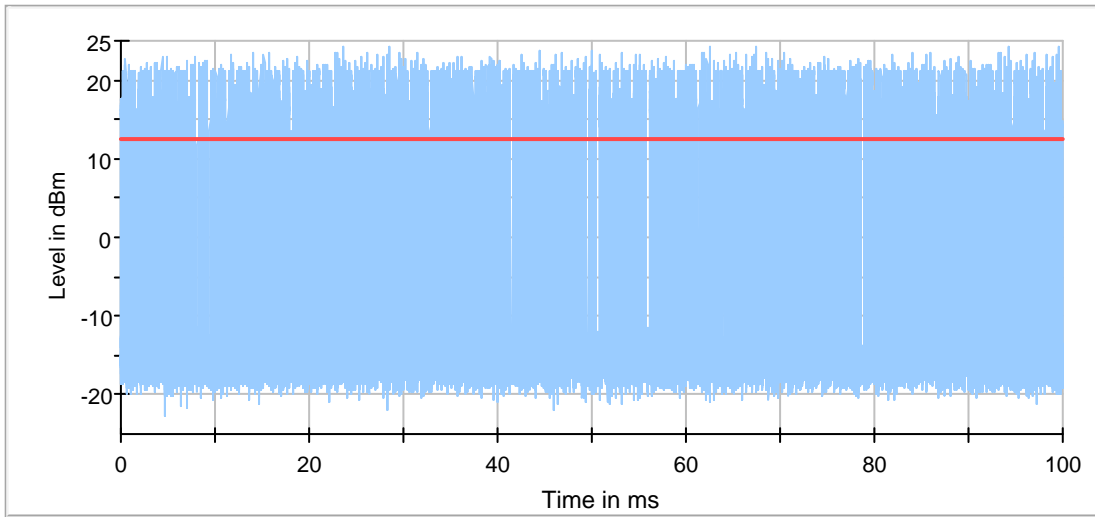

— In-Service Monitoring Transmitt Test Sweep — Threshold

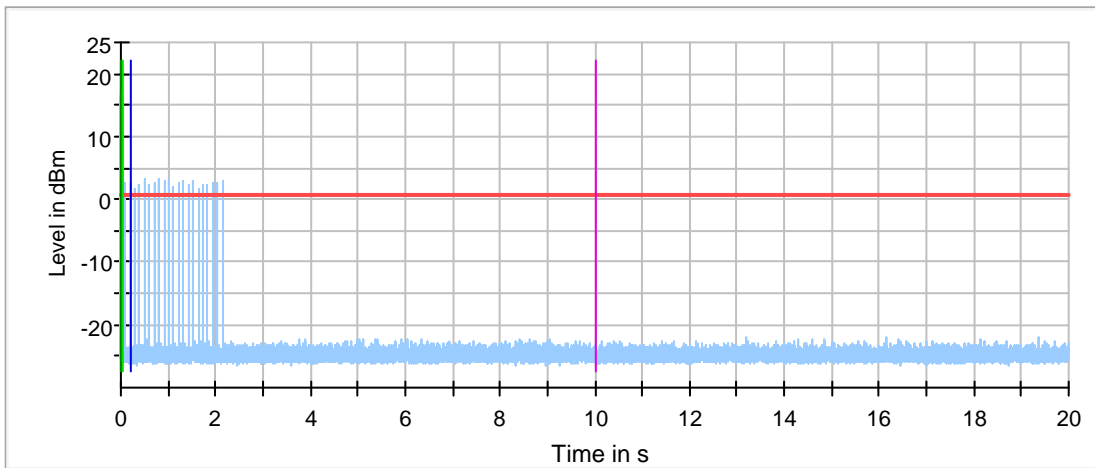

— In-Service Monitoring Channel Move Time — Threshold
 — Start of Radar — Trigger at end of Radar
 — First 200ms of Channel Closing Tx Time — 10sec Channel Move Time Limit

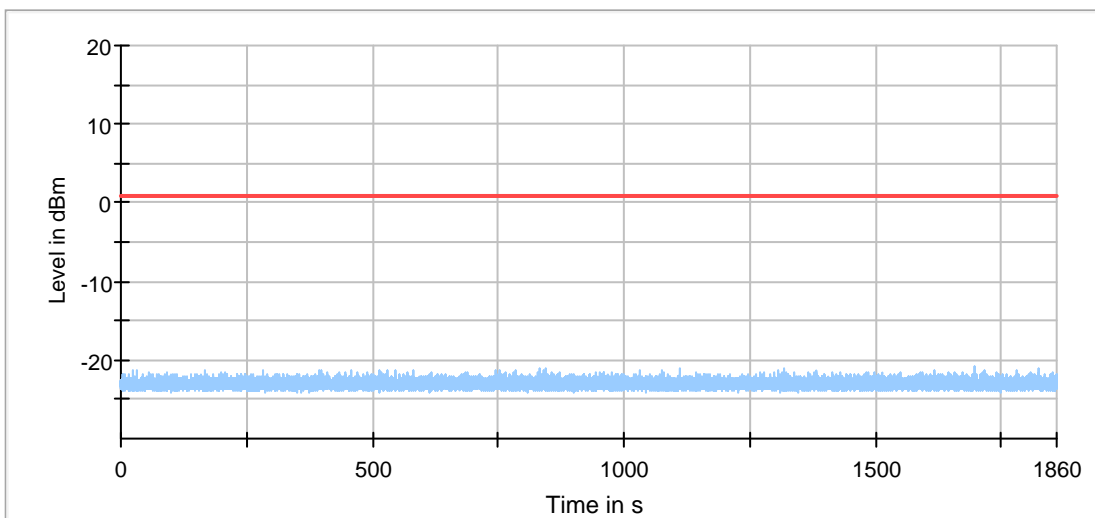

— In-Service Monitoring Non-occupancy period — Threshold

DFS In-Service Monitoring (5310 MHz; 40 MHz)

Measurement Summary

DUT Frequency (MHz)	Radar Type No.	Type of Measurement value	Overall Result
5310.000000	0	First of all Transmitt Test	PASS
5310.000000	0	Channel Move Time	PASS
5310.000000	0	Channel Closing Transmission Time	PASS
5310.000000	0	Non-occupancy period	PASS

(continuation of the "Measurement Summary" table from column 4 ...)

Channel Move Time Detailed Results

DUT Frequency (MHz)	Radar Type No.	CMT Tx Time (s)	CMT Limit (s)	CMT Result
5310.000000	0	0.000	10.000	PASS

(continuation of the "Channel Move Time Detailed Results" table from column 5 ...)

DUT Frequency (MHz)	CMT Comment
5310.000000	Tx Time value is last trailing edge found within sweep. See Note 1.

Channel Closing Transmission Time Detailed Results

DUT Frequency (MHz)	Radar Type No.	CCTT Type of Value	CCTT No. of Pulses found	CCTT Tx Time (ms)
5310.000000	0	first 200 ms	0	0.000
5310.000000	0	remaining 10.0 second(s) period	0	0.000

(continuation of the "Channel Closing Transmission Time Detailed Results" table from column 5 ...)

DUT Frequency (MHz)	CCTT Tx Time Limit	CCTT Result	CCTT Comment
5310.000000	200.000	PASS	See Note 1.
5310.000000	60.000	PASS	See Note 1.

Non-occupancy period Detailed Results

DUT Frequency (MHz)	Radar Type No.	NOP No. of Pulses found	NOP No. of Pulses Limit	NOP Tx Time (s)	NOP Tx Time Limit (s)
5310.000000	0	0	0	0.000	0.000

(continuation of the "Non-occupancy period Detailed Results" table from column 6 ...)

DUT Frequency (MHz)	NOP Result
5310.000000	PASS

Transmitting Test Detailed Results

DUT Frequency (MHz)	Tx-Test DutyCycle (%)	Tx-Test DutyCycle Limit	Tx-Test No. of Pulses found	Tx-Test Result	Tx-Test Comment
5320.000000	41.073	>=17 %	287	PASS	

Additional Information

Note	Description
Note 1:	Because of the radar pulse event at the beginning, the investigation of the trace begins with an offset of 26.7 ms conforming to the end of the Radar burst.
Note 2:	Channel move time (CMT) / channel closing transmission time (CCTT) measurement was made with hi resolution video sweep using OSP DAQ channel
Note 3:	Because of the substantially higher sampling rate of the video signal the results for CCTT and CMT are more accurate than in the graphics visible. Reached timing accuracy of the video trace: approx 4
Note 4:	The Non-Occupancy Period trace starts at the end of the Channel move time trace (20.000 secs.) Labeling of the x-axis (time) is relative to its beginning (0 secs.)

Radar level verification

Description	Value	Unit
Configured DUT EIRP:	31.62	mW
Configured DUT PSD:	3.00	dBm/MHz
Requirement of the Detection threshold value for this given values acc. to FCC clause 5.2 / Table 3	-62	dBm
Vector Generator level setting	11.56	dBm
Configured overall pathloss from Vector Generator RF out to DUT connector of 'DUT to OSP'-cable	71.15	dB
Given additional level added to the amplitude of the waveform to account for variations in measurement equipment acc. to FCC clause 5.2 / Table 3 / Note 2	1.00	dB
This results in the following radar signal level at the DUT	-59.59	dBm

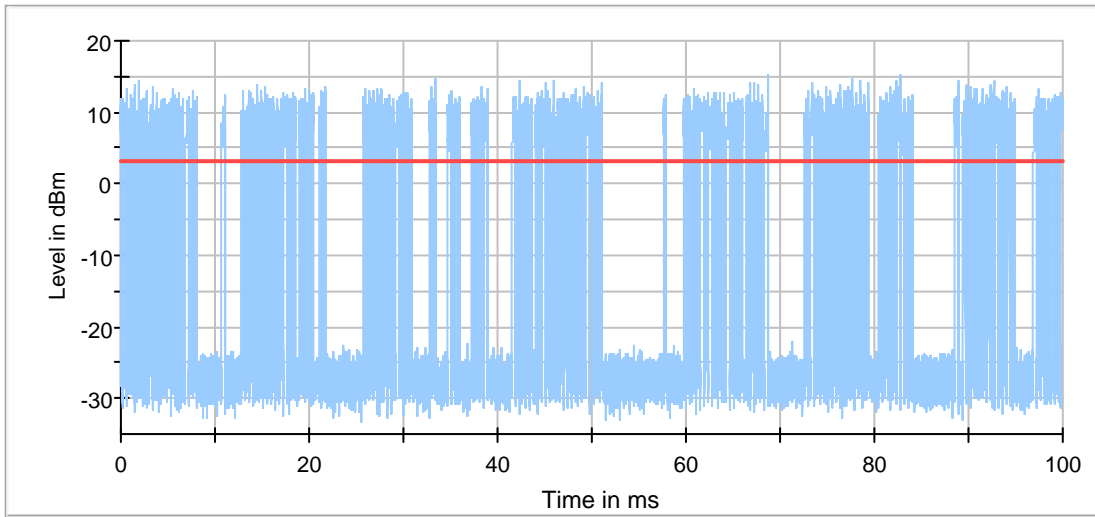

— In-Service Monitoring Transmitt Test Sweep — Threshold

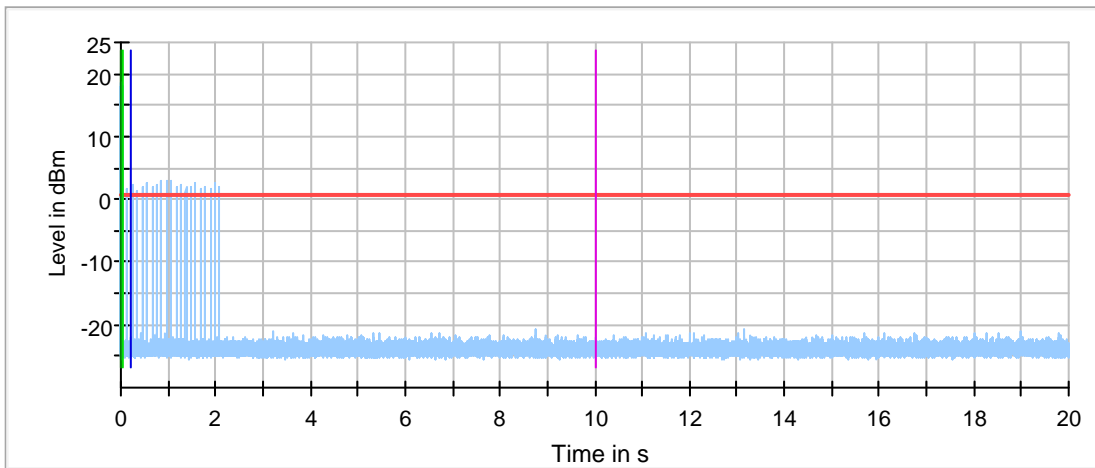

— In-Service Monitoring Channel Move Time — Threshold
 — Start of Radar — Trigger at end of Radar
 — First 200ms of Channel Closing Tx Time — 10sec Channel Move Time Limit

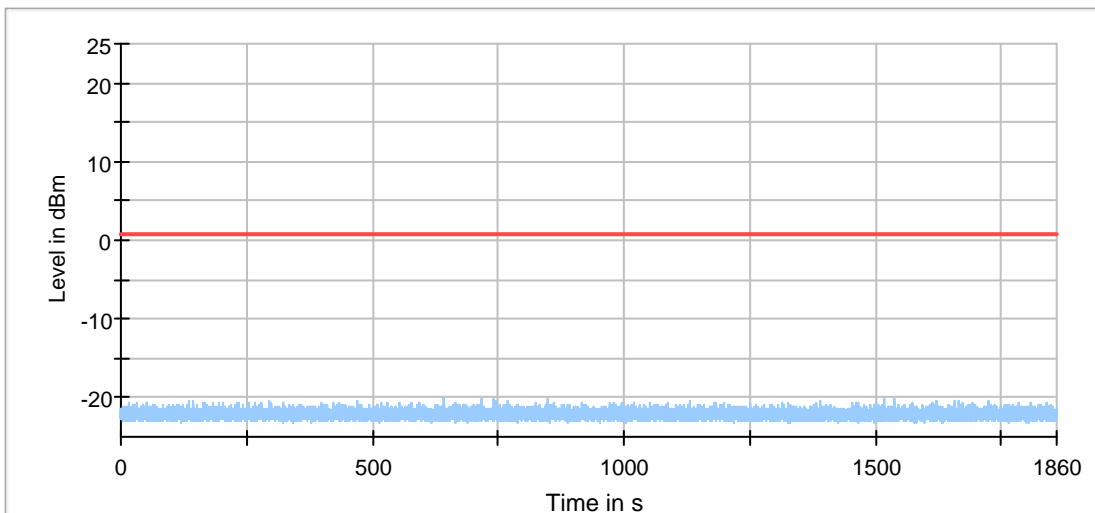

— In-Service Monitoring Non-occupancy period — Threshold

DFS In-Service Monitoring (5510 MHz; 40 MHz)

Measurement Summary

DUT Frequency (MHz)	Radar Type No.	Type of Measurement value	Overall Result
5510.000000	0	First of all Transmitt Test	PASS
5510.000000	0	Channel Move Time	PASS
5510.000000	0	Channel Closing Transmission Time	PASS
5510.000000	0	Non-occupancy period	PASS

(continuation of the "Measurement Summary" table from column 4 ...)

Channel Move Time Detailed Results

DUT Frequency (MHz)	Radar Type No.	CMT Tx Time	CMT Limit (s)	CMT Result
5510.000000	0	0.000	10.000	PASS

(continuation of the "Channel Move Time Detailed Results" table from column 5 ...)

DUT Frequency (MHz)	CMT Comment
5510.000000	Tx Time value is last trailing edge found within sweep. See Note 1.

Channel Closing Transmission Time Detailed Results

DUT Frequency (MHz)	Radar Type No.	CCTT Type of Value	CCTT No. of Pulses found	CCTT Tx Time (ms)
5510.000000	0	first 200 ms	0	0.000
5510.000000	0	remaining 10.0 second(s) period	0	0.000

(continuation of the "Channel Closing Transmission Time Detailed Results" table from column 5 ...)

DUT Frequency (MHz)	CCTT Tx Time Limit (ms)	CCTT Result	CCTT Comment
5510.000000	200.000	PASS	See Note 1.
5510.000000	60.000	PASS	See Note 1.

Non-occupancy period Detailed Results

DUT Frequency (MHz)	Radar Type No.	NOP No. of Pulses found	NOP No. of Pulses Limit	NOP Tx Time (s)	NOP Tx Time Limit (s)
5510.000000	0	0	0	0.000	0.000

(continuation of the "Non-occupancy period Detailed Results" table from column 6 ...)

DUT Frequency (MHz)	NOP Result
5510.000000	PASS

Transmitting Test Detailed Results

DUT Frequency (MHz)	Tx-Test DutyCycle (%)	Tx-Test DutyCycle Limit	Tx-Test No. of Pulses found	Tx-Test Result	Tx-Test Comment
5320.000000	41.073	>=17 %	287	PASS	

Additional Information

Note	Description
Note 1:	Because of the radar pulse event at the beginning, the investigation of the trace begins with an offset of 26.7 ms conforming to the end of the Radar burst.
Note 2:	Channel move time (CMT) / channel closing transmission time (CCTT) measurement was made with hi resolution video sweep using OSP DAQ channel
Note 3:	Because of the substantially higher sampling rate of the video signal the results for CCTT and CMT are more accurate than in the graphics visible. Reached timing accuracy of the video trace: approx 4
Note 4:	The Non-Occupancy Period trace starts at the end of the Channel move time trace (20.000 secs.) Labeling of the x-axis (time) is relative to its beginning (0 secs.)

Radar level verification

Description	Value	Unit
Configured DUT EIRP:	31.62	mW
Configured DUT PSD:	2.00	dBm/MHz
Requirement of the Detection threshold value for this given values acc. to FCC clause 5.2 / Table 3	-62	dBm
Vector Generator level setting	12.06	dBm
Configured overall pathlost from Vector Generator RF out to DUT connector of 'DUT to OSP'-cable	72.30	dB
Given additional level added to the amplitude of the waveform to account for variations in measurement equipment acc. to FCC clause 5.2 / Table 3 / Note 2	1.00	dB
This results in the following radar signal level at the DUT	-60.24	dBm

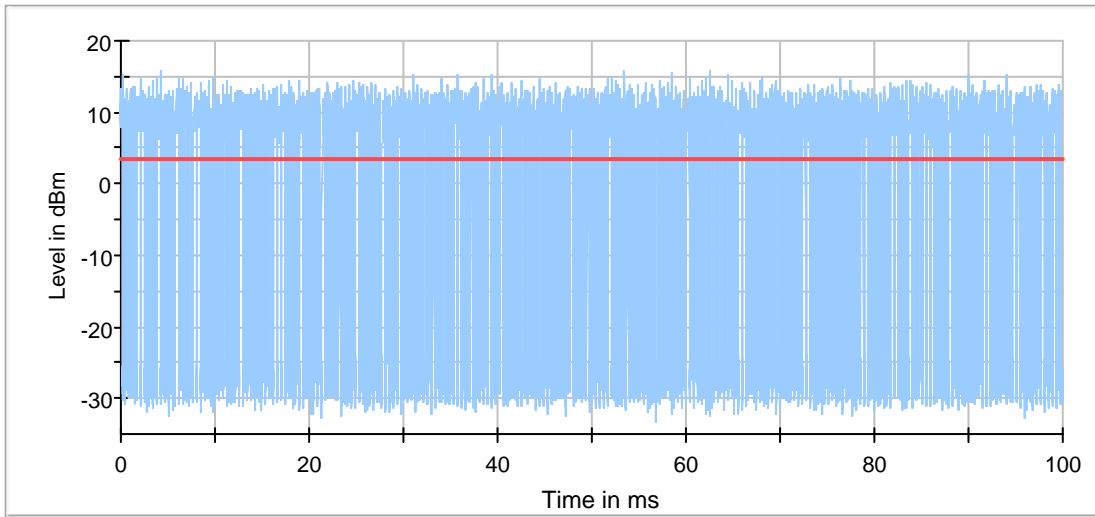

— In-Service Monitoring Transmitt Test Sweep — Threshold

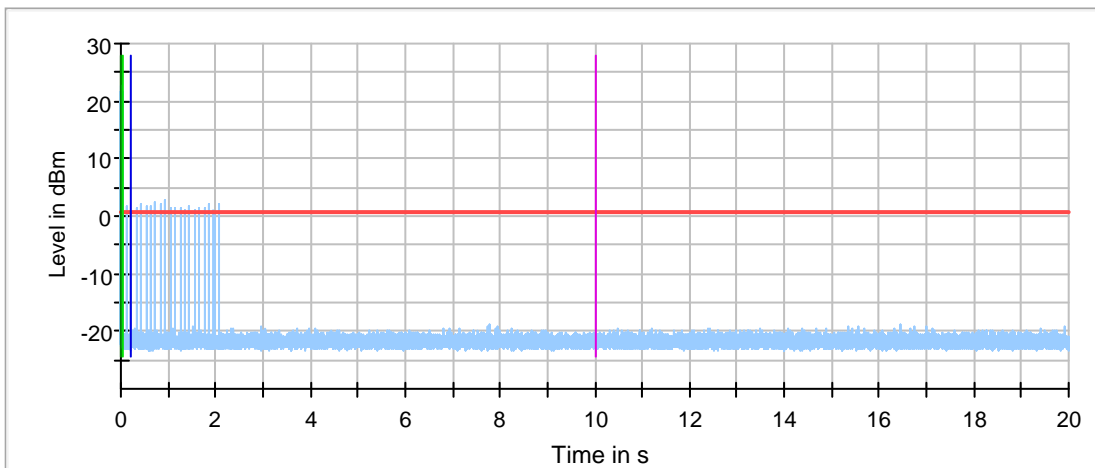

— In-Service Monitoring Channel Move Time — Threshold
 — Start of Radar — Trigger at end of Radar
 — First 200ms of Channel Closing Tx Time — 10sec Channel Move Time Limit

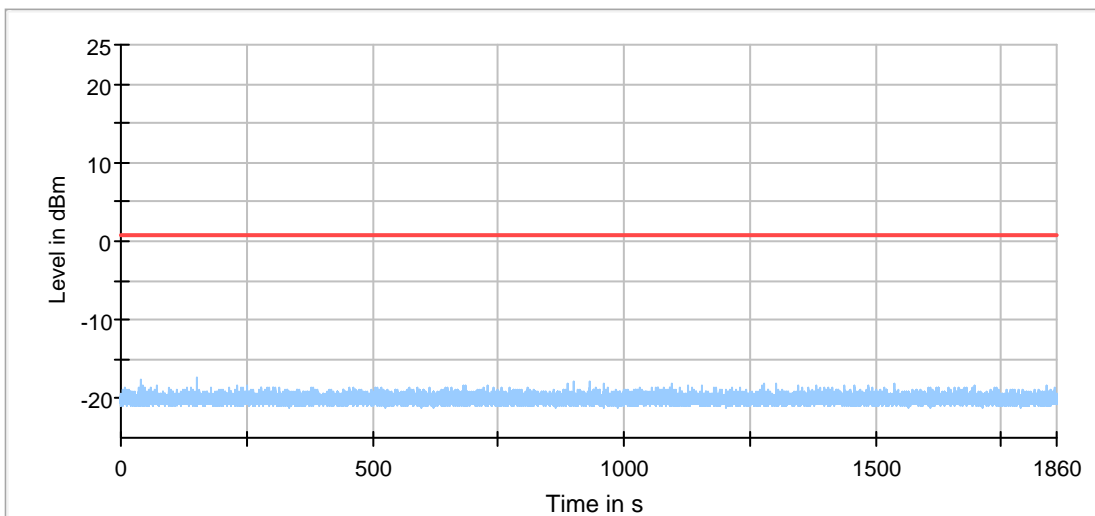

— In-Service Monitoring Non-occupancy period — Threshold

DFS In-Service Monitoring (5670 MHz; 40 MHz)

Measurement Summary

DUT Frequency (MHz)	Radar Type No.	Type of Measurement value	Overall Result
5670.000000	0	First of all Transmitt Test	PASS
5670.000000	0	Channel Move Time	PASS
5670.000000	0	Channel Closing Transmission Time	PASS
5670.000000	0	Non-occupancy period	PASS

(continuation of the "Measurement Summary" table from column 4 ...)

Channel Move Time Detailed Results

DUT Frequency (MHz)	Radar Type No.	CMT Tx Time (s)	CMT Limit (s)	CMT Result
5670.000000	0	1.983	10.000	PASS

(continuation of the "Channel Move Time Detailed Results" table from column 5 ...)

DUT Frequency (MHz)	CMT Comment
5670.000000	Tx Time value is last trailing edge found within sweep. See Note 1.

Channel Closing Transmission Time Detailed Results

DUT Frequency (MHz)	Radar Type No.	CCTT Type of Value	CCTT No. of Pulses found	CCTT Tx Time (ms)
5670.000000	0	first 200 ms	50	0.956
5670.000000	0	remaining 10.0 second(s) period	7	0.056

(continuation of the "Channel Closing Transmission Time Detailed Results" table from column 5 ...)

DUT Frequency (MHz)	CCTT Tx Time Limit (ms)	CCTT Result	CCTT Comment
5670.000000	200.000	PASS	See Note 1.
5670.000000	60.000	PASS	See Note 1.

Non-occupancy period Detailed Results

DUT Frequency (MHz)	Radar Type No.	NOP No. of Pulses found	NOP No. of Pulses Limit	NOP Tx Time (s)	NOP Tx Time Limit (s)
5670.000000	0	0	0	0.000	0.000

(continuation of the "Non-occupancy period Detailed Results" table from column 6 ...)

DUT Frequency (MHz)	NOP Result
5670.000000	PASS

Transmitting Test Detailed Results

DUT Frequency (MHz)	Tx-Test DutyCycle (%)	Tx-Test DutyCycle Limit	Tx-Test No. of Pulses found	Tx-Test Result	Tx-Test Comment
5320.000000	41.073	>=17 %	287	PASS	

Additional Information

Note	Description
Note 1:	Because of the radar pulse event at the beginning, the investigation of the trace begins with an offset of 26.7 ms conforming to the end of the Radar burst.
Note 2:	Channel move time (CMT) / channel closing transmission time (CCTT) measurement was made with hi resolution video sweep using OSP DAQ channel
Note 3:	Because of the substantially higher sampling rate of the video signal the results for CCTT and CMT are more accurate than in the graphics visible. Reached timing accuracy of the video trace: approx 4
Note 4:	The Non-Occupancy Period trace starts at the end of the Channel move time trace (20.000 secs.) Labeling of the x-axis (time) is relative to its beginning (0 secs.)

Radar level verification

Description	Value	Unit
Configured DUT EIRP:	31.62	mW
Configured DUT PSD:	2.00	dBm/MHz
Requirement of the Detection threshold value for this given values acc. to FCC clause 5.2 / Table 3	-62	dBm
Vector Generator level setting	12.06	dBm
Configured overall pathlost from Vector Generator RF out to DUT connector of 'DUT to OSP'-cable	72.30	dB
Given additional level added to the amplitude of the waveform to account for variations in measurement equipment acc. to FCC clause 5.2 / Table 3 / Note 2	1.00	dB
This results in the following radar signal level at the DUT	-60.24	dBm

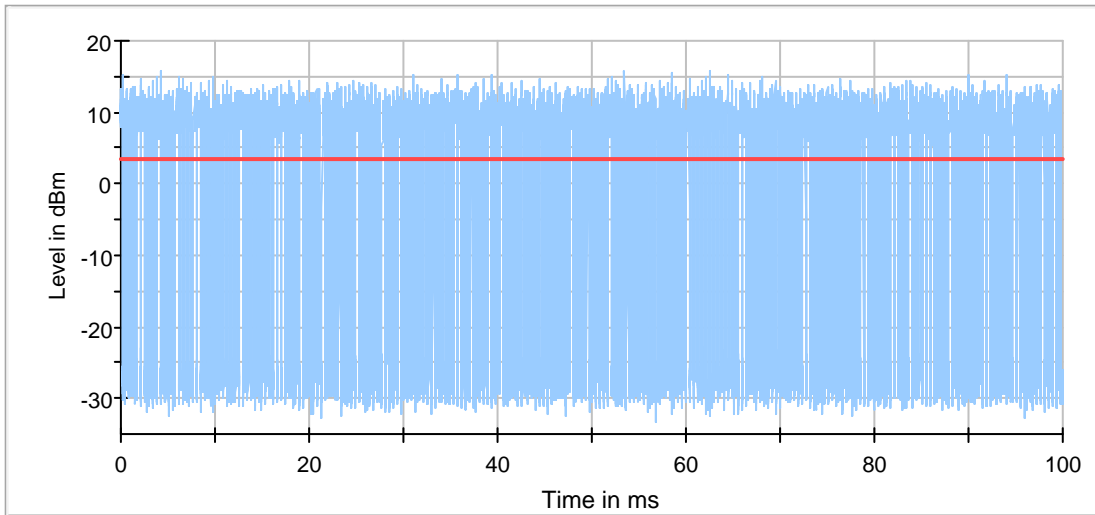

— In-Service Monitoring Transmitt Test Sweep — Threshold

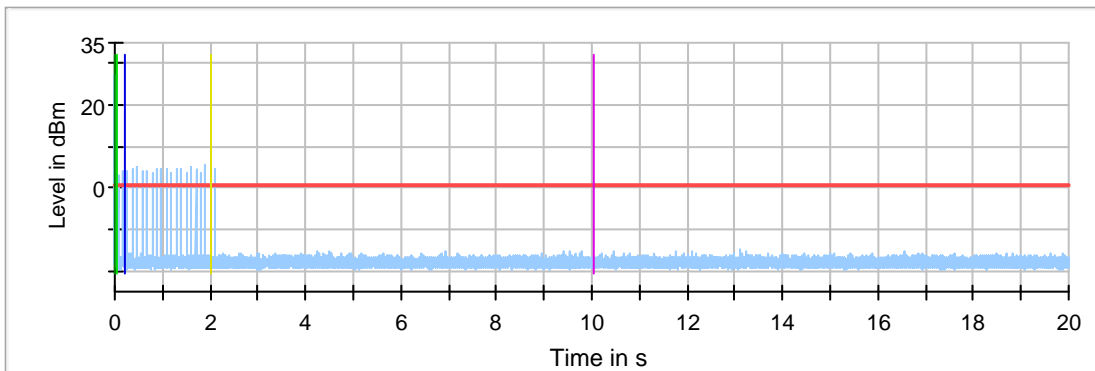

— In-Service Monitoring Channel Move Time
 — Threshold
 — Start of Radar
 — Trigger at end of Radar
 — First 200ms of Channel Closing Tx Time
 — 10sec Channel Move Time Limit
 — Last measured edge of Channel Closing Tx Time

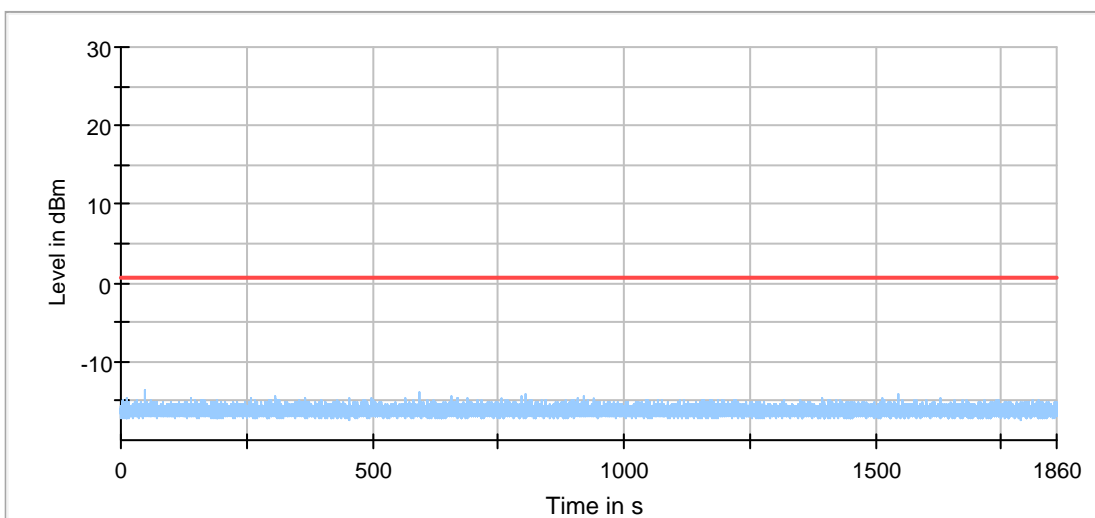

— In-Service Monitoring Non-occupancy period — Threshold

5. TEST SETUP PHOTOS



6. PHOTOS OF EUT

External Photos
M/N: ONA19TB003

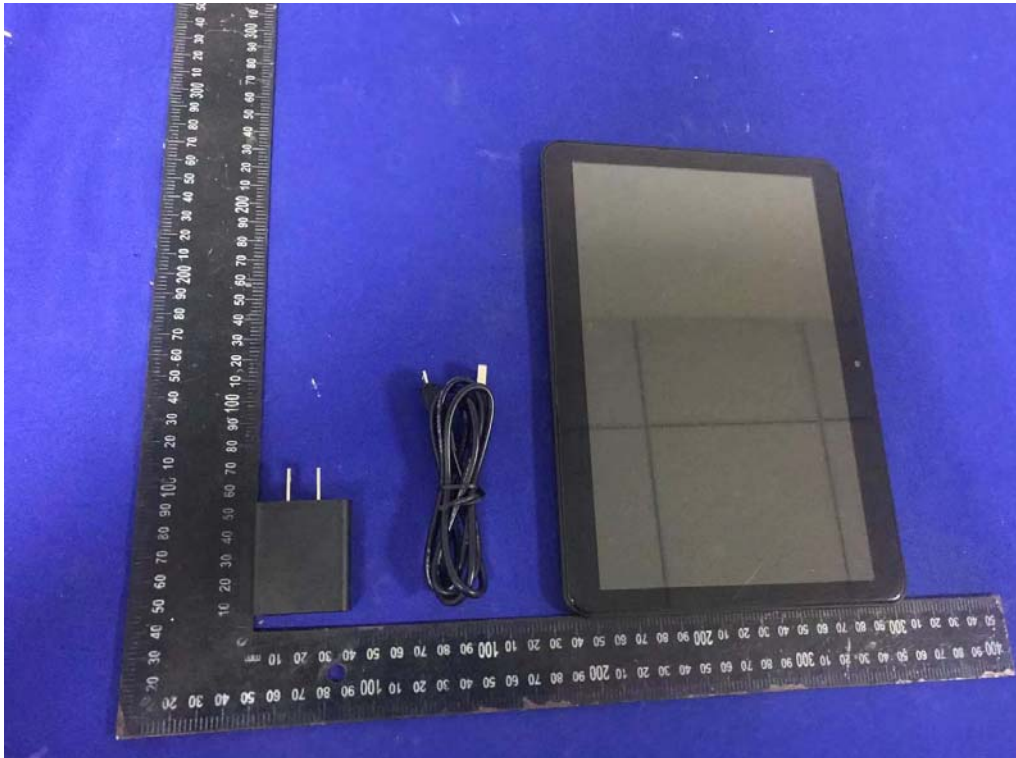

External Photos
M/N: ONA19TB003



External Photos
M/N: ONA19TB003



External Photos
M/N: ONA19TB003

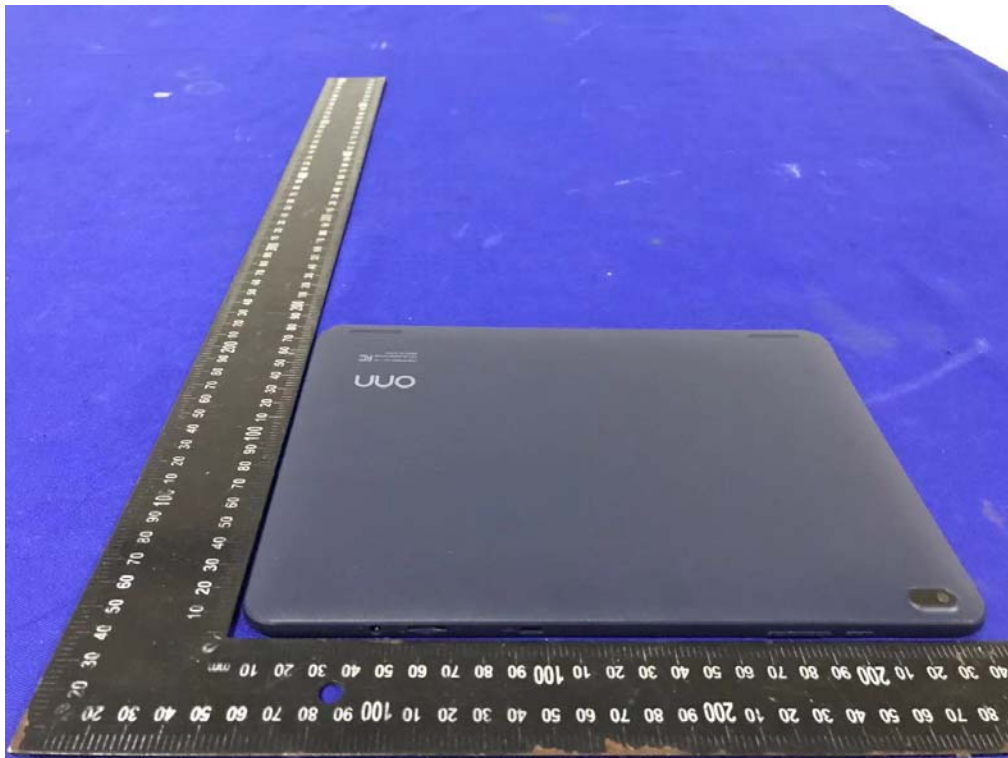

External Photos
M/N: ONA19TB003



Internal Photos
M/N: ONA19TB003

RF
Antenna

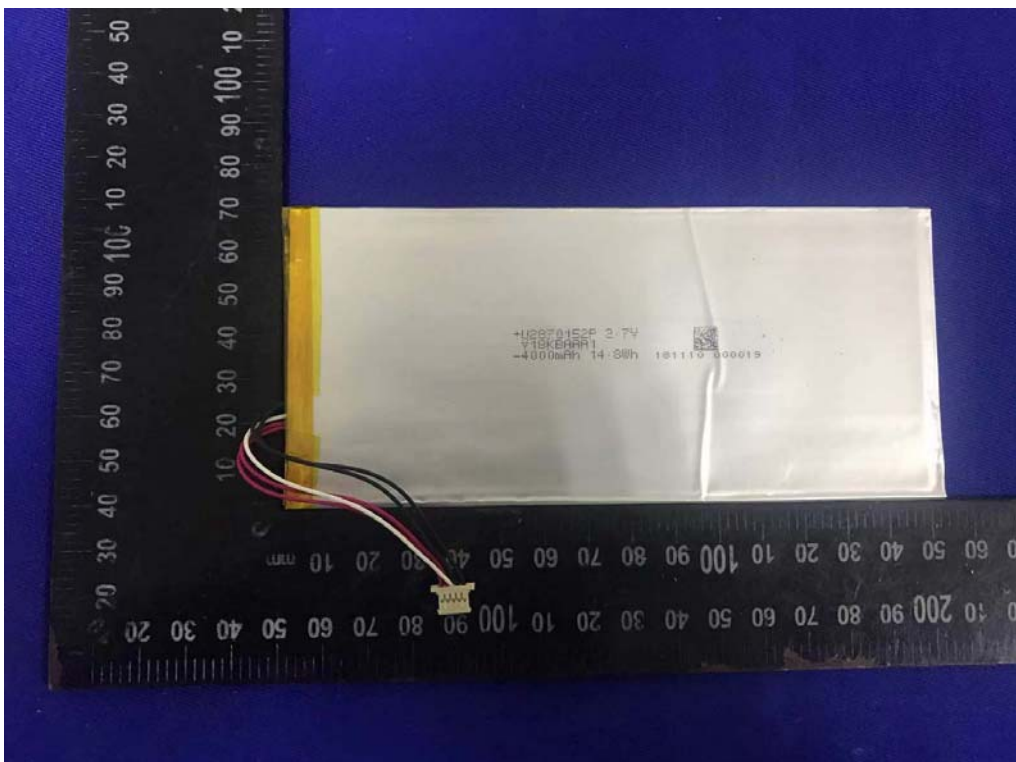
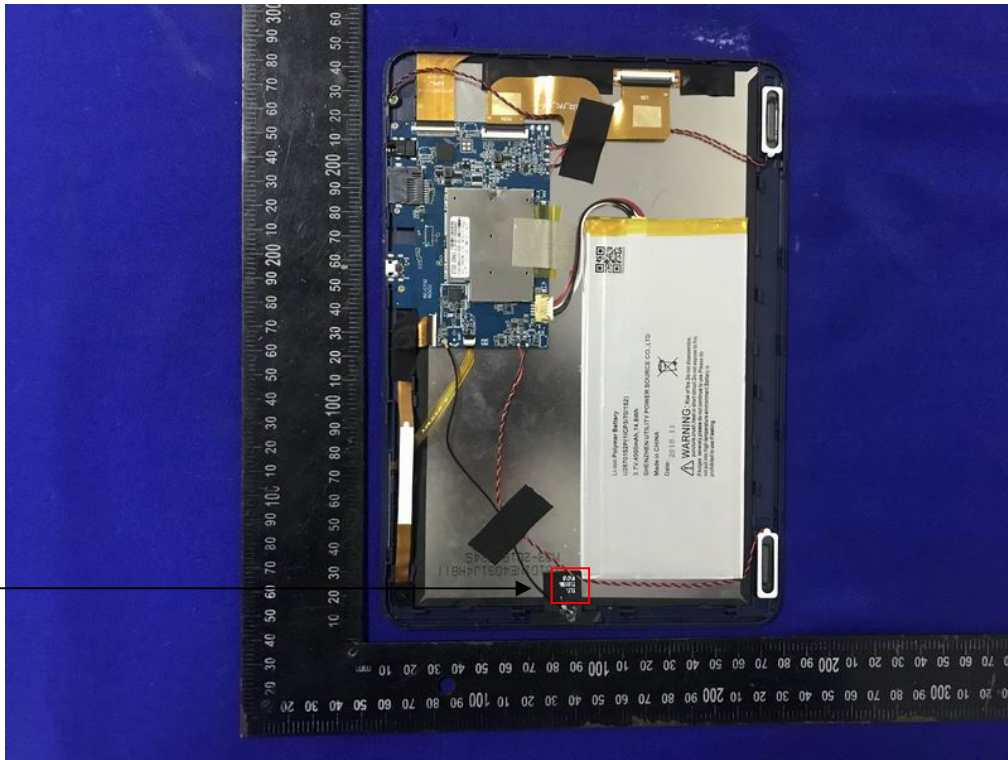

Internal Photos
M/N: ONA19TB003

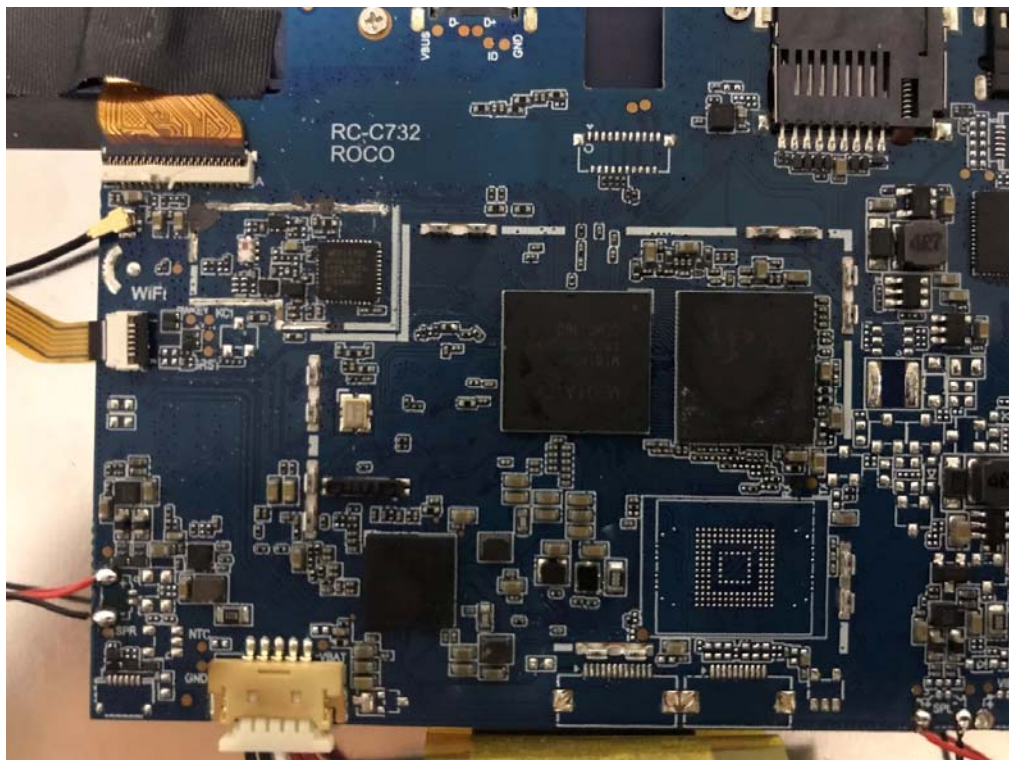
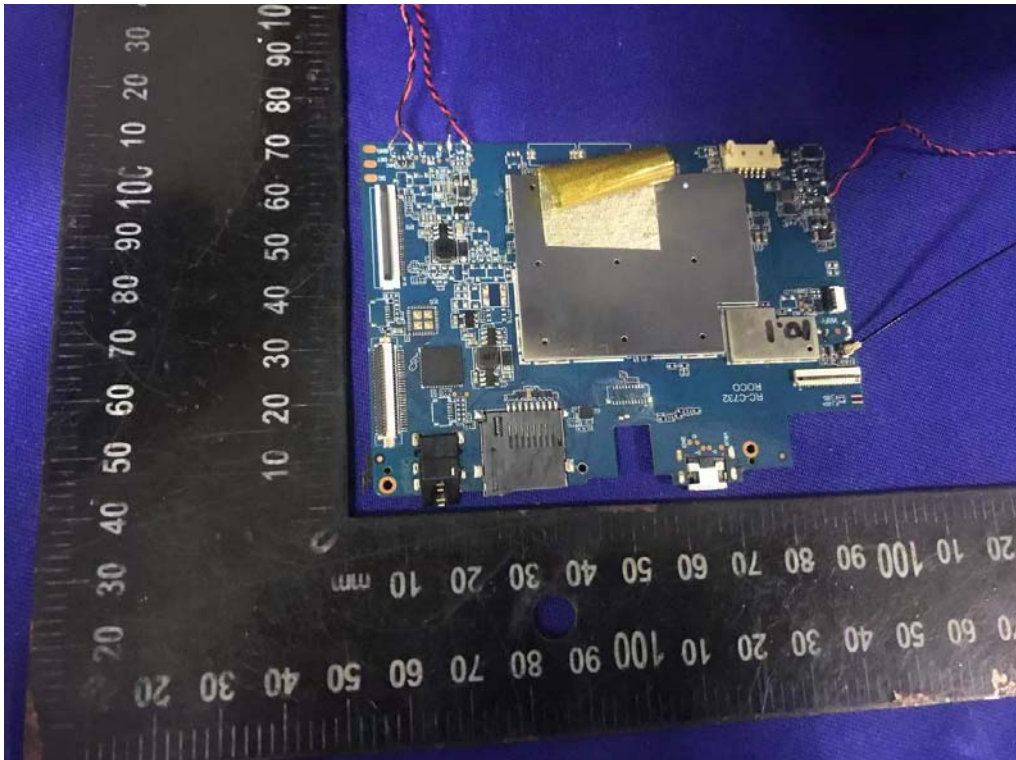

Internal Photos
M/N: ONA19TB003

RF
Antenna Port

