

Application for FCC Certificate
On Behalf of

Chunghsin Technology Group CO.,LTD

43 " LED TV

Model Number: ONC43FR19C11

FCC ID: 2AE2WONC43FR19C11

Prepared for:	Chunghsin Technology Group CO.,LTD
	NO.618-2 GONGREN WEST ROAD, JIAOJIANG AREA, TAIZHOU, ZHEJIANG China
Prepared By:	EST Technology Co., Ltd.
	Chilingxiang, Qishantou, Santun, Houjie, Dongguan, Guangdong, China
	Tel: 86-769-83081888-808





Report Number:	ESTE-F1904031
Date of Test:	March 26 ~ Apr 03, 2019
Date of Report:	Apr 03, 2019

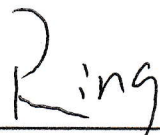

TABLE OF CONTENTS

	Page
Test Report Declaration	4
1. GENERAL PRODUCT INFORMATION	4
1.1. Product Function	4
1.2. Description of Device (EUT)	4
1.3. Difference between Model Numbers	4
1.4. Independent Operation Modes	4
2. TEST SITES	5
2.1. Description of Standards and Results	5
2.2. Test Facilities	6
2.3. List of Test and Measurement Instruments	7
3. TEST SET-UP AND OPERATION MODES	8
3.1. Principle of Configuration Selection	8
3.2. Block Diagram of Test Set-up	8
3.3. Test Operation Mode and Test Software	8
3.4. Special Accessories and Auxiliary Equipment	8
3.5. Countermeasures to Achieve EMC Compliance	10
4. EMISSION TEST RESULTS	11
4.1. Conducted Emission at the Mains Terminals Test	11
4.2. Radiated Emission Test	14

EST Technology Co., Ltd.

Applicant:	Chunghsin Technology Group CO.,LTD		
Address:	NO.618-2 GONGREN WEST ROAD, JIAOJIANG AREA, TAIZHOU, ZHEJIANG China		
Manufacturer:	Chunghsin Technology Group CO.,LTD		
Address:	NO.618-2 GONGREN WEST ROAD, JIAOJIANG AREA, TAIZHOU, ZHEJIANG China		
Factory :	Chunghsin Technology Group CO.,LTD		
Address:	NO.618-2 GONGREN WEST ROAD, JIAOJIANG AREA, TAIZHOU, ZHEJIANG China		
E.U.T:	43" LED TV		
Model Number:	ONC43FR19C11		
Trade Name:	ONN	Serial No.:	-----
Date of Receipt:	March 26 2019	Date of Test:	March 26 ~ Apr 04, 2019
Test Specification:	FCC Rules and Regulations Part 15 Subpart B:2018 ANSI C63.4:2014		
Test Result:	<p>The device described above is tested by EST Technology Co., Ltd.. The measurement results were contained in this test report and EST Technology Co., Ltd. was assumed full responsibility for the accuracy and completeness of these measurements. Also, this report shows that the EUT to be technically compliance with the FCC Rules and Regulations Part 15 Subpart B requirements. This report applies to above tested sample only and shall not be reproduced in part without written approval of EST Technology Co., Ltd.</p> <p style="text-align: right;">Issue Date: Apr 04, 2019</p>		
Prepared by:	Reviewed by:	Approved by:	
 <hr style="width: 100%;"/> Ring / Assistant	 <hr style="width: 100%;"/> Tony / Engineer	 <hr style="width: 100%;"/> Iceman Hu / Manager	
			
Other Aspects:	None.		
Abbreviations: OK/P=passed fail/F=failed n.a/N=not applicable E.U.T=equipment under tested			

1. GENERAL PRODUCT INFORMATION

1.1. Product Function

Refer to Technical Construction Form and User Manual.

1.2. Description of Device (EUT)

Description : LED TV
 Model No. : ONC43FR19C11
 System Input Voltage : AC 120V/60Hz
 Power : 70W

1.3. Difference between Model Numbers

Note: N/A

1.4. Independent Operation Modes

1.4.1. Conducted Modes

1	HDMI	Worst case
2	NTSC CH2/14/125	
3	ATSC CH2/34/69	
4	AV IN	
5	USB Play	
Note: The worst case will be recorded in this report.		

1.4.2. Radiated Modes

30MHz~1GHz		
1	HDMI	
2	NTSC CH2/14/125	Worst case
3	ATSC CH2/34/69	
4	AV IN	
5	USB Play	
Above 1GHz		
1	HDMI	Worst case
2	NTSC CH2/14/125	
3	ATSC CH2/34/69	
4	AV IN	
5	USB Play	
Note: The worst case will be recorded in this report.		

2. TEST SITES

2.1. Description of Standards and Results

The EUT have been tested according to the applicable standards as referenced below

EMISSION			
Description of Test Item	Standard	Limits	Results
Conducted disturbance at mains terminals	FCC Rules and Regulations Part 15 Subpart B:2018 ANSI C63.4:2014	15.107(a) Class B	PASS
		Minimum passing margin is 7.12dB at 4.87MHz	
Radiated Emission Test	FCC Rules and Regulations Part 15 Subpart B:2018 ANSI C63.4:2014	15.109(a) Class B	PASS
		Minimum passing margin is 3.34dB at 296.403MHz for 30-1000MHz; Minimum passing margin is 7.18dB at 2970.00MHz for above 1GHZ;	

2.2. Test Facilities

EMC Lab : Certificated by CNAS, CHINA
Registration No.: L5288
Date of registration: November 13, 2017

Certificated by FCC, USA
Designation Number: CN1215
Test Firm Registration Number: 722932
Date of registration: November 21, 2017

Certificated by A2LA, USA
Registration No.: 4366.01
Date of registration: November 07, 2017

Certificated by Industry Canada
CAB identifier No.: CN0035
Date of registration: January 04, 2019

Certificated by VCCI, Japan
Registration No.: R-13663; C-14103
Date of registration: July 25, 2017
This Certificate is valid until: July 24, 2020

Certificated by TUV Rheinland, Germany
Registration No.: UA 50413872 0001
Date of registration: July 31, 2018

Certificated by TUV/PS, Shenzhen
Registration No.: SCN1017
Date of registration: January 27, 2011

Certificated by Intertek ETL SEMKO
Registration No.: 2011-RTL-L2-64
Date of registration: April 28, 2011

Certificated by Nemko, Hong Kong
Registration No.: 175193
Date of registration: May 4, 2011

Name of Firm : EST Technology Co., Ltd.

Site Location : Chilingxiang, Qishantou, Santun, Houjie, Dongguan, Guangdong, China

2.3. List of Test and Measurement Instruments

2.3.1. For conducted emission at the mains terminals test (844 Room)

Equipment	Manufacturer	Model No.	Serial No.	Last Cal.	Next Cal.
EMI Test Receiver	Rohde & Schwarz	ESHS30	832354	June 15,18	1 Year
Artificial Mains Network	Rohde & Schwarz	ENV216	101260	June 15,18	1 Year
Pulse Limiter	Rohde & Schwarz	ESH3-Z2	101100	June 15,18	1 Year
Test Software	Audix	e3-6.111221a	N/A	N/A	N/A

2.3.2. For radiated emission test

Equipment	Manufacturer	Model No.	Serial No.	Last Cal.	Next Cal.
EMI Test Receiver	Rohde & Schwarz	ESR7	101780	June 15,18	1 Year
Bilog Antenna	Teseq	CBL 6111D	37062	June 15,18	1 Year
Horn Antenna	SCHWARZBECK	BBHA9120D	8128-290	June 18,18	3 Year
Signal Amplifier	SCHWARZBECK	BBV9718	9718-212	June 15,18	1 Year
Test Software	Audix	e3-6.111221a	N/A	N/A	N/A

3. TEST SET-UP AND OPERATION MODES

3.1. Principle of Configuration Selection

Emission: The equipment under test (EUT) was configured to measure its highest possible radiation level. The test modes were adapted accordingly in reference to the Operating Instructions.

3.2. Block Diagram of Test Set-up

System Diagram of Connections between EUT and Simulators

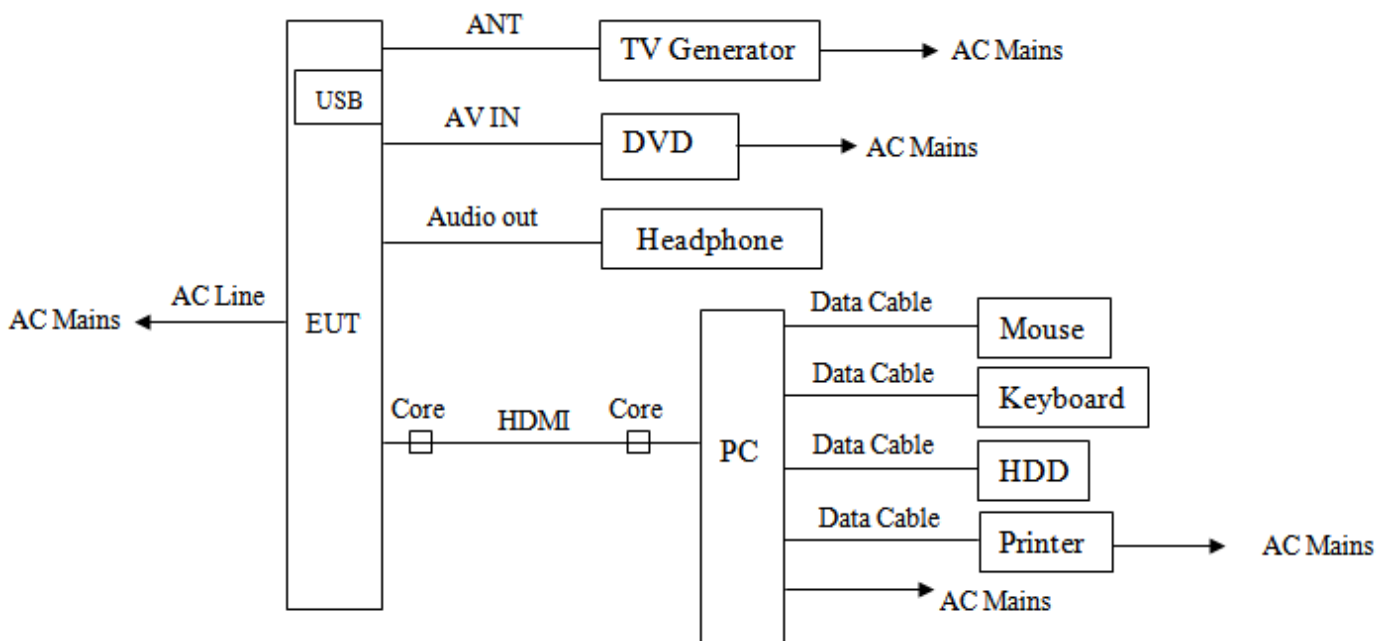

(EUT: LED TV)

A	AC Line	Unshielded, Undetachable 1.5 m
B	AV IN	Unshielded, Detachable 1.2 m
C	Audio out	Unshielded, Detachable 1.2 m
D	HDMI	Shielded, Detachable 1.2 m

3.3. Test Operation Mode and Test Software

Refer to Test Setup in clause 4.

3.4. Special Accessories and Auxiliary Equipment

3.4.1. DELL PC (4K)

M / N : Precision Tower 3620

S / N : 23TH6H2
Manufacturer : DELL

3.4.2. Keyboard

M / N : L100
S / N : CN-0RH656-65890-01M-070T
Manufacturer : Dell
Data Cable : Shielded, Undetachable, 1.8m

3.4.3. Mouse

M / N : L100
S / N : CN-0RH656-65890-01M-070T
Manufacturer : Dell
Data Cable : Shielded, Undetachable, 1.8m

3.4.4. TV Generator

M / N : SFE
S / N : 121120
Manufacturer : R&S
Data Cable : Shielded, Detachable, 1.6m

3.4.5. U Disc

M / N : SDCZ7-4096
S / N : BH0701AGOB
Manufacturer : SanDisk

3.4.6. HDD

M / N : iPod/A1238
S / N : 8K044D2Z9ZU
Manufacturer : Apple

3.4.7. Earphone

M / N : KDM-430
Manufacturer : KEENION
Data Cable : Unshielded, Undetachable, 1.6m

3.4.8. Printer

M / N : HP LaserJet 1020 Plus
Manufacturer : HP
AC Line : Unshielded, Detachable 1.2m
USB Line : Unshielded, Detachable 1.2m

3.4.9. DVD Player (4K)

M / N : BDP-G4350
S / N : BD43504KXX17011600701
Manufacturer : GIEC

3.5. Countermeasures to Achieve EMC Compliance

None.

4. EMISSION TEST RESULTS

4.1. Conducted Emission at the Mains Terminals Test

RESULT : **Pass**
Test Procedure : ANSI C63.4:2014
Frequency Range : 0.15 to 30MHz
Test Site : Shielded Room
Limits : FCC Part 15:2018 Class B

Test Setup

Date of Test : March 27,2019
M/N : ONC43FR19C11
Input Voltage : AC 120V/60Hz
Operation Mode : NTSC CH2

The frequency range from 150 kHz to 30 MHz was investigated.

The bandwidth of the test receiver was set at 9 kHz.

The test data of the worst case condition(s) was reported on the following page.

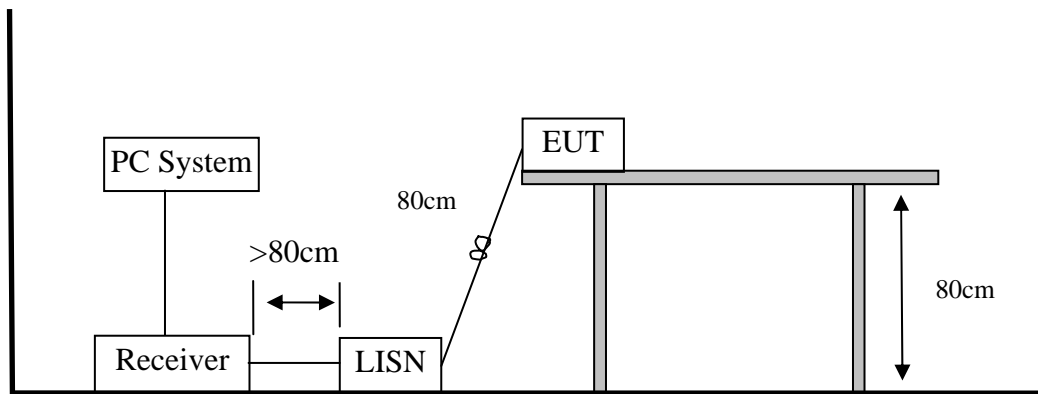

Note: Measurement Uncertainty: ± 3.48 dB at a level of confidence of 95%.

Test Data

EST Technology

Chilingxiang, Qishantou, Santun,
Houjie, Dongguan, Guangdong, China
Tel: +86-769-83081888
Fax: +86-769-83081878

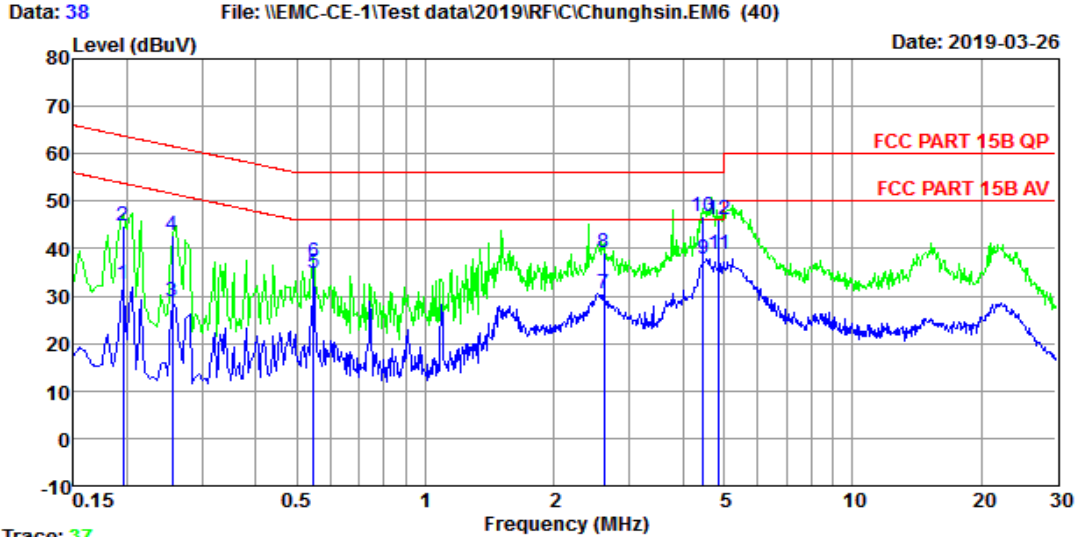

Trace: 37
 Site no : 844 Shield Room Data no. : 38
 Env. / Ins. : Temp:22.7;æ Humi:68% Press:101.50kPa LINE Phase : NEUTRAL
 Limit : FCC PART 15B QP
 Engineer : WS
 EUT : 43" LED TV
 Power : AC 120V/60Hz
 M/N : ONC43FR19C11
 Test Mode : HDMI

	Freq. (MHz)	LISN Factor (dB)	Cable Loss (dB)	Reading (dBuV)	Emission Level (dBuv)	Limits (dBuv)	Margin (dB)	Remark
1	0.20	9.66	0.04	22.70	32.40	53.80	21.40	Average
2	0.20	9.66	0.04	35.20	44.90	63.80	18.90	QP
3	0.25	9.68	0.04	19.03	28.75	51.60	22.85	Average
4	0.25	9.68	0.04	33.18	42.90	61.60	18.70	QP
5	0.55	9.76	0.05	24.93	34.74	46.00	11.26	Average
6	0.55	9.76	0.05	27.19	37.00	56.00	19.00	QP
7	2.62	9.86	0.07	20.57	30.50	46.00	15.50	Average
8	2.62	9.86	0.07	29.07	39.00	56.00	17.00	QP
9	4.48	9.90	0.07	27.77	37.74	46.00	8.26	Average
10	4.48	9.90	0.07	36.93	46.90	56.00	9.10	QP
11	4.87	9.91	0.07	28.90	38.88	46.00	7.12	Average
12	4.87	9.91	0.07	36.22	46.20	56.00	9.80	QP

Remarks: 1. Emission Level= LISN Factor + Cable Loss + Reading.
 2. Margin=Limit - Emission Level.
 3. If the average limit is met when using a quasi-peak detector, the EUT shall be deemed to meet both limits and measurement with average detector is unnecessary.



EST Technology

Chilingxiang, Qishantou, Santun,
Houjie, Dongguan, Guangdong, China
Tel: +86-769-83081888
Fax: +86-769-83081878

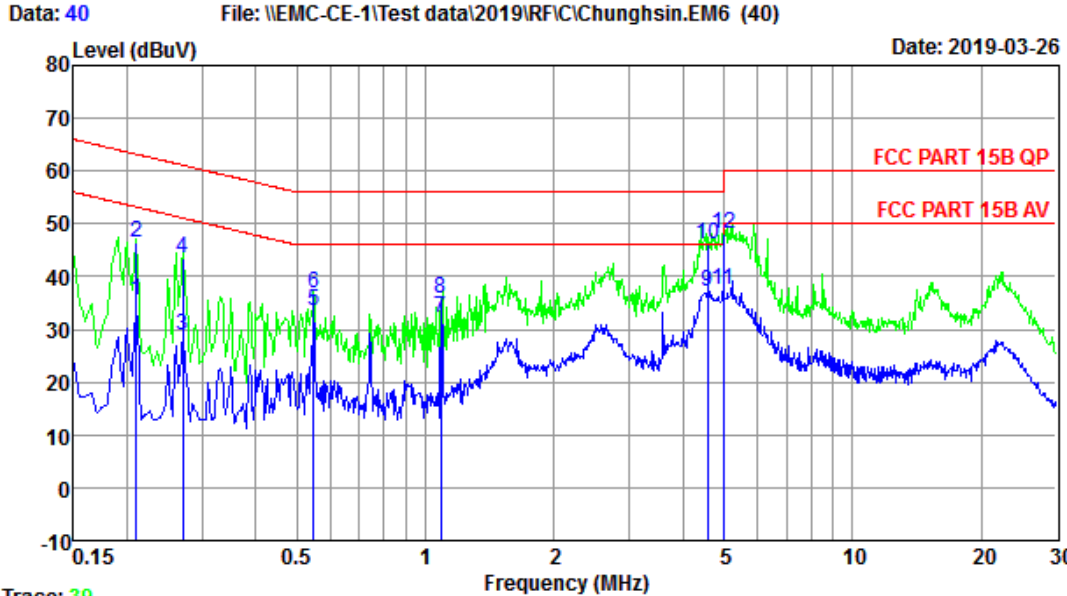

Trace: 39
 Site no : 844 Shield Room Data no. : 40
 Env. / Ins. : Temp:22.7;æ Humi:68% Press:101.50kPa LINE Phase : LINE
 Limit : FCC PART 15B QP
 Engineer : WS
 EUT : 43" LED TV
 Power : AC 120V/60Hz
 M/N : ONC43FR19C11
 Test Mode : HDMI

	Freq. (MHz)	LISN Factor (dB)	Cable Loss (dB)	Reading (dBuV)	Emission Level (dBuv)	Limits (dBuv)	Margin (dB)	Remark
1	0.21	9.68	0.04	25.83	35.55	53.18	17.63	Average
2	0.21	9.68	0.04	36.88	46.60	63.18	16.58	QP
3	0.27	9.70	0.04	19.18	28.92	51.12	22.20	Average
4	0.27	9.70	0.04	33.86	43.60	61.12	17.52	QP
5	0.55	9.76	0.05	23.81	33.62	46.00	12.38	Average
6	0.55	9.76	0.05	27.09	36.90	56.00	19.10	QP
7	1.09	9.79	0.06	22.28	32.13	46.00	13.87	Average
8	1.09	9.79	0.06	26.05	35.90	56.00	20.10	QP
9	4.57	9.85	0.07	27.31	37.23	46.00	8.77	Average
10	4.57	9.85	0.07	36.28	46.20	56.00	9.80	QP
11	4.98	9.85	0.07	27.41	37.33	46.00	8.67	Average
12	4.98	9.85	0.07	38.08	48.00	56.00	8.00	QP

Remarks: 1. Emission Level= LISN Factor + Cable Loss + Reading.
 2. Margin=Limit - Emission Level.
 3. If the average limit is met when using a quasi-peak detector, the EUT shall be deemed to meet both limits and measurement with average detector is unnecessary.



4.2. Radiated Emission Test

RESULT : **Pass**
Test Procedure : ANSI C63.4:2014
Frequency Range : 30-1000 MHz;1-6 GHz
Test Site : 966 Chamber
Limits : FCC Part 15:2018 Class B

Test Setup

Date of Test : March 29,2019
M/N : ONC43FR19C11
Input Voltage : AC 120V/60Hz
Operation Mode : NTSC,HDMI

The EUT was placed on a turn table which was 0.8 m above the ground. The turn table can rotate 360 degrees to determine the position of the maximum emission level. The EUT was set 3 m away from the receiving antenna which was mounted on an antenna tower. The measuring antenna moved up and down to find out the maximum emission level. It moved from 1 m to 4 m for both horizontal and vertical polarizations.

The EUT was tested in the Chamber Site. It was pre-scanned with a Peak detector from the spectrum, and all the final readings from the test receiver were measured with the Quasi-Peak detector.

The bandwidth setting on the test receiver was 120 kHz.

The bandwidth of the Spectrum's VBW is set at 3MHz and RBW is set at 1MHz for peak emissions measurement above 1GHz and 1MHz RBW, 10Hz VBW for average emissions measure above 1GHz

The test data of the worst case condition(s) was reported on the following page.

1、 In Semi-anechoic Chamber Test Setup Diagram for 30MHz~1000MHz

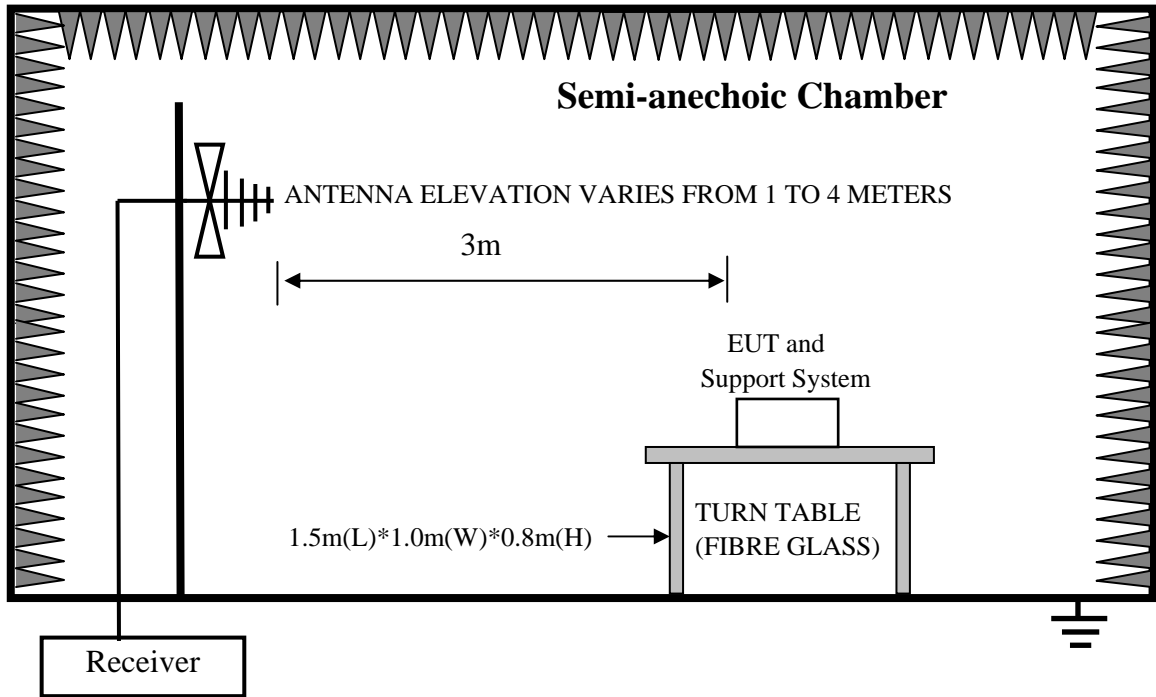

2、 In Anechoic Chamber Test Setup Diagram for 1-6GHz

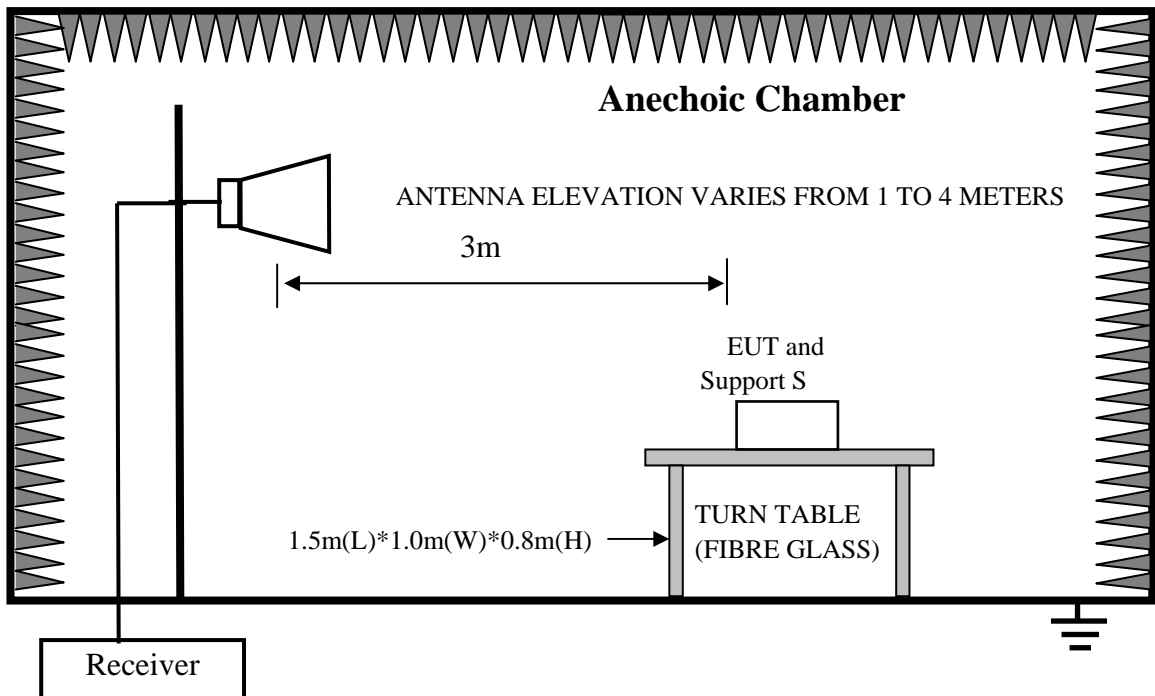

Note: Test uncertainty: ± 4.6 dB (H); ± 4.68 dB (V) at a level of confidence of 95%(30MHz ~ 1GHz); Test uncertainty: ± 4.96 dB at a level of confidence of 95%(Above 1GHz).

Test Data
30MHz-1GHz

EST Technology

Chilingxiang, Qishantou, Santun,
Houjie, Dongguan, Guangdong, China
Tel: +86-769-83081888
Fax: +86-769-83081878

Data: 25 File: \\Emc-966-1\test data\2019\EMC\C\Chunghsin-1.EM6 (36) Date: 2019-03-29

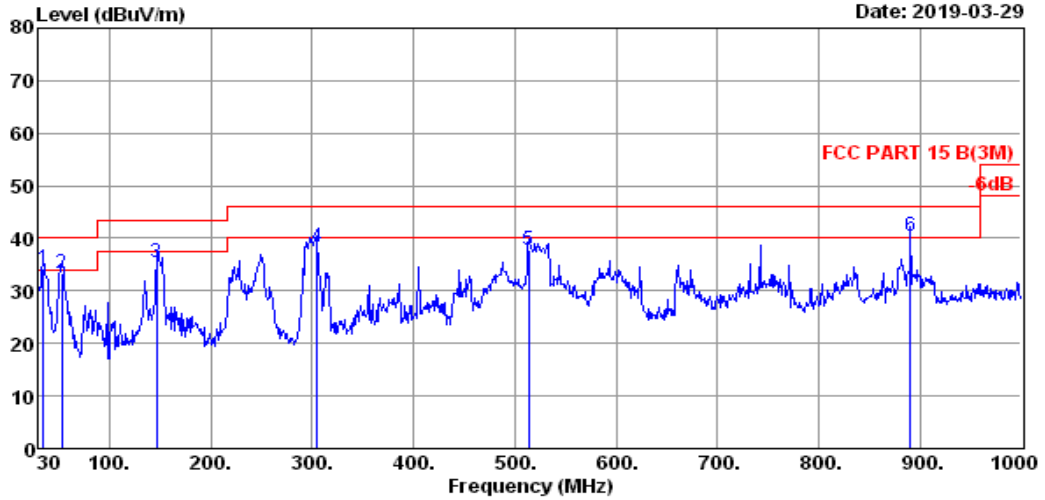

Site no. : 1# 966 Chamber Data no. : 25
 Dis. / Ant. : 3m 37062 Ant. pol. : VERTICAL
 Limit : FCC PART 15 B(3M)
 Env. / Ins. : Temp:22';Humi:64%;Press:101.52kPa
 Engineer : ZERO
 EUT : 43" LED TV
 Power : AC 120V/60Hz
 M/N : ONC43FR19C11
 Test Mode : NTSC CH 2

	Freq. (MHz)	ANT Factor (dB/m)	Cable Loss (dB)	Reading (dBuV)	Emission Level (dBuV/m)	Limit (dBuV/m)	Margin (dB)	Remark
1	34.850	16.45	0.19	17.60	34.24	40.00	5.76	QP
2	53.280	7.50	0.33	25.68	33.51	40.00	6.49	QP
3	146.400	11.58	1.05	22.90	35.53	43.50	7.97	QP
4	304.510	13.75	1.86	22.73	38.34	46.00	7.66	QP
5	514.030	18.48	2.72	16.54	37.74	46.00	8.26	QP
6	890.390	23.60	3.87	12.88	40.35	46.00	5.65	QP

Remarks: 1. Emission Level= Antenna Factor + Cable Loss + Reading.
 2. Margin= Limit - Emission Level.
 3. The emission levels that are 20dB below the official limit are not reported.



EST Technology

Chilingxiang, Qishantou, Santun,
Houjie, Dongguan, Guangdong, China
Tel: +86-769-83081888
Fax: +86-769-83081878

Data: 26 File: \\Emc-966-1\test data\2019\EMC\C\Chunghsin-1.EM6 (36)

Date: 2019-03-29

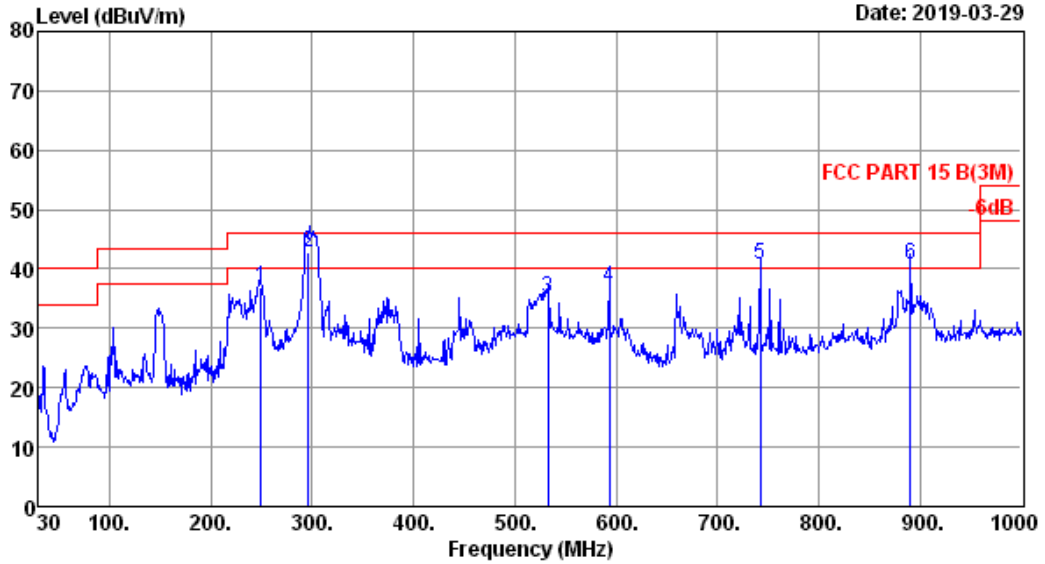

Site no. : 1# 966 Chamber Data no. : 26
 Dis. / Ant. : 3m 37062 Ant. pol. : HORIZONTAL
 Limit : FCC PART 15 B(3M)
 Env. / Ins. : Temp:22';Humi:64%;Press:101.52kPa
 Engineer : ZERO
 EUT : 43" LED TV
 Power : AC 120V/60Hz
 M/N : ONC43FR19C11
 Test Mode : NTSC CH 2

	Freq. (MHz)	ANT Factor (dB/m)	Cable Loss (dB)	Reading (dBuV)	Emission Level (dBuV/m)	Limit (dBuV/m)	Margin (dB)	Remark
1	249.220	12.10	1.62	23.30	37.02	46.00	8.98	QP
2	296.403	13.64	1.82	27.20	42.66	46.00	3.34	QP
3	532.460	18.94	2.79	13.41	35.14	46.00	10.86	QP
4	593.570	19.97	2.95	14.03	36.95	46.00	9.05	QP
5	741.980	21.74	3.62	15.44	40.80	46.00	5.20	QP
6	890.390	23.60	3.87	13.18	40.65	46.00	5.35	QP

Remarks: 1. Emission Level= Antenna Factor + Cable Loss + Reading.
 2. Margin= Limit - Emission Level.
 3. The emission levels that are 20dB below the official limit are not reported.



Above 1GHz

EST Technology

Chilingxiang, Qishantou, Santun,
Houjie, Dongguan, Guangdong, China
Tel:+86-769-83081888
Fax:+86-769-83081878

Data: 18 File: \\Emc-966-1\test data\2019\EMC\C\Chunghsin.EM6 (72) Date: 2019-03-29

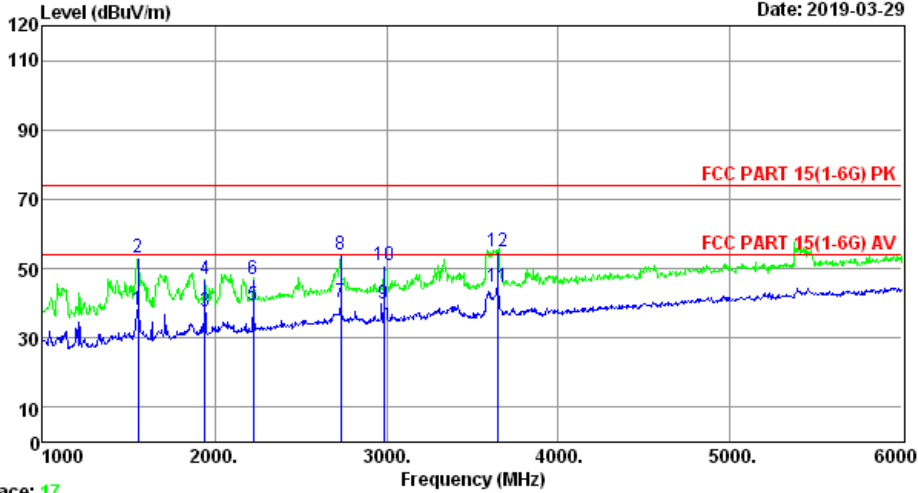

Trace: 17
 Site no. : 1# 966 Chamber Data no. : 18
 Dis. / Ant. : 3m 9L20D 1-18G Ant. pol. : VERTICAL
 Limit : FCC PART 15(1-6G) PK
 Env. / Ins. : Temp:26.4';Humi:52.4%;Press:101.52kPa
 Engineer : ZERO
 EUT : 43" LED TV
 Power : AC 120V/60Hz
 M/N : ONC43FR19C11
 Test Mode : HDMI

	Freq. (MHz)	ANT Factor (dB/m)	Cable Loss (dB)	Reading (dBuV)	Emission Level (dBuV/m)	Limit (dBuV/m)	Margin (dB)	Remark
1	1555.000	25.07	2.34	10.55	37.96	54.00	16.04	Average
2	1555.000	25.07	2.34	25.69	53.10	74.00	20.90	Peak
3	1945.000	26.48	2.59	8.71	37.78	54.00	16.22	Average
4	1945.000	26.48	2.59	17.83	46.90	74.00	27.10	Peak
5	2225.000	27.01	2.76	9.57	39.34	54.00	14.66	Average
6	2225.000	27.01	2.76	17.23	47.00	74.00	27.00	Peak
7	2735.000	27.96	3.11	9.28	40.35	54.00	13.65	Average
8	2735.000	27.96	3.11	22.93	54.00	74.00	20.00	Peak
9	2985.000	28.56	3.28	8.01	39.85	54.00	14.15	Average
10	2985.000	28.56	3.28	19.06	50.90	74.00	23.10	Peak
11	3645.000	28.82	3.76	12.00	44.58	54.00	9.42	Average
12	3645.000	28.82	3.76	22.42	55.00	74.00	19.00	Peak

Remarks: 1. Emission Level= Antenna Factor + Cable Loss + Reading.
 2. Margin= Limit - Emission Level.
 3. The emission levels that are 20dB below the official limit are not reported.



Data: 20 File: \\Emc-966-1\test data\2019\EMC\C\Chunghsin.EM6 (72) Date: 2019-03-29

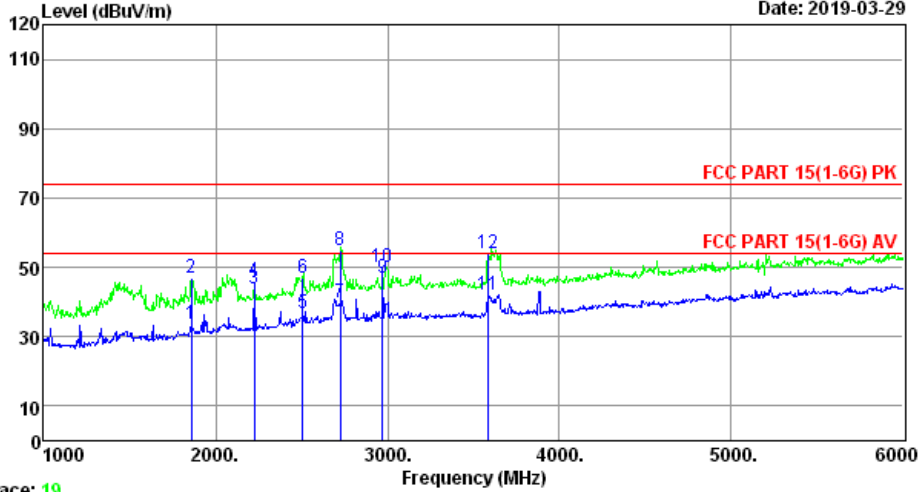

Trace: 19
 Site no. : 1# 966 Chamber Data no. : 20
 Dis. / Ant. : 3m 9120D 1-18G Ant. pol. : HORIZONTAL
 Limit : FCC PART 15(1-6G) PK
 Env. / Ins. : Temp:26.4°;Humi:52.4%;Press:101.52kPa
 Engineer : ZERO
 EUT : 43" LED TV
 Power : AC 120V/60Hz
 M/N : ONC43FR19C11
 Test Mode : HDMI

	Freq. (MHz)	ANT Factor (dB/m)	Cable Loss (dB)	Reading (dBuV)	Emission Level (dBuV/m)	Limit (dBuV/m)	Margin (dB)	Remark
1	1860.000	26.10	2.59	5.13	33.82	54.00	20.18	Average
2	1860.000	26.10	2.59	18.41	47.10	74.00	26.90	Peak
3	2225.000	27.01	2.76	13.90	43.67	54.00	10.33	Average
4	2225.000	27.01	2.76	16.23	46.00	74.00	28.00	Peak
5	2505.000	27.44	2.97	6.27	36.68	54.00	17.32	Average
6	2505.000	27.44	2.97	16.49	46.90	74.00	27.10	Peak
7	2725.000	27.92	3.10	9.04	40.06	54.00	13.94	Average
8	2725.000	27.92	3.10	23.98	55.00	74.00	19.00	Peak
9	2970.000	28.52	3.27	15.03	46.82	54.00	7.18	Average
10	2970.000	28.52	3.27	18.21	50.00	74.00	24.00	Peak
11	3585.000	28.72	3.71	9.59	42.02	54.00	11.98	Average
12	3585.000	28.72	3.71	21.57	54.00	74.00	20.00	Peak

Remarks: 1. Emission Level= Antenna Factor + Cable Loss + Reading.
 2. Margin= Limit - Emission Level.
 3. The emission levels that are 20dB below the official limit are not reported.