



FCC RADIO TEST REPORT

Applicant : ARICH INTERNATIONAL INC
Address : 360 SUMMERVIEW CT SAN RAMON CA
94583-4463
Equipment : Wand
Model No. : Rogers
Trade Name : Tunai Creative Inc.
FCC ID. : 2ADZTROGERS

I HEREBY CERTIFY THAT :

The sample was received on Sep. 01, 2017 and the testing was carried out on Sep. 07, 2017 at CerpPASS Technology Corp. The test result refers exclusively to the test presented test model / sample. Without written approval of CerpPASS Technology Corp., the test report shall not be reproduced except in full.

Approved by:

Mark Liao / Assistant Manager

Tested by:

Spree Yei / Engineer

Laboratory Accreditation:

CerpPASS Technology Corporation Test Laboratory





Contents

1. Summary of Test Procedure and Test Results.....	5
1.1 Applicable Standards	5
2. Test Configuration of Equipment under Test.....	6
2.1 Feature of Equipment under Test.....	6
2.2 Carrier Frequency of Channels	6
2.3 Test Mode & Test Software	7
2.4 Description of Test System.....	7
2.5 General Information of Test.....	8
3. Test Equipment and Ancillaries Used for Tests.....	9
4. Antenna Requirements.....	10
4.1 Standard Applicable	10
4.2 Antenna Construction and Directional Gain.....	10
5. Test of AC Power Line Conducted Emission	11
5.1 Test Limit	11
5.2 Test Procedures	11
5.3 Typical Test Setup	12
5.4 Test Result and Data	13
5.5 Test Photographs	15
6. Test of Radiated Spurious Emission.....	16
6.1 Test Limit	16
6.2 Test Procedures.....	16
6.3 Typical Test Setup	17
6.4 Test Result and Data (9kHz ~ 30MHz).....	18
6.5 Test Result and Data (30MHz ~ 1GHz).....	18
6.6 Test Result and Data (1GHz ~ 25GHz).....	20
6.7 Restricted Bands of Operation	32
6.8 Test Photographs (30MHz ~ 1GHz)	33
6.9 Test Photographs (1GHz ~ 25GHz)	34
7. Test of Conducted Spurious Emission	35
7.1 Test Limit	35
7.2 Test Procedure	35
7.3 Test Setup Layout	35
7.4 Test Result and Data	35
8. 20dB Bandwidth Measurement Data.....	43
8.1 Test Limit	43
8.2 Test Procedures	43
8.3 Test Setup Layout	43
8.4 Test Result and Data	43
9. Frequencies Separation	46
9.1 Test Limit	46
9.2 Test Procedures	46
9.3 Test Setup Layout	46



9.4 Test Result and Data 46

10. Dwell Time on each channel 49

10.1 Test Limit 49

10.2 Test Procedures 49

10.3 Test Setup Layout 49

10.4 Test Result and Data 49

11. Number of Hopping Channels 52

11.1 Test Limit 52

11.2 Test Procedures 52

11.3 Test Setup Layout 52

11.4 Test Result and Data 52

12. Maximum Peak Output Power 54

12.1 Test Limit 54

12.2 Test Procedures 54

12.3 Test Setup Layout 54

12.4 Test Result and Data 55

13. Radio Frequency Exposure 56

13.1 Applicable Standards 56

13.2 EUT Specification 56

13.3 Test Results 57

13.4 Calculation 57

13.5 Maximum Permissible Exposure 58



History of this test report

Report No.	Issue Date	Description
TEFB1708221	Sep. 12, 2017	Original



1. Summary of Test Procedure and Test Results

1.1 Applicable Standards

ANSI C63.4:2014

ANSI C63.10:2013

FCC Rules and Regulations Part 15 Subpart C §15.247

FCC Rule	Description of Test	Result
15.203	. Antenna Requirement	Pass
15.207	. AC Power Line Conducted Emission	Pass
15.209 15.205	. Radiated Spurious Emission	Pass
15.247(d)	. Conducted Spurious Emission	Pass
15.247(a)(1)	. Channel Carrier Frequencies Separation	Pass
15.247(a)(1)	. 20dB Bandwidth	Pass
15.247(a)(1)	. Dwell Time	Pass
15.247(b)	. Number of Hopping Channels	Pass
15.247(b)	. Peak Output Power Measurement Data	Pass

This EUT has been also tested and compiled with the requirement of FCC Part 15, Subpart B, recorded in a separate test report.



2. Test Configuration of Equipment under Test

2.1 Feature of Equipment under Test

Frequency Range	2402-2480 MHz
Type of Modulation	GFSK for 1Mbps π /4-DQPSK for 2Mbps 8DPSK for 3Mbps
Antenna Type	Chip Antenna
Antenna Gain	3 dBi

2.2 Carrier Frequency of Channels

Channel	Frequency (MHz)	Channel	Frequency (MHz)	Channel	Frequency (MHz)	Channel	Frequency (MHz)
*00	2402	20	2422	40	2442	60	2462
01	2403	21	2423	41	2443	61	2463
02	2404	22	2424	42	2444	62	2464
03	2405	23	2425	43	2445	63	2465
04	2406	24	2426	44	2446	64	2466
05	2407	25	2427	45	2447	65	2467
06	2408	26	2428	46	2448	66	2468
07	2409	27	2429	47	2449	67	2469
08	2410	28	2430	48	2450	68	2470
09	2411	29	2431	49	2451	69	2471
10	2412	30	2432	50	2452	70	2472
11	2413	31	2433	51	2453	71	2473
12	2414	32	2434	52	2454	72	2474
13	2415	33	2435	53	2455	73	2475
14	2416	34	2436	54	2456	74	2476
15	2417	35	2437	55	2457	75	2477
16	2418	36	2438	56	2458	76	2478
17	2419	37	2439	57	2459	77	2479
18	2420	38	2440	58	2460	*78	2480
19	2421	*39	2441	59	2461	---	---

Note: Channels remarked * are selected to perform test.



2.3 Test Mode & Test Software

- a. During testing, the interface cables and equipment positions were varied according to ANSI C63.4
- b. The complete test system included Notebook and EUT for RF test.
- c. An executive program, "BlueSuite:2.6.4" under WIN 7 was executed to transmit and receive data via Bluetooth.
- d. The following test modes were performed for the test:

Test Mode	Operating Description
1	GFSK (1Mbps)
2	$\pi/4$ -DQPSK (2Mbps)
3	8DPSK (3Mbps)

For conduction test, caused "Test Mode 3" generated the worst case, it was reported as the final data.
For radiation test (below 1GHz), caused "Test Mode 3" generated the worst case, it was reported as the final data.
For radiation test (above 1GHz), caused "Test Mode 1,3" generated the worst case, they were reported as the final data.

2.4 Description of Test System

Device	Manufacturer	Model No.	Description
Notebook	DELL	LatitudeE5450/5450	Power Cable, Non-shielded, 1.8m



2.5 General Information of Test

Test Site	CerpPASS Technology Corporation Test Laboratory Address: No.10, Ln. 2, Lianfu St., Luzhu Dist., Taoyuan City 33848, Taiwan (R.O.C.) Tel:+886-3-3226-888 Fax:+886-3-3226-881 Address: No.68-1, Shihbachongsi, Shihding Township, New Taipei City 223, Taiwan, R.O.C. Tel: +886-2-2663-8582	
	FCC	TW1079, TW1061, 390316, 228391, 641184
	IC	4934E-1, 4934E-2
	VCCI	T-2205 for Telecommunication Test C-4663 for Conducted emission test R-4218, R-4399 for Radiated emission test G-812, G-813 for radiated disturbance above 1GHz
Frequency Range Investigated:	Conducted: from 150kHz to 30 MHz Radiation: from 30 MHz to 25,000MHz	
Test Distance:	The test distance of radiated emission from antenna to EUT is 3 M.	



3. Test Equipment and Ancillaries Used for Tests

Instrument	Manufacturer	Model No.	Serial No.	Calibration Date	Valid Date
EMI Receiver	R&S	ESCI3	100443	2017/03/07	2018/03/06
LISN	Schwarzbeck	NSLK 8127	8127-568	2017/02/15	2018/02/14
Pulse Limiter	R&S	ESH3-Z2	101934	2017/02/14	2018/02/13
Bilog Antenna	Schwarzbeck	VULB9168	369	2017/03/15	2018/03/14
Active Loop Antenna	EMCO	6507	40855	2017/05/15	2018/05/14
Horn Antenna	EMCO	3115	31601	2016/09/05	2017/09/04
Horn Antenna	EMCO	3116	31970	2017/03/29	2018/03/28
EXA Signal Analyzer	KEYSIGHT	N9010A	MY54200207	2017/03/17	2018/03/16
Preamplifier	EM	EM330	60660	2017/02/25	2018/02/24
Preamplifier	EMC INSTRUMENTS	EMC051845SE	980333	2016/09/13	2017/09/12
Preamplifier	Agilent	8449B	3008A01954	2017/02/09	2018/02/08
Preamplifier	EMC INSTRUMENTS	EMC184045	980065	2016/11/04	2017/11/03
MXG MW Analog Signal Generator	KEYSIGHT	N5183A	MY50142931	2017/03/17	2018/03/16
Spectrum Analyzer	R&S	FSP40	100219	2017/07/01	2018/06/30
BLUETOOTH TESTER	R&S	CBT	101133	2017/03/10	2018/03/09
Attenuator	KEYSIGHT	8491B	MY39250703	2017/03/07	2018/03/06
Rotary Attenuator	Agilent	8495B	MY42146680	2017/03/13	2018/03/12
Temp & Humi chamber	T-MACHINE	TMJ-9712	T-12-040111	2016/09/05	2017/09/04
Series Power Meter	Anritsu	ML2495A	1224005	2017/03/01	2018/02/28
Power Sensor	Anritsu	MA2411B	1207295	2017/03/01	2018/02/28
Cable	HUBER SUHNER	SUCOFLEX 102	28422/2	2017/02/25	2018/02/24
Cable	HUBER SUHNER	SUCOFLEX 102	28418/2	2017/02/25	2018/02/24
Software	Farad	Ez-EMC	ver.ct3a1	N/A	N/A
Software	AUDIX	E3	V8.2014-8-6	N/A	N/A
Software	Keysight	N7607B Signal Studio	v2.0.0.1	N/A	N/A
Software	Keysight	Inservice MonitorUtility	N/A	N/A	N/A



4. Antenna Requirements

4.1 Standard Applicable

For intentional device, according to FCC 47 CFR Section 15.203, an intentional radiator shall be designed to ensure that no antenna other than that furnished by the responsible party shall be used with the device.

And according to FCC 47 CFR Section 15.247 (b), if transmitting antennas of directional gain greater than 6dBi are used, the power shall be reduced by the amount in dB that the directional gain of the antenna exceeds 6dBi.

4.2 Antenna Construction and Directional Gain

Antenna Type	Chip Antenna
Antenna Gain	3 dBi



5. Test of AC Power Line Conducted Emission

5.1 Test Limit

Conducted Emissions were measured from 150 kHz to 30 MHz with a bandwidth of 9 KHz, according to the methods defined in ANSI C63.4-2014. The EUT was placed on a nonmetallic stand in a shielded room 0.8 meters above the ground plane. The interface cables and equipment positioning were varied within limits of reasonable applications to determine the position produced maximum conducted emissions.

Frequency (MHz)	Quasi Peak (dB μ V)	Average (dB μ V)
0.15 – 0.5	66-56*	56-46*
0.5 – 5.0	56	46
5.0 – 30.0	60	50

*Decreases with the logarithm of the frequency.

5.2 Test Procedures

- a. The EUT was placed 0.4 meter from the conducting wall of the shielding room was kept at least 80 centimeters from any other grounded conducting surface.
- b. Connect EUT to the power mains through a line impedance stabilization network (LISN).
- c. All the support units are connecting to the other LISN.
- d. The LISN provides 50 ohm coupling impedance for the measuring instrument.
- e. The FCC states that a 50 ohm, 50 micro-Henry LISN should be used.
- f. Both sides of AC line were checked for maximum conducted interference.
- g. The frequency range from 150 kHz to 30 MHz was searched.
- h. Set the test-receiver system to Peak Detect Function and Specified Bandwidth with Maximum Hold Mode.



5.3 Typical Test Setup

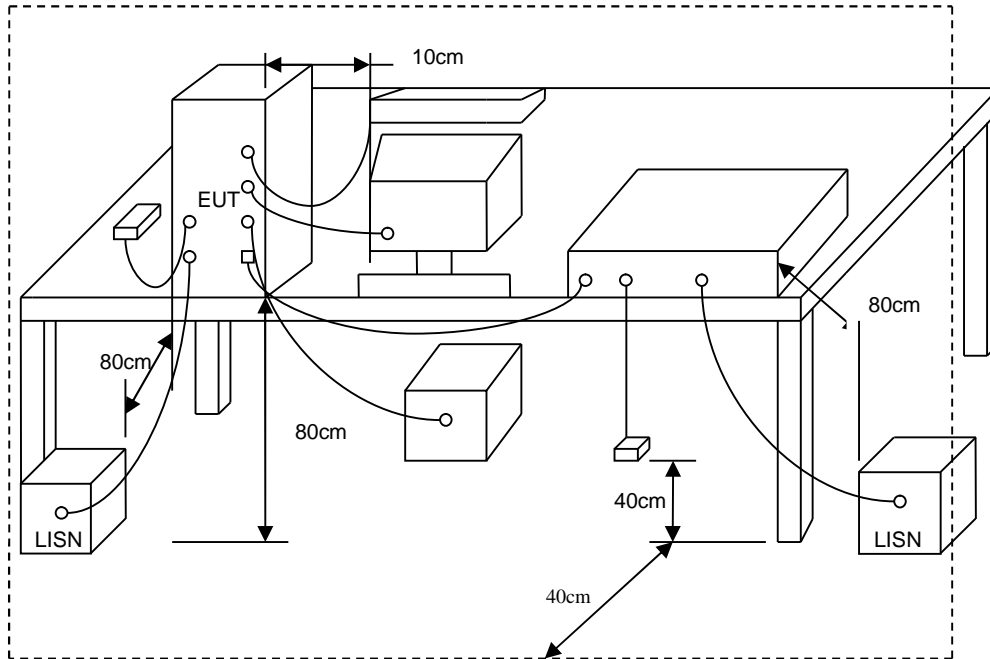



5.4 Test Result and Data

Power	: From System	Pol/Phase	: LINE
Test Mode	: Mode 3	Temperature	: 22 °C
Test date	: Sep. 07, 2017	Humidity	: 64 %

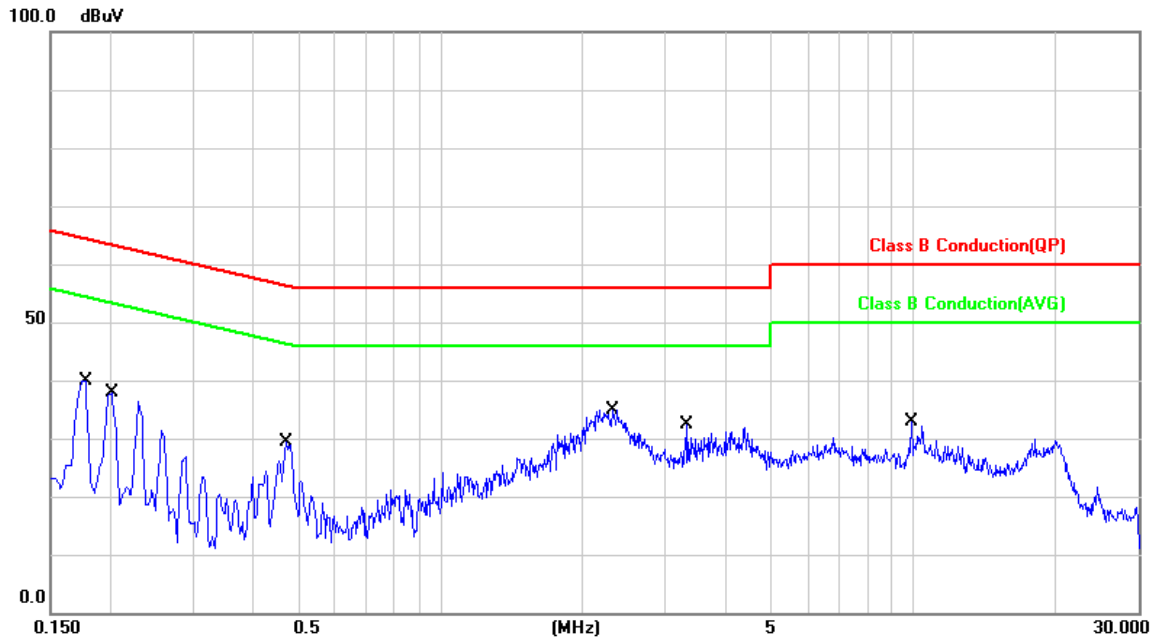

No.	Frequency (MHz)	Factor (dB)	Reading (dBuV)	Level (dBuV)	Limit (dBuV)	Margin (dB)	Detector	P/F
1	0.1780	9.91	26.93	36.84	64.57	-27.73	QP	P
2	0.1780	9.91	11.45	21.36	54.57	-33.21	AVG	P
3	0.2020	9.91	24.04	33.95	63.52	-29.57	QP	P
4	0.2020	9.91	9.37	19.28	53.52	-34.24	AVG	P
5	0.4740	9.93	15.78	25.71	56.44	-30.73	QP	P
6	0.4740	9.93	8.21	18.14	46.44	-28.30	AVG	P
7	2.3179	10.07	21.73	31.80	56.00	-24.20	QP	P
8	2.3179	10.07	17.00	27.07	46.00	-18.93	AVG	P
9	3.3420	10.11	14.31	24.42	56.00	-31.58	QP	P
10	3.3420	10.11	8.94	19.05	46.00	-26.95	AVG	P
11	9.9580	10.34	14.35	24.69	60.00	-35.31	QP	P
12	9.9580	10.34	8.93	19.27	50.00	-30.73	AVG	P

Note: Level = Reading + Factor
 Margin = Level – Limit
 Factor = (LISN, ISN, PLC or current probe) Factor + Cable Loss+ Attenuator



Power	: From System	Pol/Phase	: NEUTRAL
Test Mode	: Mode 3	Temperature	: 22 °C
Test date	: Sep. 07, 2017	Humidity	: 64 %

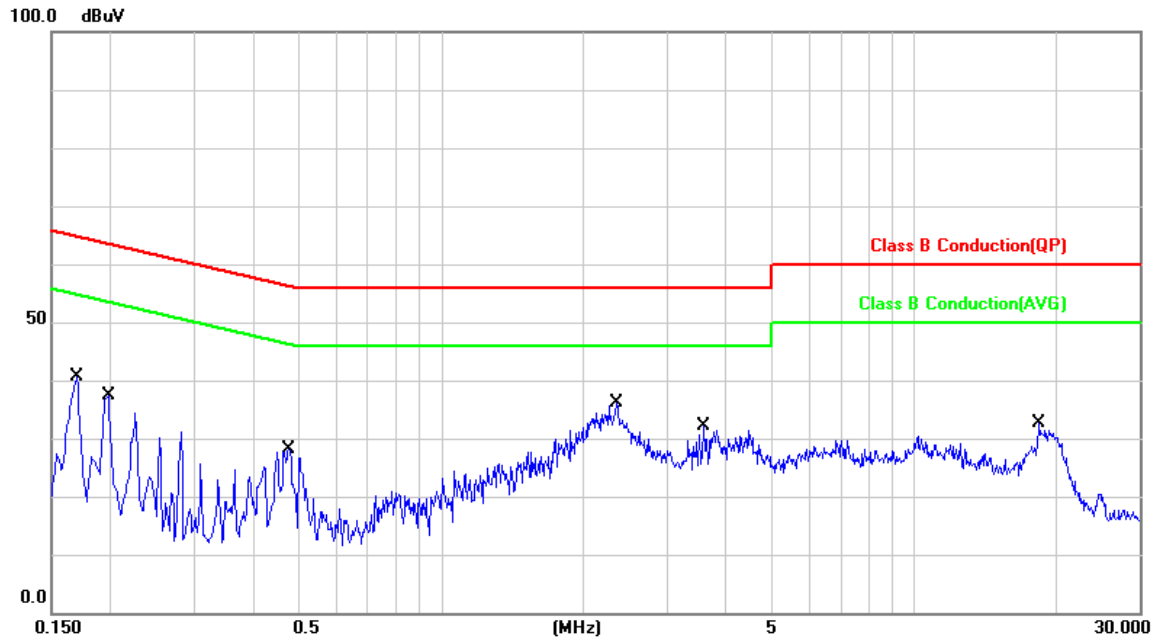

No.	Frequency (MHz)	Factor (dB)	Reading (dBuV)	Level (dBuV)	Limit (dBuV)	Margin (dB)	Detector	P/F
1	0.1700	9.88	27.13	37.01	64.96	-27.95	QP	P
2	0.1700	9.88	10.81	20.69	54.96	-34.27	AVG	P
3	0.1980	9.88	23.50	33.38	63.69	-30.31	QP	P
4	0.1980	9.88	9.40	19.28	53.69	-34.41	AVG	P
5	0.4780	9.89	16.06	25.95	56.37	-30.42	QP	P
6	0.4780	9.89	8.90	18.79	46.37	-27.58	AVG	P
7	2.3580	10.02	21.70	31.72	56.00	-24.28	QP	P
8	2.3580	10.02	16.95	26.97	46.00	-19.03	AVG	P
9	3.6020	10.06	15.90	25.96	56.00	-30.04	QP	P
10	3.6020	10.06	9.82	19.88	46.00	-26.12	AVG	P
11	18.3779	10.59	13.50	24.09	60.00	-35.91	QP	P
12	18.3779	10.59	8.85	19.44	50.00	-30.56	AVG	P

Note: Level = Reading + Factor
Margin = Level – Limit
Factor = (LISN, ISN, PLC or current probe) Factor + Cable Loss+ Attenuator



6. Test of Radiated Spurious Emission

6.1 Test Limit

Radiated emissions from 30 MHz to 25 GHz were measured according to the methods defines in ANSI C63.4-2014. The EUT was placed, 0.8 meter above the ground plane, as shown in section 5.6.3. The interface cables and equipment positions were varied within limits of reasonable applications to determine the positions producing maximum radiated emissions For unintentional device, according to § 15.109(a), except for Class A digital devices, the field strength of radiated emissions from unintentional radiators at a distance of 3 meters shall not exceed the following values:

Frequency (MHz)	Distance Meters	Radiated (μ V / M)	Radiated (dB μ V / M)
30-88	3	100	40.0
88-216	3	150	43.5
216-960	3	200	46.0
Above 960	3	500	54.0

For unintentional device, according to CISPR PUB.22, for Class B digital devices, the general requirement of field strength of radiated emissions from intentional radiators at a distance of 10 meters shall not exceed the above table.

Frequency (MHz)	Distance Meters	Radiated (dB μ V / M)
30-230	10	30
230-1000	10	37

6.2 Test Procedures

- The EUT was placed on a rotatable table top 0.8 meter above ground.
- The EUT was set 3 meters from the interference receiving antenna which was mounted on the top of a variable height antenna tower.
- The table was rotated 360 degrees to determine the position of the highest radiation.
- The antenna is a broadband antenna and its height is varied between one meter and four meters above ground to find the maximum value of the field strength both horizontal polarization and vertical polarization of the antenna are set to make the measurement.
- For each suspected emission the EUT was arranged to its worst case and then tune the antenna tower (from 1 M to 4 M) and turn table (from 0 degree to 360 degrees) to find the maximum reading.
- Set the test-receiver system to Peak or CISPR quasi-peak Detect Function and specified bandwidth with Maximum Hold Mode.
- If the emission level of the EUT in peak mode was 3 dB lower than the limit specified, then testing will be stopped and peak values of EUT will be reported, otherwise, the emissions which do not have 3 dB margin will be repeated one by one using the quasi-peak method and reported.
- For testing above 1GHz, the emission level of the EUT in peak mode was 20dB lower than average limit (that means the emission level in peak mode also complies with the limit in average mode), then testing will be stopped and peak values of EUT will be reported, otherwise, the emissions will be measured in average mode again and reported.



6.3 Typical Test Setup

Below 30MHz test setup

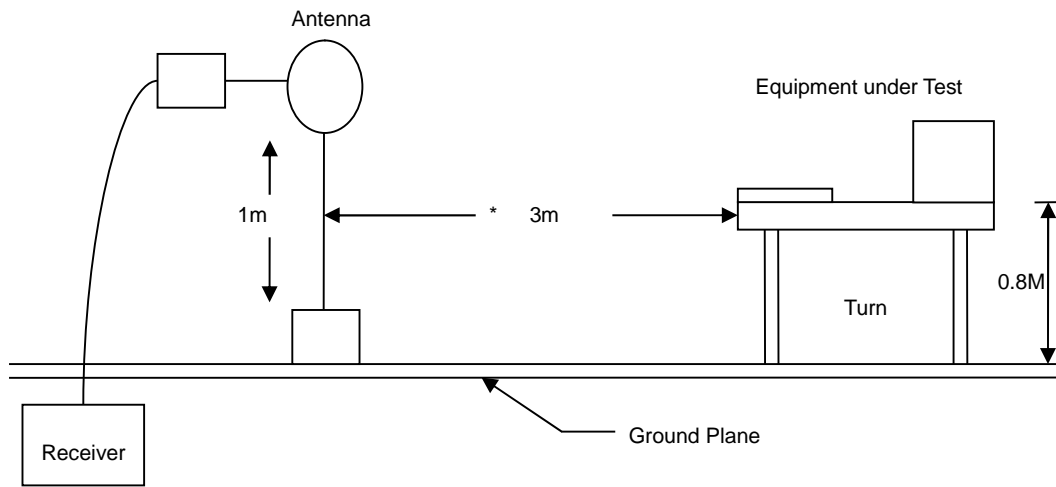

30MHz- 1GHz Test Setup

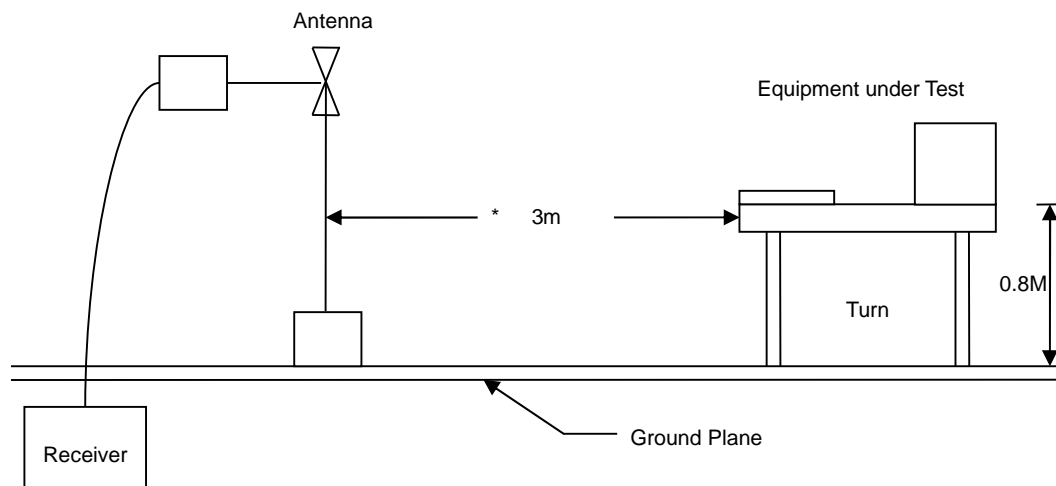

Above 1GHz Test Setup

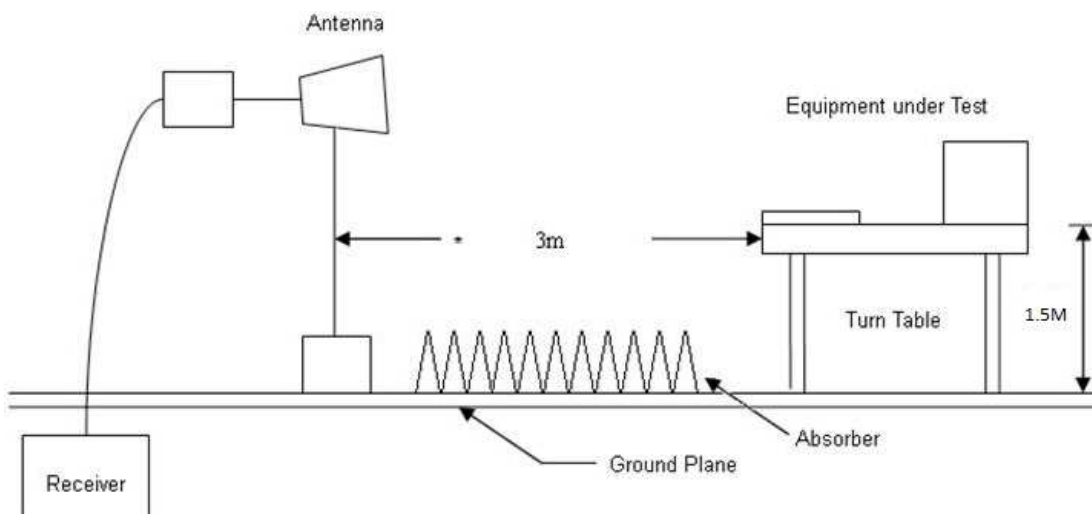



6.4 Test Result and Data (9kHz ~ 30MHz)

The 9kHz-30MHz spurious emission is under limit 20dB more.

6.5 Test Result and Data (30MHz ~ 1GHz)

Power	: From System	Pol/Phase	: VERTICAL
Test Mode	: Mode 3	Temperature	: 24 °C
Test Date	: Sep. 01, 2017	Humidity	: 63 %

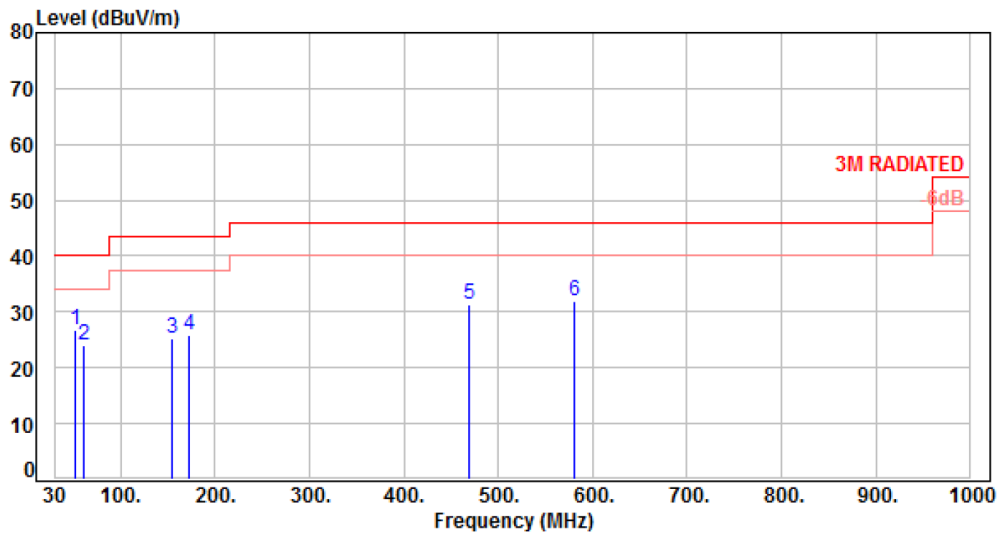

No.	Frequency (MHz)	Factor (dB)	Reading (dBuV)	Level (dBuV)	Limit (dBuV)	Margin (dB)	Detector	Height (cm)	Azimuth (deg)	P/F
1	51.34	-9.86	36.69	26.83	40.00	-13.17	Peak	100	0	P
2	61.04	-10.60	34.56	23.96	40.00	-16.04	Peak	100	0	P
3	154.16	-9.92	35.31	25.39	43.50	-18.11	Peak	100	0	P
4	171.62	-10.31	36.28	25.97	43.50	-17.53	Peak	100	0	P
5	468.44	-4.53	35.85	31.32	46.00	-14.68	Peak	100	0	P
6	580.96	-2.17	33.97	31.80	46.00	-14.20	Peak	100	0	P

Note: Level=Reading+Factor
Margin=Level-Limit
Factor=Antenna Factor + cable loss - Amplifier Factor



Power	: From System	Pol/Phase	: HORIZONTAL
Test Mode	: Mode 3	Temperature	: 24 °C
Test Date	: Sep. 01, 2017	Humidity	: 63 %

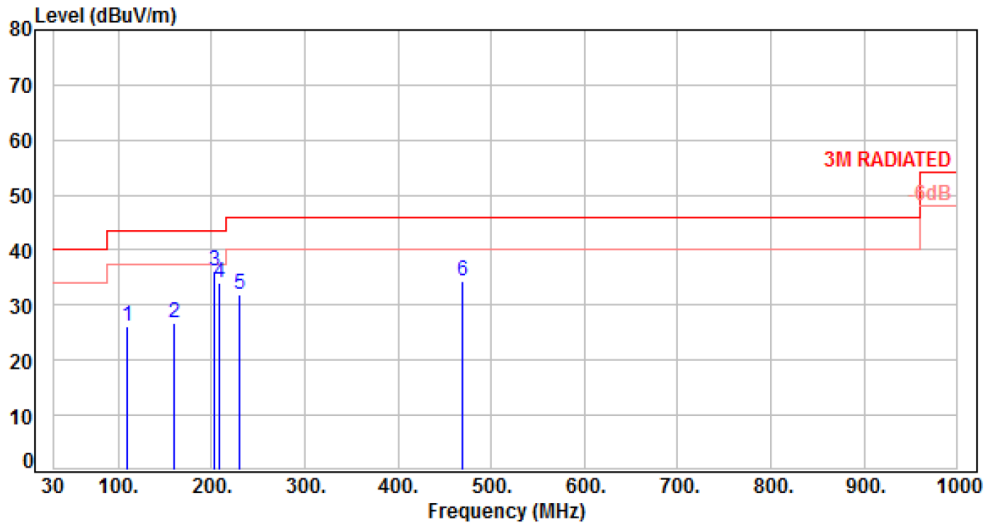

No.	Frequency (MHz)	Factor (dB)	Reading (dBuV)	Level (dBuV)	Limit (dBuV)	Margin (dB)	Detector	Height (cm)	Azimuth (deg)	P/F
1	109.54	-13.21	39.34	26.13	43.50	-17.37	Peak	100	0	P
2	159.98	-9.90	36.66	26.76	43.50	-16.74	Peak	100	0	P
3	202.66	-12.49	48.69	36.20	43.50	-7.30	Peak	100	0	P
4	208.48	-12.45	46.57	34.12	43.50	-9.38	Peak	100	0	P
5	229.82	-11.76	43.78	32.02	46.00	-13.98	Peak	100	0	P
6	468.44	-4.53	38.85	34.32	46.00	-11.68	Peak	100	0	P

Note: Level=Reading+Factor
Margin=Level-Limit
Factor=Antenna Factor + cable loss - Amplifier Factor



6.6 Test Result and Data (1GHz ~ 25GHz)

Power	: From System	Pol/Phase	: VERTICAL
Test Mode	: Mode 1, CH00	Temperature	: 24 °C
Test Date	: Sep. 01, 2017	Humidity	: 63 %

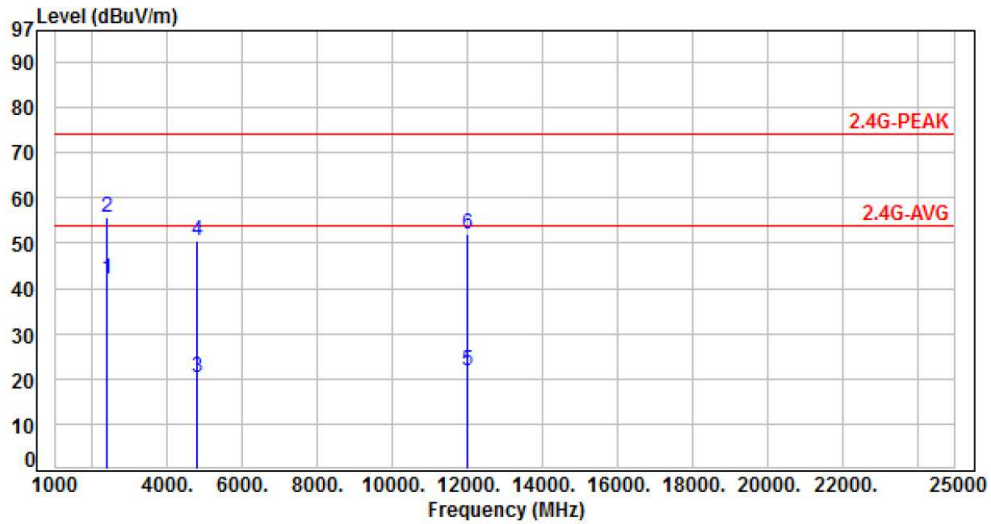

No.	Frequency (MHz)	Factor (dB)	Reading (dBuV)	Level (dBuV)	Limit (dBuV)	Margin (dB)	Detector	Height (cm)	Azimuth (deg)	P/F
1	2390.00	-18.91	61.10	42.19	54.00	-11.81	Average	118	147	P
2	2390.00	-18.91	74.54	55.63	74.00	-18.37	Peak	118	147	P
3	4804.00	-13.26	33.51	20.25	54.00	-33.75	Average	101	240	P
4	4804.00	-13.26	63.61	50.35	74.00	-23.65	Peak	101	240	P
5	12010.00	-5.78	27.52	21.74	54.00	-32.26	Average	107	98	P
6	12010.00	-5.78	57.62	51.84	74.00	-22.16	Peak	107	98	P

Note: Level=Reading+Factor
 Margin=Level-Limit
 Factor=Antenna Factor + cable loss - Amplifier Factor



Power	: From System	Pol/Phase	: HORIZONTAL
Test Mode	: Mode 1, CH00	Temperature	: 24 °C
Test Date	: Sep. 01, 2017	Humidity	: 63 %

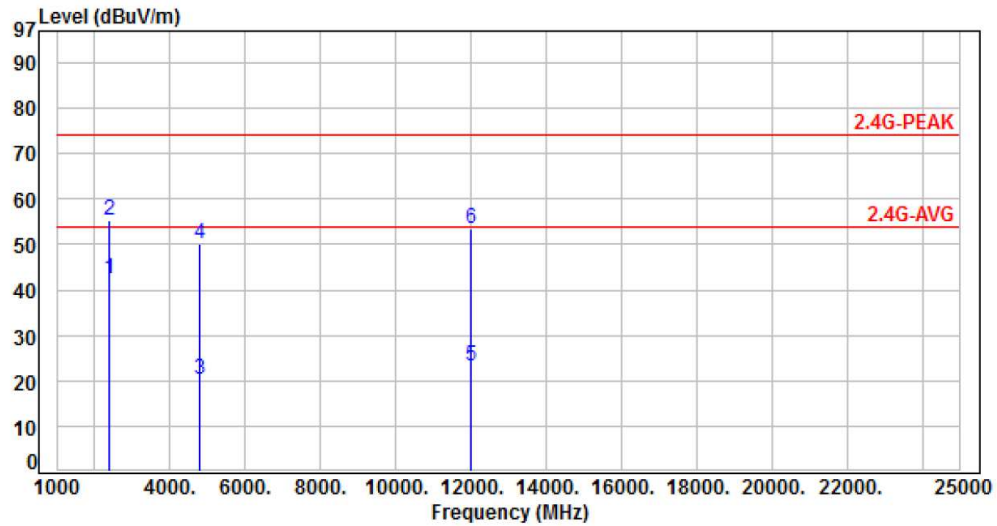

No.	Frequency (MHz)	Factor (dB)	Reading (dBuV)	Level (dBuV)	Limit (dBuV)	Margin (dB)	Detector	Height (cm)	Azimuth (deg)	P/F
1	2390.00	-18.91	61.42	42.51	54.00	-11.49	Average	114	36	P
2	2390.00	-18.91	74.24	55.33	74.00	-18.67	Peak	114	36	P
3	4804.00	-13.26	33.44	20.18	54.00	-33.82	Average	231	290	P
4	4804.00	-13.26	63.54	50.28	74.00	-23.72	Peak	231	290	P
5	12010.00	-5.78	29.08	23.30	54.00	-30.70	Average	112	99	P
6	12010.00	-5.78	59.18	53.40	74.00	-20.60	Peak	112	99	P

Note: Level=Reading+Factor
 Margin=Level-Limit
 Factor=Antenna Factor + cable loss - Amplifier Factor



Power	: From System	Pol/Phase	: VERTICAL
Test Mode	: Mode 1, CH39	Temperature	: 24 °C
Test Date	: Sep. 01, 2017	Humidity	: 63 %

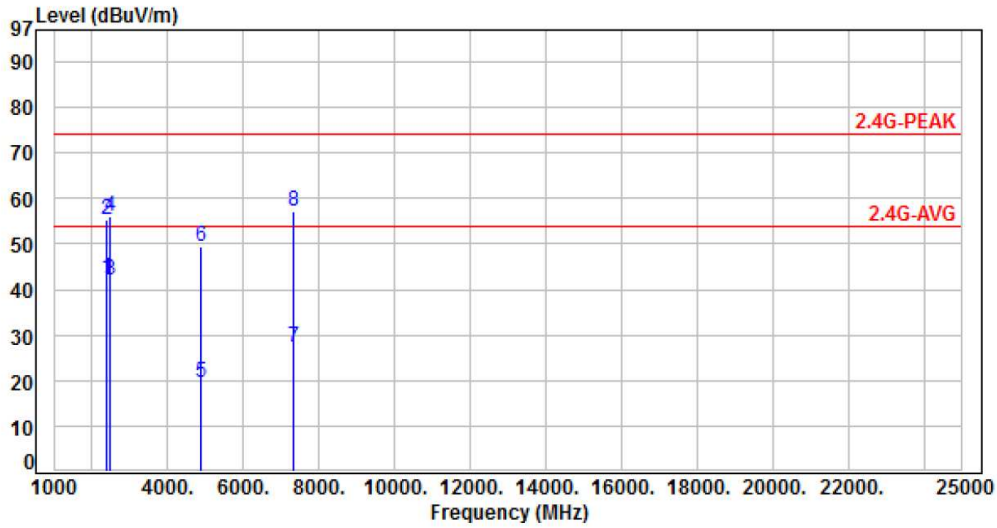

No.	Frequency (MHz)	Factor (dB)	Reading (dBuV)	Level (dBuV)	Limit (dBuV)	Margin (dB)	Detector	Height (cm)	Azimuth (deg)	P/F
1	2390.00	-18.91	61.23	42.32	54.00	-11.68	Average	113	154	P
2	2390.00	-18.91	74.09	55.18	74.00	-18.82	Peak	113	154	P
3	2483.50	-18.62	60.75	42.13	54.00	-11.87	Average	113	154	P
4	2483.50	-18.62	74.67	56.05	74.00	-17.95	Peak	113	154	P
5	4882.00	-13.11	32.48	19.37	54.00	-34.63	Average	101	246	P
6	4882.00	-13.11	62.58	49.47	74.00	-24.53	Peak	101	246	P
7	7323.00	-9.86	37.05	27.19	54.00	-26.81	Average	116	66	P
8	7323.00	-9.86	67.15	57.29	74.00	-16.71	Peak	116	66	P

Note: Level=Reading+Factor
 Margin=Level-Limit
 Factor=Antenna Factor + cable loss - Amplifier Factor



Power	: From System	Pol/Phase	: HORIZONTAL
Test Mode	: Mode 1, CH39	Temperature	: 24 °C
Test Date	: Sep. 01, 2017	Humidity	: 63 %

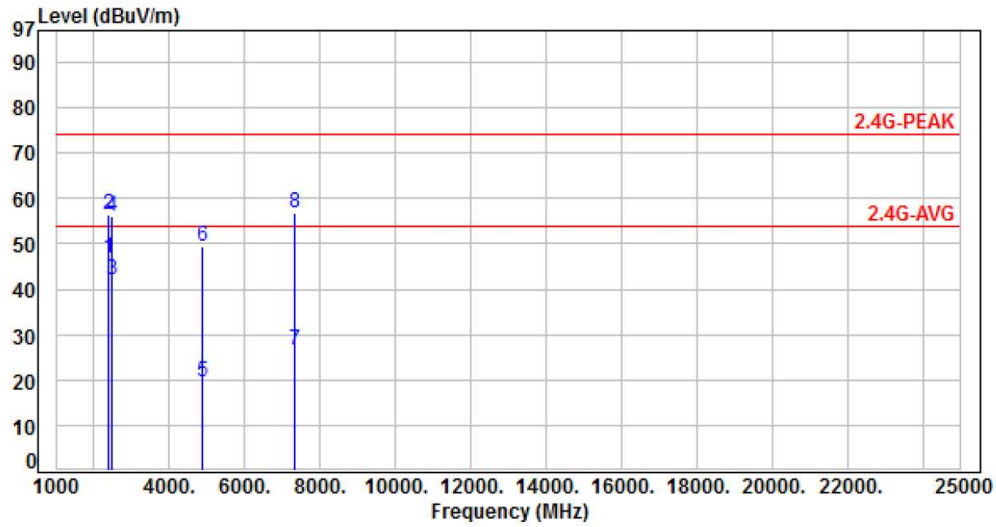

No.	Frequency (MHz)	Factor (dB)	Reading (dBuV)	Level (dBuV)	Limit (dBuV)	Margin (dB)	Detector	Height (cm)	Azimuth (deg)	P/F
1	2390.00	-18.91	65.59	46.68	54.00	-7.32	Average	114	48	P
2	2390.00	-18.91	75.40	56.49	74.00	-17.51	Peak	114	48	P
3	2483.50	-18.62	60.77	42.15	54.00	-11.85	Average	114	48	P
4	2483.50	-18.62	74.54	55.92	74.00	-18.08	Peak	114	48	P
5	4882.00	-13.11	32.56	19.45	54.00	-34.55	Average	163	284	P
6	4882.00	-13.11	62.66	49.55	74.00	-24.45	Peak	163	284	P
7	7323.00	-9.86	36.56	26.70	54.00	-27.30	Average	134	139	P
8	7323.00	-9.86	66.66	56.80	74.00	-17.20	Peak	134	139	P

Note: Level=Reading+Factor
Margin=Level-Limit
Factor=Antenna Factor + cable loss - Amplifier Factor



Power	: From System	Pol/Phase	: VERTICAL
Test Mode	: Mode 1, CH78	Temperature	: 24 °C
Test Date	: Sep. 01, 2017	Humidity	: 63 %

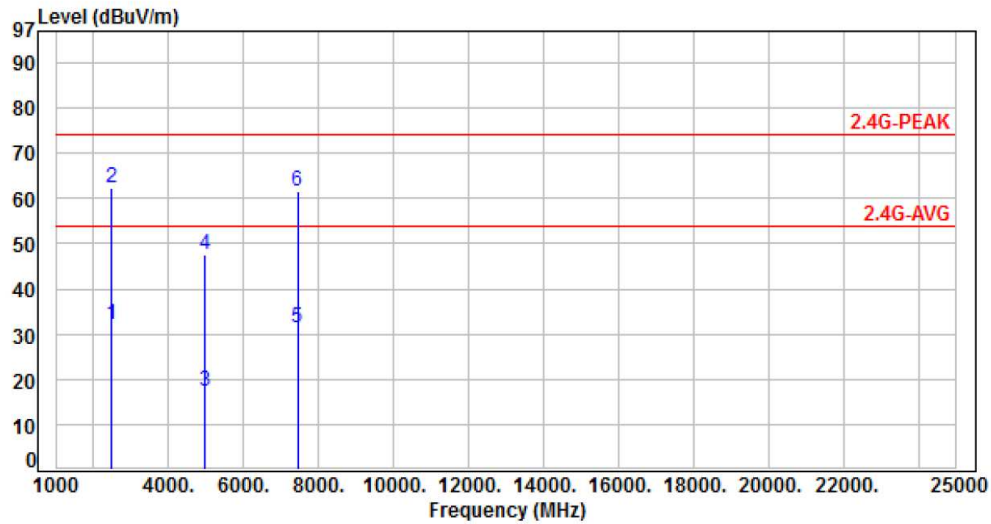

No.	Frequency (MHz)	Factor (dB)	Reading (dBUV)	Level (dBUV)	Limit (dBUV)	Margin (dB)	Detector	Height (cm)	Azimuth (deg)	P/F
1	2483.50	-18.62	50.68	32.06	54.00	-21.94	Average	112	152	P
2	2483.50	-18.62	80.78	62.16	74.00	-11.84	Peak	112	152	P
3	4960.00	-12.96	30.38	17.42	54.00	-36.58	Average	101	253	P
4	4960.00	-12.96	60.48	47.52	74.00	-26.48	Peak	101	253	P
5	7440.00	-9.58	41.06	31.48	54.00	-22.52	Average	101	76	P
6	7440.00	-9.58	71.16	61.58	74.00	-12.42	Peak	101	76	P

Note: Level=Reading+Factor
 Margin=Level-Limit
 Factor=Antenna Factor + cable loss - Amplifier Factor



Power	: From System	Pol/Phase	: HORIZONTAL
Test Mode	: Mode 1, CH78	Temperature	: 24 °C
Test Date	: Sep. 01, 2017	Humidity	: 63 %

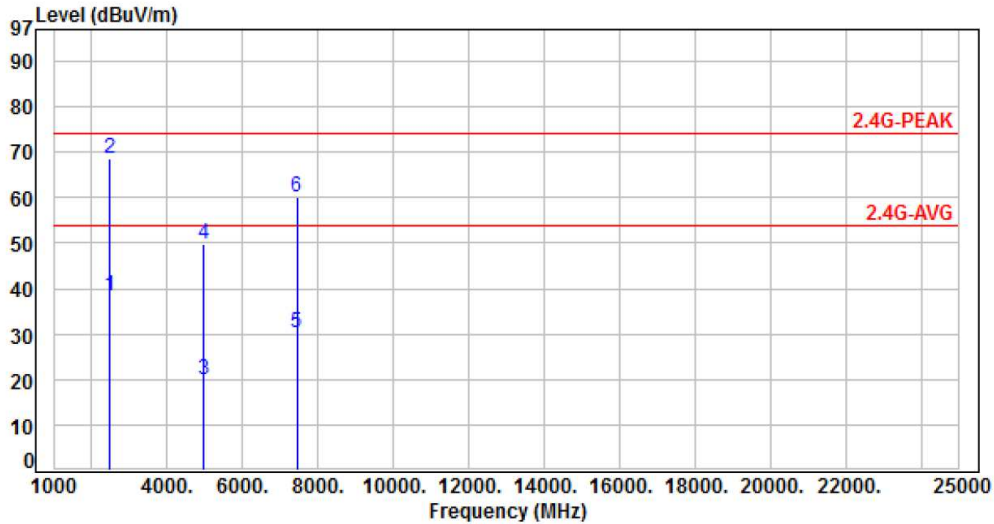

No.	Frequency (MHz)	Factor (dB)	Reading (dBuV)	Level (dBuV)	Limit (dBuV)	Margin (dB)	Detector	Height (cm)	Azimuth (deg)	P/F
1	2483.50	-18.62	57.08	38.46	54.00	-15.54	Average	112	45	P
2	2483.50	-18.62	87.18	68.56	74.00	-5.44	Peak	112	45	P
3	4960.00	-12.96	32.78	19.82	54.00	-34.18	Average	136	282	P
4	4960.00	-12.96	62.88	49.92	74.00	-24.08	Peak	136	282	P
5	7440.00	-9.58	39.66	30.08	54.00	-23.92	Average	129	139	P
6	7440.00	-9.58	69.76	60.18	74.00	-13.82	Peak	129	139	P

Note: Level=Reading+Factor
 Margin=Level-Limit
 Factor=Antenna Factor + cable loss - Amplifier Factor



Power	: From System	Pol/Phase	: VERTICAL
Test Mode	: Mode 3, CH00	Temperature	: 24 °C
Test Date	: Sep. 01, 2017	Humidity	: 63 %

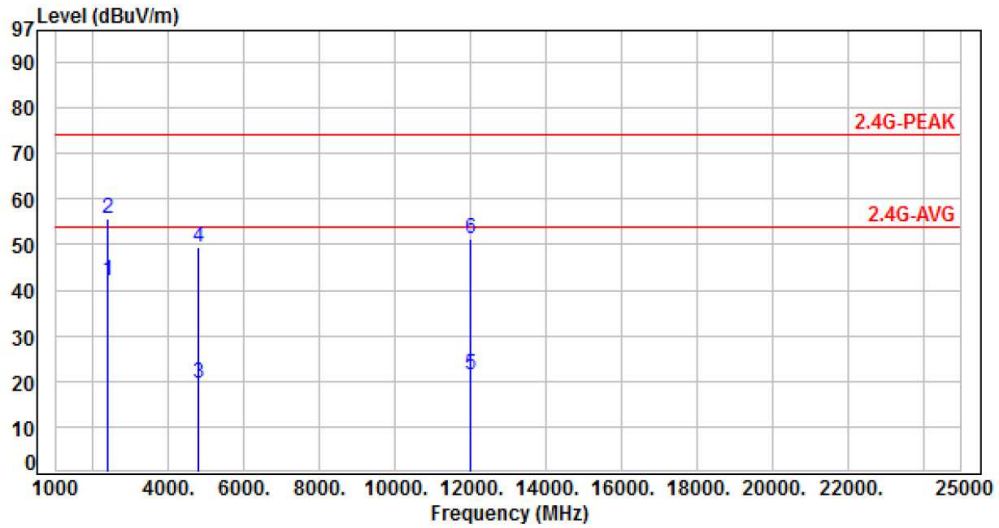

No.	Frequency (MHz)	Factor (dB)	Reading (dBuV)	Level (dBuV)	Limit (dBuV)	Margin (dB)	Detector	Height (cm)	Azimuth (deg)	P/F
1	2390.00	-18.91	61.01	42.10	54.00	-11.90	Average	123	154	P
2	2390.00	-18.91	74.45	55.54	74.00	-18.46	Peak	123	154	P
3	4804.00	-13.26	32.74	19.48	54.00	-34.52	Average	101	237	P
4	4804.00	-13.26	62.84	49.58	74.00	-24.42	Peak	101	237	P
5	12010.00	-5.78	27.08	21.30	54.00	-32.70	Average	112	94	P
6	12010.00	-5.78	57.18	51.40	74.00	-22.60	Peak	112	94	P

Note: Level=Reading+Factor
 Margin=Level-Limit
 Factor=Antenna Factor + cable loss - Amplifier Factor



Power	: From System	Pol/Phase	: HORIZONTAL
Test Mode	: Mode 3, CH00	Temperature	: 24 °C
Test Date	: Sep. 01, 2017	Humidity	: 63 %

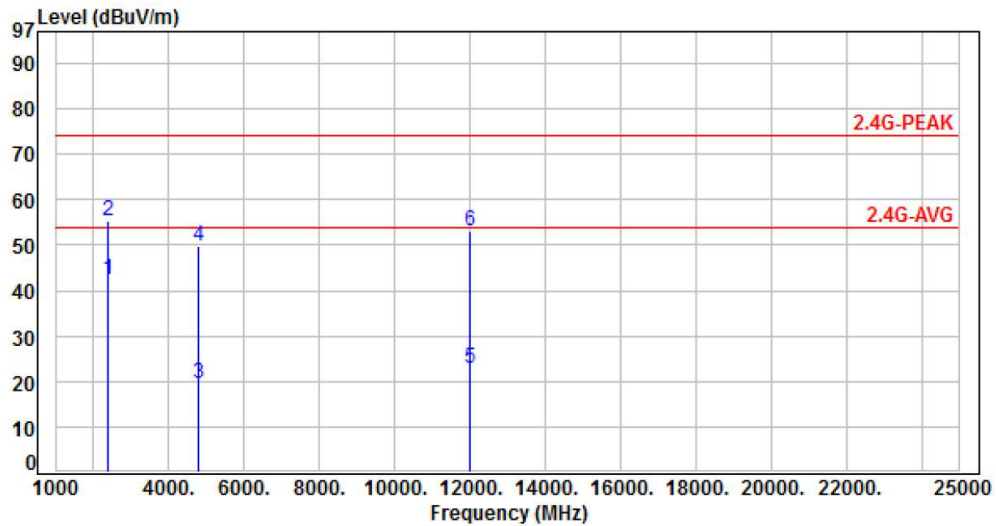

No.	Frequency (MHz)	Factor (dB)	Reading (dBuV)	Level (dBuV)	Limit (dBuV)	Margin (dB)	Detector	Height (cm)	Azimuth (deg)	P/F
1	2390.00	-18.91	61.37	42.46	54.00	-11.54	Average	116	35	P
2	2390.00	-18.91	74.17	55.26	74.00	-18.74	Peak	116	35	P
3	4804.00	-13.26	32.80	19.54	54.00	-34.46	Average	235	288	P
4	4804.00	-13.26	62.90	49.64	74.00	-24.36	Peak	235	288	P
5	12010.00	-5.78	28.77	22.99	54.00	-31.01	Average	114	96	P
6	12010.00	-5.78	58.87	53.09	74.00	-20.91	Peak	114	96	P

Note: Level=Reading+Factor
Margin=Level-Limit
Factor=Antenna Factor + cable loss - Amplifier Factor



Power	: From System	Pol/Phase	: VERTICAL
Test Mode	: Mode 3, CH39	Temperature	: 24 °C
Test Date	: Sep. 01, 2017	Humidity	: 63 %

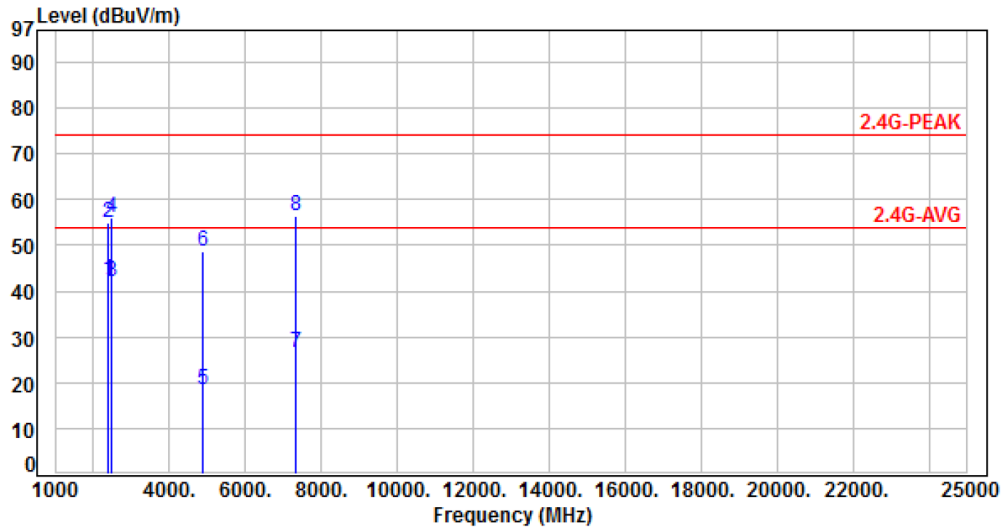

No.	Frequency (MHz)	Factor (dB)	Reading (dBuV)	Level (dBuV)	Limit (dBuV)	Margin (dB)	Detector	Height (cm)	Azimuth (deg)	P/F
1	2390.00	-18.91	61.16	42.25	54.00	-11.75	Average	112	151	P
2	2390.00	-18.91	74.01	55.10	74.00	-18.90	Peak	112	151	P
3	2483.50	-18.62	60.68	42.06	54.00	-11.94	Average	112	151	P
4	2483.50	-18.62	74.59	55.97	74.00	-18.03	Peak	112	151	P
5	4882.00	-13.11	31.73	18.62	54.00	-35.38	Average	101	249	P
6	4882.00	-13.11	61.83	48.72	74.00	-25.28	Peak	101	249	P
7	7323.00	-9.86	36.26	26.40	54.00	-27.60	Average	118	65	P
8	7323.00	-9.86	66.36	56.50	74.00	-17.50	Peak	118	65	P

Note: Level=Reading+Factor
Margin=Level-Limit
Factor=Antenna Factor + cable loss - Amplifier Factor



Power	: From System	Pol/Phase	: HORIZONTAL
Test Mode	: Mode 3, CH39	Temperature	: 24 °C
Test Date	: Sep. 01, 2017	Humidity	: 63 %

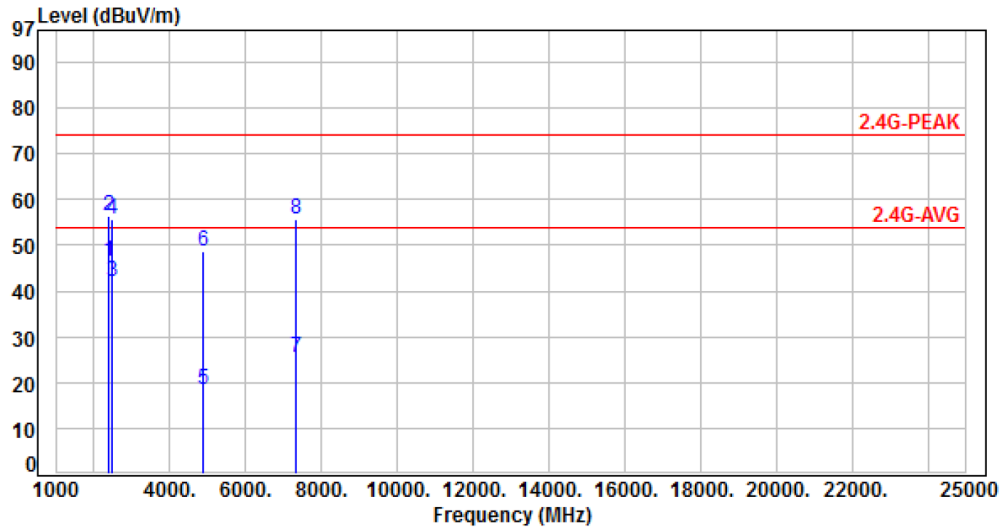

No.	Frequency (MHz)	Factor (dB)	Reading (dBuV)	Level (dBuV)	Limit (dBuV)	Margin (dB)	Detector	Height (cm)	Azimuth (deg)	P/F
1	2390.00	-18.91	65.48	46.57	54.00	-7.43	Average	112	51	P
2	2390.00	-18.91	75.33	56.42	74.00	-17.58	Peak	112	51	P
3	2483.50	-18.62	60.68	42.06	54.00	-11.94	Average	112	51	P
4	2483.50	-18.62	74.45	55.83	74.00	-18.17	Peak	112	51	P
5	4882.00	-13.11	31.64	18.53	54.00	-35.47	Average	165	283	P
6	4882.00	-13.11	61.74	48.63	74.00	-25.37	Peak	165	283	P
7	7323.00	-9.86	35.28	25.42	54.00	-28.58	Average	131	145	P
8	7323.00	-9.86	65.38	55.52	74.00	-18.48	Peak	131	145	P

Note: Level=Reading+Factor
 Margin=Level-Limit
 Factor=Antenna Factor + cable loss - Amplifier Factor



Power	: From System	Pol/Phase	: VERTICAL
Test Mode	: Mode 3, CH78	Temperature	: 24 °C
Test Date	: Sep. 01, 2017	Humidity	: 63 %

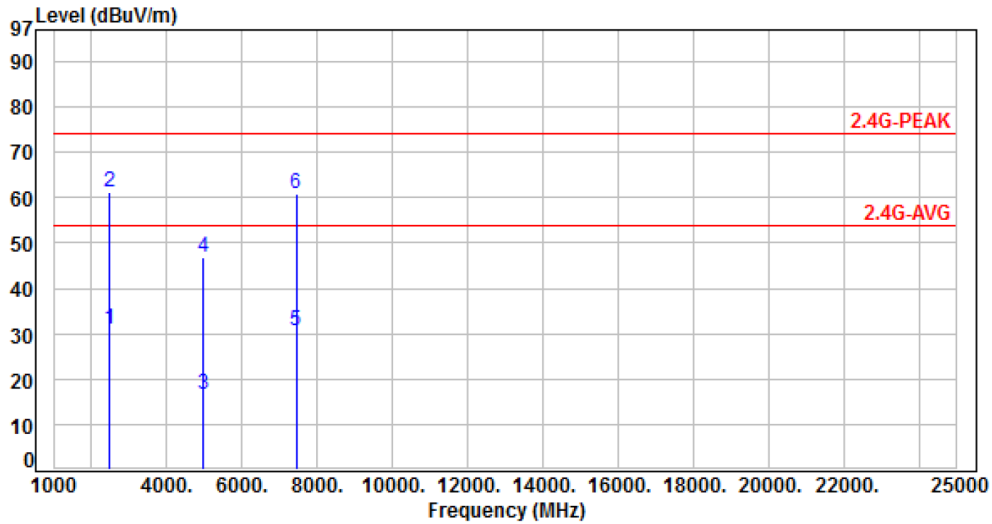

No.	Frequency (MHz)	Factor (dB)	Reading (dBuV)	Level (dBuV)	Limit (dBuV)	Margin (dB)	Detector	Height (cm)	Azimuth (deg)	P/F
1	2483.50	-18.62	49.73	31.11	54.00	-22.89	Average	111	153	P
2	2483.50	-18.62	79.83	61.21	74.00	-12.79	Peak	111	153	P
3	4960.00	-12.96	29.62	16.66	54.00	-37.34	Average	102	256	P
4	4960.00	-12.96	59.72	46.76	74.00	-27.24	Peak	102	256	P
5	7440.00	-9.58	40.27	30.69	54.00	-23.31	Average	101	82	P
6	7440.00	-9.58	70.37	60.79	74.00	-13.21	Peak	101	82	P

Note: Level=Reading+Factor
 Margin=Level-Limit
 Factor=Antenna Factor + cable loss - Amplifier Factor



Power	: From System	Pol/Phase	: HORIZONTAL
Test Mode	: Mode 3, CH78	Temperature	: 24 °C
Test Date	: Sep. 01, 2017	Humidity	: 63 %

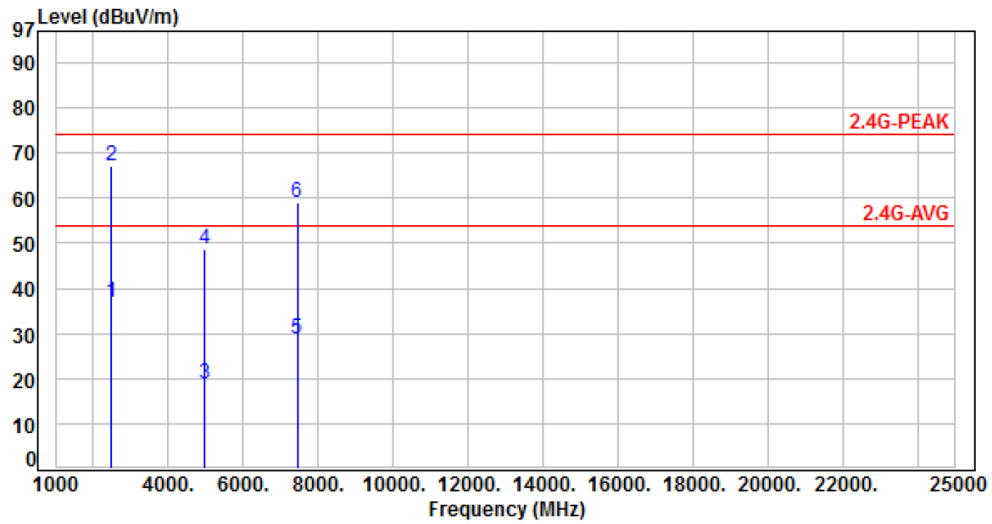

No.	Frequency (MHz)	Factor (dB)	Reading (dBuV)	Level (dBuV)	Limit (dBuV)	Margin (dB)	Detector	Height (cm)	Azimuth (deg)	P/F
1	2483.50	-18.62	55.68	37.06	54.00	-16.94	Average	114	41	P
2	2483.50	-18.62	85.78	67.16	74.00	-6.84	Peak	114	41	P
3	4960.00	-12.96	31.62	18.66	54.00	-35.34	Average	139	284	P
4	4960.00	-12.96	61.72	48.76	74.00	-25.24	Peak	139	284	P
5	7440.00	-9.58	38.44	28.86	54.00	-25.14	Average	127	141	P
6	7440.00	-9.58	68.54	58.96	74.00	-15.04	Peak	127	141	P

Note: Level=Reading+Factor
 Margin=Level-Limit
 Factor=Antenna Factor + cable loss - Amplifier Factor



6.7 Restricted Bands of Operation

Only spurious emissions are permitted in any of the frequency bands listed below:

MHz	MHz	MHz	GHz
0.09000 – 0.11000	16.42000 – 16.42300	399.9 – 410.0	4.500 – 5.250
0.49500 – 0.505**	16.69475 – 16.69525	608.0 – 614.0	5.350 – 5.460
2.17350 – 2.19050	16.80425 – 16.80475	960.0 – 1240.0	7.250 – 7.750
4.12500 – 4.12800	25.50000 – 25.67000	1300.0 – 1427.0	8.025 – 8.500
4.17725 – 4.17775	37.50000 – 38.25000	1435.0 – 1626.5	9.000 – 9.200
4.20725 – 4.20775	73.00000 – 74.60000	1645.5 – 1646.5	9.300 – 9.500
6.21500 – 6.21800	74.80000 – 75.20000	1660.0 – 1710.0	10.600 – 12.700
6.26775 – 6.26825	108.00000 – 121.94000	1718.8 – 1722.2	13.250 – 13.400
6.31175 – 6.31225	123.00000 – 138.00000	2200.0 – 2300.0	14.470 – 14.500
8.29100 – 8.29400	149.90000 – 150.05000	2310.0 – 2390.0	15.350 – 16.200
8.36200 – 8.36600	156.52475 – 156.52525	2483.5 – 2500.0	17.700 – 21.400
8.37625 – 8.38675	156.70000 – 156.90000	2655.0 – 2900.0	22.010 – 23.120
8.41425 – 8.41475	162.01250 – 167.17000	3260.0 – 3267.0	23.600 – 24.000
12.29000 – 12.29300	167.72000 – 173.20000	3332.0 – 3339.0	31.200 – 31.800
12.51975 – 12.52025	240.00000 – 285.00000	3345.8 – 3358.0	36.430 – 36.500
12.57675 – 12.57725	322.00000 – 335.40000	3600.0 – 4400.0	Above 38.6
13.36000 – 13.41000			

** : Until February 1, 1999, this restricted band shall be 0.490-0.510 MHz



7. Test of Conducted Spurious Emission

7.1 Test Limit

Below -20dB of the highest emission level of operating band (in 100kHz Resolution Bandwidth).

7.2 Test Procedure

- a. The transmitter output was connected to the spectrum analyzer via a low lose cable.
- b. Set both RBW and VBW of spectrum analyzer to 100 KHz with convenient frequency span including 100 KHz bandwidth from band edge.
- c. The band edges was measured and recorded.

7.3 Test Setup Layout

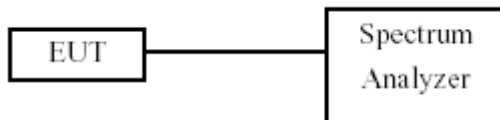

7.4 Test Result and Data

Test Result	: PASS	Temperature	: 26°C
Test Date	: Sep. 04, 2017	Humidity	: 62%

Note: Test plots refer to the following pages.



Modulation Type: GFSK, CH00

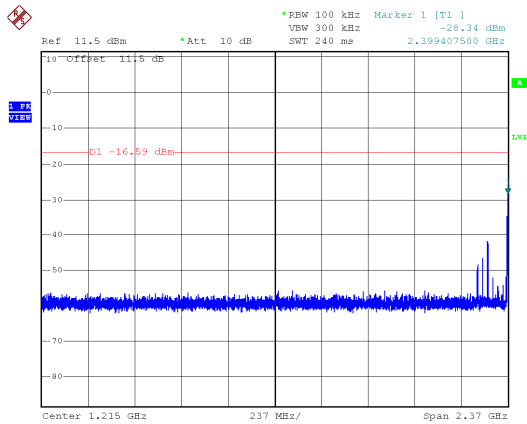

Modulation Type: GFSK, CH39

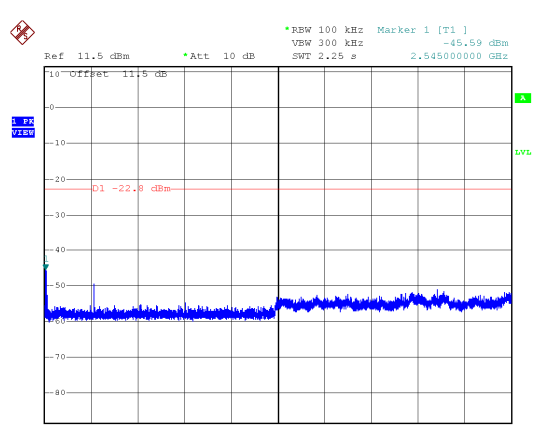
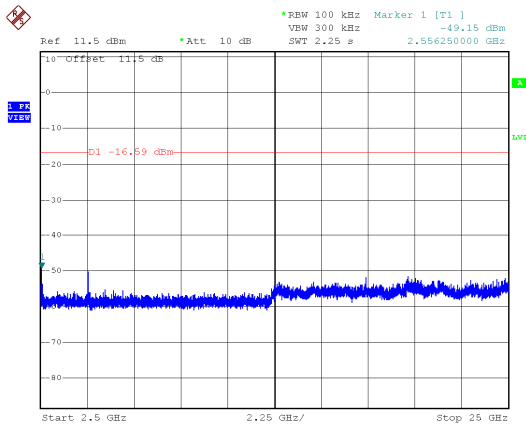
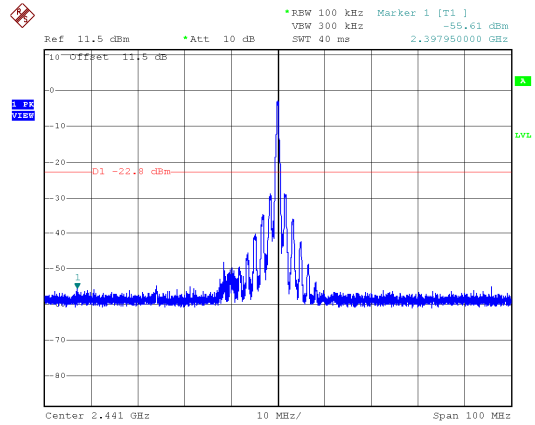
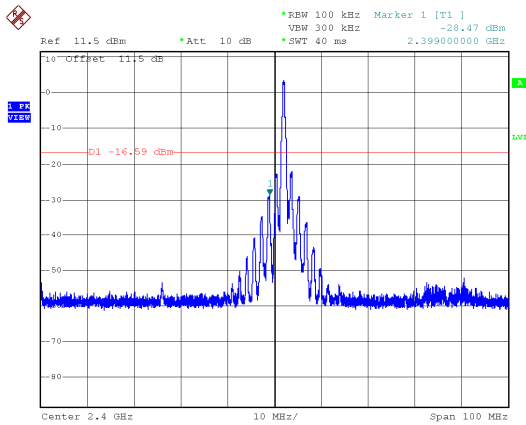
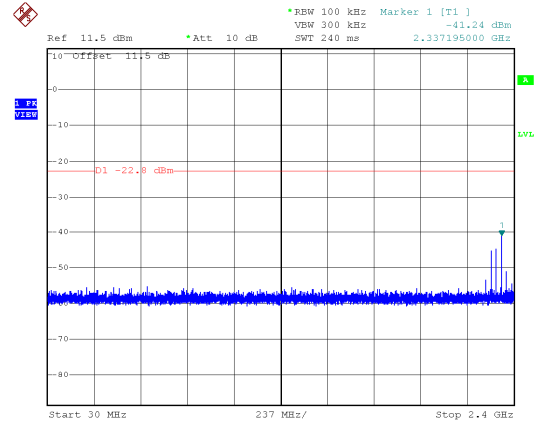



Modulation Type: GFSK, CH78

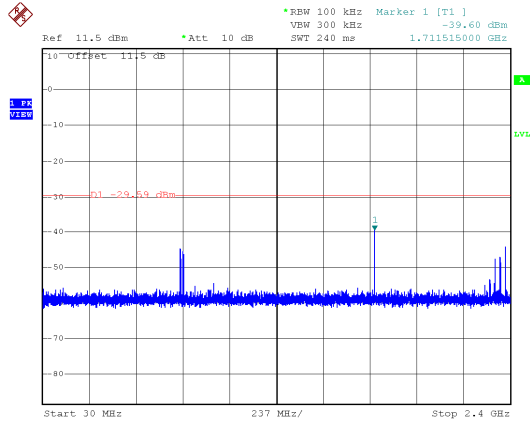

Modulation Type: $\pi/4$ -DQPSK, CH00

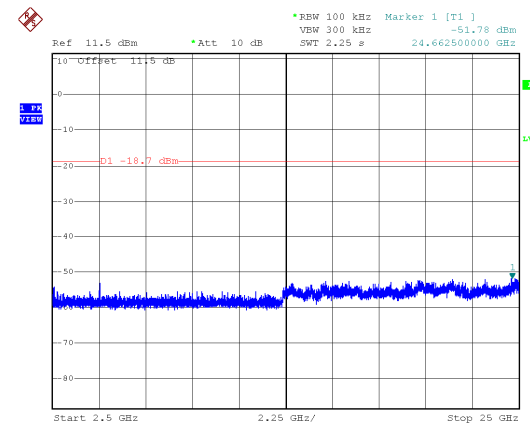
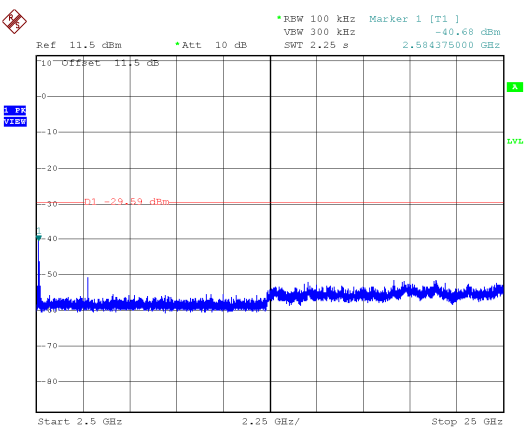
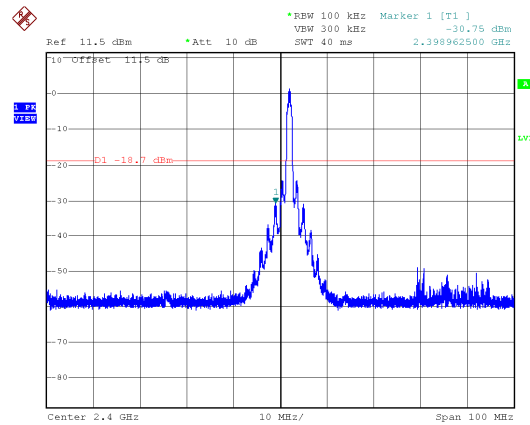
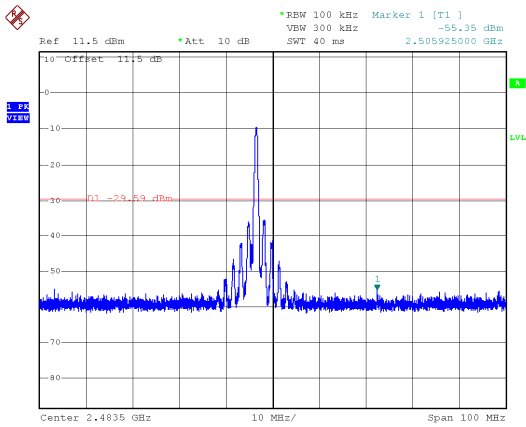
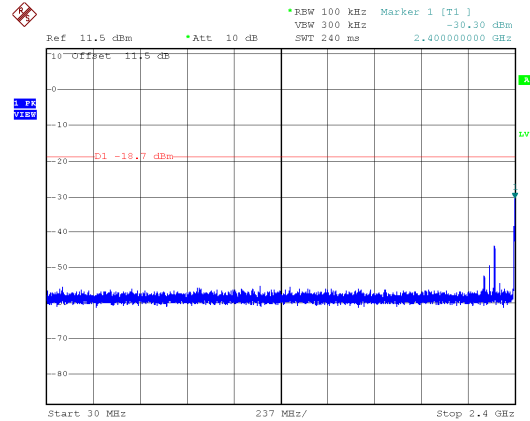



Modulation Type: $\pi/4$ -DQPSK, CH39

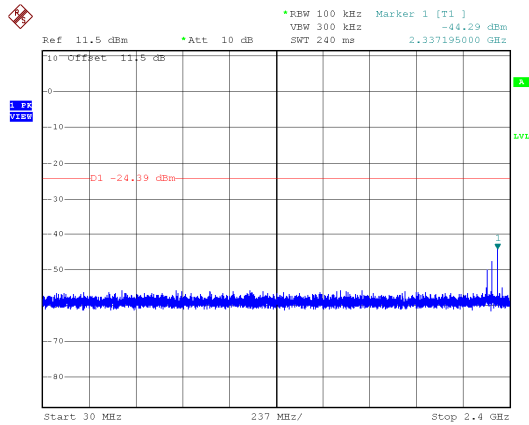

Modulation Type: $\pi/4$ -DQPSK, CH78

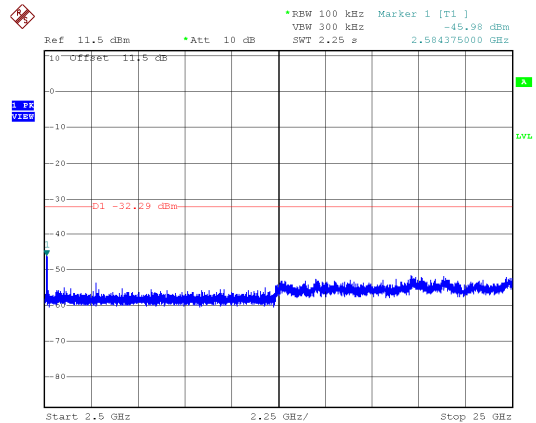
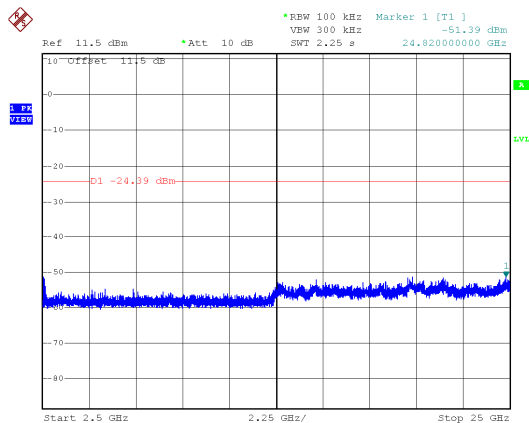
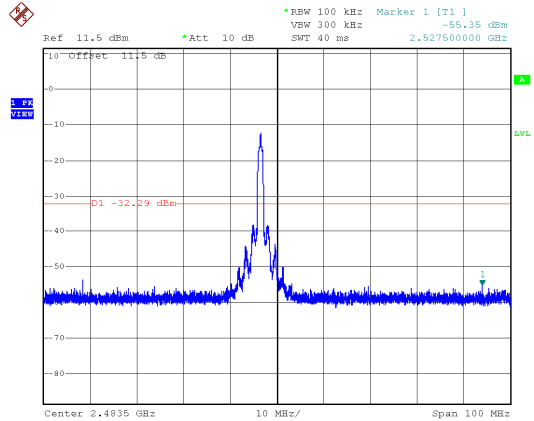
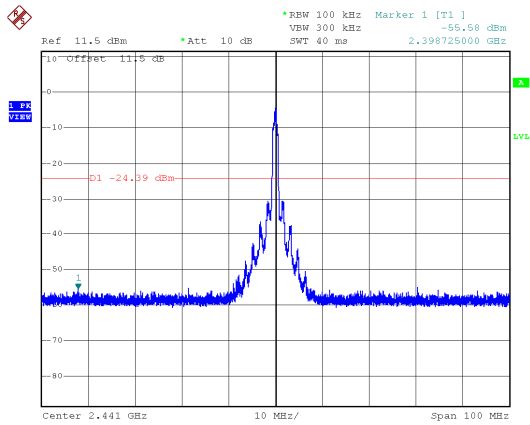
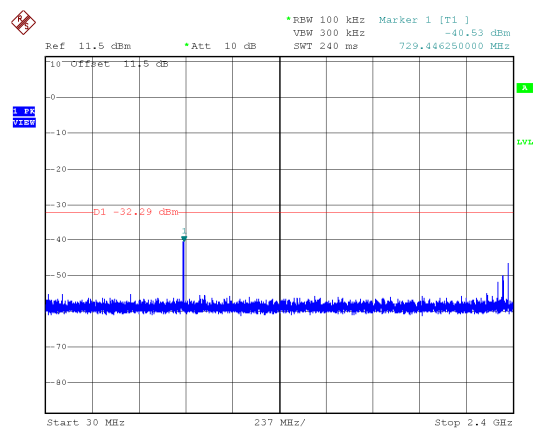



Modulation Type: 8DPSK, CH00

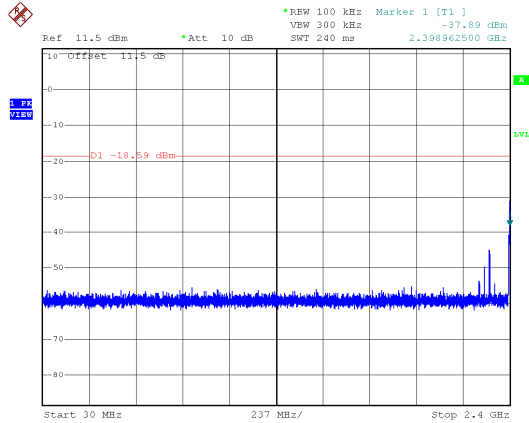

Modulation Type: 8DPSK, CH39

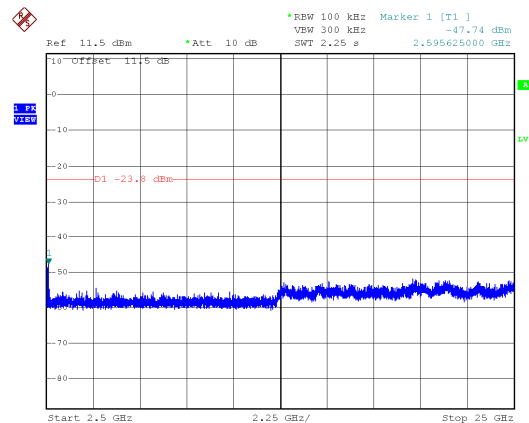
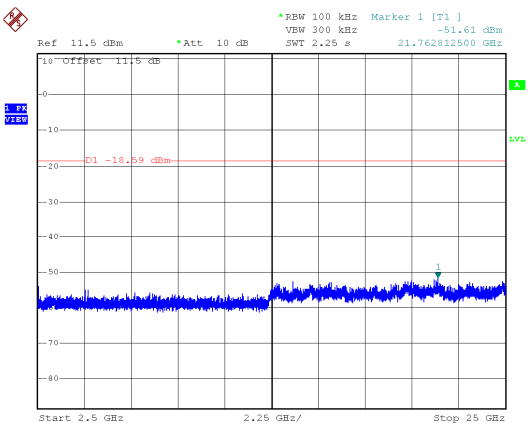
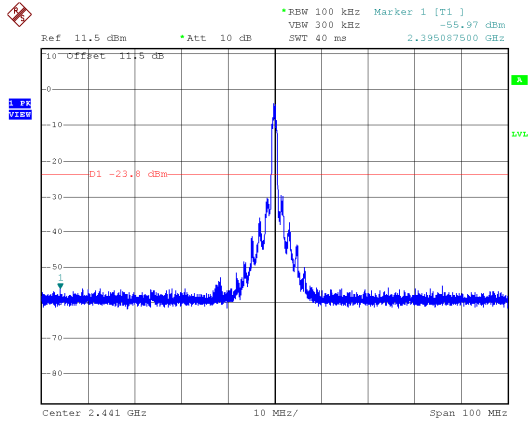
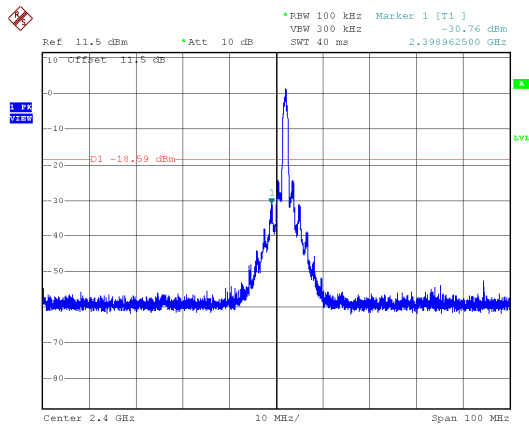
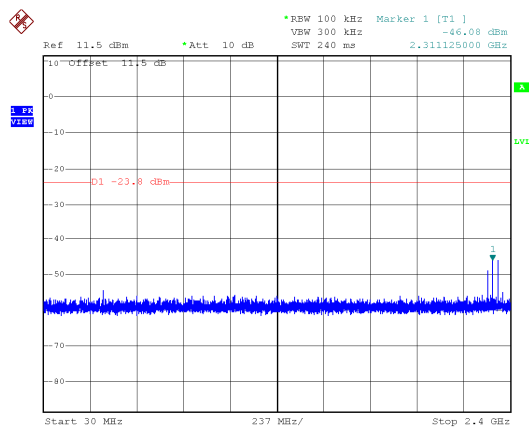



Modulation Type: 8DPSK, CH78

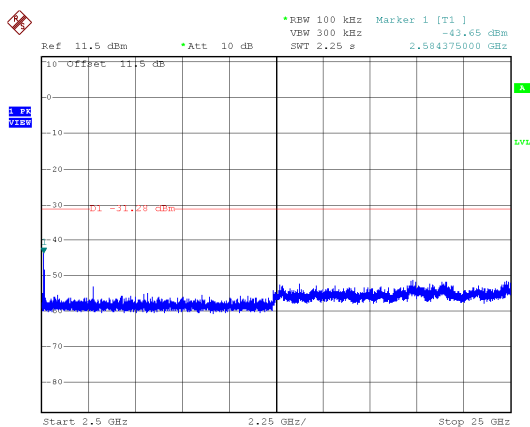
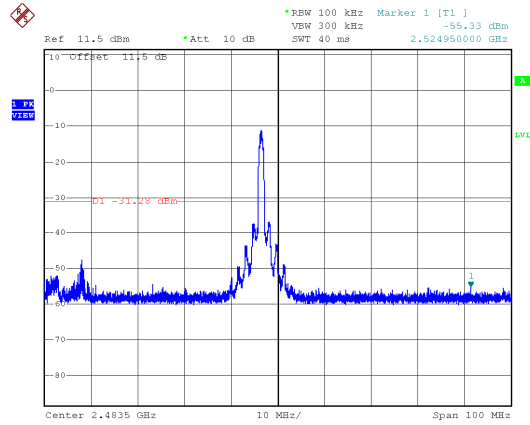
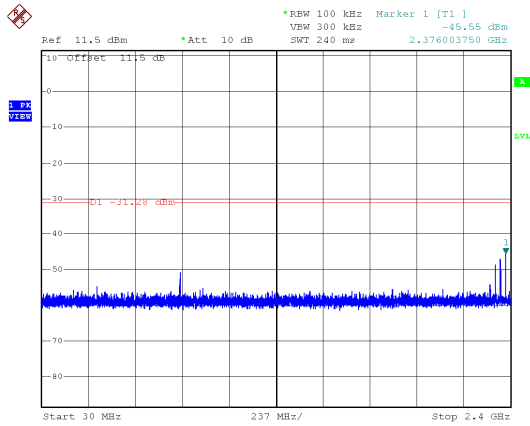



Hopping Mode:
Modulation Type: GFSK

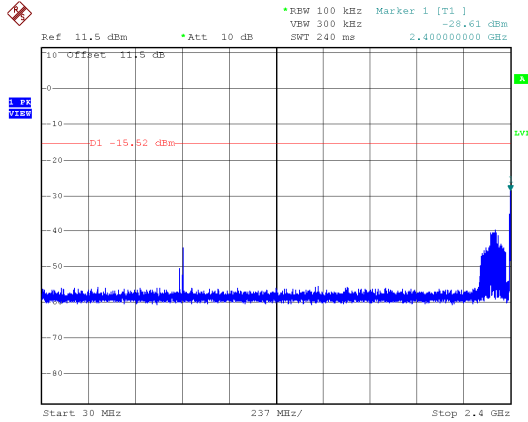

Modulation Type: $\pi/4$ -DQPSK

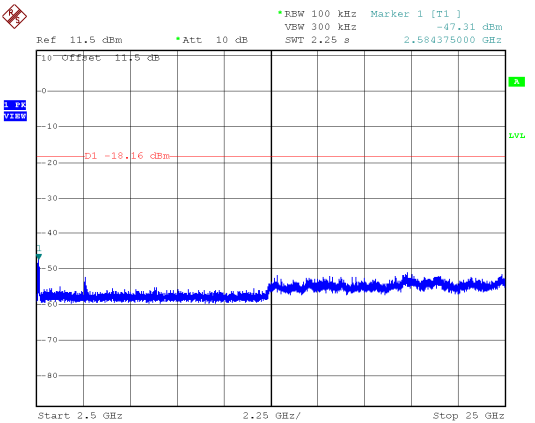
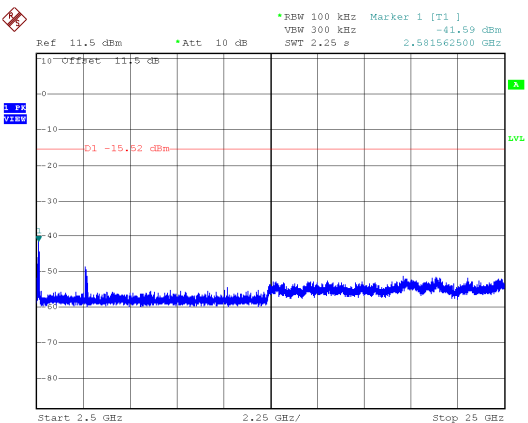
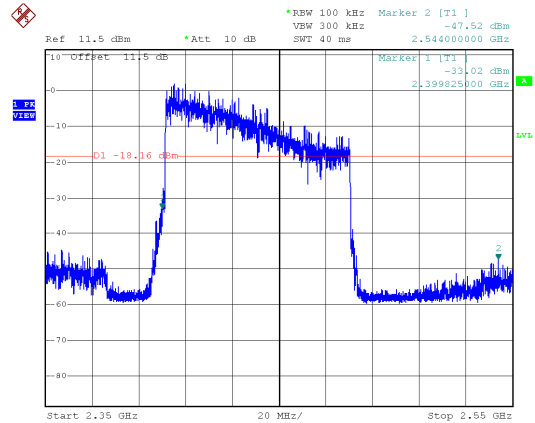
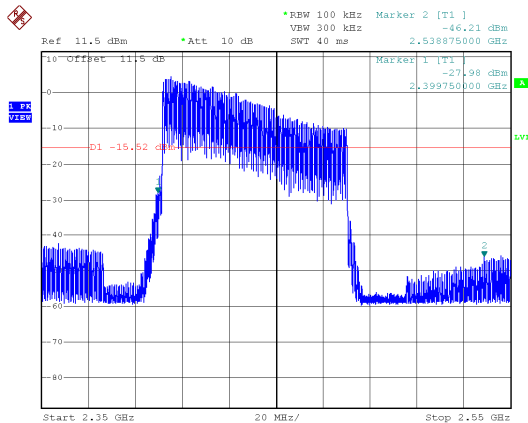
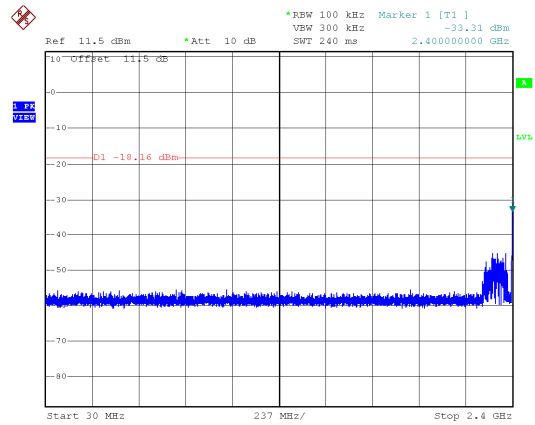



Modulation Type: 8DPSK

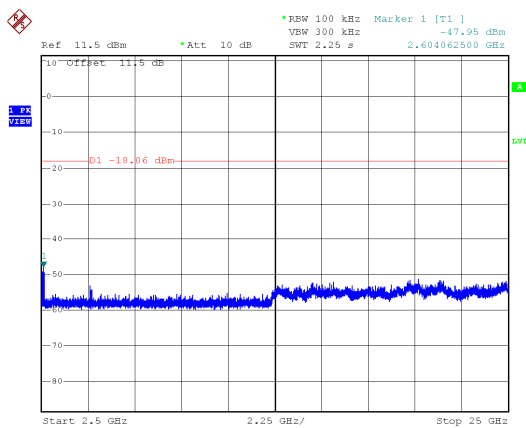
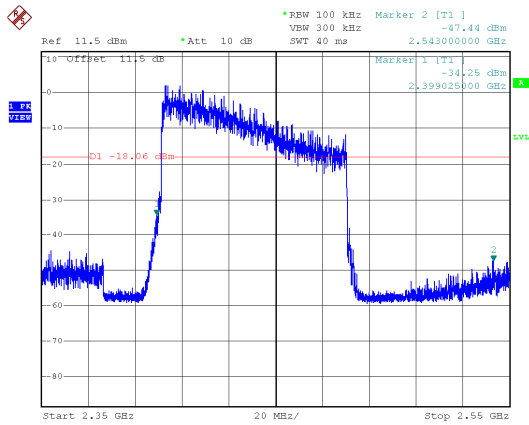
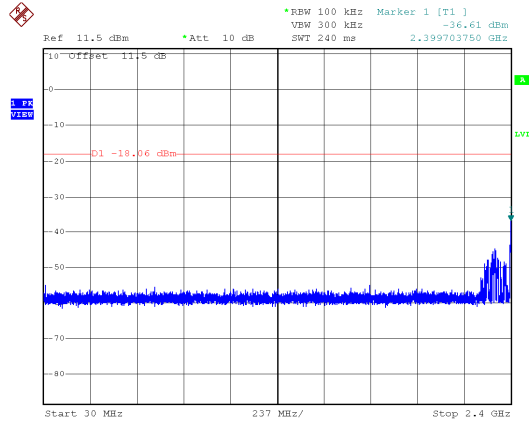



8. 20dB Bandwidth Measurement Data

8.1 Test Limit

Frequency hopping systems shall have hopping channel carrier frequencies separated by a minimum of 25 kHz or the 20 dB bandwidth of the hopping channel, whichever is greater. Alternatively, frequency hopping systems operating in the 2400–2483.5 MHz band may have hopping channel carrier frequencies that are separated by 25 kHz or two-thirds of the 20 dB bandwidth of the hopping channel, whichever is greater, provided the systems operate with an output power no greater than 125 mW.

8.2 Test Procedures

- a. The transmitter output was connected to the spectrum analyzer.
- b. Set RBW of spectrum analyzer to 30 KHz and VBW to 100 KHz.
- c. The 20 dB bandwidth is defined as the total spectrum the power of which is higher than peak power minus 20 dB.

8.3 Test Setup Layout

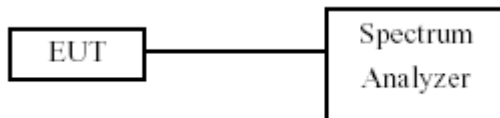

8.4 Test Result and Data

Test Result	: PASS	Temperature	: 26°C
Test Date	: Sep. 04, 2017	Humidity	: 62%

Modulation Type	Channel	Frequency (MHz)	20dB Bandwidth (MHz)	2/3 20dB Bandwidth (MHz)
GFSK	0	2402	0.846	0.564
	39	2441	0.882	0.588
	78	2480	0.882	0.588
$\pi/4$ -DQPSK	0	2402	1.224	0.816
	39	2441	1.224	0.816
	78	2480	1.224	0.816
8DPSK	0	2402	1.254	0.836
	39	2441	1.254	0.836
	78	2480	1.254	0.836



Modulation Type: GFSK
CH00

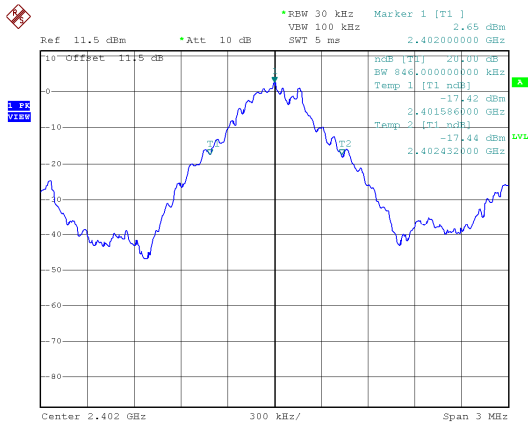

Modulation Type: $\pi/4$ -DQPSK
CH00

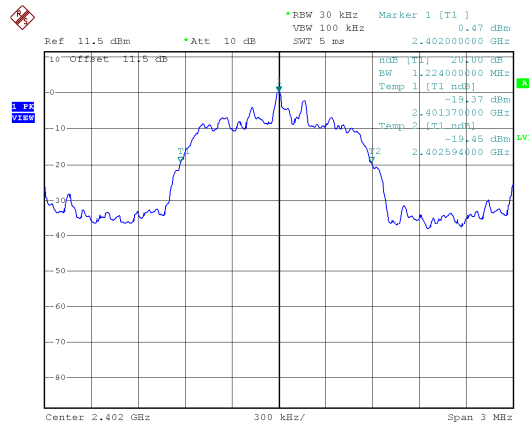

CH39

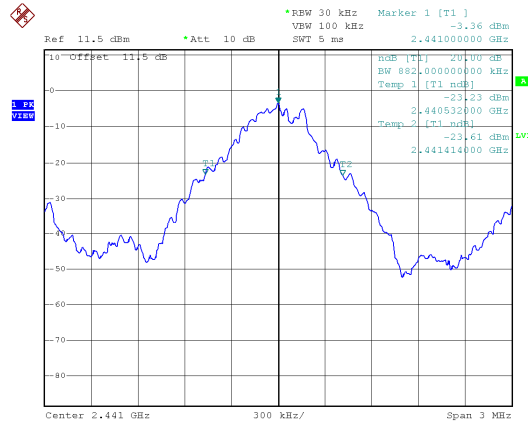

CH39

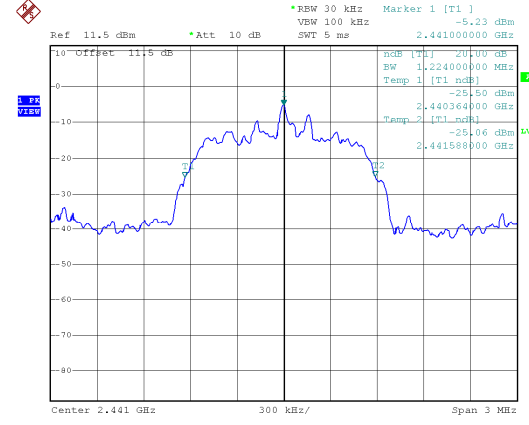

CH78

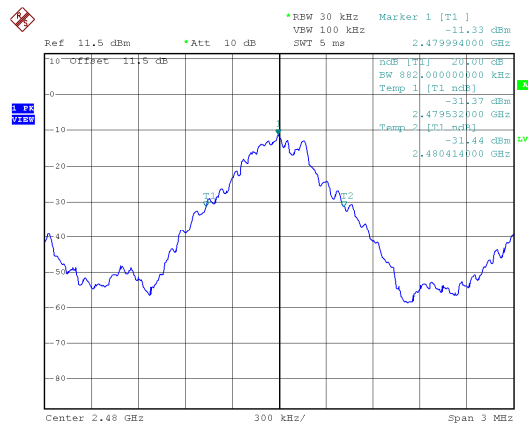

CH78

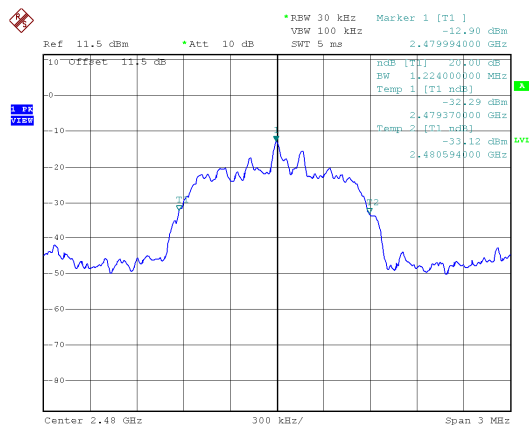



Modulation Type: 8DSPK
CH00

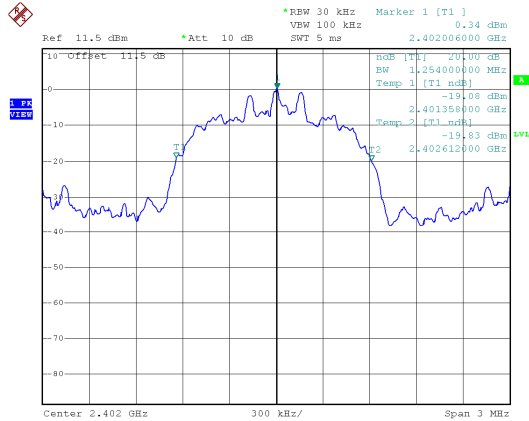

CH39

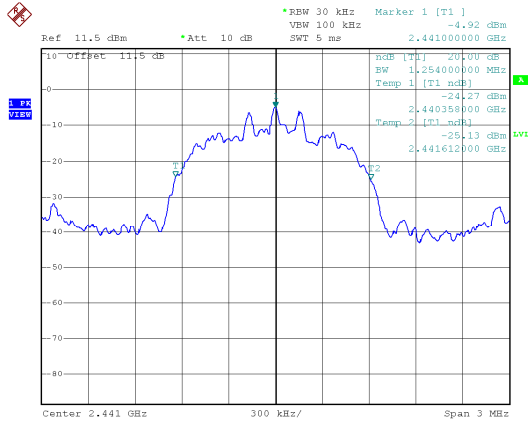

CH78

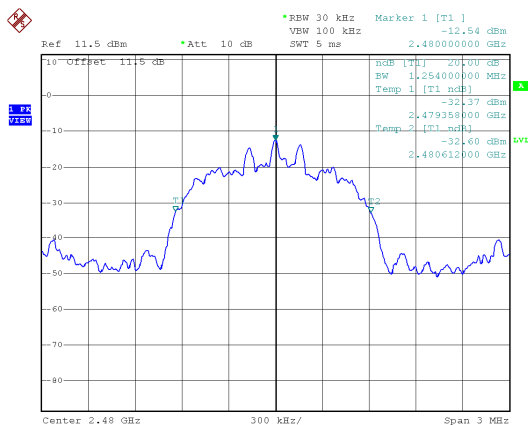



9. Frequencies Separation

9.1 Test Limit

Frequency hopping systems shall have hopping channel carrier frequencies separated by a minimum of 25 kHz or the 20 dB bandwidth of the hopping channel, whichever is greater.

9.2 Test Procedures

- a. The transmitter output was connected to the spectrum analyzer.
- b. Set RBW of spectrum analyzer to 30 KHz and VBW to 100 KHz.
- c. By using the MaxHold function record the separation of two adjacent channels.
- d. Measure the frequency difference of these two adjacent channels.

9.3 Test Setup Layout

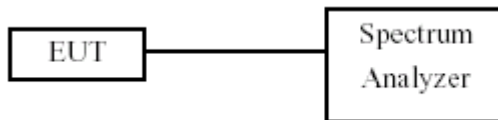

9.4 Test Result and Data

Test Result : PASS

Temperature : 26°C

Test Date : Sep. 04, 2017

Humidity : 62%

Modulation Type	Channel	Frequency (MHz)	Channel Separation (MHz)	Limit (MHz)
GFSK	00	2402	1.002	0.564
	39	2441	0.996	0.588
	78	2480	0.996	0.588
$\pi/4$ -DQPSK	00	2402	1.008	0.816
	39	2441	1.002	0.816
	78	2480	1.002	0.816
8DPSK	00	2402	1.002	0.836
	39	2441	1.008	0.836
	78	2480	0.996	0.836



Modulation Type: GFSK
CH00

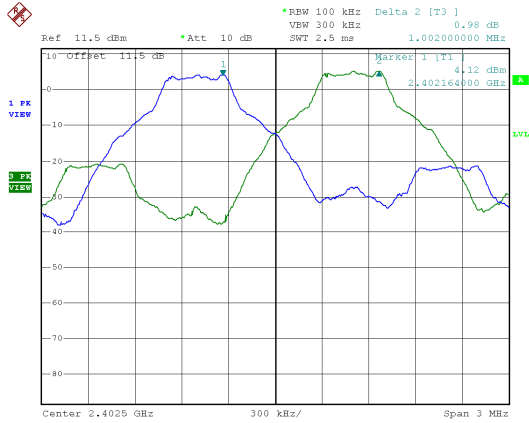

Modulation Type: $\pi/4$ -DQPSK
CH00

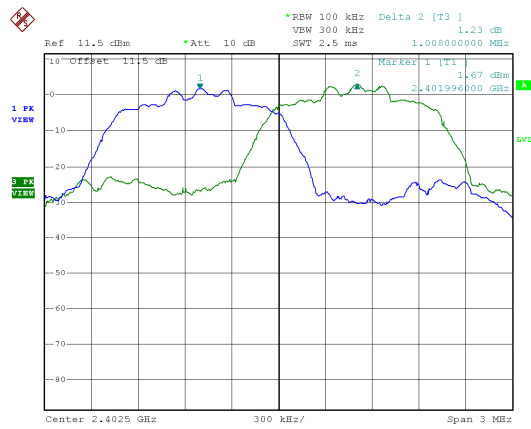

CH39

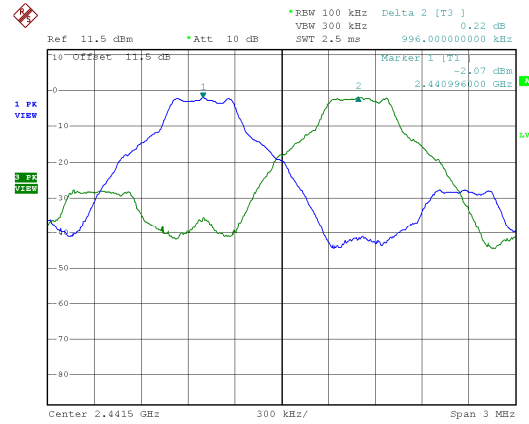

CH39

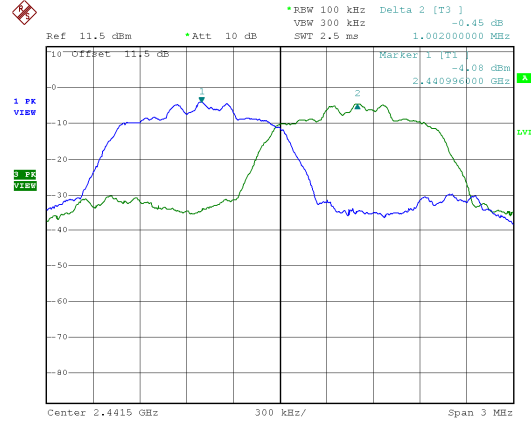

CH78

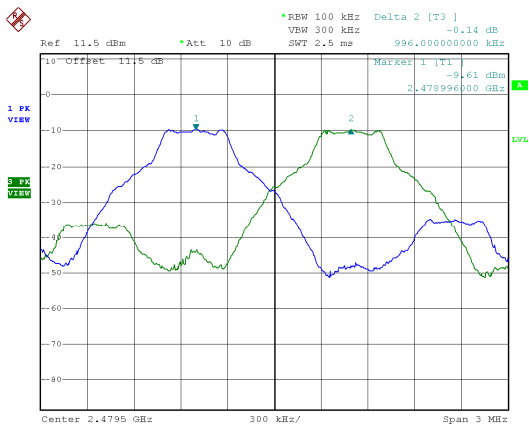

CH78

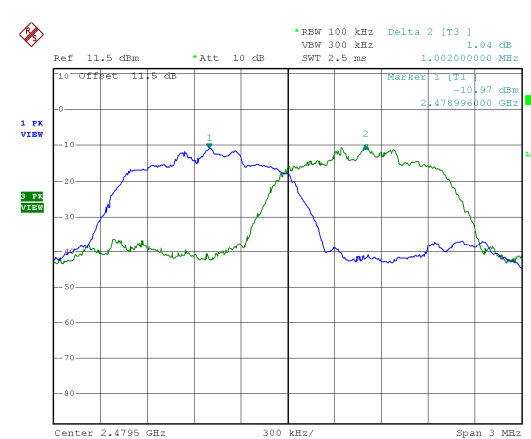



Modulation Type: 8DSPK
CH00

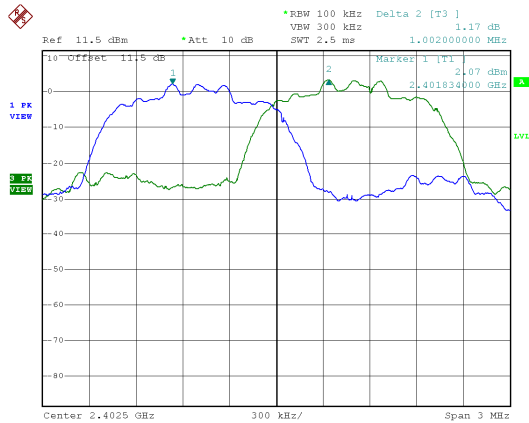

CH39

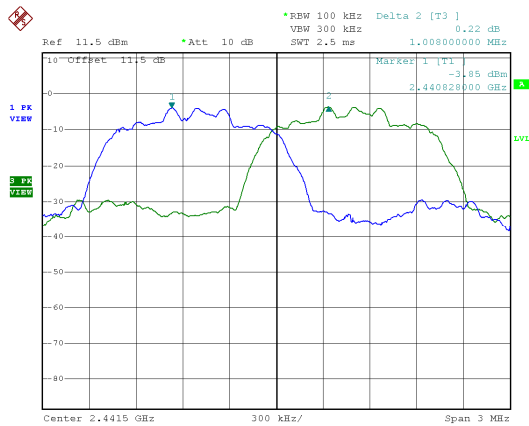

CH78

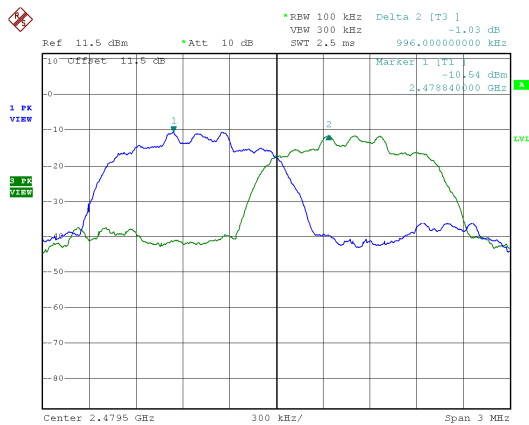



10. Dwell Time on each channel

10.1 Test Limit

The average time of occupancy on any channel shall not be greater than 0.4 seconds within a period of 0.4 seconds multiplied by the number of hopping channels employed.

10.2 Test Procedures

1. The transmitter output was connected to the spectrum analyzer.
2. Adjust the center frequency to measure frequency, then set zero span mode.
2. Set RBW of spectrum analyzer to 1 MHz and VBW to 1 MHz.
4. Measure the time duration of one transmission on the measured frequency.

10.3 Test Setup Layout

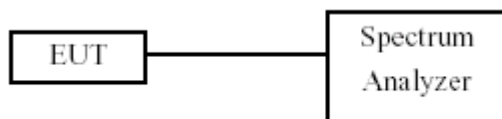

10.4 Test Result and Data

Test Result : PASS Temperature : 26°C
 Test Date : Sep. 04, 2017 Humidity : 62%
 Test Period = 0.4 (second/ channel) x 79 Channel = 31.6 sec

Modulation Type	Frequency (MHz)	Length of transmission time (ms)	Number of transmission in a 31.6 (79 Hopping*0.4)	Dwell Time (ms)	Limit (ms)
GFSK (DH1)	2402	0.428	320.10	137.00	400
GFSK (DH3)	2402	1.698	159.90	271.51	400
GFSK (DH5)	2402	2.960	106.81	316.16	400
$\pi/4$ -DQPSK (DH1)	2402	0.436	320.10	139.56	400
$\pi/4$ -DQPSK (DH3)	2402	1.704	159.90	272.47	400
$\pi/4$ -DQPSK (DH5)	2402	2.960	106.81	316.16	400
8DPSK (DH1)	2402	0.440	320.10	140.84	400
8DPSK (DH3)	2402	1.712	159.90	273.75	400
8DPSK (DH5)	2402	2.968	106.81	317.01	400



Modulation Type: GFSK(DH1)

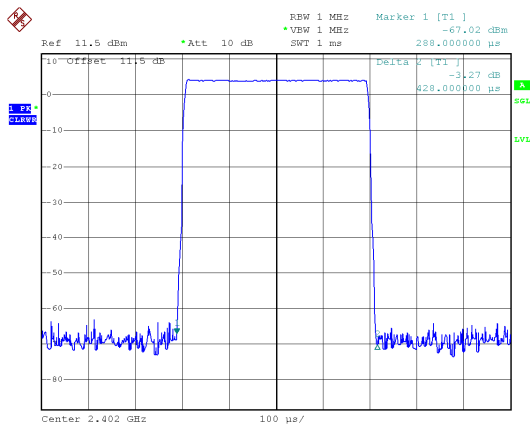

Modulation Type: $\pi/4$ -DQPSK (DH1)

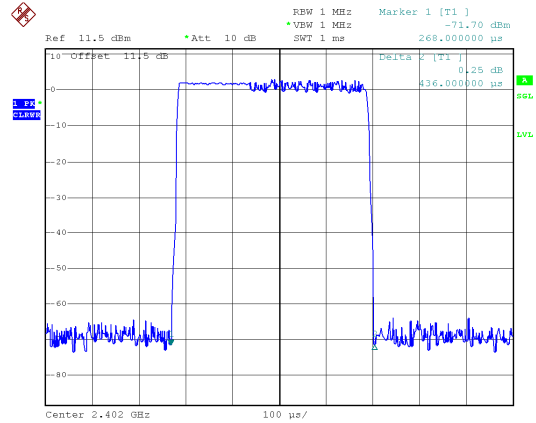

Modulation Type: GFSK(DH3)

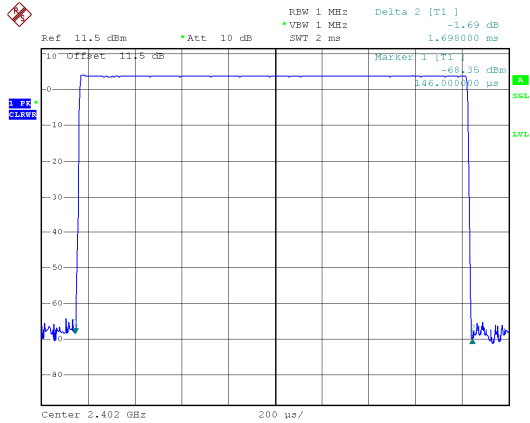

Modulation Type: $\pi/4$ -DQPSK (DH3)

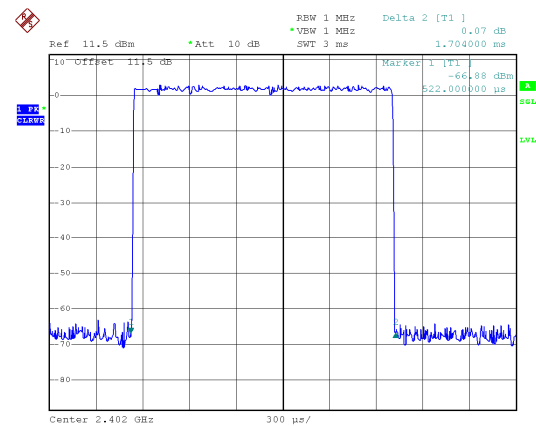

Modulation Type: GFSK(DH5)

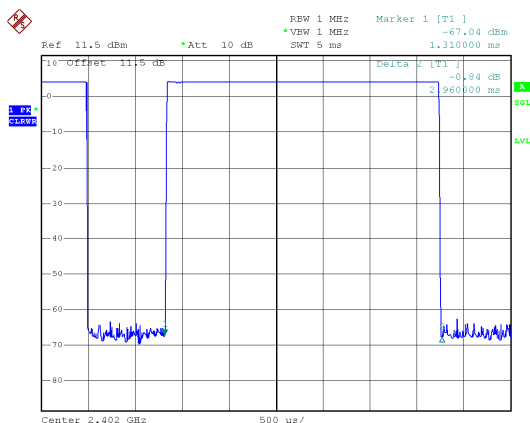

Modulation Type: $\pi/4$ -DQPSK (DH5)

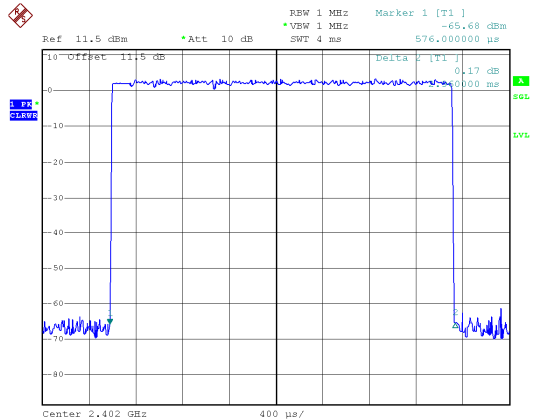



Modulation Type: 8DSPK (DH1)

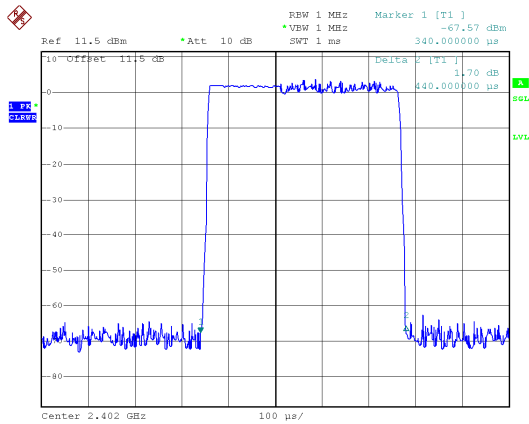

Modulation Type: 8DSPK (DH3)

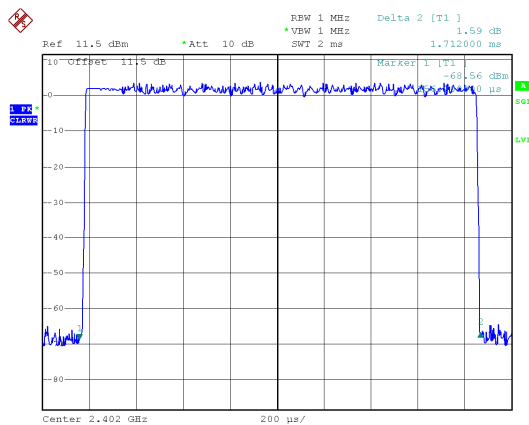

Modulation Type: 8DSPK (DH5)

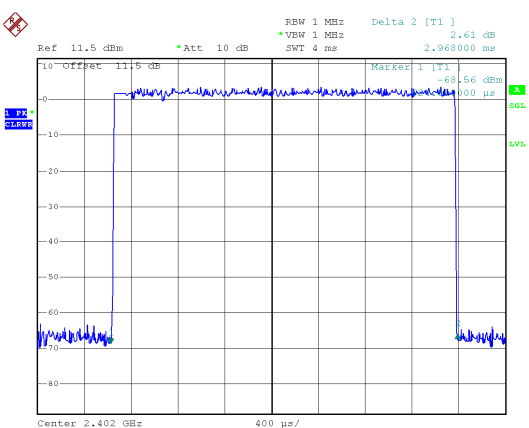



11. Number of Hopping Channels

11.1 Test Limit

Frequency hopping systems in the 2400 ~ 2483.5 MHz band shall use at least 15 channels.

11.2 Test Procedures

- a. The transmitter output was connected to the spectrum analyzer.
- b. 2. Set RBW of spectrum analyzer to 100 KHz and VBW to 100 KHz.
- c. 3. Set the MaxHold function, and then keep the EUT in hopping mode. Record all the signals from each channel until each one has been record.

11.3 Test Setup Layout

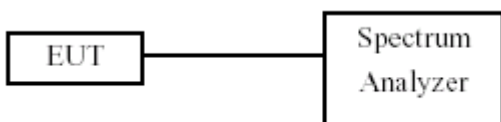

11.4 Test Result and Data

Test Result : PASS	Temperature : 26°C
Test Date : Sep. 04, 2017	Humidity : 62%

Modulation Type	Hopping Channels
GFSK	79
$\pi/4$ -DQPSK	79
8DPSK	79



Modulation Type: GFSK

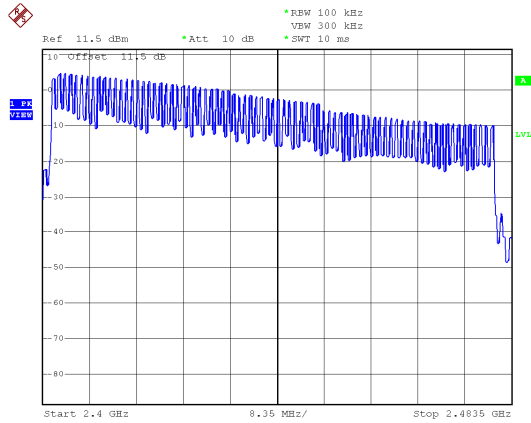

Modulation Type: $\pi/4$ -DQPSK

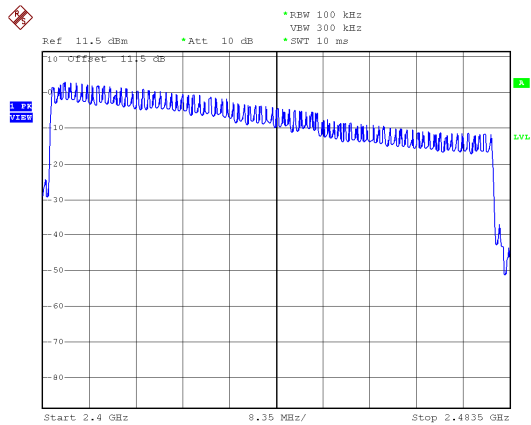

Modulation Type: 8DPSK

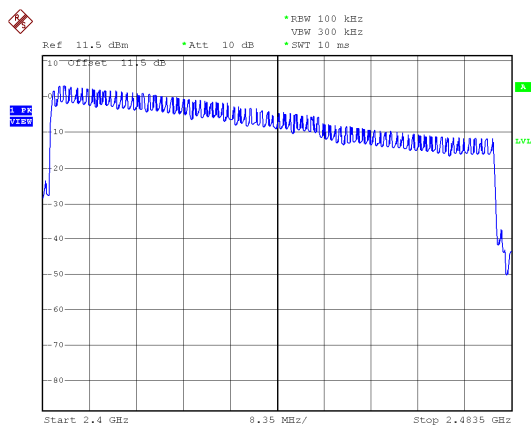



12. Maximum Peak Output Power

12.1 Test Limit

The Maximum Peak Output Power Measurement is 30dBm.

12.2 Test Procedures

The antenna port(RF output)of the EUT was connected to the input(RF input)of a power meter. Power was read directly from the meter and cable loss connection was added to the reading to obtain power at the EUT antenna terminal. The EUT Output Power was set to maximum to produce the worse case test result.

12.3 Test Setup Layout

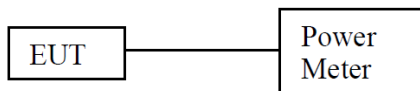



12.4 Test Result and Data

Test Result : PASS

Temperature : 26°C

Test Date : Sep. 04, 2017

Humidity : 62%

Modulation Type	Channel	Frequency (MHz)	Peak Output Power (dBm)	Peak Output Power (mW)
GFSK	00	2402	4.46	2.793
	39	2441	-1.23	0.753
	78	2480	-7.89	0.163
$\pi/4$ -DQPSK	00	2402	3.62	2.301
	39	2441	-1.63	0.687
	78	2480	-8.45	0.143
8DPSK	00	2402	4.39	2.748
	39	2441	-1.13	0.771
	78	2480	-8.24	0.150

Modulation Type	Channel	Frequency (MHz)	Average Output Power (dBm)	Average Output Power (mW)
GFSK	00	2402	2.89	1.945
	39	2441	-2.86	0.518
	78	2480	-10.16	0.096
$\pi/4$ -DQPSK	00	2402	-0.77	0.838
	39	2441	-6.59	0.219
	78	2480	-13.88	0.041
8DPSK	00	2402	-0.75	0.841
	39	2441	-6.83	0.207
	78	2480	-14.16	0.038

Note: Average power is for reference only.