



中国认可
国际互认
检测
TESTING
CNAS L2264

EMC TEST REPORT

Applicant Alcatel-Lucent Shanghai Bell CO. Ltd.
FCC ID 2ADZRXS250WXA
Product XGSPON ONU
Brand NOKIA
Model XS-250WX-A/XS-240W-A
Report No. YBA1612-0108EMC01R4
Issue Date March 30, 2017

TA Technology (Shanghai) Co., Ltd. tested the above equipment in accordance with the requirements in **FCC Code CFR47 Part15B (2015)/ ANSI C63.4 (2014)**. The test results show that the equipment tested is capable of demonstrating compliance with the requirements as documented in this report.

Wei Liu

Guangchang Fan

Performed by: Wei Liu/ Manager

Approved by: Guangchang Fan/ Director

TA Technology (Shanghai) Co., Ltd.

No.145, Jintang Rd, Tangzhen Industry Park, Pudong Shanghai, China

TEL: +86-021-50791141/2/3

FAX: +86-021-50791141/2/3-8000

Table of Contents

1	Test Laboratory.....	4
1.1	Notes of the Test Report.....	4
1.2	Test facility.....	4
1.3	Testing Location.....	5
2	General Description of Equipment under Test.....	6
2.1	Client Information.....	6
2.2	General information.....	6
2.3	Applied Standards.....	8
3	Test Case Results.....	9
3.1	Radiated Emission.....	9
3.2	Conducted Emission.....	15
4	Main Test Equipment.....	18
ANNEX A:	The EUT Appearance and Test Configuration.....	19
A.1	EUT Appearance.....	19
A.2	Test Setup.....	21

Summary of measurement results

Number	Test Case	Clause in FCC Rules	Conclusion
1	Radiated Emission	15.109, ANSI C63.4-2014	PASS
2	Conducted Emission	15.107, ANSI C63.4-2014	PASS
Test Date: December 20, 2016~January 17, 2017			

1 Test Laboratory

1.1 Notes of the Test Report

This report shall not be reproduced in full or partial, without the written approval of **TA technology (shanghai) co., Ltd.** The results documented in this report apply only to the tested sample, under the conditions and modes of operation as described herein .Measurement Uncertainties were not taken into account and are published for informational purposes only. This report is written to support regulatory compliance of the applicable standards stated above. This report must not be used by the client to claim product certification, approval, or endorsement by CNAS or any government agencies.

1.2 Test facility

CNAS (accreditation number: L2264)

TA Technology (Shanghai) Co., Ltd. has obtained the accreditation of China National Accreditation Service for Conformity Assessment (CNAS).

FCC (recognition number is 428261)

TA Technology (Shanghai) Co., Ltd. has been listed on the US Federal Communications Commission list of test facilities recognized to perform electromagnetic emissions measurements.

IC (recognition number is 8510A)

TA Technology (Shanghai) Co., Ltd. has been listed by industry Canada to perform electromagnetic emission measurement.

VCCI (recognition number is C-4595, T-2154, R-4113, G-766)

TA Technology (Shanghai) Co., Ltd. has been listed by industry Japan to perform electromagnetic emission measurement.

A2LA (Certificate Number: 3857.01)

TA Technology (Shanghai) Co., Ltd. has been listed by American Association for Laboratory Accreditation to perform electromagnetic emission measurement.

1.3 Testing Location

Company: TA Technology (Shanghai) Co., Ltd.
Address: No.145, Jintang Rd, Tangzhen Industry Park, Pudong Shanghai, China
City: Shanghai
Post code: 201201
Country: P. R. China
Contact: Xu Kai
Telephone: +86-021-50791141/2/3
Fax: +86-021-50791141/2/3-8000
Website: <http://www.ta-shanghai.com>
E-mail: xukai@ta-shanghai.com

2 General Description of Equipment under Test

2.1 Client Information

Applicant	Alcatel-Lucent Shanghai Bell CO. Ltd.
Applicant address	388-389#,Ningqiao Road,Pudong Jinqiao, Shanghai, P.R. China
Manufacturer	Alcatel-Lucent Shanghai Bell CO. Ltd.
Manufacturer address	388-389#,Ningqiao Road,Pudong Jinqiao, Shanghai, P.R. China

2.2 General information

XS-250WX-A	XS-240W-A
With 10GE port	Without 10GE port
Note: Customer declaration, two models is the same except 10GE port, This report tested XS-250WX-A.	

	Model	ONU Part number	Kit Part number
US ONU	XS-250WX-A	3FE 46307 AA	-
US Kit	XS-250WX-A	3FE 46307 AA	3FE 46439 AA
US ONU	XS-240W-A	3FE 46631 AA	-
US Kit	XS-240W-A	3FE 46631 AA	3FE 46626 AA

EUT Description	
Device Type:	Portable Device
Product Name:	XGSPON ONU
Model Number:	XS-250WX-A/XS-240W-A
HW Version:	3FE 46307 AAAA 3FE 46631 AAAA
SW Version:	3FE46346
SN:	/
Antenna Type:	Internal Antenna/External Antenna
Used Host Product:	Fix Phone Manufacturer: TCL Model: HCD868(79)TSD
Test Mode:	Transfer Data Mode
EUT Accessory	
Adapter	Manufacturer: DELTA electronics, INC. Model: ADP-66CR BC
Remark: The information of the EUT is declared by the manufacturer. Please refer to the specifications or user manual for details.	

2.3 Applied Standards

According to the specifications of the manufacturer, it must comply with the requirements of the following standards:

Test standards

FCC Code CFR47 Part15B (2015)

ANSI C63.4 (2014)

3 Test Case Results

3.1 Radiated Emission

Ambient condition

Temperature	Relative humidity	Pressure
24°C~26°C	45%~50%	102.5kPa

Methods of Measurement

The EUT is placed on a non-metallic table 0.8m above the horizontal metal reference ground plane. The distance between EUT and receive antenna should be 3 meters. During the test, the EUT was operating in its typical mode. The test method is according to ANSI C63.4-2014. Sweep the whole frequency band through the range from 30MHz to the 5th harmonic of the carrier. During the test, the height of receive antenna shall be moved from 1 to 4 meters, and the antenna shall be performed under horizontal and vertical polarization. The turn table shall be rotated from 0 to 360 degrees for detecting the maximum of radiated signal level.

The data of cable loss and antenna factor has been calibrated in full testing frequency range before the testing. During the test, the EUT is worked at maximum output power.

Set the spectrum analyzer in the following:

Below 1GHz:

RBW=100 kHz / VBW=300 kHz / Sweep=AUTO

Above 1GHz:

(a) PEAK: RBW=1MHz VBW=3MHz/ Sweep=AUTO

(b) AVERAGE: RBW=1MHz / VBW=3MHz / Sweep=AUTO

During the test, EUT is connected to a laptop via a USB cable in the case of Transfer Data mode. The EUT is used as the peripheral equipment of the PC. The data is transferred from EUT to PC; PC is connected to server via a long LAN cable.

Test Setup

Below 1GHz

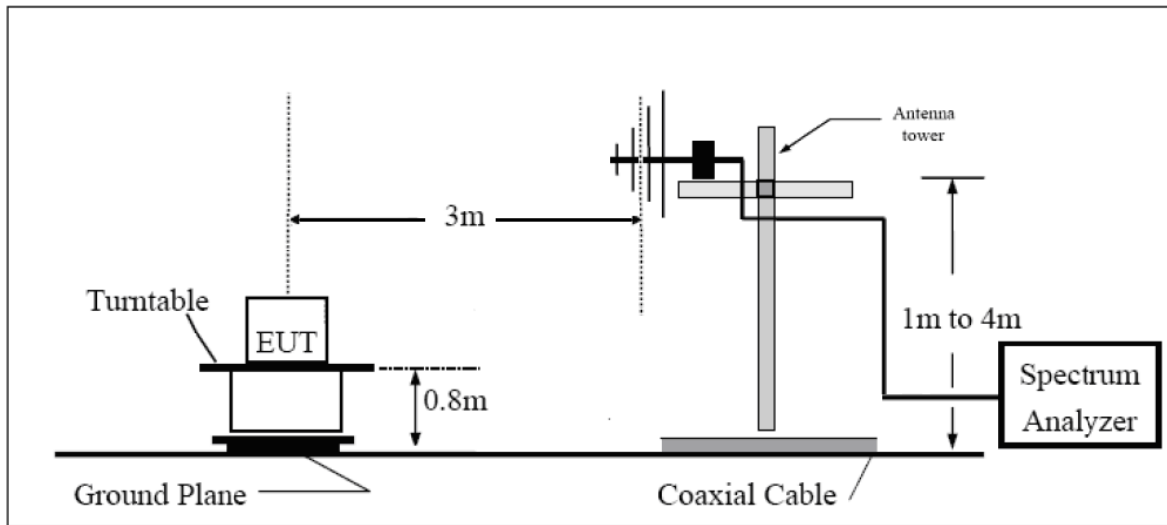

Above 1GHz

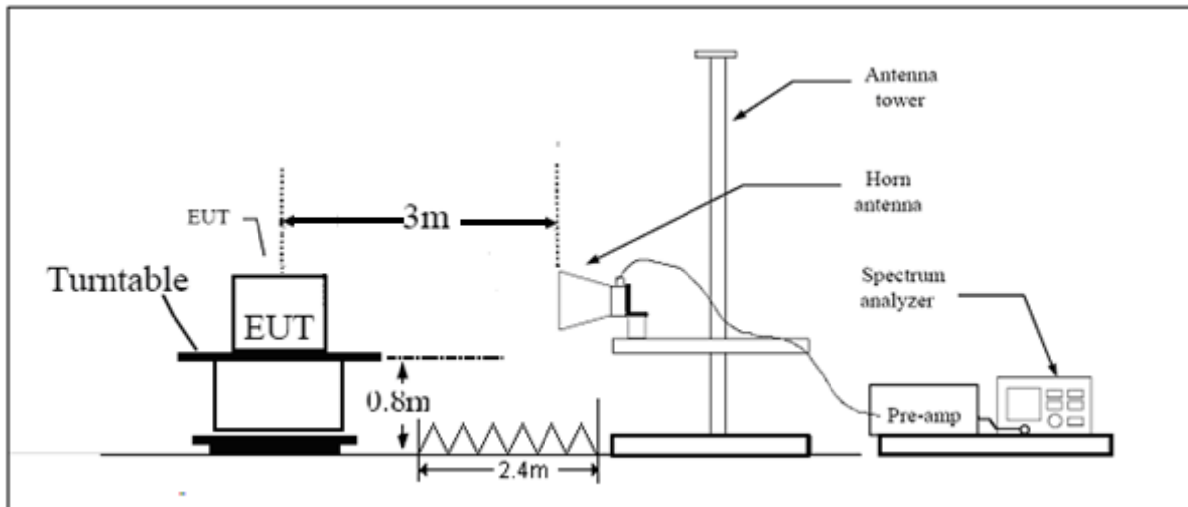

Note: Area side:2.4mX3.6m

Antenna Tower meets ANSI C63.4 requirements for measurements above 1 GHz by keeping the antenna aimed at the EUT during the antenna's ascent/ descent along the antenna mast.

Limits

Frequency (MHz)	Field Strength (dB μ V/m)	Detector
30 -88	40.0	Quasi-peak
88-216	43.5	Quasi-peak
216 – 960	46.0	Quasi-peak
960-1000	54.0	Quasi-peak
1000-5 th harmonic of the highest frequency or 40GHz, which is lower	54 74	Average Peak

Measurement Uncertainty

The assessed measurement uncertainty to ensure 95% confidence level for the normal distribution is with the coverage factor $k = 1.96$. $U = 3.92$ dB.

Test Results

The following graphs display the maximum values of horizontal and vertical by software.
 For above 1GHz, Blue trace uses the peak detection, Green trace uses the average detection.

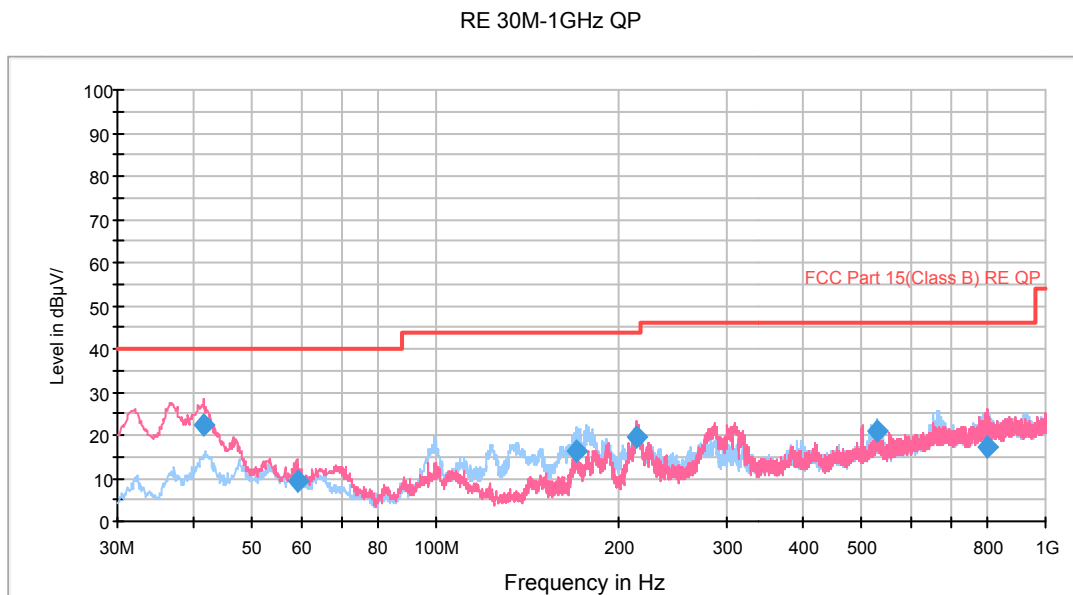

Radiated Emission from 30MHz to 1GHz

Frequency (MHz)	Quasi-Peak (dBuV/m)	Reading value (dBuV/m)	Height (cm)	Polarization	Azimuth (deg)	Correct Factor (dB)	Margin (dB)	Limit (dBuV/m)
41.494953	22.5	42.9	102.0	V	216.0	-20.4	17.5	40.0
59.192250	9.2	32.2	105.0	V	164.0	-23.0	30.8	40.0
169.577694	16.2	44.5	105.0	H	295.0	-28.3	27.3	43.5
213.761250	19.6	45.3	130.0	V	251.0	-25.7	23.9	43.5
527.893000	21.0	39.5	101.0	H	22.0	-18.5	25.0	46.0
804.492750	17.4	32.1	130.0	V	0.0	-14.7	28.6	46.0

- Remark:**
1. Quasi-Peak = Reading value + Correction factor
 2. Correction Factor = Antenna factor+ Insertion loss(cable loss+amplifier gain)
 3. Margin = Limit – Quasi-Peak

RE 1G-3GHz PK+AV

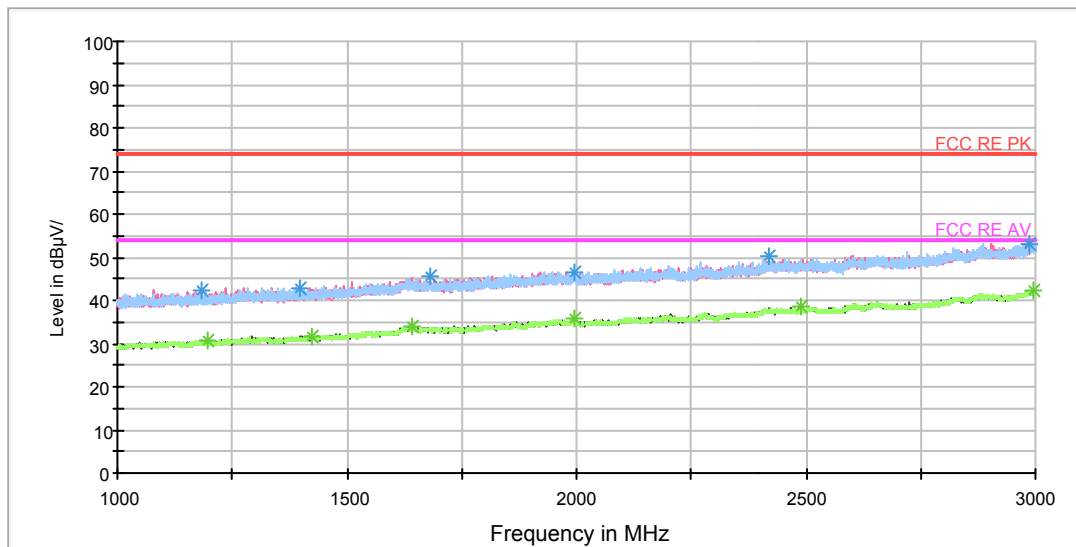

Radiated Emission from 1GHz to 3GHz

Frequency (MHz)	Peak (dBuV/m)	Reading value (dBuV/m)	Height (cm)	Polarization	Azimuth (deg)	Correct Factor (dB)	Margin (dB)	Limit (dBuV/m)
1182.750000	42.3	50.3	105.0	V	0.0	-8.0	31.7	74
1397.500000	43.0	50.1	205.0	V	251.0	-7.1	31.0	74
1681.500000	45.4	50.4	205.0	H	230.0	-5.0	28.6	74
1996.250000	46.7	50.0	105.0	V	203.0	-3.3	27.3	74
2419.250000	50.1	50.7	205.0	V	123.0	-0.6	23.9	74
2985.500000	53.2	55.4	105.0	H	0.0	-2.2	20.8	74

Frequency (MHz)	Average (dBuV/m)	Reading value (dBuV/m)	Height (cm)	Polarization	Azimuth (deg)	Correct Factor (dB)	Margin (dB)	Limit (dBuV/m)
1196.500000	30.6	38.8	205.0	H	0.0	-8.2	23.4	54
1422.500000	31.8	38.7	105.0	V	294.0	-6.9	22.2	54
1640.000000	33.8	38.5	205.0	V	43.0	-4.7	20.2	54
1996.500000	35.7	39.0	205.0	V	16.0	-3.3	18.3	54
2488.750000	38.4	38.6	205.0	V	243.0	-0.2	15.6	54
2995.250000	42.2	44.5	205.0	H	166.0	-2.3	11.8	54

RE 3-18GHz PK+AV_BELL SWEEP

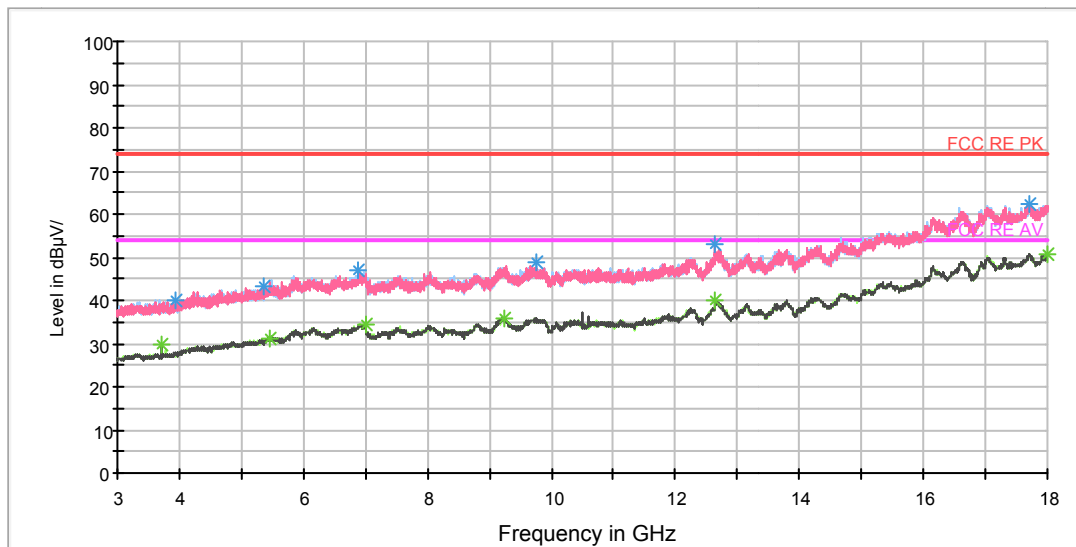

Radiated Emission from 3GHz to 18GHz

Frequency (MHz)	Peak (dBuV/m)	Reading value (dBuV/m)	Height (cm)	Polarization	Azimuth (deg)	Correct Factor (dB)	Margin (dB)	Limit (dBuV/m)
3922.500000	40.1	41.3	105.0	H	157.0	-1.2	33.9	74
5371.875000	43.1	45.4	105.0	H	0.0	-2.3	30.9	74
6881.250000	46.7	52.7	205.0	V	292.0	-6.0	27.3	74
9765.000000	48.7	58.3	205.0	H	4.0	-9.6	25.3	74
12637.500000	52.9	67.2	205.0	V	260.0	-14.3	21.1	74
17703.750000	62.3	87.0	105.0	H	222.0	-24.7	11.7	74

Frequency (MHz)	Average (dBuV/m)	Reading value (dBuV/m)	Height (cm)	Polarization	Azimuth (deg)	Correct Factor (dB)	Margin (dB)	Limit (dBuV/m)
3714.375000	29.6	31.2	105.0	V	0.0	-1.6	24.4	54
5445.000000	31.4	34.3	205.0	H	0.0	-2.9	22.6	54
6993.750000	34.4	40.9	105.0	H	286.0	-6.5	19.6	54
9232.500000	36.0	45.9	105.0	V	0.0	-9.9	18.0	54
12643.125000	40.2	54.6	205.0	H	35.0	-14.4	13.8	54
17998.125000	50.9	76.3	205.0	H	0.0	-25.4	3.1	54

3.2 Conducted Emission

Ambient condition

Temperature	Relative humidity	Pressure
24°C ~26°C	50%~55%	102.5kPa

Methods of Measurement

The EUT is placed on a non-metallic table of 80cm height above the horizontal metal reference ground plane. During the test, the EUT was operating in its typical mode. The test method is according to ANSI C63.4-2014. Connect the AC power line of the EUT to the L.I.S.N. Use EMI receiver to detect the average and Quasi-peak value. RBW is set to 9 kHz, VBW is set to 30kHz. The measurement result should include both L line and N line.

During the test, EUT is connected to a fix phone via a cable in the case of Transfer Data mode. The fix phone is used as the peripheral equipment of the EUT.

Test Setup

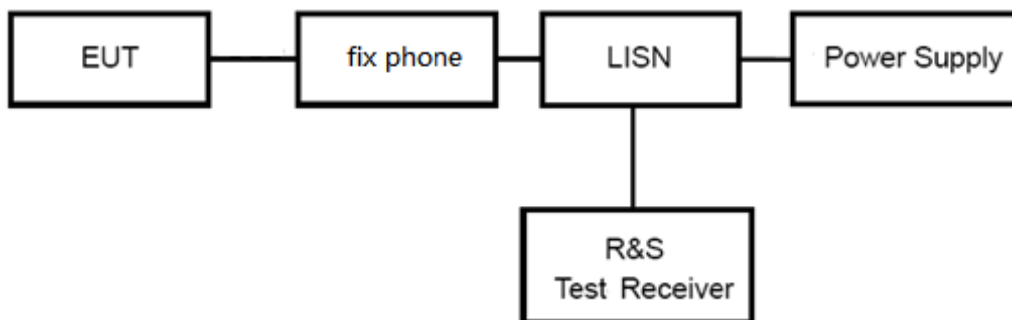

Note: Power Supply is AC Power source and it is used to change the voltage 120V/60Hz.

Limits

Frequency (MHz)	Conducted Limits(dBμV)	
	Quasi-peak	Average
0.15 - 0.5	66 to 56 *	56 to 46 *
0.5 - 5	56	46
5 - 30	60	50

*: Decreases with the logarithm of the frequency.

Measurement Uncertainty

The assessed measurement uncertainty to ensure 95% confidence level for the normal distribution is with the coverage factor $k = 1.96$. $U = 2.69$ dB.

Test Results

Following plots, Blue trace uses the peak detection; Green trace uses the average detection.

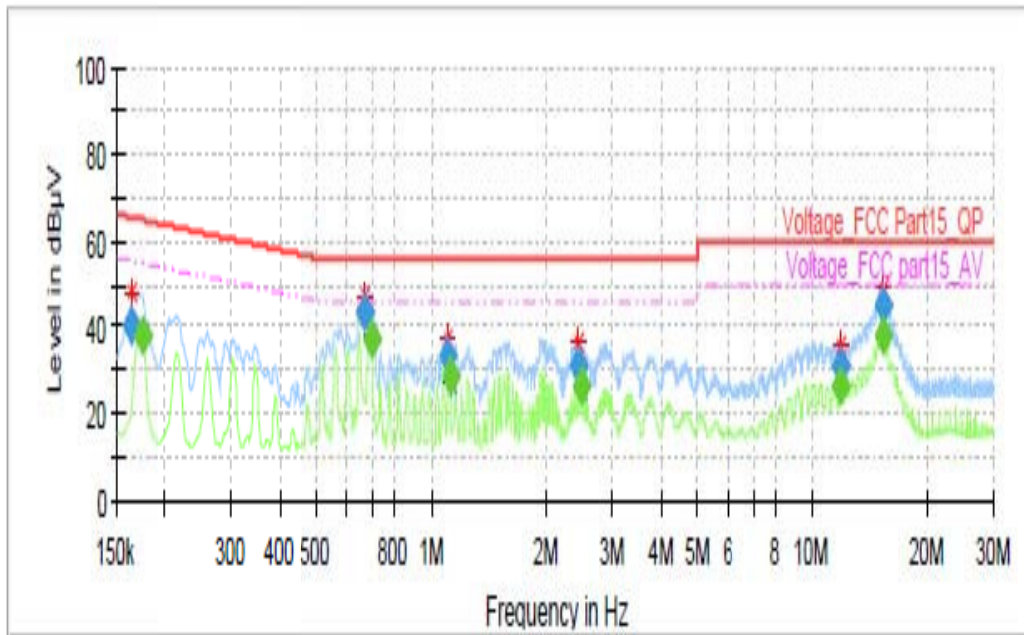

Final Result

Frequency (MHz)	QuasiPeak (dBµV)	Average (dBµV)	Limit (dBµV)	Margin (dB)	Meas. Time (ms)	Bandwidth (kHz)	Line	Filter	Corr. (dB)
0.163500	40.33	---	65.28	24.95	1000.0	9.000	L1	ON	19.1
0.174750	---	38.34	54.73	16.39	1000.0	9.000	L1	ON	19.2
0.672000	43.62	---	56.00	12.38	1000.0	9.000	L1	ON	19.3
0.696750	---	37.26	46.00	8.74	1000.0	9.000	L1	ON	19.3
1.113000	33.04	---	56.00	22.96	1000.0	9.000	L1	ON	19.2
1.128750	---	29.03	46.00	16.97	1000.0	9.000	L1	ON	19.2
2.424750	30.80	---	56.00	25.20	1000.0	9.000	L1	ON	19.0
2.476500	---	26.03	46.00	19.97	1000.0	9.000	L1	ON	19.0
11.901750	31.15	---	60.00	28.85	1000.0	9.000	L1	ON	19.4
11.904000	---	26.73	50.00	23.27	1000.0	9.000	L1	ON	19.4
15.362250	44.63	---	60.00	15.37	1000.0	9.000	L1	ON	19.5
15.472500	---	38.19	50.00	11.81	1000.0	9.000	L1	ON	19.4

L line

Conducted Emission from 150 KHz to 30 MHz

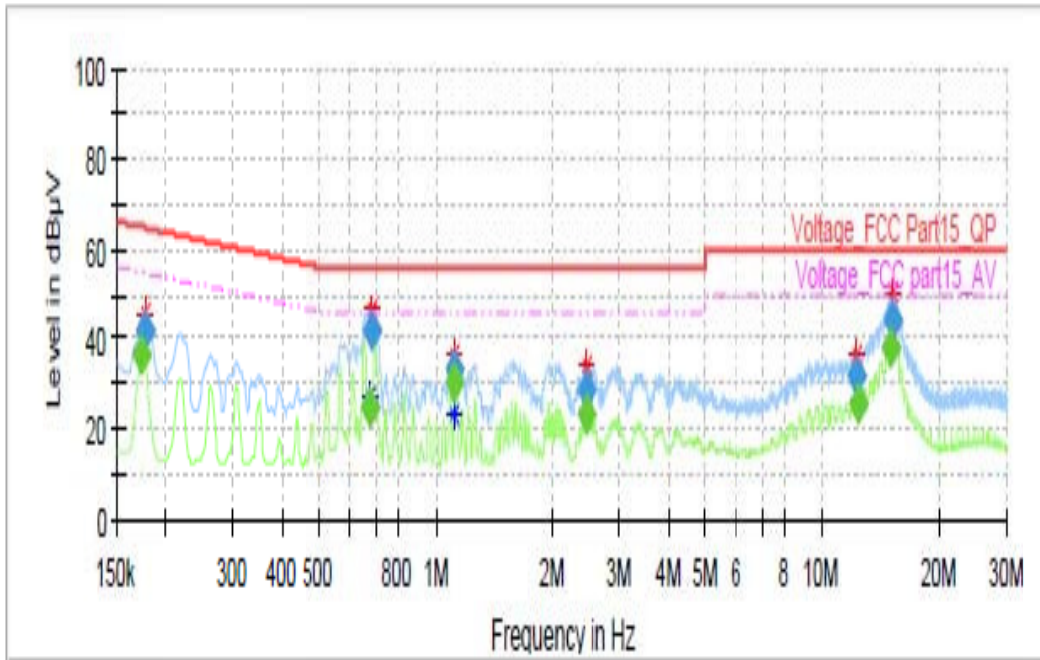

Final Result

Frequency (MHz)	QuasiPeak (dBµV)	Average (dBµV)	Limit (dBµV)	Margin (dB)	Meas. Time (ms)	Bandwidth (kHz)	Line	Filter	Corr. (dB)
0.172500	---	36.70	54.84	18.14	1000.0	9.000	N	ON	19.2
0.177000	41.73	---	64.63	22.89	1000.0	9.000	N	ON	19.2
0.674250	---	24.88	46.00	21.12	1000.0	9.000	N	ON	19.3
0.687750	42.03	---	56.00	13.97	1000.0	9.000	N	ON	19.3
1.122000	---	30.00	46.00	16.00	1000.0	9.000	N	ON	19.2
1.124250	33.10	---	56.00	22.90	1000.0	9.000	N	ON	19.2
2.463000	---	23.47	46.00	22.53	1000.0	9.000	N	ON	19.0
2.469750	28.80	---	56.00	27.20	1000.0	9.000	N	ON	19.0
12.277500	31.54	---	60.00	28.46	1000.0	9.000	N	ON	19.4
12.390000	---	25.88	50.00	24.12	1000.0	9.000	N	ON	19.4
15.083250	---	38.24	50.00	11.76	1000.0	9.000	N	ON	19.5
15.220500	43.92	---	60.00	16.08	1000.0	9.000	N	ON	19.4

N line

Conducted Emission from 150 KHz to 30 MHz

4 Main Test Equipment

Name	Type	Manufacturer	Serial Number	Last Cal.	Cal. Due Date
EMI Test Receiver	ESCI3	R&S	100948	2016-06-01	2017-05-31
Signal Analyzer	FSV30	R&S	100815	2016-12-16	2017-12-15
Loop Antenna	FMZB1519	SCHWARZBECK	1519-047	2014-02-29	2017-02-28
Trilog Antenna	VULB 9163	SCHWARZBECK	9163-201	2014-12-06	2017-12-05
Horn Antenna	HF907	R&S	100126	2014-12-06	2017-12-05
Horn Antenna	3160-09	ETS-Lindgren	00102643	2015-01-30	2018-01-29
EMI Test Receiver	ESCS30	R&S	100138	2016-12-16	2017-12-15
LISN	ENV216	R&S	101171	2016-12-17	2019-12-16
Bore Sight Antenna mast	2171B	ETS	00058752	NA	NA

ANNEX A: The EUT Appearance and Test Configuration

A.1 EUT Appearance





a: EUT



b: Adapter
Picture 1 EUT

A.2 Test Setup



a: Below 1GHz

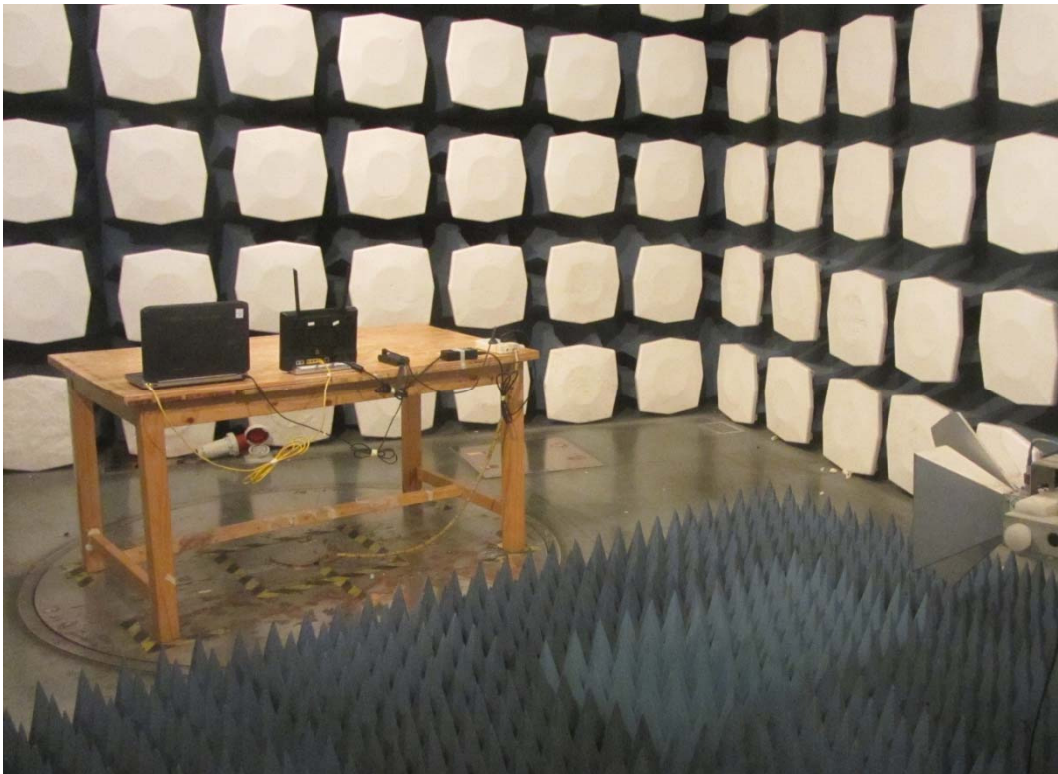

b: Above 1GHz

Picture 2 Radiated Emission Test Setup



Picture 3 Conducted Emission Test Setup