



中国认可
国际互认
检测
TESTING
CNAS L2264

RF TEST REPORT

Applicant	Alcatel-Lucent Shanghai Bell Co.,Ltd.
FCC ID	2ADZRXS250WXA
Product	XGSPON ONU
Brand	NOKIA
Model	XS-250WX-A/XS-240W-A
Report No.	YBA1612-0108RF01R3
Issue Date	March 29, 2017

TA Technology (Shanghai) Co., Ltd. tested the above equipment in accordance with the requirements in **FCC CFR47 Part 15C (2016)**. The test results show that the equipment tested is capable of demonstrating compliance with the requirements as documented in this report.

Performed by: Xianqing Li

Approved by: Kai Xu

TA Technology (Shanghai) Co., Ltd.

No.145, Jintang Rd, Tangzhen Industry Park, Pudong Shanghai, China

TEL: +86-021-50791141/2/3

FAX: +86-021-50791141/2/3-8000



TABLE OF CONTENT

1. Test Laboratory	4
1.1. Notes of the test report.....	4
1.2. Test facility	4
1.3. Testing Location.....	5
2. General Description of Equipment under Test.....	6
3. Applied Standards	8
4. Test Configuration	9
5. Test Case Results	11
5.1. Average Power Output –Conducted.....	11
5.2. 6dB Bandwidth	15
5.3. Band Edge	20
5.4. Power Spectral Density	23
5.5. Spurious RF Conducted Emissions.....	31
5.6. Radiated Emissions in the Restricted Band	39
5.7. Radiates Emission	44
5.8. Conducted Emission	95
6. Main Test Instruments.....	102
ANNEX A: EUT Appearance and Test Setup	103
A.1 EUT Appearance	103
A.2 Test Setup	105



Summary of measurement results

Number	Summary of measurements of results	Clause in FCC rules	Verdict
1	Maximum Average conducted output power	15.247(b)(3)	PASS
2	6 dB bandwidth	15.247(a)(2)	PASS
3	Maximum power spectral density	15.247(e)	PASS
4	Band Edge	15.247(d)	PASS
5	Spurious RF Conducted Emissions	15.247(d)	PASS
6	Radiated Emissions in restricted frequency bands	15.247(d),15.205,15.209	PASS
7	Radiated Emissions	15.247(d),15.205,15.209	PASS
8	Conducted Emissions	15.207	PASS
Date of Testing: December 20, 2016 ~ January 24, 2017			

1. Test Laboratory

1.1. Notes of the test report

This report shall not be reproduced in full or partial, without the written approval of **TA technology (shanghai) co., Ltd.** The results documented in this report apply only to the tested sample, under the conditions and modes of operation as described herein. Measurement Uncertainties were not taken into account and are published for informational purposes only. This report is written to support regulatory compliance of the applicable standards stated above. This report must not be used by the client to claim product certification, approval, or endorsement by CNAS or any government agencies.

1.2. Test facility

CNAS (accreditation number: L2264)

TA Technology (Shanghai) Co., Ltd. has obtained the accreditation of China National Accreditation Service for Conformity Assessment (CNAS).

FCC (recognition number is 428261)

TA Technology (Shanghai) Co., Ltd. has been listed on the US Federal Communications Commission list of test facilities recognized to perform electromagnetic emissions measurements.

IC (recognition number is 8510A)

TA Technology (Shanghai) Co., Ltd. has been listed by industry Canada to perform electromagnetic emission measurement.

VCCI (recognition number is C-4595, T-2154, R-4113, G-766)

TA Technology (Shanghai) Co., Ltd. has been listed by industry Japan to perform electromagnetic emission measurement.

A2LA (Certificate Number: 3857.01)

TA Technology (Shanghai) Co., Ltd. has been listed by American Association for Laboratory Accreditation to perform electromagnetic emission measurement.



1.3. Testing Location

Company: TA Technology (Shanghai) Co., Ltd.
Address: No.145, Jintang Rd, Tangzhen Industry Park, Pudong
City: Shanghai
Post code: 201201
Country: P. R. China
Contact: Xu Kai
Telephone: +86-021-50791141/2/3
Fax: +86-021-50791141/2/3-8000
Website: <http://www.ta-shanghai.com>
E-mail: xukai@ta-shanghai.com

2. General Description of Equipment under Test

Client Information

Applicant	Alcatel-Lucent Shanghai Bell Co.,Ltd.
Applicant address	388-389#,Ningqiao Road,Pudong Jinqiao, Shanghai, P.R. China
Manufacturer	Alcatel-Lucent Shanghai Bell Co.,Ltd.
Manufacturer address	388-389#,Ningqiao Road,Pudong Jinqiao, Shanghai, P.R. China

General information

XS-250WX-A	XS-240W-A
With 10GE port	Without 10GE port
Note: Customer declaration, two models is the same except 10GE port, This report tested XS-250WX-A.	

	Model	ONU Part number	Kit Part number
US ONU	XS-250WX-A	3FE 46307 AA	-
US Kit	XS-250WX-A	3FE 46307 AA	3FE 46439 AA
US ONU	XS-240W-A	3FE 46631 AA	-
US Kit	XS-240W-A	3FE 46631 AA	3FE 46626 AA



EUT Description	
Model:	XS-250WX-A/XS-240W-A
SN:	/
Hardware Version:	3FE 46307 AAAA 3FE 46631 AAAA
Software Version:	3FE46346
Power Supply:	AC adapter
Antenna Type:	Internal Antenna*1 External Antenna*2
Antenna Connector:	A permanently attached antenna (meet with the standard FCC Part 15.203 requirement)
Antenna Gain:	Antenna 1: 3.00 dBi Antenna 2: 3.00 dBi Antenna 3: 3.00 dBi
Directional Gain:	3.00 dBi
Test Mode:	802.11b 802.11g 802.11n (HT20/HT40);
Modulation Type:	802.11b: DSSS; 802.11g/n (HT20/HT40): OFDM
Max. Conducted Power	Wi-Fi 2.4G: 25.55 dBm
Operating Frequency Range(s)	2400 ~ 2483.5 MHz
EUT Accessory	
Adapter	Manufacturer: DELTA electronics, INC. Model: ADP-66CR BC
Note: The information of the EUT is declared by the manufacturer. Please refer to the specifications or user manual for details.	



3. Applied Standards

According to the specifications of the manufacturer, it must comply with the requirements of the following standards:

Test standards

- **FCC CFR47 Part 15C (2016) Radio Frequency Devices**
- **ANSI C63.10 (2013)**
- **KDB 558074 D01 DTS Meas Guidance v03r05**
- **KDB 662911 D01 Multiple Transmitter Output v02r01**

4. Test Configuration

Test Mode

The EUT was programmed to be in continuously transmitting mode and the transmit duty cycle is not less than 98%.

The EUT has been associated with peripherals and configuration operated in a manner tended to maximize its emission characteristics in a typical application.

The radiated emission was measured in the following position: EUT stand-up position (Z axis), lie-down position (X, Y axis). The worst emission was found in stand-up position (Z axis) and the worst case was recorded.

In order to find the worst case condition, Pre-tests are needed at the presence of different data rate. Preliminary tests have been done on all the configuration for confirming worst case. Data rate below means worst-case rate of each test item.

Worst-case data rates are shown as following table.

Test Cases	Worst case for 802.11b/ g/ n HT20/ HT40
Maximum Average conducted output power	1Mbps/6Mbps/ MCS24/ MCS24
6 dB bandwidth	1Mbps/6Mbps/ MCS24/ MCS24
Maximum power spectral density	1Mbps/6Mbps/ MCS24/ MCS24
Band Edge	1Mbps/6Mbps/ MCS24/ MCS24
Spurious RF Conducted Emissions	1Mbps/6Mbps/ MCS24/ MCS24
Radiated Emissions in restricted frequency bands	1Mbps/6Mbps/ MCS24/ MCS24
Radiated Emissions	1Mbps/6Mbps/ MCS24/ MCS24
Conducted Emissions	1Mbps/6Mbps/ MCS24/ MCS24

**The worst case Antenna mode for each of the following tests for Wi-Fi:**

Test Cases	Antenna 1	Antenna 2	Antenna 3	MIMO
Maximum Average conducted output power	802.11b/g	802.11g	802.11g	802.11n HT20/40
6 dB bandwidth	802.11b	--	802.11g	802.11n HT20/40
Maximum power spectral density	802.11b/g	802.11g	802.11g	802.11n HT20/40
Band Edge	802.11b	--	802.11g	802.11n HT20/40
Spurious RF Conducted Emissions	802.11b/g	802.11g	802.11g	802.11n HT20/40
Radiated Emissions in restricted frequency bands	802.11b	--	802.11g	802.11n HT20/40
Radiated Emissions	802.11b	--	802.11g	802.11n HT20/40
Conducted Emissions	802.11b	--	802.11g	802.11n HT20/40

5. Test Case Results

5.1. Average Power Output –Conducted

Ambient condition

Temperature	Relative humidity	Pressure
23°C ~25°C	45%~50%	101.5kPa

Methods of Measurement

During the process of the testing, The EUT was connected to Average power meter with a known loss. The EUT is max power transmission with proper modulation. The Average detector is used. We use Maximum Average Conducted Output Power Level Method in KDB 558074 D01/KDB662911 D01 for this test.

The conducted Power is measured at each antenna port. The measured results at the various antenna ports are then summed mathematically.

Test Setup

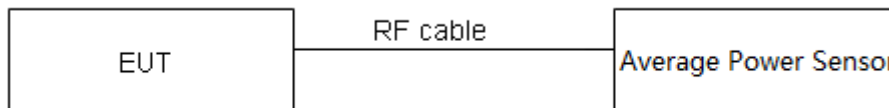

Limits

Rule Part 15.247 (b) (3) specifies that " For systems using digital modulation in the 902–928 MHz, 2400–2483.5 MHz: 1 Watt."

Average Output Power	$\leq 1W$ (30dBm)
----------------------	-------------------

Measurement Uncertainty

The assessed measurement uncertainty to ensure 95% confidence level for the normal distribution is with the coverage factor $k = 2$, $U = 0.44$ dB.

**Test Results**

Note: According to client requirement, testing SISO antenna mode.

SISO Antenna Power Index									
Packet Type	Antenna 1 Power Index			Antenna 2 Power Index			Antenna 3 Power Index		
	CH1	CH6	CH11	CH1	CH6	CH11	CH1	CH6	CH11
802.11b	92	92	92	Not support	Not support	Not support	Not support	Not support	Not support
802.11g	92	92	92	92	92	92	92	92	92

MIMO Antenna 1&2&3 Power Index			
Packet Type	CH1	CH6	CH11
802.11n HT20	74	74	74
Packet Type	CH3	CH6	CH9
802.11n HT40	74	74	74

**SISO Antenna 1**

Network Standards	Carrier frequency (MHz)	Average Output Power (dBm)	Limit (dBm)	Conclusion
802.11b	2412	24.96	30	PASS
	2437	24.85	30	PASS
	2462	25.25	30	PASS
802.11g	2412	24.50	30	PASS
	2437	24.82	30	PASS
	2462	24.94	30	PASS

SISO Antenna 2

Network Standards	Carrier frequency (MHz)	Average Output Power (dBm)	Limit (dBm)	Conclusion
802.11g	2412	24.39	30	PASS
	2437	24.21	30	PASS
	2462	24.61	30	PASS

SISO Antenna 3

Network Standards	Carrier frequency (MHz)	Average Output Power (dBm)	Limit (dBm)	Conclusion
802.11g	2412	25.32	30	PASS
	2437	25.50	30	PASS
	2462	25.55	30	PASS

**MIMO**

Network Standards	Carrier frequency (MHz)	Average Output Power (dBm)				Limit (dBm)	Conclusion
		ANT1	ANT2	ANT3	MIMO		
802.11 n HT20	2412	20.15	19.01	20.14	24.57	30	PASS
	2437	19.96	18.48	20.18	24.37	30	PASS
	2462	19.99	19.02	20.24	24.55	30	PASS
802.11 n HT40	2422	19.84	18.63	19.96	24.29	30	PASS
	2437	20.18	18.73	20.13	24.50	30	PASS
	2452	20.09	18.65	19.89	24.36	30	PASS

5.2. 6dB Bandwidth

Ambient condition

Temperature	Relative humidity	Pressure
23°C ~25°C	45%~50%	101.5kPa

Method of Measurement

The EUT was connected to the spectrum analyzer through an external attenuator (20dB) and a known loss cable. RBW is set to 100 kHz; VBW is set to 300 kHz on spectrum analyzer.

Test Setup

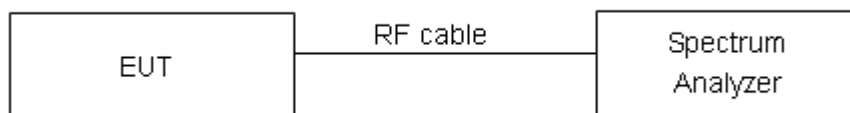

Limits

Rule Part 15.247 (a) (2) specifies that “Systems using digital modulation techniques may operate in the 902–928 MHz, 2400–2483.5 MHz bands. The minimum 6 dB bandwidth shall be at least 500 kHz.”

minimum 6 dB bandwidth	≥ 500 kHz
------------------------	-----------

Measurement Uncertainty

The assessed measurement uncertainty to ensure 95% confidence level for the normal distribution is with the coverage factor $k = 2$, $U = 936$ Hz.

**Test Results:****SISO Antenna 1**

Network Standards	Carrier frequency (MHz)	Minimum 6 dB bandwidth (MHz)	99% bandwidth (MHz)	Limit (kHz)	Conclusion
802.11b	2412	8.619	11.486	500	PASS
	2437	9.081	11.833	500	PASS
	2462	9.077	11.911	500	PASS

SISO Antenna 3

Network Standards	Carrier frequency (MHz)	Minimum 6 dB bandwidth (MHz)	99% bandwidth (MHz)	Limit (kHz)	Conclusion
802.11g	2412	16.070	16.890	500	PASS
	2437	16.100	16.711	500	PASS
	2462	16.330	16.632	500	PASS

**MIMO Antenna 3**

Network Standards	Carrier frequency (MHz)	Minimum 6 dB bandwidth (MHz)	99% bandwidth (MHz)	Limit (kHz)	Conclusion
802.11n HT20	2412	16.980	17.672	500	PASS
	2437	17.600	17.648	500	PASS
	2462	17.610	17.637	500	PASS
802.11n HT40	2422	35.780	35.993	500	PASS
	2437	36.310	36.124	500	PASS
	2452	36.420	36.194	500	PASS



SISO Antenna 1

802.11b, Carrier frequency (MHz): 2412



SISO Antenna 3

802.11g, Carrier frequency (MHz): 2412

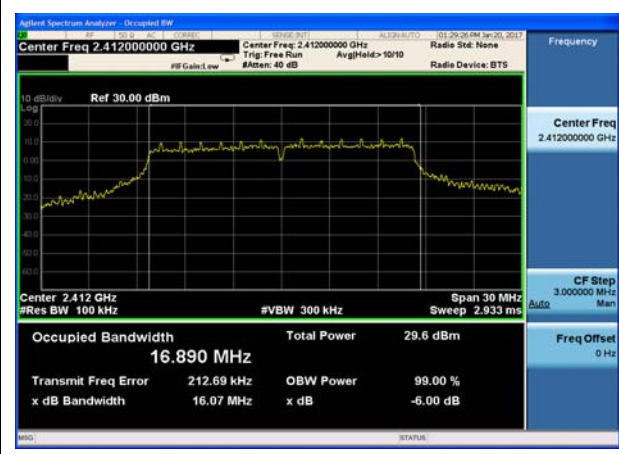

802.11b, Carrier frequency (MHz): 2437

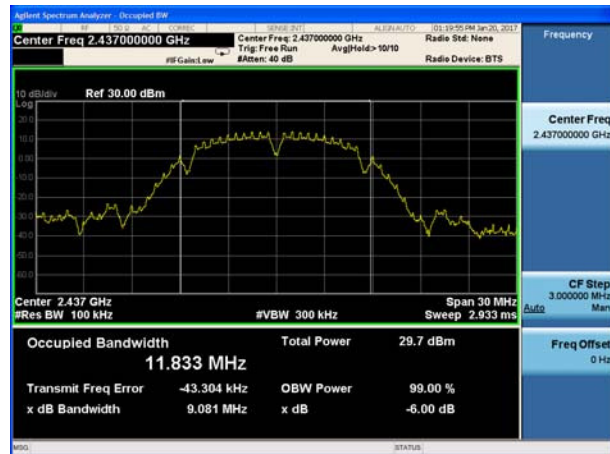

802.11g, Carrier frequency (MHz): 2437

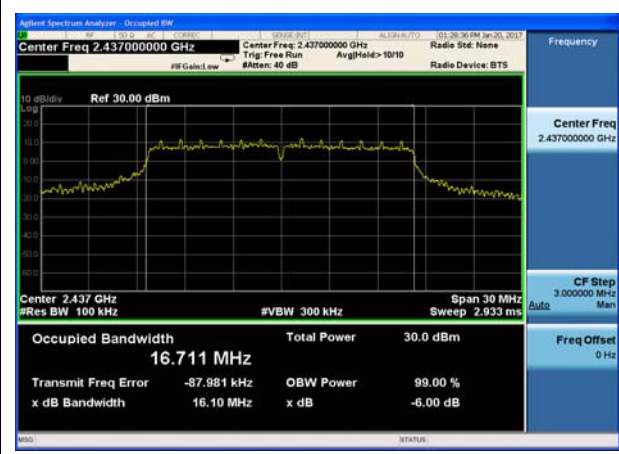

802.11b, Carrier frequency (MHz):2462

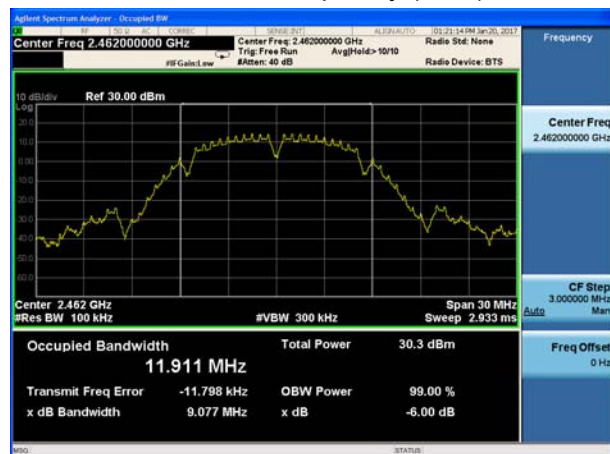

802.11g, Carrier frequency (MHz):2462

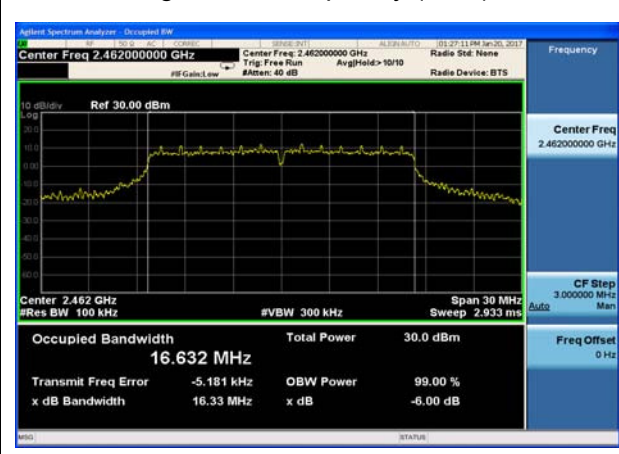

5.3. Band Edge

Ambient condition

Temperature	Relative humidity	Pressure
23°C ~25°C	45%~50%	101.5kPa

Method of Measurement

The EUT was connected to the spectrum analyzer through an external attenuator (20dB) and a known loss cable the band edge of the lowest and highest channels were measured. The peak detector is used and RBW is set to 100 kHz and VBW is set to 300 kHz on spectrum analyzer. Spectrum analyzer plots are included on the following pages.

Test Setup

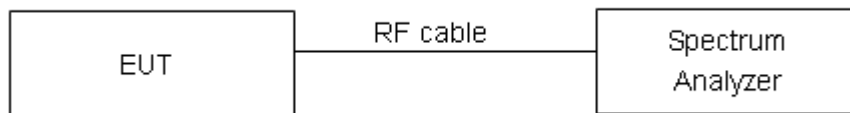

Limits

Rule Part 15.247(d) specifies that “In any 100 kHz bandwidth outside the frequency band in which the spread spectrum or digitally modulated intentional radiator is operating, the radio frequency power that is produced by the intentional radiator shall be at least 20 dB below that in the 100 kHz bandwidth within the band that contains the highest level of the desired power, based on either an RF conducted or a radiated measurement, provided the transmitter demonstrates compliance with the peak conducted power limits.”

Measurement Uncertainty

The assessed measurement uncertainty to ensure 95% confidence level for the normal distribution is with the coverage factor $k = 1.96$.

Frequency	Uncertainty
2GHz-3GHz	1.407 dB



Test Results: PASS

SISO Antenna 1

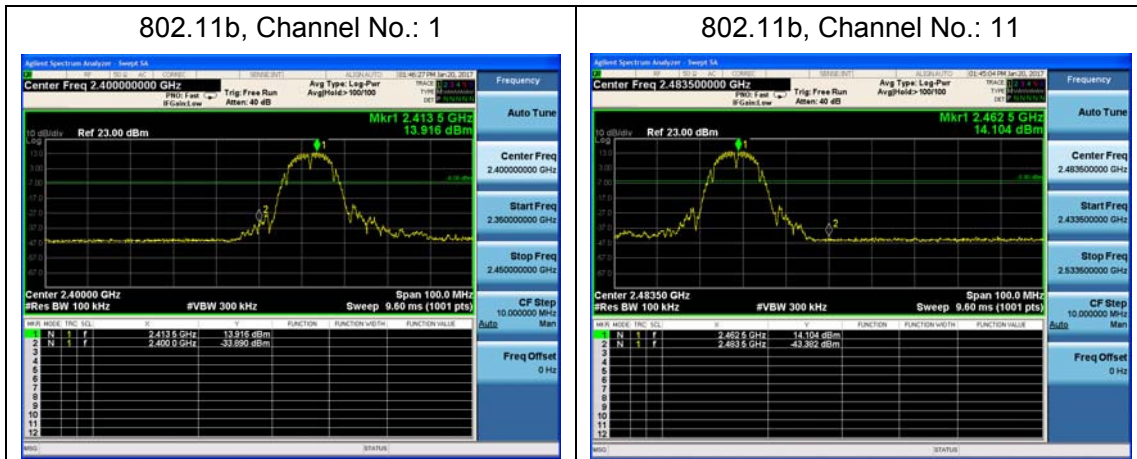

SISO Antenna3

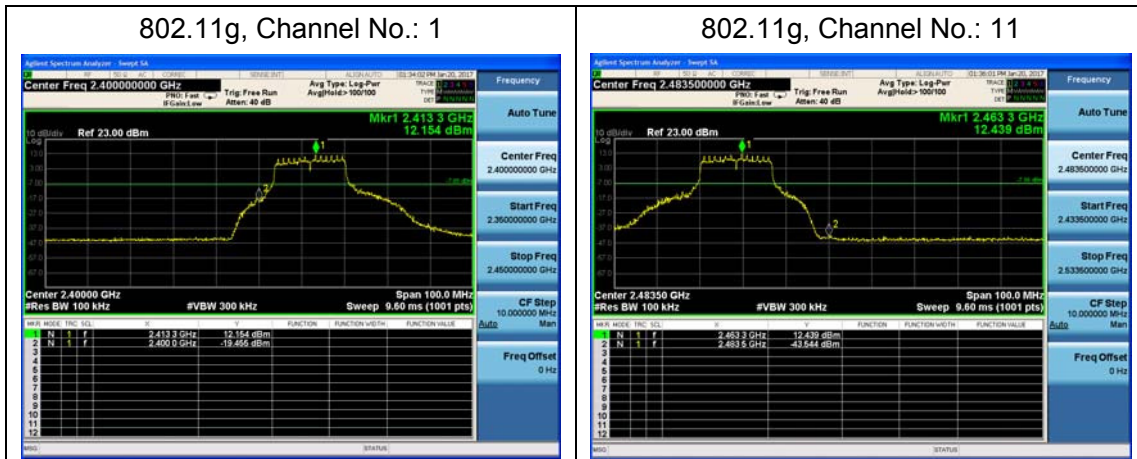



MIMO Antenna 3

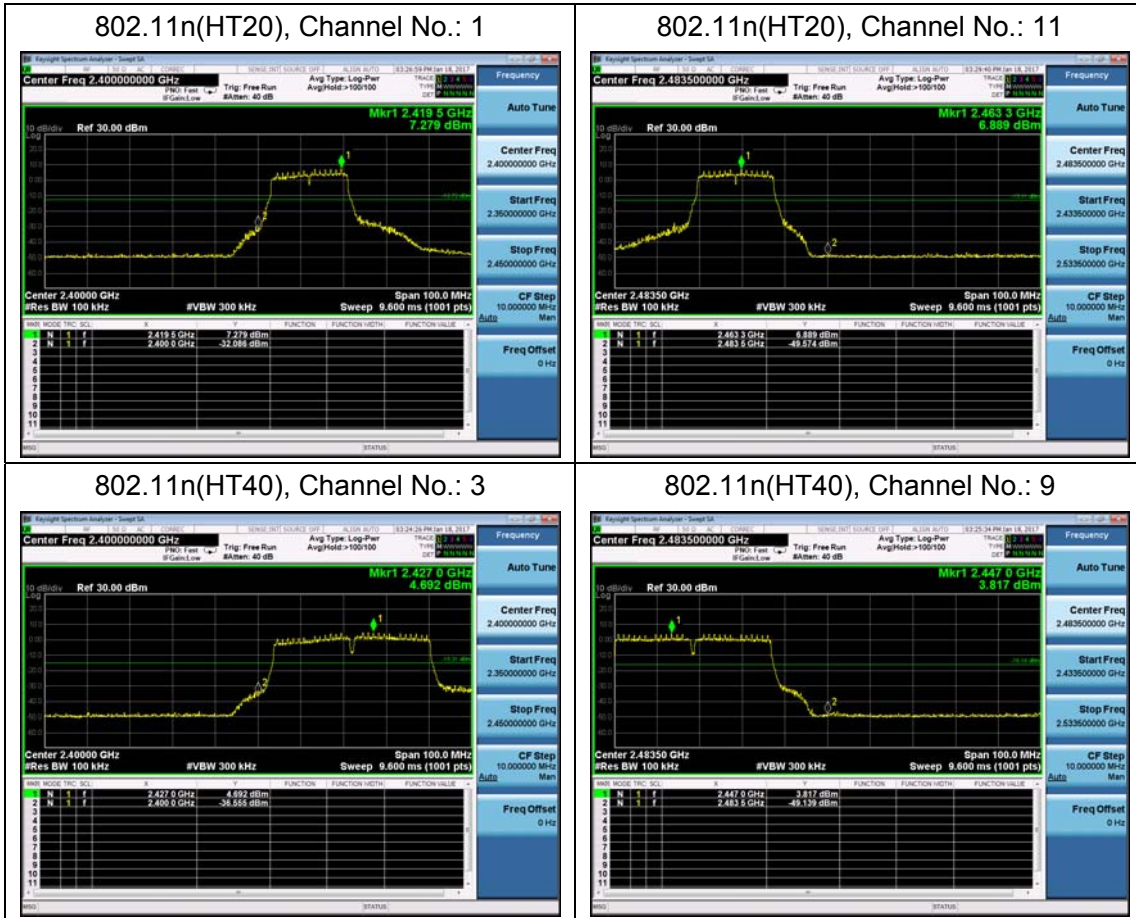

5.4. Power Spectral Density

Ambient condition

Temperature	Relative humidity	Pressure
23°C ~25°C	45%~50%	101.5kPa

Method of Measurement

The EUT was connected to the spectrum analyzer through an external attenuator (20dB) and a known loss cable.

RBW is set to 3 kHz and VBW is set to 10 kHz for BLE/ Wi-Fi 2.4G on spectrum analyzer.

Set the span to 1.5 times the DTS channel bandwidth. Sweep time = auto couple. Trace mode = max hold. The Average power spectral density is recorded.

The conducted Power is measured at each antenna port. The measured results at the various antenna ports are then summed mathematically.

Test setup

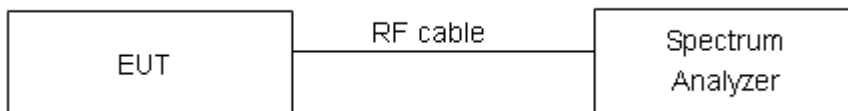

Limits

Rule Part 15.247(e) specifies that” For digitally modulated systems, the power spectral density conducted from the intentional radiator to the antenna shall not be greater than 8 dBm in any 3 kHz band during any time interval of continuous transmission. ”

Limits	≤ 8 dBm / 3kHz
--------	----------------

Measurement Uncertainty

The assessed measurement uncertainty to ensure 95% confidence level for the normal distribution is with the coverage factor $k = 2$, $U = 0.75\text{dB}$.

**Test Results:**

Note: According to client requirement, testing SISO antenna mode.

SISO Antenna 1

Network Standards	Channel Number	Power Spectral Density (dBm / 3kHz)	Limit (dBm / 3kHz)	Conclusion
802.11b	1	-10.527	8	PASS
	6	-10.758	8	PASS
	11	-10.437	8	PASS
802.11g	1	-12.249	8	PASS
	6	-12.636	8	PASS
	11	-12.195	8	PASS

SISO Antenna 2

Network Standards	Channel Number	Power Spectral Density (dBm / 3kHz)	Limit (dBm / 3kHz)	Conclusion
802.11g	1	-12.870	8	PASS
	6	-13.400	8	PASS
	11	-12.656	8	PASS

SISO Antenna 3

Network Standards	Channel Number	Power Spectral Density (dBm / 3kHz)	Limit (dBm / 3kHz)	Conclusion
802.11g	1	-11.307	8	PASS
	6	-14.559	8	PASS
	11	-11.596	8	PASS

**MIMO**

Network Standards	Channel Number	Power Spectral Density (dBm / 3kHz)				Limit (dBm / 3kHz)	Conclusion
		ANT1	ANT2	ANT3	MIMO		
802.11n HT20	1	-18.566	-18.085	-17.089	-13.100	8	PASS
	6	-17.657	-18.309	-16.996	-12.850	8	PASS
	11	-19.959	-18.953	-16.795	-13.590	8	PASS
802.11n HT40	3	-19.906	-20.575	-19.674	-15.260	8	PASS
	6	-20.787	-20.676	-20.491	-15.880	8	PASS
	9	-20.615	-21.431	-19.808	-15.800	8	PASS



SISO Antenna 1

802.11b, Channel No.: 1



802.11g, Channel No.: 1

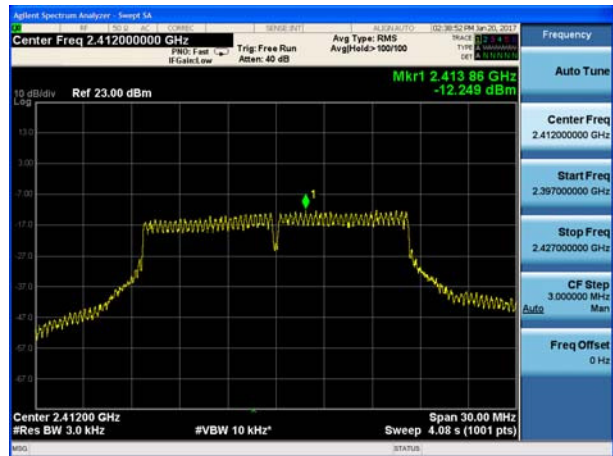

802.11b, Channel No.: 6



802.11g, Channel No.: 6

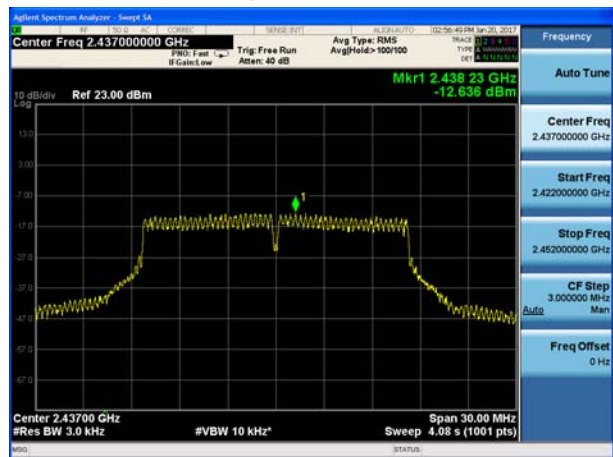

802.11b, Channel No.: 11

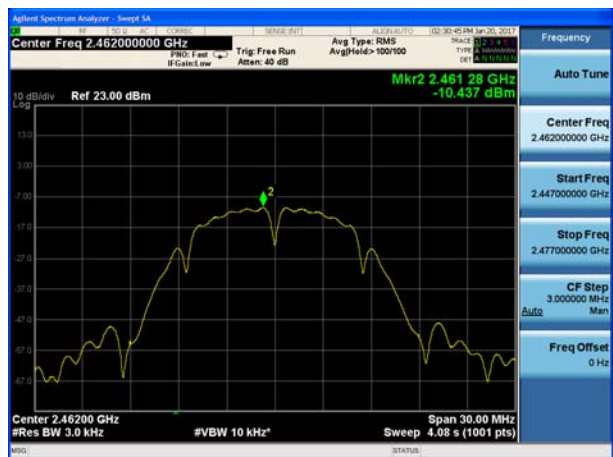

802.11g, Channel No.: 11

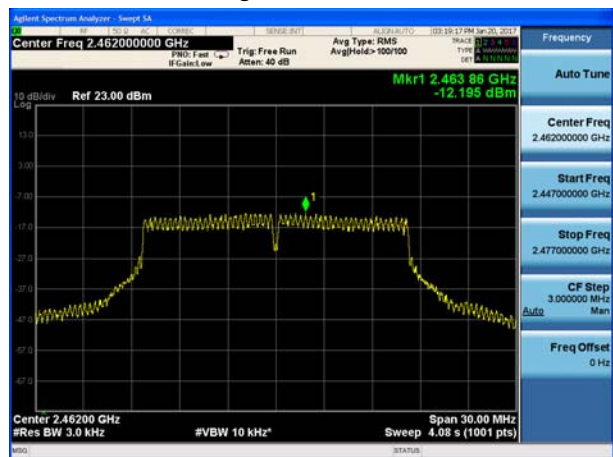



SISO Antenna 2

802.11g, Channel No.: 1

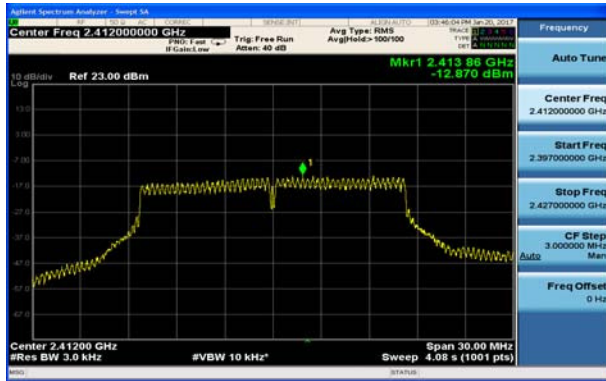

SISO Antenna 3

802.11g, Channel No.: 1



802.11g, Channel No.: 6

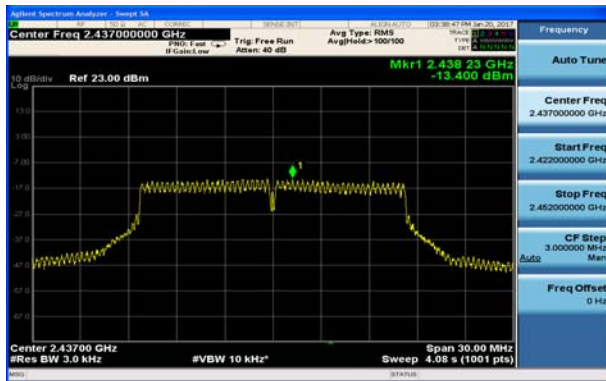

802.11g, Channel No.: 6

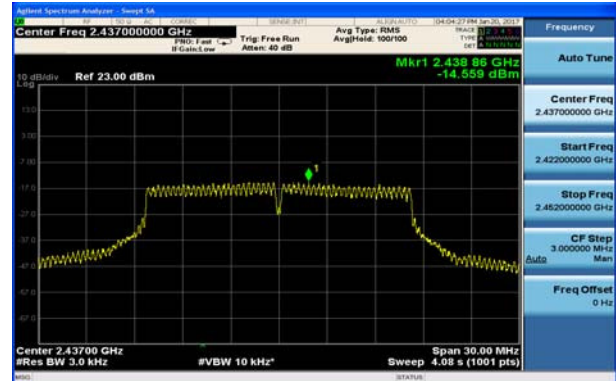

802.11g, Channel No.: 11

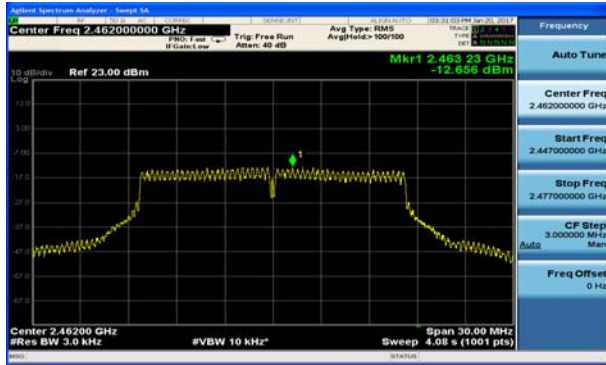

802.11g, Channel No.: 11





MIMO Antenna 1

802.11n(HT20), Channel No. 1

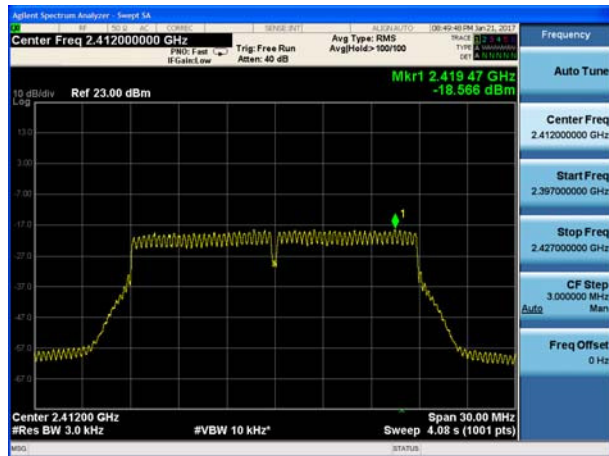

802.11n(HT40), Channel No. 3

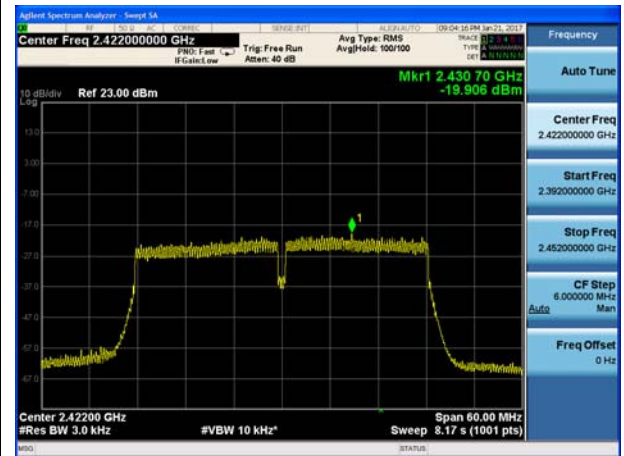

802.11n(HT20), Channel No. 6

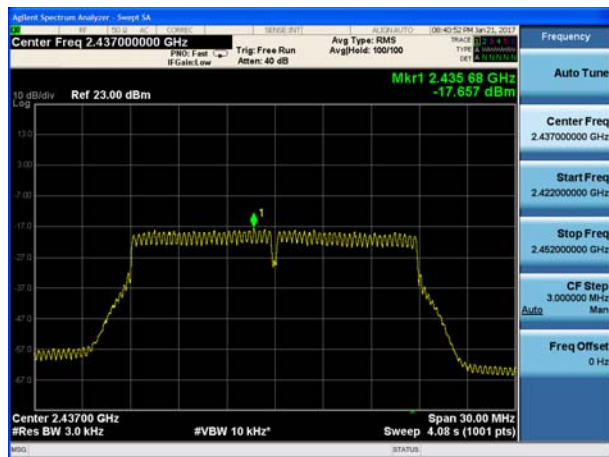

802.11n(HT40), Channel No. 6

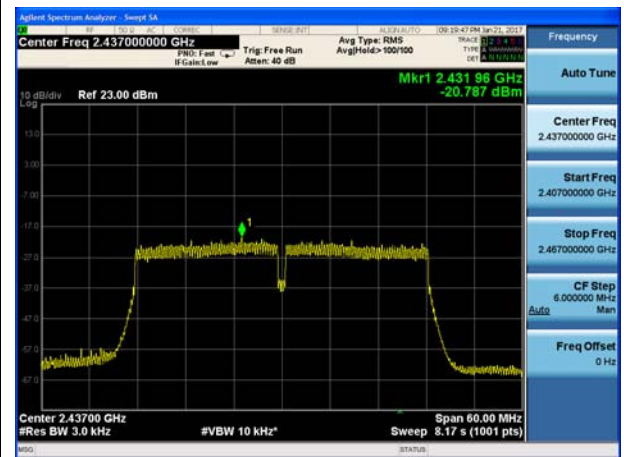

802.11n(HT20), Channel No. 11

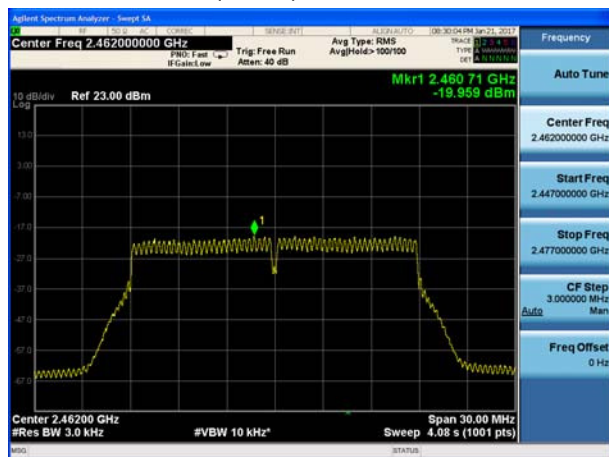

802.11n(HT40), Channel No. 9

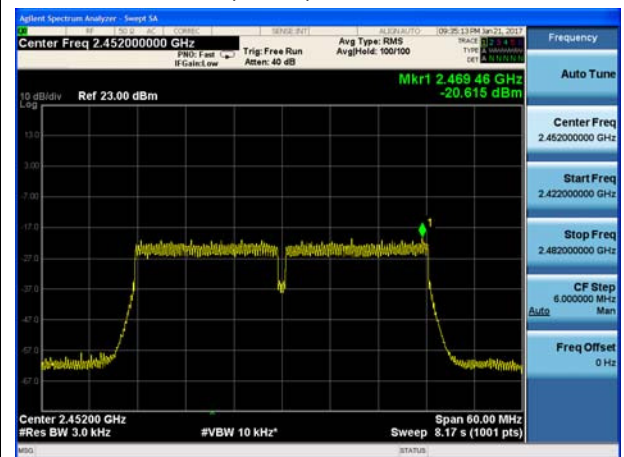



MIMO Antenna 2

802.11n(HT20), Channel No. 1

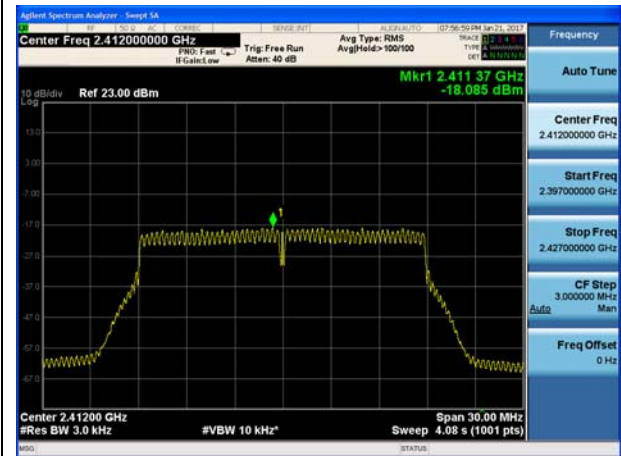

802.11n(HT40), Channel No. 3

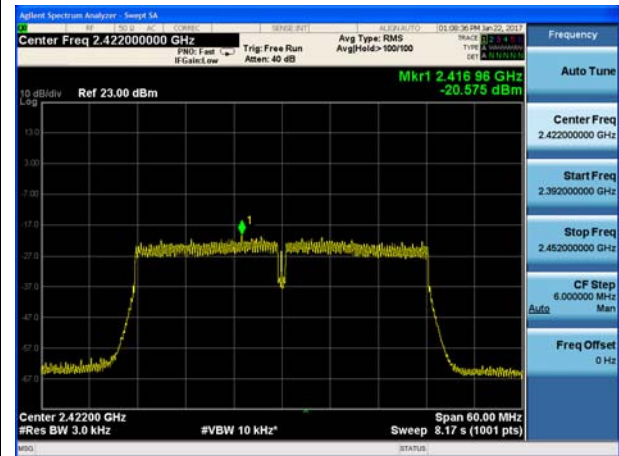

802.11n(HT20), Channel No. 6

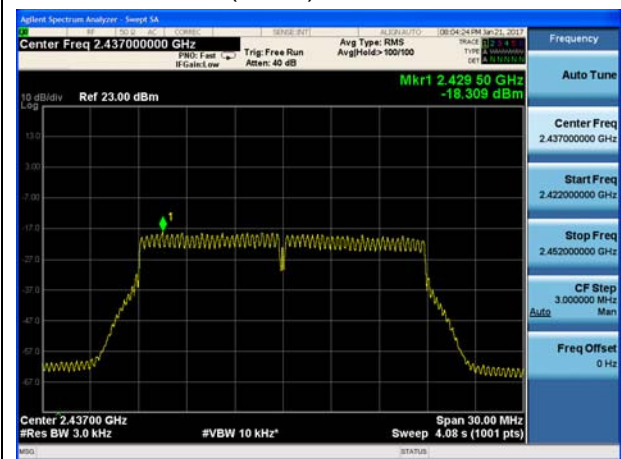

802.11n(HT40), Channel No. 6

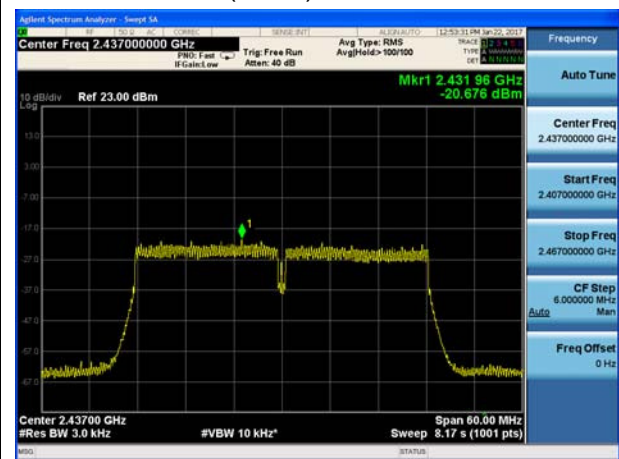

802.11n(HT20), Channel No. 11

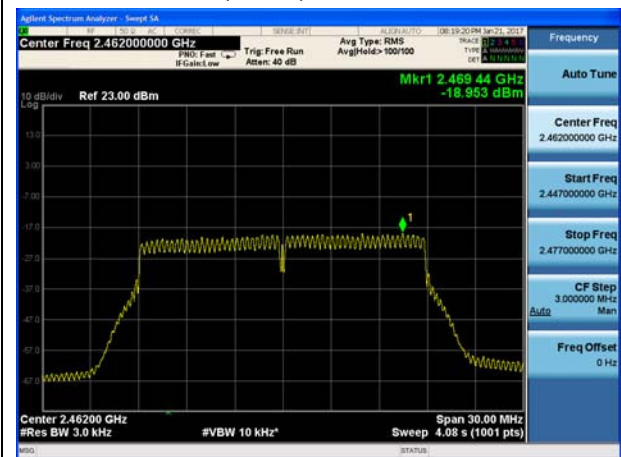

802.11n(HT40), Channel No. 9

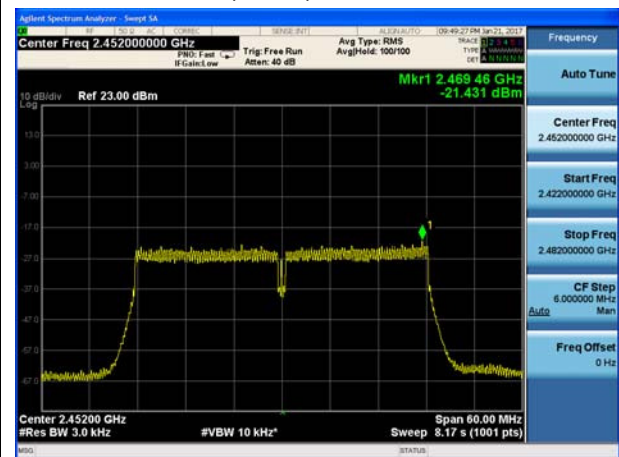



MIMO Antenna 3

802.11n(HT20), Channel No. 1

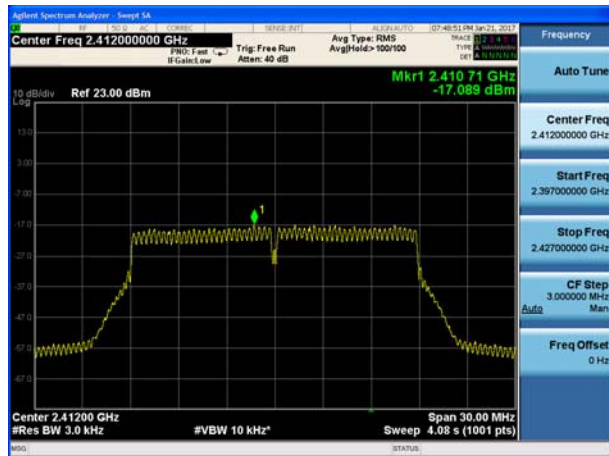

802.11n(HT40), Channel No. 3

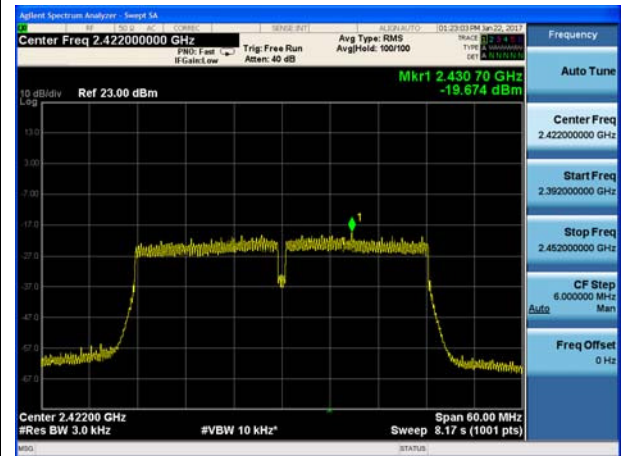

802.11n(HT20), Channel No. 6

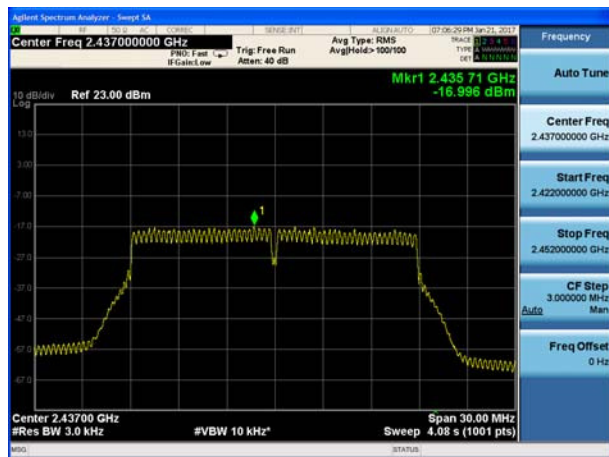

802.11n(HT40), Channel No. 6

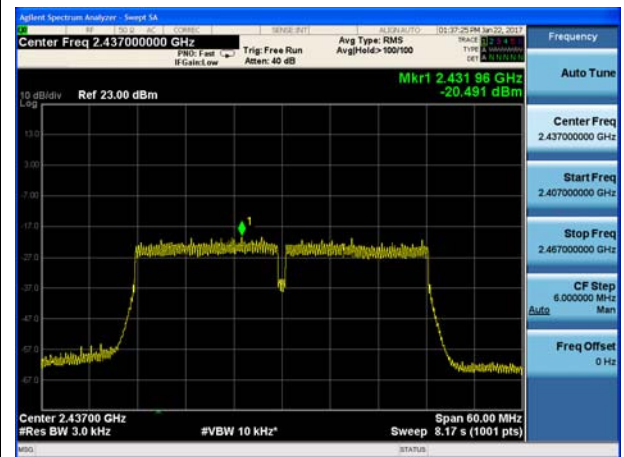

802.11n(HT20), Channel No. 11

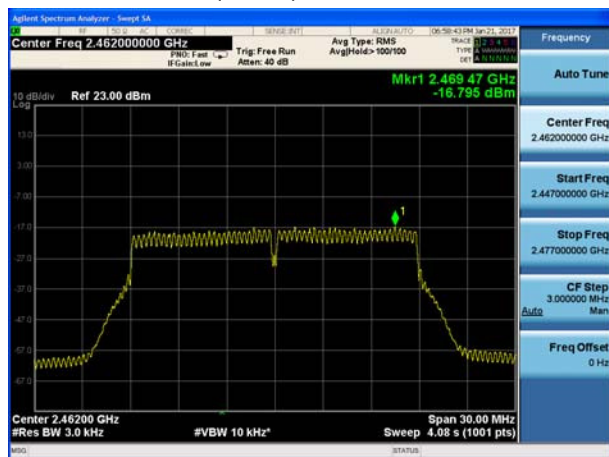

802.11n(HT40), Channel No. 9

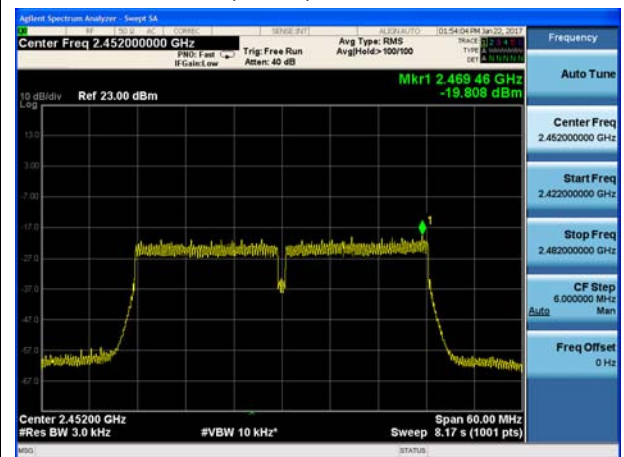

5.5. Spurious RF Conducted Emissions

Ambient condition

Temperature	Relative humidity	Pressure
23°C ~25°C	45%~50%	101.5kPa

Method of Measurement

The EUT was connected to the spectrum analyzer with a known loss. The spectrum analyzer scans from 30MHz to the 10th harmonic of the carrier. The peak detector is used. RBW and VBW are set to 100 kHz, Sweep is set to ATUO.

The test is in transmitting mode.

Test setup



Limits

Rule Part 15.247(d) pacifies that “In any 100 kHz bandwidth outside the frequency band in which the spread spectrum intentional radiator is operating, the radio frequency power that is produced by the intentional radiator shall be at least 20 dB below that in the 100 kHz bandwidth within the band that contains the highest level of the desired power.”

SISO Antenna 1

Network Standards	Carrier frequency (MHz)	Reference value (dBm)	Limit
802.11b	2412	-6.785	-26.785
	2437	-5.255	-25.255
	2462	-7.620	-27.62
802.11g	2412	-5.562	-25.562
	2437	-8.855	-28.855
	2462	-9.393	-29.393

SISO Antenna 2

Network Standards	Carrier frequency (MHz)	Reference value (dBm)	Limit
802.11g	2412	-16.416	-36.416
	2437	-13.514	-33.514
	2462	-17.495	-37.495

SISO Antenna 3

Network Standards	Carrier frequency (MHz)	Reference value (dBm)	Limit
802.11g	2412	-16.751	-36.751
	2437	-16.183	-36.183
	2462	-19.204	-39.204

MIMO

Network Standards	Carrier frequency (MHz)	Reference value (dBm)	Limit
802.11n HT20	2412	4.465	-15.535
	2437	2.951	-17.049
	2462	2.546	-17.454
802.11n HT40	2422	0.955	-19.045
	2437	0.984	-19.016
	2452	1.508	-18.492

Measurement Uncertainty

The assessed measurement uncertainty to ensure 95% confidence level for the normal distribution is with the coverage factor $k = 1.96$.

Frequency	Uncertainty
100kHz-2GHz	0.684 dB
2GHz-26GHz	1.407 dB



Test Results:

If disturbances were found more than 20dB below limit line, the mark is not required for the EUT.
The signal beyond the limit is carrier.

The signal beyond the limit is carrier

SISO Antenna 1

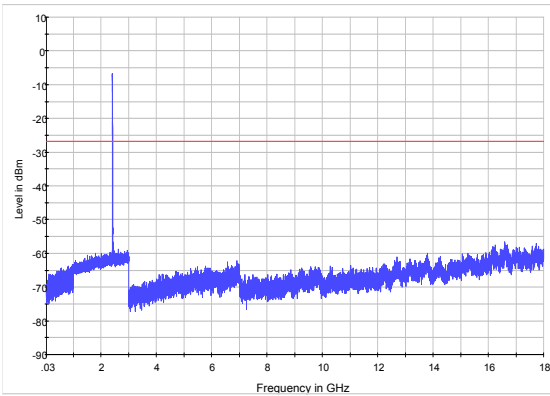

802.11b CH1 30MHz to 18GHz

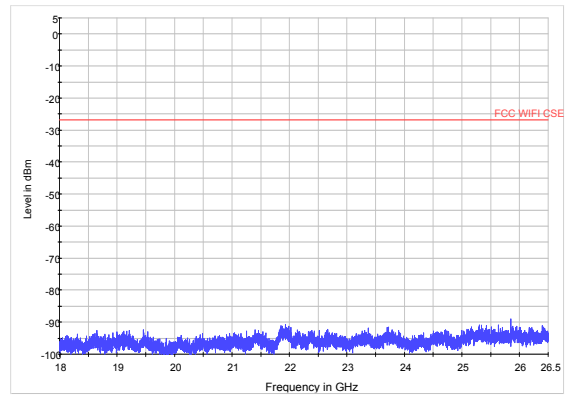

802.11b CH1 18GHz to 26.5GHz

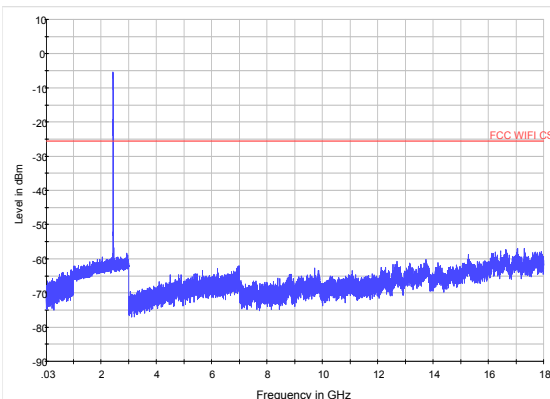

802.11b CH6 30MHz to 18GHz

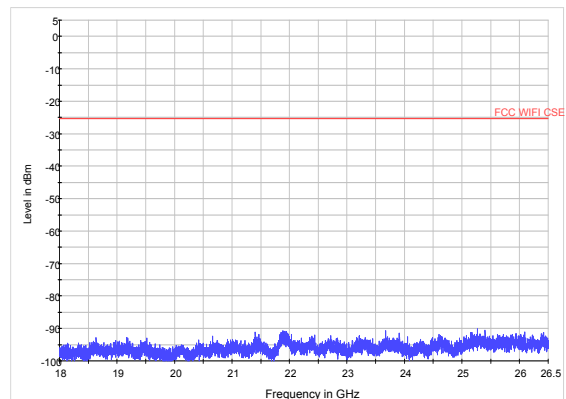

802.11b CH6 18GHz to 26.5GHz

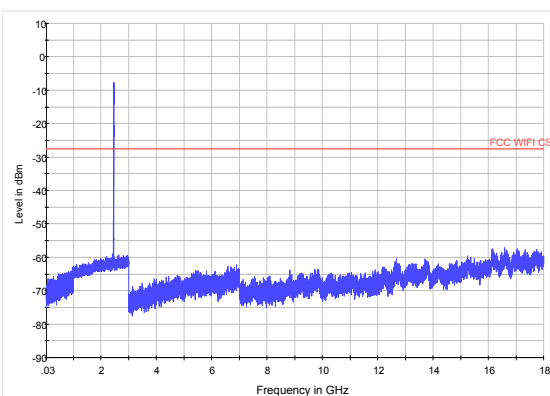

802.11b CH11 30MHz to 18GHz

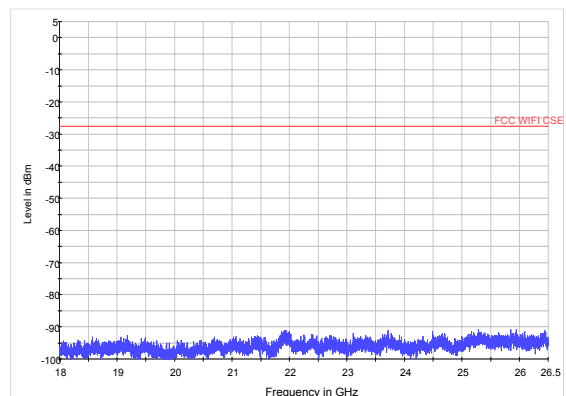

802.11b CH11 18GHz to 26.5GHz

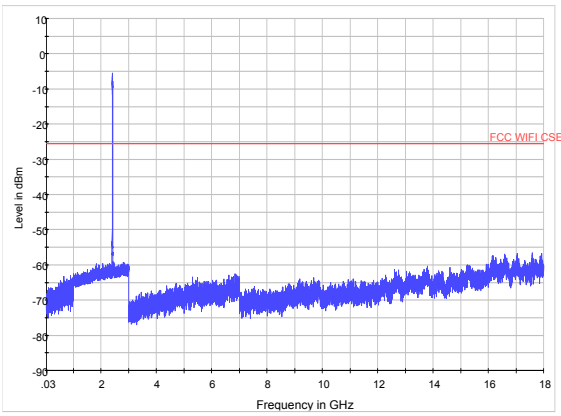

802.11g CH1 30MHz to 18GHz

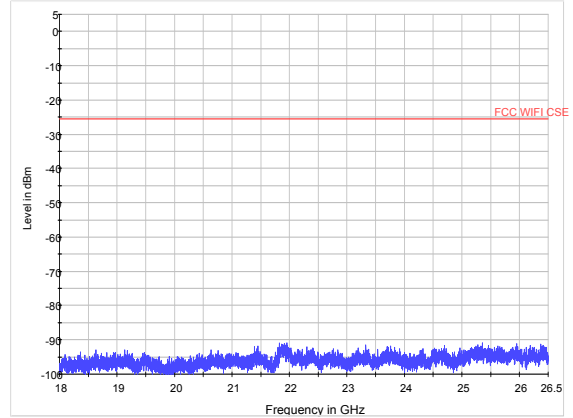

802.11g CH1 18GHz to 26.5GHz

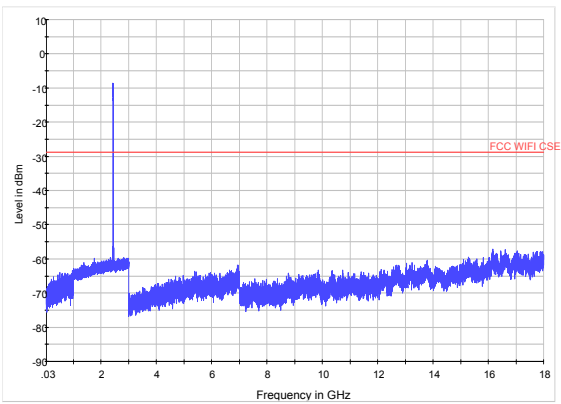

802.11g CH6 30MHz to 18GHz

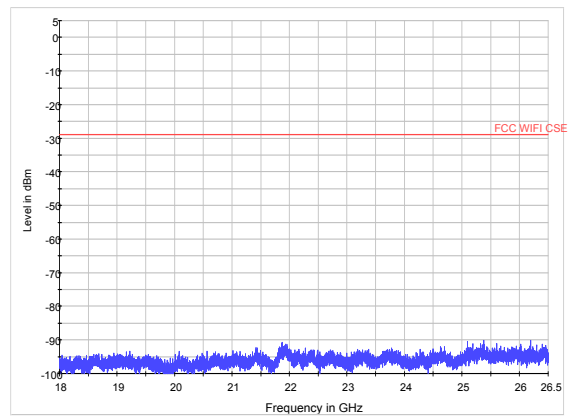

802.11g CH6 18GHz to 26.5GHz

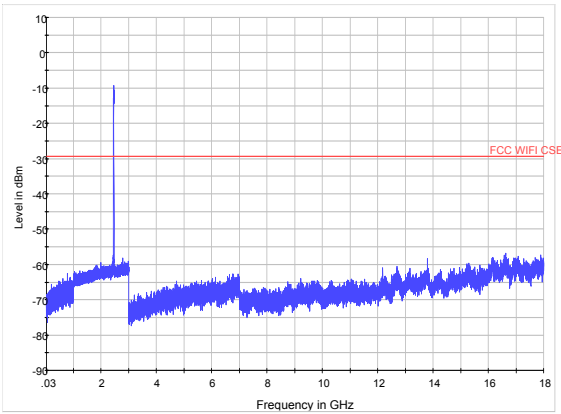

802.11g CH11 30MHz to 18GHz

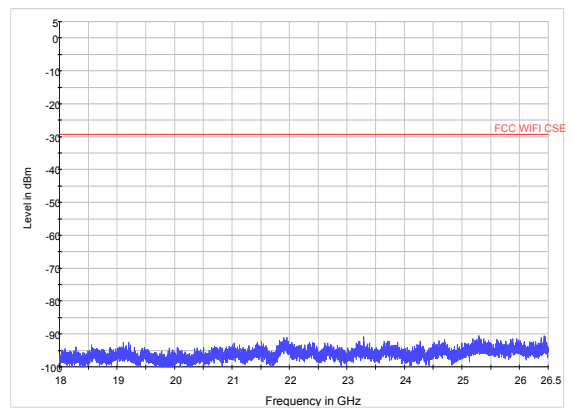

802.11g CH11 18GHz to 26.5GHz



SISO Antenna 2

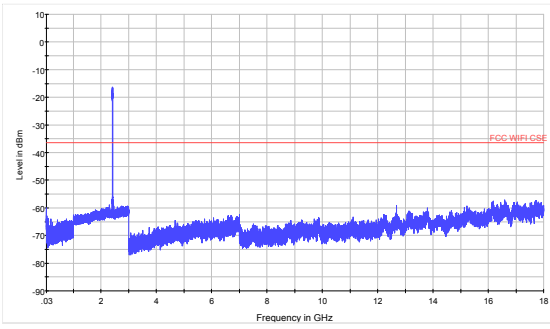

802.11g CH1 30MHz to 18GHz

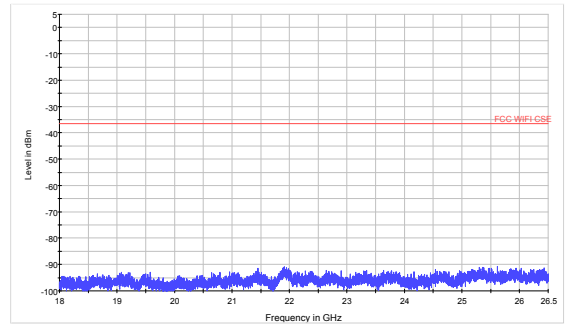

802.11g CH1 18GHz to 26.5GHz

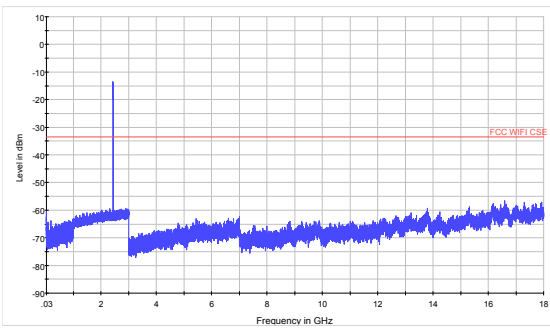

802.11g CH6 30MHz to 18GHz

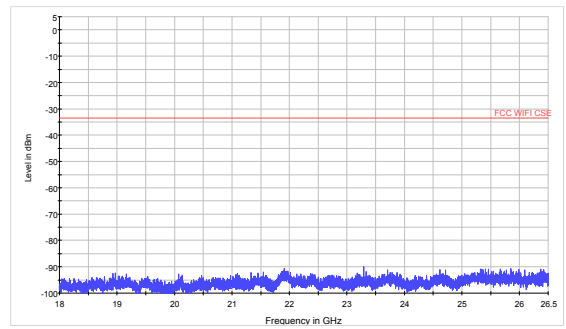

802.11g CH6 18GHz to 26.5GHz

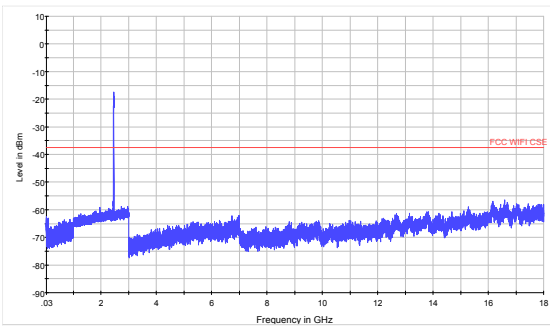

802.11g CH11 30MHz to 18GHz

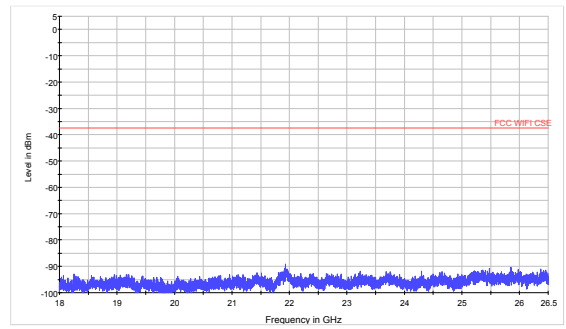

802.11g CH11 18GHz to 26.5GHz



SISO Antenna 3

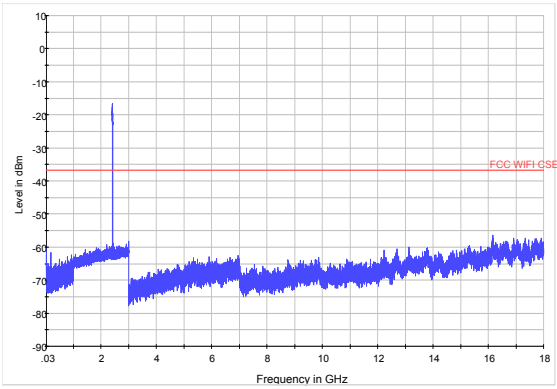

802.11g CH1 30MHz to 18GHz

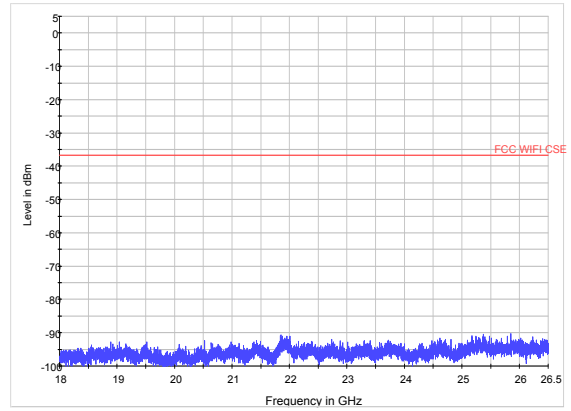

802.11g CH1 18GHz to 26.5GHz

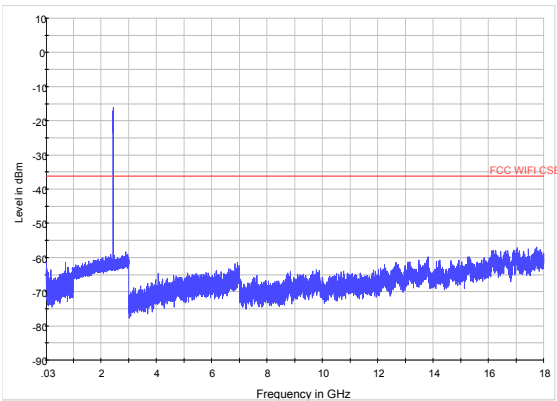

802.11g CH6 30MHz to 18GHz

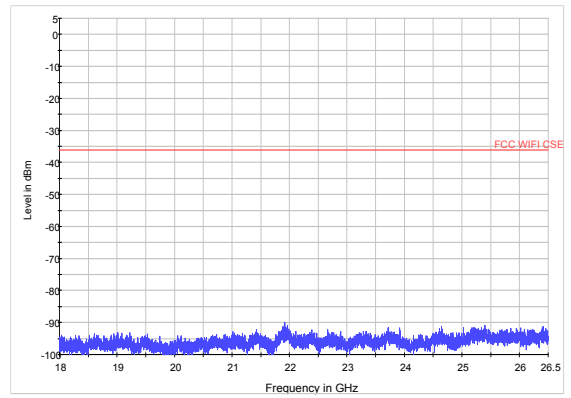

802.11g CH6 18GHz to 26.5GHz

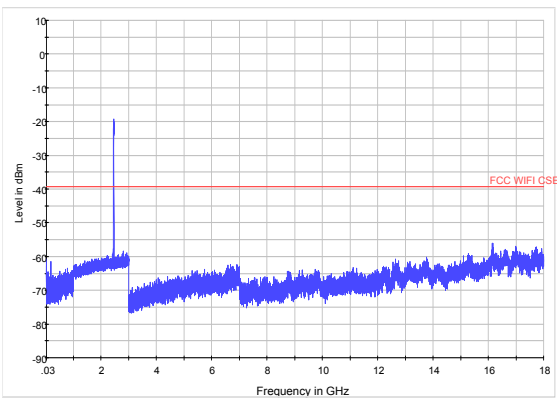

802.11g CH11 30MHz to 18GHz

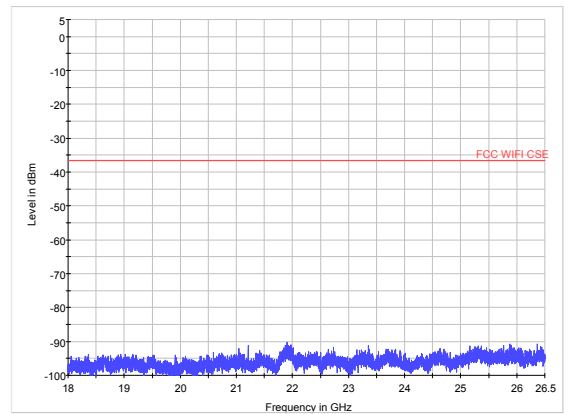

802.11g CH11 18GHz to 26.5GHz



MIMO

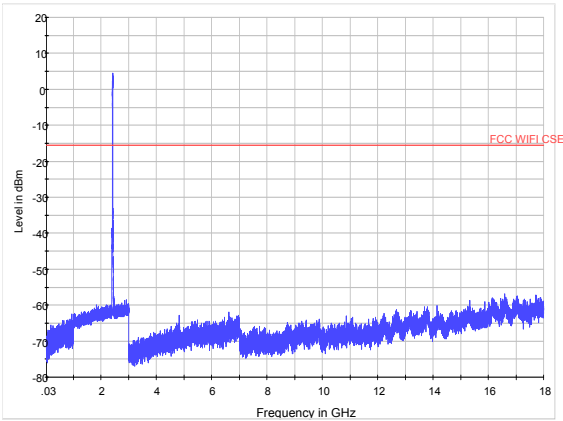

802.11n (HT20) CH1 30MHz to 18GHz

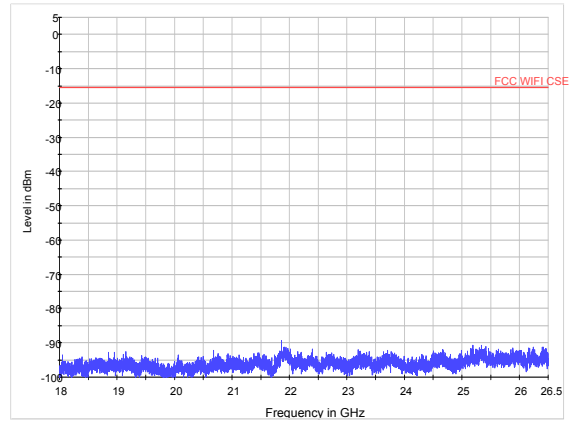

802.11n (HT20) CH1 18GHz to 26.5GHz

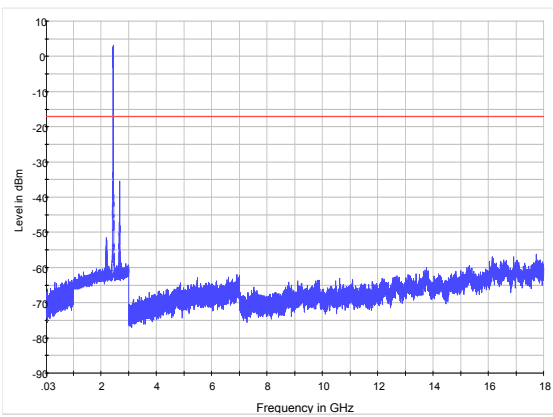

802.11n (HT20) CH6 30MHz to 18GHz

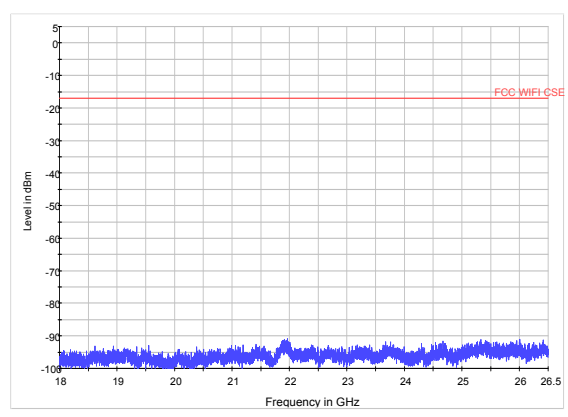

802.11n (HT20) CH6 18GHz to 26.5GHz

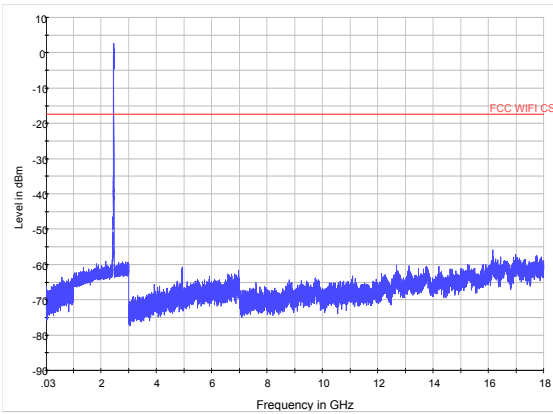

802.11n (HT20) CH11 30MHz to 18GHz

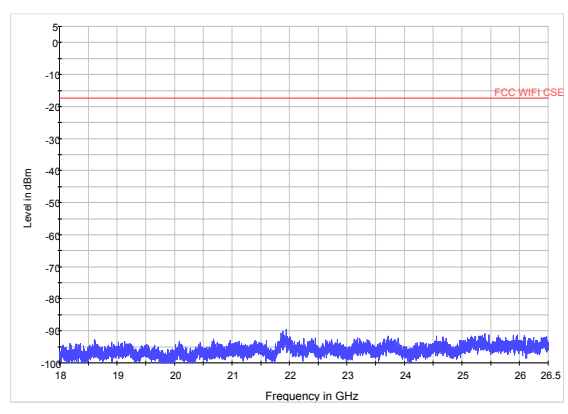

802.11n (HT20) CH11 18GHz to 26.5GHz

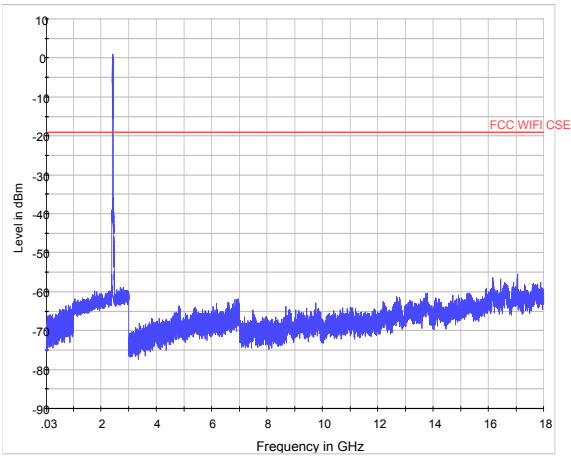

802.11n (HT40) CH3 30MHz to 18GHz

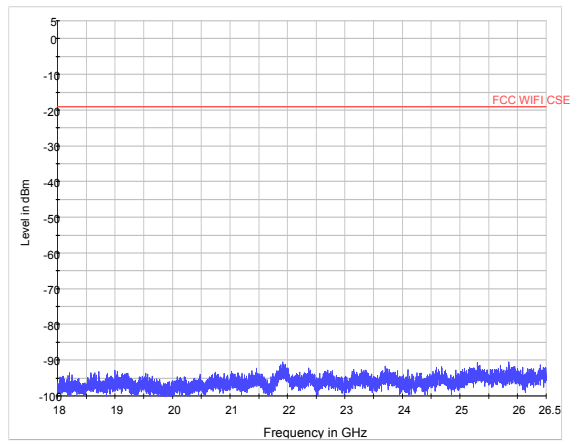

802.11n (HT40) CH3 18GHz to 26.5GHz

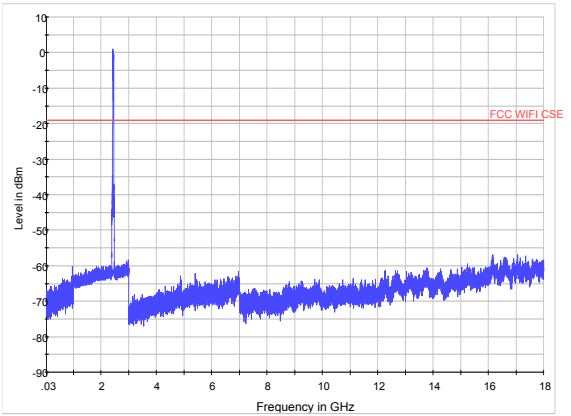

802.11n (HT40) CH6 30MHz to 18GHz

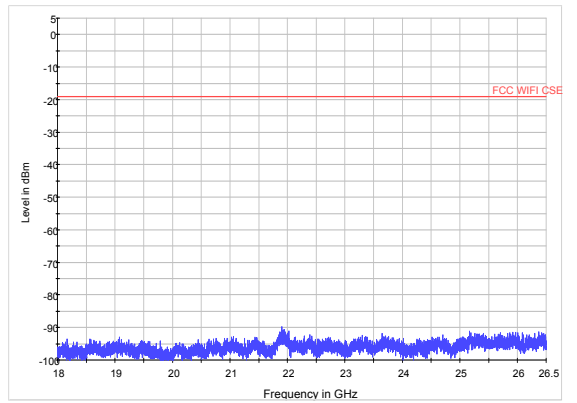

802.11n (HT40) CH6 18GHz to 26.5GHz

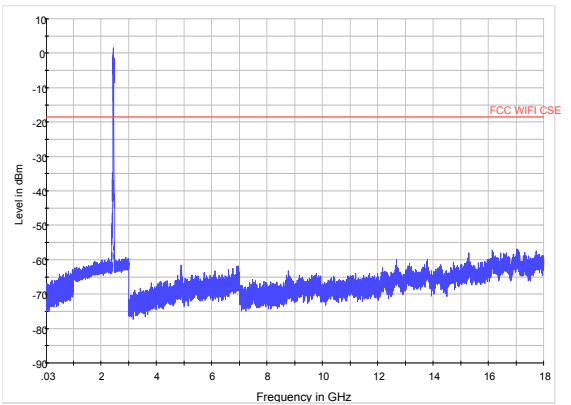

802.11n (HT40) CH9 30MHz to 18GHz

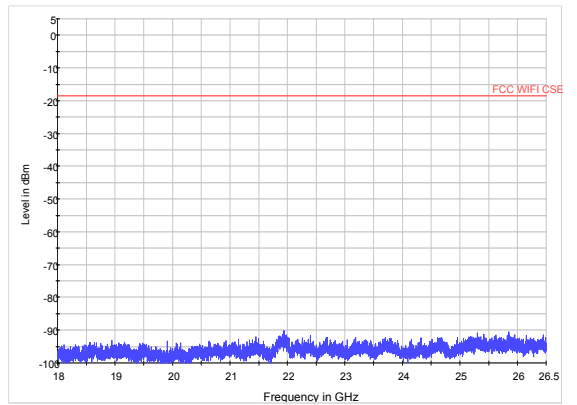

802.11n (HT40) CH9 18GHz to 26.5GHz

5.6. Radiated Emissions in the Restricted Band

Ambient condition

Temperature	Relative humidity	Pressure
23°C ~25°C	45%~50%	101.5kPa

Method of Measurement

The Equipment Under Test (EUT) was set up on a non-conductive table in the semi-anechoic chamber. The test was performed at the distance of 3 m between the EUT and the receiving antenna. The turntable shall be rotated from 0 to 360 degrees for detecting the maximum of radiated spurious signal level. The measurements shall be repeated with orthogonal polarization of the test antenna. RBW is set to 100kHz. The data of cable loss and antenna factor has been calibrated in full testing frequency range before the testing. Sweep the whole frequency band through the range from 9kHz to the 10th harmonic of the carrier, and the emissions less than 20 dB below the permissible value are reported.

Set the spectrum analyzer in the following:

- (a) PEAK: RBW=VBW=1MHz / Sweep=AUTO
- (b) AVERAGE: RBW=1MHz / VBW=1MHz / Sweep=AUTO

This setting method can refer to **KDB 558074**.

The field strength of spurious emission was measured in the following position: EUT stand-up position (Z axis), lie-down position (X, Y axis). The worst emission was found in stand-up position (Y axis) and the antenna is vertical.

The test is in transmitting mode.

Test setup

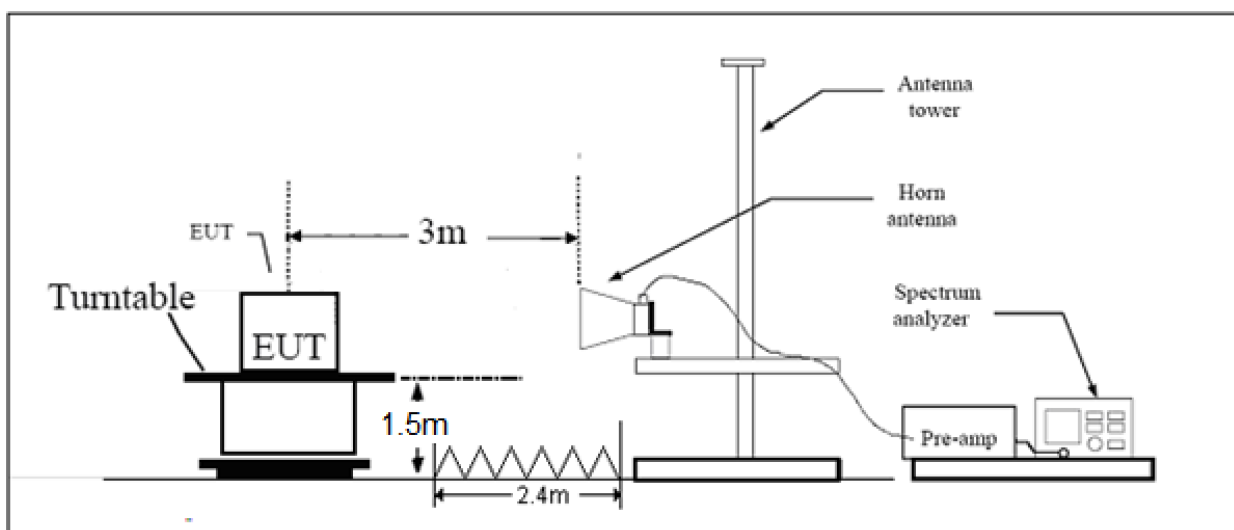

Note: Area side: 2.4mX3.6m

Limits

Spurious Radiated Emissions are permitted in any of the frequency bands listed below:

MHz	MHz	MHz	GHz
0.090 - 0.110	16.42 - 16.423	399.9 - 410	4.5 - 5.15
¹ 0.495 - 0.505	16.69475 - 16.69525	608 - 614	5.35 - 5.46
2.1735 - 2.1905	16.80425 - 16.80475	960 - 1240	7.25 - 7.75
4.125 - 4.128	25.5 - 25.67	1300 - 1427	8.025 - 8.5
4.17725 - 4.17775	37.5 - 38.25	1435 - 1626.5	9.0 - 9.2
4.20725 - 4.20775	73 - 74.6	1645.5 - 1646.5	9.3 - 9.5
6.215 - 6.218	74.8 - 75.2	1660 - 1710	10.6 - 12.7
6.26775 - 6.26825	108 - 121.94	1718.8 - 1722.2	13.25 - 13.4
6.31175 - 6.31225	123 - 138	2200 - 2300	14.47 - 14.5
8.291 - 8.294	149.9 - 150.05	2310 - 2390	15.35 - 16.2
8.362 - 8.366	156.52475 - 156.52525	2483.5 - 2500	17.7 - 21.4
8.37625 - 8.38675	156.7 - 156.9	2690 - 2900	22.01 - 23.12
8.41425 - 8.41475	162.0125 - 167.17	3260 - 3267	23.6 - 24.0
12.29 - 12.293	167.72 - 173.2	3332 - 3339	31.2 - 31.8
12.51975 - 12.52025	240 - 285	3345.8 - 3358	36.43 - 36.5
12.57675 - 12.57725	322 - 335.4	3600 - 4400	(²)
13.36 - 13.41			

Limit in restricted band

Frequency of emission (MHz)	Field strength(uV/m)	Field strength(dBuV/m)
30-88	100	40
88-216	150	43.5
216-960	200	46
Above960	500	54

§15.35(b)

There is also a limit on the radio frequency emissions, as measured using instrumentation with a peak detector function, corresponding to 20 dB above the maximum permitted average limit.

Peak Limit=74 dBuV/m

Average Limit=54 dBuV/m

Measurement Uncertainty

The assessed measurement uncertainty to ensure 95% confidence level for the normal distribution is with the coverage factor $k = 1.96$, $U = 3.55$ dB.



Test Results:

PASS

The signal beyond the limit is carrier.

SISO Antenna 1

802.11b-Channel 1: Peak

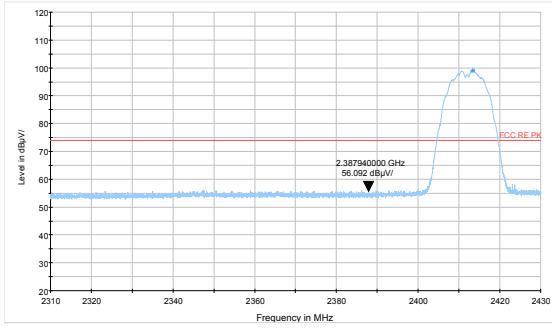

802.11b-Channel 11: Peak

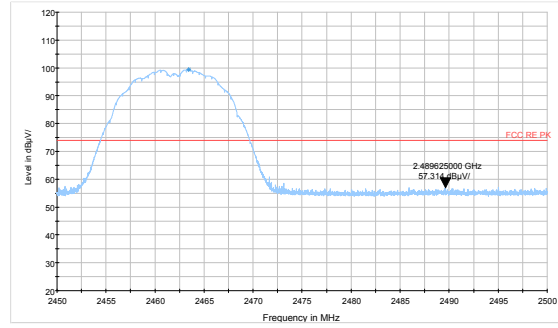

802.11b-Channel 1: Average

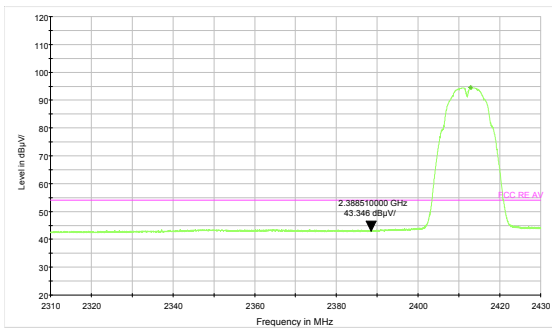

802.11b-Channel 11: Average

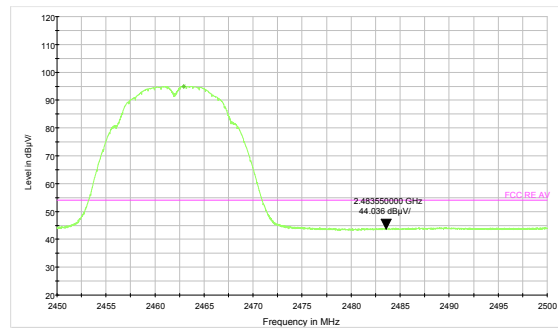



SISO Antenna 3

802.11g-Channel 1: Peak

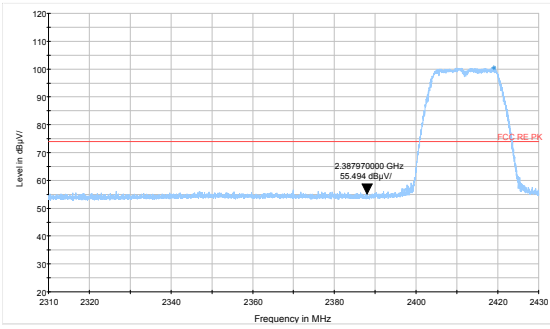

802.11g-Channel 11: Peak

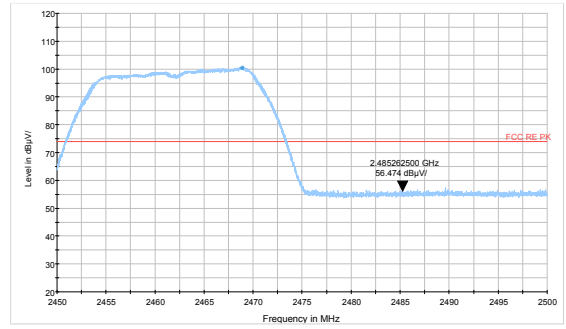

802.11g-Channel 1: Average

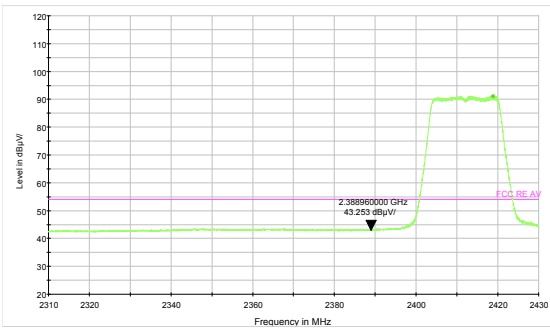

802.11g-Channel 11: Average

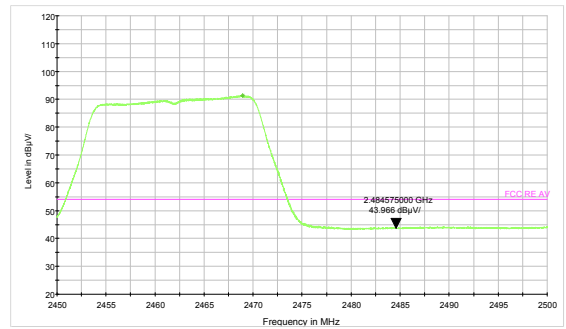



MIMO

802.11n HT20 -Channel 1: Peak

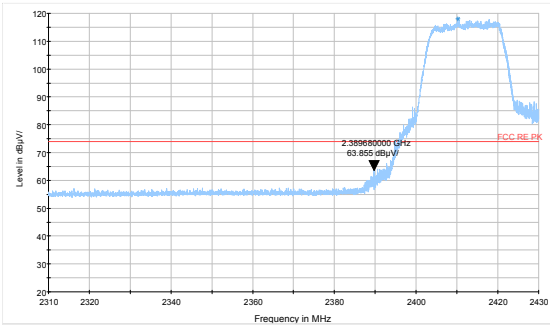

802.11n HT20-Channel 11: Peak

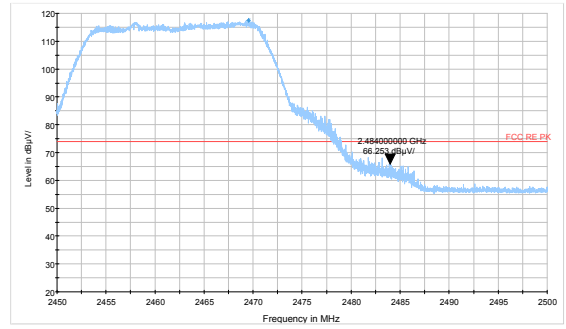

802.11n HT20-Channel 1: Average

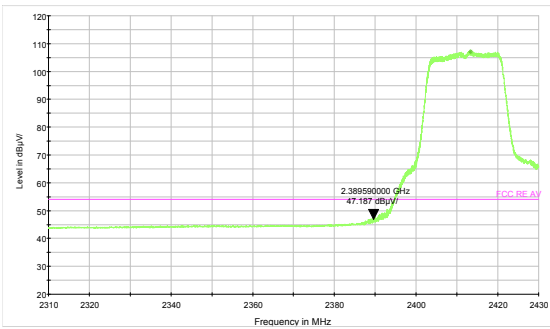

802.11n HT20-Channel 11: Average

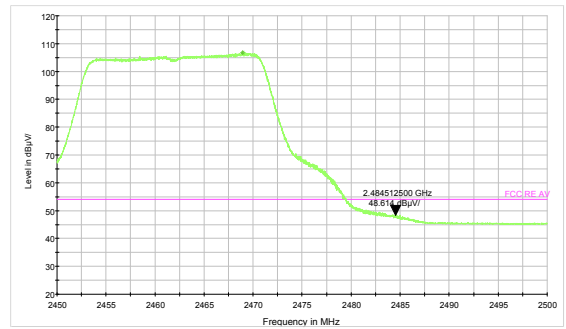

802.11n HT40 -Channel 3: Peak

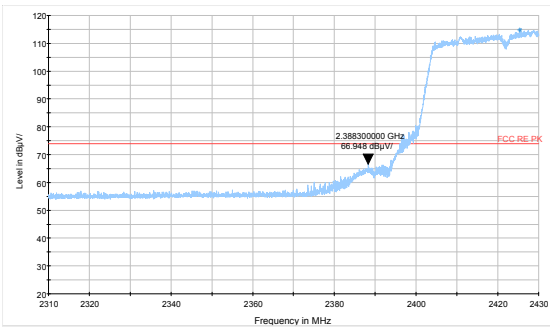

802.11n HT40-Channel 9: Peak

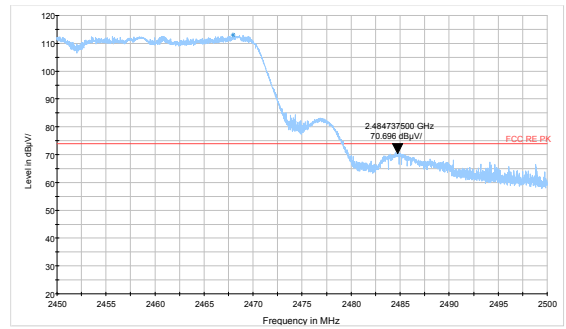

802.11n HT40-Channel 3: Average

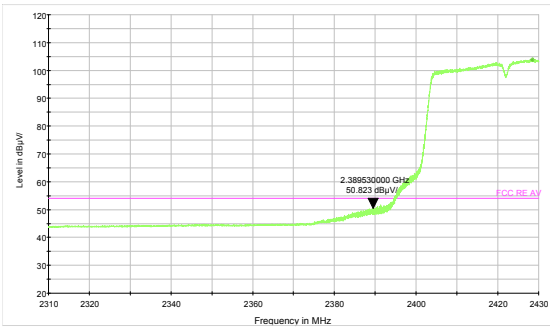

802.11n HT40-Channel 9: Average

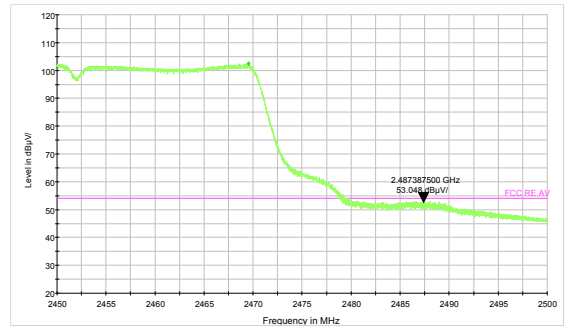

5.7. Radiates Emission

Ambient condition

Temperature	Relative humidity	Pressure
23°C ~25°C	45%~50%	102.5kPa

Method of Measurement

The test set-up was made in accordance to the general provisions of ANSI C63.10-2013. The Equipment Under Test (EUT) was set up on a non-conductive table in the semi-anechoic chamber. The test was performed at the distance of 3 m between the EUT and the receiving antenna. The radiated emissions measurements were made in a typical installation configuration.

Sweep the whole frequency band through the range from 9 kHz to the 10th harmonic of the carrier, and the emissions less than 20 dB below the permissible value are reported.

During the test, below 30MHz, the center of the loop shall be 1 meters; above 30MHz, the height of receive antenna shall be moved from 1 to 4 meters, and the antenna shall be performed under horizontal and vertical polarization. The turntable shall be rotated from 0 to 360 degrees for detecting the maximum of radiated spurious signal level. The measurements shall be repeated with orthogonal polarization of the test antenna. The data of cable loss and antenna factor has been calibrated in full testing frequency range before the testing.

Set the spectrum analyzer in the following:

Below 1GHz (detector: Peak and Quasi-Peak)

RBW=100 kHz / VBW=300 kHz / Sweep=AUTO

Above 1GHz (detector: Peak):

(a) PEAK: RBW=1MHz VBW=3MHz/ Sweep=AUTO

(b) AVERAGE: RBW=1MHz / VBW=3MHz / Sweep=AUTO

The radiated emission was measured in the following position: EUT stand-up position (Z axis), lie-down position (X, Y axis). The worst emission was found in stand-up position (Z axis) and the worst case was recorded.

The test is in transmitting mode.

Test setup

9KHz~~~ 30MHz

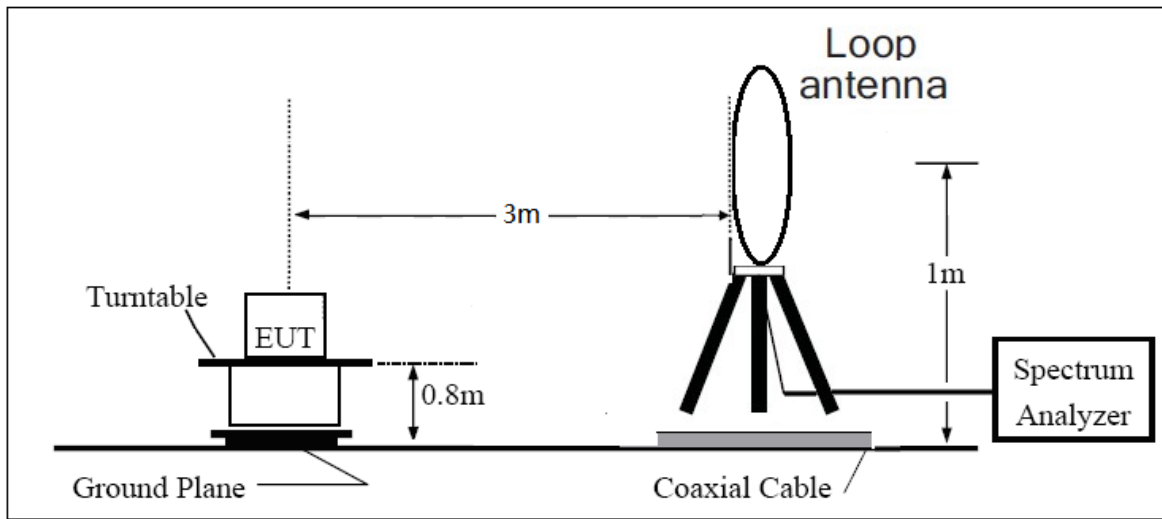

30MHz~~~ 1GHz

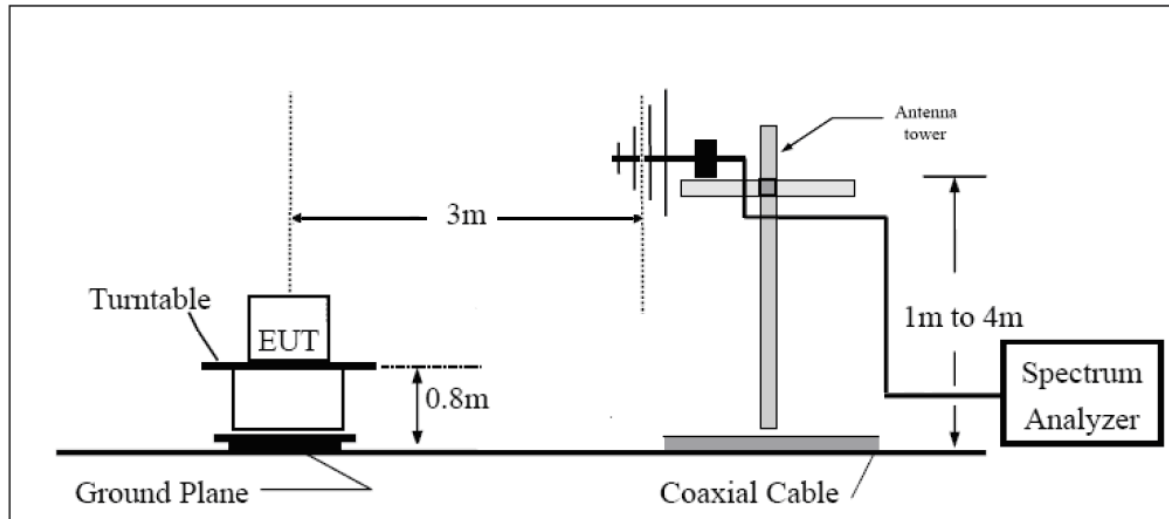

Above 1GHz

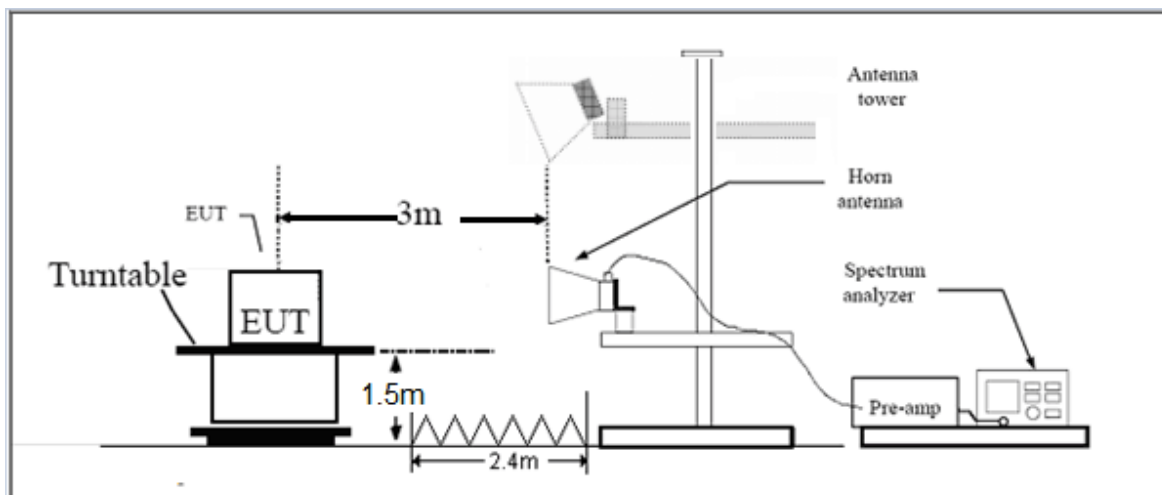

Note: Area side: 2.4mX3.6m

**Limits**

Rule Part 15.247(d) specifies that “In addition, radiated emissions which fall in the restricted bands, as defined in § 15.205(a), must also comply with the radiated emission limits specified in § 15.209(a) (see § 15.205(c)).”

Limit in restricted band

Frequency of emission (MHz)	Field strength(uV/m)	Field strength(dBuV/m)
0.009–0.490	2400/F(kHz)	/
0.490–1.705	24000/F(kHz)	/
1.705–30.0	30	/
30-88	100	40
88-216	150	43.5
216-960	200	46
Above960	500	54

§15.35(b)

There is also a limit on the radio frequency emissions, as measured using instrumentation with a peak detector function, corresponding to 20 dB above the maximum permitted average limit.

Measurement Uncertainty

The assessed measurement uncertainty to ensure 95% confidence level for the normal distribution is with the coverage factor $k = 1.96$.

Frequency	Uncertainty
9KHz-30MHz	3.55 dB
30MHz-200MHz	4.19 dB
200MHz-1GHz	3.63 dB
Above 1GHz	3.68 dB



Test result

Sweep from 9 kHz to 30MHz, and the emissions more than 20 dB below the permissible value are not reported.

The following graphs display the maximum values of horizontal and vertical by software.

For above 1GHz, Blue trace uses the peak detection, Green trace uses the average detection.

SISO Antenna 1 802.11b CH1

FCC RE 0.03-1GHz QP Class B

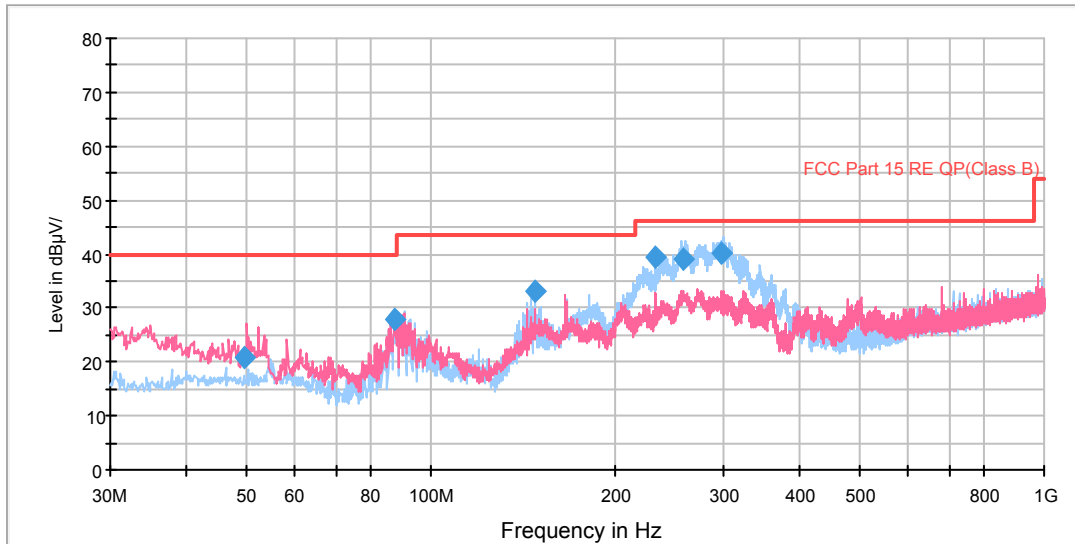

Radiates Emission from 30MHz to 1GHz

Frequency (MHz)	Quasi-Peak (dBuV/m)	Height (cm)	Polarization	Azimuth (deg)	Reading value (dBuV/m)	Correct Factor (dB)	Margin (dB)	Limit (dBuV/m)
49.847500	20.8	100.0	V	246.0	33.8	-13.0	19.2	40.0
87.633750	27.8	125.0	V	112.0	38.9	-11.1	12.2	40.0
148.137500	33.1	125.0	H	25.0	42.2	-9.1	10.4	43.5
232.766250	39.4	125.0	H	257.0	52.8	-13.4	6.6	46.0
258.966250	39.0	100.0	H	250.0	53.3	-14.3	7.0	46.0
298.775000	40.1	100.0	H	237.0	55.5	-15.4	5.9	46.0

Remark: 1. Quasi-Peak = Reading value + Correction factor

2. Correction Factor = Antenna factor+ Insertion loss (cable loss+amplifier gain)

3. Margin = Limit – Quasi-Peak

RE 1G-3GHz PK+AV

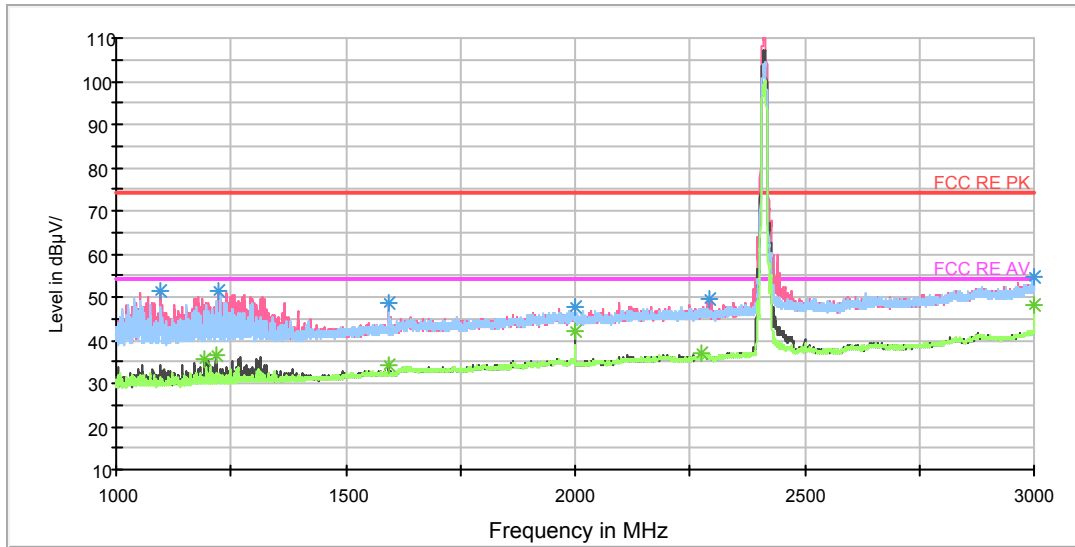

Note: The signal beyond the limit is carrier.
Radiates Emission from 1GHz to 3GHz

Frequency (MHz)	Peak (dBuV/m)	Height (cm)	Polarization	Azimuth (deg)	Reading value (dBuV/m)	Correct Factor (dB)	Margin (dB)	Limit (dBuV/m)
1097.000000	51.3	101.0	V	84.0	60.2	-8.9	22.7	74
1222.500000	51.5	101.0	V	72.0	59.3	-7.8	22.5	74
1595.500000	48.5	101.0	V	193.0	54.9	-6.4	25.5	74
2000.000000	47.7	101.0	V	84.0	51.1	-3.4	26.3	74
3000.000000	54.7	202.0	V	220.0	57.0	-2.3	19.3	74
2293.500000	49.8	101.0	V	48.0	51.7	-1.9	24.2	74

Remark: 1. Correction Factor = Antenna factor+ Insertion loss (cable loss + amplifier gain)

Frequency (MHz)	Average (dBuV/m)	Height (cm)	Polarization	Azimuth (deg)	Reading value (dBuV/m)	Correct Factor (dB)	Margin (dB)	Limit (dBuV/m)
1192.750000	35.5	101.0	V	48.0	43.7	-8.2	18.5	54
1216.250000	36.3	101.0	V	84.0	44.2	-7.9	17.7	54
1595.250000	34.0	101.0	V	266.0	40.4	-6.4	20.0	54
2000.000000	42.1	101.0	V	84.0	45.5	-3.4	11.9	54
3000.000000	48.2	101.0	V	0.0	50.5	-2.3	5.8	54
2275.500000	37.0	101.0	V	0.0	38.5	-1.5	17.0	54

Remark: 1. Correction Factor = Antenna factor+ Insertion loss (cable loss + amplifier gain)

RE 3-18GHz PK+AV

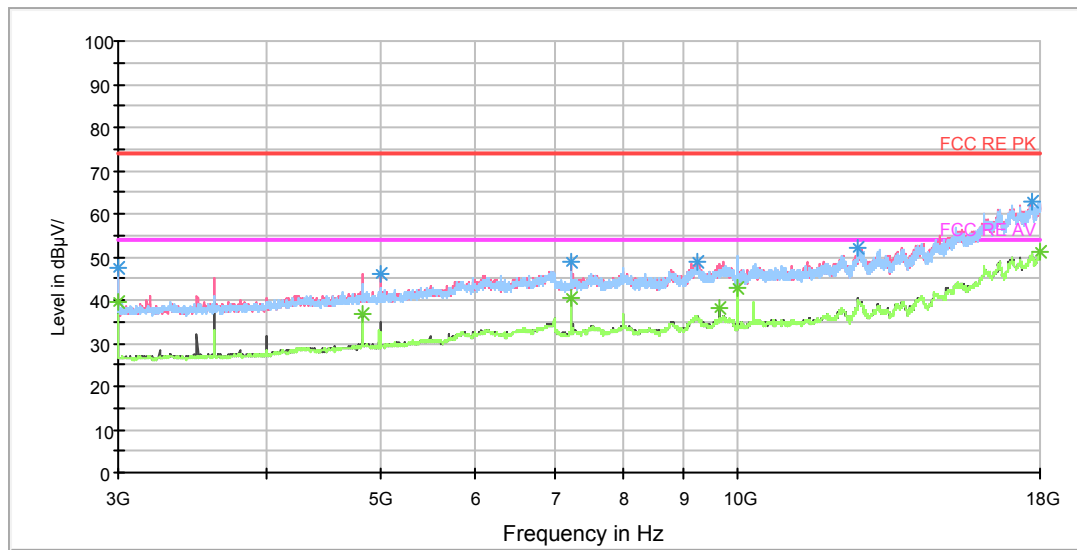

Radiates Emission from 3GHz to 18GHz

Frequency (MHz)	Peak (dBuV/m)	Height (cm)	Polarization	Azimuth (deg)	Reading value (dBuV/m)	Correct Factor (dB)	Margin (dB)	Limit (dBuV/m)
3000.000000	47.6	202.0	V	16.0	50.8	-3.2	26.4	74
4998.750000	45.9	202.0	V	341.0	47.5	-1.6	28.1	74
7235.625000	49.0	102.0	V	44.0	55.8	-6.8	25.0	74
9253.125000	48.9	102.0	V	0.0	58.5	-9.6	25.1	74
12641.250000	52.1	202.0	H	67.0	66.6	-14.5	21.9	74
17705.625000	62.9	202.0	V	200.0	87.6	-24.7	11.1	74

Remark: 1. Correction Factor = Antenna factor+ Insertion loss (cable loss + amplifier gain)

Frequency (MHz)	Average (dBuV/m)	Height (cm)	Polarization	Azimuth (deg)	Reading value (dBuV/m)	Correct Factor (dB)	Margin (dB)	Limit (dBuV/m)
3000.000000	39.4	202.0	V	16.0	42.6	-3.2	14.6	54
4822.500000	36.7	102.0	V	139.0	38.0	-1.3	17.3	54
7235.625000	40.6	102.0	V	44.0	47.4	-6.8	13.4	54
9648.750000	38.2	202.0	V	0.0	48.0	-9.8	15.8	54
10001.250000	42.7	102.0	H	315.0	52.4	-9.7	11.3	54
18000.000000	50.9	102.0	V	162.0	76.4	-25.5	3.1	54

Remark: 1. Correction Factor = Antenna factor+ Insertion loss (cable loss + amplifier gain)

RE 18-26.5GHz PK+AV

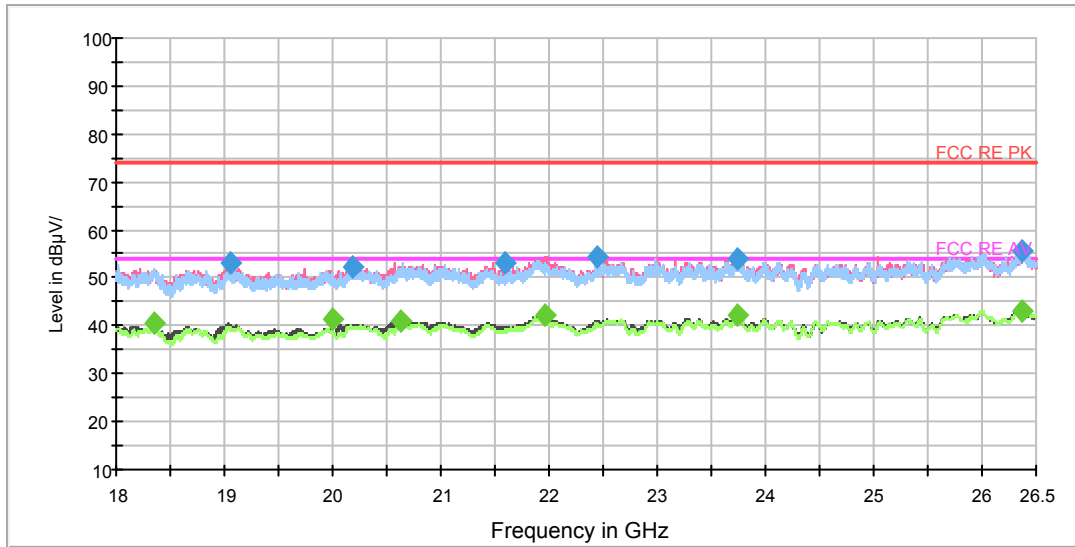

Radiates Emission from 18GHz to 26.5GHz

Frequency (MHz)	Peak (dBuV/m)	Polarization	Azimuth (deg)	Reading value (dBuV/m)	Correct Factor (dB)	Margin (dB)	Limit (dBuV/m)
19055.062500	53.0	V	354.0	58.2	-5.2	21.0	74
20190.875000	52.2	V	260.0	58.1	-5.9	21.8	74
21588.062500	53.3	V	164.0	61.3	-8.0	20.7	74
22440.187500	54.3	V	177.0	61.3	-7.0	19.7	74
23749.187500	54.1	V	205.0	60.0	-5.9	19.9	74
26366.125000	55.6	H	24.0	61.0	-5.4	18.4	74

Remark: 1. Correction Factor = Antenna factor+ Insertion loss (cable loss + amplifier gain)

Frequency (MHz)	Average (dBuV/m)	Polarization	Azimuth (deg)	Reading value (dBuV/m)	Correct Factor (dB)	Margin (dB)	Limit (dBuV/m)
18343.187500	40.5	V	205.0	43.7	-3.2	13.5	54
20000.687500	41.2	H	0.0	46.9	-5.7	12.8	54
20621.187500	41.2	V	96.0	47.7	-6.5	12.8	54
21970.562500	42.2	V	177.0	50.2	-8.0	11.8	54
23744.937500	42.1	V	232.0	48.0	-5.9	11.9	54
26377.812500	43.3	V	327.0	48.7	-5.4	10.7	54

Remark: 1. Correction Factor = Antenna factor+ Insertion loss (cable loss + amplifier gain)



SISO Antenna 1 802.11b CH6

FCC RE 0.03-1GHz QP Class B

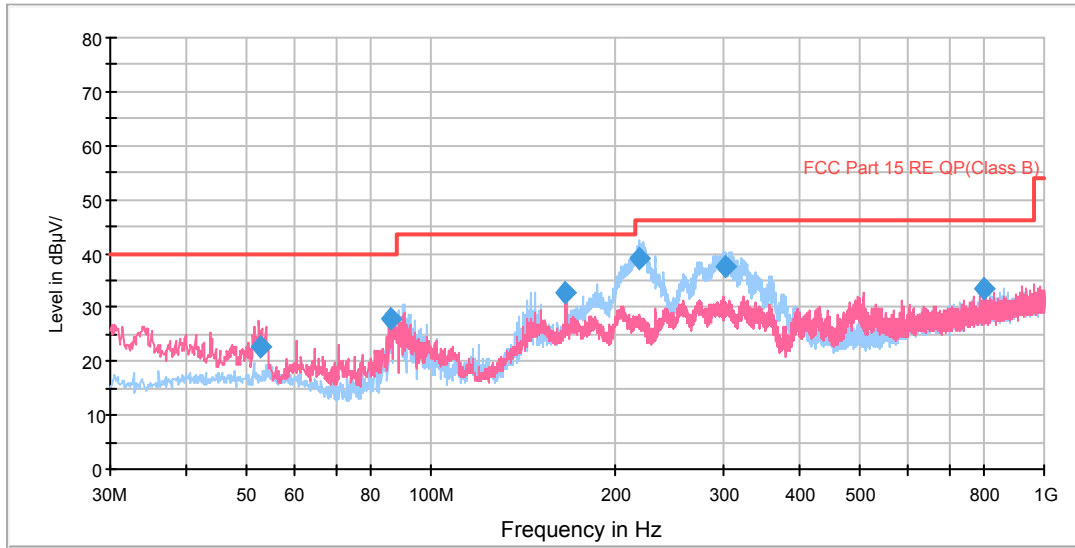

Radiates Emission from 30MHz to 1GHz

Frequency (MHz)	Quasi-Peak (dBuV/m)	Height (cm)	Polarization	Azimuth (deg)	Reading value (dBuV/m)	Correct Factor (dB)	Margin (dB)	Limit (dBuV/m)
52.871250	22.6	100.0	V	257.0	35.4	-12.8	17.4	40.0
86.057500	27.8	125.0	H	241.0	38.4	-10.6	12.2	40.0
166.001250	32.6	125.0	H	291.0	42.6	-10.0	10.9	43.5
219.427500	39.1	114.0	H	262.0	52.0	-12.9	6.9	46.0
301.917500	37.7	100.0	H	224.0	53.2	-15.5	8.3	46.0
796.623750	33.3	100.0	V	114.0	57.6	-24.3	12.7	46.0

- Remark: 1. Quasi-Peak = Reading value + Correction factor
 2. Correction Factor = Antenna factor+ Insertion loss (cable loss+amplifier gain)
 3. Margin = Limit – Quasi-Peak

RE 1G-3GHz PK+AV

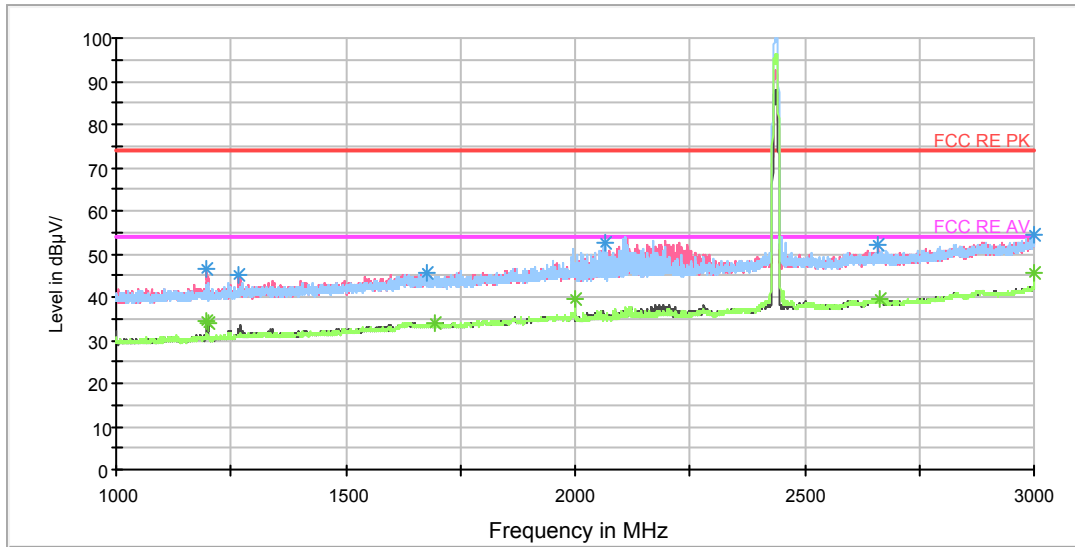

Note: The signal beyond the limit is carrier.
Radiates Emission from 1GHz to 3GHz

Frequency (MHz)	Peak (dBuV/m)	Height (cm)	Polarization	Azimuth (deg)	Reading value (dBuV/m)	Correct Factor (dB)	Margin (dB)	Limit (dBuV/m)
1197.500000	46.3	101.0	V	267.0	54.5	-8.2	27.7	74
1267.000000	44.9	101.0	V	357.0	52.6	-7.7	29.1	74
1676.000000	45.4	101.0	V	110.0	50.5	-5.1	28.6	74
2067.000000	52.8	101.0	H	296.0	55.9	-3.1	21.2	74
2661.500000	52.3	101.0	V	339.0	52.6	-0.3	21.7	74
3000.000000	54.6	101.0	V	0.0	56.9	-2.3	19.4	74

Remark: 1. Correction Factor = Antenna factor+ Insertion loss (cable loss + amplifier gain)

Frequency (MHz)	Average (dBuV/m)	Height (cm)	Polarization	Azimuth (deg)	Reading value (dBuV/m)	Correct Factor (dB)	Margin (dB)	Limit (dBuV/m)
1198.250000	34.4	101.0	V	267.0	42.6	-8.2	19.6	54
1201.000000	34.0	101.0	V	267.0	42.2	-8.2	20.0	54
1695.000000	34.1	101.0	V	314.0	39.1	-5.0	19.9	54
2000.250000	39.5	101.0	V	71.0	42.9	-3.4	14.5	54
2662.750000	39.5	101.0	V	297.0	39.8	-0.3	14.5	54
3000.000000	45.7	101.0	H	0.0	48.0	-2.3	8.3	54

Remark: 1. Correction Factor = Antenna factor+ Insertion loss (cable loss + amplifier gain)



RE 3-18GHz PK+AV

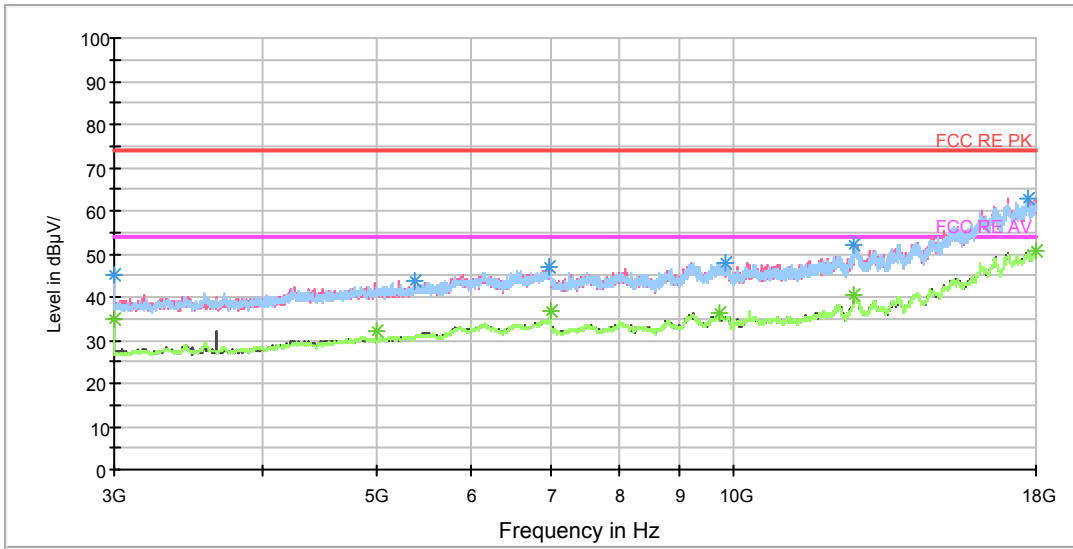

Radiates Emission from 3GHz to 18GHz

Frequency (MHz)	Peak (dBuV/m)	Height (cm)	Polarization	Azimuth (deg)	Reading value (dBuV/m)	Correct Factor (dB)	Margin (dB)	Limit (dBuV/m)
3000.000000	44.9	101.0	H	0.0	48.1	-3.2	29.1	74
5377.500000	43.6	101.0	V	331.0	45.9	-2.3	30.4	74
6978.750000	46.9	101.0	H	33.0	53.2	-6.3	27.1	74
9841.875000	47.8	101.0	H	7.0	58.0	-10.2	26.2	74
12643.125000	52.3	101.0	V	358.0	66.7	-14.4	21.7	74
17703.750000	62.8	101.0	V	303.0	87.5	-24.7	11.2	74

Remark: 1. Correction Factor = Antenna factor+ Insertion loss (cable loss + amplifier gain)

Frequency (MHz)	Average (dBuV/m)	Height (cm)	Polarization	Azimuth (deg)	Reading value (dBuV/m)	Correct Factor (dB)	Margin (dB)	Limit (dBuV/m)
3000.000000	35.1	101.0	H	0.0	38.3	-3.2	18.9	54
4998.750000	31.9	101.0	H	0.0	33.5	-1.6	22.1	54
6999.375000	36.9	101.0	V	0.0	43.4	-6.5	17.1	54
9744.375000	36.2	101.0	V	142.0	46.1	-9.9	17.8	54
12643.125000	40.3	101.0	V	358.0	54.7	-14.4	13.7	54
18000.000000	50.8	101.0	V	197.0	76.3	-25.5	3.2	54

Remark: 1. Correction Factor = Antenna factor+ Insertion loss (cable loss + amplifier gain)

RE 18-26.5GHz PK+AV

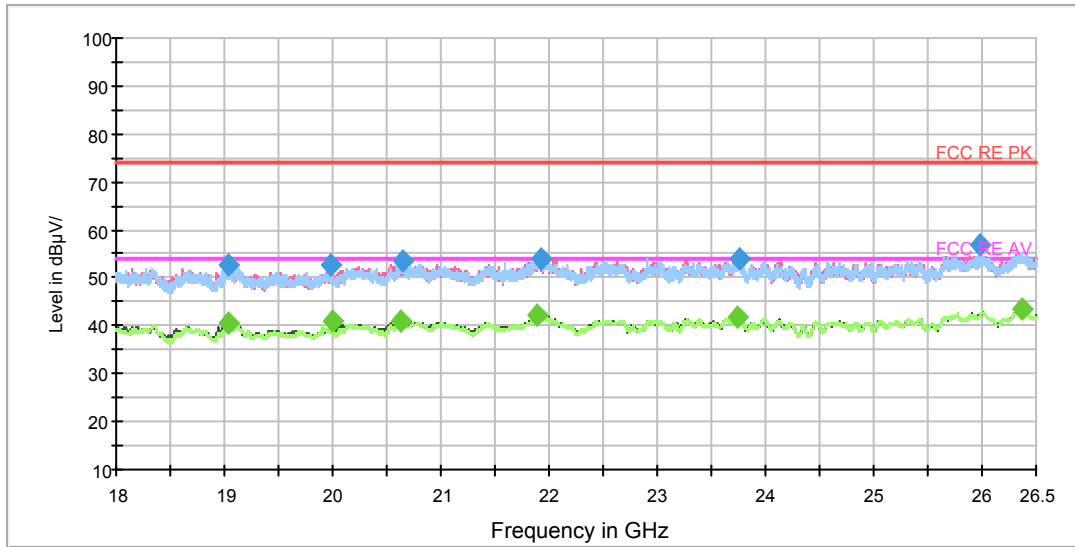

Radiates Emission from 18GHz to 26.5GHz

Frequency (MHz)	Peak (dBuV/m)	Polarization	Azimuth (deg)	Reading value (dBuV/m)	Correct Factor (dB)	Margin (dB)	Limit (dBuV/m)
19038.062500	52.5	V	138.0	57.6	-5.1	21.5	74
19978.375000	52.7	V	233.0	58.4	-5.7	21.3	74
20648.812500	53.3	V	260.0	59.9	-6.6	20.7	74
21930.187500	53.9	H	111.0	61.9	-8.0	20.1	74
23761.937500	53.9	V	274.0	59.8	-5.9	20.1	74
25988.937500	56.8	H	193.0	62.2	-5.4	17.2	74

Remark: 1. Correction Factor = Antenna factor+ Insertion loss (cable loss + amplifier gain)

Frequency (MHz)	Average (dBuV/m)	Polarization	Azimuth (deg)	Reading value (dBuV/m)	Correct Factor (dB)	Margin (dB)	Limit (dBuV/m)
19031.687500	40.5	V	206.0	45.6	-5.1	13.5	54
20000.687500	40.9	V	40.0	46.6	-5.7	13.1	54
20628.625000	41.1	V	233.0	47.6	-6.5	12.9	54
21896.187500	42.0	V	96.0	50.0	-8.0	12.0	54
23744.937500	41.9	H	235.0	47.8	-5.9	12.1	54
26368.250000	43.3	V	246.0	48.7	-5.4	10.7	54

Remark: 1. Correction Factor = Antenna factor+ Insertion loss (cable loss + amplifier gain)

SISO Antenna 1 802.11b CH11

FCC RE 0.03-1GHz QP Class B

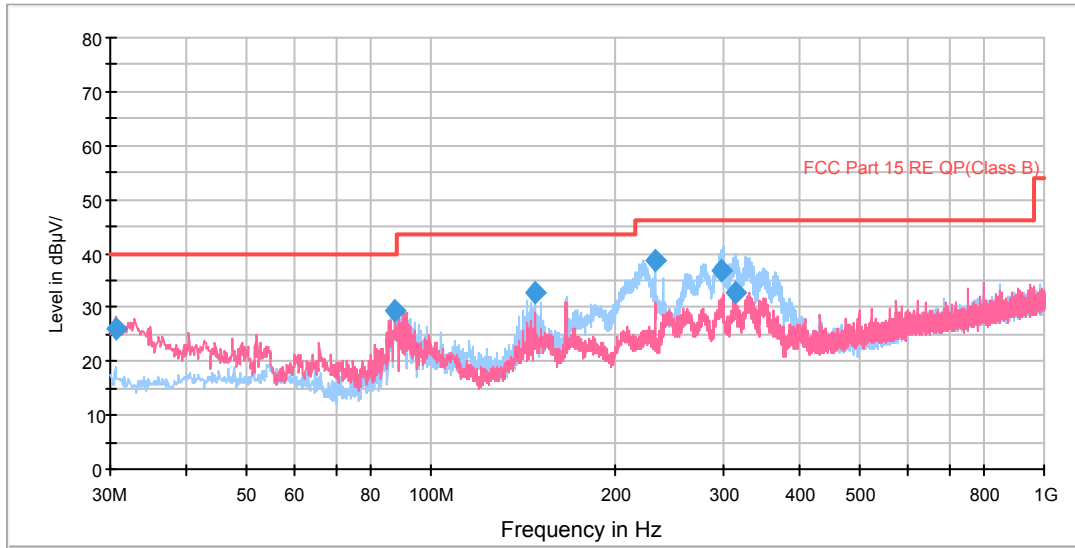

Radiates Emission from 30MHz to 1GHz

Frequency (MHz)	Quasi-Peak (dBuV/m)	Height (cm)	Polarization	Azimuth (deg)	Reading value (dBuV/m)	Correct Factor (dB)	Margin (dB)	Limit (dBuV/m)
30.606250	26.2	100.0	V	190.0	38.1	-11.9	13.8	40.0
87.633750	29.3	125.0	H	235.0	40.4	-11.1	10.7	40.0
148.137500	32.9	125.0	H	29.0	42.0	-9.1	10.6	43.5
232.370000	38.6	125.0	H	273.0	52.0	-13.4	7.4	46.0
298.776250	36.7	100.0	H	253.0	52.1	-15.4	9.3	46.0
313.002500	32.8	100.0	H	226.0	48.5	-15.7	13.2	46.0

- Remark:**
1. Quasi-Peak = Reading value + Correction factor
 2. Correction Factor = Antenna factor+ Insertion loss(cable loss+amplifier gain)
 3. Margin = Limit – Quasi-Peak

RE 1G-3GHz PK+AV

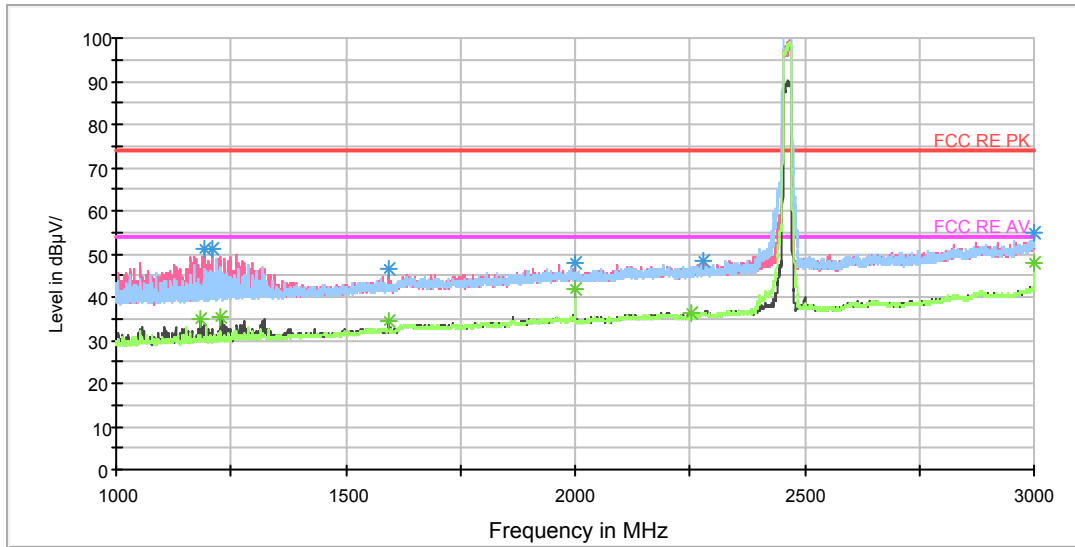

Note: The signal beyond the limit is carrier.
Radiates Emission from 1GHz to 3GHz

Frequency (MHz)	Peak (dBuV/m)	Height (cm)	Polarization	Azimuth (deg)	Reading value (dBuV/m)	Correct Factor (dB)	Margin (dB)	Limit (dBuV/m)
1190.250000	51.2	102.0	V	73.0	59.4	-8.2	22.8	74
1207.750000	51.3	102.0	V	36.0	59.4	-8.1	22.7	74
1593.000000	46.6	102.0	V	258.0	53.0	-6.4	27.4	74
2000.000000	48.0	102.0	V	73.0	51.4	-3.4	26.0	74
3000.000000	54.7	102.0	V	0.0	57.0	-2.3	19.3	74
2281.500000	48.1	202.0	V	67.0	49.5	-1.4	25.9	74

Remark: 1. Correction Factor = Antenna factor+ Insertion loss (cable loss + amplifier gain)

Frequency (MHz)	Average (dBuV/m)	Height (cm)	Polarization	Azimuth (deg)	Reading value (dBuV/m)	Correct Factor (dB)	Margin (dB)	Limit (dBuV/m)
1182.750000	34.7	102.0	V	36.0	42.7	-8.0	19.3	54
1229.000000	35.3	102.0	V	36.0	43.0	-7.7	18.7	54
1593.750000	34.4	102.0	V	196.0	40.8	-6.4	19.6	54
2000.000000	42.0	202.0	V	150.0	45.4	-3.4	12.0	54
3000.000000	47.9	202.0	V	212.0	50.2	-2.3	6.1	54
2251.750000	36.1	202.0	V	0.0	38.4	-2.3	17.9	54

Remark: 1. Correction Factor = Antenna factor+ Insertion loss (cable loss + amplifier gain)

RE 3-18GHz PK+AV

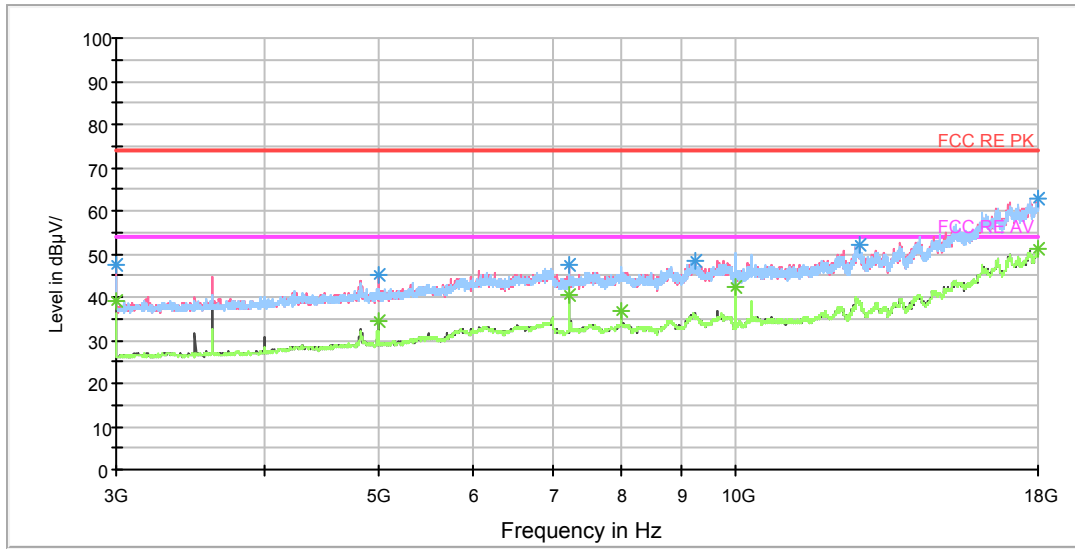

Radiates Emission from 3GHz to 18GHz

Frequency (MHz)	Peak (dBuV/m)	Height (cm)	Polarization	Azimuth (deg)	Reading value (dBuV/m)	Correct Factor (dB)	Margin (dB)	Limit (dBuV/m)
3000.000000	47.5	202.0	V	17.0	50.7	-3.2	26.5	74
4998.750000	45.1	202.0	V	341.0	46.7	-1.6	28.9	74
7235.625000	47.4	102.0	V	44.0	54.2	-6.8	26.6	74
9240.000000	48.4	202.0	V	62.0	58.3	-9.9	25.6	74
12738.750000	51.9	202.0	V	108.0	66.0	-14.1	22.1	74
18000.000000	62.7	202.0	H	297.0	88.2	-25.5	11.3	74

Remark: 1. Correction Factor = Antenna factor+ Insertion loss (cable loss + amplifier gain)

Frequency (MHz)	Average (dBuV/m)	Height (cm)	Polarization	Azimuth (deg)	Reading value (dBuV/m)	Correct Factor (dB)	Margin (dB)	Limit (dBuV/m)
3000.000000	38.8	202.0	V	17.0	42.0	-3.2	15.2	54
4998.750000	34.6	202.0	V	341.0	36.2	-1.6	19.4	54
7235.625000	40.4	102.0	V	44.0	47.2	-6.8	13.6	54
8000.625000	36.8	102.0	H	39.0	44.1	-7.3	17.2	54
10001.250000	42.5	102.0	H	312.0	52.2	-9.7	11.5	54
18000.000000	50.9	102.0	H	39.0	76.4	-25.5	3.1	54

Remark: 1. Correction Factor = Antenna factor+ Insertion loss (cable loss + amplifier gain)

RE 18-26.5GHz PK+AV

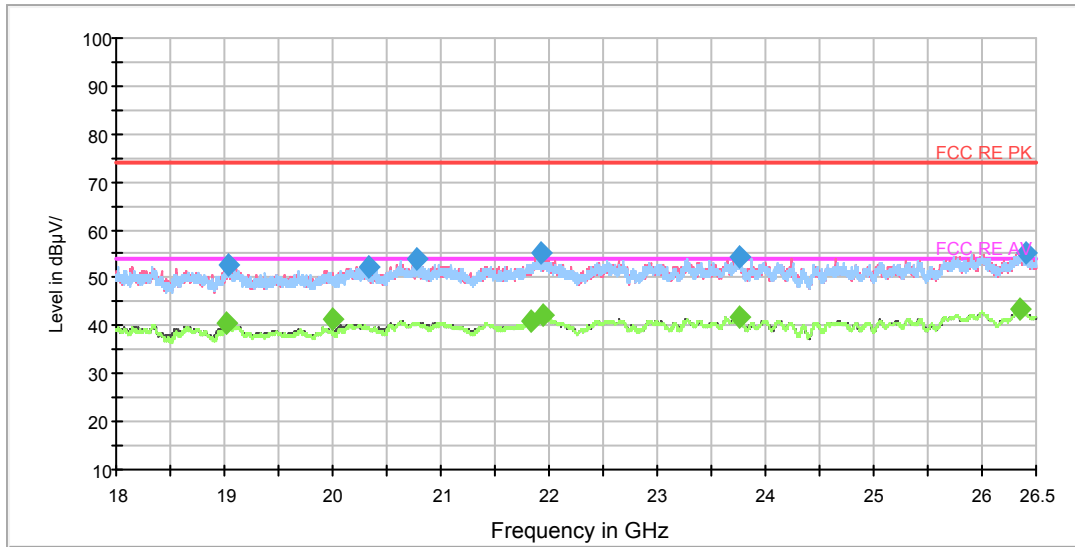

Radiates Emission from 18GHz to 26.5GHz

Frequency (MHz)	Peak (dBuV/m)	Polarization	Azimuth (deg)	Reading value (dBuV/m)	Correct Factor (dB)	Margin (dB)	Limit (dBuV/m)
19038.062500	52.7	H	59.0	57.8	-5.1	21.3	74
20329.000000	52.3	V	325.0	58.3	-6.0	21.7	74
20782.687500	53.8	V	339.0	60.7	-6.9	20.2	74
21921.687500	55.2	V	151.0	63.2	-8.0	18.8	74
23754.500000	54.4	V	244.0	60.3	-5.9	19.6	74
26416.062500	55.1	V	325.0	60.5	-5.4	18.9	74

Remark: 1. Correction Factor = Antenna factor+ Insertion loss (cable loss + amplifier gain)

Frequency (MHz)	Average (dBuV/m)	Polarization	Azimuth (deg)	Reading value (dBuV/m)	Correct Factor (dB)	Margin (dB)	Limit (dBuV/m)
19025.312500	40.4	V	69.0	45.5	-5.1	13.6	54
20000.687500	41.4	H	32.0	47.1	-5.7	12.6	54
21839.875000	41.1	V	285.0	49.1	-8.0	12.9	54
21944.000000	42.3	V	0.0	50.3	-8.0	11.7	54
23753.437500	42.0	H	0.0	47.9	-5.9	12.0	54
26353.375000	43.3	H	86.0	48.7	-5.4	10.7	54

Remark: 1. Correction Factor = Antenna factor+ Insertion loss (cable loss + amplifier gain)



SISO Antenna 3 802.11g CH1

FCC RE 0.03-1GHz QP Class B

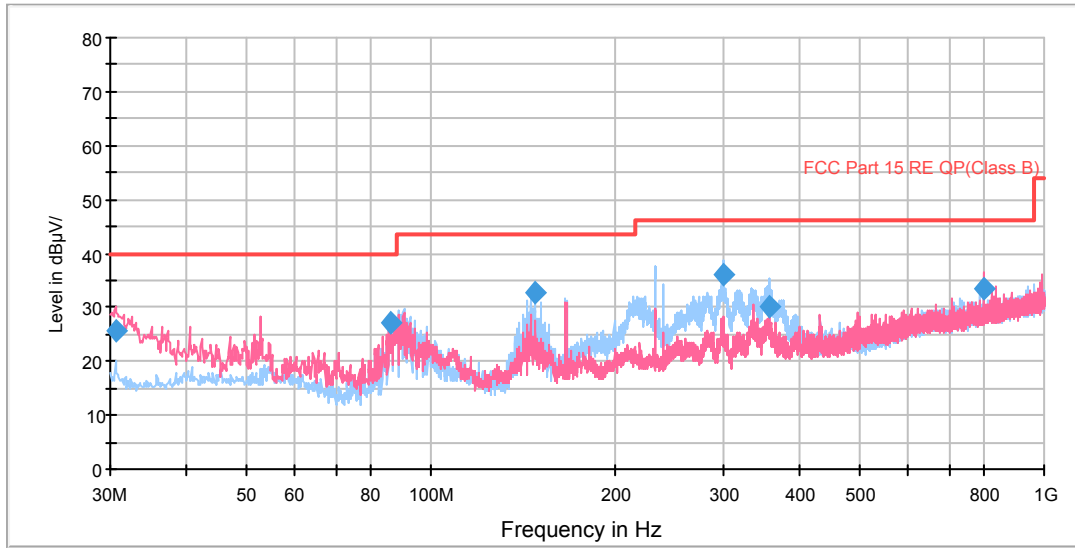

Radiates Emission from 30MHz to 1GHz

Frequency (MHz)	Quasi-Peak (dBuV/m)	Height (cm)	Polarization	Azimuth (deg)	Reading value (dBuV/m)	Correct Factor (dB)	Margin (dB)	Limit (dBuV/m)
30.606250	25.8	100.0	V	303.0	37.7	-11.9	14.2	40.0
86.057500	27.1	125.0	V	124.0	37.7	-10.6	12.9	40.0
148.137500	32.9	125.0	H	21.0	42.0	-9.1	10.6	43.5
299.296250	36.0	100.0	H	252.0	51.4	-15.4	10.0	46.0
356.768750	30.1	100.0	H	199.0	46.9	-16.8	15.9	46.0
796.623750	33.7	100.0	V	112.0	58.0	-24.3	12.3	46.0

- Remark: 1. Quasi-Peak = Reading value + Correction factor
 2. Correction Factor = Antenna factor+ Insertion loss(cable loss+amplifier gain)
 3. Margin = Limit – Quasi-Peak

RE 1G-3GHz PK+AV

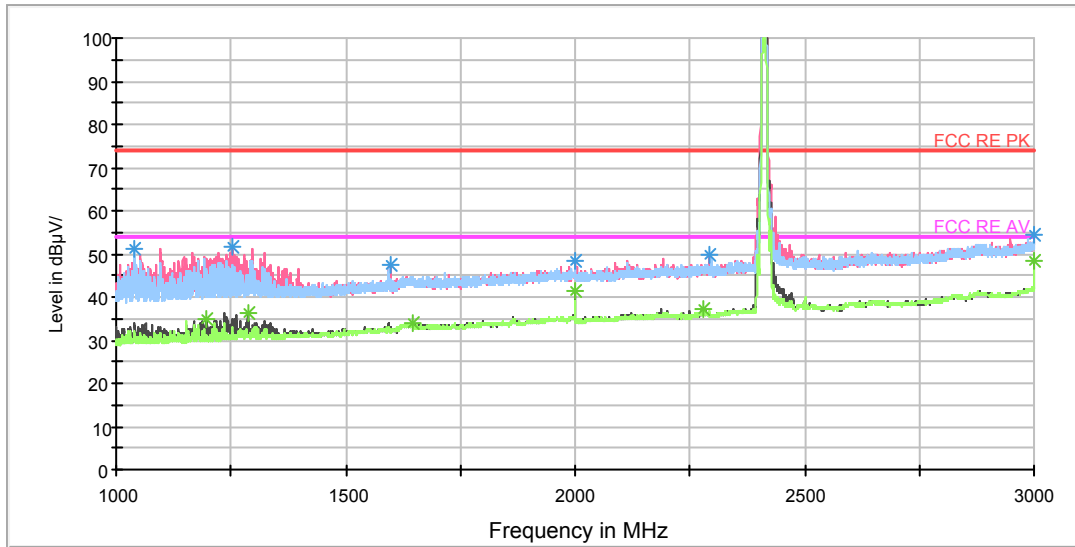

Note: The signal beyond the limit is carrier.
Radiates Emission from 1GHz to 3GHz

Frequency (MHz)	Peak (dBuV/m)	Height (cm)	Polarization	Azimuth (deg)	Reading value (dBuV/m)	Correct Factor (dB)	Margin (dB)	Limit (dBuV/m)
1038.750000	51.4	103.0	H	57.0	60.5	-9.1	22.6	74
1252.000000	51.8	103.0	V	185.0	59.8	-8.0	22.2	74
1596.750000	47.2	103.0	V	49.0	53.6	-6.4	26.8	74
2000.250000	48.5	202.0	V	149.0	51.9	-3.4	25.5	74
3000.000000	54.3	103.0	V	0.0	56.6	-2.3	19.7	74
2292.000000	50.0	103.0	V	0.0	51.8	-1.8	24.0	74

Remark: 1. Correction Factor = Antenna factor+ Insertion loss (cable loss + amplifier gain)

Frequency (MHz)	Average (dBuV/m)	Height (cm)	Polarization	Azimuth (deg)	Reading value (dBuV/m)	Correct Factor (dB)	Margin (dB)	Limit (dBuV/m)
1197.250000	34.9	103.0	V	98.0	43.1	-8.2	19.1	54
1286.250000	36.5	103.0	V	86.0	44.2	-7.7	17.5	54
1646.250000	33.9	202.0	V	202.0	38.8	-4.9	20.1	54
2000.250000	41.6	103.0	V	86.0	45.0	-3.4	12.4	54
3000.000000	48.2	202.0	V	138.0	50.5	-2.3	5.8	54
2279.750000	37.0	103.0	V	0.0	38.3	-1.3	17.0	54

Remark: 1. Correction Factor = Antenna factor+ Insertion loss (cable loss + amplifier gain)

RE 3-18GHz PK+AV

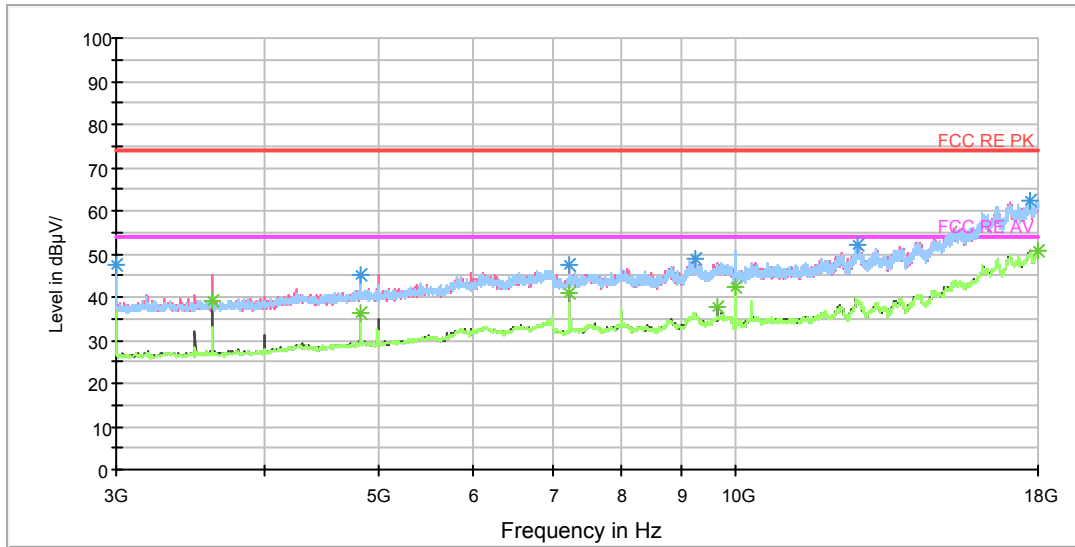

Radiates Emission from 3GHz to 18GHz

Frequency (MHz)	Peak (dBuV/m)	Height (cm)	Polarization	Azimuth (deg)	Reading value (dBuV/m)	Correct Factor (dB)	Margin (dB)	Limit (dBuV/m)
3000.000000	47.2	202.0	V	16.0	50.4	-3.2	26.8	74
4822.500000	45.2	202.0	V	0.0	46.5	-1.3	28.8	74
7235.625000	47.5	102.0	V	341.0	54.3	-6.8	26.5	74
9238.125000	48.9	202.0	V	0.0	58.8	-9.9	25.1	74
12663.750000	51.9	202.0	H	0.0	65.8	-13.9	22.1	74
17707.500000	62.5	202.0	H	0.0	87.2	-24.7	11.5	74

Remark: 1. Correction Factor = Antenna factor+ Insertion loss (cable loss + amplifier gain)

Frequency (MHz)	Average (dBuV/m)	Height (cm)	Polarization	Azimuth (deg)	Reading value (dBuV/m)	Correct Factor (dB)	Margin (dB)	Limit (dBuV/m)
3616.875000	39.3	202.0	V	0.0	41.3	-2.0	14.7	54
4822.500000	36.2	102.0	V	183.0	37.5	-1.3	17.8	54
7235.625000	40.8	102.0	V	341.0	47.6	-6.8	13.2	54
9648.750000	37.7	202.0	V	0.0	47.5	-9.8	16.3	54
10001.250000	42.2	102.0	H	292.0	51.9	-9.7	11.8	54
17998.125000	50.7	202.0	H	320.0	76.1	-25.4	3.3	54

Remark: 1. Correction Factor = Antenna factor+ Insertion loss (cable loss + amplifier gain)

RE 18-26.5GHz PK+AV

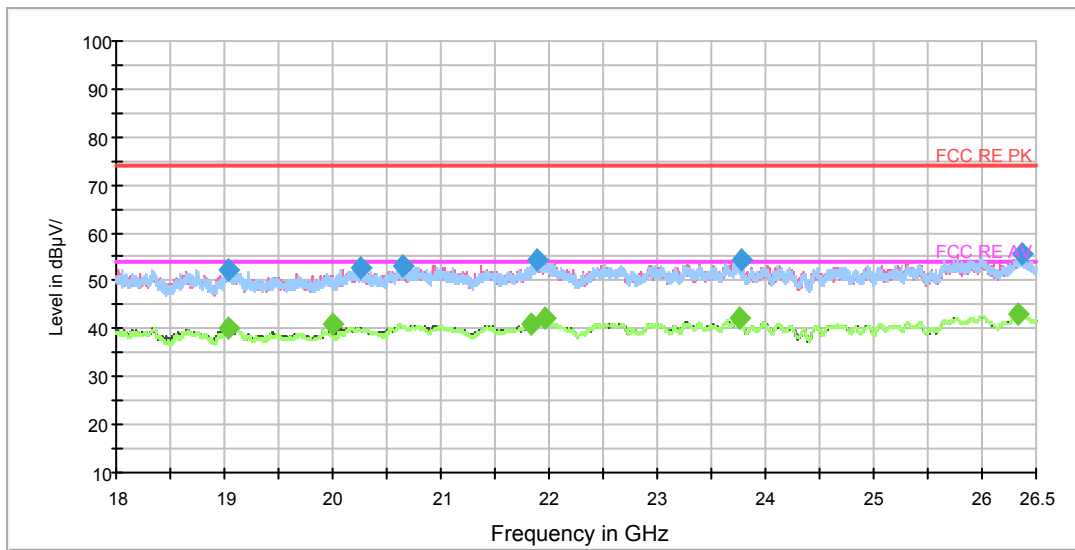

Radiates Emission from 18GHz to 26.5GHz

Frequency (MHz)	Peak (dBuV/m)	Polarization	Azimuth (deg)	Reading value (dBuV/m)	Correct Factor (dB)	Margin (dB)	Limit (dBuV/m)
19029.562500	52.5	H	4.0	57.6	-5.1	21.5	74
20259.937500	52.5	V	138.0	58.4	-5.9	21.5	74
20647.750000	53.3	V	232.0	59.9	-6.6	20.7	74
21897.250000	54.5	V	219.0	62.5	-8.0	19.5	74
23778.937500	54.5	V	125.0	60.4	-5.9	19.5	74
26362.937500	55.6	V	327.0	61.0	-5.4	18.4	74

Remark: 1. Correction Factor = Antenna factor+ Insertion loss (cable loss + amplifier gain)

Frequency (MHz)	Average (dBuV/m)	Polarization	Azimuth (deg)	Reading value (dBuV/m)	Correct Factor (dB)	Margin (dB)	Limit (dBuV/m)
19030.625000	40.3	V	314.0	45.4	-5.1	13.7	54
20000.687500	41.0	V	0.0	46.7	-5.7	13.0	54
21839.875000	41.1	V	0.0	49.1	-8.0	12.9	54
21964.187500	42.2	H	99.0	50.2	-8.0	11.8	54
23754.500000	42.1	H	0.0	48.0	-5.9	11.9	54
26341.687500	43.1	V	152.0	48.5	-5.4	10.9	54

Remark: 1. Correction Factor = Antenna factor+ Insertion loss (cable loss + amplifier gain)



SISO Antenna 3 802.11g CH6

FCC RE 0.03-1GHz QP Class B

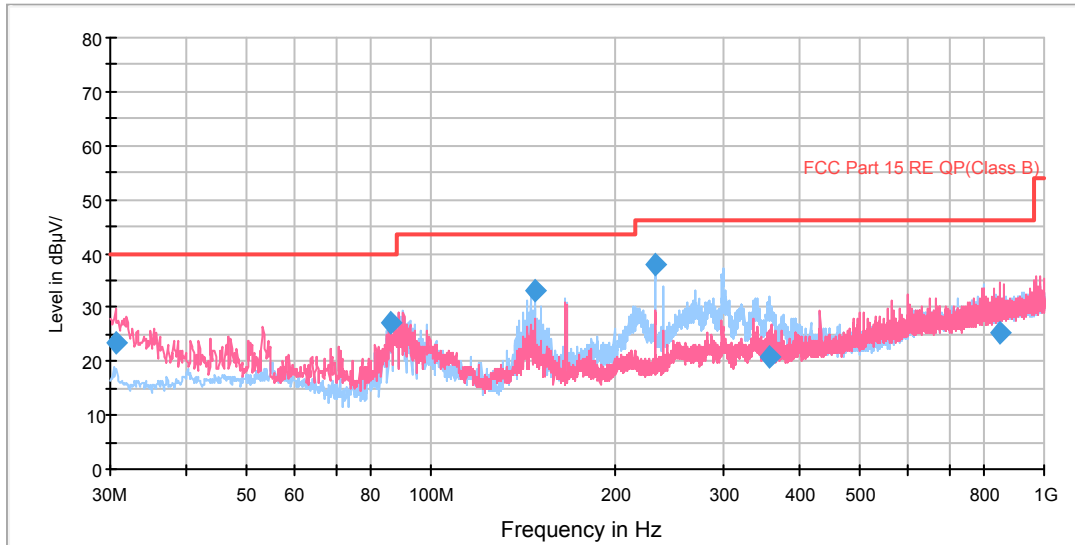

Radiates Emission from 30MHz to 1GHz

Frequency (MHz)	Quasi-Peak (dBuV/m)	Height (cm)	Polarization	Azimuth (deg)	Reading value (dBuV/m)	Correct Factor (dB)	Margin (dB)	Limit (dBuV/m)
30.606250	23.4	100.0	V	300.0	35.3	-11.9	16.6	40.0
86.057500	27.2	125.0	V	135.0	37.8	-10.6	12.8	40.0
148.137500	33.2	125.0	H	20.0	42.3	-9.1	10.3	43.5
232.371250	37.8	125.0	H	268.0	51.2	-13.4	8.2	46.0
356.077500	20.9	100.0	H	197.0	37.7	-16.8	25.1	46.0
845.685000	25.3	114.0	V	279.0	50.2	-24.9	20.7	46.0

- Remark: 1. Quasi-Peak = Reading value + Correction factor
 2. Correction Factor = Antenna factor+ Insertion loss(cable loss+amplifier gain)
 3. Margin = Limit – Quasi-Peak

RE 1G-3GHz PK+AV

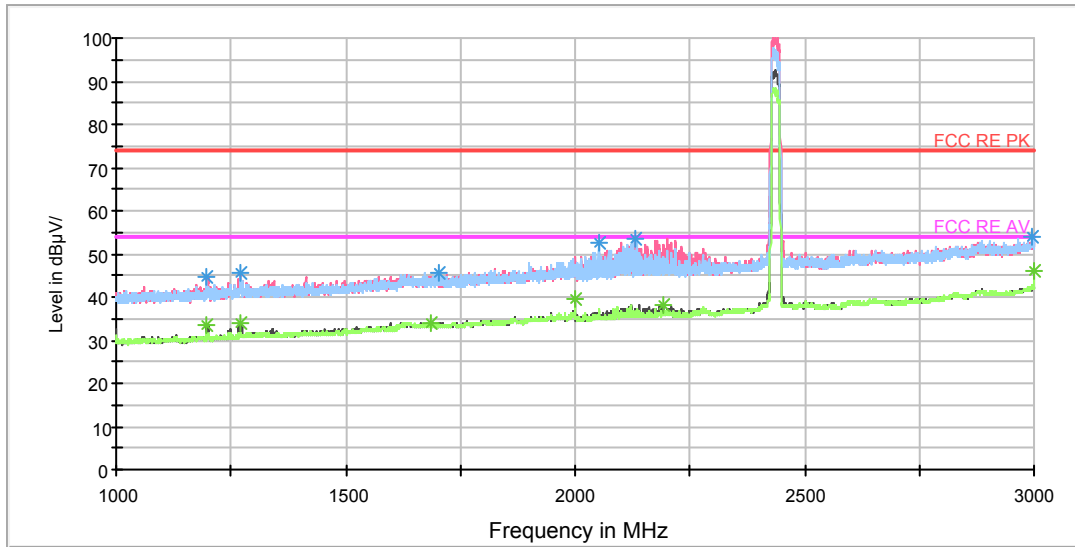

Note: The signal beyond the limit is carrier.
Radiates Emission from 1GHz to 3GHz

Frequency (MHz)	Peak (dBuV/m)	Height (cm)	Polarization	Azimuth (deg)	Reading value (dBuV/m)	Correct Factor (dB)	Margin (dB)	Limit (dBuV/m)
1197.000000	44.9	101.0	V	326.0	53.1	-8.2	29.1	74
1270.250000	45.5	101.0	V	357.0	53.2	-7.7	28.5	74
1703.000000	45.6	101.0	H	218.0	50.5	-4.9	28.4	74
2050.250000	52.4	101.0	H	305.0	55.6	-3.2	21.6	74
2132.500000	53.5	101.0	V	340.0	55.9	-2.4	20.5	74
2995.250000	53.8	101.0	H	0.0	56.1	-2.3	20.2	74

Remark: 1. Correction Factor = Antenna factor+ Insertion loss (cable loss + amplifier gain)

Frequency (MHz)	Average (dBuV/m)	Height (cm)	Polarization	Azimuth (deg)	Reading value (dBuV/m)	Correct Factor (dB)	Margin (dB)	Limit (dBuV/m)
1198.250000	33.6	101.0	V	267.0	41.8	-8.2	20.4	54
1270.500000	33.9	101.0	V	357.0	41.6	-7.7	20.1	54
1683.500000	34.2	101.0	V	35.0	39.2	-5.0	19.8	54
2000.000000	39.4	101.0	V	61.0	42.8	-3.4	14.6	54
2190.750000	38.1	101.0	V	315.0	40.3	-2.2	15.9	54
3000.000000	45.9	101.0	V	200.0	48.2	-2.3	8.1	54

Remark: 1. Correction Factor = Antenna factor+ Insertion loss (cable loss + amplifier gain)

RE 3-18GHz PK+AV

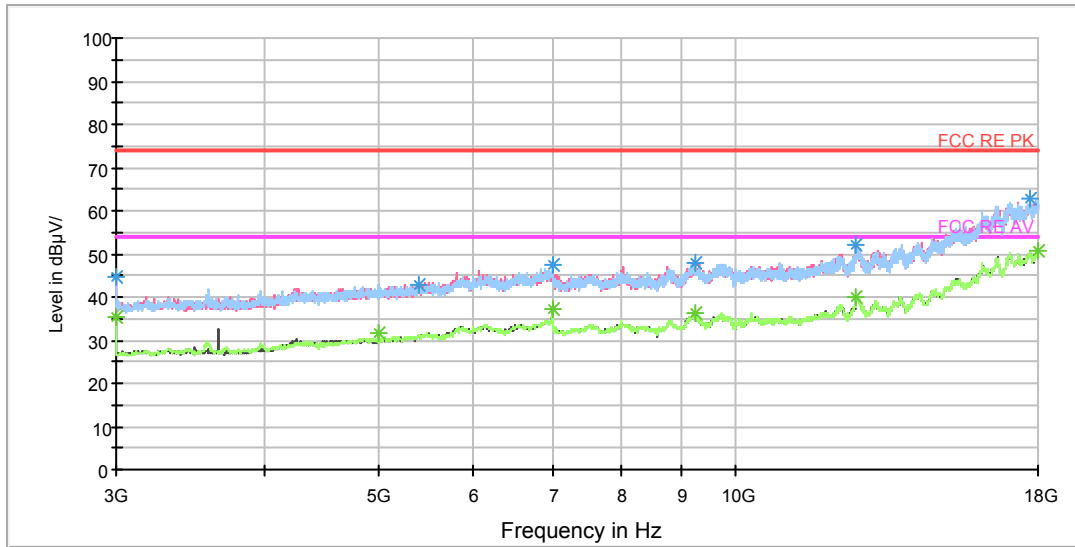

Radiates Emission from 3GHz to 18GHz

Frequency (MHz)	Peak (dBuV/m)	Height (cm)	Polarization	Azimuth (deg)	Reading value (dBuV/m)	Correct Factor (dB)	Margin (dB)	Limit (dBuV/m)
3000.000000	44.7	101.0	H	0.0	47.9	-3.2	29.3	74
5394.375000	42.9	101.0	V	0.0	45.3	-2.4	31.1	74
6999.375000	47.3	101.0	H	6.0	53.8	-6.5	26.7	74
9249.375000	48.1	101.0	V	219.0	57.8	-9.7	25.9	74
12639.375000	52.2	101.0	V	192.0	66.7	-14.5	21.8	74
17709.375000	62.7	101.0	H	34.0	87.4	-24.7	11.3	74

Remark: 1. Correction Factor = Antenna factor+ Insertion loss (cable loss + amplifier gain)

Frequency (MHz)	Average (dBuV/m)	Height (cm)	Polarization	Azimuth (deg)	Reading value (dBuV/m)	Correct Factor (dB)	Margin (dB)	Limit (dBuV/m)
3000.000000	35.2	101.0	H	0.0	38.4	-3.2	18.8	54
4998.750000	31.5	101.0	H	279.0	33.1	-1.6	22.5	54
6999.375000	37.2	101.0	V	0.0	43.7	-6.5	16.8	54
9238.125000	36.2	101.0	V	219.0	46.1	-9.9	17.8	54
12641.250000	40.2	101.0	V	354.0	54.7	-14.5	13.8	54
17992.500000	50.7	101.0	V	0.0	76.0	-25.3	3.3	54

Remark: 1. Correction Factor = Antenna factor+ Insertion loss (cable loss + amplifier gain)

RE 18-26.5GHz PK+AV

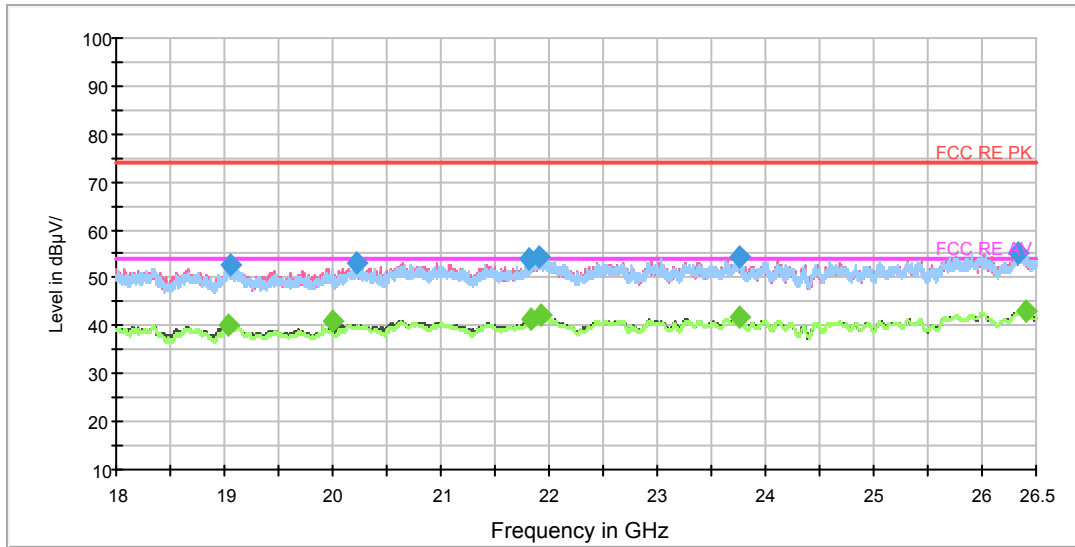

Radiates Emission from 18GHz to 26.5GHz

Frequency (MHz)	Peak (dBuV/m)	Polarization	Azimuth (deg)	Reading value (dBuV/m)	Correct Factor (dB)	Margin (dB)	Limit (dBuV/m)
19049.750000	52.7	V	55.0	57.9	-5.2	21.3	74
20220.625000	53.3	V	299.0	59.2	-5.9	20.7	74
21808.000000	54.1	V	0.0	62.1	-8.0	19.9	74
21901.500000	54.4	H	68.0	62.4	-8.0	19.6	74
23750.250000	54.3	H	68.0	60.2	-5.9	19.7	74
26333.187500	55.4	V	232.0	60.8	-5.4	18.6	74

Remark: 1. Correction Factor = Antenna factor+ Insertion loss (cable loss + amplifier gain)

Frequency (MHz)	Average (dBuV/m)	Polarization	Azimuth (deg)	Reading value (dBuV/m)	Correct Factor (dB)	Margin (dB)	Limit (dBuV/m)
19044.437500	40.3	V	325.0	45.5	-5.2	13.7	54
20000.687500	40.9	V	0.0	46.6	-5.7	13.1	54
21838.812500	41.2	V	259.0	49.2	-8.0	12.8	54
21923.812500	42.1	V	69.0	50.1	-8.0	11.9	54
23753.437500	41.9	V	339.0	47.8	-5.9	12.1	54
26401.187500	43.1	V	312.0	48.5	-5.4	10.9	54

Remark: 1. Correction Factor = Antenna factor+ Insertion loss (cable loss + amplifier gain)



SISO Antenna 3 802.11g CH11

FCC RE 0.03-1GHz QP Class B

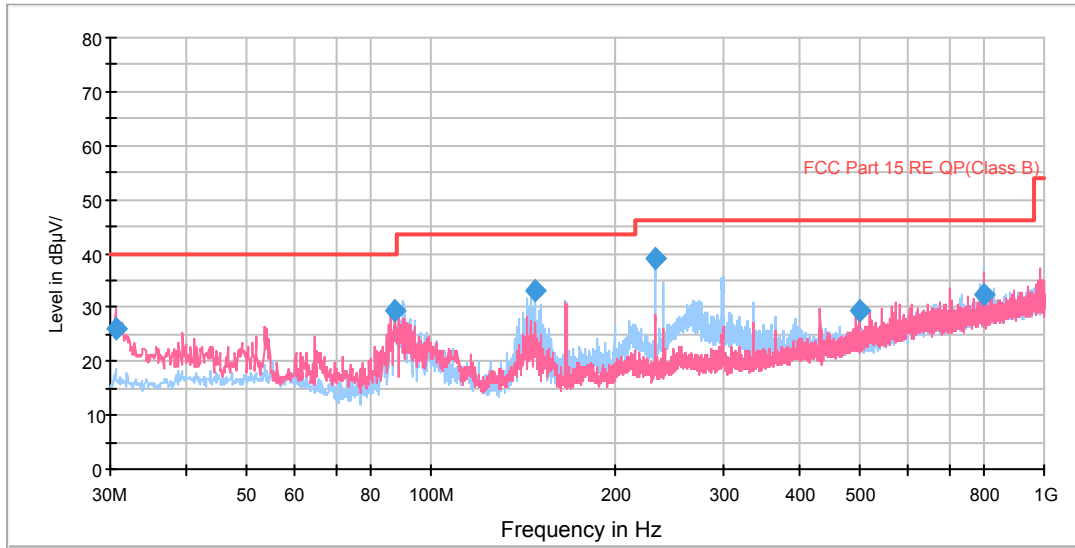

Radiates Emission from 30MHz to 1GHz

Frequency (MHz)	Quasi-Peak (dBuV/m)	Height (cm)	Polarization	Azimuth (deg)	Reading value (dBuV/m)	Correct Factor (dB)	Margin (dB)	Limit (dBuV/m)
30.606250	25.9	100.0	V	209.0	37.8	-11.9	14.1	40.0
87.633750	29.2	125.0	H	243.0	40.3	-11.1	10.8	40.0
148.137500	33.1	125.0	H	25.0	42.2	-9.1	10.4	43.5
232.371250	39.0	125.0	H	267.0	52.4	-13.4	7.0	46.0
500.005000	29.6	114.0	V	293.0	49.5	-19.9	16.4	46.0
798.161250	32.3	125.0	H	17.0	56.6	-24.3	13.7	46.0

- Remark: 1. Quasi-Peak = Reading value + Correction factor
 2. Correction Factor = Antenna factor+ Insertion loss(cable loss+amplifier gain)
 3. Margin = Limit – Quasi-Peak

RE 1G-3GHz PK+AV

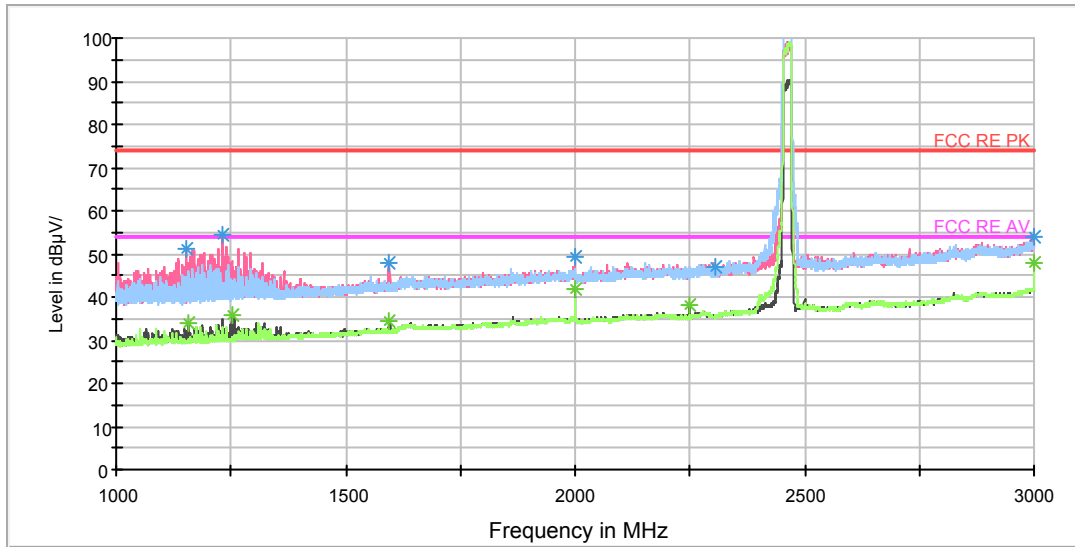

Note: The signal beyond the limit is carrier.
Radiates Emission from 1GHz to 3GHz

Frequency (MHz)	Peak (dBuV/m)	Height (cm)	Polarization	Azimuth (deg)	Reading value (dBuV/m)	Correct Factor (dB)	Margin (dB)	Limit (dBuV/m)
1151.000000	50.9	102.0	V	81.0	59.4	-8.5	23.1	74
1229.750000	54.2	102.0	V	81.0	61.9	-7.7	19.8	74
1596.000000	47.9	102.0	V	46.0	54.3	-6.4	26.1	74
1999.750000	49.5	202.0	V	148.0	52.9	-3.4	24.5	74
3000.000000	54.1	102.0	V	0.0	56.4	-2.3	19.9	74
2305.000000	47.1	102.0	V	225.0	49.2	-2.1	26.9	74

Remark: 1. Correction Factor = Antenna factor+ Insertion loss (cable loss + amplifier gain)

Frequency (MHz)	Average (dBuV/m)	Height (cm)	Polarization	Azimuth (deg)	Reading value (dBuV/m)	Correct Factor (dB)	Margin (dB)	Limit (dBuV/m)
1156.250000	33.7	102.0	V	81.0	42.1	-8.4	20.3	54
1251.750000	35.8	102.0	V	92.0	43.8	-8.0	18.2	54
1596.000000	34.5	102.0	V	46.0	40.9	-6.4	19.5	54
2000.000000	41.9	202.0	V	64.0	45.3	-3.4	12.1	54
3000.000000	48.1	202.0	V	179.0	50.4	-2.3	5.9	54
2250.000000	38.3	202.0	V	148.0	40.6	-2.3	15.7	54

Remark: 1. Correction Factor = Antenna factor+ Insertion loss (cable loss + amplifier gain)

RE 3-18GHz PK+AV

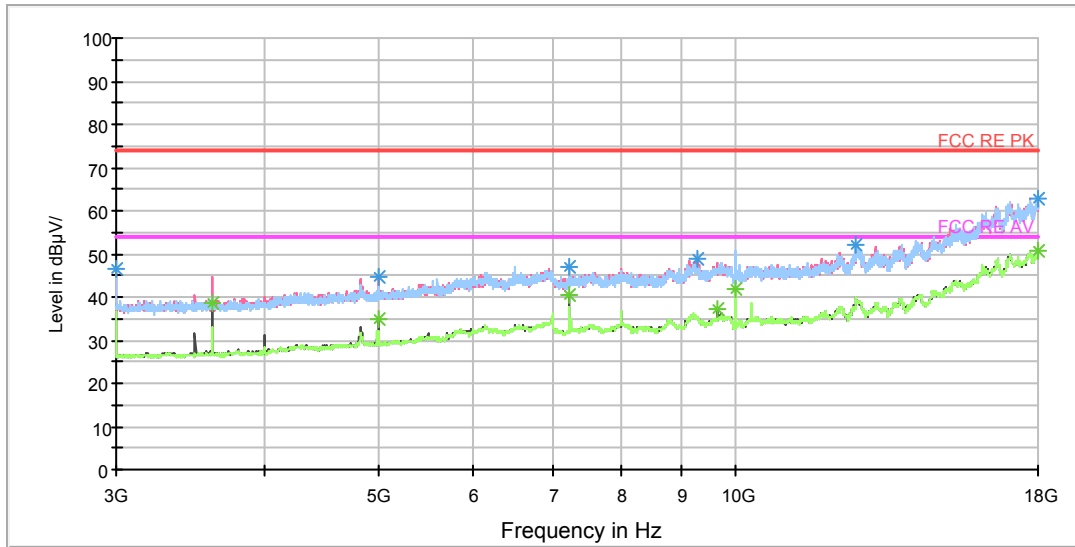

Radiates Emission from 3GHz to 18GHz

Frequency (MHz)	Peak (dBuV/m)	Height (cm)	Polarization	Azimuth (deg)	Reading value (dBuV/m)	Correct Factor (dB)	Margin (dB)	Limit (dBuV/m)
3000.000000	46.7	202.0	V	17.0	49.9	-3.2	27.3	74
4998.750000	44.8	202.0	V	341.0	46.4	-1.6	29.2	74
7235.625000	46.9	102.0	V	0.0	53.7	-6.8	27.1	74
9271.875000	48.9	202.0	V	198.0	58.2	-9.3	25.1	74
12648.750000	51.9	202.0	H	251.0	66.1	-14.2	22.1	74
17977.500000	62.8	202.0	V	108.0	87.7	-24.9	11.2	74

Remark: 1. Correction Factor = Antenna factor+ Insertion loss (cable loss + amplifier gain)

Frequency (MHz)	Average (dBuV/m)	Height (cm)	Polarization	Azimuth (deg)	Reading value (dBuV/m)	Correct Factor (dB)	Margin (dB)	Limit (dBuV/m)
3616.875000	38.7	202.0	V	315.0	40.7	-2.0	15.3	54
4998.750000	34.7	202.0	V	341.0	36.3	-1.6	19.3	54
7235.625000	40.7	102.0	V	0.0	47.5	-6.8	13.3	54
9648.750000	37.1	202.0	V	0.0	46.9	-9.8	16.9	54
10001.250000	42.1	102.0	H	315.0	51.8	-9.7	11.9	54
18000.000000	50.7	102.0	V	0.0	76.2	-25.5	3.3	54

Remark: 1. Correction Factor = Antenna factor+ Insertion loss (cable loss + amplifier gain)

RE 18-26.5GHz PK+AV

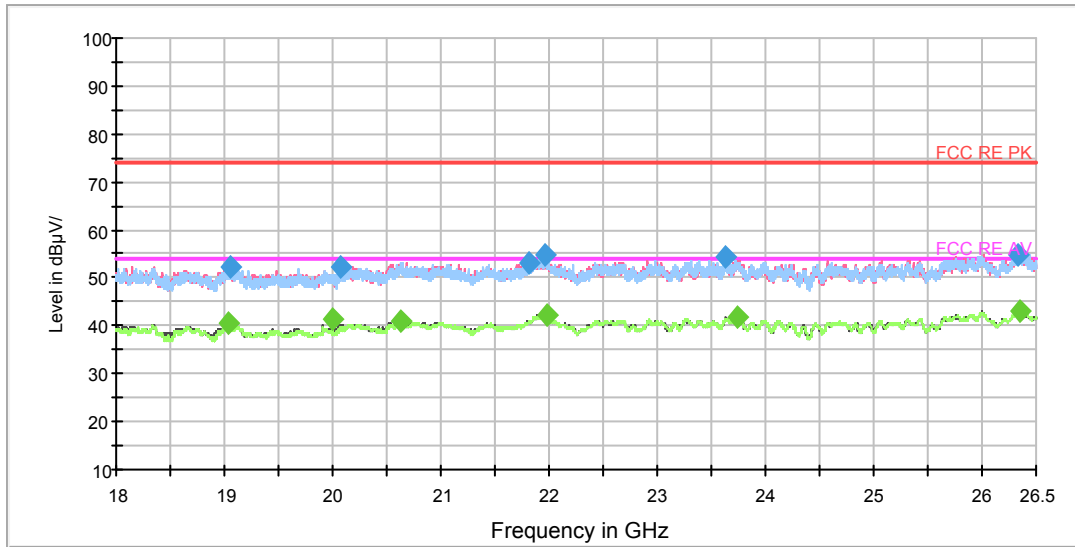

Radiates Emission from 18GHz to 26.5GHz

Frequency (MHz)	Peak (dBuV/m)	Polarization	Azimuth (deg)	Reading value (dBuV/m)	Correct Factor (dB)	Margin (dB)	Limit (dBuV/m)
19048.687500	52.4	V	343.0	57.6	-5.2	21.6	74
20077.187500	52.4	V	0.0	58.1	-5.7	21.6	74
21823.937500	53.3	H	99.0	61.3	-8.0	20.7	74
21963.125000	54.7	H	0.0	62.7	-8.0	19.3	74
23636.562500	54.4	V	127.0	60.3	-5.9	19.6	74
26341.687500	55.0	V	97.0	60.4	-5.4	19.0	74

Remark: 1. Correction Factor = Antenna factor+ Insertion loss (cable loss + amplifier gain)

Frequency (MHz)	Average (dBuV/m)	Polarization	Azimuth (deg)	Reading value (dBuV/m)	Correct Factor (dB)	Margin (dB)	Limit (dBuV/m)
19034.875000	40.5	H	59.0	45.6	-5.1	13.5	54
20000.687500	41.3	H	31.0	47.0	-5.7	12.7	54
20628.625000	41.0	H	0.0	47.5	-6.5	13.0	54
21978.000000	42.2	V	154.0	50.2	-8.0	11.8	54
23741.750000	41.8	V	97.0	47.7	-5.9	12.2	54
26360.812500	43.0	V	154.0	48.4	-5.4	11.0	54

Remark: 1. Correction Factor = Antenna factor+ Insertion loss (cable loss + amplifier gain)

MIMO

802.11n (HT20) CH1

FCC RE 0.03-1GHz QP Class B

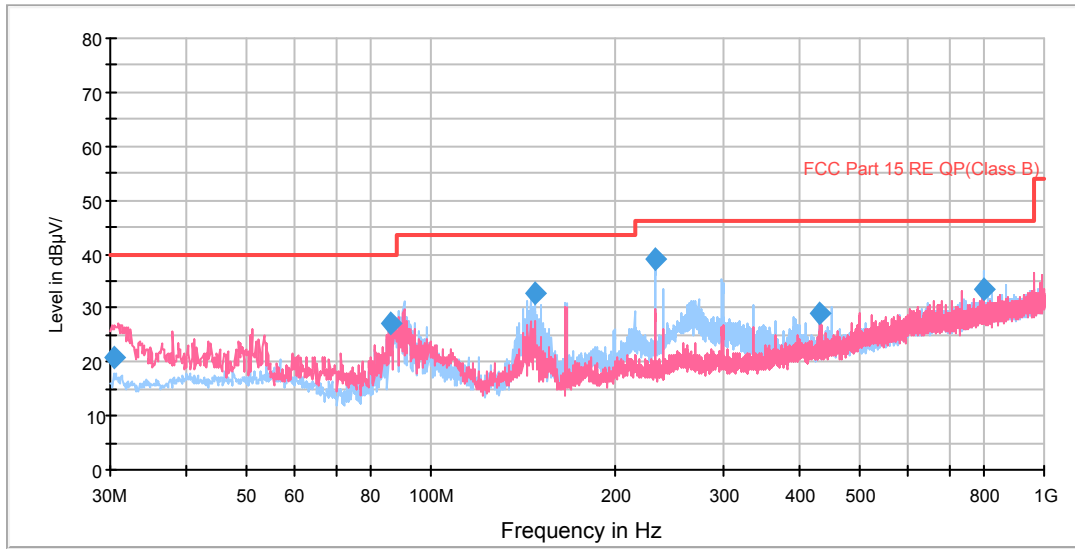

Radiates Emission from 30MHz to 1GHz

Frequency (MHz)	Quasi-Peak (dBuV/m)	Height (cm)	Polarization	Azimuth (deg)	Reading value (dBuV/m)	Correct Factor (dB)	Margin (dB)	Limit (dBuV/m)
30.410000	21.0	100.0	V	281.0	32.9	-11.9	19.0	40.0
86.057500	27.0	125.0	V	114.0	37.6	-10.6	13.0	40.0
148.137500	32.9	125.0	H	35.0	42.0	-9.1	10.6	43.5
232.366250	39.1	125.0	H	266.0	52.5	-13.4	6.9	46.0
431.985000	28.9	125.0	V	175.0	47.5	-18.6	17.1	46.0
798.201250	33.4	125.0	H	17.0	57.7	-24.3	12.6	46.0

- Remark:**
1. Quasi-Peak = Reading value + Correction factor
 2. Correction Factor = Antenna factor+ Insertion loss(cable loss+amplifier gain)
 3. Margin = Limit – Quasi-Peak

RE 1G-3GHz PK+AV

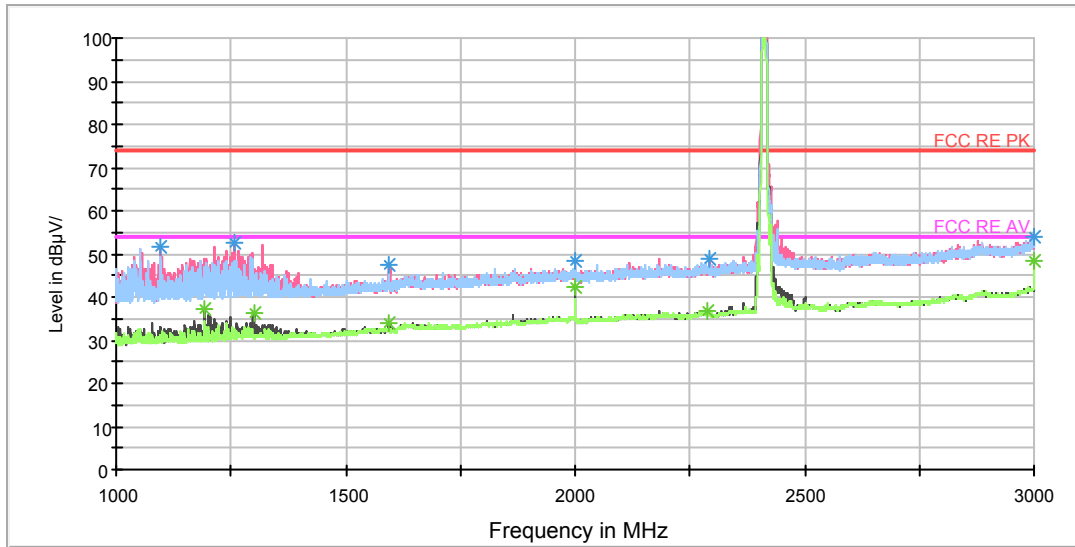

Note: The signal beyond the limit is carrier.
Radiates Emission from 1GHz to 3GHz

Frequency (MHz)	Peak (dBuV/m)	Height (cm)	Polarization	Azimuth (deg)	Reading value (dBuV/m)	Correct Factor (dB)	Margin (dB)	Limit (dBuV/m)
1097.000000	51.5	101.0	V	74.0	60.4	-8.9	22.5	74
1255.750000	52.4	101.0	V	86.0	60.3	-7.9	21.6	74
1595.500000	47.6	101.0	V	248.0	54.0	-6.4	26.4	74
2000.250000	48.2	101.0	V	74.0	51.6	-3.4	25.8	74
3000.000000	54.2	101.0	V	0.0	56.5	-2.3	19.8	74
2293.250000	48.8	101.0	V	0.0	50.7	-1.9	25.2	74

Remark: 1. Correction Factor = Antenna factor+ Insertion loss (cable loss + amplifier gain)

Frequency (MHz)	Average (dBuV/m)	Height (cm)	Polarization	Azimuth (deg)	Reading value (dBuV/m)	Correct Factor (dB)	Margin (dB)	Limit (dBuV/m)
1193.500000	37.0	101.0	V	36.0	45.2	-8.2	17.0	54
1299.750000	36.2	101.0	V	99.0	44.1	-7.9	17.8	54
1594.750000	34.0	101.0	V	195.0	40.4	-6.4	20.0	54
2000.000000	42.4	202.0	V	152.0	45.8	-3.4	11.6	54
3000.000000	48.3	202.0	V	184.0	50.6	-2.3	5.7	54
2289.000000	36.5	101.0	V	36.0	38.2	-1.7	17.5	54

Remark: 1. Correction Factor = Antenna factor+ Insertion loss (cable loss + amplifier gain)

RE 3-18GHz PK+AV

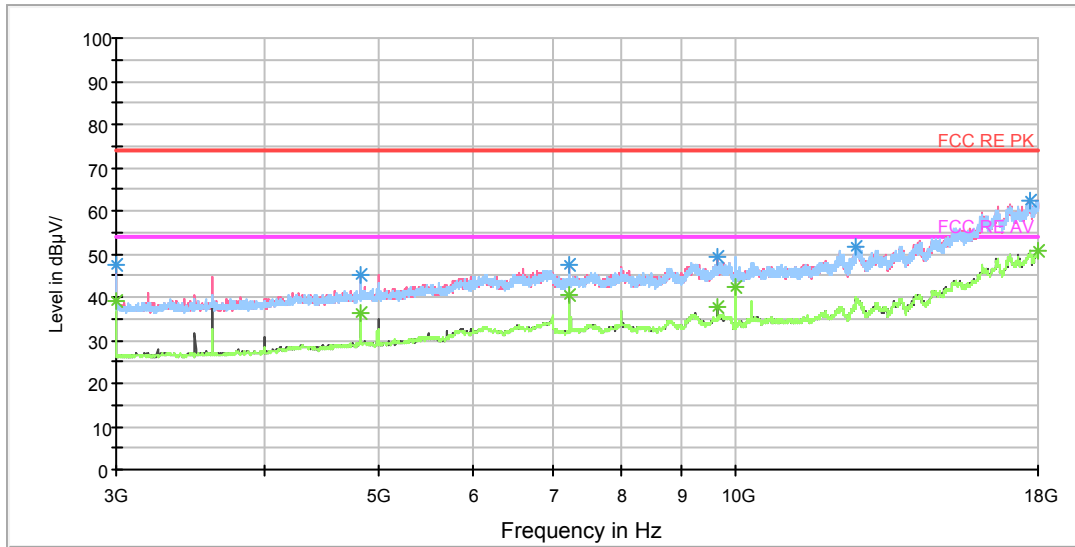

Radiates Emission from 3GHz to 18GHz

Frequency (MHz)	Peak (dBuV/m)	Height (cm)	Polarization	Azimuth (deg)	Reading value (dBuV/m)	Correct Factor (dB)	Margin (dB)	Limit (dBuV/m)
3000.000000	47.3	202.0	V	17.0	50.5	-3.2	26.7	74
4822.500000	45.1	202.0	V	0.0	46.4	-1.3	28.9	74
7235.625000	47.2	102.0	V	44.0	54.0	-6.8	26.8	74
9646.875000	49.1	202.0	V	0.0	58.9	-9.8	24.9	74
12650.625000	51.7	102.0	H	86.0	65.8	-14.1	22.3	74
17707.500000	62.3	202.0	V	0.0	87.0	-24.7	11.7	74

Remark: 1. Correction Factor = Antenna factor+ Insertion loss (cable loss + amplifier gain)

Frequency (MHz)	Average (dBuV/m)	Height (cm)	Polarization	Azimuth (deg)	Reading value (dBuV/m)	Correct Factor (dB)	Margin (dB)	Limit (dBuV/m)
3000.000000	39.0	202.0	V	17.0	42.2	-3.2	15.0	54
4822.500000	36.1	202.0	V	0.0	37.4	-1.3	17.9	54
7235.625000	40.5	102.0	V	44.0	47.3	-6.8	13.5	54
9648.750000	37.8	202.0	V	0.0	47.6	-9.8	16.2	54
10001.250000	42.3	102.0	H	293.0	52.0	-9.7	11.7	54
18000.000000	50.8	202.0	V	17.0	76.3	-25.5	3.2	54

Remark: 1. Correction Factor = Antenna factor+ Insertion loss (cable loss + amplifier gain)

RE 18-26.5GHz PK+AV

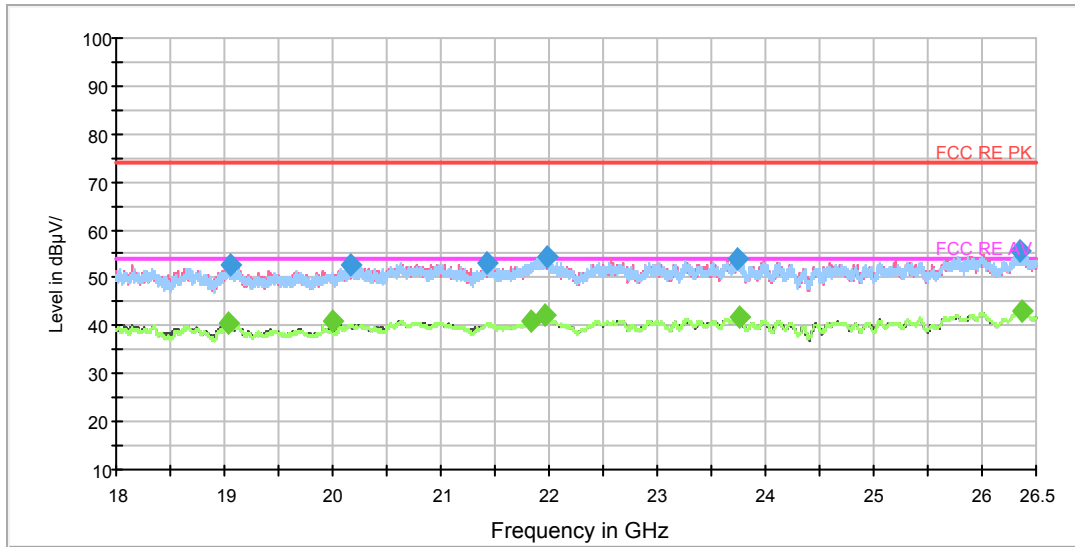

Radiates Emission from 18GHz to 26.5GHz

Frequency (MHz)	Peak (dBuV/m)	Polarization	Azimuth (deg)	Reading value (dBuV/m)	Correct Factor (dB)	Margin (dB)	Limit (dBuV/m)
19050.812500	52.6	H	35.0	57.8	-5.2	21.4	74
20160.062500	52.7	V	0.0	58.5	-5.8	21.3	74
21426.562500	53.2	H	209.0	61.2	-8.0	20.8	74
21989.687500	54.4	H	0.0	62.4	-8.0	19.6	74
23733.250000	54.0	V	218.0	59.9	-5.9	20.0	74
26358.687500	55.6	H	89.0	61.0	-5.4	18.4	74

Remark: 1. Correction Factor = Antenna factor+ Insertion loss (cable loss + amplifier gain)

Frequency (MHz)	Average (dBuV/m)	Polarization	Azimuth (deg)	Reading value (dBuV/m)	Correct Factor (dB)	Margin (dB)	Limit (dBuV/m)
19031.687500	40.4	V	245.0	45.5	-5.1	13.6	54
20000.687500	41.0	H	9.0	46.7	-5.7	13.0	54
21838.812500	41.2	V	0.0	49.2	-8.0	12.8	54
21969.500000	42.3	V	69.0	50.3	-8.0	11.7	54
23755.562500	41.8	H	195.0	47.7	-5.9	12.2	54
26372.500000	43.0	H	0.0	48.4	-5.4	11.0	54

Remark: 1. Correction Factor = Antenna factor+ Insertion loss (cable loss + amplifier gain)



802.11n (HT20) CH6

FCC RE 0.03-1GHz QP Class C

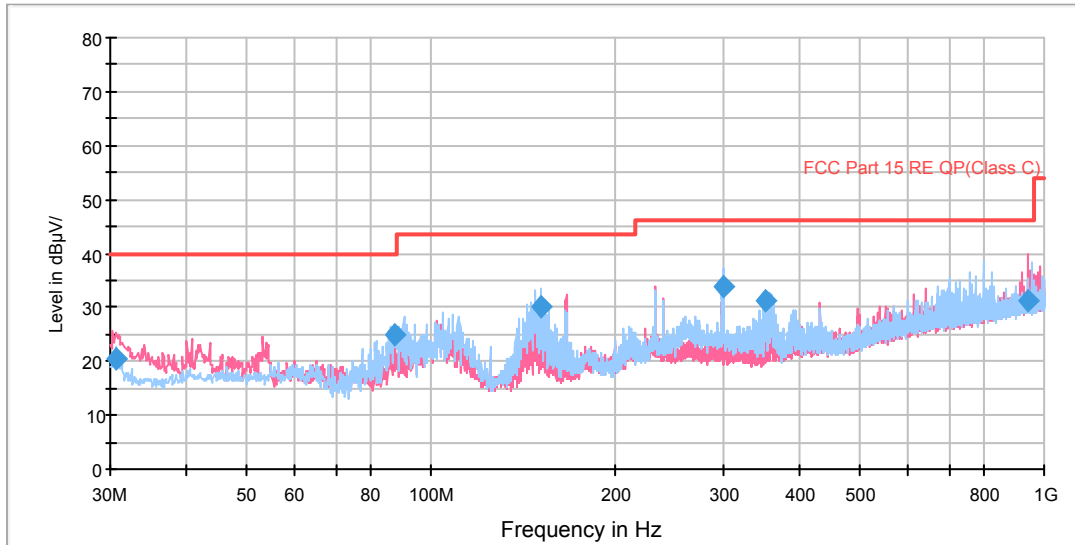

Radiates Emission from 30MHz to 1GHz

Frequency (MHz)	Quasi-Peak (dBuV/m)	Height (cm)	Polarization	Azimuth (deg)	Reading value (dBuV/m)	Correct Factor (dB)	Margin (dB)	Limit (dBuV/m)
30.640000	20.5	100.0	V	0.0	32.4	-11.9	19.5	40.0
87.633750	25.1	200.0	H	179.0	36.2	-11.1	14.9	40.0
151.572500	30.3	189.0	H	34.0	39.5	-9.2	13.2	43.5
299.296250	33.9	100.0	H	269.0	49.3	-15.4	12.1	46.0
351.878750	31.1	100.0	H	283.0	47.8	-16.7	14.9	46.0
940.056250	31.1	114.0	V	265.0	57.1	-26.0	14.9	46.0

- Remark: 1. Quasi-Peak = Reading value + Correction factor
 2. Correction Factor = Antenna factor+ Insertion loss(cable loss+amplifier gain)
 3. Margin = Limit – Quasi-Peak

RE 1G-3GHz PK+AV

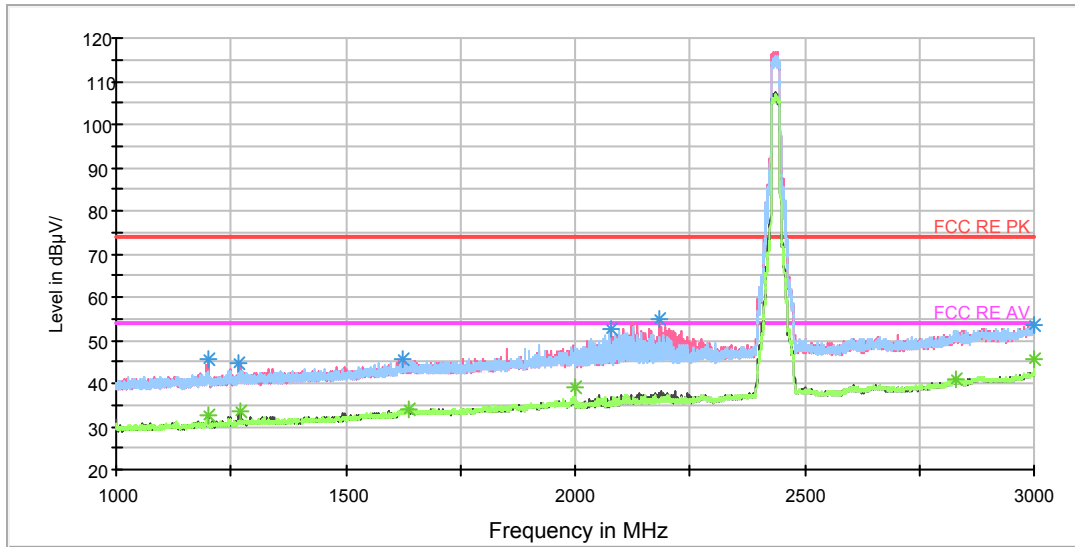

Note: The signal beyond the limit is carrier.
Radiates Emission from 1GHz to 3GHz

Frequency (MHz)	Peak (dBuV/m)	Height (cm)	Polarization	Azimuth (deg)	Reading value (dBuV/m)	Correct Factor (dB)	Margin (dB)	Limit (dBuV/m)
1199.000000	45.7	101.0	V	340.0	53.9	-8.2	28.3	74
1268.000000	44.7	101.0	V	347.0	52.4	-7.7	29.3	74
1624.500000	45.5	101.0	V	335.0	50.3	-4.8	28.5	74
2079.000000	52.4	101.0	V	329.0	55.4	-3.0	21.6	74
2185.250000	55.0	101.0	V	0.0	57.2	-2.2	19.0	74
2998.000000	53.5	101.0	V	152.0	55.8	-2.3	20.5	74

Remark: 1. Correction Factor = Antenna factor+ Insertion loss (cable loss + amplifier gain)

Frequency (MHz)	Average (dBuV/m)	Height (cm)	Polarization	Azimuth (deg)	Reading value (dBuV/m)	Correct Factor (dB)	Margin (dB)	Limit (dBuV/m)
1200.250000	32.6	101.0	V	347.0	40.8	-8.2	21.4	54
1269.250000	33.3	101.0	V	329.0	41.0	-7.7	20.7	54
1639.000000	34.1	101.0	V	212.0	38.8	-4.7	19.9	54
2000.250000	39.2	101.0	V	272.0	42.6	-3.4	14.8	54
2829.250000	41.0	101.0	V	347.0	42.6	-1.6	13.0	54
3000.000000	45.6	101.0	H	6.0	47.9	-2.3	8.4	54

Remark: 1. Correction Factor = Antenna factor+ Insertion loss (cable loss + amplifier gain)



RE 3-18GHz PK+AV

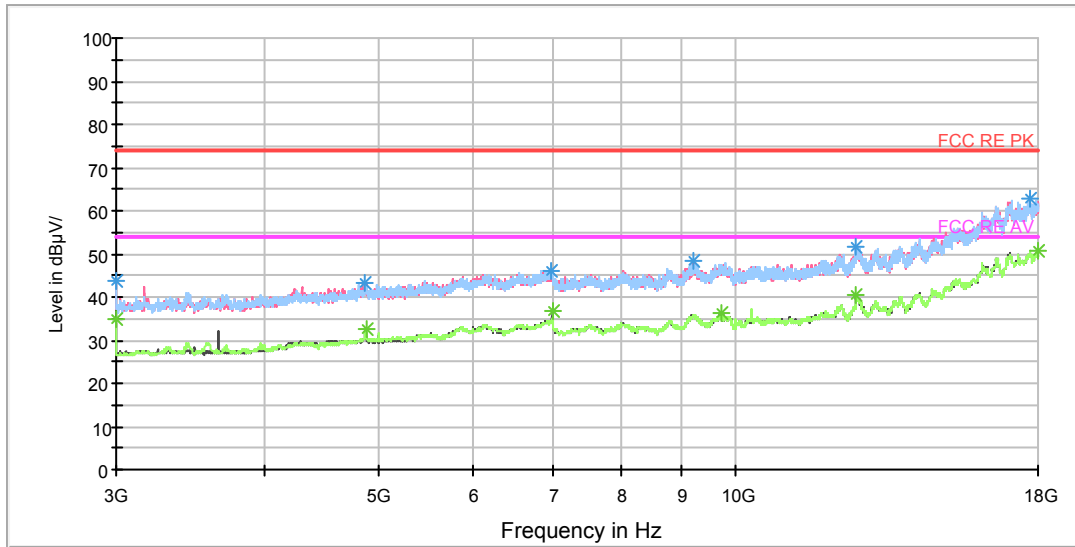

Radiates Emission from 3GHz to 18GHz

Frequency (MHz)	Peak (dBuV/m)	Height (cm)	Polarization	Azimuth (deg)	Reading value (dBuV/m)	Correct Factor (dB)	Margin (dB)	Limit (dBuV/m)
3000.000000	43.8	101.0	H	0.0	47.0	-3.2	30.2	74
4865.625000	43.4	101.0	V	221.0	45.1	-1.7	30.6	74
6986.250000	46.1	101.0	H	0.0	52.5	-6.4	27.9	74
9215.625000	48.2	101.0	V	248.0	58.2	-10.0	25.8	74
12631.875000	51.5	101.0	V	302.0	65.1	-13.6	22.5	74
17711.250000	62.6	101.0	H	308.0	87.3	-24.7	11.4	74

Remark: 1. Correction Factor = Antenna factor+ Insertion loss (cable loss + amplifier gain)

Frequency (MHz)	Average (dBuV/m)	Height (cm)	Polarization	Azimuth (deg)	Reading value (dBuV/m)	Correct Factor (dB)	Margin (dB)	Limit (dBuV/m)
3000.000000	35.0	101.0	H	0.0	38.2	-3.2	19.0	54
4873.125000	32.4	101.0	H	0.0	34.2	-1.8	21.6	54
6999.375000	36.8	101.0	V	0.0	43.3	-6.5	17.2	54
9742.500000	36.1	101.0	V	0.0	46.1	-10.0	17.9	54
12641.250000	40.3	101.0	H	166.0	54.8	-14.5	13.7	54
17998.125000	50.8	101.0	H	0.0	76.2	-25.4	3.2	54

Remark: 1. Correction Factor = Antenna factor+ Insertion loss (cable loss + amplifier gain)

RE 18-26.5GHz PK+AV

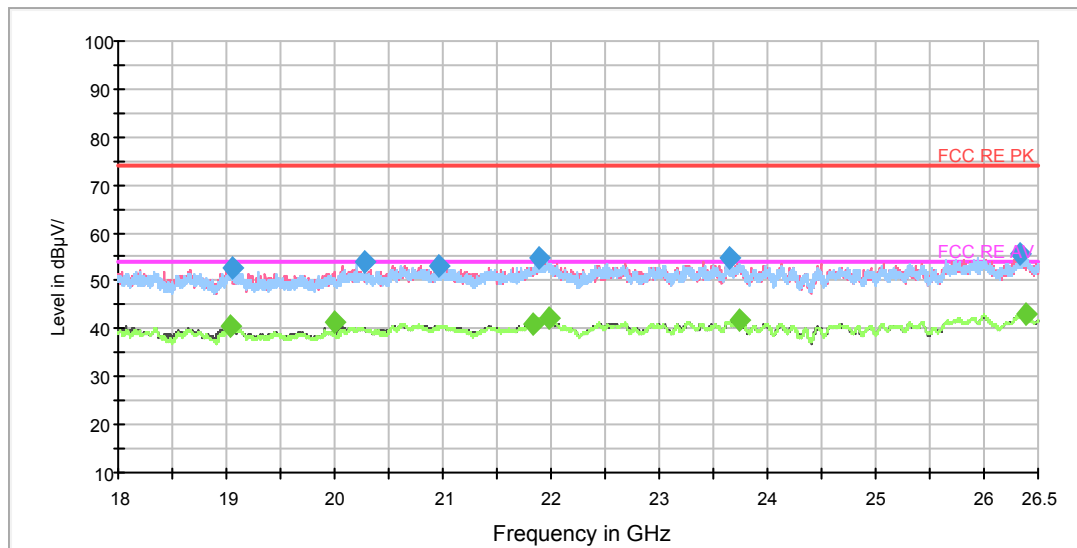

Radiates Emission from 18GHz to 26.5GHz

Frequency (MHz)	Peak (dBuV/m)	Polarization	Azimuth (deg)	Reading value (dBuV/m)	Correct Factor (dB)	Margin (dB)	Limit (dBuV/m)
19052.937500	52.7	H	181.0	57.9	-5.2	21.3	74
20270.562500	53.8	H	0.0	59.7	-5.9	20.2	74
20963.312500	53.1	V	0.0	60.4	-7.3	20.9	74
21886.625000	54.7	H	86.0	62.7	-8.0	19.3	74
23649.312500	54.9	H	99.0	60.8	-5.9	19.1	74
26338.500000	55.7	H	0.0	61.1	-5.4	18.3	74

Remark: 1. Correction Factor = Antenna factor+ Insertion loss (cable loss + amplifier gain)

Frequency (MHz)	Average (dBuV/m)	Polarization	Azimuth (deg)	Reading value (dBuV/m)	Correct Factor (dB)	Margin (dB)	Limit (dBuV/m)
19037.000000	40.5	H	181.0	45.6	-5.1	13.5	54
20000.687500	41.5	V	0.0	47.2	-5.7	12.5	54
21833.500000	41.0	V	83.0	49.0	-8.0	13.0	54
21980.125000	42.4	V	41.0	50.4	-8.0	11.6	54
23749.187500	41.9	H	18.0	47.8	-5.9	12.1	54
26382.062500	43.0	H	140.0	48.4	-5.4	11.0	54

Remark: 1. Correction Factor = Antenna factor+ Insertion loss (cable loss + amplifier gain)

802.11n (HT20) CH11

FCC RE 0.03-1GHz QP Class C

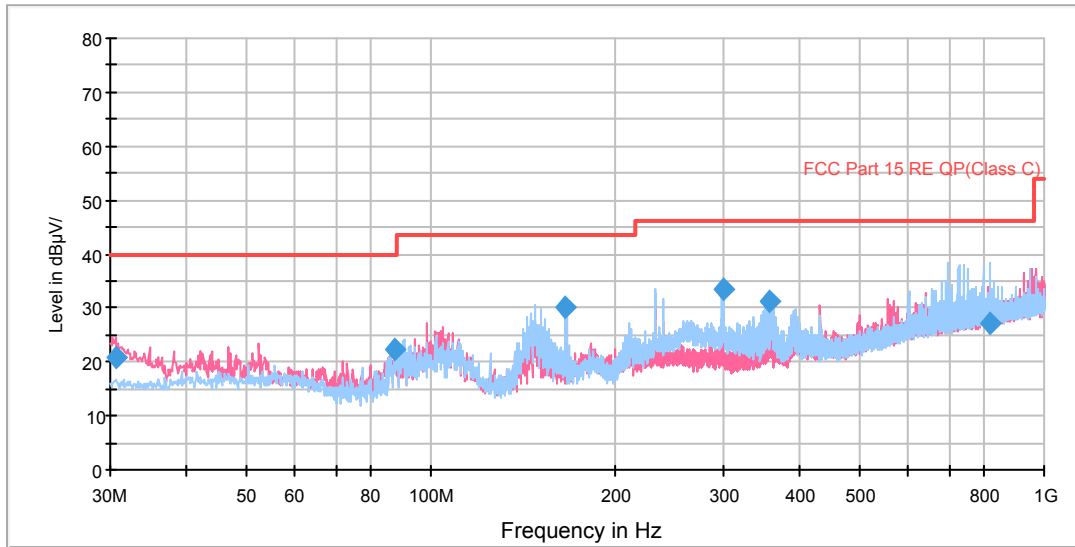

Radiates Emission from 30MHz to 1GHz

Frequency (MHz)	Quasi-Peak (dBuV/m)	Height (cm)	Polarization	Azimuth (deg)	Reading value (dBuV/m)	Correct Factor (dB)	Margin (dB)	Limit (dBuV/m)
30.600000	20.7	100.0	V	25.0	32.6	-11.9	19.3	40.0
87.630000	22.2	125.0	H	339.0	33.3	-11.1	17.8	40.0
166.005000	30.0	100.0	V	247.0	40.0	-10.0	13.5	43.5
299.290000	33.6	100.0	H	266.0	49.0	-15.4	12.4	46.0
356.727500	31.2	100.0	H	283.0	48.0	-16.8	14.8	46.0
816.391250	27.3	100.0	H	241.0	51.9	-24.6	18.7	46.0

- Remark: 1. Quasi-Peak = Reading value + Correction factor
 2. Correction Factor = Antenna factor+ Insertion loss(cable loss+amplifier gain)
 3. Margin = Limit – Quasi-Peak

RE 1G-3GHz PK+AV

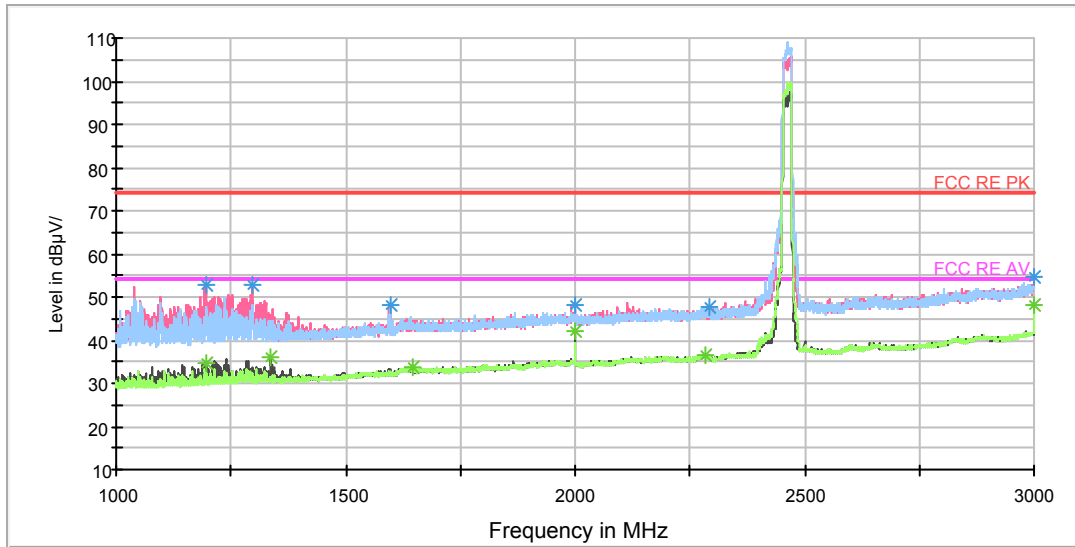

Note: The signal beyond the limit is carrier.

Radiates Emission from 1GHz to 3GHz

Frequency (MHz)	Peak (dBuV/m)	Height (cm)	Polarization	Azimuth (deg)	Reading value (dBuV/m)	Correct Factor (dB)	Margin (dB)	Limit (dBuV/m)
1194.750000	53.0	102.0	V	82.0	61.2	-8.2	21.0	74
1296.000000	52.6	102.0	V	94.0	60.4	-7.8	21.4	74
1596.250000	48.3	102.0	H	54.0	54.7	-6.4	25.7	74
1999.750000	48.0	202.0	H	333.0	51.4	-3.4	26.0	74
3000.000000	54.5	102.0	H	0.0	56.8	-2.3	19.5	74
2290.750000	47.7	102.0	V	0.0	49.5	-1.8	26.3	74

Remark: 1. Correction Factor = Antenna factor+ Insertion loss (cable loss + amplifier gain)

Frequency (MHz)	Average (dBuV/m)	Height (cm)	Polarization	Azimuth (deg)	Reading value (dBuV/m)	Correct Factor (dB)	Margin (dB)	Limit (dBuV/m)
1198.250000	34.5	102.0	V	21.0	42.7	-8.2	19.5	54
1337.750000	35.9	102.0	V	94.0	43.3	-7.4	18.1	54
1646.000000	33.8	102.0	H	65.0	38.7	-4.9	20.2	54
2000.250000	42.1	202.0	V	150.0	45.5	-3.4	11.9	54
3000.000000	48.2	202.0	V	212.0	50.5	-2.3	5.8	54
2283.000000	36.7	202.0	V	108.0	38.1	-1.4	17.3	54

Remark: 1. Correction Factor = Antenna factor+ Insertion loss (cable loss + amplifier gain)