



Part 15B

TEST REPORT

Product Name	GPON ONU
Model Name	I-240W-A
FCC ID	2ADZRI240WA
Applicant	Alcatel-Lucent Shanghai Bell Co., Ltd.
Manufacturer	Shenzhen ZOWEE Technology Co.,Ltd. Bao'an Branch
Date of issue	July 10, 2015

TA Technology (Shanghai) Co., Ltd.

TA Technology (Shanghai) Co., Ltd.
Test Report

Report No.: RBA1505-0061EMC

Page 2 of 20

GENERAL SUMMARY

Reference Standard(s)	FCC Code CFR47 Part15B (2013) Radio frequency device. ANSI C63.4 (2009) Methods of Measurement of Radio-Noise Emission from Low-Voltage Electrical and Electronic Equipment in the Range of 9 KHz to 40GHz.
Conclusion	This portable wireless equipment has been measured in all cases requested by the relevant standards. Test results in Chapter 2 of this test report are below limits specified in the relevant standards. General Judgment : Pass
Comment	The test result only responds to the measured sample.

Approved by Guangchang Fan Revised by Wei Liu Performed by Xianqing Li
Guangchang Fan Wei Liu Xianqing Li
Director EMC Manager EMC Engineer

TA Technology (Shanghai) Co., Ltd.
Test Report

Report No.: RBA1505-0061EMC

Page 3 of 20

TABLE OF CONTENT

1. General Information	4
1.1. Notes of the test report	4
1.2. Testing laboratory	5
1.3. Applicant Information	5
1.4. Manufacturer Information	5
1.5. Information of EUT	6
1.6. Test Date	6
2. Test Information	7
2.1. Summary of test results	7
2.2. Radiated Emission	8
2.3. Conducted Emission	13
3. Main Test Instruments	17
ANNEX A: The EUT Appearance and Test Setup	18
A.1 EUT Appearance	18
A.2 Test Setup	19

TA Technology (Shanghai) Co., Ltd. Test Report

1. General Information

1.1. Notes of the test report

TA Technology (Shanghai) Co., Ltd. has obtained the accreditation of China National Accreditation Service for Conformity Assessment (CNAS), and accreditation number: L2264.

TA Technology (Shanghai) Co., Ltd. has been listed on the US Federal Communications Commission list of test facilities recognized to perform electromagnetic emissions measurements. The site recognition number is 428261.

TA Technology (Shanghai) Co., Ltd. has been listed by industry Canada to perform electromagnetic emission measurement. The site recognition number is 8510A.

TA Technology (Shanghai) Co., Ltd. guarantees the reliability of the data presented in this test report, which is the results of measurements and tests performed for the items under test on the date and under the conditions stated in this test report and is based on the knowledge and technical facilities available at TA Technology (Shanghai) Co., Ltd. at the time of execution of the test.

TA Technology (Shanghai) Co., Ltd. is liable to the client for the maintenance by its personnel of the confidentiality of all information related to the items under test and the results of the test. The sample under test was selected by the Client. This report only refers to the item that has undergone the test.

The test results in this test report relate only to the devices specified in this report. This report shall not be reproduced except in full without the written approval of **TA Technology (Shanghai) Co., Ltd.**

If the electronic report is inconsistent with the printed one, it should be subject to the latter.

TA Technology (Shanghai) Co., Ltd.

Test Report

Report No.: RBA1505-0061EMC

Page 5 of 20

1.2. Testing laboratory

Company: TA Technology (Shanghai) Co., Ltd.
Address: No.145, Jintang Rd, Tangzhen Industry Park, Pudong
City: Shanghai
Post code: 201201
Country: P. R. China
Contact: Xu Kai
Telephone: +86-021-50791141/2/3
Fax: +86-021-50791141/2/3-8000
Website: <http://www.ta-shanghai.com>
E-mail: xukai@ta-shanghai.com

1.3. Applicant Information

Company: Alcatel-Lucent Shanghai Bell CO. Ltd.
6B602,388 Ningqiao Road Pudong,Shanghai
Address: 201206
P.R. China

1.4. Manufacturer Information

Company: Shenzhen ZOWEE Technology Co.,Ltd. Bao'an Branch
Zowee Factory, TongFuYu Industrial Zone. Songgang Street Bao'an District,
Address: Shenzhen, Guangdong,
518105
P.R. China

TA Technology (Shanghai) Co., Ltd.

Test Report

Report No.: RBA1505-0061EMC

Page 6 of 20

1.5. Information of EUT

General information

Model Name:	I-240W-A
Hardware Version:	3FE54861ACAA
Software Version:	3FE54869
Antenna Type:	External Antenna
Used Host Product:	Model :Lenovo X61 /SN : L3-D1224
Test Mode:	LAN Mode

1.6. Test Date

The test is performed from May 14, 2015 to May 25, 2015.

TA Technology (Shanghai) Co., Ltd.
Test Report

Report No.: RBA1505-0061EMC

Page 7 of 20

2. Test Information

2.1. Summary of test results

Number	Test Case	Clause in FCC Rules	conclusion
1	Radiated Emission	15.109, ANSI C63.4-2009	PASS
2	Conducted Emission	15.107, ANSI C63.4-2009	PASS

TA Technology (Shanghai) Co., Ltd.

Test Report

2.2. Radiated Emission

Ambient condition

Temperature	Relative humidity	Pressure
24°C~26°C	45%~50%	102.5kPa

Methods of Measurement

The EUT is placed on a non-metallic table 0.8m above the horizontal metal reference ground plane. The distance between EUT and receive antenna should be 3 meters. During the test, the EUT was operating in its typical mode. The test method is according to ANSI C63.4-2009. Sweep the whole frequency band through the range from 30MHz to the 5th harmonic of the carrier. During the test, the height of receive antenna shall be moved from 1 to 4 meters, and the antenna shall be performed under horizontal and vertical polarization. The turn table shall be rotated from 0 to 360 degrees for detecting the maximum of radiated signal level.

During the test, EUT is connected to a laptop via a LAN cable. The EUT is used as the peripheral equipment of the PC. The model of laptop is Lenovo X61 and the serial number of laptop is L3-D1224. The data is transferred from EUT to PC; PC is connected to server via a long LAN cable.

The data of cable loss and antenna factor has been calibrated in full testing frequency range before the testing. During the test, the EUT is worked at maximum output power.

Set the spectrum analyzer in the following:

Below 1GHz:

RBW=100kHz / VBW=300kHz / Sweep=AUTO

Above 1GHz:

(a) PEAK: RBW=1MHz VBW=3MHz/ Sweep=AUTO

(b) AVERAGE: RBW=1MHz / VBW=10Hz / Sweep=AUTO

TA Technology (Shanghai) Co., Ltd. Test Report

Report No.: RBA1505-0061EMC

Page 9 of 20

Test Setup

Below 1GHz

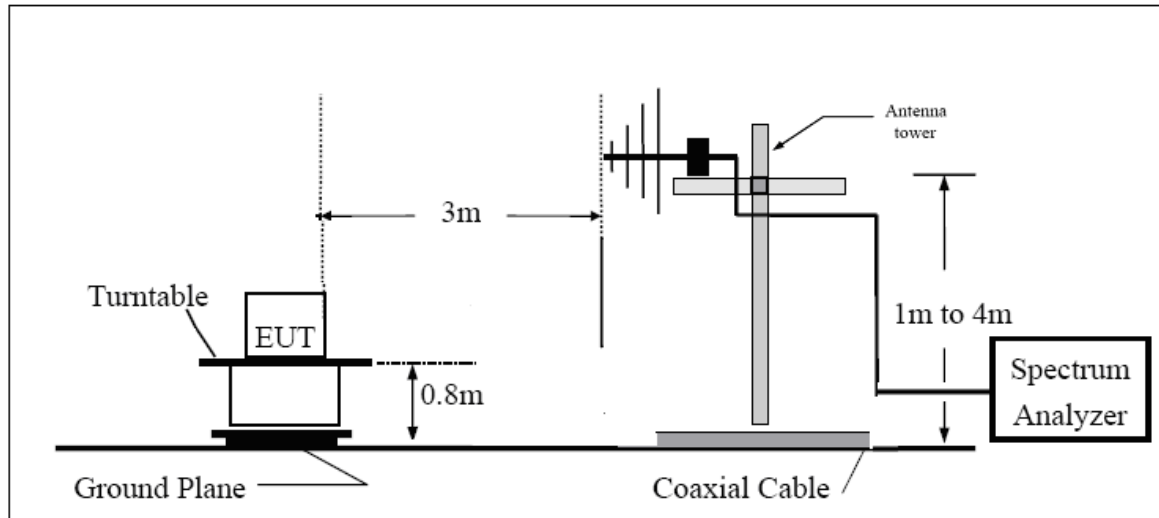

Above 1GHz

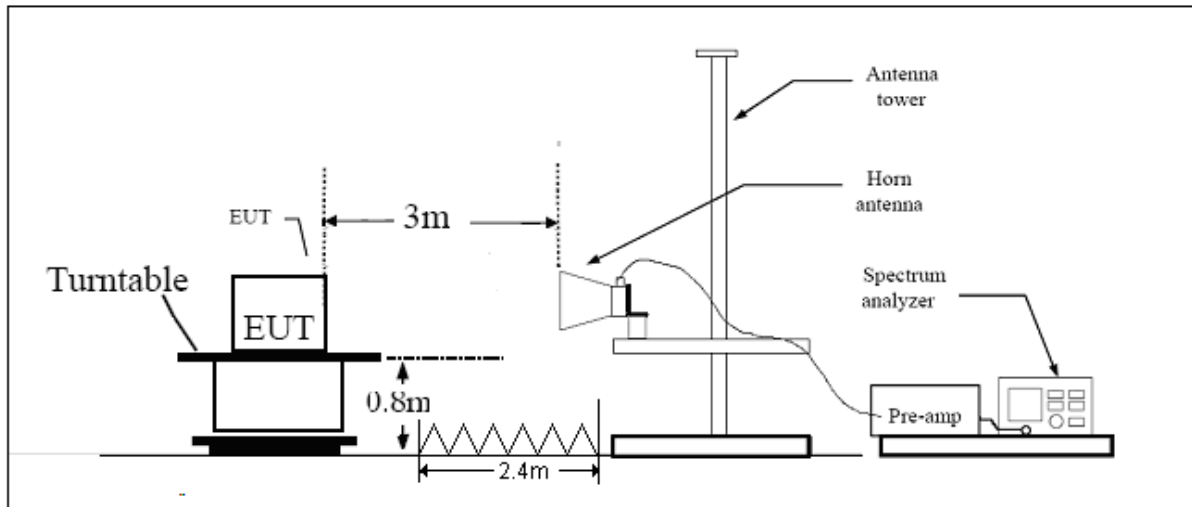

Note: Area side:2.4mX3.6m

TA Technology (Shanghai) Co., Ltd.

Test Report

Report No.: RBA1505-0061EMC

Page 10 of 20

Limits

Frequency (MHz)	Field Strength (dB μ V/m)	Detector
30 -88	40.0	Quasi-peak
88-216	43.5	Quasi-peak
216 – 960	46.0	Quasi-peak
960-1000	54.0	Quasi-peak
1000-5 th harmonic of the highest frequency or 40GHz, which is lower	54 74	Average Peak

Measurement Uncertainty

The assessed measurement uncertainty to ensure 95% confidence level for the normal distribution is with the coverage factor $k = 1.96$. $U = 3.92$ dB.

TA Technology (Shanghai) Co., Ltd. Test Report

Report No.: RBA1505-0061EMC

Page 11 of 20

Test Results

RE 0.03-1GHz QP Class B

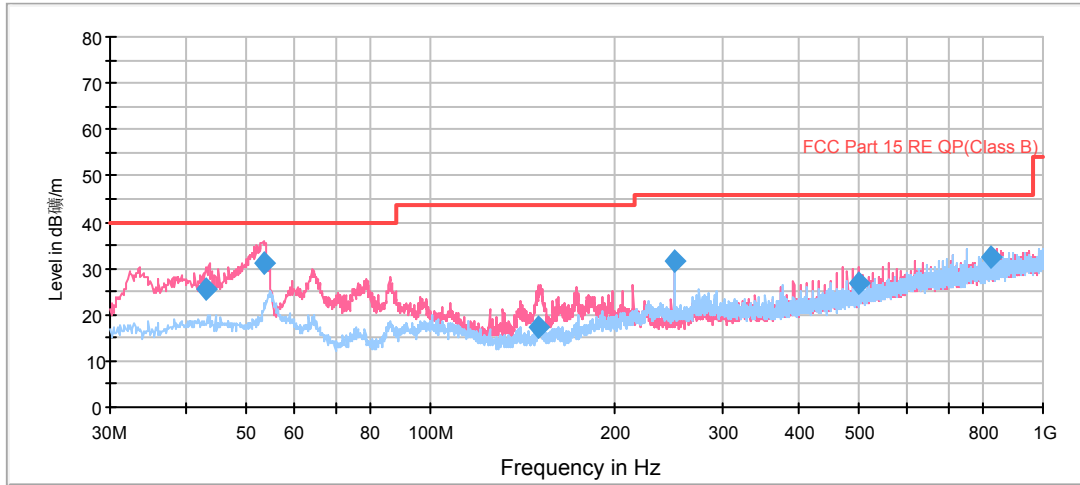

— FCC Part 15 RE QP(Class B) [..]
— Preview Result 1H-PK+ [Preview Result 1H.Result:1]
 ◆ Preview Result 1V-PK+ [Preview Result 1V.Result:1]
◆ Final Result 1-QPK [Final Result 1.Result:1]

Note: This graph displays the maximum values of horizontal and vertical by software

Note: a font (Level in dBuV/m) in the test plot =(level in dBuV/m)

Radiates Emission from 30MHz to 1GHz

Frequency (MHz)	Quasi-Peak (dBuV/m)	Reading value (dBuV/m)	Height (cm)	Polarization	Azimuth (deg)	Correct Factor (dB)	Margin (dB)	Limit (dBuV/m)
43.140000	25.4	38.5	100.0	V	324.0	13.1	14.6	40.0
53.361250	31.2	44.0	100.0	V	59.0	12.8	8.8	40.0
150.483750	17.3	26.4	113.0	V	0.0	9.1	26.2	43.5
249.988750	31.4	45.5	125.0	H	298.0	14.1	14.6	46.0
499.641250	26.7	46.6	100.0	V	346.0	19.9	19.3	46.0
822.895000	32.3	56.9	100.0	H	0.0	24.6	13.7	46.0

Remark: 1. Quasi-Peak = Reading value + Correction factor

2. Correction Factor = Antenna factor+ Insertion loss(cable loss+amplifier gain)

3. Margin = Limit – Quasi-Peak

TA Technology (Shanghai) Co., Ltd. Test Report

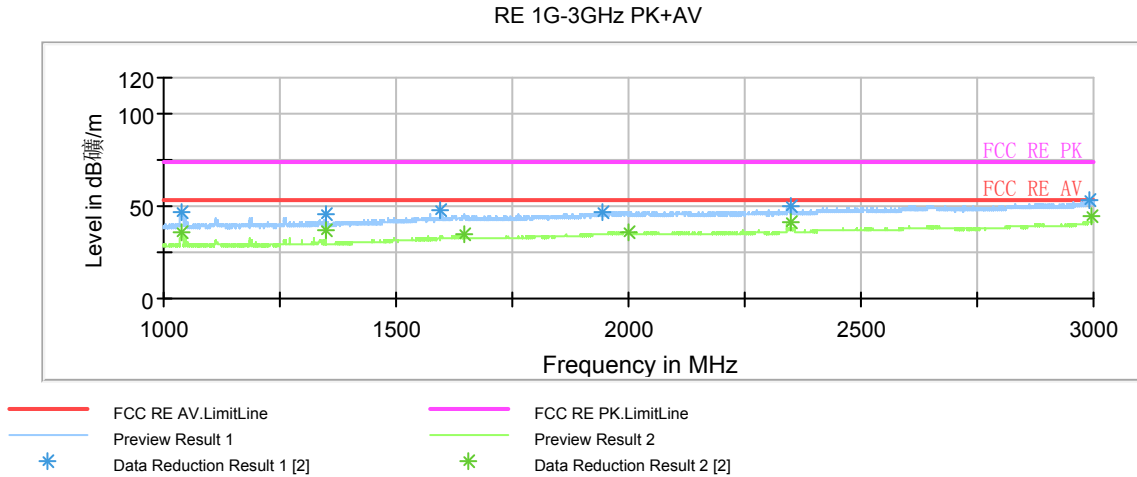

Note: This graph displays the maximum values of horizontal and vertical by software

Note: a font (Level in dB/m) in the test plot =(level in dBuv/m)

Note: The signal beyond the limit is carrier.

Radiates Emission from 1GHz to 3GHz

Frequency (MHz)	Peak (dBuV/m)	Reading value (dBuV/m)	Height (cm)	Polarization	Azimuth (deg)	Correct Factor (dB)	Margin (dB)	Limit (dBuV/m)
1038.250000	45.9	55.8	201.0	V	249.0	-9.9	28.1	74
1347.500000	44.1	53.0	101.0	V	348.0	-8.9	29.9	74
1646.500000	45.3	50.7	101.0	V	185.0	-5.4	28.7	74
1999.000000	44.9	47.9	201.0	V	207.0	-3.0	29.1	74
2350.000000	49.4	51.6	101.0	V	192.0	-2.2	24.6	74
2994.750000	51.2	52.6	101.0	V	245.0	1.4	22.8	74

Frequency (MHz)	Average (dBuV/m)	Reading value (dBuV/m)	Height (cm)	Polarization	Azimuth (deg)	Correct Factor (dB)	Margin (dB)	Limit (dBuV/m)
1038.250000	36.4	46.3	201.0	V	249.0	-9.9	17.6	54
1347.500000	37.3	46.2	101.0	V	348.0	-8.9	16.7	54
1646.500000	35.3	40.7	101.0	V	185.0	-5.4	18.7	54
1999.000000	36.0	39.0	201.0	V	207.0	-3.0	18.0	54
2350.000000	41.6	43.8	101.0	V	192.0	-2.2	12.4	54
2994.750000	44.7	46.1	101.0	V	245.0	1.4	9.3	54

TA Technology (Shanghai) Co., Ltd. Test Report

RE 3-18GHz PK+AV

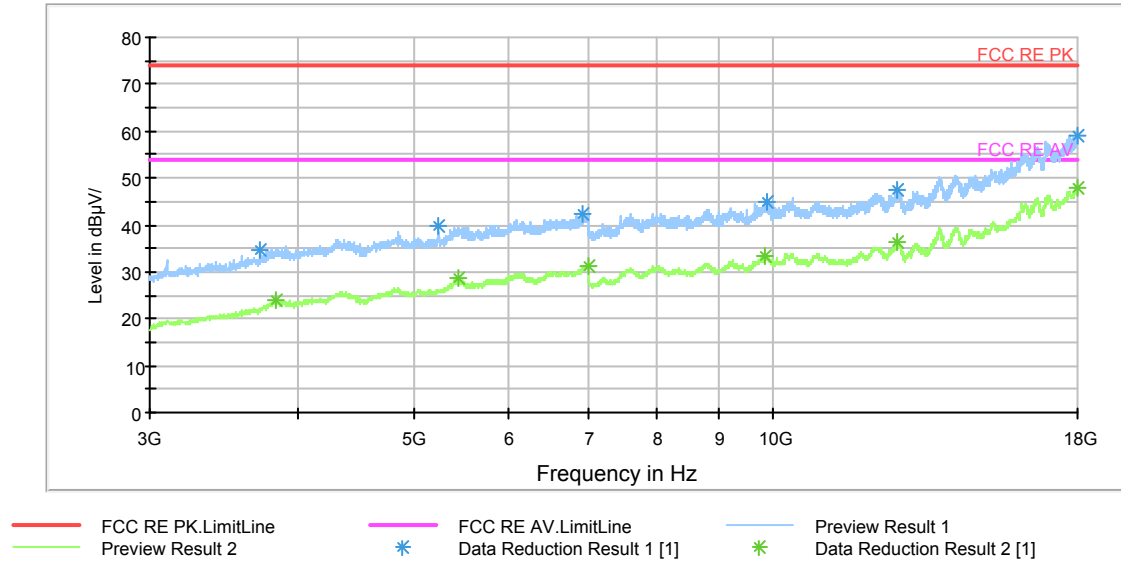

Note: Blue trace uses the peak detection Green trace uses the average detection
 This graph displays the maximum values of horizontal and vertical by software.
 Radiates Emission from 3GHz to 18GHz

Frequency (MHz)	Peak (dBuV/m)	Reading value (dBuV/m)	Height (cm)	Polarization	Azimuth (deg)	Correct Factor (dB)	Margin (dB)	Limit (dBuV/m)
3823.125000	33.0	33.1	99.0	H	173.0	-0.1	41.0	74
5450.625000	37.7	40.5	199.0	H	208.0	2.8	36.3	74
6991.875000	41.0	46.0	99.0	H	236.0	5.0	33.0	74
9849.375000	43.6	53.4	99.0	H	0.0	9.8	30.4	74
12723.750000	45.7	58.3	401.0	H	245.0	12.6	28.3	74
17988.750000	57.5	81.0	299.0	H	23.0	23.5	16.5	74

3.

Frequency (MHz)	Average (dBuV/m)	Reading value (dBuV/m)	Height (cm)	Polarization	Azimuth (deg)	Correct Factor (dB)	Margin (dB)	Limit (dBuV/m)
3823.125000	23.9	24.0	99.0	H	173.0	-0.1	30.1	54
5450.625000	28.6	31.4	199.0	H	208.0	2.8	25.4	54
6991.875000	31.4	36.4	99.0	H	236.0	5.0	22.6	54
9849.375000	33.4	43.2	99.0	H	0.0	9.8	20.6	54
12723.750000	36.2	48.8	401.0	H	245.0	12.6	17.8	54
17988.750000	47.7	71.2	299.0	H	23.0	23.5	6.3	54

TA Technology (Shanghai) Co., Ltd.

Test Report

3.1. Conducted Emission

Ambient condition

Temperature	Relative humidity	Pressure
24°C ~26°C	50%~55%	102.5kPa

Methods of Measurement

The EUT is placed on a non-metallic table of 80cm height above the horizontal metal reference ground plane. During the test, the EUT was operating in its typical mode. The test method is according to ANSI C63.4-2009. Connect the AC power line of the EUT to the L.I.S.N. Use EMI receiver to detect the average and Quasi-peak value. RBW is set to 9 kHz, VBW is set to 30kHz. The measurement result should include both L line and N line. During the test, EUT is connected to a laptop via a LAN cable. The EUT is used as the peripheral equipment of the PC. The model of laptop is Lenovo X61 and the serial number of laptop is L3-D1224.

Test Setup

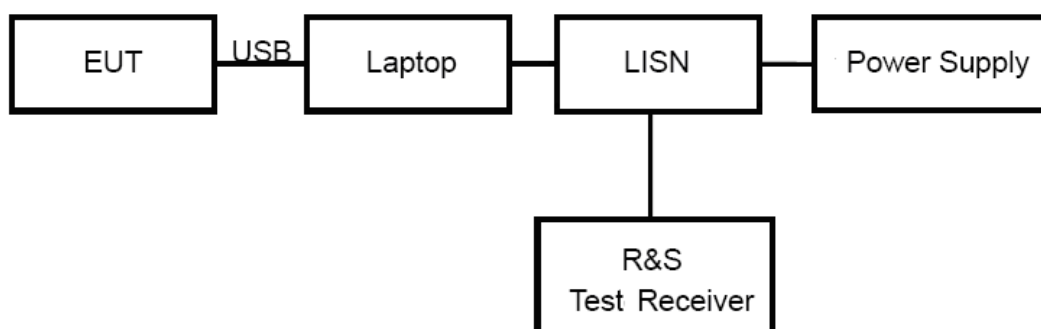

Note: Power Supply is AC Power source and it is used to change the voltage from 230V/50Hz to 120V/60Hz.

Limits

Frequency (MHz)	Conducted Limits(dBμV)	
	Quasi-peak	Average
0.15 - 0.5	66 to 56 *	56 to 46 *
0.5 - 5	56	46
5 - 30	60	50

*: Decreases with the logarithm of the frequency.

Measurement Uncertainty

The assessed measurement uncertainty to ensure 95% confidence level for the normal distribution is with the coverage factor $k = 1.96$. $U = 2.69$ dB.

TA Technology (Shanghai) Co., Ltd. Test Report

Report No.: RBA1505-0061EMC

Page 15 of 20

Test Results

USB Mode

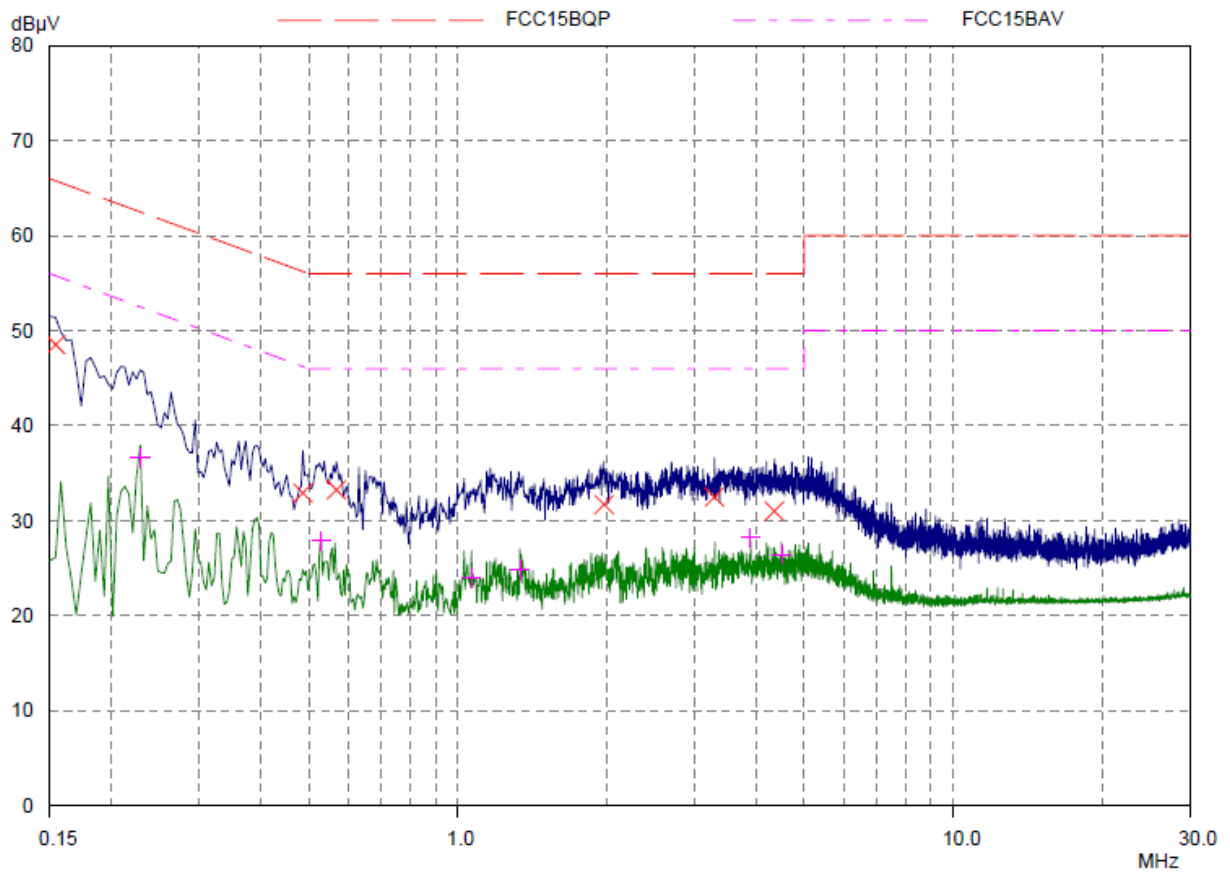

Final Measurement Results

Frequency MHz	QP Level dBµV	QP Limit dBµV	QP Delta dB	Phase -	PE -
0.1539	48.52	65.79	17.27	L1	gnd
0.48593	32.91	56.24	23.33	L1	gnd
0.56796	33.26	56.00	22.74	L1	gnd
1.97031	31.70	56.00	24.30	L1	gnd
3.29453	32.48	56.00	23.52	L1	gnd
4.35312	31.02	56.00	24.98	L1	gnd

Frequency MHz	AV Level dBµV	AV Limit dBµV	AV Delta dB	Phase -	PE -
0.22812	36.62	52.52	15.90	L1	gnd
0.5289	27.85	46.00	18.15	L1	gnd
1.06406	23.98	46.00	22.02	L1	gnd
1.33359	24.85	46.00	21.15	L1	gnd
3.89609	28.24	46.00	17.76	L1	gnd
4.49765	26.46	46.00	19.54	L1	gnd

CE_I-240W-A_L_0.15-30MHz

TA Technology (Shanghai) Co., Ltd. Test Report

Report No.: RBA1505-0061EMC

Page 16 of 20

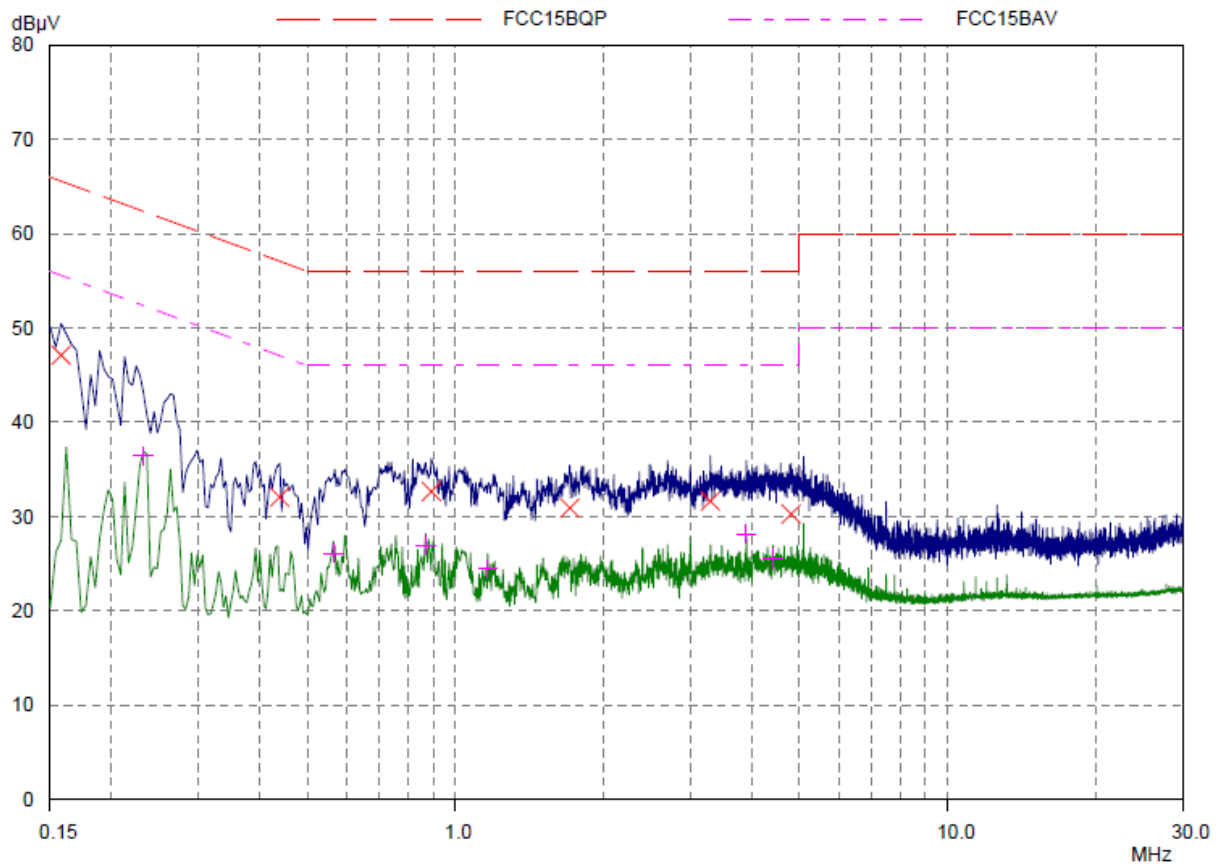

Final Measurement Results

Frequency MHz	QP Level dBµV	QP Limit dBµV	QP Delta dB	Phase -	PE -
0.15781	47.11	65.58	18.47	N	gnd
0.43906	32.06	57.08	25.02	N	gnd
0.89218	32.67	56.00	23.33	N	gnd
1.70468	30.91	56.00	25.09	N	gnd
3.29453	31.64	56.00	24.36	N	gnd
4.80625	30.27	56.00	25.73	N	gnd

Frequency MHz	AV Level dBµV	AV Limit dBµV	AV Delta dB	Phase -	PE -
0.23203	36.45	52.38	15.93	N	gnd
0.56406	26.12	46.00	19.88	N	gnd
0.86875	26.98	46.00	19.02	N	gnd
1.16171	24.47	46.00	21.53	N	gnd
3.89609	28.18	46.00	17.82	N	gnd
4.41171	25.56	46.00	20.44	N	gnd

CE_I-240W-A_N_0.15-30MHz

TA Technology (Shanghai) Co., Ltd.
Test Report

Report No.: RBA1505-0061EMC

Page 17 of 20

4. Main Test Instruments

No.	Name	Type	Manufacturer	Serial Number	Calibration Date	Expiration Time	Valid Period
01	EMI Test Receiver	ESCI	R&S	100948	2014-06-28	2015-06-27	1 year
02	Trilog Antenna	VULB 9163	SCHWARZBECK	9163-201	2013-06-19	2016-06-18	3 years
03	Signal Analyzer	FSV30	R&S	100815	2014-06-28	2015-06-27	1 year
04	Horn Antenna	HF907	R&S	100126	2012-07-01	2015-06-30	3 years
05	Horn Antenna	3160-09	ETS-Lindgren	00102643	2012-07-01	2015-06-30	3 years
06	EMI Test Receiver	ESCS30	R&S	100138	2015-01-13	2016-01-12	1 year
07	LISN	ENV216	R&S	101171	2015-04-11	2016-04-11	1 year

*****END OF REPORT *****

ANNEX A: The EUT Appearance and Test Setup

A.1 EUT Appearance



a: EUT



b: Adapter

Picture 1 EUT

TA Technology (Shanghai) Co., Ltd.
Test Report

A.2 Test Setup



a: Below 1GHz

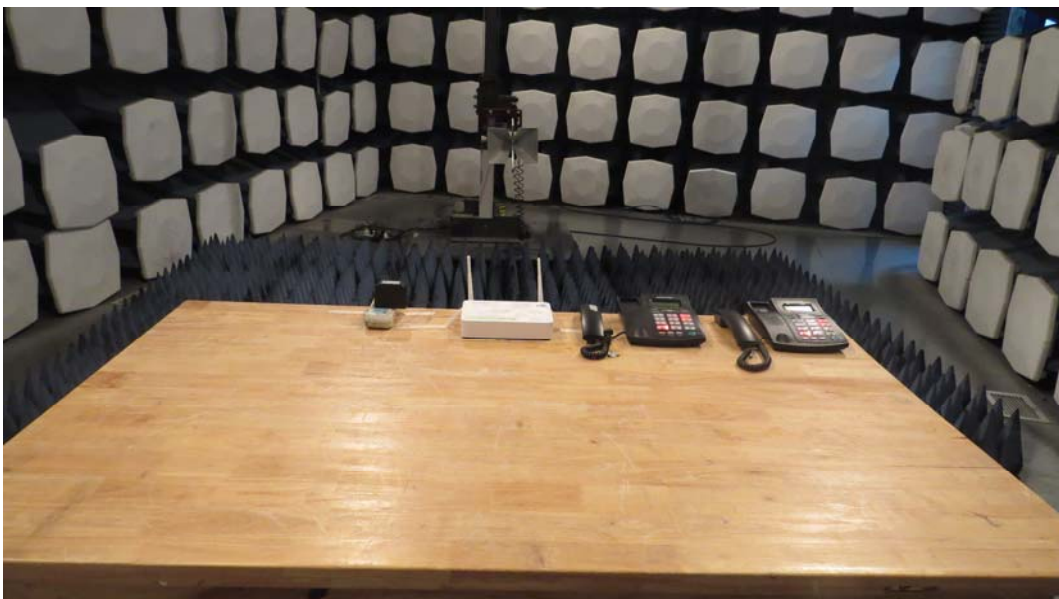

b: Above 1GHz

Picture 2 Radiated Emission Test Setup

**TA Technology (Shanghai) Co., Ltd.
Test Report**

Report No.: RBA1505-0061EMC

Page 20 of 20



Picture 3 Conducted Emission Test Setup