



RADIO TEST REPORT

FCC ID : 2ADZRHA0336GA
Equipment : Nokia WiFi Beacon 6
Brand Name : NOKIA
Model Name : HA-0336G-A
Applicant : Nokia Shanghai Bell Co. Ltd.
No. 388, Ningqiao Rd.
Pilot Free Trade Zone Shanghai , China 201206
Manufacturer : Nokia Shanghai Bell Co. Ltd.
No. 388, Ningqiao Rd.
Pilot Free Trade Zone Shanghai , China 201206
Standard : 47 CFR FCC Part 15.407

The product was received on Jul. 17, 2022, and testing was started from Aug. 20, 2022 and completed on Aug. 31, 2022. We, Sporton International Inc. Hsinchu Laboratory, would like to declare that the tested sample has been evaluated in accordance with the procedures given in ANSI C63.10-2013 and shown compliance with the applicable technical standards.

The test results in this variant report apply exclusively to the tested model / sample. Without written approval of Sporton International Inc. Hsinchu Laboratory, the test report shall not be reproduced except in full.

Approved by: Sam Chen

Sporton International Inc. Hsinchu Laboratory

No.8, Ln. 724, Bo'ai St., Zhubei City, Hsinchu County 302010, Taiwan (R.O.C.)



Table of Contents

History of this test report.....3

Summary of Test Result.....4

1 General Description5

1.1 Information.....5

1.2 Applicable Standards13

1.3 Testing Location Information.....13

1.4 Measurement Uncertainty14

2 Test Configuration of EUT15

2.1 Test Channel Mode15

2.2 The Worst Case Measurement Configuration.....16

2.3 EUT Operation during Test17

2.4 Accessories18

2.5 Support Equipment.....18

2.6 Test Setup Diagram20

3 Transmitter Test Result24

3.1 AC Power-line Conducted Emissions24

3.2 Emission Bandwidth.....26

3.3 Maximum Output Power.....28

3.4 Power Spectral Density30

3.5 Unwanted Emissions.....33

4 Test Equipment and Calibration Data37

Appendix A. Test Results of AC Power-line Conducted Emissions

Appendix B. Test Results of Emission Bandwidth

Appendix C. Test Results of Maximum Output Power

Appendix D. Test Results of Power Spectral Density

Appendix E. Test Results of Unwanted Emissions

Appendix F. Test Photos

Photographs of EUT v01



History of this test report

Report No.	Version	Description	Issued Date
FR9D0907-09AB	01	Initial issue of report	Sep. 14, 2022



Summary of Test Result

Report Clause	Ref Std. Clause	Test Items	Result (PASS/FAIL)	Remark
1.1.2	15.203	Antenna Requirement	PASS	-
3.1	15.207	AC Power-line Conducted Emissions	PASS	-
3.2	15.407(a)	Emission Bandwidth	PASS	-
3.3	15.407(a)	Maximum Output Power	PASS	-
3.4	15.407(a)	Power Spectral Density	PASS	-
3.5	15.407(b)	Unwanted Emissions	PASS	-

Declaration of Conformity:

1. The test results with all measurement uncertainty excluded are presented in accordance with the regulation limits or requirements declared by manufacturers. It's means measurement values may risk exceeding the limit of regulation standards, if measurement uncertainty is include in test results.
2. The measurement uncertainty please refer to report "Measurement Uncertainty".

Comments and Explanations:

1. The test configuration, test mode and test software were written in this test report are declared by the manufacturer.
2. The declared of product specification for EUT presented in the report are provided by the manufacturer, and the manufacturer takes all the responsibilities for the accuracy of product specification.

Reviewed by: Sam Chen

Report Producer: Penny Kao



1 General Description

1.1 Information

1.1.1 RF General Information

Frequency Range (MHz)	IEEE Std. 802.11	Ch. Frequency (MHz)	Channel Number
5150-5250	a, n (HT20), ac (VHT20), ax (HEW20)	5180-5240	36-48 [4]
5250-5350		5260-5320	52-64 [4]
5470-5725		5500-5720	100-144 [12]
5725-5850		5745-5825	149-165 [5]
5150-5250	n (HT40), ac (VHT40), ax (HEW40)	5190-5230	38-46 [2]
5250-5350		5270-5310	54-62 [2]
5470-5725		5510-5710	102-142 [6]
5725-5850		5755-5795	151-159 [2]
5150-5250	ac (VHT80), ax (HEW80)	5210	42 [1]
5250-5350		5290	58 [1]
5470-5725		5530-5610	106-138 [3]
5725-5850		5775	155 [1]

Band	Mode	BWch (MHz)	Nant
5.15-5.35GHz	802.11a	20	2TX
5.15-5.35GHz	802.11n HT20	20	2TX
5.15-5.35GHz	802.11n HT20-BF	20	2TX
5.15-5.35GHz	802.11ac VHT20	20	2TX
5.15-5.35GHz	802.11ac VHT20-BF	20	2TX
5.15-5.35GHz	802.11ax HEW20	20	2TX
5.15-5.35GHz	802.11ax HEW20-BF	20	2TX
5.15-5.35GHz	802.11n HT40	40	2TX
5.15-5.35GHz	802.11n HT40-BF	40	2TX
5.15-5.35GHz	802.11ac VHT40	40	2TX
5.15-5.35GHz	802.11ac VHT40-BF	40	2TX
5.15-5.35GHz	802.11ax HEW40	40	2TX
5.15-5.35GHz	802.11ax HEW40-BF	40	2TX
5.15-5.35GHz	802.11ac VHT80	80	2TX
5.15-5.35GHz	802.11ac VHT80-BF	80	2TX
5.15-5.35GHz	802.11ax HEW80	80	2TX



Band	Mode	BWch (MHz)	Nant
5.15-5.35GHz	802.11ax HEW80-BF	80	2TX
5.47-5.725GHz	802.11a	20	4TX
5.47-5.725GHz	802.11n HT20	20	4TX
5.47-5.725GHz	802.11n HT20-BF	20	4TX
5.47-5.725GHz	802.11ac VHT20	20	4TX
5.47-5.725GHz	802.11ac VHT20-BF	20	4TX
5.47-5.725GHz	802.11ax HEW20	20	4TX
5.47-5.725GHz	802.11ax HEW20-BF	20	4TX
5.47-5.725GHz	802.11n HT40	40	4TX
5.47-5.725GHz	802.11n HT40-BF	40	4TX
5.47-5.725GHz	802.11ac VHT40	40	4TX
5.47-5.725GHz	802.11ac VHT40-BF	40	4TX
5.47-5.725GHz	802.11ax HEW40	40	4TX
5.47-5.725GHz	802.11ax HEW40-BF	40	4TX
5.47-5.725GHz	802.11ac VHT80	80	4TX
5.47-5.725GHz	802.11ac VHT80-BF	80	4TX
5.47-5.725GHz	802.11ax HEW80	80	4TX
5.47-5.725GHz	802.11ax HEW80-BF	80	4TX
5.725-5.85GHz	802.11a	20	4TX
5.725-5.85GHz	802.11n HT20	20	4TX
5.725-5.85GHz	802.11n HT20-BF	20	4TX
5.725-5.85GHz	802.11ac VHT20	20	4TX
5.725-5.85GHz	802.11ac VHT20-BF	20	4TX
5.725-5.85GHz	802.11ax HEW20	20	4TX
5.725-5.85GHz	802.11ax HEW20-BF	20	4TX
5.725-5.85GHz	802.11n HT40	40	4TX
5.725-5.85GHz	802.11n HT40-BF	40	4TX
5.725-5.85GHz	802.11ac VHT40	40	4TX
5.725-5.85GHz	802.11ac VHT40-BF	40	4TX
5.725-5.85GHz	802.11ax HEW40	40	4TX
5.725-5.85GHz	802.11ax HEW40-BF	40	4TX
5.725-5.85GHz	802.11ac VHT80	80	4TX
5.725-5.85GHz	802.11ac VHT80-BF	80	4TX
5.725-5.85GHz	802.11ax HEW80	80	4TX
5.725-5.85GHz	802.11ax HEW80-BF	80	4TX



Note:

- ◆ 11a, HT20 and HT40 use a combination of OFDM-BPSK, QPSK, 16QAM, 64QAM modulation.
- ◆ VHT20, VHT40, VHT80 use a combination of OFDM-BPSK, QPSK, 16QAM, 64QAM, 256QAM, modulation.
- ◆ HEW20, HEW40, HEW80 use a combination of OFDMA-BPSK, QPSK, 16QAM, 64QAM, 256QAM, 1024QAM modulation.
- ◆ BWch is the nominal channel bandwidth.



1.1.2 Antenna Information

For Galtronics antenna

Set	Ant.	Port	Brand	Model Name	Cable Color	Antenna Type	Connector	Gain (dBi)
1	1	1	Galtronics	02102140-07236-1	White	Dipole Antenna	U.FL	Note
	2	2	Galtronics	02102140-07236-2	Black	Dipole Antenna	U.FL	Note
	3	1	Galtronics	02102142-07236-1	Red	Dipole Antenna	U.FL	Note
	4	2	Galtronics	02102142-07236-2	Green	Dipole Antenna	U.FL	Note
	5	3	Galtronics	02102142-07236-3	Blue	Dipole Antenna	U.FL	Note
	6	4	Galtronics	02102142-07236-4	Grey	Dipole Antenna	U.FL	Note

Note:

Ant.	Port	Peak Gain (dBi)				
		2.4GHz	5GHz UNII 1	5GHz UNII 2A	5GHz UNII 2C	5GHz UNII 3
1	1	2.47	2.32	2.32	-	-
2	2	2.19	2.48	2.48	-	-
3	1	-	-	-	2.1	2.15
4	2	-	-	-	2.1	1.38
5	3	-	-	-	2.41	1.83
6	4	-	-	-	2.15	1.82

Ant.	Port	Max Directional Gain (dBi)				
		2.4GHz	5GHz UNII 1	5GHz UNII 2A	5GHz UNII 2C	5GHz UNII 3
1	1	2.26	5.24	5.24	-	-
2	2				-	-
3	1	-	-	-	6.07	5.6
4	2	-	-	-		
5	3	-	-	-		
6	4	-	-	-		



For Inpaq antenna

Set	Ant.	Port	Brand	Model Name	Cable Color	Antenna Type	Connector	Gain (dBi)
2	1	1	Inpaq	RFDPA072516IMLB9C1	White	Dipole Antenna	I-PEX	Note
	2	2	Inpaq	RFDPA072511IMLB9C1	Black	Dipole Antenna	I-PEX	Note
	3	1	Inpaq	RFDPA051106IM5B9C2	Red	Dipole Antenna	I-PEX	Note
	4	2	Inpaq	RFDPA051105IM5B9C1	Green	Dipole Antenna	I-PEX	Note
	5	3	Inpaq	RFDPA051108IM5B9C1	Blue	Dipole Antenna	I-PEX	Note
	6	4	Inpaq	RFDPA051112IM5B9C1	Grey	Dipole Antenna	I-PEX	Note

Note:

Ant.	Port	Peak Gain (dBi)				
		2.4GHz	5GHz UNII 1	5GHz UNII 2A	5GHz UNII 2C	5GHz UNII 3
1	1	2.97	4.66	3.87	-	-
2	2	3.54	3.63	2.99	-	-
3	1	-	-	-	3.62	1.72
4	2	-	-	-	1.57	1.5
5	3	-	-	-	2.14	1.36
6	4	-	-	-	2.78	2.07

Ant.	Port	Max Directional Gain (dBi)				
		2.4GHz	5GHz UNII 1	5GHz UNII 2A	5GHz UNII 2C	5GHz UNII 3
1	1	4.98	5.07	4.98	-	-
2	2				-	-
3	1	-	-	-	5.87	5.8
4	2	-	-	-		
5	3	-	-	-		
6	4	-	-	-		

Note: The above information was declared by manufacturer.

The EUT has 2 sets antennas.

For Conducted test:

2.4GHz/5GHz UNII 3: Because Galtronics’s antennas and Inpaq’s antennas are the same type antennas, only the highest directional gain antennas “Inpaq’s antennas” was tested and recorded in the report.

5GHz UNII 1~2C: Because Galtronics’s antennas and Inpaq’s antennas are the same type antennas, only the highest directional gain antennas “Galtronics’s antennas” was tested and recorded in the report.

For Radiated test:

2.4GHz/5GHz UNII 1~2C: Because Galtronics’s antennas and Inpaq’s antennas are the same type antennas, only the highest peak gain antennas “Inpaq’s antennas” was tested and recorded in the report.

5GHz UNII 3: Because Galtronics’s antennas and Inpaq’s antennas are the same type antennas, only the highest peak gain antennas “Galtronics’s antennas” was tested and recorded in the report.



<For 2.4GHz Function>

For IEEE 802.11b/g/n/ax/VHT mode (2TX, 2RX):

Ant. 1(Port 1) and Ant. 2(Port 2) can be used as transmitting/receiving antenna.

Ant. 1(Port 1) and Ant. 2(Port 2) could transmit/receive simultaneously.

<For 5GHz UNII 1~2A Function>

For IEEE 802.11a/n/ac/ax mode (2TX/2RX):

Ant. 1(Port 1) and Ant. 2(Port 2) can be used as transmitting/receiving antenna.

Ant. 1(Port 1) and Ant. 2(Port 2) could transmit/receive simultaneously.

<For 5GHz UNII 2C~3 Function>

For IEEE 802.11a/n/ac/ax mode (4TX/4RX):

Ant. 3(Port 1) 、 Ant. 4(Port 2) 、 Ant. 5(Port 3) and Ant. 6(Port 4) can be used as transmitting/receiving antenna.

Ant. 3(Port 1) 、 Ant. 4(Port 2) 、 Ant. 5(Port 3) and Ant. 6(Port 4) could transmit/receive simultaneously.



1.1.3 Mode Test Duty Cycle

Mode	DC	DCF(dB)	T(s)	VBW(Hz) ≥ 1/T
802.11a	0.936	0.29	1.432m	1k
802.11ax HEW20	0.959	0.18	5.445m	300
802.11ax HEW20-BF	0.879	0.56	1.757m	1k
802.11ax HEW40	0.939	0.27	5.445m	300
802.11ax HEW40-BF	0.879	0.56	1.757m	1k
802.11ax HEW80	0.935	0.29	5.445m	300
802.11ax HEW80-BF	0.851	0.7	1.681m	1k

Note:

- ◆ DC is Duty Cycle.
- ◆ DCF is Duty Cycle Factor.

1.1.4 EUT Operational Condition

EUT Power Type	From Power Adapter			
Beamforming Function	<input checked="" type="checkbox"/>	With beamforming	<input type="checkbox"/>	Without beamforming
	The product has beamforming function for 802.11n/ax \ VHT in 2.4G and 802.11n/ac/ax in 5GHz.			
Weather Band	<input checked="" type="checkbox"/>	With 5600~5650MHz	<input type="checkbox"/>	Without 5600~5650MHz
Function	<input type="checkbox"/>	Outdoor P2M	<input checked="" type="checkbox"/>	Indoor P2M
	<input type="checkbox"/>	Fixed P2P	<input type="checkbox"/>	Client
	<input checked="" type="checkbox"/>	Point-to-multipoint	<input type="checkbox"/>	Point-to-point
TPC Function	<input checked="" type="checkbox"/>	With TPC	<input type="checkbox"/>	Without TPC
Test Software Version	Non-beamforming mode: QSPR Beamforming mode: TeraTerm \ iperf			

Note: The above information was declared by manufacturer.

1.1.5 Table for EUT Support Function

Type of Function	2.4GHz	5GHz UNII 1	5GHz UNII 2A	5GHz UNII 2C	5GHz UNII 3
Router Mode	V	V	V	V	V
Mesh Mode	-	-	-	V	V

Note: The EUT supports Router and Mesh mode, only Router mode was tested and recorded in this test report by manufacturer request.



1.1.6 Table for Multiple Listing

Model Name	Kit Code	EMA Code	Part Description
HA-0336G-A	3FE48064XXXX	3FE49001XXXX	Beacon6, AX4200, Triband Wi-Fi 6, 1PACK
	3FE48065XXXX		Beacon6, AX4200, Triband Wi-Fi 6, 2PACK

Note1: X can be replaced by alphanumeric characters A-Z/0-9 or blank.

Note2: The above information was declared by manufacturer.

1.1.7 Table for Permissive Change

This product is an extension of original one reported under Sporton project number: FR9D0907-05AB

Below is the table for the change of the product with respect to the original one.

Modifications	Performance Checking
Changing the FEM of WLAN 5GHz to "QPF4588A" from "QPF4588".	<ol style="list-style-type: none"> AC power-line conducted emissions Unwanted Emissions below 1GHz Based on original output power for 802.11a (5180/5200MHz), 802.11ax HEW20 (5200 MHz, 5180MHz-BF), 802.11ax HEW40 (5190/5310MHz, 5190MHz-BF, 5755MHz-BF) 802.11ax HEW80 (5290MHz) to measure below test item:Emission Bandwidth. Maximum Conducted Output Power. Peak Power Spectral Density. Based on original output power for 802.11a (5180/5200MHz), 802.11ax HEW20 (5200/5240MHz, 5180MHz-BF, 5825MHz-BF), 802.11ax HEW40 (5190/5270/5310MHz, 5190MHz-BF, 5755MHz-BF) 802.11ax HEW80 (5290/5530MHz) to measure below test item: Unwanted Emissions Above 1GHz.



1.2 Applicable Standards

According to the specifications of the manufacturer, the EUT must comply with the requirements of the following standards:

- ◆ 47 CFR FCC Part 15
- ◆ ANSI C63.10-2013
- ◆ FCC KDB 789033 D02 v02r01

The following reference test guidance is not within the scope of accreditation of TAF.

- ◆ FCC KDB 662911 D01 v02r01
- ◆ FCC KDB 412172 D01 v01r01
- ◆ FCC KDB 414788 D01 v01r01

1.3 Testing Location Information

Testing Location Information	
Test Lab. : Sporton International Inc. Hsinchu Laboratory	
Hsinchu (TAF: 3787)	ADD: No.8, Ln. 724, Bo'ai St., Zhubei City, Hsinchu County 302010, Taiwan (R.O.C.) TEL: 886-3-656-9065 FAX: 886-3-656-9085 Test site Designation No. TW3787 with FCC. Conformity Assessment Body Identifier (CABID) TW3787 with ISED.

Test Condition	Test Site No.	Test Engineer	Test Environment (°C / %)	Test Date
RF Conducted	TH03-CB	Owen Hsu	23.8-24.9 / 50-54	Aug. 22, 2022~ Aug. 31, 2022
Radiated Emission below 1GHz	03CH05-CB	Stim Sung	23.7~24.8 / 64~70	Aug. 22, 2022~ Aug. 24, 2022
Radiated Emission above 1GHz	03CH01-CB	KJ Chang	24.9~25 / 65~67	Aug. 20, 2022~ Aug. 27, 2022
	03CH06-CB		23.8~25.5 / 64~66	
	03CH03-CB		23.8~24.8 / 66~69	
AC Conduction	CO02-CB	Peter Wu	23~24 / 58~59	Aug. 30, 2022



1.4 Measurement Uncertainty

ISO/IEC 17025 requires that an estimate of the measurement uncertainties associated with the emissions test results be included in the report. The measurement uncertainties given below are based on a 95% confidence level (based on a coverage factor (k=2))

Test Items	Uncertainty	Remark
Conducted Emission (150kHz ~ 30MHz)	3.4 dB	Confidence levels of 95%
Radiated Emission (9kHz ~ 30MHz)	3.4 dB	Confidence levels of 95%
Radiated Emission (30MHz ~ 1,000MHz)	5.6 dB	Confidence levels of 95%
Radiated Emission (1GHz ~ 18GHz)	5.2 dB	Confidence levels of 95%
Radiated Emission (18GHz ~ 40GHz)	4.7 dB	Confidence levels of 95%
Conducted Emission	3.2 dB	Confidence levels of 95%
Output Power Measurement	0.8 dB	Confidence levels of 95%
Power Density Measurement	3.2 dB	Confidence levels of 95%
Bandwidth Measurement	2.0 %	Confidence levels of 95%



2 Test Configuration of EUT

2.1 Test Channel Mode

Mode	Power Setting
802.11a_Nss1,(6Mbps)_2TX	-
5180MHz	20
5200MHz	23
802.11ax HEW20_Nss1,(MCS0)_2TX	-
5200MHz	23
802.11ax HEW40_Nss1,(MCS0)_2TX	-
5190MHz	19
5310MHz	19
802.11ax HEW80_Nss1,(MCS0)_2TX	-
5290MHz	18.5
802.11ax HEW20-BF_Nss1,(MCS0)_2TX	-
5180MHz	23
802.11ax HEW40-BF_Nss1,(MCS0)_2TX	-
5190MHz	21
802.11ax HEW40-BF_Nss1,(MCS0)_4TX	-
5755MHz	28

Note:

- ♦ Evaluated HEW20/HEW40/HEW80 mode only due to the similar modulation.
The power setting of HT20/HT40/VHT20/VHT40/VHT80 mode are the same or lower than HEW20/HEW40/HEW80.



2.2 The Worst Case Measurement Configuration

The Worst Case Mode for Following Conformance Tests	
Tests Item	AC power-line conducted emissions
Condition	AC power-line conducted measurement for line and neutral Test Voltage: 120Vac / 60Hz
Operating Mode	Normal Link
	<ol style="list-style-type: none"> The Adapter 1~2 were performed testing. After evaluation, Adapter 1 has been evaluated to be the worst case. Consequently, measurement will follow this same test mode. The Antenna set 1~2 were performed testing. After evaluation, Antenna set 2 has been evaluated to be the worst case. Consequently, measurement will follow this same test mode.
1	EUT with antenna set 2 + Adapter 1

The Worst Case Mode for Following Conformance Tests	
Tests Item	Emission Bandwidth Maximum Output Power Power Spectral Density
Test Condition	Conducted measurement at transmit chains
1	WLAN 5GHz UNII 1~2A with antenna set 1 WLAN 5GHz UNII 3 with antenna set 2

The Worst Case Mode for Following Conformance Tests	
Tests Item	Unwanted Emissions
Test Condition	Radiated measurement If EUT consist of multiple antenna assembly (multiple antenna are used in EUT regardless of spatial multiplexing MIMO configuration), the radiated test should be performed with highest antenna gain of each antenna type.
Operating Mode < 1GHz	Normal Link
	<ol style="list-style-type: none"> The Adapter 1~2 were performed testing. After evaluation, Adapter 1 has been evaluated to be the worst case. Consequently, measurement will follow this same test mode. The Antenna set 1~2 were performed testing. After evaluation, Antenna set 2 has been evaluated to be the worst case. Consequently, measurement will follow this same test mode.
1	EUT with antenna set 2 + Adapter 1
Operating Mode > 1GHz	CTX
1	WLAN 5GHz UNII 1~2A with antenna set 2 WLAN 5GHz UNII 3 with antenna set 1

Note: The EUT can only be used at Y axis position.



2.3 EUT Operation during Test

For CTX Mode:

non-beamforming mode:

The EUT was programmed to be in continuously transmitting mode.

beamforming mode:

For Conducted Mode:

During the test, the following programs under WIN 7 were executed.

The program was executed as follows:

1. During the test, the EUT operation to normal function.
2. Executed command fixed test channel under TeraTerm、iperf.
3. Executed "Lantest.exe" to link with the remote workstation to transmit and receive packet by RX device and transmit duty cycle no less than 98%.

For Radiated Mode:

During the test, the following programs under WIN 7 were executed.

The program was executed as follows:

1. During the test, the EUT operation to normal function.
2. Executed command fixed test channel under TeraTerm、iperf.
3. Executed "Lantest.exe" to link with the remote workstation to transmit and receive packet by WLAN module and transmit duty cycle no less than 98%.

For Normal Link:

During the test, the EUT operation to normal function.



2.4 Accessories

Accessories			
Equipment Name	Brand Holder	Model Name	Rating
Adapter 1	Dongguan Shilong Fuhua Electronic Co., Ltd.	UES36WU-120250SPA	INPUT: 100-240V~50/60Hz, 1.0A OUTPUT: 12.0V-2.5A
Adapter 2	ShenZhen SOY Technology Co., Ltd.	SUN-1200300	INPUT: 100-240V~50/60Hz, 0.9A Max. OUTPUT: 12V-3.0A
Others			
RJ-45 cable*1, Non-Shielded, 1m			

2.5 Support Equipment

For AC Conduction:

Support Equipment				
No.	Equipment	Brand Name	Model Name	FCC ID
A	LAN2 NB	DELL	E6430	N/A
B	2.4G NB	DELL	E6430	N/A
C	5GH NB	DELL	E6430	N/A
D	WAN NB	DELL	E6430	N/A
E	LAN1 NB	DELL	E6430	N/A
F	5GL NB	DELL	E6430	N/A
G	Flash disk3.0	Transcend	JetFlash-700	N/A

For Radiated (below 1GHz):

Support Equipment				
No.	Equipment	Brand Name	Model Name	FCC ID
A	Notebook(LAN 1)	DELL	E4300	N/A
B	Flash disk3.0	Silicon Power	B06	N/A
C	Notebook(2.4G)	DELL	E4300	N/A
D	Notebook(5G Low Band)	DELL	E4300	N/A
E	Notebook(5G High Band)	DELL	E4300	N/A
F	Notebook(LAN 2)	DELL	E4300	N/A
G	Notebook(WAN)	DELL	E4300	N/A



**For Radiated (above 1GHz):
Non-beamforming mode**

Support Equipment				
No.	Equipment	Brand Name	Model Name	FCC ID
A	Notebook	DELL	E4300	N/A

Beamforming mode

Support Equipment				
No.	Equipment	Brand Name	Model Name	FCC ID
A	Notebook	DELL	E4300	N/A
B	Notebook	DELL	E4300	N/A
C	WLAN module	Intel	AX210NGW	PD9AX210NG

**For RF Conducted:
Non-beamforming mode**

Support Equipment				
No.	Equipment	Brand Name	Model Name	FCC ID
A	Notebook	DELL	E4300	N/A

Beamforming mode

Support Equipment				
No.	Equipment	Brand Name	Model Name	FCC ID
A	Notebook	DELL	E4300	N/A
B	Notebook	DELL	E4300	N/A
C	RX device	Nokia	HA-0236G-A/ HA-0336G-A	N/A

2.6 Test Setup Diagram

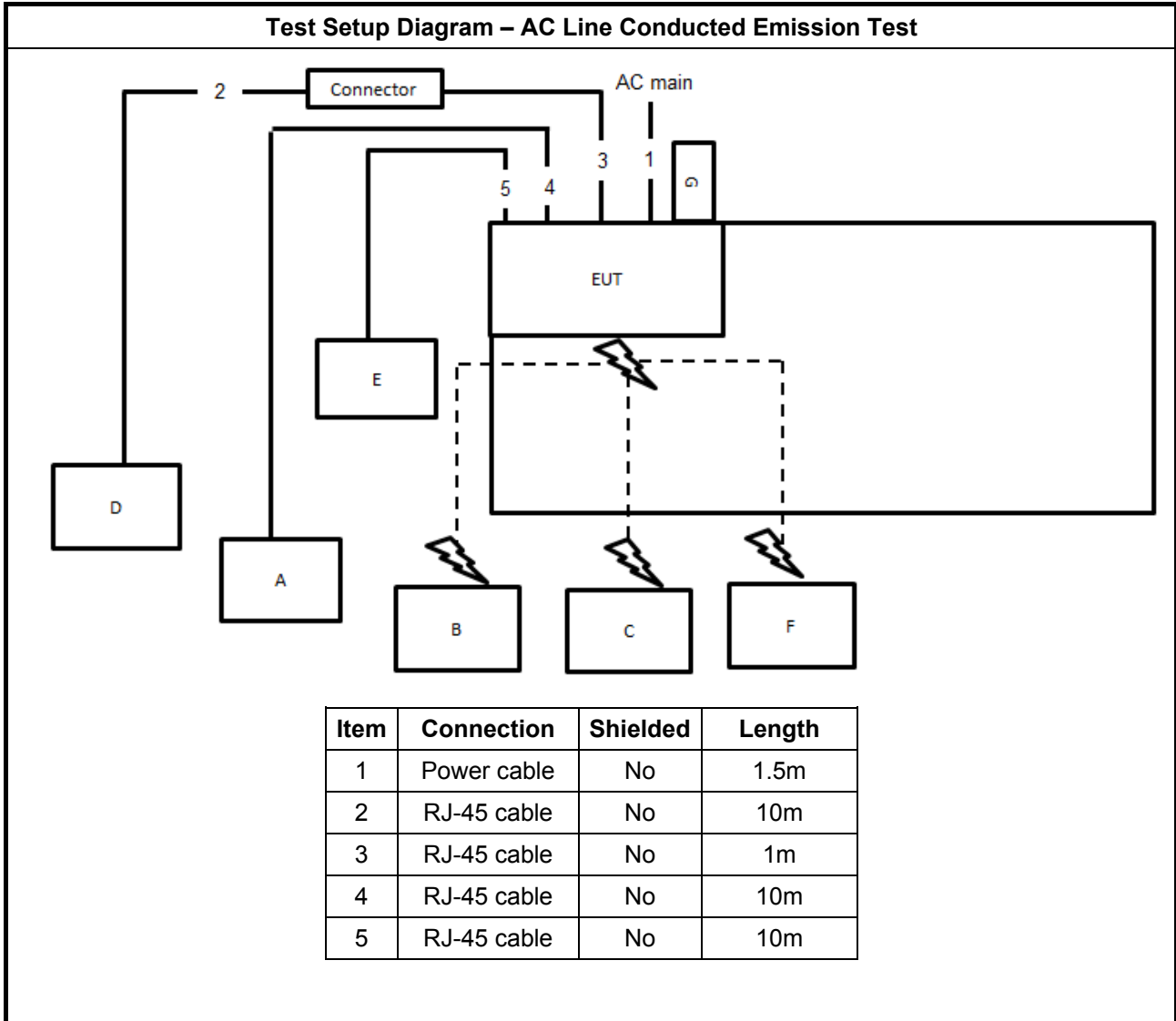

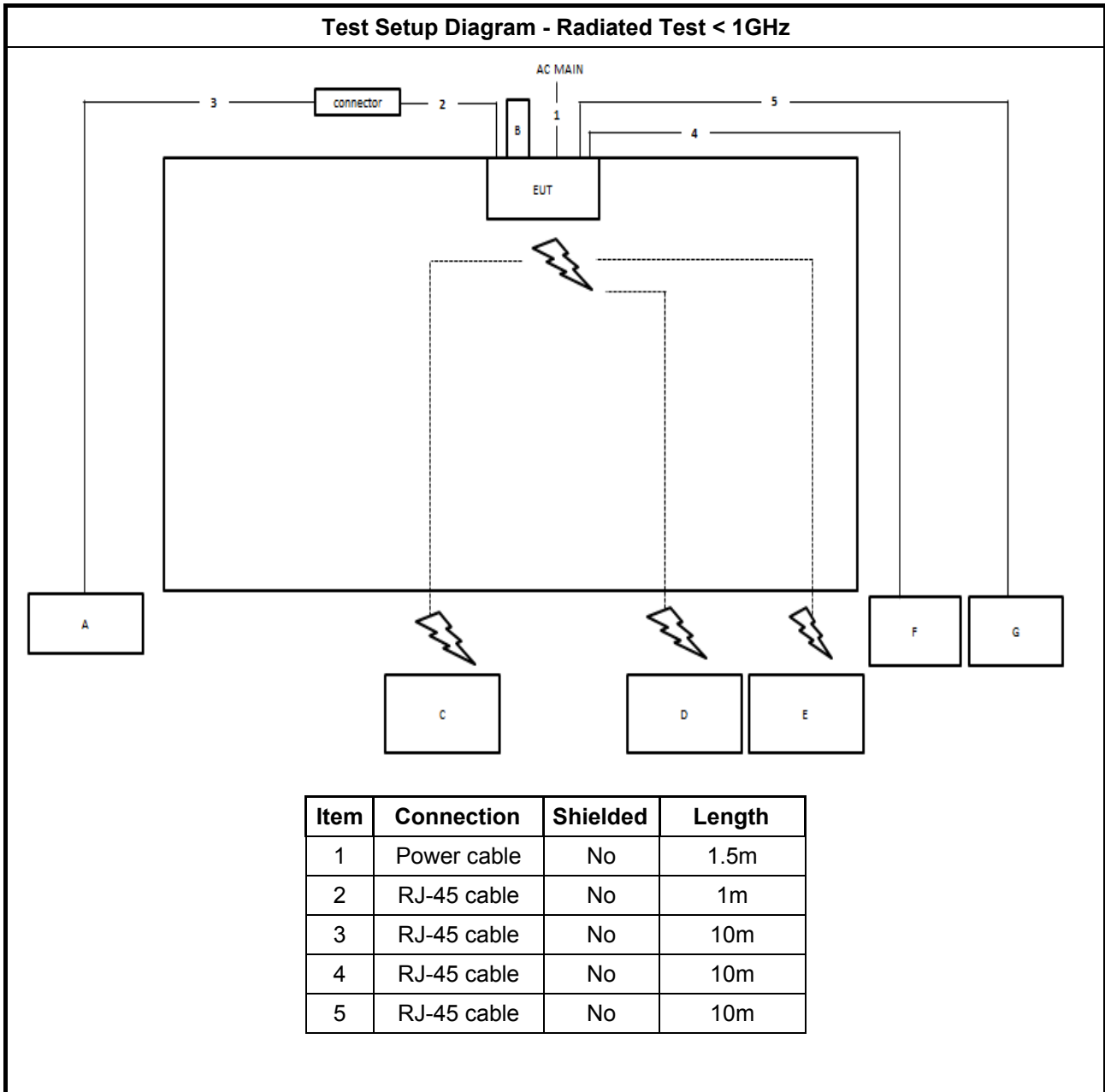

**Test Setup Diagram - Radiated Test > 1GHz
Non-beamforming mode**

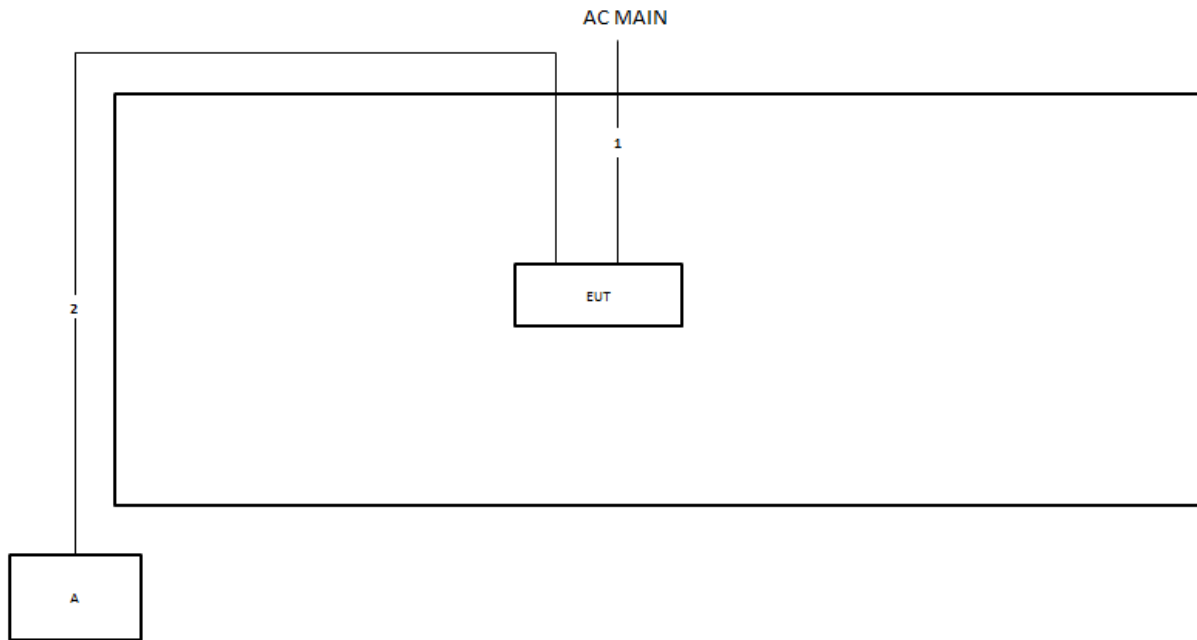

Item	Connection	Shielded	Length
1	Power cable	No	1.5m
2	RJ-45 cable	No	10m

**Test Setup Diagram - Radiated Test > 1GHz
Beamforming mode**

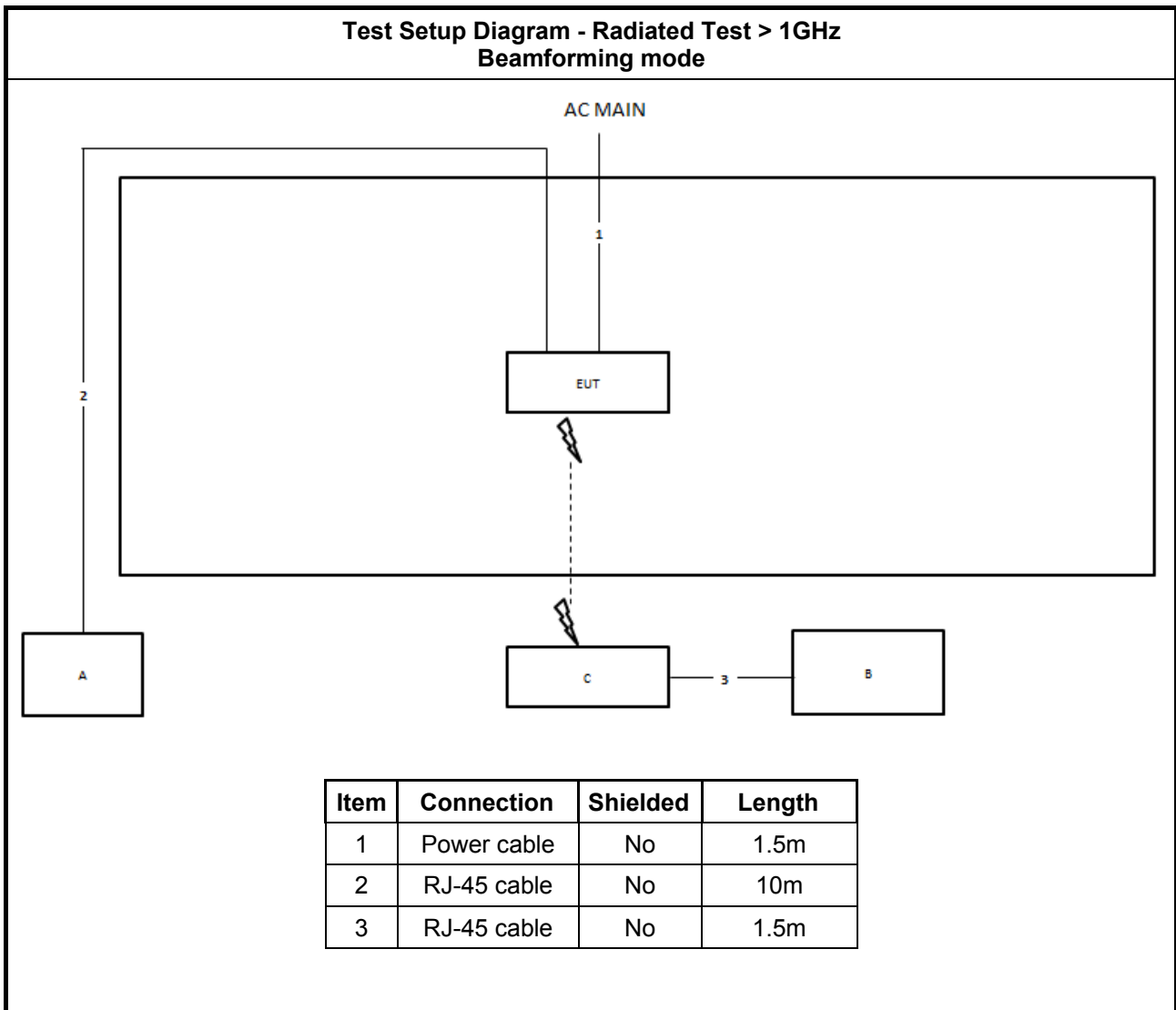

Item	Connection	Shielded	Length
1	Power cable	No	1.5m
2	RJ-45 cable	No	10m
3	RJ-45 cable	No	1.5m



3 Transmitter Test Result

3.1 AC Power-line Conducted Emissions

3.1.1 AC Power-line Conducted Emissions Limit

AC Power-line Conducted Emissions Limit		
Frequency Emission (MHz)	Quasi-Peak	Average
0.15-0.5	66 - 56 *	56 - 46 *
0.5-5	56	46
5-30	60	50

Note 1: * Decreases with the logarithm of the frequency.

3.1.2 Measuring Instruments

Refer a test equipment and calibration data table in this test report.

3.1.3 Test Procedures

Test Method
<input checked="" type="checkbox"/> Refer as ANSI C63.10-2013, clause 6.2 for AC power-line conducted emissions.

3.1.4 Test Setup

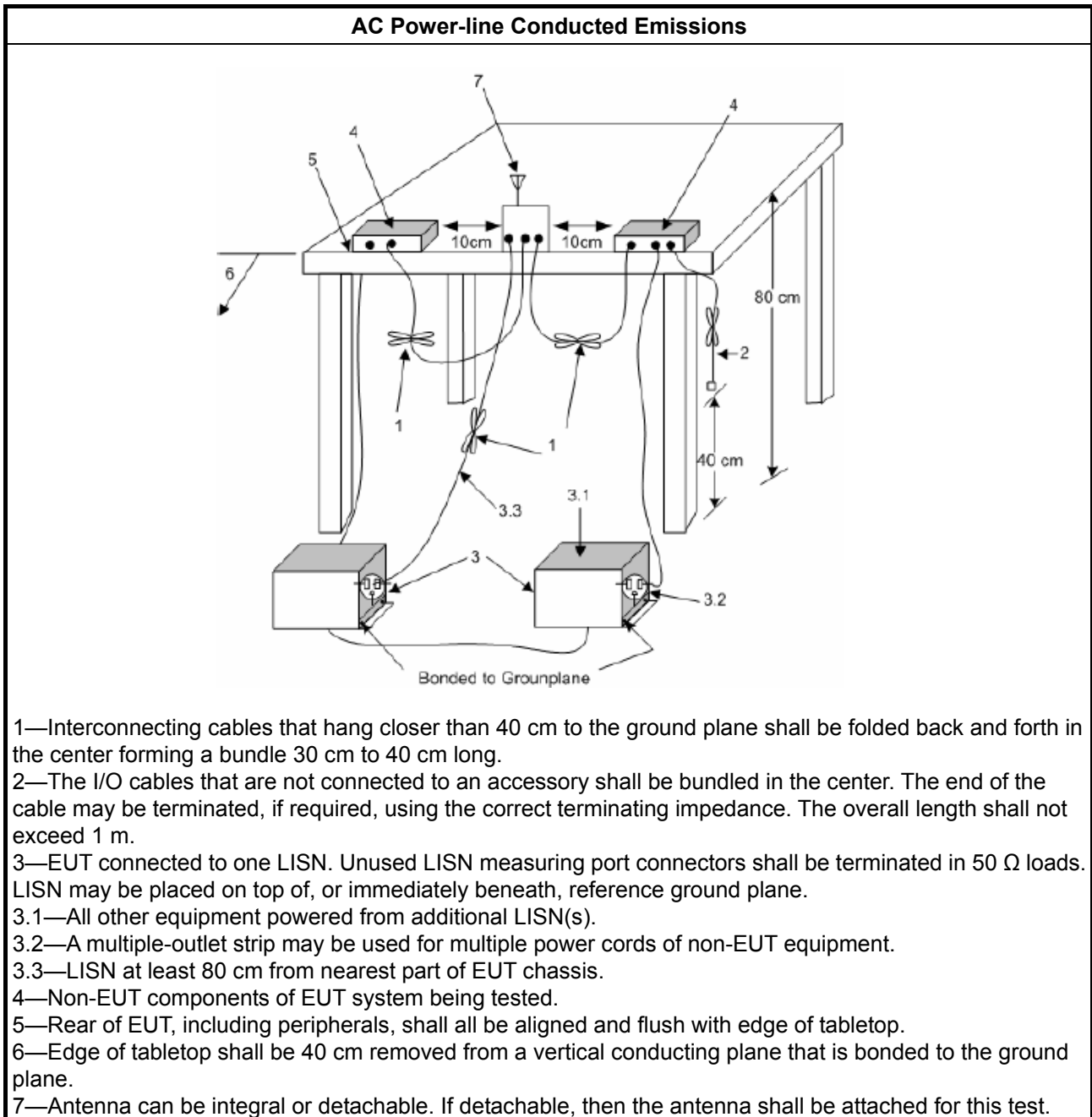

3.1.5 Measurement Results Calculation

The measured Level is calculated using:

- a. Corrected Reading: LISN Factor (LISN) + Attenuator (AT/AUX) + Cable Loss (CL) + Read Level (Raw) = Level
- b. Margin = -Limit + Level

3.1.6 Test Result of AC Power-line Conducted Emissions

Refer as Appendix A



3.2 Emission Bandwidth

3.2.1 Emission Bandwidth Limit

Emission Bandwidth Limit	
UNII Devices	
<input checked="" type="checkbox"/>	For the 5.15-5.25 GHz band, N/A
<input checked="" type="checkbox"/>	For the 5.25-5.35 GHz band, the maximum conducted output power shall not exceed the lesser of 250 mW or 11 dBm + 10 log B, where B is the 26 dB emission bandwidth in MHz.
<input checked="" type="checkbox"/>	For the 5.47-5.725 GHz band, the maximum conducted output power shall not exceed the lesser of 250 mW or 11 dBm + 10 log B, where B is the 26 dB emission bandwidth in MHz.
<input checked="" type="checkbox"/>	For the 5.725-5.85 GHz band, 26 dB emission bandwidth ,N/A. 6 dB emission bandwidth ≥ 500kHz.
<input type="checkbox"/>	For the 5.85-5.895 GHz band, 26 dB emission bandwidth ,N/A. 6 dB emission bandwidth ≥ 500kHz.
LE-LAN Devices	
<input type="checkbox"/>	For the band 5.15-5.25 GHz, the maximum e.i.r.p. shall not exceed 200 mW or 10 + 10 log B, dBm, whichever power is less. B is the 99% emission bandwidth in MHz.
<input type="checkbox"/>	For the 5.25-5.35 GHz band, the maximum e.i.r.p. shall not exceed 1.0 W or 17 + 10 log B, dBm, whichever power is less. B is the 99% emission bandwidth in MHz
<input type="checkbox"/>	For the 5.47-5.6 GHz band and 5.65-5.725 GHz band, the maximum e.i.r.p. shall not exceed 1.0 W or 17 + 10 log B, dBm, whichever power is less. B is the 99% emission bandwidth in MHz
<input type="checkbox"/>	For the 5.725-5.85 GHz band, 6 dB emission bandwidth ≥ 500kHz.

3.2.2 Measuring Instruments

Refer a test equipment and calibration data table in this test report.

3.2.3 Test Procedures

Test Method							
<ul style="list-style-type: none"> ▪ For the emission bandwidth shall be measured using one of the options below: <table border="1" style="width: 100%; border-collapse: collapse;"> <tr> <td style="width: 30px;"><input checked="" type="checkbox"/></td> <td>Refer as FCC KDB 789033 D02, clause C for EBW and clause D for OBW measurement.</td> </tr> <tr> <td><input type="checkbox"/></td> <td>Refer as ANSI C63.10, clause 6.9.1 for occupied bandwidth testing.</td> </tr> <tr> <td><input type="checkbox"/></td> <td>Refer as IC RSS-Gen, clause 4.6 for bandwidth testing.</td> </tr> </table> 		<input checked="" type="checkbox"/>	Refer as FCC KDB 789033 D02, clause C for EBW and clause D for OBW measurement.	<input type="checkbox"/>	Refer as ANSI C63.10, clause 6.9.1 for occupied bandwidth testing.	<input type="checkbox"/>	Refer as IC RSS-Gen, clause 4.6 for bandwidth testing.
<input checked="" type="checkbox"/>	Refer as FCC KDB 789033 D02, clause C for EBW and clause D for OBW measurement.						
<input type="checkbox"/>	Refer as ANSI C63.10, clause 6.9.1 for occupied bandwidth testing.						
<input type="checkbox"/>	Refer as IC RSS-Gen, clause 4.6 for bandwidth testing.						

3.2.4 Test Setup

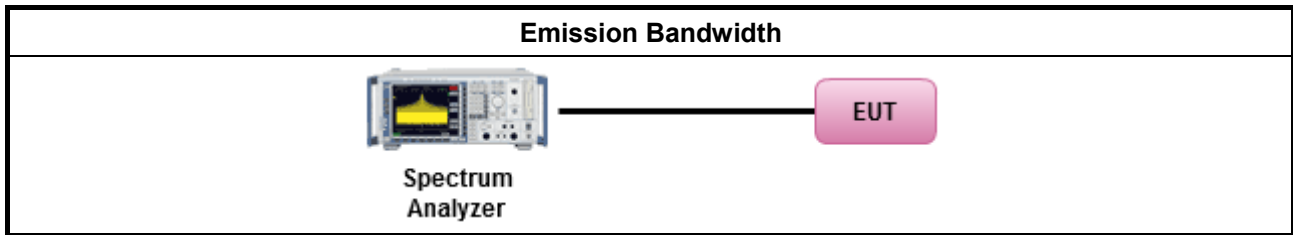

3.2.5 Test Result of Emission Bandwidth

Refer as Appendix B



3.3 Maximum Output Power

3.3.1 Limit

Maximum Output Power Limit	
UNII Devices	
<input checked="" type="checkbox"/> For the 5.15-5.25 GHz band:	
	<ul style="list-style-type: none"> Outdoor AP: the maximum conducted output power (P_{Out}) shall not exceed the lesser of 1 W. If $G_{TX} > 6$ dBi, then $P_{Out} = 30 - (G_{TX} - 6)$. e.i.r.p. at any elevation angle above 30 degrees $\leq 125mW$ [21dBm] Indoor AP: the maximum conducted output power (P_{Out}) shall not exceed the lesser of 1 W. If $G_{TX} > 6$ dBi, then $P_{Out} = 30 - (G_{TX} - 6)$ Point-to-point AP: the maximum conducted output power (P_{Out}) shall not exceed the lesser of 1 W. If $G_{TX} > 23$ dBi, then $P_{Out} = 30 - (G_{TX} - 23)$. Mobile or Portable Client: the maximum conducted output power (P_{Out}) shall not exceed the lesser of 250 mW. If $G_{TX} > 6$ dBi, then $P_{Out} = 24 - (G_{TX} - 6)$.
<input checked="" type="checkbox"/> For the 5.25-5.35 GHz band, the maximum conducted output power (P_{Out}) shall not exceed the lesser of 250 mW or $11 \text{ dBm} + 10 \log B$, where B is the 26 dB emission bandwidth in MHz. If $G_{TX} > 6$ dBi, then $P_{Out} = 24 - (G_{TX} - 6)$.	
<input checked="" type="checkbox"/> For the 5.47-5.725 GHz band, the maximum conducted output power (P_{Out}) shall not exceed the lesser of 250 mW or $11 \text{ dBm} + 10 \log B$, where B is the 26 dB emission bandwidth in MHz. If $G_{TX} > 6$ dBi, then $P_{Out} = 24 - (G_{TX} - 6)$.	
<input checked="" type="checkbox"/> For the 5.725-5.85 GHz band:	
	<ul style="list-style-type: none"> Point-to-multipoint systems (P2M): the maximum conducted output power (P_{Out}) shall not exceed the lesser of 1 W. If $G_{TX} > 6$ dBi, then $P_{Out} = 30 - (G_{TX} - 6)$. Point-to-point systems (P2P): the maximum conducted output power (P_{Out}) shall not exceed the lesser of 1 W.
Maximum EIRP Limit	
<input type="checkbox"/> For the 5.85-5.895 GHz band:	
	<ul style="list-style-type: none"> Indoor AP & subordinate device < 36 dBm Client device < 30 dBm
LE-LAN Devices	
<input type="checkbox"/> For the 5.15-5.25 GHz band, the maximum e.i.r.p. shall not exceed 200 mW or $10 + 10 \log B$, dBm, whichever power is less. B is the 99% emission bandwidth in MHz.	
<input type="checkbox"/> For the 5.25-5.35 GHz band, the maximum e.i.r.p. shall not exceed 1.0 W or $17 + 10 \log B$, dBm, whichever power is less. B is the 99% emission bandwidth in MHz	
<input type="checkbox"/> For the 5.47-5.6 GHz band and 5.65-5.725 GHz band, the maximum e.i.r.p. shall not exceed 1.0 W or $17 + 10 \log B$, dBm, whichever power is less. B is the 99% emission bandwidth in MHz	
<input type="checkbox"/> For the 5.725-5.85 GHz band:	
	<ul style="list-style-type: none"> Point-to-multipoint systems (P2M): the maximum conducted output power (P_{Out}) shall not exceed the lesser of 1 W. If $G_{TX} > 6$ dBi, then $P_{Out} = 30 - (G_{TX} - 6)$. Point-to-point systems (P2P): the maximum conducted output power (P_{Out}) shall not exceed the

lesser of 1 W.

P_{Out} = maximum conducted output power in dBm,
 G_{TX} = the maximum transmitting antenna directional gain in dBi.

3.3.2 Measuring Instruments

Refer a test equipment and calibration data table in this test report.

3.3.3 Test Procedures

Test Method	
Average over on/off periods with duty factor	
<input type="checkbox"/>	Refer as FCC KDB 789033 D02, clause E Method SA-2 (spectral trace averaging).
<input type="checkbox"/>	Refer as FCC KDB 789033 D02, clause E Method SA-2 Alt. (RMS detection with slow sweep speed)
Wideband RF power meter and average over on/off periods with duty factor	
<input checked="" type="checkbox"/>	Refer as FCC KDB 789033 D02, clause E Method PM-G (using an RF average power meter).
<input checked="" type="checkbox"/>	For conducted measurement.
<ul style="list-style-type: none"> If the EUT supports multiple transmit chains using options given below: Refer as FCC KDB 662911, In-band power measurements. Using the measure-and-sum approach, measured all transmit ports individually. Sum the power (in linear power units e.g., mW) of all ports for each individual sample and save them. If multiple transmit chains, EIRP calculation could be following as methods: $P_{total} = P_1 + P_2 + \dots + P_n$ (calculated in linear unit [mW] and transfer to log unit [dBm]) $EIRP_{total} = P_{total} + DG$ 	
<input type="checkbox"/>	For radiated measurement.
<ul style="list-style-type: none"> Refer as FCC KDB 789033 D02 clause II A.1.F "Antenna-port Conducted versus Radiated Testing" Refer as ANSI C63.10, clause 6.6 for radiated emissions above 1GHz. Refer as FCC KDB 412172 D01 clause 2.2 for EIRP calculation. 	

3.3.4 Test Setup

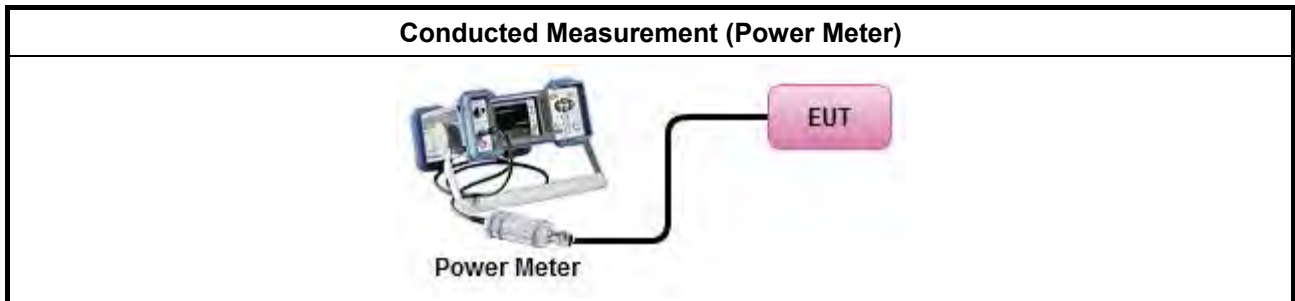

3.3.5 Test Result of Maximum Output Power

Refer as Appendix C



3.4 Power Spectral Density

3.4.1 Limit

Peak Power Spectral Density Limit	
UNII Devices	
<input checked="" type="checkbox"/> For the 5.15-5.25 GHz band:	
	<ul style="list-style-type: none"> ▪ Outdoor AP: the peak power spectral density (PPSD) shall not exceed the lesser of 17dBm/MHz. If $G_{TX} > 6$ dBi, then $P_{Out} = 17 - (G_{TX} - 6)$. ▪ Indoor AP: the peak power spectral density (PPSD) shall not exceed the lesser of 17dBm/MHz. If $G_{TX} > 6$ dBi, then $P_{Out} = 17 - (G_{TX} - 6)$. ▪ Point-to-point AP: the peak power spectral density (PPSD) shall not exceed the lesser of 17dBm/MHz. If $G_{TX} > 23$ dBi, then $P_{Out} = 17 - (G_{TX} - 23)$. ▪ Mobile or Portable Client: the peak power spectral density (PPSD) ≤ 11 dBm/MHz. If $G_{TX} > 6$ dBi, then $PPSD = 11 - (G_{TX} - 6)$.
<input checked="" type="checkbox"/> For the 5.25-5.35 GHz band, the peak power spectral density (PPSD) ≤ 11 dBm/MHz. If $G_{TX} > 6$ dBi, then $PPSD = 11 - (G_{TX} - 6)$.	
<input checked="" type="checkbox"/> For the 5.47-5.725 GHz band, the peak power spectral density (PPSD) ≤ 11 dBm/MHz. If $G_{TX} > 6$ dBi, then $PPSD = 11 - (G_{TX} - 6)$.	
<input checked="" type="checkbox"/> For the 5.725-5.85 GHz band:	
	<ul style="list-style-type: none"> ▪ Point-to-multipoint systems (P2M): the peak power spectral density (PPSD) ≤ 30 dBm/500kHz. If $G_{TX} > 6$ dBi, then $PPSD = 30 - (G_{TX} - 6)$. ▪ Point-to-point systems (P2P): the peak power spectral density (PPSD) ≤ 30 dBm/500kHz.
EIRP Power Spectral Density Limit	
<input type="checkbox"/> For the 5.85-5.895 GHz band:	
	<ul style="list-style-type: none"> ▪ Indoor AP & subordinate device < 20dBm/MHz ▪ Client device < 14dBm/MHz
LE-LAN Devices	
<input type="checkbox"/> For the 5.15-5.25 GHz band, the e.i.r.p. peak power spectral density (PPSD) ≤ 10 dBm/MHz.	
<input type="checkbox"/> For the 5.25-5.35 GHz band, the peak power spectral density (PPSD) ≤ 11 dBm/MHz.	
	<ul style="list-style-type: none"> ▪ e.i.r.p. greater than 200 mW shall comply with the following e.i.r.p. at different elevations, where θ is the angle above the local horizontal plane (of the Earth) as shown below: -13 dBW/MHz for $0^\circ \leq \theta < 8^\circ$; -13 - 0.716 (θ-8) dBW/MHz for $8^\circ \leq \theta < 40^\circ$ -35.9 - 1.22 (θ-40) dBW/MHz for $40^\circ \leq \theta \leq 45^\circ$; -42 dBW/MHz for $\theta > 45^\circ$
<input type="checkbox"/> For the 5.47-5.6 GHz band and 5.65-5.725 GHz band, the peak power spectral density (PPSD) ≤ 11 dBm/MHz.	
<input type="checkbox"/> For the 5.725-5.85 GHz band:	
	<ul style="list-style-type: none"> ▪ Point-to-multipoint systems (P2M): the peak power spectral density (PPSD) ≤ 30 dBm/500kHz. If $G_{TX} > 6$ dBi, then $PPSD = 30 - (G_{TX} - 6)$. ▪ Point-to-point systems (P2P): the peak power spectral density (PPSD) ≤ 30 dBm/500kHz.
PPSD = peak power spectral density that he same method as used to determine the conducted output	



power shall be used to determine the power spectral density. And power spectral density in dBm/MHz
 G_{TX} = the maximum transmitting antenna directional gain in dBi.

3.4.2 Measuring Instruments

Refer a test equipment and calibration data table in this test report.

3.4.3 Test Procedures

Test Method	
	<ul style="list-style-type: none"> ▪ Peak power spectral density procedures that the same method as used to determine the conducted output power shall be used to determine the peak power spectral density and use the peak search function on the spectrum analyzer to find the peak of the spectrum. For the peak power spectral density shall be measured using below options:
<input type="checkbox"/>	Refer as FCC KDB 789033 D02, F)5) power spectral density can be measured using resolution bandwidths < 1 MHz provided that the results are integrated over 1 MHz bandwidth
	[duty cycle ≥ 98% or external video / power trigger]
<input checked="" type="checkbox"/>	Refer as FCC KDB 789033 D02, clause E Method SA-1 (spectral trace averaging).
<input type="checkbox"/>	Refer as FCC KDB 789033 D02, clause E Method SA-1 Alt. (RMS detection with slow sweep speed)
	duty cycle < 98% and average over on/off periods with duty factor
<input checked="" type="checkbox"/>	Refer as FCC KDB 789033 D02, clause E Method SA-2 (spectral trace averaging).
<input type="checkbox"/>	Refer as FCC KDB 789033 D02, clause E Method SA-2 Alt. (RMS detection with slow sweep speed)
<input checked="" type="checkbox"/>	For conducted measurement.
	<ul style="list-style-type: none"> ▪ If the EUT supports multiple transmit chains using options given below:
<input checked="" type="checkbox"/>	Option 1: Measure and sum the spectra across the outputs. Refer as FCC KDB 662911, In-band power spectral density (PSD). Sample all transmit ports simultaneously using a spectrum analyzer for each transmit port. Where the trace bin-by-bin of each transmit port summing can be performed. (i.e., in the first spectral bin of output 1 is summed with that in the first spectral bin of output 2 and that from the first spectral bin of output 3, and so on up to the NTX output to obtain the value for the first frequency bin of the summed spectrum.). Add up the amplitude (power) values for the different transmit chains and use this as the new data trace.
<input type="checkbox"/>	Option 2: Measure and sum spectral maxima across the outputs. With this technique, spectra are measured at each output of the device at the required resolution bandwidth. The maximum value (peak) of each spectrum is determined. These maximum values are then summed mathematically in linear power units across the outputs. These operations shall be performed separately over frequency spans that have different out-of-band or spurious emission limits,
<input type="checkbox"/>	Option 3: Measure and add 10 log(N) dB, where N is the number of transmit chains. Refer as FCC KDB 662911, In-band power spectral density (PSD). Performed at each transmit chains and each transmit chains shall be compared with the limit have been reduced with 10 log(N). Or each transmit chains shall be add 10 log(N) to compared with the limit.
	<ul style="list-style-type: none"> ▪ If multiple transmit chains, EIRP PPSD calculation could be following as methods: $PPSD_{total} = PPSD_1 + PPSD_2 + \dots + PPSD_n$ (calculated in linear unit [mW] and transfer to log unit [dBm])

Test Method	
	$EIRP_{total} = PPSD_{total} + DG$
<input type="checkbox"/>	For radiated measurement.
	<ul style="list-style-type: none"> Refer as FCC KDB 789033 D02 clause II A.1.F "Antenna-port Conducted versus Radiated Testing"
	<ul style="list-style-type: none"> Refer as ANSI C63.10, clause 6.6 for radiated emissions above 1GHz.
	<ul style="list-style-type: none"> Refer as FCC KDB 412172 D01 clause 2.2 for EIRP calculation.

3.4.4 Test Setup

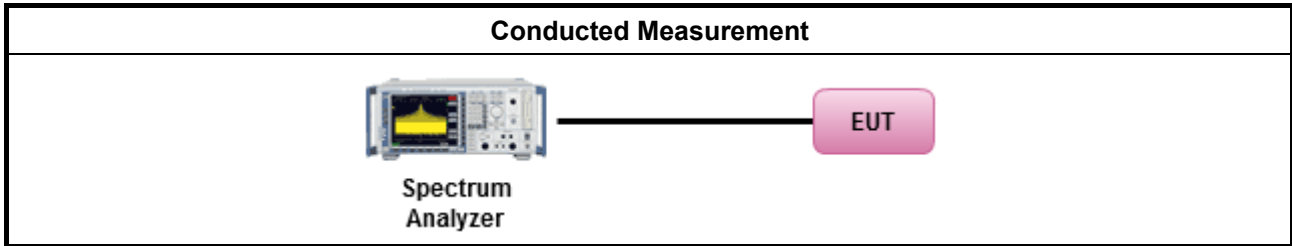

3.4.5 Test Result of Power Spectral Density

Refer as Appendix D



3.5 Unwanted Emissions

3.5.1 Transmitter Unwanted Emissions Limit

Unwanted emissions below 1 GHz and restricted band emissions above 1GHz limit			
Frequency Range (MHz)	Field Strength (uV/m)	Field Strength (dBuV/m)	Measure Distance (m)
0.009~0.490	2400/F(kHz)	48.5 - 13.8	300
0.490~1.705	24000/F(kHz)	33.8 - 23	30
1.705~30.0	30	29	30
30~88	100	40	3
88~216	150	43.5	3
216~960	200	46	3
Above 960	500	54	3

Note 1: Test distance for frequencies at or above 30 MHz, measurements may be performed at a distance other than the limit distance provided they are not performed in the near field and the emissions to be measured can be detected by the measurement equipment. When performing measurements at a distance other than that specified, the results shall be extrapolated to the specified distance using an extrapolation factor of 20 dB/decade (inverse of linear distance for field-strength measurements, inverse of linear distance-squared for power-density measurements).

Note 2: Test distance for frequencies at below 30 MHz, measurements may be performed at a distance closer than the EUT limit distance; however, an attempt should be made to avoid making measurements in the near field. When performing measurements below 30 MHz at a closer distance than the limit distance, the results shall be extrapolated to the specified distance by either making measurements at a minimum of two or more distances on at least one radial to determine the proper extrapolation factor or by using the square of an inverse linear distance extrapolation factor (40 dB/decade). The test report shall specify the extrapolation method used to determine compliance of the EUT.

Note 3: Using the distance of 1m during the test for above 18 GHz, and the test value to correct for the distance factor at 3m.

Un-restricted band emissions above 1GHz Limit	
Operating Band	Limit
<input checked="" type="checkbox"/> 5.15 - 5.25 GHz	e.i.r.p. -27 dBm [68.2 dBuV/m@3m]
<input checked="" type="checkbox"/> 5.25 - 5.35 GHz	e.i.r.p. -27 dBm [68.2 dBuV/m@3m]
<input checked="" type="checkbox"/> 5.47 - 5.725 GHz	e.i.r.p. -27 dBm [68.2 dBuV/m@3m]
<input checked="" type="checkbox"/> 5.725 - 5.85 GHz	all emissions shall be limited to a level of -27 dBm/MHz at 75 MHz or more above or below the band edge increasing linearly to 10 dBm/MHz at 25 MHz above or below the band edge, and from 25 MHz above or below the band edge increasing linearly to a level of 15.6 dBm/MHz at 5 MHz above or below the band edge, and from 5 MHz above or below the band edge increasing linearly to a level of 27 dBm/MHz at the band edge.
<input type="checkbox"/> 5.85 - 5.895 GHz	(i) For an indoor access point or subordinate device, all emissions at or above 5.895 GHz shall not exceed an e.i.r.p. of 15 dBm/MHz and shall decrease linearly to an e.i.r.p. of - 7 dBm/MHz at or above 5.925 GHz. (ii) For a client device, all emissions at or above 5.895 GHz shall not exceed an



	<p>e.i.r.p. of -5 dBm/MHz and shall decrease linearly to an e.i.r.p. of -27 dBm/MHz at or above 5.925 GHz.</p> <p>(iii) For a client device or indoor access point or subordinate device, all emissions below 5.725 GHz shall not exceed an e.i.r.p. of -27 dBm/MHz at 5.65 GHz increasing linearly to 10 dBm/ MHz at 5.7 GHz, and from 5.7 GHz increasing linearly to a level of 15.6 dBm/MHz at 5.72 GHz, and from 5.72 GHz increasing linearly to a level of 27 dBm/MHz at 5.725 GHz.</p>
<p>Note 1: Measurements may be performed at a distance other than the limit distance provided they are not performed in the near field and the emissions to be measured can be detected by the measurement equipment. When performing measurements at a distance other than that specified, the results shall be extrapolated to the specified distance using an extrapolation factor of 20 dB/decade (inverse of linear distance for field-strength measurements, inverse of linear distance-squared for power-density measurements).</p>	

3.5.2 Measuring Instruments

Refer a test equipment and calibration data table in this test report.

3.5.3 Test Procedures

Test Method															
	<ul style="list-style-type: none"> ▪ Measurements may be performed at a distance other than the limit distance provided they are not performed in the near field and the emissions to be measured can be detected by the measurement equipment. Measurements shall not be performed at a distance greater than 30 m for frequencies above 30 MHz, unless it can be further demonstrated that measurements at a distance of 30 m or less are impractical. When performing measurements at a distance other than that specified, the results shall be extrapolated to the specified distance using an extrapolation factor of 20 dB/decade (inverse of linear distance for field-strength measurements, inverse of linear distance-squared for power-density measurements). 														
	<ul style="list-style-type: none"> ▪ The average emission levels shall be measured in [duty cycle ≥ 98 or duty factor]. 														
	<ul style="list-style-type: none"> ▪ For the transmitter unwanted emissions shall be measured using following options below: <table border="1" style="width: 100%; border-collapse: collapse;"> <tr> <td style="width: 5%;"></td> <td> <ul style="list-style-type: none"> ▪ Refer as FCC KDB 789033 D02, clause G)2) for unwanted emissions into non-restricted bands. ▪ Refer as FCC KDB 789033 D02, clause G)1) for unwanted emissions into restricted bands. </td> </tr> <tr> <td style="text-align: center;"><input type="checkbox"/></td> <td>Refer as FCC KDB 789033 D02, G)6) Method AD (Trace Averaging).</td> </tr> <tr> <td style="text-align: center;"><input checked="" type="checkbox"/></td> <td>Refer as FCC KDB 789033 D02, G)6) Method VB (Reduced VBW).</td> </tr> <tr> <td style="text-align: center;"><input type="checkbox"/></td> <td>Refer as ANSI C63.10, clause 11.12.2.5.3 (Reduced VBW). VBW ≥ 1/T, where T is pulse time.</td> </tr> <tr> <td style="text-align: center;"><input type="checkbox"/></td> <td>Refer as ANSI C63.10, clause 7.5 average value of pulsed emissions.</td> </tr> <tr> <td style="text-align: center;"><input checked="" type="checkbox"/></td> <td>Refer as FCC KDB 789033 D02, clause G)5) measurement procedure peak limit.</td> </tr> <tr> <td style="text-align: center;"><input type="checkbox"/></td> <td>Refer as ANSI C63.10, clause 4.1.4.2.2 measurement procedure peak limit.</td> </tr> </table> 		<ul style="list-style-type: none"> ▪ Refer as FCC KDB 789033 D02, clause G)2) for unwanted emissions into non-restricted bands. ▪ Refer as FCC KDB 789033 D02, clause G)1) for unwanted emissions into restricted bands. 	<input type="checkbox"/>	Refer as FCC KDB 789033 D02, G)6) Method AD (Trace Averaging).	<input checked="" type="checkbox"/>	Refer as FCC KDB 789033 D02, G)6) Method VB (Reduced VBW).	<input type="checkbox"/>	Refer as ANSI C63.10, clause 11.12.2.5.3 (Reduced VBW). VBW ≥ 1/T, where T is pulse time.	<input type="checkbox"/>	Refer as ANSI C63.10, clause 7.5 average value of pulsed emissions.	<input checked="" type="checkbox"/>	Refer as FCC KDB 789033 D02, clause G)5) measurement procedure peak limit.	<input type="checkbox"/>	Refer as ANSI C63.10, clause 4.1.4.2.2 measurement procedure peak limit.
	<ul style="list-style-type: none"> ▪ Refer as FCC KDB 789033 D02, clause G)2) for unwanted emissions into non-restricted bands. ▪ Refer as FCC KDB 789033 D02, clause G)1) for unwanted emissions into restricted bands. 														
<input type="checkbox"/>	Refer as FCC KDB 789033 D02, G)6) Method AD (Trace Averaging).														
<input checked="" type="checkbox"/>	Refer as FCC KDB 789033 D02, G)6) Method VB (Reduced VBW).														
<input type="checkbox"/>	Refer as ANSI C63.10, clause 11.12.2.5.3 (Reduced VBW). VBW ≥ 1/T, where T is pulse time.														
<input type="checkbox"/>	Refer as ANSI C63.10, clause 7.5 average value of pulsed emissions.														
<input checked="" type="checkbox"/>	Refer as FCC KDB 789033 D02, clause G)5) measurement procedure peak limit.														
<input type="checkbox"/>	Refer as ANSI C63.10, clause 4.1.4.2.2 measurement procedure peak limit.														
	<ul style="list-style-type: none"> ▪ For radiated measurement. <table border="1" style="width: 100%; border-collapse: collapse;"> <tr> <td style="width: 5%;"></td> <td> <ul style="list-style-type: none"> ▪ Refer as ANSI C63.10, clause 6.4 for radiated emissions below 30 MHz and test distance is 3m. ▪ Refer as ANSI C63.10, clause 6.5 for radiated emissions 30 MHz to 1 GHz and test distance is 3m. ▪ Refer as ANSI C63.10, clause 6.6 for radiated emissions above 1GHz. </td> </tr> </table> 		<ul style="list-style-type: none"> ▪ Refer as ANSI C63.10, clause 6.4 for radiated emissions below 30 MHz and test distance is 3m. ▪ Refer as ANSI C63.10, clause 6.5 for radiated emissions 30 MHz to 1 GHz and test distance is 3m. ▪ Refer as ANSI C63.10, clause 6.6 for radiated emissions above 1GHz. 												
	<ul style="list-style-type: none"> ▪ Refer as ANSI C63.10, clause 6.4 for radiated emissions below 30 MHz and test distance is 3m. ▪ Refer as ANSI C63.10, clause 6.5 for radiated emissions 30 MHz to 1 GHz and test distance is 3m. ▪ Refer as ANSI C63.10, clause 6.6 for radiated emissions above 1GHz. 														
	<ul style="list-style-type: none"> ▪ The any unwanted emissions level shall not exceed the fundamental emission level. 														

Test Method

- All amplitude of spurious emissions that are attenuated by more than 20 dB below the permissible value has no need to be reported.

3.5.4 Test Setup

Transmitter Radiated Unwanted Emissions

9kHz ~30MHz

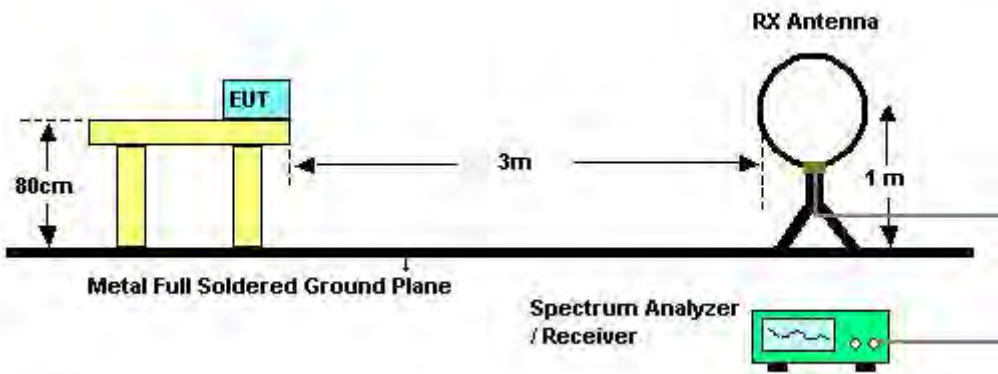

30MHz~1GHz

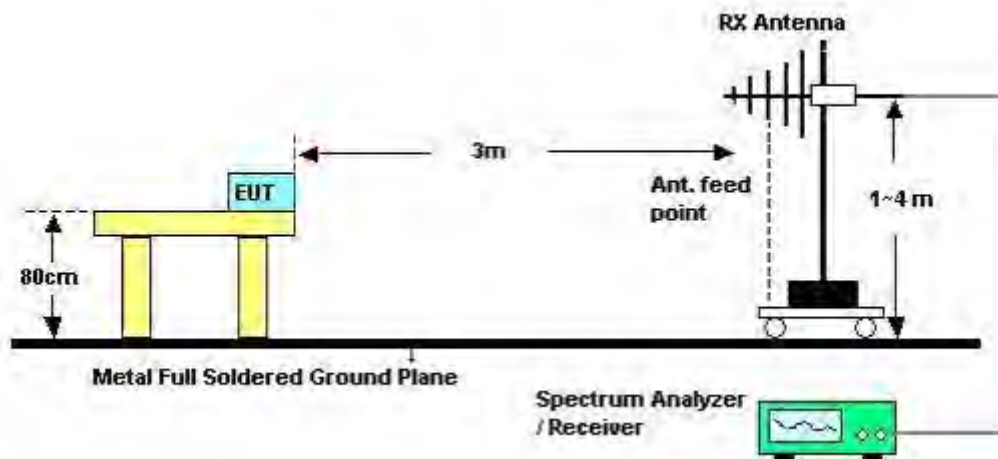

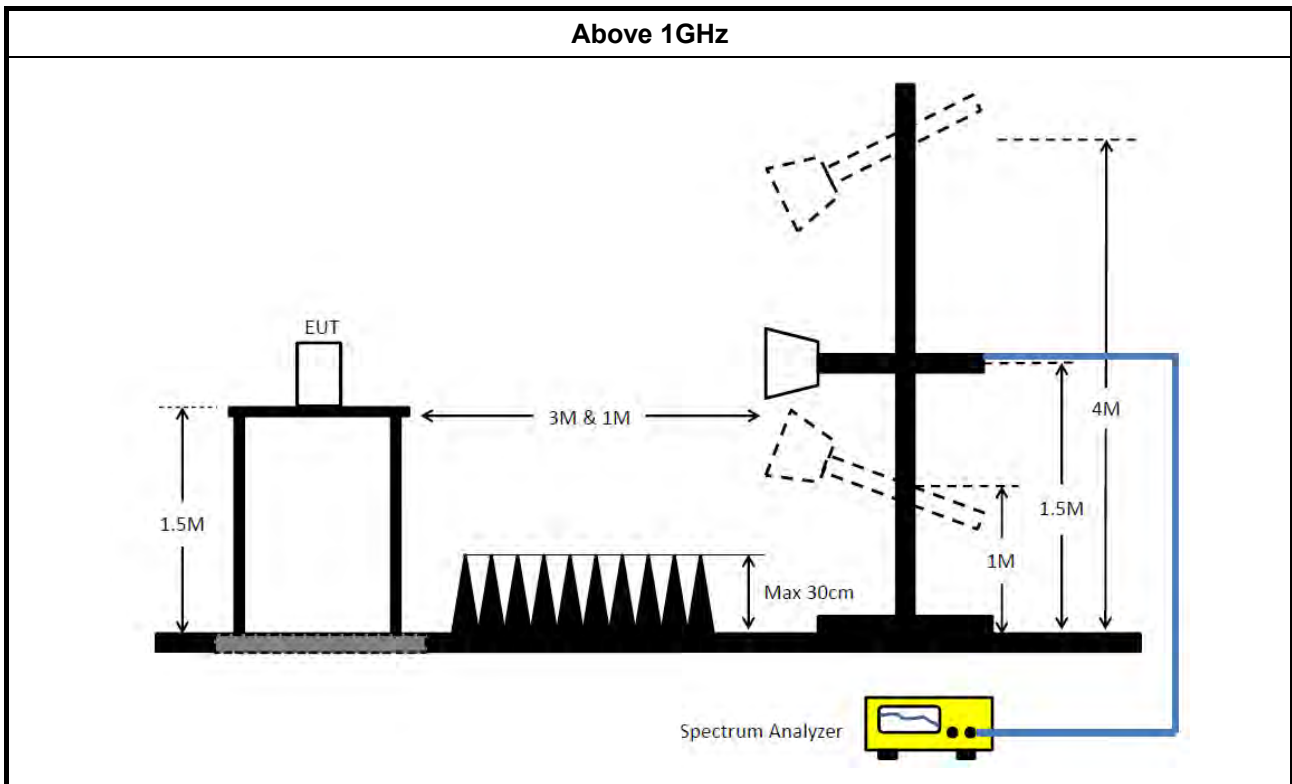

3.5.5 Measurement Results Calculation

The measured Level is calculated using:

Corrected Reading: Antenna factor (AF) + Cable loss (CL) + Read level (Raw) - Preamp factor (PA)(if applicable) = Level.

3.5.6 Transmitter Unwanted Emissions (Below 30MHz)

There is a comparison data of both open-field test site and alternative test site - semi-Anechoic chamber according to KDB414788 Radiated Test Site, and the result came out very similar.

All amplitude of spurious emissions that are attenuated by more than 20 dB below the permissible value has no need to be reported.

The radiated emissions were investigated from 9 kHz or the lowest frequency generated within the device, up to the 10th harmonic or 40 GHz, whichever is appropriate.

3.5.7 Test Result of Transmitter Unwanted Emissions

Refer as Appendix E



4 Test Equipment and Calibration Data

Instrument	Brand	Model No.	Serial No.	Characteristics	Calibration Date	Calibration Due Date	Remark
LISN	Schwarzbeck	NSLK 8127	8127650	9kHz ~ 30MHz	Jan. 07, 2022	Jan. 06, 2023	Conduction (CO02-CB)
LISN	Schwarzbeck	NSLK 8127	8127478	9kHz ~ 30MHz	Dec. 22, 2021	Dec. 21, 2022	Conduction (CO02-CB)
EMI Receiver	Agilent	N9038A	MY52260140	9kHz ~ 8.4GHz	May 06, 2022	May 05, 2023	Conduction (CO02-CB)
COND Cable	Woken	Cable	2	0.15MHz ~ 30MHz	Oct. 19, 2021	Oct. 18, 2022	Conduction (CO02-CB)
Pulse Limiter	Schwarzbeck	VTSD 9561F-N	00378	9kHz ~ 30MHz	Mar. 18, 2022	Mar. 17, 2023	Conduction (CO02-CB)
Software	SPORTON	SENSE	V5.10	-	N.C.R.	N.C.R.	Conduction (CO02-CB)
Loop Antenna	Teseq	HLA 6120	24155	9kHz - 30 MHz	May 14, 2022	May 13, 2023	Radiation (03CH05-CB)
3m Semi Anechoic Chamber NSA	TDK	SAC-3M	03CH05-CB	30 MHz ~ 1 GHz	Aug. 03, 2022	Aug. 02, 2023	Radiation (03CH05-CB)
Bilog Antenna with 6dB Attenuator	TESEQ & EMCI	CBL 6112D & N-6-06	35236 & AT-N0610	30MHz ~ 2GHz	Mar. 25, 2022	Mar. 24, 2023	Radiation (03CH05-CB)
Pre-Amplifier	EMCI	EMC330N	980331	20MHz ~ 3GHz	Apr. 26, 2022	Apr. 25, 2023	Radiation (03CH05-CB)
Spectrum Analyzer	R&S	FSP40	100304	9kHz ~ 40GHz	Mar. 14, 2022	Mar. 13, 2023	Radiation (03CH05-CB)
EMI Test Receiver	R&S	ESCS	826547/017	9kHz ~ 2.75GHz	Jun. 17, 2022	Jun. 16, 2023	Radiation (03CH05-CB)
RF Cable-low	Woken	RG402	Low Cable-04+23	30MHz~1GHz	Oct. 13, 2021	Oct. 12, 2022	Radiation (03CH05-CB)
Test Software	SPORTON	SENSE	V5.10	-	N.C.R.	N.C.R.	Radiation (03CH05-CB)
3m Semi Anechoic Chamber VSWR	TDK	SAC-3M	03CH01-CB	1GHz ~18GHz 3m	May 06, 2022	May 05, 2023	Radiation (03CH01-CB)
Horn Antenna	ETS-LINDGREN	3115	00075790	750MHz ~ 18GHz	Nov. 06, 2021	Nov. 05, 2022	Radiation (03CH01-CB)
Horn Antenna	SCHWARZBECK	BBHA 9170	BBHA9170507	15GHz ~ 40GHz	Jul. 05, 2022	Jul. 04, 2023	Radiation (03CH01-CB)
Pre-Amplifier	Agilent	8449B	3008A02121	1GHz ~ 26.5GHz	May 19, 2022	May 18, 2023	Radiation (03CH01-CB)
Pre-Amplifier	MITEQ	TTA1840-35-HG	1864479	18GHz ~ 40GHz	Jul. 20, 2022	Jul. 19, 2023	Radiation (03CH01-CB)
Spectrum Analyzer	R&S	FSP40	100056	9kHz ~ 40GHz	May 06, 2022	May 05, 2023	Radiation (03CH01-CB)
RF Cable-high	Woken	RG402	High Cable-16	1 GHz ~ 18 GHz	Oct. 04, 2021	Oct. 03, 2022	Radiation (03CH01-CB)



Instrument	Brand	Model No.	Serial No.	Characteristics	Calibration Date	Calibration Due Date	Remark
RF Cable-high	Woken	RG402	High Cable-16+17	1 GHz ~ 18 GHz	Oct. 04, 2021	Oct. 03, 2022	Radiation (03CH01-CB)
High Cable	Woken	WCA0929M	40G#5+7	1GHz ~ 40 GHz	Dec. 14, 2021	Dec. 13, 2022	Radiation (03CH01-CB)
High Cable	Woken	WCA0929M	40G#5	1GHz ~ 40 GHz	Dec. 08, 2021	Dec. 07, 2022	Radiation (03CH01-CB)
High Cable	Woken	WCA0929M	40G#7	1GHz ~ 40 GHz	Dec. 14, 2021	Dec. 13, 2022	Radiation (03CH01-CB)
Test Software	SPORTON	SENSE	V5.10	-	N.C.R.	N.C.R.	Radiation (03CH01-CB)
3m Semi Anechoic Chamber VSWR	TDK	SAC-3M	03CH03-CB	1GHz ~18GHz 3m	May 05, 2022	May 04, 2023	Radiation (03CH03-CB)
Horn Antenna	ETS • Lindgren	3115	6821	750MHz~18GHz z	Jan. 21, 2022	Jan. 20, 2023	Radiation (03CH03-CB)
Horn Antenna	SCHWARZBECK	BBHA 9170	BBHA9170507	15GHz ~ 40GHz	Jul. 05, 2022	Jul. 04, 2023	Radiation (03CH03-CB)
Pre-Amplifier	Agilent	8449B	3008A02097	1GHz ~ 26.5GHz	Jul. 01, 2022	Jun. 30, 2023	Radiation (03CH03-CB)
Pre-Amplifier	MITEQ	TTA1840-35-HG	1864479	18GHz ~ 40GHz	Jul. 20, 2022	Jul. 19, 2023	Radiation (03CH03-CB)
Spectrum Analyzer	R&S	FSP40	100019	9kHz ~ 40GHz	Jun. 10, 2022	Jun. 09, 2023	Radiation (03CH03-CB)
RF Cable-high	Woken	RG402	High Cable-20+29	1GHz ~ 18GHz	Oct. 04, 2021	Oct. 03, 2022	Radiation (03CH03-CB)
RF Cable-high	Woken	RG402	High Cable-29	1GHz ~ 18GHz	Oct. 04, 2021	Oct. 03, 2022	Radiation (03CH03-CB)
High Cable	Woken	WCA0929M	40G#5+7	1GHz ~ 40 GHz	Dec. 14, 2021	Dec. 13, 2022	Radiation (03CH03-CB)
High Cable	Woken	WCA0929M	40G#5	1GHz ~ 40 GHz	Dec. 08, 2021	Dec. 07, 2022	Radiation (03CH03-CB)
High Cable	Woken	WCA0929M	40G#7	1GHz ~ 40 GHz	Dec. 14, 2021	Dec. 13, 2022	Radiation (03CH03-CB)
Test Software	SPORTON	SENSE	V5.10	-	N.C.R.	N.C.R.	Radiation (03CH03-CB)
3m Semi Anechoic Chamber VSWR	TDK	SAC-3M	03CH06-CB	1GHz ~18GHz 3m	Oct. 01, 2021	Sep. 30, 2022	Radiation (03CH06-CB)
Horn Antenna	SCHWARZBECK	BBHA9120D	BBHA 9120D-1292	1GHz~18GHz	Aug. 09, 2022	Aug. 08, 2023	Radiation (03CH06-CB)
Horn Antenna	SCHWARZBECK	BBHA 9170	BBHA9170507	15GHz ~ 40GHz	Jul. 05, 2022	Jul. 04, 2023	Radiation (03CH06-CB)
Pre-Amplifier	Agilent	83017A	MY53270064	0.5GHz ~ 26.5GHz	Aug 02, 2022	Aug 01, 2023	Radiation (03CH06-CB)
Pre-Amplifier	MITEQ	TTA1840-35-HG	1864479	18GHz ~ 40GHz	Jul. 20, 2022	Jul. 19, 2023	Radiation (03CH06-CB)
Spectrum analyzer	R&S	FSP40	100080	9kHz~40GHz	Dec. 24, 2021	Dec. 23, 2022	Radiation (03CH06-CB)



Instrument	Brand	Model No.	Serial No.	Characteristics	Calibration Date	Calibration Due Date	Remark
RF Cable-high	Woken	RG402	High Cable-67	1GHz~18GHz	Feb. 24, 2022	Feb. 23, 2023	Radiation (03CH06-CB)
RF Cable-high	Woken	RG402	High Cable-05+67	1GHz~18GHz	Feb. 24, 2022	Feb. 23, 2023	Radiation (03CH06-CB)
High Cable	Woken	WCA0929M	40G#5+7	1GHz ~ 40 GHz	Dec. 14, 2021	Dec. 13, 2022	Radiation (03CH06-CB)
High Cable	Woken	WCA0929M	40G#5	1GHz ~ 40 GHz	Dec. 08, 2021	Dec. 07, 2022	Radiation (03CH06-CB)
High Cable	Woken	WCA0929M	40G#7	1GHz ~ 40 GHz	Dec. 14, 2021	Dec. 13, 2022	Radiation (03CH06-CB)
Test Software	SPORTON	SENSE	V5.10	-	N.C.R.	N.C.R.	Radiation (03CH06-CB)
Spectrum analyzer	R&S	FSV40	101028	9kHz~40GHz	Jan. 07, 2022	Jan. 06, 2023	Conducted (TH03-CB)
Power Sensor	Anritsu	MA2411B	1531344	300MHz~40GHz	Jul. 31, 2022	Jul. 30, 2023	Conducted (TH03-CB)
Power Meter	Anritsu	ML2495A	1728002	300MHz~40GHz	Jul. 31, 2022	Jul. 30, 2023	Conducted (TH03-CB)
RF Cable-high	Woken	RG402	High Cable-11	1 GHz ~18 GHz	Oct. 04, 2021	Oct. 03, 2022	Conducted (TH03-CB)
RF Cable-high	Woken	RG402	High Cable-12	1 GHz ~18 GHz	Oct. 04, 2021	Oct. 03, 2022	Conducted (TH03-CB)
RF Cable-high	Woken	RG402	High Cable-13	1 GHz ~18 GHz	Oct. 04, 2021	Oct. 03, 2022	Conducted (TH03-CB)
RF Cable-high	Woken	RG402	High Cable-14	1 GHz ~18 GHz	Oct. 04, 2021	Oct. 03, 2022	Conducted (TH03-CB)
RF Cable-high	Woken	RG402	High Cable-15	1 GHz ~18 GHz	Oct. 04, 2021	Oct. 03, 2022	Conducted (TH03-CB)
Switch	SPTCB	SP-SWI	SWI-03	1 GHz ~26.5 GHz	Dec. 13, 2021	Dec. 12, 2022	Conducted (TH03-CB)
RF Cable-high	Woken	RG402	SWI-03-P1	1 GHz ~26.5 GHz	Dec. 13, 2021	Dec. 12, 2022	Conducted (TH03-CB)
RF Cable-high	Woken	RG402	SWI-03-P2	1 GHz ~26.5 GHz	Dec. 13, 2021	Dec. 12, 2022	Conducted (TH03-CB)
RF Cable-high	Woken	RG402	SWI-03-P3	1 GHz ~26.5 GHz	Dec. 13, 2021	Dec. 12, 2022	Conducted (TH03-CB)
RF Cable-high	Woken	RG402	SWI-03-P4	1 GHz ~26.5 GHz	Dec. 13, 2021	Dec. 12, 2022	Conducted (TH03-CB)
RF Cable-high	Woken	RG402	SWI-03-P5	1 GHz ~26.5 GHz	Dec. 13, 2021	Dec. 12, 2022	Conducted (TH03-CB)
Test Software	SPORTON	SENSE	V5.10	-	N.C.R.	N.C.R.	Conducted (TH03-CB)

Note: Calibration Interval of instruments listed above is one year.

NCR means Non-Calibration required.



Summary

Mode	Result	Type	Freq (Hz)	Level (dBuV)	Limit (dBuV)	Margin (dB)	Condition
Mode 1	Pass	AV	424.5k	36.12	47.36	-11.24	Neutral

Mode 1

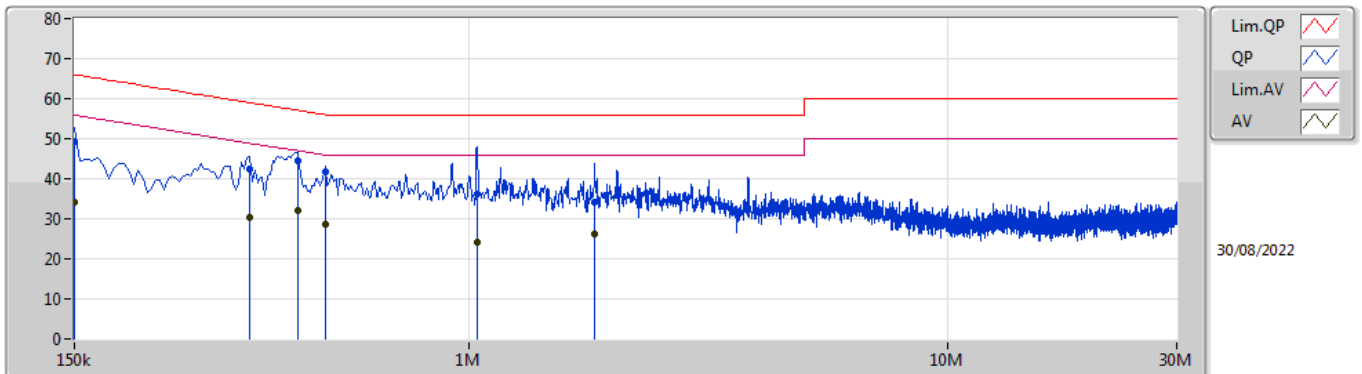

Type	Freq (Hz)	Level (dBuV)	Limit (dBuV)	Margin (dB)	Factor (dB)	Condition	Comment	Raw (dBuV)	LISN (dB)	CL (dB)	AT (dB)
QP	150k	49.33	66.00	-16.67	10.25	Line	-	39.08	0.12	0.02	10.11
AV	150k	34.31	56.00	-21.69	10.25	Line	-	24.06	0.12	0.02	10.11
QP	348k	42.39	59.00	-16.61	10.24	Line	-	32.15	0.12	0.02	10.10
AV	348k	30.29	49.00	-18.71	10.24	Line	-	20.05	0.12	0.02	10.10
QP	438k	44.51	57.11	-12.60	10.25	Line	"Worst"	34.26	0.12	0.02	10.11
AV	438k	32.12	47.11	-14.99	10.25	Line	-	21.87	0.12	0.02	10.11
QP	500k	41.67	56.00	-14.33	10.26	Line	-	31.41	0.12	0.02	10.12
AV	500k	28.61	46.00	-17.39	10.26	Line	-	18.35	0.12	0.02	10.12
QP	1.041M	36.04	56.00	-19.96	10.30	Line	-	25.74	0.14	0.02	10.14
AV	1.041M	24.26	46.00	-21.74	10.30	Line	-	13.96	0.14	0.02	10.14
QP	1.829M	34.03	56.00	-21.97	10.37	Line	-	23.66	0.17	0.05	10.15
AV	1.829M	26.04	46.00	-19.96	10.37	Line	-	15.67	0.17	0.05	10.15

Mode 1

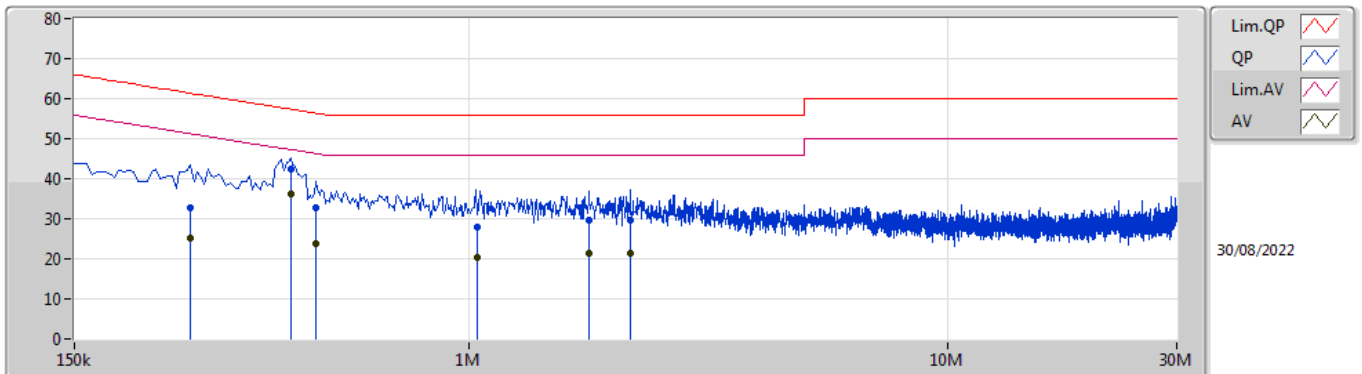

Type	Freq (Hz)	Level (dBuV)	Limit (dBuV)	Margin (dB)	Factor (dB)	Condition	Comment	Raw (dBuV)	LISN (dB)	CL (dB)	AT (dB)
QP	262.5k	32.90	61.35	-28.45	10.26	Neutral	-	22.64	0.16	0.02	10.08
AV	262.5k	25.19	51.35	-26.16	10.26	Neutral	-	14.93	0.16	0.02	10.08
QP	424.5k	42.38	57.36	-14.98	10.29	Neutral	-	32.09	0.16	0.02	10.11
AV	424.5k	36.12	47.36	-11.24	10.29	Neutral	"Worst"	25.83	0.16	0.02	10.11
QP	478.5k	32.91	56.36	-23.45	10.30	Neutral	-	22.61	0.16	0.02	10.12
AV	478.5k	23.74	46.36	-22.62	10.30	Neutral	-	13.44	0.16	0.02	10.12
QP	1.037M	27.91	56.00	-28.09	10.33	Neutral	-	17.58	0.17	0.02	10.14
AV	1.037M	20.30	46.00	-25.70	10.33	Neutral	-	9.97	0.17	0.02	10.14
QP	1.779M	29.64	56.00	-26.36	10.38	Neutral	-	19.26	0.19	0.04	10.15
AV	1.779M	21.52	46.00	-24.48	10.38	Neutral	-	11.14	0.19	0.04	10.15
QP	2.171M	29.69	56.00	-26.31	10.39	Neutral	-	19.30	0.19	0.05	10.15
AV	2.171M	21.47	46.00	-24.53	10.39	Neutral	-	11.08	0.19	0.05	10.15

Summary

Mode	Max-N dB (Hz)	Max-OBW (Hz)	ITU-Code	Min-N dB (Hz)	Min-OBW (Hz)
5.15-5.25GHz	-	-	-	-	-
802.11a_Nss1,(6Mbps)_2TX	19.59M	16.462M	16M5D1D	19.35M	16.402M
802.11ax HEW20_Nss1,(MCS0)_2TX	21.39M	18.951M	19M0D1D	21.3M	18.921M
802.11ax HEW40_Nss1,(MCS0)_2TX	41.46M	37.901M	37M9D1D	40.92M	37.901M
802.11ax HEW20-BF_Nss1,(MCS0)_2TX	21.27M	18.921M	18M9D1D	21.24M	18.921M
802.11ax HEW40-BF_Nss1,(MCS0)_2TX	41.22M	37.961M	38M0D1D	41.1M	37.841M
5.25-5.35GHz	-	-	-	-	-
802.11ax HEW40_Nss1,(MCS0)_2TX	41.22M	37.961M	38M0D1D	41.04M	37.901M
802.11ax HEW80_Nss1,(MCS0)_2TX	82.8M	77.601M	77M6D1D	82.2M	77.241M
5.725-5.85GHz	-	-	-	-	-
802.11ax HEW40-BF_Nss1,(MCS0)_4TX	38.04M	38.021M	38M0D1D	37.14M	37.781M

Max-N dB = Maximum 6dB down bandwidth for 5.725-5.85GHz band / Maximum 26dB down bandwidth for other band;
 Max-OBW = Maximum 99% occupied bandwidth;
 Min-N dB = Minimum 6dB down bandwidth for 5.725-5.85GHz band / Maximum 26dB down bandwidth for other band;
 Min-OBW = Minimum 99% occupied bandwidth

Result

Mode	Result	Limit (Hz)	Port 1-N dB (Hz)	Port 1-OBW (Hz)	Port 2-N dB (Hz)	Port 2-OBW (Hz)	Port 3-N dB (Hz)	Port 3-OBW (Hz)	Port 4-N dB (Hz)	Port 4-OBW (Hz)
802.11a_Nss1,(6Mbps)_2TX	-	-	-	-	-	-	-	-	-	-
5180MHz	Pass	Inf	19.47M	16.432M	19.35M	16.402M				
5200MHz	Pass	Inf	19.59M	16.462M	19.38M	16.432M				
802.11ax HEW20_Nss1,(MCS0)_2TX	-	-	-	-	-	-	-	-	-	-
5200MHz	Pass	Inf	21.39M	18.921M	21.3M	18.951M				
802.11ax HEW40_Nss1,(MCS0)_2TX	-	-	-	-	-	-	-	-	-	-
5190MHz	Pass	Inf	41.46M	37.901M	40.92M	37.901M				
5310MHz	Pass	Inf	41.04M	37.901M	41.22M	37.961M				
802.11ax HEW80_Nss1,(MCS0)_2TX	-	-	-	-	-	-	-	-	-	-
5290MHz	Pass	Inf	82.8M	77.241M	82.2M	77.601M				
802.11ax HEW20-BF_Nss1,(MCS0)_2TX	-	-	-	-	-	-	-	-	-	-
5180MHz	Pass	Inf	21.27M	18.921M	21.24M	18.921M				
802.11ax HEW40-BF_Nss1,(MCS0)_2TX	-	-	-	-	-	-	-	-	-	-
5190MHz	Pass	Inf	41.22M	37.841M	41.1M	37.961M				
802.11ax HEW40-BF_Nss1,(MCS0)_4TX	-	-	-	-	-	-	-	-	-	-
5755MHz	Pass	500k	38.04M	37.961M	37.14M	37.781M	37.92M	38.021M	37.68M	37.961M

Port X-N dB = Port X 6dB down bandwidth for 5.725-5.85GHz band / 26dB down bandwidth for other band
 Port X-OBW = Port X 99% occupied bandwidth

802.11a_Nss1,(6Mbps)_2TX

EBW

5180MHz

23/08/2022

CF
5.18GHz
Span
60MHz
RBW
300kHz
VBW
1MHz
Sweep Time
100ms
Detector Type
Peak

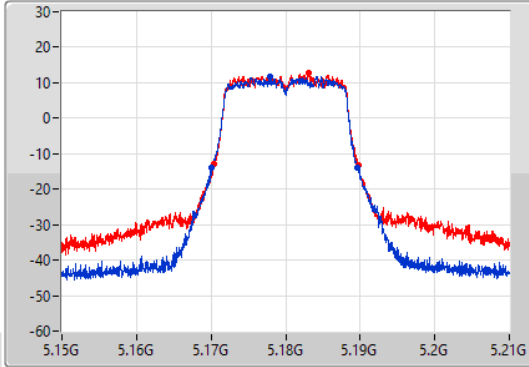

CF
5.18GHz
Span
60MHz
RBW
300kHz
VBW
1MHz
Sweep Time
100ms
Detector Type
Peak

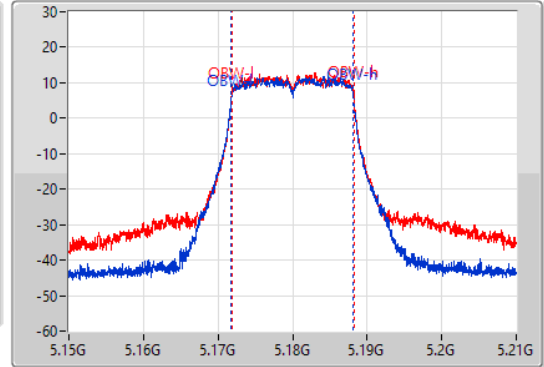

26dB(Hz)	Fl-26dB(Hz)	Fh-26dB(Hz)	OBW(Hz)	Fl-OBW(Hz)	Fh-OBW(Hz)	Limit(Hz)	Port
19.47M	5.17013G	5.1896G	16.432M	5.171754G	5.188186G	Inf	1
19.35M	5.1704G	5.18975G	16.402M	5.171814G	5.188216G	Inf	2

802.11a_Nss1,(6Mbps)_2TX

EBW

5200MHz

23/08/2022

CF
5.2GHz
Span
60MHz
RBW
300kHz
VBW
1MHz
Sweep Time
100ms
Detector Type
Peak

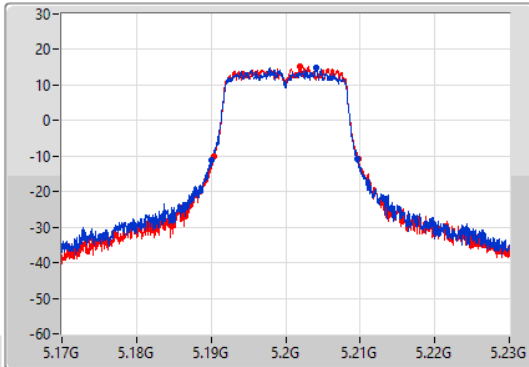

CF
5.2GHz
Span
60MHz
RBW
300kHz
VBW
1MHz
Sweep Time
100ms
Detector Type
Peak

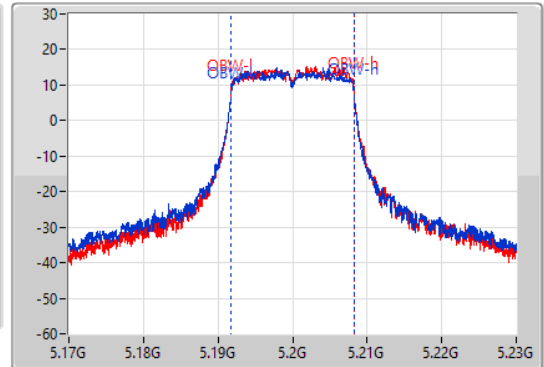

26dB(Hz)	Fl-26dB(Hz)	Fh-26dB(Hz)	OBW(Hz)	Fl-OBW(Hz)	Fh-OBW(Hz)	Limit(Hz)	Port
19.59M	5.19007G	5.20966G	16.462M	5.191754G	5.208216G	Inf	1
19.38M	5.19037G	5.20975G	16.432M	5.191784G	5.208216G	Inf	2

802.11ax HEW20_Nss1,(MCS0)_2TX

EBW

5200MHz

23/08/2022

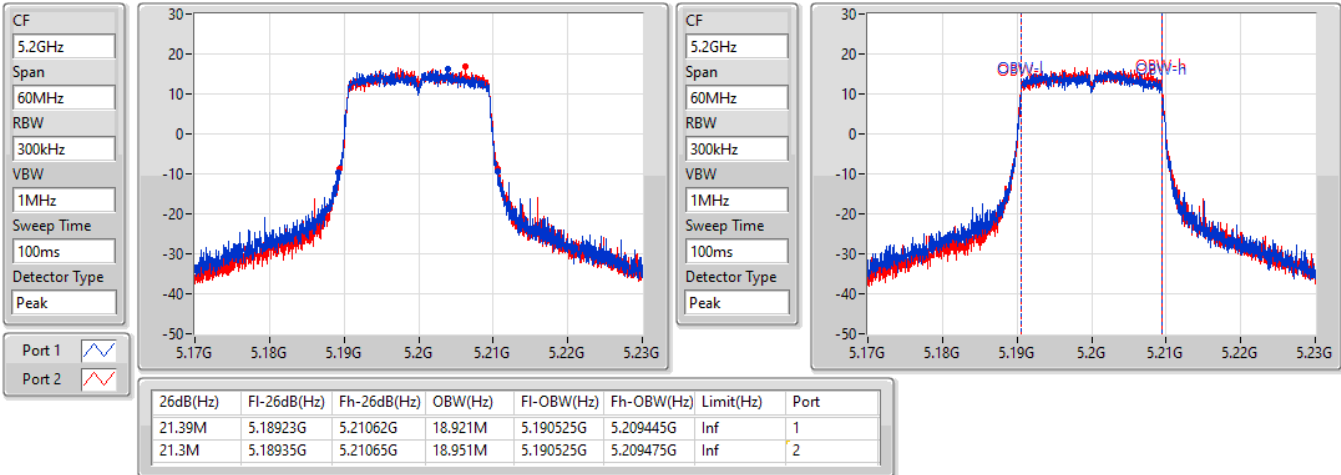

802.11ax HEW40_Nss1,(MCS0)_2TX

EBW

5190MHz

23/08/2022

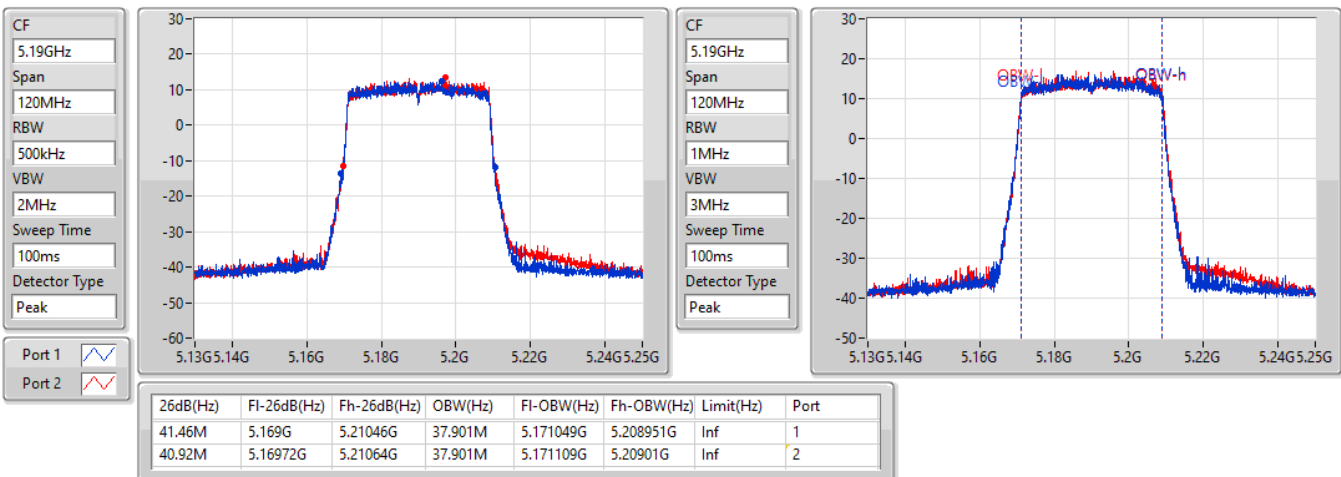

802.11ax HEW40_Nss1,(MCS0)_2TX

EBW

5310MHz

23/08/2022

CF
5.31GHz
Span
120MHz
RBW
500kHz
VBW
2MHz
Sweep Time
100ms
Detector Type
Peak

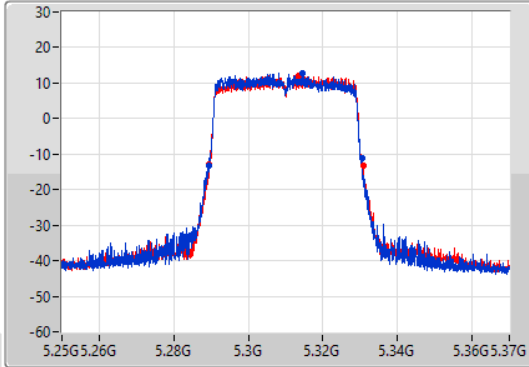

CF
5.31GHz
Span
120MHz
RBW
1MHz
VBW
3MHz
Sweep Time
100ms
Detector Type
Peak

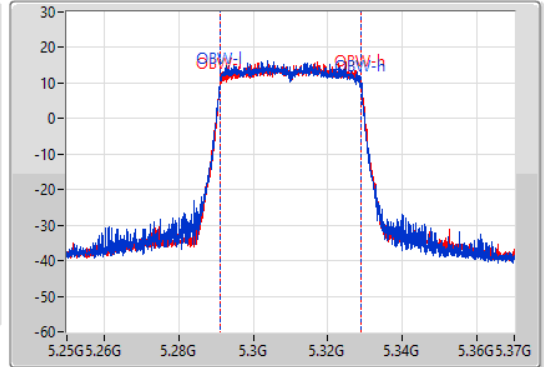

26dB(Hz)	Fl-26dB(Hz)	Fh-26dB(Hz)	OBW(Hz)	Fl-OBW(Hz)	Fh-OBW(Hz)	Limit(Hz)	Port
41.04M	5.28936G	5.3304G	37.901M	5.29099G	5.328891G	Inf	1
41.22M	5.28954G	5.33076G	37.961M	5.291049G	5.32901G	Inf	2

802.11ax HEW80_Nss1,(MCS0)_2TX

EBW

5290MHz

23/08/2022

CF
5.29GHz
Span
240MHz
RBW
1MHz
VBW
3MHz
Sweep Time
100ms
Detector Type
Peak

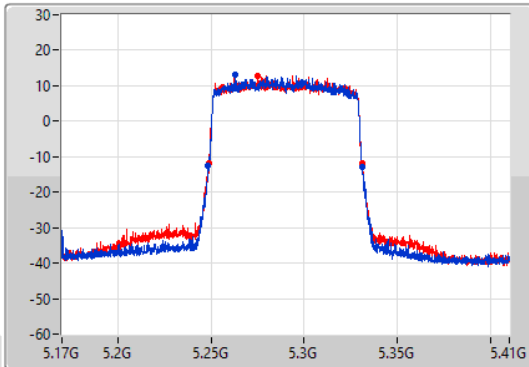

CF
5.29GHz
Span
240MHz
RBW
2MHz
VBW
10MHz
Sweep Time
100ms
Detector Type
Peak

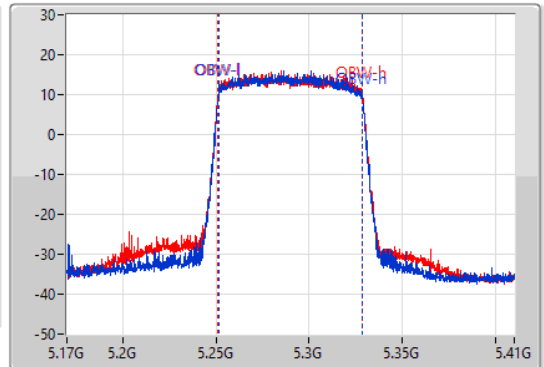

26dB(Hz)	Fl-26dB(Hz)	Fh-26dB(Hz)	OBW(Hz)	Fl-OBW(Hz)	Fh-OBW(Hz)	Limit(Hz)	Port
82.8M	5.24848G	5.33128G	77.241M	5.251259G	5.328501G	Inf	1
82.2M	5.24884G	5.33104G	77.601M	5.251019G	5.328621G	Inf	2

802.11ax HEW20-BF_Nss1,(MCS0)_2TX

EBW

5180MHz

23/08/2022

CF
5.18GHz
Span
60MHz
RBW
300kHz
VBW
1MHz
Sweep Time
100ms
Detector Type
Peak

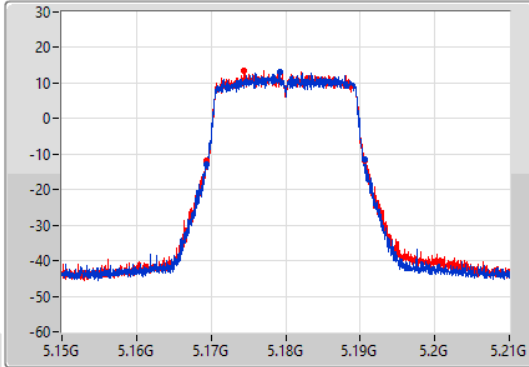

CF
5.18GHz
Span
60MHz
RBW
300kHz
VBW
1MHz
Sweep Time
100ms
Detector Type
Peak

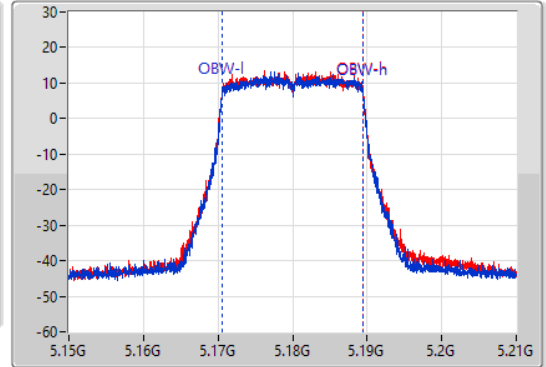

26dB(Hz)	Fl-26dB(Hz)	Fh-26dB(Hz)	OBW(Hz)	Fl-OBW(Hz)	Fh-OBW(Hz)	Limit(Hz)	Port
21.27M	5.16932G	5.19059G	18.921M	5.170555G	5.189475G	Inf	1
21.24M	5.16944G	5.19068G	18.921M	5.170555G	5.189475G	Inf	2

802.11ax HEW40-BF_Nss1,(MCS0)_2TX

EBW

5190MHz

23/08/2022

CF
5.19GHz
Span
120MHz
RBW
500kHz
VBW
2MHz
Sweep Time
100ms
Detector Type
Peak

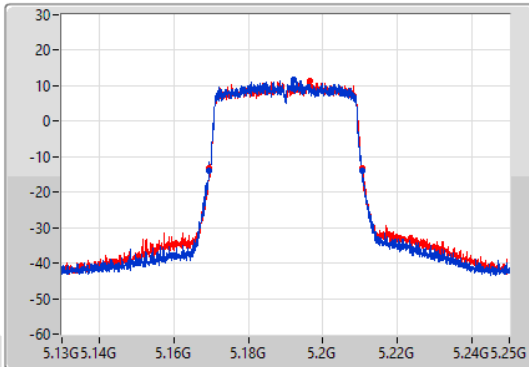

CF
5.19GHz
Span
120MHz
RBW
500kHz
VBW
2MHz
Sweep Time
100ms
Detector Type
Peak

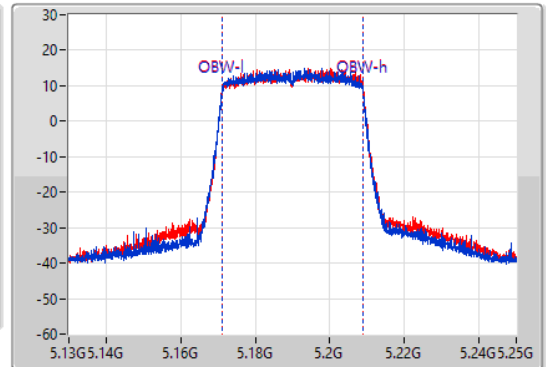

26dB(Hz)	Fl-26dB(Hz)	Fh-26dB(Hz)	OBW(Hz)	Fl-OBW(Hz)	Fh-OBW(Hz)	Limit(Hz)	Port
41.22M	5.16936G	5.21058G	37.841M	5.171049G	5.208891G	Inf	1
41.1M	5.16954G	5.21064G	37.961M	5.171049G	5.20901G	Inf	2

802.11ax HEW40-BF_Nss1,(MCS0)_4TX

EBW

5755MHz

23/08/2022

CF
5.755GHz
Span
120MHz
RBW
100kHz
VBW
300kHz
Sweep Time
100ms
Detector Type
Peak

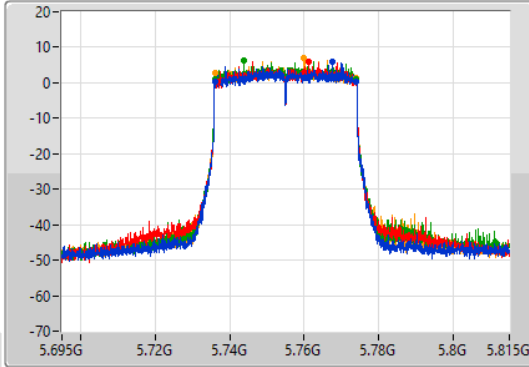

CF
5.755GHz
Span
120MHz
RBW
1MHz
VBW
3MHz
Sweep Time
100ms
Detector Type
Peak

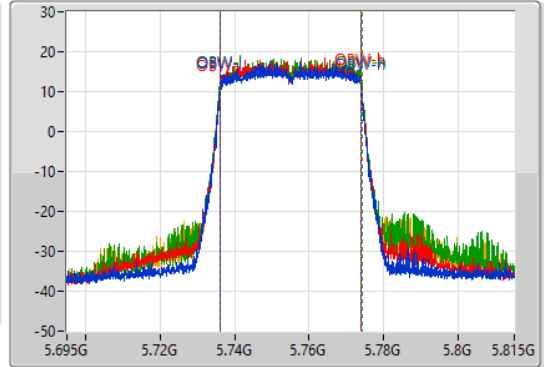

6dB(Hz)	Fl-6dB(Hz)	Fh-6dB(Hz)	OBW(Hz)	Fl-OBW(Hz)	Fh-OBW(Hz)	Limit(Hz)	Port
38.04M	5.73598G	5.77402G	37.961M	5.736049G	5.77401G	500k	1
37.14M	5.73664G	5.77378G	37.781M	5.736169G	5.773951G	500k	2
37.92M	5.7361G	5.77402G	38.021M	5.736049G	5.77407G	500k	3
37.68M	5.73622G	5.7739G	37.961M	5.736049G	5.77401G	500k	4

802.11ax HEW40-BF_Nss1,(MCS0)_4TX

EBW

5755MHz

23/08/2022

CF
5.755GHz
Span
120MHz
RBW
1MHz
VBW
3MHz
Sweep Time
100ms
Detector Type
Peak

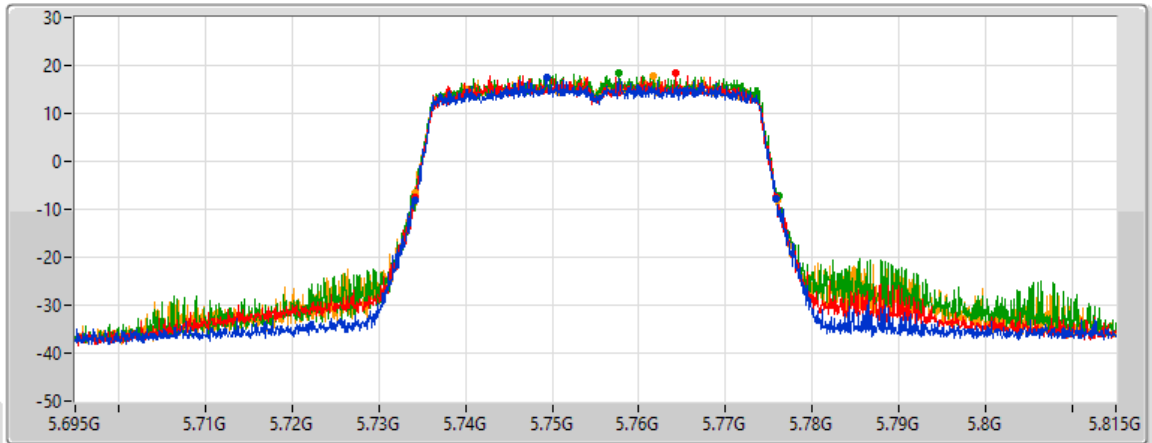

Port 1
Port 2
Port 3
Port 4

26dB(Hz)	Fl-26dB(Hz)	Fh-26dB(Hz)	Limit(Hz)	Port
41.76M	5.73412G	5.77588G	Inf	1
41.64M	5.73418G	5.77582G	Inf	2
42.12M	5.734G	5.77612G	Inf	3
41.88M	5.73418G	5.77606G	Inf	4



Summary

Mode	Total Power (dBm)	Total Power (W)
5.15-5.25GHz	-	-
802.11a_Nss1,(6Mbps)_2TX	25.79	0.37931
802.11ax HEW20_Nss1,(MCS0)_2TX	25.85	0.38459
802.11ax HEW40_Nss1,(MCS0)_2TX	22.45	0.17579
802.11ax HEW20-BF_Nss1,(MCS0)_2TX	22.46	0.17620
802.11ax HEW40-BF_Nss1,(MCS0)_2TX	21.13	0.12972
5.25-5.35GHz	-	-
802.11ax HEW40_Nss1,(MCS0)_2TX	22.32	0.17061
802.11ax HEW80_Nss1,(MCS0)_2TX	21.88	0.15417
5.725-5.85GHz	-	-
802.11ax HEW40-BF_Nss1,(MCS0)_4TX	27.91	0.61802



Result

Mode	Result	DG (dBi)	Port 1 (dBm)	Port 2 (dBm)	Port 3 (dBm)	Port 4 (dBm)	Total Power (dBm)	Power Limit (dBm)
802.11a_Nss1,(6Mbps)_2TX	-	-	-	-	-	-	-	-
5180MHz	Pass	4.66	19.96	20.42			23.21	30.00
5200MHz	Pass	4.66	22.66	22.90			25.79	30.00
802.11ax HEW20_Nss1,(MCS0)_2TX	-	-	-	-	-	-	-	-
5200MHz	Pass	4.66	22.66	23.01			25.85	30.00
802.11ax HEW40_Nss1,(MCS0)_2TX	-	-	-	-	-	-	-	-
5190MHz	Pass	4.66	19.36	19.51			22.45	30.00
5310MHz	Pass	3.87	19.40	19.22			22.32	23.98
802.11ax HEW80_Nss1,(MCS0)_2TX	-	-	-	-	-	-	-	-
5290MHz	Pass	3.87	18.94	18.79			21.88	23.98
802.11ax HEW20-BF_Nss1,(MCS0)_2TX	-	-	-	-	-	-	-	-
5180MHz	Pass	5.24	19.30	19.59			22.46	30.00
802.11ax HEW40-BF_Nss1,(MCS0)_2TX	-	-	-	-	-	-	-	-
5190MHz	Pass	5.24	18.11	18.13			21.13	30.00
802.11ax HEW40-BF_Nss1,(MCS0)_4TX	-	-	-	-	-	-	-	-
5755MHz	Pass	5.80	21.62	22.07	21.66	22.18	27.91	30.00

DG = Directional Gain; Port X = Port X output power

Summary

Mode	PD (dBm/RBW)
5.15-5.25GHz	-
802.11a_Nss1,(6Mbps)_2TX	13.13
802.11ax HEW20_Nss1,(MCS0)_2TX	12.63
802.11ax HEW40_Nss1,(MCS0)_2TX	6.44
802.11ax HEW20-BF_Nss1,(MCS0)_2TX	9.62
802.11ax HEW40-BF_Nss1,(MCS0)_2TX	5.50
5.25-5.35GHz	-
802.11ax HEW40_Nss1,(MCS0)_2TX	6.30
802.11ax HEW80_Nss1,(MCS0)_2TX	2.97
5.725-5.85GHz	-
802.11ax HEW40-BF_Nss1,(MCS0)_4TX	10.28

RBW = 500kHz for 5.725-5.85GHz band / 1MHz for other band;

Result

Mode	Result	DG (dBi)	Port 1 (dBm/RBW)	Port 2 (dBm/RBW)	Port 3 (dBm/RBW)	Port 4 (dBm/RBW)	PD (dBm/RBW)	PD Limit (dBm/RBW)
802.11a_Nss1,(6Mbps)_2TX	-	-	-	-	-	-	-	-
5180MHz	Pass	5.24	7.49	7.84			10.50	17.00
5200MHz	Pass	5.24	10.18	10.34			13.13	17.00
802.11ax HEW20_Nss1,(MCS0)_2TX	-	-	-	-	-	-	-	-
5200MHz	Pass	5.24	9.70	9.86			12.63	17.00
802.11ax HEW40_Nss1,(MCS0)_2TX	-	-	-	-	-	-	-	-
5190MHz	Pass	5.24	3.60	3.53			6.44	17.00
5310MHz	Pass	5.24	3.69	3.20			6.30	11.00
802.11ax HEW80_Nss1,(MCS0)_2TX	-	-	-	-	-	-	-	-
5290MHz	Pass	5.24	0.36	-0.11			2.97	11.00
802.11ax HEW20-BF_Nss1,(MCS0)_2TX	-	-	-	-	-	-	-	-
5180MHz	Pass	5.24	6.67	6.82			9.62	17.00
802.11ax HEW40-BF_Nss1,(MCS0)_2TX	-	-	-	-	-	-	-	-
5190MHz	Pass	5.24	2.66	2.52			5.50	17.00
802.11ax HEW40-BF_Nss1,(MCS0)_4TX	-	-	-	-	-	-	-	-
5755MHz	Pass	5.80	3.83	4.42	4.99	4.64	10.28	30.00

DG = Directional Gain; RBW = 500kHz for 5.725-5.85GHz band / 1MHz for other band;
 PD = trace bin-by-bin of each transmits port summing can be performed maximum power density; Port X = Port X Power Density;

802.11a_Nss1,(6Mbps)_2TX

PSD

5180MHz

23/08/2022

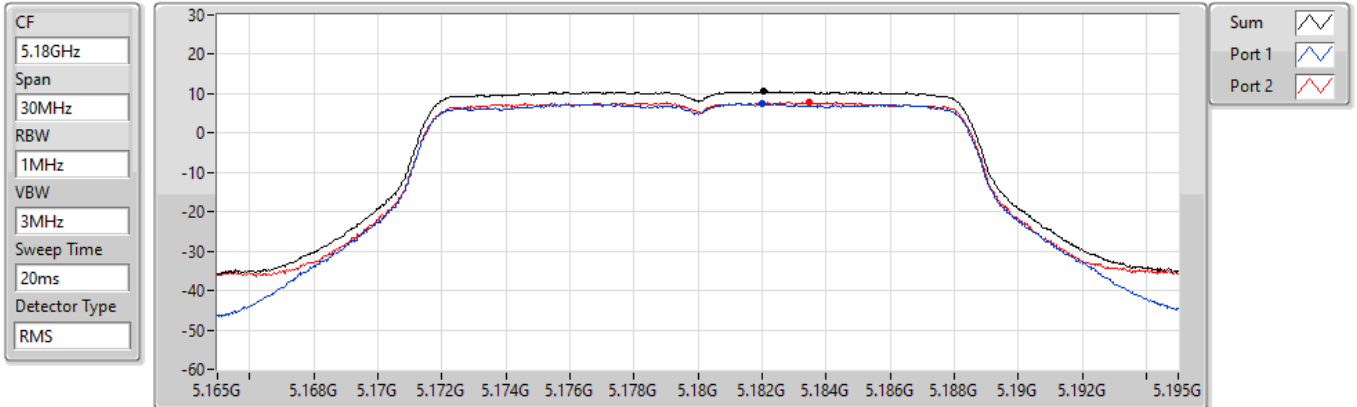

Sum	PD	Port 1	Port 2
(dBm/RBW)	(dBm/RBW)	(dBm/RBW)	(dBm/RBW)
10.50	10.50	7.49	7.84

802.11a_Nss1,(6Mbps)_2TX

PSD

5200MHz

23/08/2022

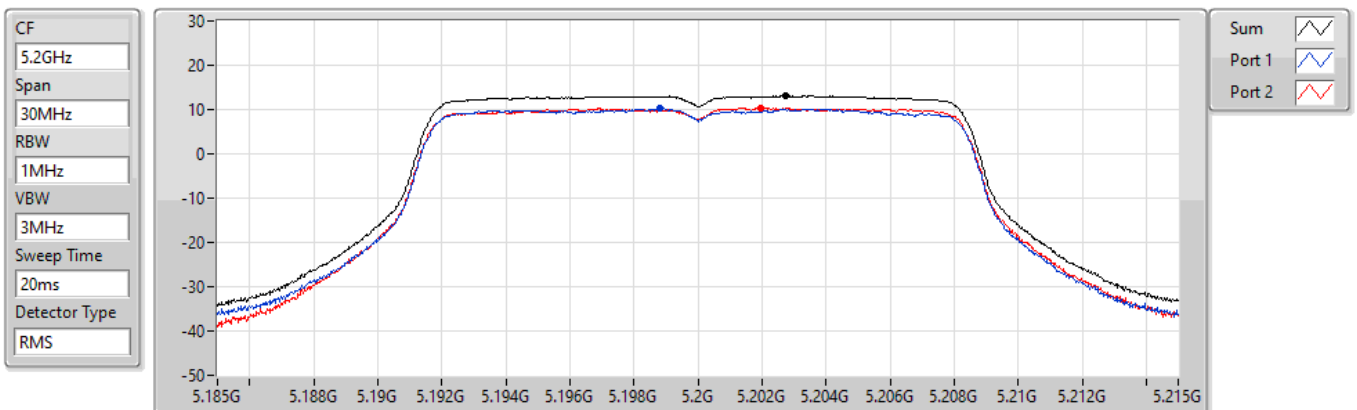

Sum	PD	Port 1	Port 2
(dBm/RBW)	(dBm/RBW)	(dBm/RBW)	(dBm/RBW)
13.13	13.13	10.18	10.34

802.11ax HEW20_Nss1,(MCS0)_2TX

PSD

5200MHz

23/08/2022

CF
5.2GHz

Span
30MHz

RBW
1MHz

VBW
3MHz

Sweep Time
20ms

Detector Type
RMS

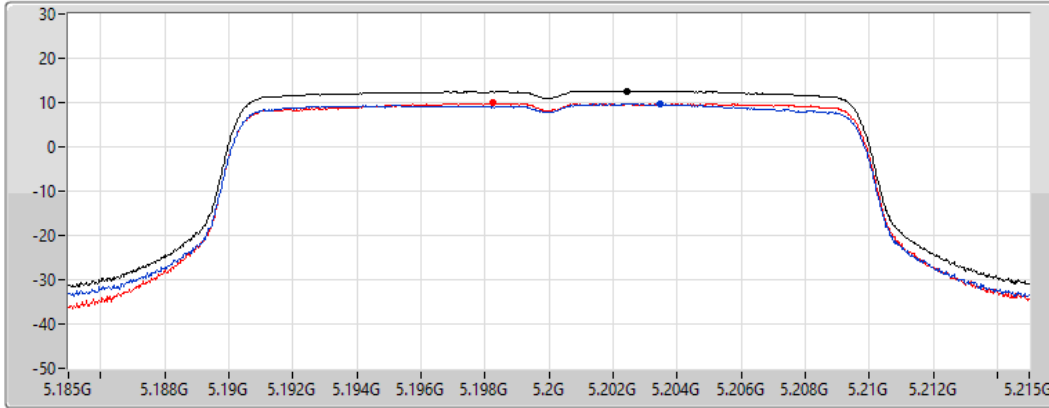

Sum

Port 1

Port 2

Sum	PD	Port 1	Port 2
(dBm/RBW)	(dBm/RBW)	(dBm/RBW)	(dBm/RBW)
12.63	12.63	9.70	9.86

802.11ax HEW40_Nss1,(MCS0)_2TX

PSD

5190MHz

23/08/2022

CF
5.19GHz

Span
60MHz

RBW
1MHz

VBW
3MHz

Sweep Time
20ms

Detector Type
RMS

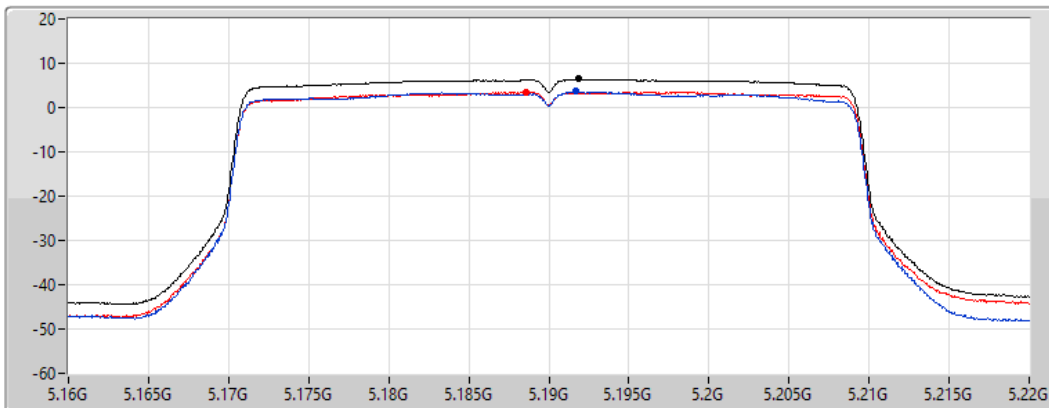

Sum

Port 1

Port 2

Sum	PD	Port 1	Port 2
(dBm/RBW)	(dBm/RBW)	(dBm/RBW)	(dBm/RBW)
6.44	6.44	3.60	3.53

802.11ax HEW40_Nss1,(MCS0)_2TX

PSD

5310MHz

23/08/2022

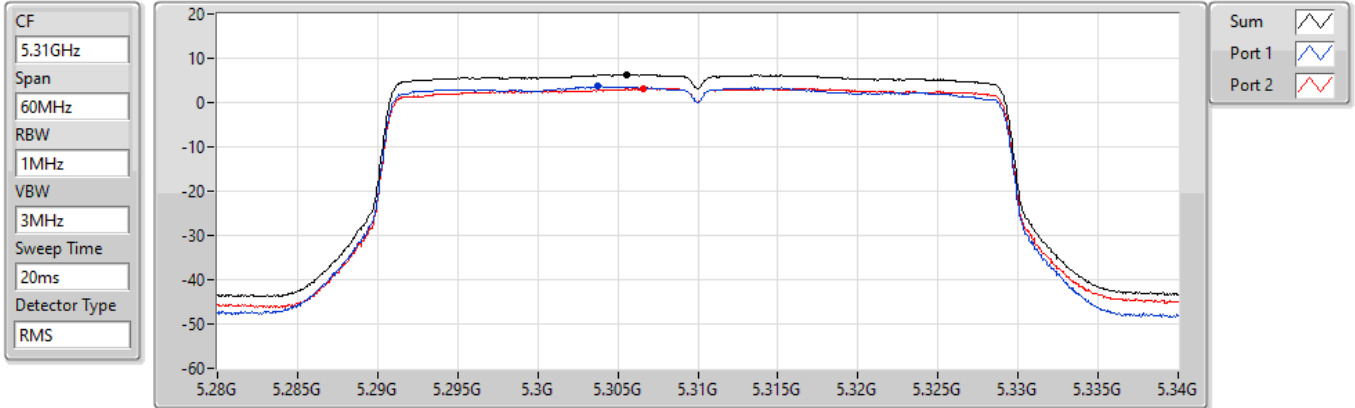

Sum	PD	Port 1	Port 2
(dBm/RBW)	(dBm/RBW)	(dBm/RBW)	(dBm/RBW)
6.30	6.30	3.69	3.20

802.11ax HEW80_Nss1,(MCS0)_2TX

PSD

5290MHz

23/08/2022

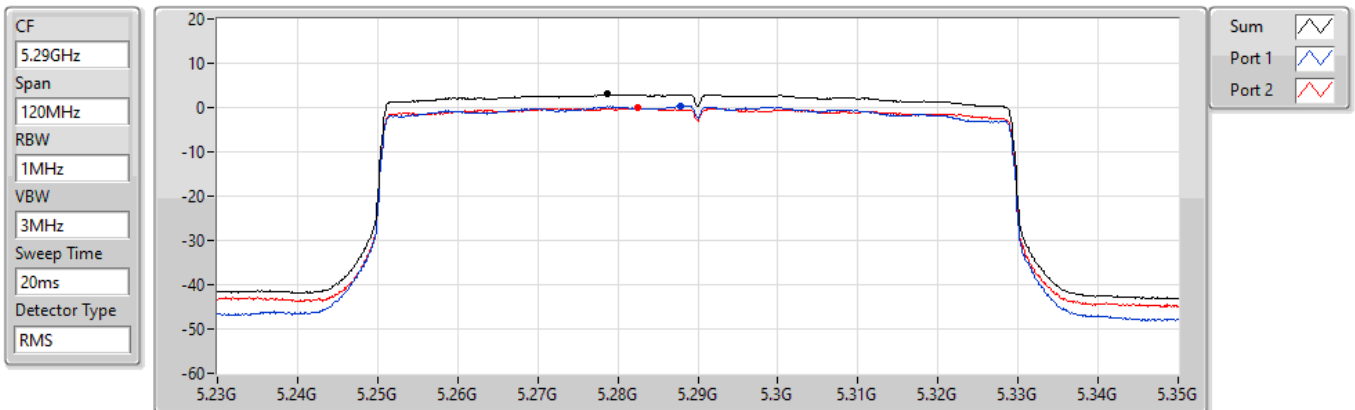

Sum	PD	Port 1	Port 2
(dBm/RBW)	(dBm/RBW)	(dBm/RBW)	(dBm/RBW)
2.97	2.97	0.36	-0.11

802.11ax HEW20-BF_Nss1,(MCS0)_2TX

PSD

5180MHz

23/08/2022

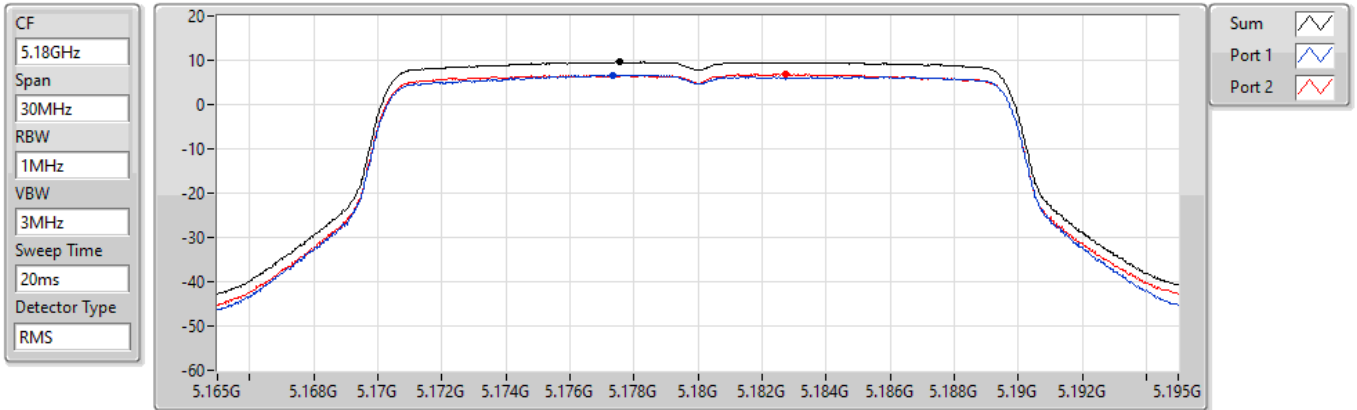

Sum	PD	Port 1	Port 2
(dBm/RBW)	(dBm/RBW)	(dBm/RBW)	(dBm/RBW)
9.62	9.62	6.67	6.82

802.11ax HEW40-BF_Nss1,(MCS0)_2TX

PSD

5190MHz

23/08/2022

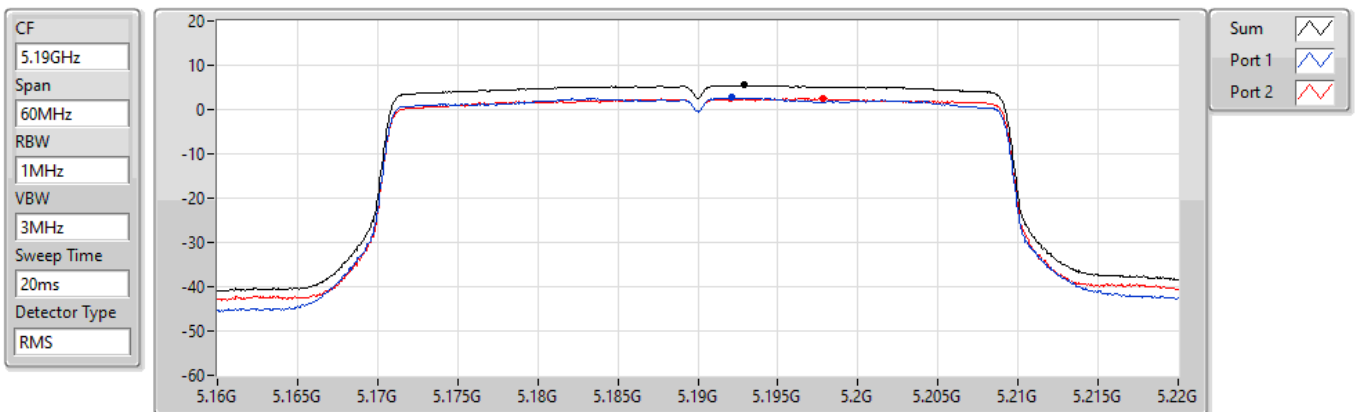

Sum	PD	Port 1	Port 2
(dBm/RBW)	(dBm/RBW)	(dBm/RBW)	(dBm/RBW)
5.50	5.50	2.66	2.52

802.11ax HEW40-BF_Nss1,(MCS0)_4TX

PSD

5755MHz

30/08/2022

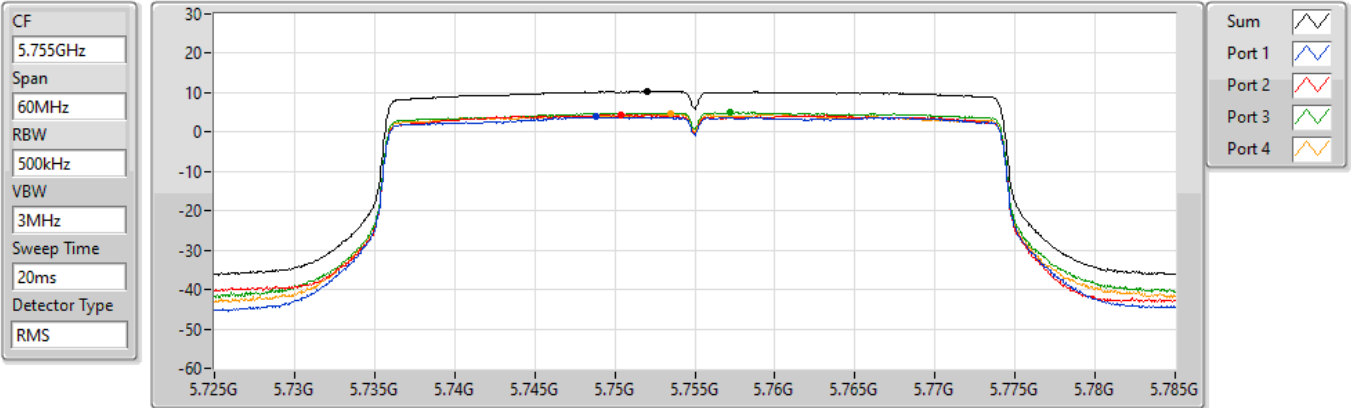

Sum	PD	Port 1	Port 2	Port 3	Port 4
(dBm/RBW)	(dBm/RBW)	(dBm/RBW)	(dBm/RBW)	(dBm/RBW)	(dBm/RBW)
10.28	10.28	3.83	4.42	4.99	4.64



Summary

Mode	Result	Type	Freq (Hz)	Level (dBuV/m)	Limit (dBuV/m)	Margin (dB)	Condition
Mode 1	Pass	QP	42.61M	36.69	40.00	-3.31	Vertical

Mode 1

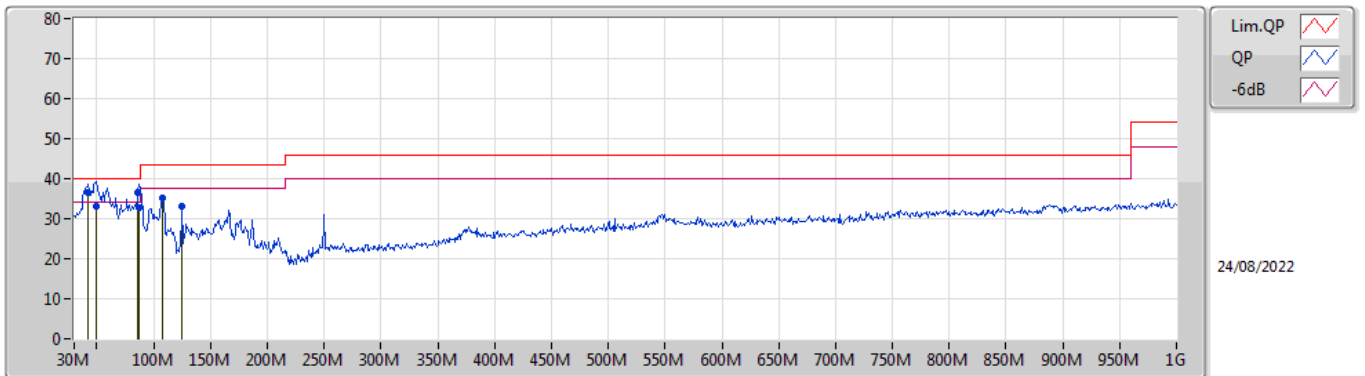

Type	Freq (Hz)	Level (dBuV/m)	Limit (dBuV/m)	Margin (dB)	Factor (dB/m)	Dist (m)	Condition	Azimuth (°)	Height (m)	Comment	Raw (dBuV/m)	AF (dB/m)	CL (dB)	PA (dB)
QP	42.61M	36.69	40.00	-3.31	-13.61	3	Vertical	247	1.00	"Worst"	50.30	17.23	0.95	31.79
QP	49.4M	33.11	40.00	-6.89	-16.49	3	Vertical	359	1.00	-	49.60	14.28	1.09	31.86
PK	86.26M	36.39	40.00	-3.61	-16.63	3	Vertical	148	1.00	-	53.02	13.89	1.43	31.95
QP	87.23M	32.61	40.00	-7.39	-16.49	3	Vertical	6	1.00	-	49.10	14.02	1.44	31.95
PK	107.6M	35.20	43.50	-8.30	-12.97	3	Vertical	0	1.25	-	48.17	17.46	1.54	31.97
PK	125.06M	33.20	43.50	-10.30	-12.44	3	Vertical	184	1.25	-	45.64	17.89	1.65	31.98

Mode 1

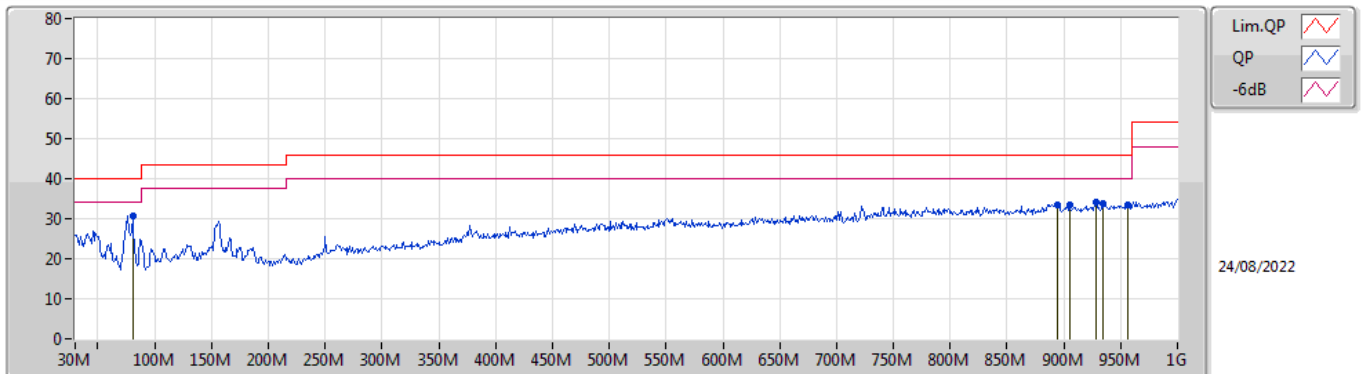

Type	Freq (Hz)	Level (dBuV/m)	Limit (dBuV/m)	Margin (dB)	Factor (dB/m)	Dist (m)	Condition	Azimuth (°)	Height (m)	Comment	Raw (dBuV/m)	AF (dB/m)	CL (dB)	PA (dB)
PK	80.44M	30.80	40.00	-9.20	-17.78	3	Horizontal	325	2.00	"Worst"	48.58	12.80	1.40	31.98
PK	894.27M	33.53	46.00	-12.47	-1.03	3	Horizontal	275	1.50	-	34.56	26.18	5.28	32.49
PK	904.94M	33.32	46.00	-12.68	-0.96	3	Horizontal	31	1.25	-	34.28	26.20	5.33	32.49
PK	928.22M	34.17	46.00	-11.83	-0.79	3	Horizontal	125	1.50	-	34.96	26.22	5.47	32.48
PK	934.04M	33.82	46.00	-12.18	-0.67	3	Horizontal	31	1.25	-	34.49	26.31	5.50	32.48
PK	956.35M	33.51	46.00	-12.49	-0.26	3	Horizontal	283	3.00	-	33.77	26.60	5.60	32.46



Summary

Mode	Result	Type	Freq (Hz)	Level (dBuV/m)	Limit (dBuV/m)	Margin (dB)	Dist (m)	Condition	Azimuth	Height	Comments
									(°)	(m)	
5.47-5.725GHz	-	-	-	-	-	-	-	-	-	-	-
802.11ax HEW80_Nss1,(MCS0)_4TX	Pass	AV	5.454G	53.95	54.00	-0.05	3	Vertical	266	1.42	-

802.11ax HEW20_Nss1,(MCS0)_2TX

5240MHz_TnomVnom

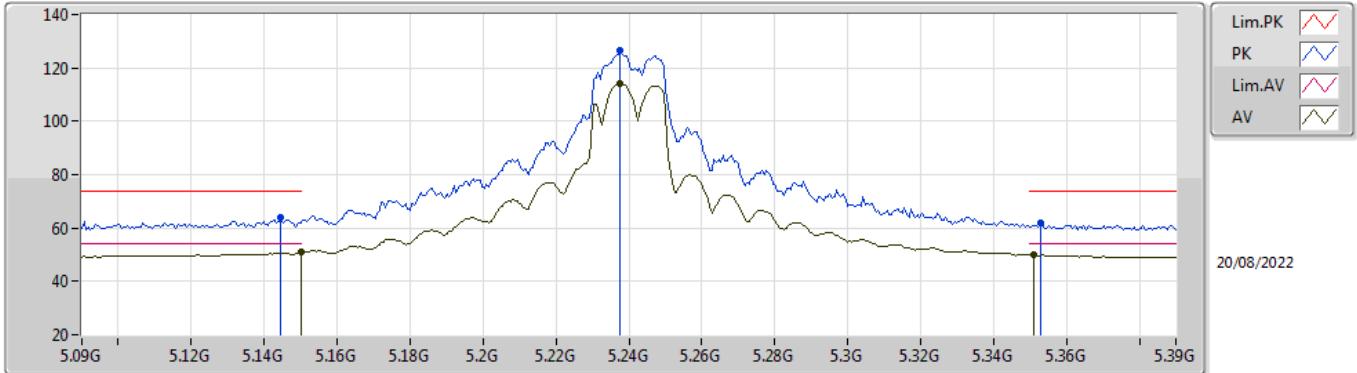

EUT_V_2TX
Setting 26
01-L-K-3-10

Type	Freq (Hz)	Level (dBuV/m)	Limit (dBuV/m)	Margin (dB)	Raw (dBuV)	Dist (m)	Condition	Azimuth (°)	Height (m)	Comment	AF (dB)	CL (dB)	PA (dB)
PK	5.1446G	64.17	74.00	-9.83	57.88	3	Vertical	188	2.04	-	32.71	6.37	32.79
AV	5.15G	50.84	54.00	-3.16	44.56	3	Vertical	188	2.04	-	32.70	6.37	32.79
PK	5.2376G	126.34	Inf	-Inf	119.91	3	Vertical	188	2.04	-	32.78	6.40	32.75
AV	5.2376G	114.04	Inf	-Inf	107.61	3	Vertical	188	2.04	-	32.78	6.40	32.75
PK	5.3528G	62.00	74.00	-12.00	55.29	3	Vertical	188	2.04	-	33.01	6.40	32.70
AV	5.351G	49.99	54.00	-4.01	43.29	3	Vertical	188	2.04	-	33.00	6.40	32.70

802.11ax HEW20_Nss1,(MCS0)_2TX

5240MHz_TnomVnom

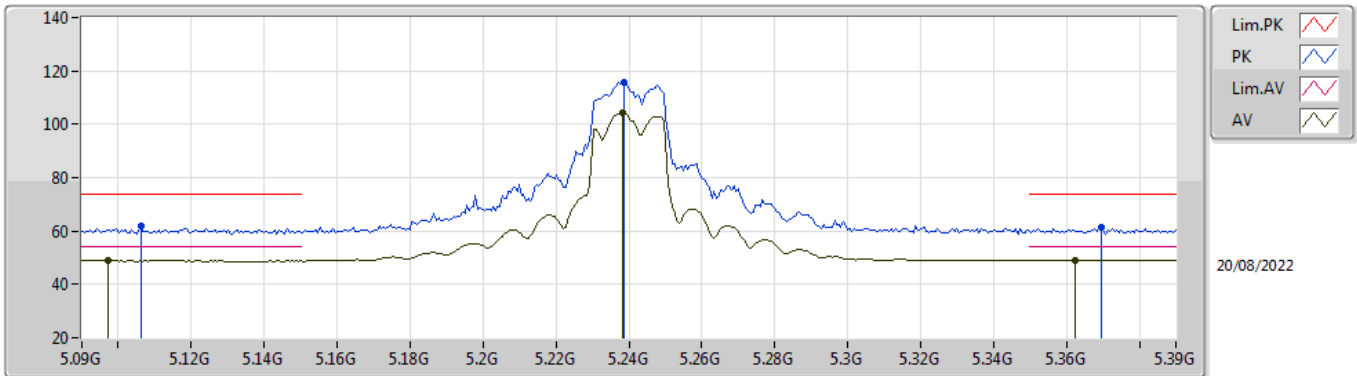

EUT_V_2TX
Setting 26
01-L-K-3-10

Type	Freq (Hz)	Level (dBuV/m)	Limit (dBuV/m)	Margin (dB)	Raw (dBuV)	Dist (m)	Condition	Azimuth (°)	Height (m)	Comment	AF (dB)	CL (dB)	PA (dB)
PK	5.1062G	61.74	74.00	-12.26	55.41	3	Horizontal	232	1.84	-	32.79	6.35	32.81
AV	5.0972G	48.92	54.00	-5.08	42.58	3	Horizontal	232	1.84	-	32.80	6.35	32.81
PK	5.2388G	115.65	Inf	-Inf	109.22	3	Horizontal	232	1.84	-	32.78	6.40	32.75
AV	5.2382G	104.12	Inf	-Inf	97.69	3	Horizontal	232	1.84	-	32.78	6.40	32.75
PK	5.3696G	61.29	74.00	-12.71	54.50	3	Horizontal	232	1.84	-	33.08	6.40	32.69
AV	5.3624G	49.06	54.00	-4.94	42.31	3	Horizontal	232	1.84	-	33.05	6.40	32.70

802.11ax HEW20_Nss1,(MCS0)_2TX

5240MHz_TnomVnom

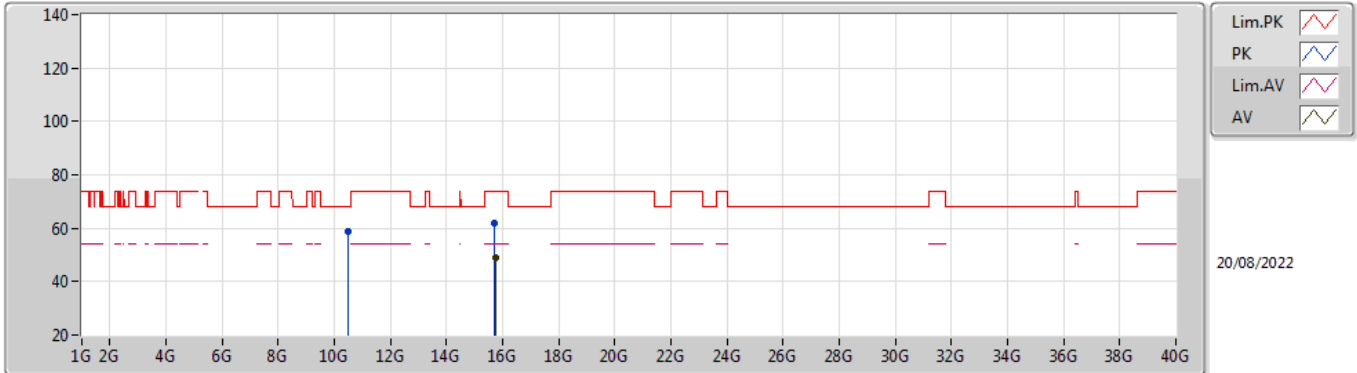

EUT Y_2TX
Setting 26
01-L-K-3

Type	Freq (Hz)	Level (dBuV/m)	Limit (dBuV/m)	Margin (dB)	Raw (dBuV)	Dist (m)	Condition	Azimuth (°)	Height (m)	Comment	AF (dB)	CL (dB)	PA (dB)
PK	10.482G	58.77	68.20	-9.43	43.33	3	Vertical	21	1.82	-	38.48	8.62	31.66
PK	15.724G	62.06	74.00	-11.94	44.46	3	Vertical	222	1.80	-	37.84	10.42	30.66
AV	15.7336G	49.13	54.00	-4.87	31.47	3	Vertical	222	1.80	-	37.90	10.42	30.66

802.11ax HEW20_Nss1,(MCS0)_2TX

5240MHz_TnomVnom

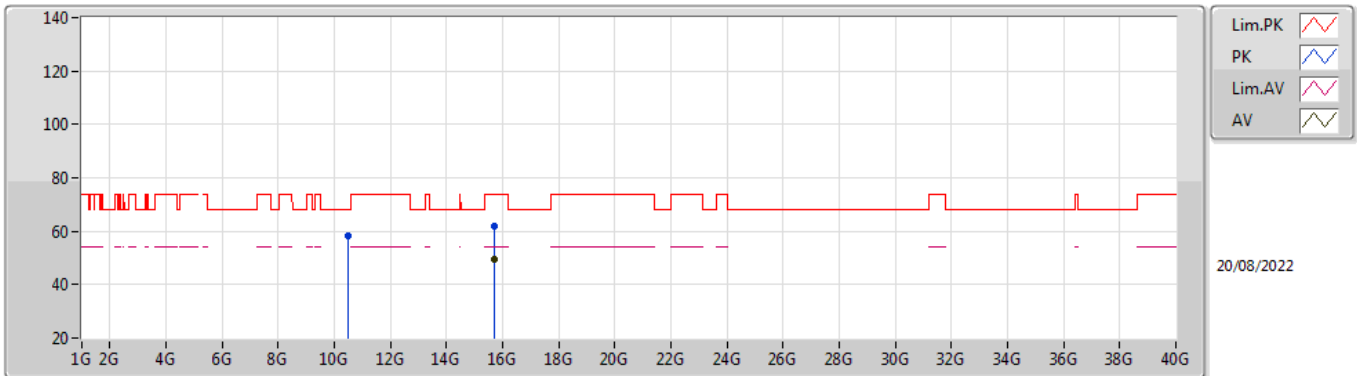

EUT Y_2TX
Setting 26
01-L-K-3

Type	Freq (Hz)	Level (dBuV/m)	Limit (dBuV/m)	Margin (dB)	Raw (dBuV)	Dist (m)	Condition	Azimuth (°)	Height (m)	Comment	AF (dB)	CL (dB)	PA (dB)
PK	10.49216G	58.07	68.20	-10.13	42.61	3	Horizontal	97	3.00	-	38.49	8.62	31.65
PK	15.72576G	61.76	74.00	-12.24	44.15	3	Horizontal	289	2.59	-	37.85	10.42	30.66
AV	15.71776G	49.27	54.00	-4.73	31.70	3	Horizontal	289	2.59	-	37.81	10.42	30.66

802.11ax HEW40_Nss1,(MCS0)_2TX

5270MHz_TnomVnom

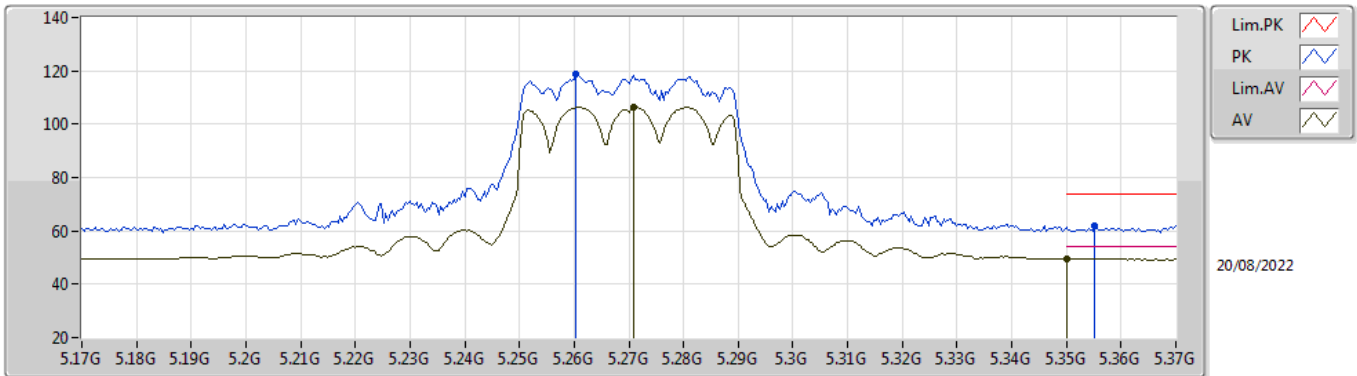

EUT Y_2TX
Setting 21
01-L-K-3-10

Type	Freq (Hz)	Level (dBuV/m)	Limit (dBuV/m)	Margin (dB)	Raw (dBuV)	Dist (m)	Condition	Azimuth (°)	Height (m)	Comment	AF (dB)	CL (dB)	PA (dB)
PK	5.2604G	118.82	Inf	-Inf	112.34	3	Vertical	180	2.02	-	32.82	6.40	32.74
AV	5.2708G	106.50	Inf	-Inf	100.00	3	Vertical	180	2.02	-	32.84	6.40	32.74
PK	5.3552G	62.10	74.00	-11.90	55.38	3	Vertical	180	2.02	-	33.02	6.40	32.70
AV	5.35G	49.62	54.00	-4.38	42.92	3	Vertical	180	2.02	-	33.00	6.40	32.70

802.11ax HEW40_Nss1,(MCS0)_2TX

5270MHz_TnomVnom

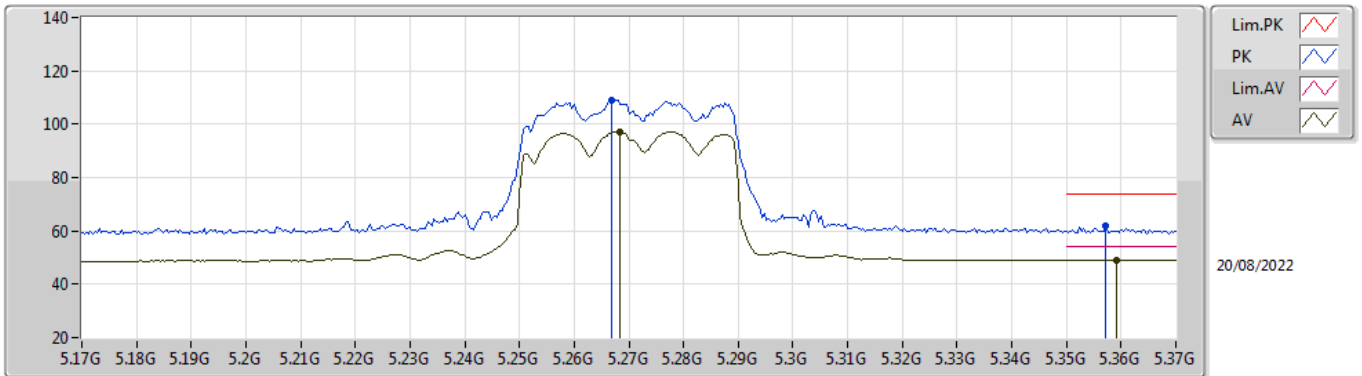

EUT Y_2TX
Setting 21
01-L-K-3-10

Type	Freq (Hz)	Level (dBuV/m)	Limit (dBuV/m)	Margin (dB)	Raw (dBuV)	Dist (m)	Condition	Azimuth (°)	Height (m)	Comment	AF (dB)	CL (dB)	PA (dB)
PK	5.2668G	109.11	Inf	-Inf	102.62	3	Horizontal	232	1.81	-	32.83	6.40	32.74
AV	5.2684G	97.12	Inf	-Inf	90.62	3	Horizontal	232	1.81	-	32.84	6.40	32.74
PK	5.3572G	61.65	74.00	-12.35	54.92	3	Horizontal	232	1.81	-	33.03	6.40	32.70
AV	5.3592G	49.07	54.00	-4.93	42.33	3	Horizontal	232	1.81	-	33.04	6.40	32.70

802.11ax HEW40_Nss1,(MCS0)_2TX

5270MHz_TnomVnom

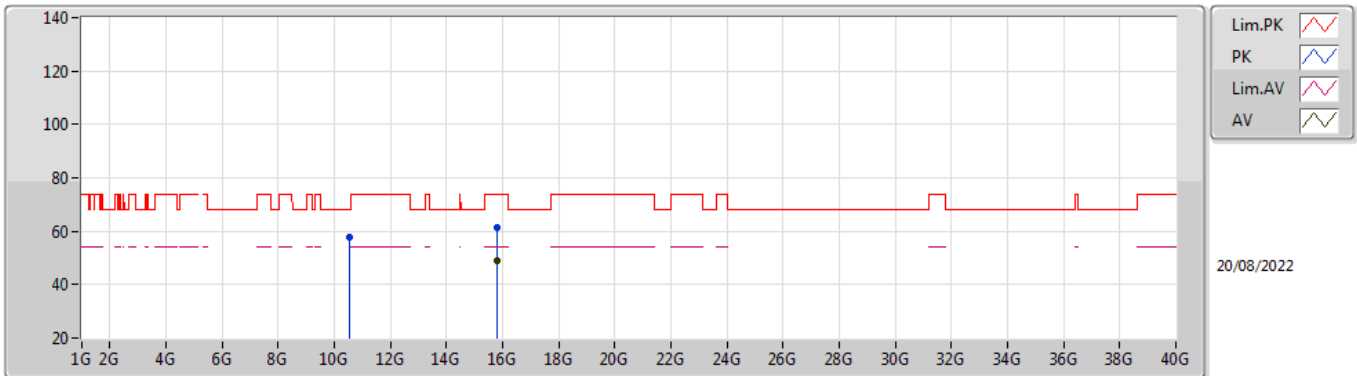

EUT Y_2TX
Setting 21
01-L-K-3

Type	Freq (Hz)	Level (dBuV/m)	Limit (dBuV/m)	Margin (dB)	Raw (dBuV)	Dist (m)	Condition	Azimuth (°)	Height (m)	Comment	AF (dB)	CL (dB)	PA (dB)
PK	10.55424G	57.66	68.20	-10.54	42.15	3	Vertical	244	1.73	-	38.55	8.64	31.68
PK	15.80392G	61.52	74.00	-12.48	43.42	3	Vertical	355	1.00	-	38.30	10.44	30.64
AV	15.80632G	49.11	54.00	-4.89	31.00	3	Vertical	355	1.00	-	38.31	10.44	30.64

802.11ax HEW40_Nss1,(MCS0)_2TX

5270MHz_TnomVnom

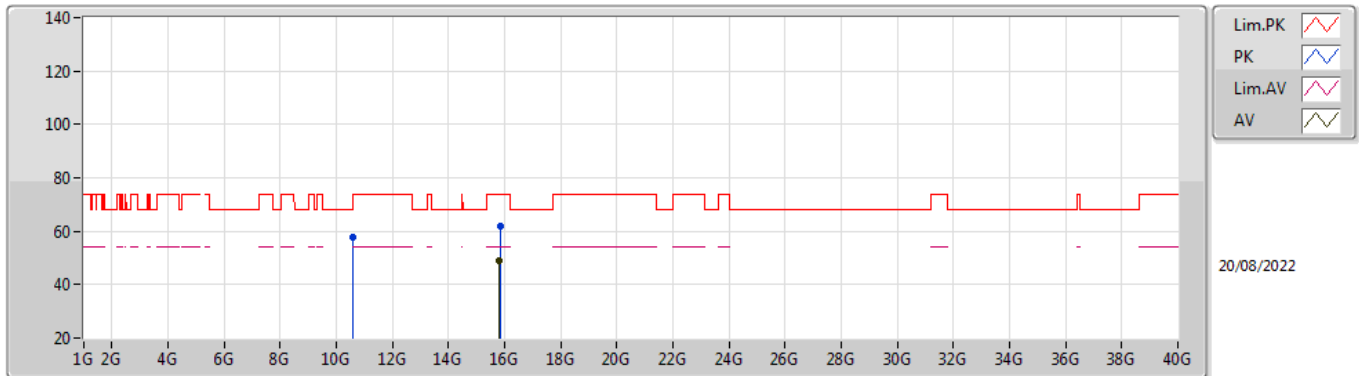

EUT Y_2TX
Setting 21
01-L-K-3

Type	Freq (Hz)	Level (dBuV/m)	Limit (dBuV/m)	Margin (dB)	Raw (dBuV)	Dist (m)	Condition	Azimuth (°)	Height (m)	Comment	AF (dB)	CL (dB)	PA (dB)
PK	10.57232G	57.92	68.20	-10.28	42.41	3	Horizontal	94	1.84	-	38.57	8.64	31.70
PK	15.83688G	61.79	74.00	-12.21	43.63	3	Horizontal	326	1.80	-	38.34	10.45	30.63
AV	15.79432G	49.09	54.00	-4.91	31.02	3	Horizontal	326	1.80	-	38.27	10.44	30.64

802.11ax HEW80_Nss1,(MCS0)_4TX

5530MHz_TnomVnom

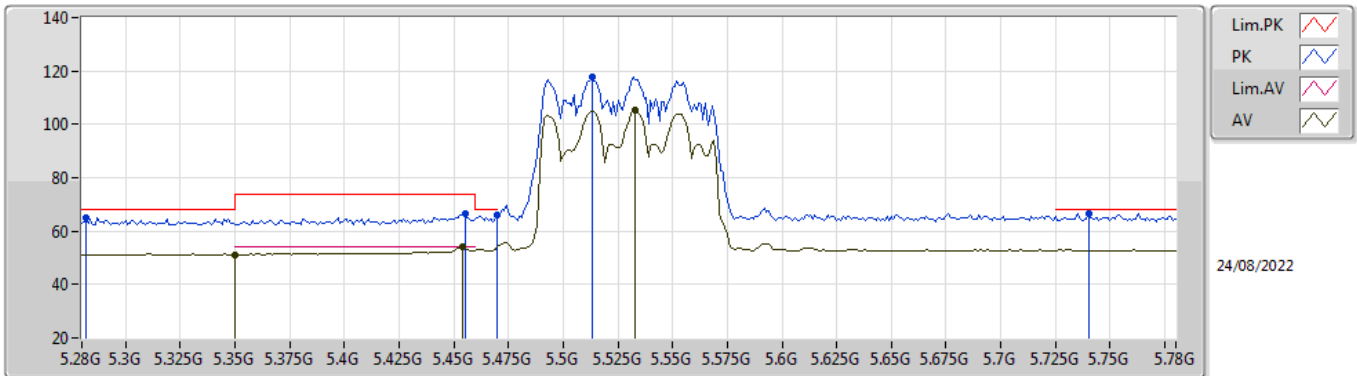

EUT_V_4TX
Setting 18
06-E-C-6-10

Type	Freq (Hz)	Level (dBuV/m)	Limit (dBuV/m)	Margin (dB)	Raw (dBuV)	Dist (m)	Condition	Azimuth (°)	Height (m)	Comment	AF (dB)	CL (dB)	PA (dB)
PK	5.282G	65.05	68.20	-3.15	60.41	3	Vertical	266	1.42	-	31.47	5.64	32.47
AV	5.35G	51.10	54.00	-2.90	46.61	3	Vertical	266	1.42	-	31.30	5.67	32.48
PK	5.455G	66.46	74.00	-7.54	61.48	3	Vertical	266	1.42	-	31.72	5.75	32.49
AV	5.454G	53.95	54.00	-0.05	48.97	3	Vertical	266	1.42	-	31.72	5.75	32.49
PK	5.47G	66.17	68.20	-2.03	61.12	3	Vertical	266	1.42	-	31.78	5.77	32.50
PK	5.513G	117.81	Inf	-Inf	112.60	3	Vertical	266	1.42	-	31.90	5.81	32.50
AV	5.533G	105.17	Inf	-Inf	99.93	3	Vertical	266	1.42	-	31.90	5.83	32.49
PK	5.74G	66.54	68.20	-1.66	60.90	3	Vertical	266	1.42	-	32.16	5.90	32.42

802.11ax HEW80_Nss1,(MCS0)_4TX

5530MHz_TnomVnom

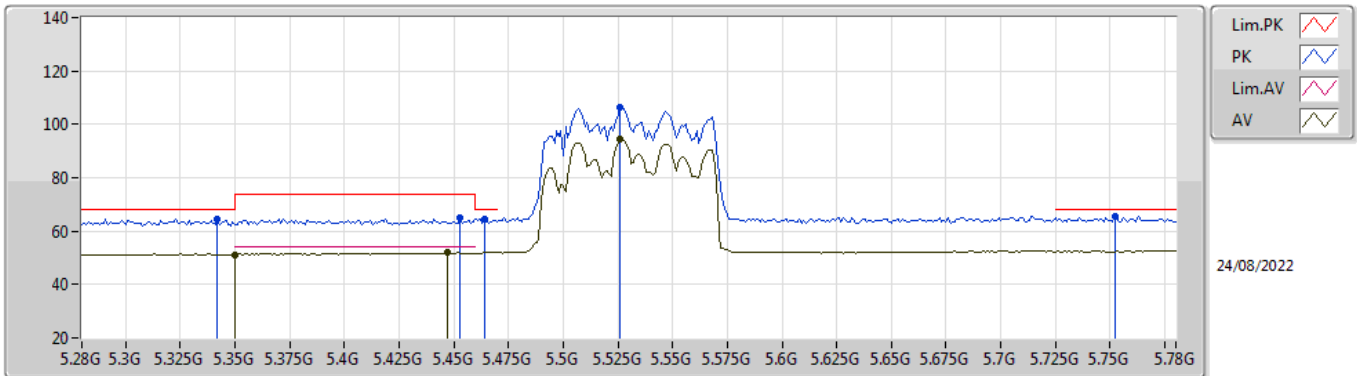

EUT_V_4TX
Setting 18
06-E-C-6-10

Type	Freq (Hz)	Level (dBuV/m)	Limit (dBuV/m)	Margin (dB)	Raw (dBuV)	Dist (m)	Condition	Azimuth (°)	Height (m)	Comment	AF (dB)	CL (dB)	PA (dB)
PK	5.342G	64.66	68.20	-3.54	60.15	3	Horizontal	249	1.83	-	31.32	5.67	32.48
AV	5.35G	51.18	54.00	-2.82	46.69	3	Horizontal	249	1.83	-	31.30	5.67	32.48
PK	5.453G	64.83	74.00	-9.17	59.86	3	Horizontal	249	1.83	-	31.71	5.75	32.49
AV	5.447G	51.92	54.00	-2.08	46.97	3	Horizontal	249	1.83	-	31.69	5.75	32.49
PK	5.464G	64.69	68.20	-3.51	59.67	3	Horizontal	249	1.83	-	31.76	5.76	32.50
PK	5.526G	106.35	Inf	-Inf	101.11	3	Horizontal	249	1.83	-	31.90	5.83	32.49
AV	5.526G	94.29	Inf	-Inf	89.05	3	Horizontal	249	1.83	-	31.90	5.83	32.49
PK	5.752G	65.49	68.20	-2.71	59.81	3	Horizontal	249	1.83	-	32.20	5.90	32.42

802.11ax HEW80_Nss1,(MCS0)_4TX

5530MHz_TnomVnom

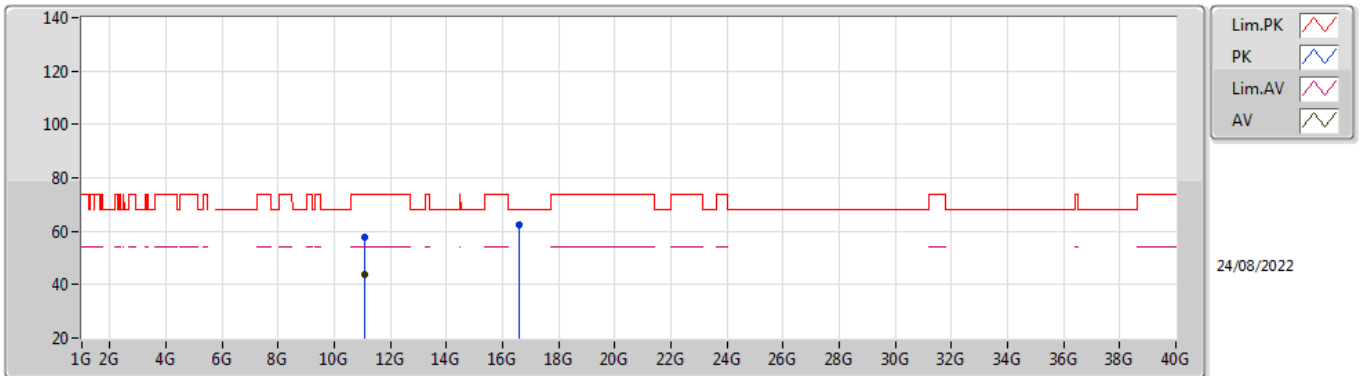

EUT Y_4TX
Setting 18
06-E-C-6

Type	Freq (Hz)	Level (dBuV/m)	Limit (dBuV/m)	Margin (dB)	Raw (dBuV)	Dist (m)	Condition	Azimuth (°)	Height (m)	Comment	AF (dB)	CL (dB)	PA (dB)
PK	11.06114G	57.96	74.00	-16.04	43.31	3	Vertical	329	1.80	-	40.36	8.94	34.65
AV	11.06984G	43.77	54.00	-10.23	29.16	3	Vertical	329	1.80	-	40.32	8.94	34.65
PK	16.59276G	62.25	68.20	-5.95	47.19	3	Vertical	156	1.95	-	39.51	10.45	34.90

802.11ax HEW80_Nss1,(MCS0)_4TX

5530MHz_TnomVnom

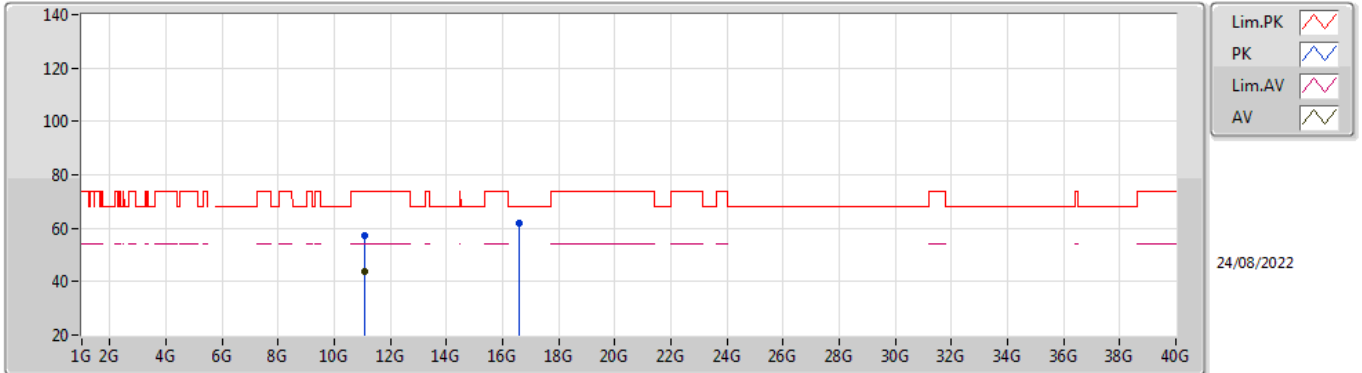

EUT Y_4TX
Setting 18
06-E-C-6

Type	Freq (Hz)	Level (dBuV/m)	Limit (dBuV/m)	Margin (dB)	Raw (dBuV)	Dist (m)	Condition	Azimuth (°)	Height (m)	Comment	AF (dB)	CL (dB)	PA (dB)
PK	11.06012G	57.14	74.00	-16.86	42.49	3	Horizontal	355	1.21	-	40.36	8.94	34.65
AV	11.07338G	43.76	54.00	-10.24	29.16	3	Horizontal	355	1.21	-	40.31	8.94	34.65
PK	16.58574G	61.76	68.20	-6.44	46.68	3	Horizontal	91	2.41	-	39.53	10.45	34.90

802.11ax HEW20-BF_Nss1,(MCS0)_4TX

5825MHz_TnomVnom

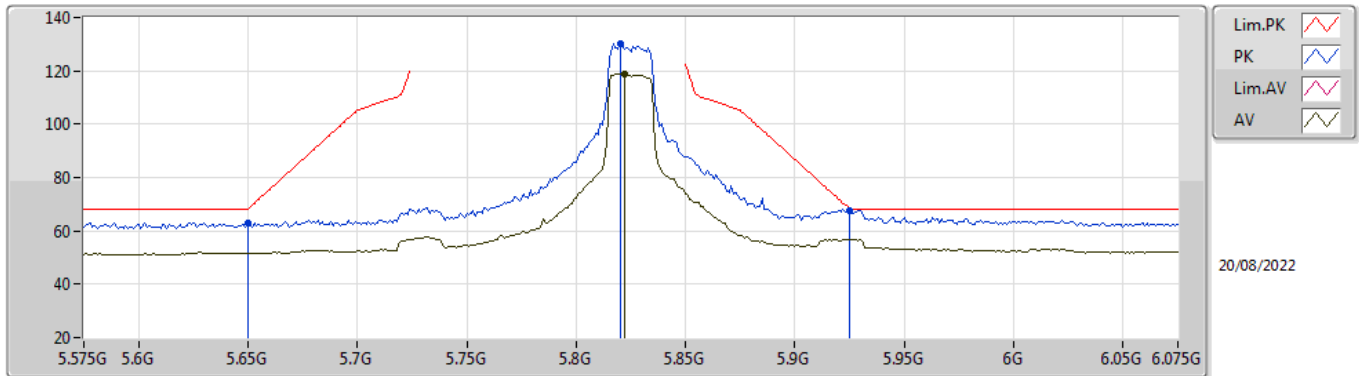

EUT Y_4TX
Setting 30
01-L-K-3-10

Type	Freq (Hz)	Level (dBuV/m)	Limit (dBuV/m)	Margin (dB)	Raw (dBuV)	Dist (m)	Condition	Azimuth (°)	Height (m)	Comment	AF (dB)	CL (dB)	PA (dB)
PK	5.65G	62.95	68.20	-5.25	54.95	3	Vertical	275	1.80	-	34.10	6.60	32.70
PK	5.82G	130.31	Inf	-Inf	121.92	3	Vertical	275	1.80	-	34.56	6.60	32.77
AV	5.822G	118.78	Inf	-Inf	110.37	3	Vertical	275	1.80	-	34.58	6.60	32.77
PK	5.925G	67.81	68.20	-0.39	59.02	3	Vertical	275	1.80	-	35.00	6.60	32.81

802.11ax HEW20-BF_Nss1,(MCS0)_4TX

5825MHz_TnomVnom

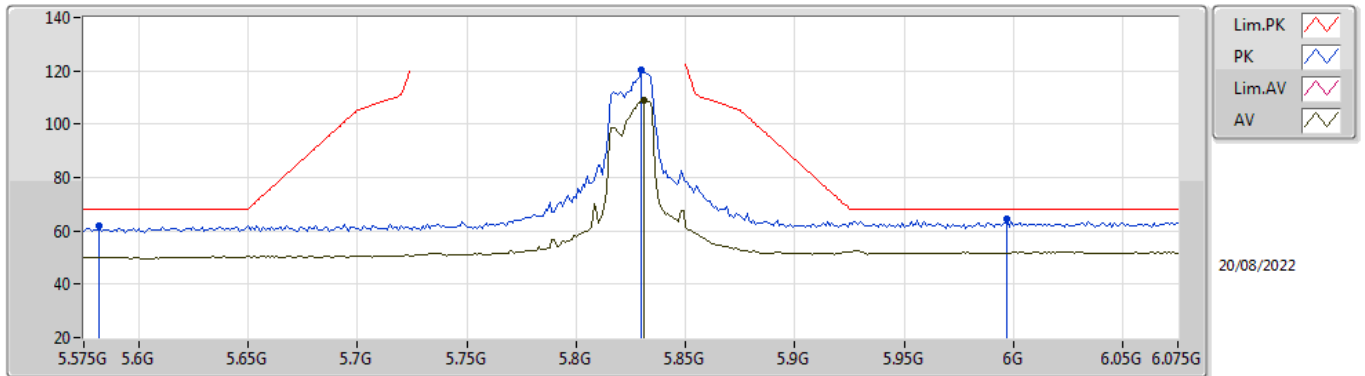

EUT Y_4TX
Setting 30
01-L-K-3-10

Type	Freq (Hz)	Level (dBuV/m)	Limit (dBuV/m)	Margin (dB)	Raw (dBuV)	Dist (m)	Condition	Azimuth (°)	Height (m)	Comment	AF (dB)	CL (dB)	PA (dB)
PK	5.582G	61.91	68.20	-6.29	54.16	3	Horizontal	131	1.55	-	33.84	6.58	32.67
PK	5.83G	120.15	Inf	-Inf	111.68	3	Horizontal	131	1.55	-	34.64	6.60	32.77
AV	5.831G	109.00	Inf	-Inf	100.52	3	Horizontal	131	1.55	-	34.65	6.60	32.77
PK	5.997G	64.25	68.20	-3.95	55.20	3	Horizontal	131	1.55	-	35.29	6.60	32.84

802.11ax HEW20-BF_Nss1,(MCS0)_4TX

5825MHz_TnomVnom

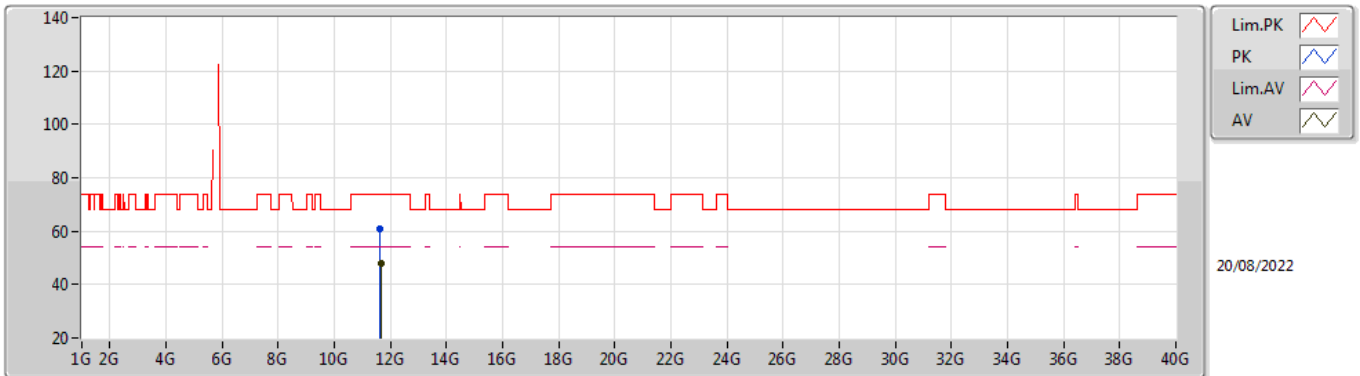

EUT Y_4TX
Setting 30
01-L-K-3

Type	Freq (Hz)	Level (dBuV/m)	Limit (dBuV/m)	Margin (dB)	Raw (dBuV)	Dist (m)	Condition	Azimuth (°)	Height (m)	Comment	AF (dB)	CL (dB)	PA (dB)
PK	11.64454G	60.61	74.00	-13.39	44.78	3	Vertical	255	1.56	-	38.60	8.91	31.68
AV	11.65182G	48.09	54.00	-5.91	32.26	3	Vertical	255	1.56	-	38.60	8.91	31.68

802.11ax HEW20-BF_Nss1,(MCS0)_4TX

5825MHz_TnomVnom

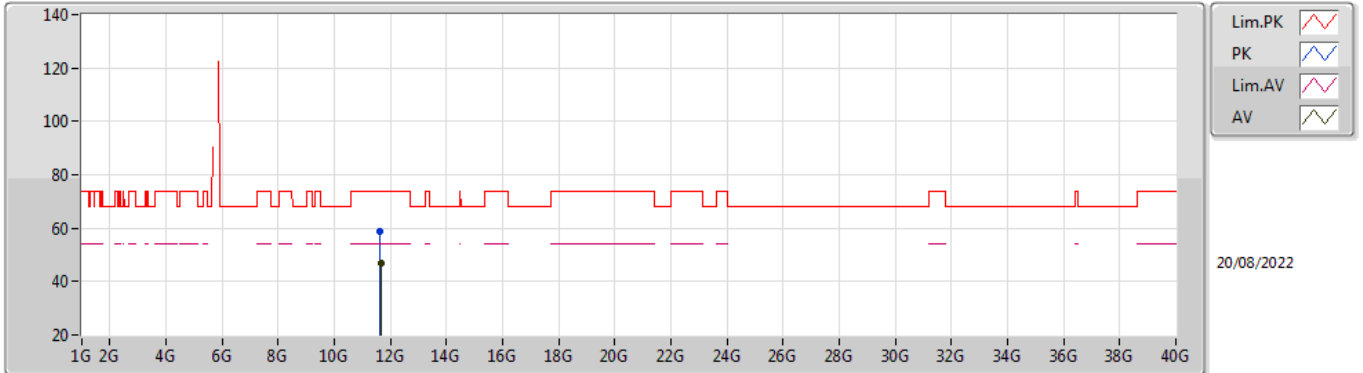

EUT Y_4TX
Setting 30
01-L-K-3

Type	Freq (Hz)	Level (dBuV/m)	Limit (dBuV/m)	Margin (dB)	Raw (dBuV)	Dist (m)	Condition	Azimuth (°)	Height (m)	Comment	AF (dB)	CL (dB)	PA (dB)
PK	11.64618G	58.55	74.00	-15.45	42.72	3	Horizontal	48	2.34	-	38.60	8.91	31.68
AV	11.65074G	46.70	54.00	-7.30	30.87	3	Horizontal	48	2.34	-	38.60	8.91	31.68



Summary

Mode	Result	Type	Freq (Hz)	Level (dBuV/m)	Limit (dBuV/m)	Margin (dB)	Dist (m)	Condition	Azimuth (°)	Height (m)	Comments
5.25-5.35GHz	-	-	-	-	-	-	-	-	-	-	-
802.11ax HEW40_Nss1,(MCS0)_2TX	Pass	AV	5.35G	53.98	54.00	-0.02	3	Vertical	186	2.11	-

802.11a_Nss1,(6Mbps)_2TX

5180MHz_TnomVnom

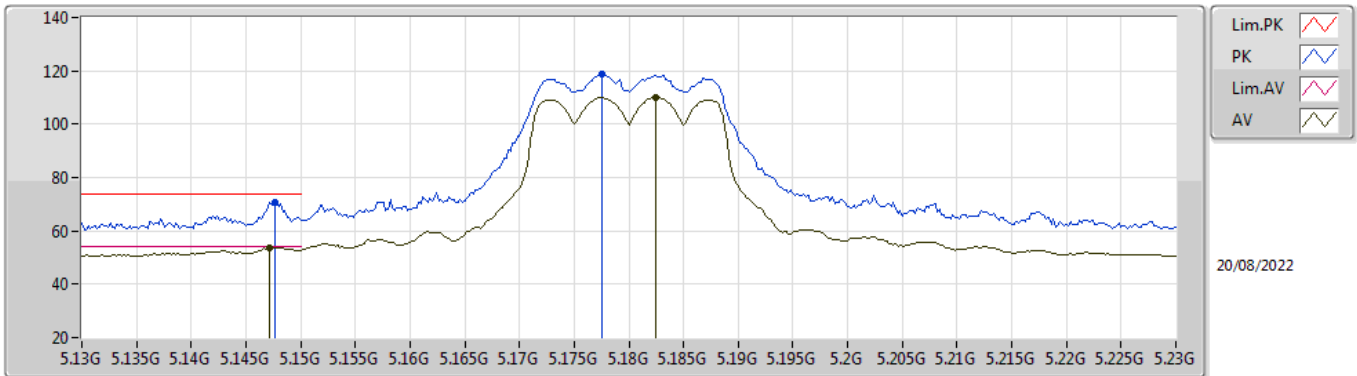

EUT_V_2TX
Setting 20
01-L-K-3-10

Type	Freq (Hz)	Level (dBuV/m)	Limit (dBuV/m)	Margin (dB)	Raw (dBuV)	Dist (m)	Condition	Azimuth (°)	Height (m)	Comment	AF (dB)	CL (dB)	PA (dB)
PK	5.1476G	70.87	74.00	-3.13	64.59	3	Vertical	182	1.98	-	32.70	6.37	32.79
AV	5.1472G	53.74	54.00	-0.26	47.45	3	Vertical	182	1.98	-	32.71	6.37	32.79
PK	5.1776G	118.56	Inf	-Inf	112.25	3	Vertical	182	1.98	-	32.70	6.39	32.78
AV	5.1824G	110.02	Inf	-Inf	103.70	3	Vertical	182	1.98	-	32.70	6.39	32.77

802.11a_Nss1,(6Mbps)_2TX

5180MHz_TnomVnom

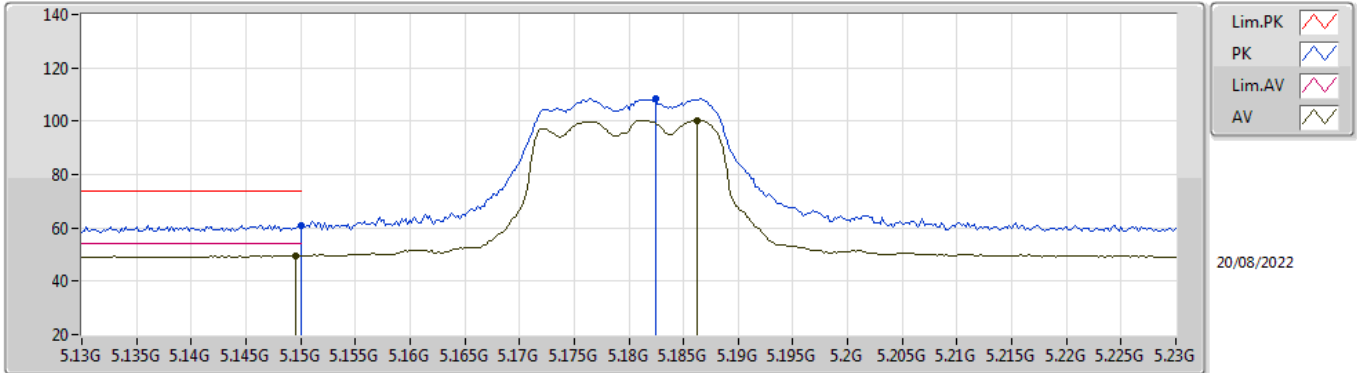

EUT_V_2TX
Setting 20
01-L-K-3-10

Type	Freq (Hz)	Level (dBuV/m)	Limit (dBuV/m)	Margin (dB)	Raw (dBuV)	Dist (m)	Condition	Azimuth (°)	Height (m)	Comment	AF (dB)	CL (dB)	PA (dB)
PK	5.15G	61.09	74.00	-12.91	54.81	3	Horizontal	233	1.82	-	32.70	6.37	32.79
AV	5.1496G	49.68	54.00	-4.32	43.40	3	Horizontal	233	1.82	-	32.70	6.37	32.79
PK	5.1824G	108.47	Inf	-Inf	102.15	3	Horizontal	233	1.82	-	32.70	6.39	32.77
AV	5.1862G	100.37	Inf	-Inf	94.05	3	Horizontal	233	1.82	-	32.70	6.39	32.77

802.11a_Nss1,(6Mbps)_2TX

5180MHz_TnomVnom

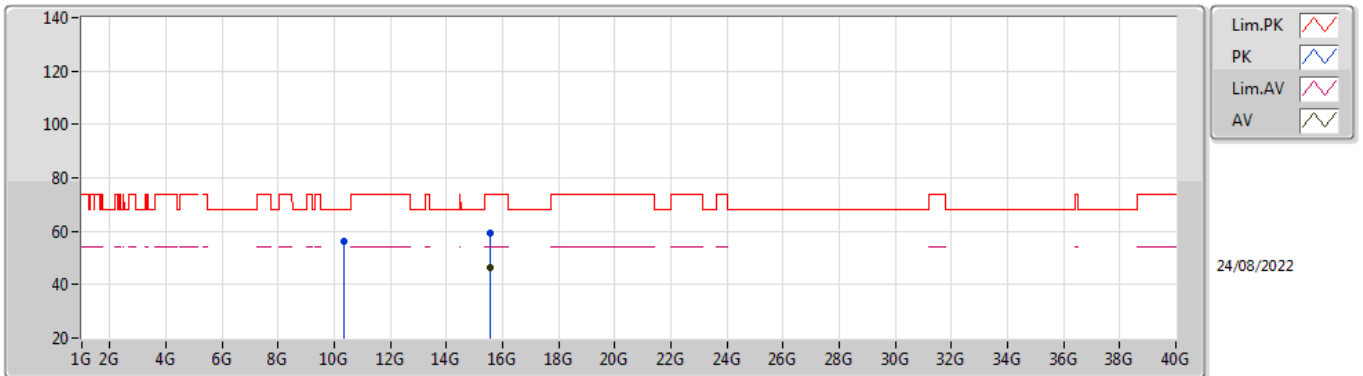

EUT Y_2TX
Setting 20
06-E-C-6

Type	Freq (Hz)	Level (dBuV/m)	Limit (dBuV/m)	Margin (dB)	Raw (dBuV)	Dist (m)	Condition	Azimuth (°)	Height (m)	Comment	AF (dB)	CL (dB)	PA (dB)
PK	10.36852G	55.96	68.20	-12.24	42.08	3	Vertical	20	1.31	-	39.97	8.52	34.61
PK	15.53718G	59.45	74.00	-14.55	45.56	3	Vertical	144	1.17	-	38.48	10.23	34.82
AV	15.54516G	46.43	54.00	-7.57	32.59	3	Vertical	144	1.17	-	38.43	10.23	34.82

802.11a_Nss1,(6Mbps)_2TX

5180MHz_TnomVnom

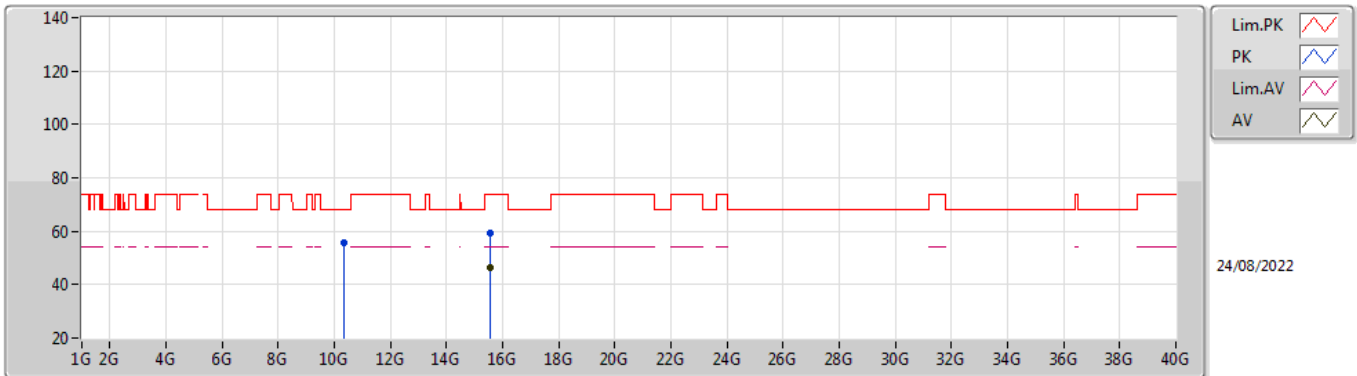

EUT Y_2TX
Setting 20
06-E-C-6

Type	Freq (Hz)	Level (dBuV/m)	Limit (dBuV/m)	Margin (dB)	Raw (dBuV)	Dist (m)	Condition	Azimuth (°)	Height (m)	Comment	AF (dB)	CL (dB)	PA (dB)
PK	10.3615G	55.65	68.20	-12.55	41.78	3	Horizontal	15	2.55	-	39.95	8.52	34.60
PK	15.54222G	59.52	74.00	-14.48	45.66	3	Horizontal	321	2.17	-	38.45	10.23	34.82
AV	15.55476G	46.42	54.00	-7.58	32.64	3	Horizontal	321	2.17	-	38.37	10.23	34.82

802.11a_Nss1,(6Mbps)_2TX

5200MHz_TnomVnom

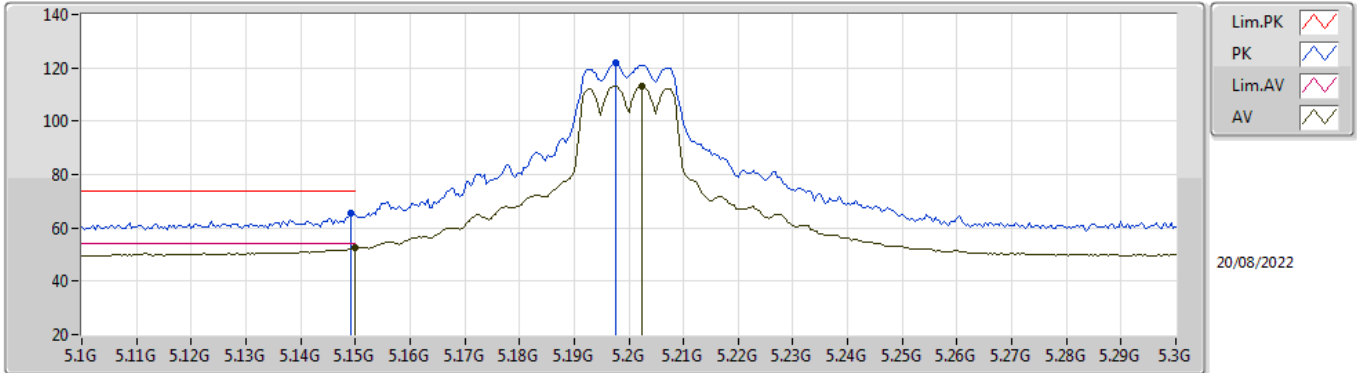

EUT_V_2TX
Setting 23
01-L-K-3-10

Type	Freq (Hz)	Level (dBuV/m)	Limit (dBuV/m)	Margin (dB)	Raw (dBuV)	Dist (m)	Condition	Azimuth (°)	Height (m)	Comment	AF (dB)	CL (dB)	PA (dB)
PK	5.1492G	65.41	74.00	-8.59	59.13	3	Vertical	341	1.96	-	32.70	6.37	32.79
AV	5.15G	52.78	54.00	-1.22	46.50	3	Vertical	341	1.96	-	32.70	6.37	32.79
PK	5.1976G	121.75	Inf	-Inf	115.42	3	Vertical	341	1.96	-	32.70	6.40	32.77
AV	5.2024G	113.02	Inf	-Inf	106.68	3	Vertical	341	1.96	-	32.70	6.40	32.76

802.11a_Nss1,(6Mbps)_2TX

5200MHz_TnomVnom

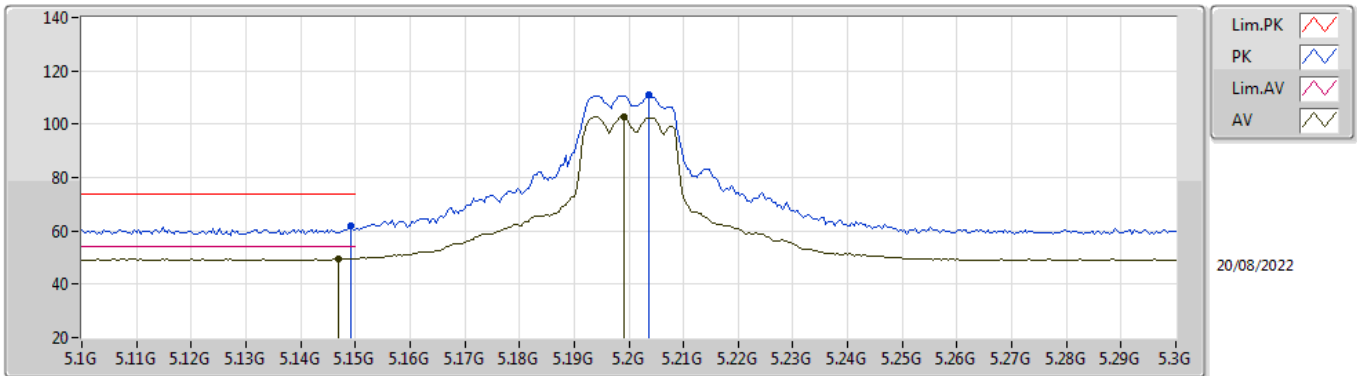

EUT V_2TX
Setting 23
01-L-K-3-10

Type	Freq (Hz)	Level (dBuV/m)	Limit (dBuV/m)	Margin (dB)	Raw (dBuV)	Dist (m)	Condition	Azimuth (°)	Height (m)	Comment	AF (dB)	CL (dB)	PA (dB)
PK	5.1492G	61.91	74.00	-12.09	55.63	3	Horizontal	233	1.84	-	32.70	6.37	32.79
AV	5.1468G	49.70	54.00	-4.30	43.41	3	Horizontal	233	1.84	-	32.71	6.37	32.79
PK	5.2036G	110.99	Inf	-Inf	104.64	3	Horizontal	233	1.84	-	32.71	6.40	32.76
AV	5.1992G	102.74	Inf	-Inf	96.41	3	Horizontal	233	1.84	-	32.70	6.40	32.77

802.11a_Nss1,(6Mbps)_2TX

5200MHz_TnomVnom

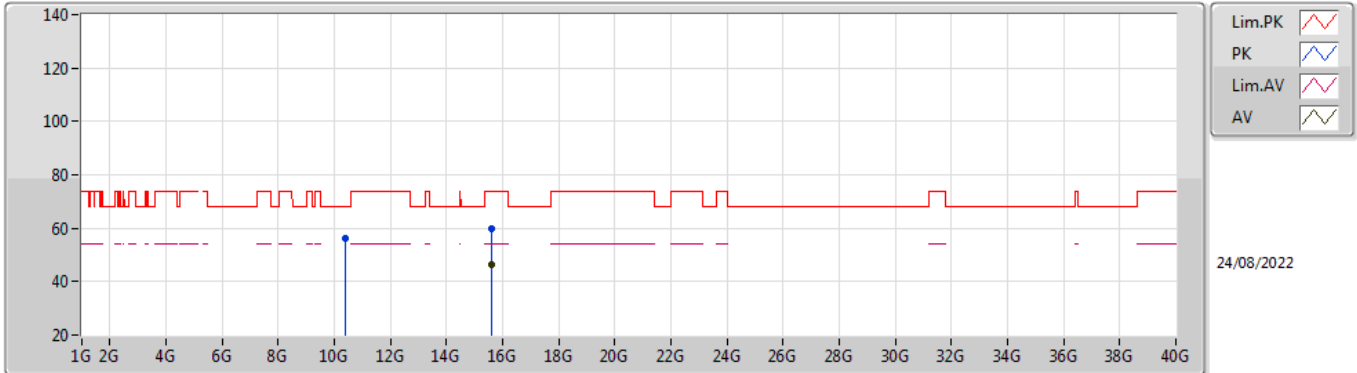

EUT Y_2TX
Setting 23
06-E-C-6

Type	Freq (Hz)	Level (dBuV/m)	Limit (dBuV/m)	Margin (dB)	Raw (dBuV)	Dist (m)	Condition	Azimuth (°)	Height (m)	Comment	AF (dB)	CL (dB)	PA (dB)
PK	10.39226G	55.98	68.20	-12.22	41.99	3	Vertical	358	2.66	-	40.07	8.54	34.62
PK	15.60054G	59.92	74.00	-14.08	46.39	3	Vertical	354	1.85	-	38.10	10.24	34.81
AV	15.5889G	46.62	54.00	-7.38	33.02	3	Vertical	354	1.85	-	38.17	10.24	34.81

802.11a_Nss1,(6Mbps)_2TX

5200MHz_TnomVnom

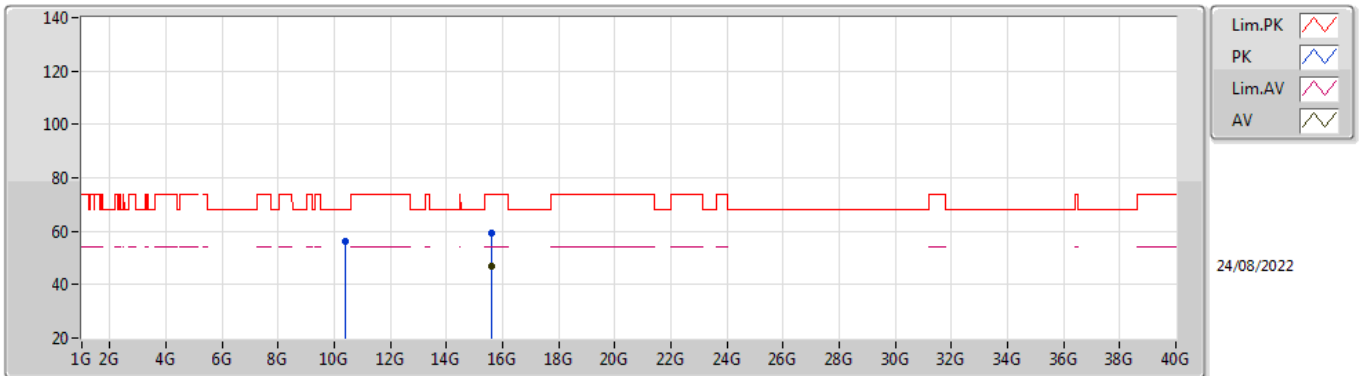

EUT Y_2TX
Setting 23
06-E-C-6

Type	Freq (Hz)	Level (dBuV/m)	Limit (dBuV/m)	Margin (dB)	Raw (dBuV)	Dist (m)	Condition	Azimuth (°)	Height (m)	Comment	AF (dB)	CL (dB)	PA (dB)
PK	10.39694G	56.33	68.20	-11.87	42.33	3	Horizontal	42	1.26	-	40.09	8.54	34.63
PK	15.61362G	59.23	74.00	-14.77	45.73	3	Horizontal	284	2.51	-	38.07	10.24	34.81
AV	15.5943G	46.71	54.00	-7.29	33.15	3	Horizontal	284	2.51	-	38.13	10.24	34.81

802.11ax HEW20_Nss1,(MCS0)_2TX

5200MHz_TnomVnom

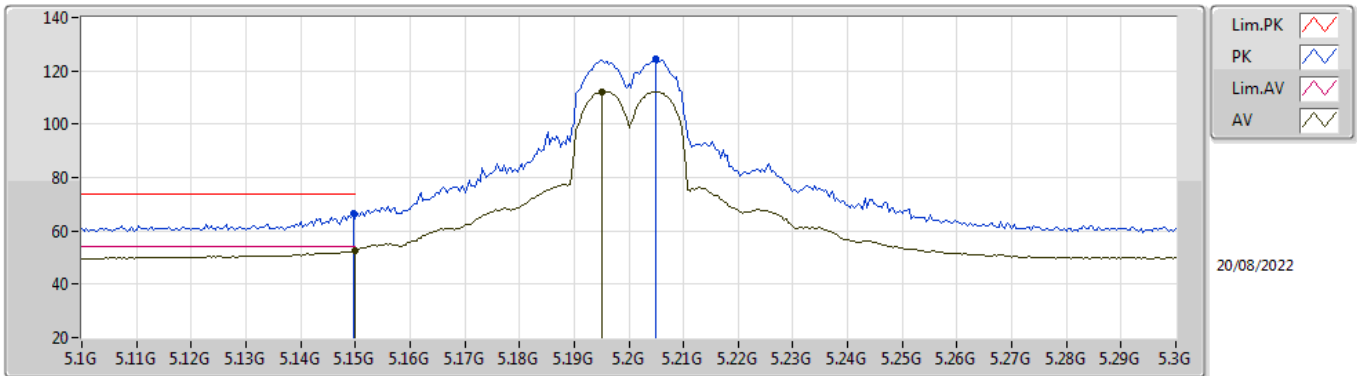

EUT Y_2TX
Setting 23
01-L-K-3-10

Type	Freq (Hz)	Level (dBuV/m)	Limit (dBuV/m)	Margin (dB)	Raw (dBuV)	Dist (m)	Condition	Azimuth (°)	Height (m)	Comment	AF (dB)	CL (dB)	PA (dB)
PK	5.1496G	66.45	74.00	-7.55	60.17	3	Vertical	342	1.97	-	32.70	6.37	32.79
AV	5.15G	52.78	54.00	-1.22	46.50	3	Vertical	342	1.97	-	32.70	6.37	32.79
PK	5.2048G	124.31	Inf	-Inf	117.96	3	Vertical	342	1.97	-	32.71	6.40	32.76
AV	5.1952G	112.24	Inf	-Inf	105.91	3	Vertical	342	1.97	-	32.70	6.40	32.77

802.11ax HEW20_Nss1,(MCS0)_2TX

5200MHz_TnomVnom

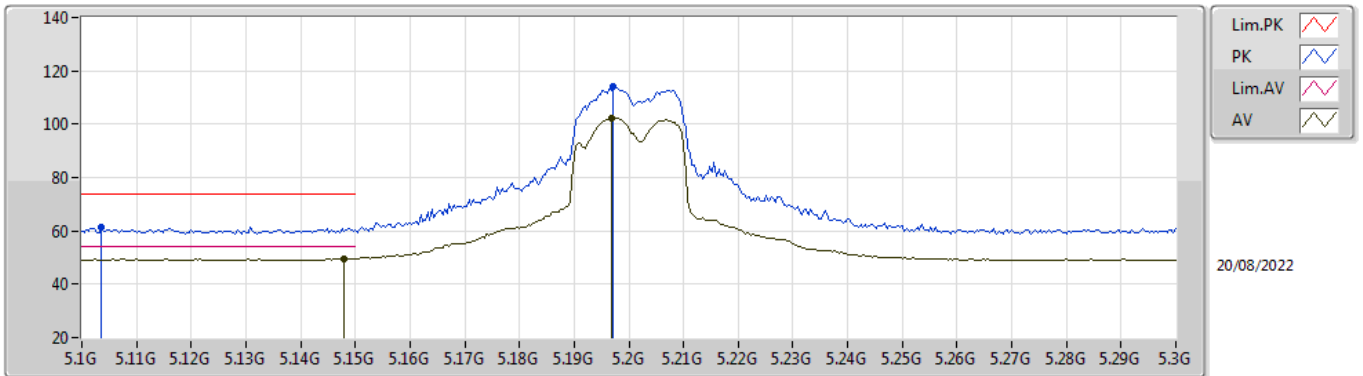

EUT V_2TX
Setting 23
01-L-K-3-10

Type	Freq (Hz)	Level (dBuV/m)	Limit (dBuV/m)	Margin (dB)	Raw (dBuV)	Dist (m)	Condition	Azimuth (°)	Height (m)	Comment	AF (dB)	CL (dB)	PA (dB)
PK	5.1036G	61.53	74.00	-12.47	55.20	3	Horizontal	234	1.54	-	32.79	6.35	32.81
AV	5.148G	49.69	54.00	-4.31	43.41	3	Horizontal	234	1.54	-	32.70	6.37	32.79
PK	5.1972G	114.09	Inf	-Inf	107.76	3	Horizontal	234	1.54	-	32.70	6.40	32.77
AV	5.1968G	102.14	Inf	-Inf	95.81	3	Horizontal	234	1.54	-	32.70	6.40	32.77

802.11ax HEW20_Nss1,(MCS0)_2TX

5200MHz_TnomVnom

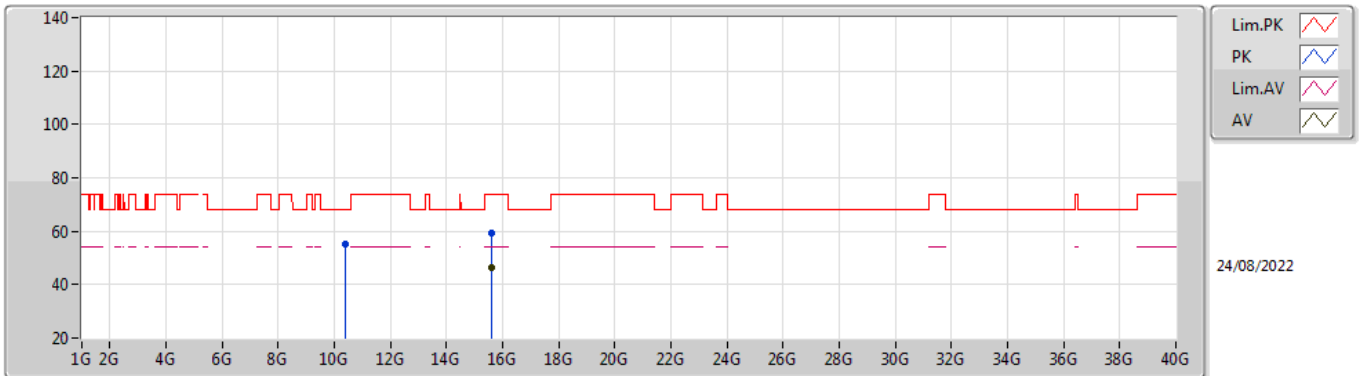

EUT Y_2TX
Setting 23
06-E-C-6

Type	Freq (Hz)	Level (dBuV/m)	Limit (dBuV/m)	Margin (dB)	Raw (dBuV)	Dist (m)	Condition	Azimuth (°)	Height (m)	Comment	AF (dB)	CL (dB)	PA (dB)
PK	10.38566G	55.41	68.20	-12.79	41.46	3	Vertical	196	2.21	-	40.04	8.53	34.62
PK	15.61014G	59.10	74.00	-14.90	45.59	3	Vertical	162	1.24	-	38.08	10.24	34.81
AV	15.5904G	46.33	54.00	-7.67	32.74	3	Vertical	162	1.24	-	38.16	10.24	34.81

802.11ax HEW20_Nss1,(MCS0)_2TX

5200MHz_TnomVnom

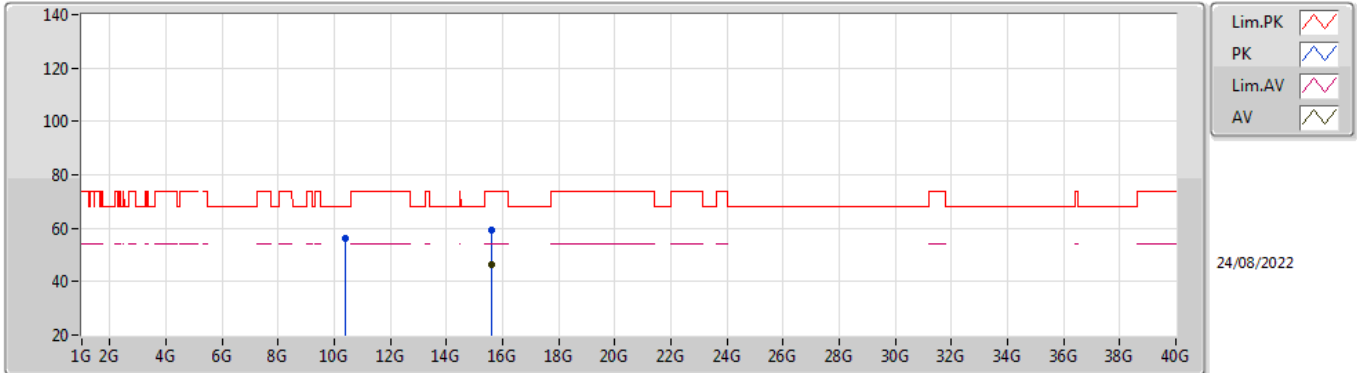

EUT Y_2TX
Setting 23
06-E-C-6

Type	Freq (Hz)	Level (dBuV/m)	Limit (dBuV/m)	Margin (dB)	Raw (dBuV)	Dist (m)	Condition	Azimuth (°)	Height (m)	Comment	AF (dB)	CL (dB)	PA (dB)
PK	10.41176G	56.16	68.20	-12.04	42.14	3	Horizontal	190	2.47	-	40.11	8.55	34.64
PK	15.60378G	59.15	74.00	-14.85	45.63	3	Horizontal	350	2.78	-	38.09	10.24	34.81
AV	15.59136G	46.35	54.00	-7.65	32.77	3	Horizontal	350	2.78	-	38.15	10.24	34.81

802.11ax HEW40_Nss1,(MCS0)_2TX

5190MHz_TnomVnom

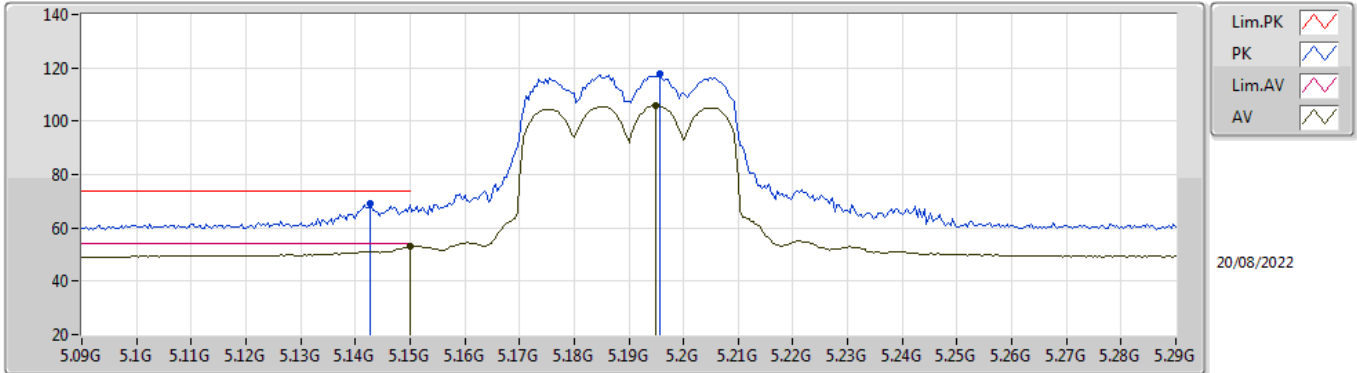

EUT Y_2TX
Setting 19
01-L-K-3-10

Type	Freq (Hz)	Level (dBuV/m)	Limit (dBuV/m)	Margin (dB)	Raw (dBuV)	Dist (m)	Condition	Azimuth (°)	Height (m)	Comment	AF (dB)	CL (dB)	PA (dB)
PK	5.1428G	69.28	74.00	-4.72	62.99	3	Vertical	182	1.98	-	32.71	6.37	32.79
AV	5.15G	53.14	54.00	-0.86	46.86	3	Vertical	182	1.98	-	32.70	6.37	32.79
PK	5.1956G	117.59	Inf	-Inf	111.26	3	Vertical	182	1.98	-	32.70	6.40	32.77
AV	5.1948G	105.76	Inf	-Inf	99.43	3	Vertical	182	1.98	-	32.70	6.40	32.77

802.11ax HEW40_Nss1,(MCS0)_2TX

5190MHz_TnomVnom

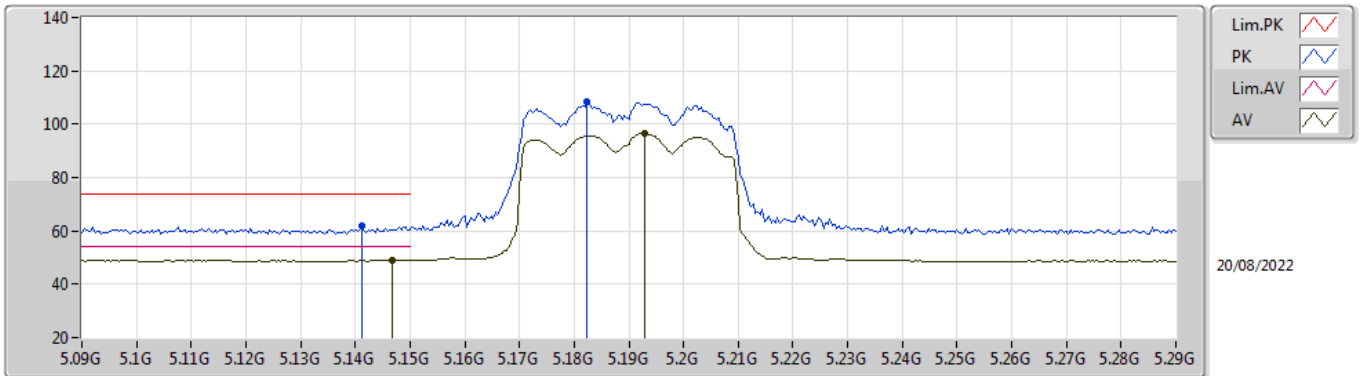

EUT V_2TX
Setting 19
01-L-K-3-10

Type	Freq (Hz)	Level (dBuV/m)	Limit (dBuV/m)	Margin (dB)	Raw (dBuV)	Dist (m)	Condition	Azimuth (°)	Height (m)	Comment	AF (dB)	CL (dB)	PA (dB)
PK	5.1412G	61.78	74.00	-12.22	55.48	3	Horizontal	233	1.83	-	32.72	6.37	32.79
AV	5.1468G	49.15	54.00	-4.85	42.86	3	Horizontal	233	1.83	-	32.71	6.37	32.79
PK	5.1824G	108.26	Inf	-Inf	101.94	3	Horizontal	233	1.83	-	32.70	6.39	32.77
AV	5.1928G	96.50	Inf	-Inf	90.17	3	Horizontal	233	1.83	-	32.70	6.40	32.77

802.11ax HEW40_Nss1,(MCS0)_2TX

5190MHz_TnomVnom

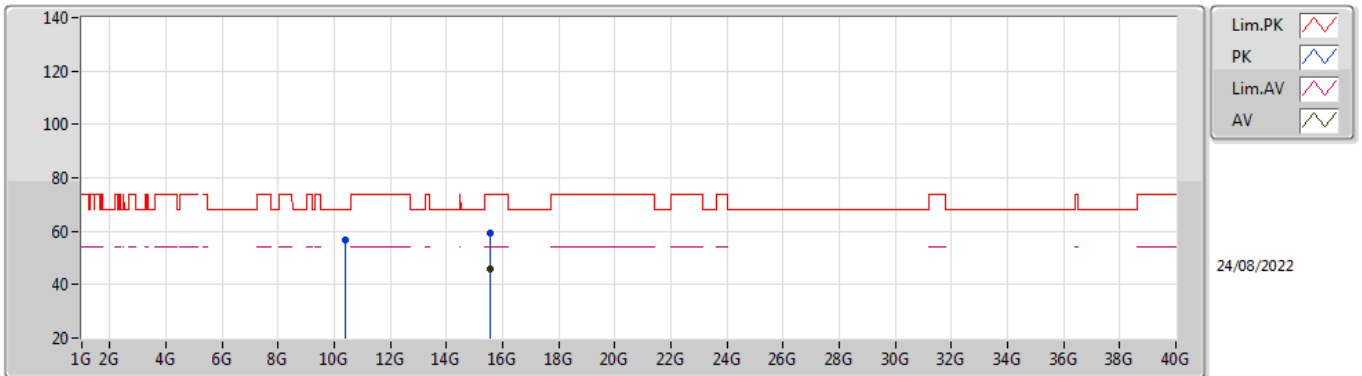

EUT Y_2TX
Setting 19
06-E-C-6

Type	Freq (Hz)	Level (dBuV/m)	Limit (dBuV/m)	Margin (dB)	Raw (dBuV)	Dist (m)	Condition	Azimuth (°)	Height (m)	Comment	AF (dB)	CL (dB)	PA (dB)
PK	10.36932G	56.58	68.20	-11.62	42.69	3	Vertical	32	2.75	-	39.98	8.52	34.61
PK	15.5772G	59.16	74.00	-14.84	45.50	3	Vertical	85	1.79	-	38.24	10.24	34.82
AV	15.56808G	45.99	54.00	-8.01	32.28	3	Vertical	85	1.79	-	38.29	10.24	34.82

802.11ax HEW40_Nss1,(MCS0)_2TX

5190MHz_TnomVnom

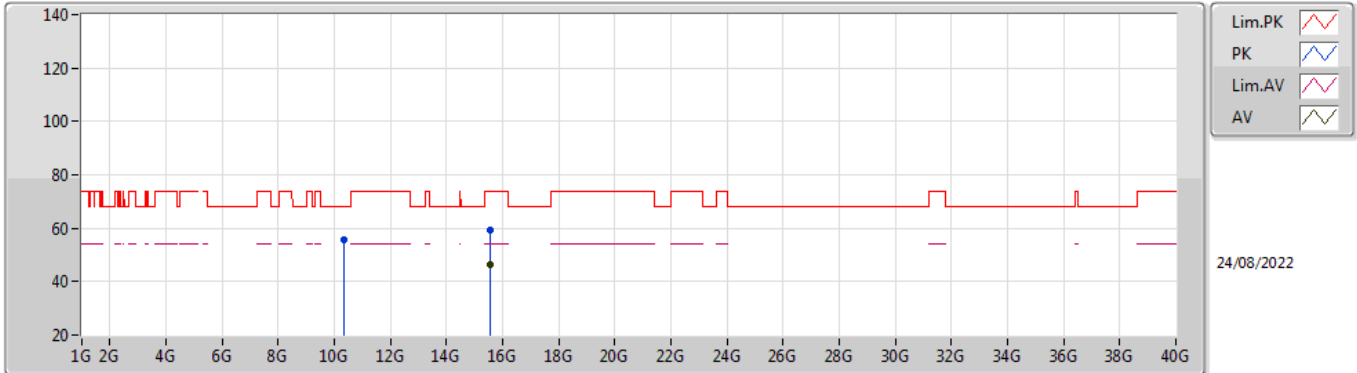

EUT Y_2TX
Setting 19
06-E-C-6

Type	Freq (Hz)	Level (dBuV/m)	Limit (dBuV/m)	Margin (dB)	Raw (dBuV)	Dist (m)	Condition	Azimuth (°)	Height (m)	Comment	AF (dB)	CL (dB)	PA (dB)
PK	10.36866G	55.57	68.20	-12.63	41.69	3	Horizontal	18	2.37	-	39.97	8.52	34.61
PK	15.57G	59.10	74.00	-14.90	45.40	3	Horizontal	289	1.68	-	38.28	10.24	34.82
AV	15.57174G	46.15	54.00	-7.85	32.46	3	Horizontal	289	1.68	-	38.27	10.24	34.82

802.11ax HEW40_Nss1,(MCS0)_2TX

5310MHz_TnomVnom

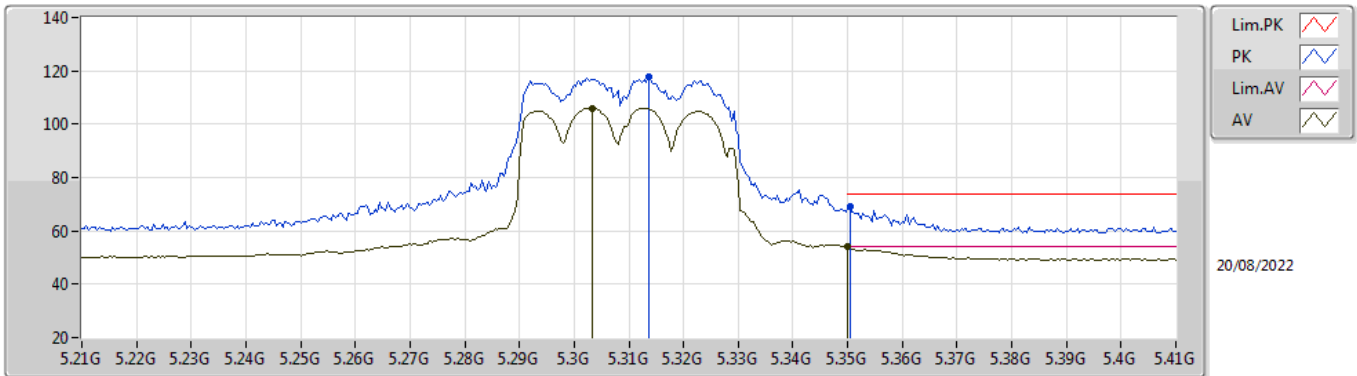

EUT_V_2TX
Setting 19
01-L-K-3-10

Type	Freq (Hz)	Level (dBuV/m)	Limit (dBuV/m)	Margin (dB)	Raw (dBuV)	Dist (m)	Condition	Azimuth (°)	Height (m)	Comment	AF (dB)	CL (dB)	PA (dB)
PK	5.3136G	117.79	Inf	-Inf	111.18	3	Vertical	186	2.11	-	32.93	6.40	32.72
AV	5.3032G	106.09	Inf	-Inf	99.50	3	Vertical	186	2.11	-	32.91	6.40	32.72
PK	5.3504G	69.25	74.00	-4.75	62.55	3	Vertical	186	2.11	-	33.00	6.40	32.70
AV	5.35G	53.98	54.00	-0.02	47.28	3	Vertical	186	2.11	-	33.00	6.40	32.70

802.11ax HEW40_Nss1,(MCS0)_2TX

5310MHz_TnomVnom

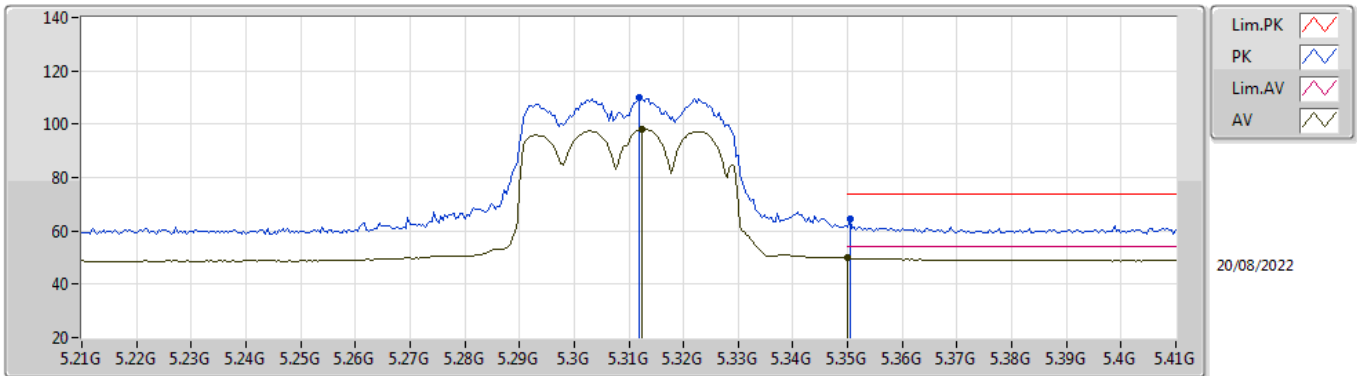

EUT Y_2TX
Setting 19
01-L-K-3-10

Type	Freq (Hz)	Level (dBuV/m)	Limit (dBuV/m)	Margin (dB)	Raw (dBuV)	Dist (m)	Condition	Azimuth (°)	Height (m)	Comment	AF (dB)	CL (dB)	PA (dB)
PK	5.312G	109.80	Inf	-Inf	103.20	3	Horizontal	282	1.54	-	32.92	6.40	32.72
AV	5.3124G	98.00	Inf	-Inf	91.40	3	Horizontal	282	1.54	-	32.92	6.40	32.72
PK	5.3504G	64.59	74.00	-9.41	57.89	3	Horizontal	282	1.54	-	33.00	6.40	32.70
AV	5.35G	49.80	54.00	-4.20	43.10	3	Horizontal	282	1.54	-	33.00	6.40	32.70

802.11ax HEW40_Nss1,(MCS0)_2TX

5310MHz_TnomVnom

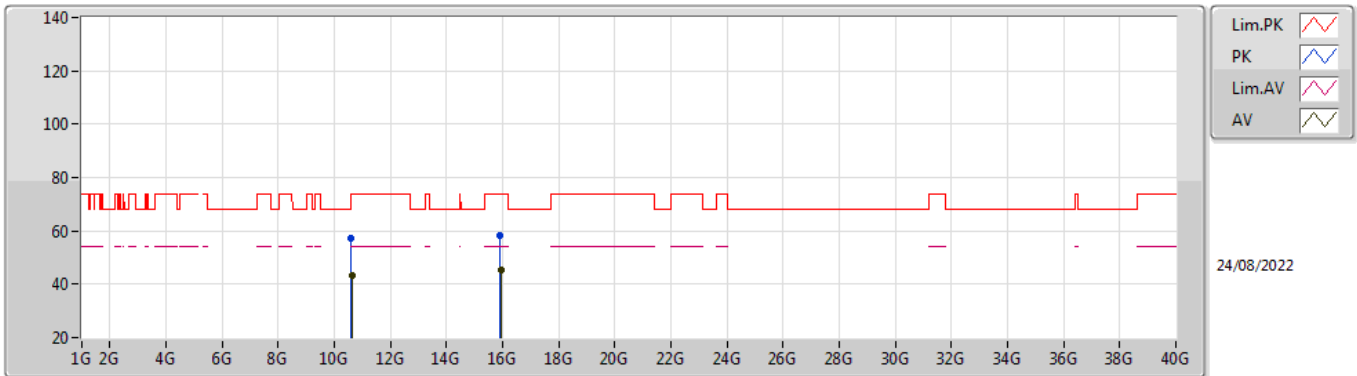

EUT Y_2TX
Setting 19
06-E-C-6

Type	Freq (Hz)	Level (dBuV/m)	Limit (dBuV/m)	Margin (dB)	Raw (dBuV)	Dist (m)	Condition	Azimuth (°)	Height (m)	Comment	AF (dB)	CL (dB)	PA (dB)
PK	10.60626G	57.00	74.00	-17.00	42.93	3	Vertical	272	2.08	-	40.10	8.66	34.69
AV	10.62714G	43.11	54.00	-10.89	29.02	3	Vertical	272	2.08	-	40.10	8.68	34.69
PK	15.91716G	58.42	74.00	-15.58	45.24	3	Vertical	299	2.93	-	37.68	10.29	34.79
AV	15.94278G	45.19	54.00	-8.81	32.03	3	Vertical	299	2.93	-	37.66	10.29	34.79

802.11ax HEW40_Nss1,(MCS0)_2TX

5310MHz_TnomVnom

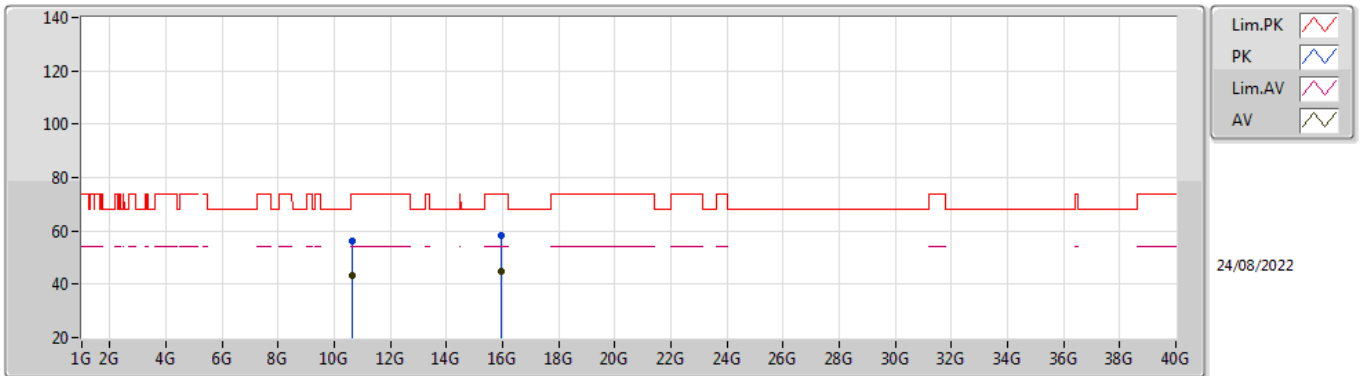

EUT Y_2TX
Setting 19
06-E-C-6

Type	Freq (Hz)	Level (dBuV/m)	Limit (dBuV/m)	Margin (dB)	Raw (dBuV)	Dist (m)	Condition	Azimuth (°)	Height (m)	Comment	AF (dB)	CL (dB)	PA (dB)
PK	10.62138G	56.46	74.00	-17.54	42.38	3	Horizontal	169	1.47	-	40.10	8.67	34.69
AV	10.6161G	43.12	54.00	-10.88	29.04	3	Horizontal	169	1.47	-	40.10	8.67	34.69
PK	15.93942G	58.10	74.00	-15.90	44.94	3	Horizontal	9	2.23	-	37.66	10.29	34.79
AV	15.94026G	45.06	54.00	-8.94	31.90	3	Horizontal	9	2.23	-	37.66	10.29	34.79

802.11ax HEW80_Nss1,(MCS0)_2TX

5290MHz_TnomVnom

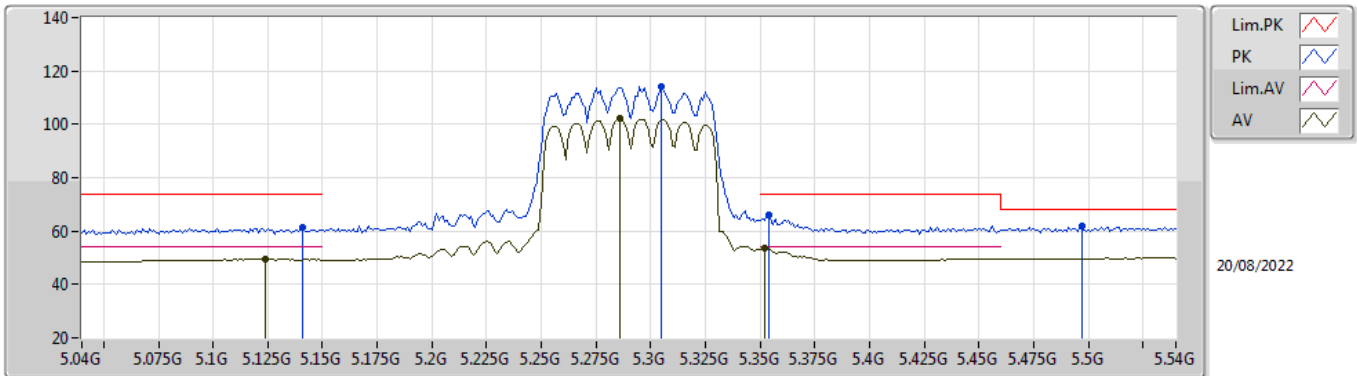

EUT_V_2TX
Setting 18.5
01-L-K-3-10

Type	Freq (Hz)	Level (dBuV/m)	Limit (dBuV/m)	Margin (dB)	Raw (dBuV)	Dist (m)	Condition	Azimuth (°)	Height (m)	Comment	AF (dB)	CL (dB)	PA (dB)
PK	5.141G	61.28	74.00	-12.72	54.98	3	Vertical	7	2.11	-	32.72	6.37	32.79
AV	5.124G	49.56	54.00	-4.44	43.25	3	Vertical	7	2.11	-	32.75	6.36	32.80
PK	5.305G	114.28	Inf	-Inf	107.69	3	Vertical	7	2.11	-	32.91	6.40	32.72
AV	5.286G	102.16	Inf	-Inf	95.62	3	Vertical	7	2.11	-	32.87	6.40	32.73
PK	5.354G	65.80	74.00	-8.20	59.08	3	Vertical	7	2.11	-	33.02	6.40	32.70
AV	5.352G	53.76	54.00	-0.24	47.05	3	Vertical	7	2.11	-	33.01	6.40	32.70
PK	5.497G	61.80	68.20	-6.40	54.24	3	Vertical	7	2.11	-	33.70	6.50	32.64

802.11ax HEW80_Nss1,(MCS0)_2TX

5290MHz_TnomVnom

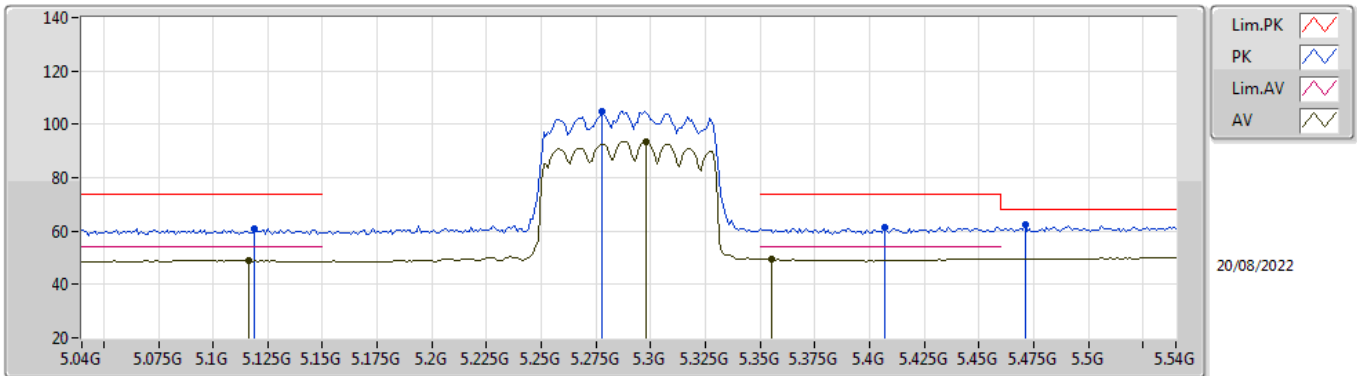

EUT_V_2TX
Setting 18.5
01-L-K-3-10

Type	Freq (Hz)	Level (dBuV/m)	Limit (dBuV/m)	Margin (dB)	Raw (dBuV)	Dist (m)	Condition	Azimuth (°)	Height (m)	Comment	AF (dB)	CL (dB)	PA (dB)
PK	5.119G	60.78	74.00	-13.22	54.46	3	Horizontal	231	1.79	-	32.76	6.36	32.80
AV	5.116G	48.93	54.00	-5.07	42.60	3	Horizontal	231	1.79	-	32.77	6.36	32.80
PK	5.278G	105.05	Inf	-Inf	98.52	3	Horizontal	231	1.79	-	32.86	6.40	32.73
AV	5.298G	93.68	Inf	-Inf	87.10	3	Horizontal	231	1.79	-	32.90	6.40	32.72
PK	5.407G	61.51	74.00	-12.49	54.51	3	Horizontal	231	1.79	-	33.27	6.41	32.68
AV	5.355G	49.45	54.00	-4.55	42.73	3	Horizontal	231	1.79	-	33.02	6.40	32.70
PK	5.471G	62.45	68.20	-5.75	54.93	3	Horizontal	231	1.79	-	33.70	6.47	32.65

802.11ax HEW80_Nss1,(MCS0)_2TX

5290MHz_TnomVnom

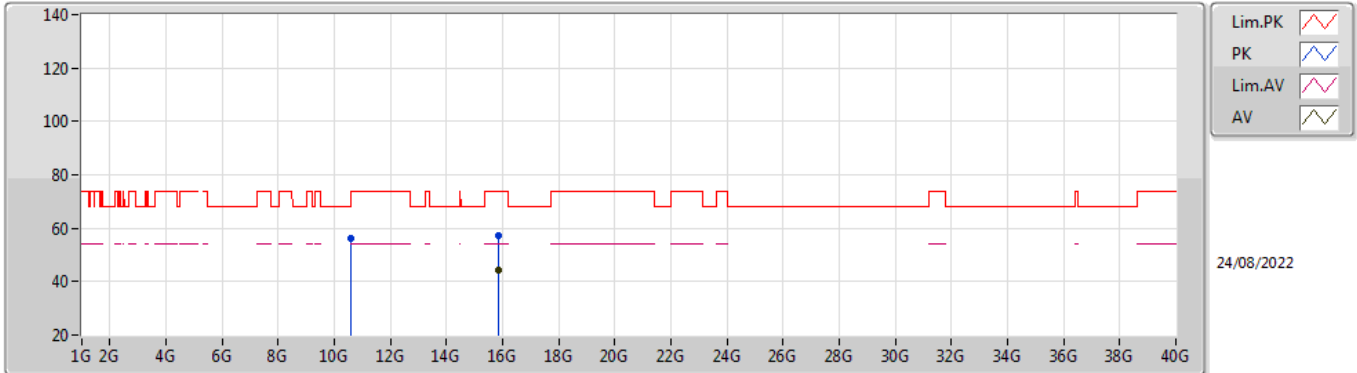

EUT Y_2TX
Setting 18.5
06-E-C-6

Type	Freq (Hz)	Level (dBuV/m)	Limit (dBuV/m)	Margin (dB)	Raw (dBuV)	Dist (m)	Condition	Azimuth (°)	Height (m)	Comment	AF (dB)	CL (dB)	PA (dB)
PK	10.56914G	55.99	68.20	-12.21	41.91	3	Vertical	333	2.94	-	40.13	8.64	34.69
PK	15.87276G	57.41	74.00	-16.59	44.18	3	Vertical	90	2.28	-	37.75	10.28	34.80
AV	15.86784G	44.49	54.00	-9.51	31.25	3	Vertical	90	2.28	-	37.76	10.28	34.80

802.11ax HEW80_Nss1,(MCS0)_2TX

5290MHz_TnomVnom

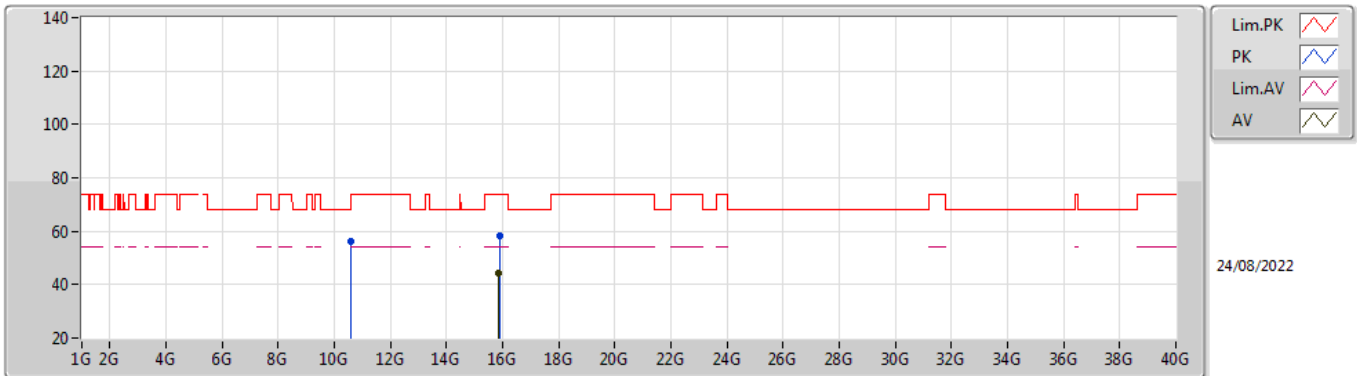

EUT Y_2TX
Setting 18.5
06-E-C-6

Type	Freq (Hz)	Level (dBuV/m)	Limit (dBuV/m)	Margin (dB)	Raw (dBuV)	Dist (m)	Condition	Azimuth (°)	Height (m)	Comment	AF (dB)	CL (dB)	PA (dB)
PK	10.58306G	56.02	68.20	-12.18	41.94	3	Horizontal	192	2.66	-	40.12	8.65	34.69
PK	15.88056G	58.44	74.00	-15.56	45.22	3	Horizontal	74	2.98	-	37.74	10.28	34.80
AV	15.87594G	44.32	54.00	-9.68	31.09	3	Horizontal	74	2.98	-	37.75	10.28	34.80

802.11ax HEW20-BF_Nss1,(MCS0)_2TX

5180MHz_TnomVnom

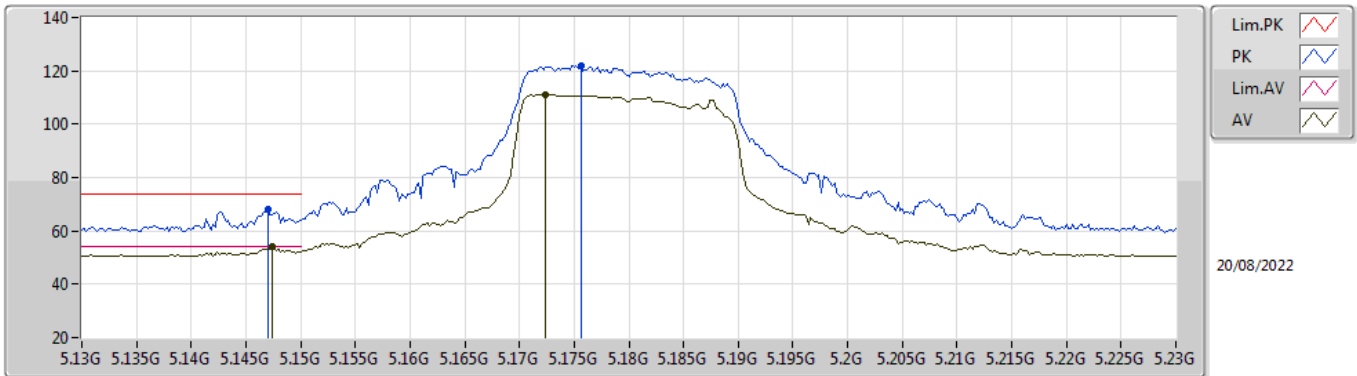

EUT V_2TX
Setting 23
01-L-K-3-10

Type	Freq (Hz)	Level (dBuV/m)	Limit (dBuV/m)	Margin (dB)	Raw (dBuV)	Dist (m)	Condition	Azimuth (°)	Height (m)	Comment	AF (dB)	CL (dB)	PA (dB)
PK	5.147G	67.95	74.00	-6.05	61.66	3	Vertical	183	1.99	-	32.71	6.37	32.79
AV	5.1474G	53.96	54.00	-0.04	47.67	3	Vertical	183	1.99	-	32.71	6.37	32.79
PK	5.1756G	121.83	Inf	-Inf	115.52	3	Vertical	183	1.99	-	32.70	6.39	32.78
AV	5.1724G	111.15	Inf	-Inf	104.84	3	Vertical	183	1.99	-	32.70	6.39	32.78

802.11ax HEW20-BF_Nss1,(MCS0)_2TX

5180MHz_TnomVnom

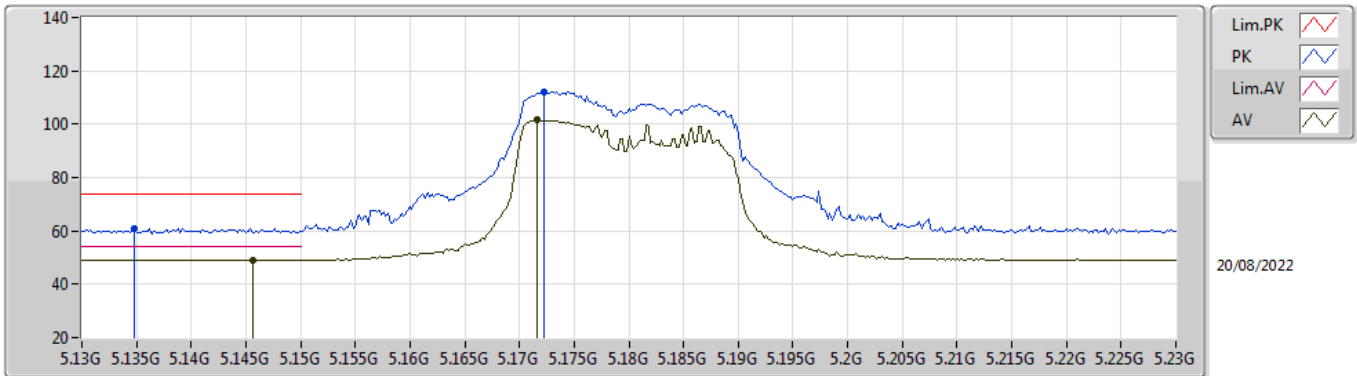

EUT Y_2TX
Setting 23
01-L-K-3-10

Type	Freq (Hz)	Level (dBuV/m)	Limit (dBuV/m)	Margin (dB)	Raw (dBuV)	Dist (m)	Condition	Azimuth (°)	Height (m)	Comment	AF (dB)	CL (dB)	PA (dB)
PK	5.1348G	61.08	74.00	-12.92	54.77	3	Horizontal	231	1.86	-	32.73	6.37	32.79
AV	5.1456G	49.16	54.00	-4.84	42.87	3	Horizontal	231	1.86	-	32.71	6.37	32.79
PK	5.1722G	112.08	Inf	-Inf	105.77	3	Horizontal	231	1.86	-	32.70	6.39	32.78
AV	5.1716G	101.53	Inf	-Inf	95.22	3	Horizontal	231	1.86	-	32.70	6.39	32.78

802.11ax HEW20-BF_Nss1,(MCS0)_2TX

5180MHz_TnomVnom

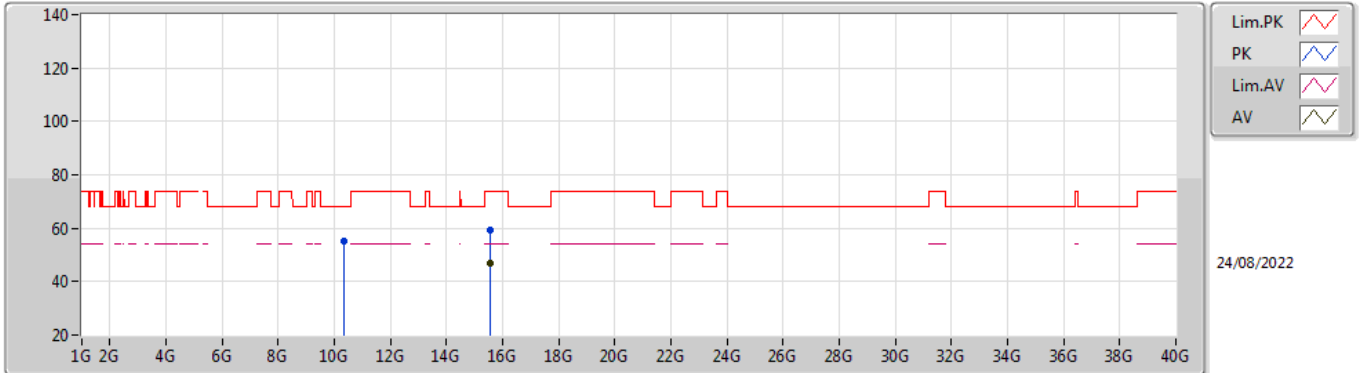

EUT Y_2TX
Setting 23
06-E-C-6

Type	Freq (Hz)	Level (dBuV/m)	Limit (dBuV/m)	Margin (dB)	Raw (dBuV)	Dist (m)	Condition	Azimuth (°)	Height (m)	Comment	AF (dB)	CL (dB)	PA (dB)
PK	10.36G	55.41	68.20	-12.79	41.55	3	Vertical	260	1.28	-	39.94	8.52	34.60
PK	15.5346G	59.10	74.00	-14.90	45.20	3	Vertical	105	2.05	-	38.49	10.23	34.82
AV	15.53796G	46.64	54.00	-7.36	32.76	3	Vertical	105	2.05	-	38.47	10.23	34.82

802.11ax HEW20-BF_Nss1,(MCS0)_2TX

5180MHz_TnomVnom

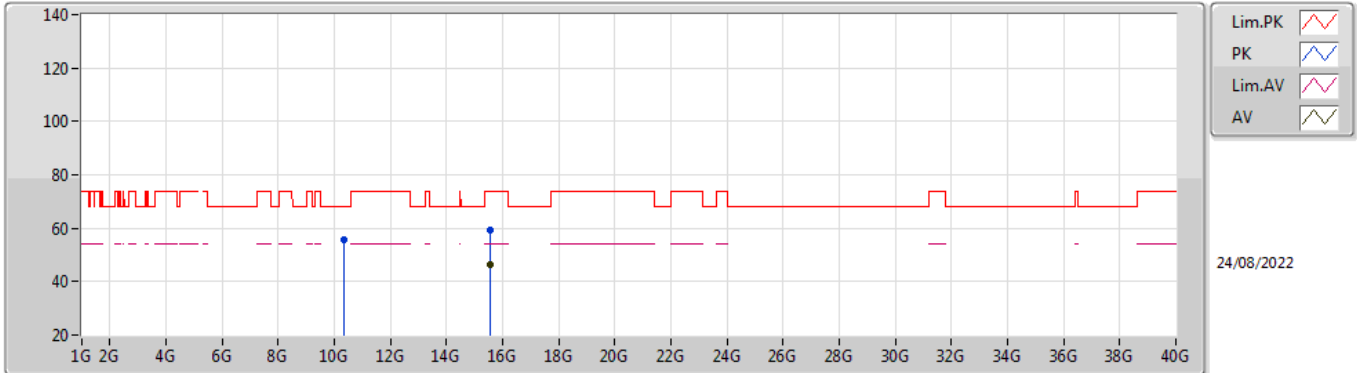

EUT Y_2TX
Setting 23
06-E-C-6

Type	Freq (Hz)	Level (dBuV/m)	Limit (dBuV/m)	Margin (dB)	Raw (dBuV)	Dist (m)	Condition	Azimuth (°)	Height (m)	Comment	AF (dB)	CL (dB)	PA (dB)
PK	10.36378G	55.59	68.20	-12.61	41.71	3	Horizontal	78	2.43	-	39.96	8.52	34.60
PK	15.54306G	59.43	74.00	-14.57	45.58	3	Horizontal	52	1.68	-	38.44	10.23	34.82
AV	15.53784G	46.50	54.00	-7.50	32.62	3	Horizontal	52	1.68	-	38.47	10.23	34.82

802.11ax HEW40-BF_Nss1,(MCS0)_2TX

5190MHz_TnomVnom

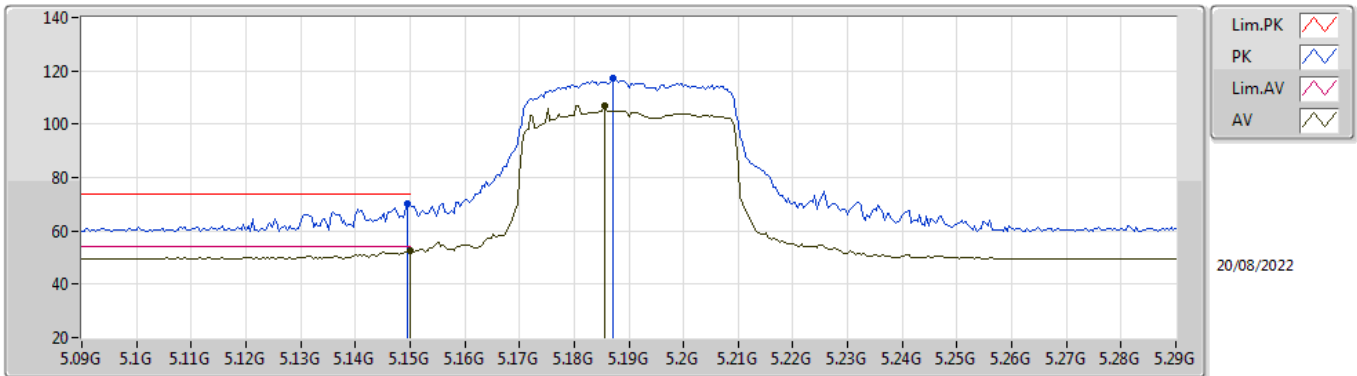

EUT V_2TX
Setting 21
01-L-K-3-10

Type	Freq (Hz)	Level (dBuV/m)	Limit (dBuV/m)	Margin (dB)	Raw (dBuV)	Dist (m)	Condition	Azimuth (°)	Height (m)	Comment	AF (dB)	CL (dB)	PA (dB)
PK	5.1496G	70.20	74.00	-3.80	63.92	3	Vertical	346.2	2.12	-	32.70	6.37	32.79
AV	5.15G	52.40	54.00	-1.60	46.12	3	Vertical	346.2	2.12	-	32.70	6.37	32.79
PK	5.1872G	117.18	Inf	-Inf	110.86	3	Vertical	346.2	2.12	-	32.70	6.39	32.77
AV	5.1856G	107.05	Inf	-Inf	100.73	3	Vertical	346.2	2.12	-	32.70	6.39	32.77

802.11ax HEW40-BF_Nss1,(MCS0)_2TX

5190MHz_TnomVnom

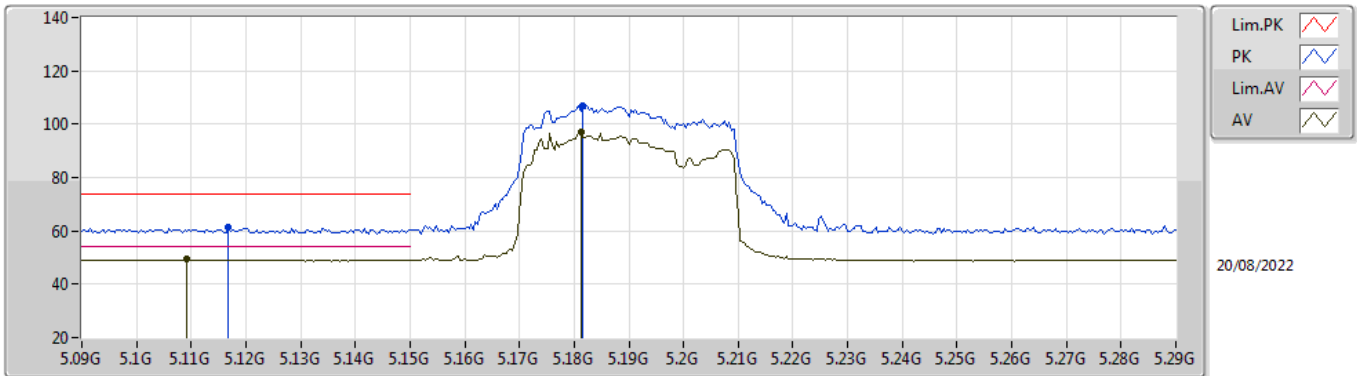

EUT V_2TX
Setting 21
01-L-K-3-10

Type	Freq (Hz)	Level (dBuV/m)	Limit (dBuV/m)	Margin (dB)	Raw (dBuV)	Dist (m)	Condition	Azimuth (°)	Height (m)	Comment	AF (dB)	CL (dB)	PA (dB)
PK	5.1168G	61.51	74.00	-12.49	55.18	3	Horizontal	281	3.00	-	32.77	6.36	32.80
AV	5.1092G	49.24	54.00	-4.76	42.91	3	Horizontal	281	3.00	-	32.78	6.35	32.80
PK	5.1816G	106.82	Inf	-Inf	100.50	3	Horizontal	281	3.00	-	32.70	6.39	32.77
AV	5.1812G	97.04	Inf	-Inf	90.72	3	Horizontal	281	3.00	-	32.70	6.39	32.77

802.11ax HEW40-BF_Nss1,(MCS0)_2TX

5190MHz_TnomVnom

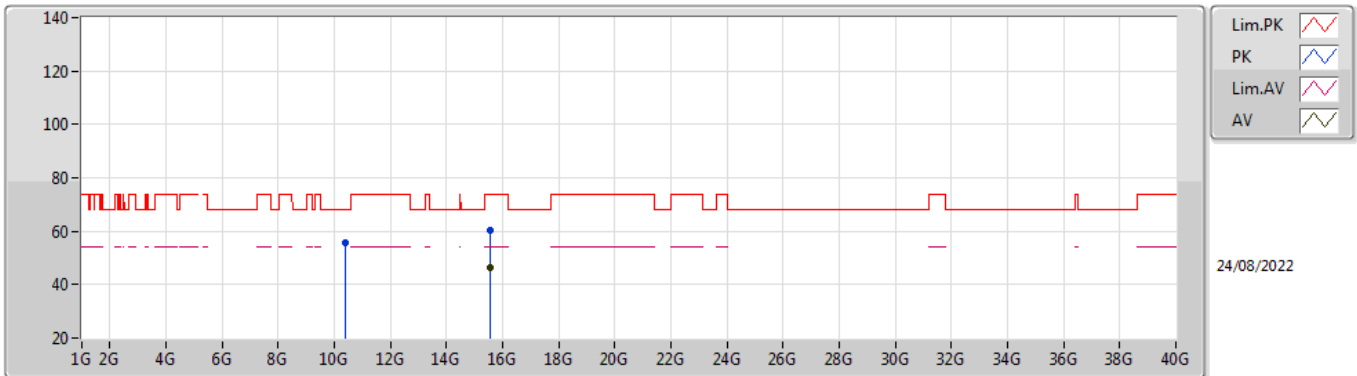

EUT Y_2TX
Setting 21
06-E-C-6

Type	Freq (Hz)	Level (dBuV/m)	Limit (dBuV/m)	Margin (dB)	Raw (dBuV)	Dist (m)	Condition	Azimuth (°)	Height (m)	Comment	AF (dB)	CL (dB)	PA (dB)
PK	10.38306G	55.90	68.20	-12.30	41.96	3	Vertical	21	1.63	-	40.03	8.53	34.62
PK	15.58056G	60.12	74.00	-13.88	46.48	3	Vertical	122	2.22	-	38.22	10.24	34.82
AV	15.57438G	46.55	54.00	-7.45	32.88	3	Vertical	122	2.22	-	38.25	10.24	34.82

802.11ax HEW40-BF_Nss1,(MCS0)_2TX

5190MHz_TnomVnom

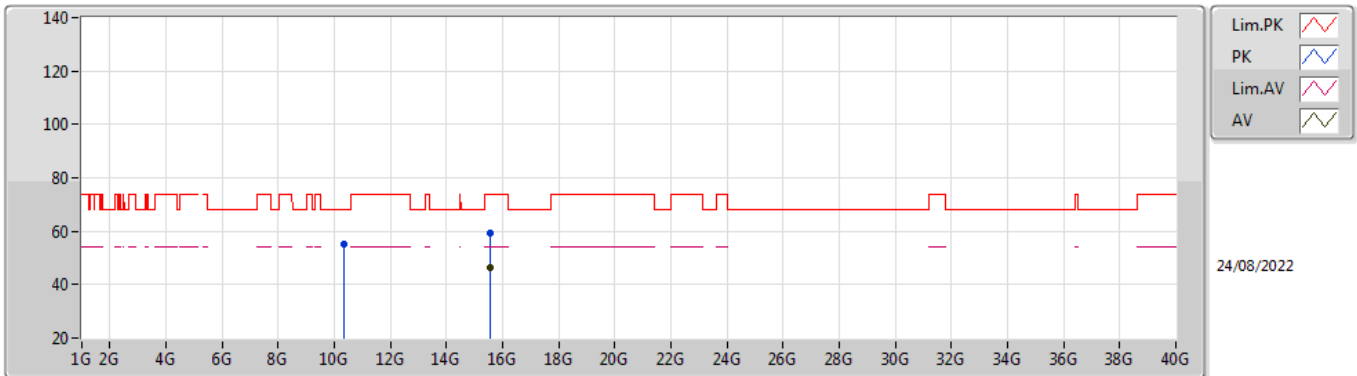

EUT Y_2TX
Setting 21
06-E-C-6

Type	Freq (Hz)	Level (dBuV/m)	Limit (dBuV/m)	Margin (dB)	Raw (dBuV)	Dist (m)	Condition	Azimuth (°)	Height (m)	Comment	AF (dB)	CL (dB)	PA (dB)
PK	10.36842G	55.13	68.20	-13.07	41.25	3	Horizontal	3	1.05	-	39.97	8.52	34.61
PK	15.57036G	59.42	74.00	-14.58	45.72	3	Horizontal	210	1.64	-	38.28	10.24	34.82
AV	15.5682G	46.50	54.00	-7.50	32.79	3	Horizontal	210	1.64	-	38.29	10.24	34.82

802.11ax HEW40-BF_Nss1,(MCS0)_4TX

5755MHz_TnomVnom

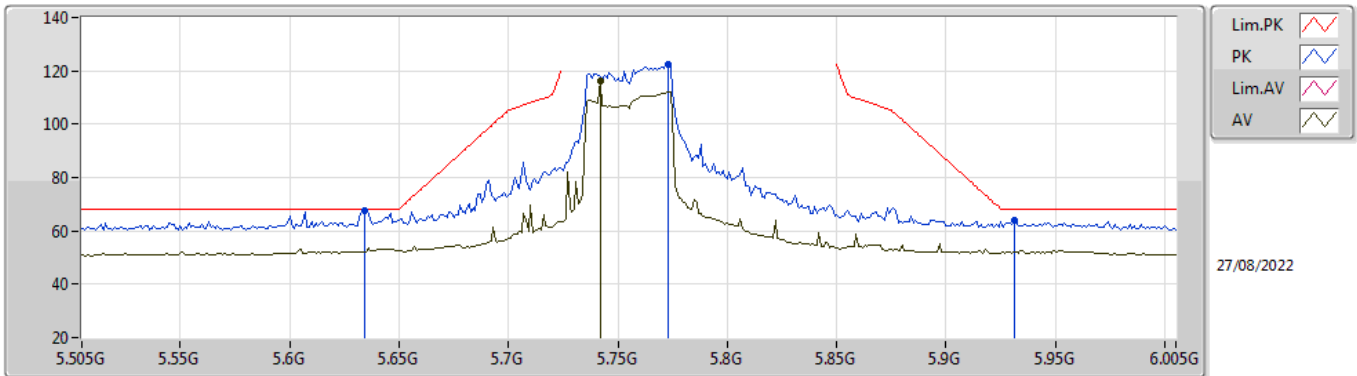

EUT Y_4TX
Setting 28
03-C-E-4-10

Type	Freq (Hz)	Level (dBuV/m)	Limit (dBuV/m)	Margin (dB)	Raw (dBuV)	Dist (m)	Condition	Azimuth (°)	Height (m)	Comment	AF (dB)	CL (dB)	PA (dB)
PK	5.773G	122.46	Inf	-Inf	115.78	3	Vertical	180.8	1.39	-	34.20	7.40	34.92
AV	5.742G	116.03	Inf	-Inf	109.32	3	Vertical	180.8	1.39	-	34.22	7.40	34.91
PK	5.931G	63.89	68.20	-4.31	56.59	3	Vertical	180.8	1.39	-	34.72	7.53	34.95
PK	5.634G	67.79	68.20	-0.41	60.75	3	Vertical	180.8	1.39	-	34.53	7.40	34.89

802.11ax HEW40-BF_Nss1,(MCS0)_4TX

5755MHz_TnomVnom

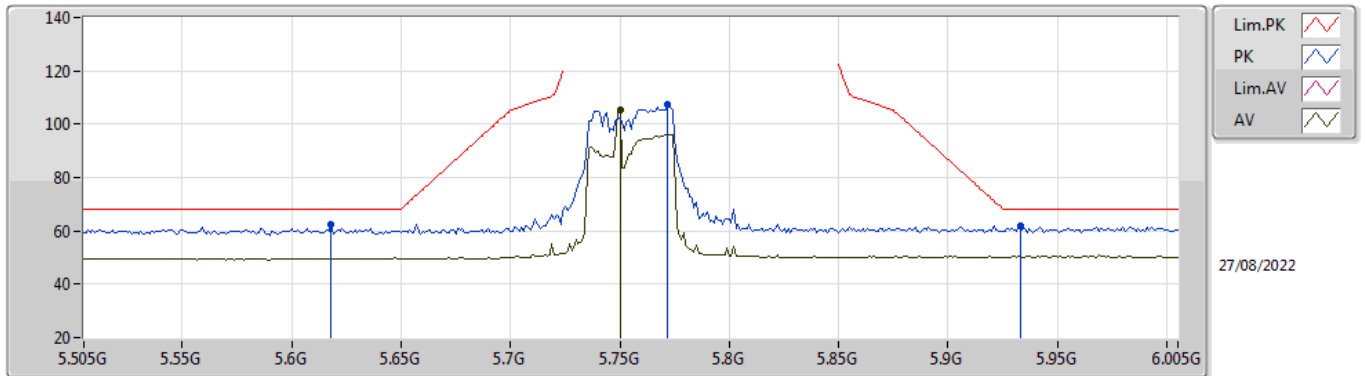

EUT Y_4TX
Setting 28
03-C-E-4-10

Type	Freq (Hz)	Level (dBuV/m)	Limit (dBuV/m)	Margin (dB)	Raw (dBuV)	Dist (m)	Condition	Azimuth (°)	Height (m)	Comment	AF (dB)	CL (dB)	PA (dB)
PK	5.618G	62.33	68.20	-5.87	55.26	3	Horizontal	41	2.31	-	34.56	7.40	34.89
PK	5.772G	107.41	Inf	-Inf	100.73	3	Horizontal	41	2.31	-	34.20	7.40	34.92
AV	5.75G	105.47	Inf	-Inf	98.78	3	Horizontal	41	2.31	-	34.20	7.40	34.91
PK	5.933G	61.91	68.20	-6.29	54.61	3	Horizontal	41	2.31	-	34.73	7.53	34.96

802.11ax HEW40-BF_Nss1,(MCS0)_4TX

5755MHz_TnomVnom

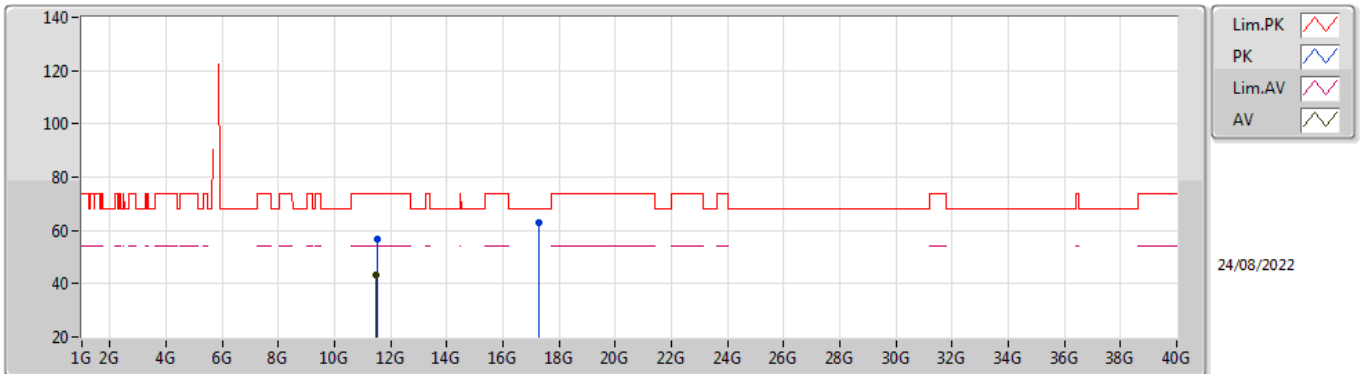

EUT Y_4TX
Setting 28
06-E-C-6

Type	Freq (Hz)	Level (dBuV/m)	Limit (dBuV/m)	Margin (dB)	Raw (dBuV)	Dist (m)	Condition	Azimuth (°)	Height (m)	Comment	AF (dB)	CL (dB)	PA (dB)
PK	11.507G	56.95	74.00	-17.05	42.29	3	Vertical	259	2.55	-	40.09	9.20	34.63
AV	11.495G	43.12	54.00	-10.88	28.45	3	Vertical	259	2.55	-	40.10	9.20	34.63
PK	17.26128G	62.92	68.20	-5.28	45.94	3	Vertical	180	2.27	-	41.42	10.62	35.06

802.11ax HEW40-BF_Nss1,(MCS0)_4TX

5755MHz_TnomVnom

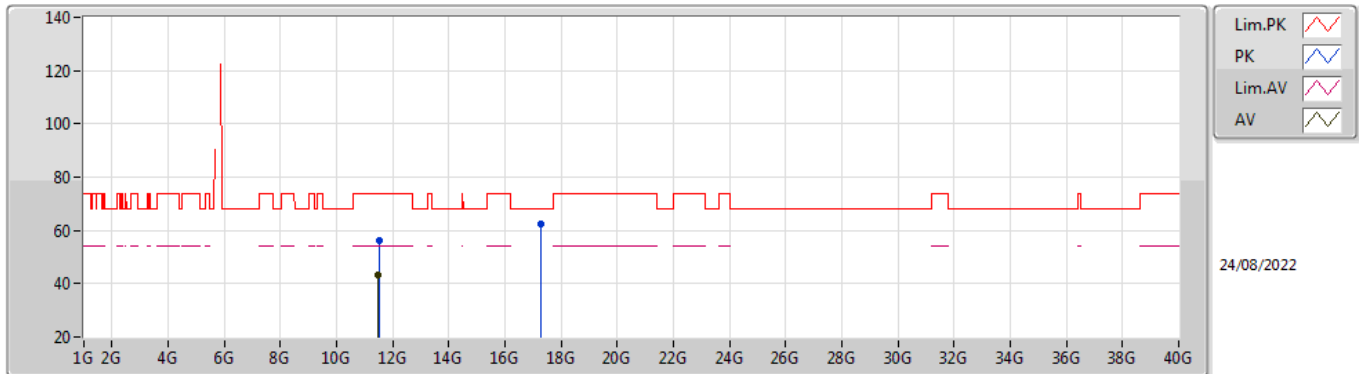

EUT Y_4TX
Setting 28
06-E-C-6

Type	Freq (Hz)	Level (dBuV/m)	Limit (dBuV/m)	Margin (dB)	Raw (dBuV)	Dist (m)	Condition	Azimuth (°)	Height (m)	Comment	AF (dB)	CL (dB)	PA (dB)
PK	11.50652G	56.25	74.00	-17.75	41.59	3	Horizontal	0	1.11	-	40.09	9.20	34.63
AV	11.49578G	43.16	54.00	-10.84	28.49	3	Horizontal	0	1.11	-	40.10	9.20	34.63
PK	17.27604G	62.37	68.20	-5.83	45.38	3	Horizontal	324	2.34	-	41.45	10.62	35.08