



中国认可
国际互认
检测
TESTING
CNAS L2264

RF TEST REPORT

Applicant	Alcatel-Lucent Shanghai Bell Co.Ltd.
FCC ID	2ADZRG240WF
Product	G-240W-F
Model	G-240W-F
Report No.	RXA1704-0102RF02
Issue Date	May 18, 2017

TA Technology (Shanghai) Co., Ltd. tested the above equipment in accordance with the requirements in **FCC CFR47 Part 15C (2016)**. The test results show that the equipment tested is capable of demonstrating compliance with the requirements as documented in this report.

Performed by: Xianqing Li

Approved by: Kai Xu

TA Technology (Shanghai) Co., Ltd.

No.145, Jintang Rd, Tangzhen Industry Park, Pudong Shanghai, China

TEL: +86-021-50791141/2/3

FAX: +86-021-50791141/2/3-8000



TABLE OF CONTENT

1. Test Laboratory	4
1.1. Notes of the test report.....	4
1.2. Test facility	4
1.3. Testing Location.....	5
2. General Description of Equipment under Test.....	6
3. Applied Standards	8
4. Test Configuration	9
5. Test Case Results	10
5.1. Average Power Output –Conducted.....	10
5.2. 6dB Bandwidth	19
5.3. Band Edge	28
5.4. Power Spectral Density	33
5.5. Spurious RF Conducted Emissions.....	42
5.6. Radiated Emissions in the Restricted Band	52
5.7. Radiates Emission	56
5.8. Conducted Emission	108
6. Main Test Instruments.....	114
ANNEX A: EUT Appearance and Test Setup.....	115
A.1 EUT Appearance	115
A.2 Test Setup	118



Summary of measurement results

Number	Summary of measurements of results	Clause in FCC rules	Verdict
1	Maximum Average conducted output power	15.247(b)(3)	PASS
2	6 dB bandwidth	15.247(a)(2)	PASS
3	Power spectral density	15.247(e)	PASS
4	Band Edge	15.247(d)	PASS
5	Spurious RF Conducted Emissions	15.247(d)	PASS
6	Radiated Emissions in restricted frequency bands	15.247(d),15.205,15.209	PASS
7	Radiated Emissions	15.247(d),15.205,15.209	PASS
8	Conducted Emissions	15.207	PASS
Date of Testing: April 17, 2017 ~ May 5, 2017			

1. Test Laboratory

1.1. Notes of the test report

This report shall not be reproduced in full or partial, without the written approval of **TA Technology (Shanghai) Co., Ltd.** The results documented in this report apply only to the tested sample, under the conditions and modes of operation as described herein .Measurement Uncertainties were not taken into account and are published for informational purposes only. This report is written to support regulatory compliance of the applicable standards stated above. This report must not be used by the client to claim product certification, approval, or endorsement by any government agencies.

1.2. Test facility

CNAS (accreditation number: L2264)

TA Technology (Shanghai) Co., Ltd. has obtained the accreditation of China National Accreditation Service for Conformity Assessment (CNAS).

FCC (recognition number is 428261)

TA Technology (Shanghai) Co., Ltd. has been listed on the US Federal Communications Commission list of test facilities recognized to perform electromagnetic emissions measurements.

IC (recognition number is 8510A)

TA Technology (Shanghai) Co., Ltd. has been listed by industry Canada to perform electromagnetic emission measurement.

VCCI (recognition number is C-4595, T-2154, R-4113, G-766)

TA Technology (Shanghai) Co., Ltd. has been listed by industry Japan to perform electromagnetic emission measurement.

A2LA (Certificate Number: 3857.01)

TA Technology (Shanghai) Co., Ltd. has been listed by American Association for Laboratory Accreditation to perform electromagnetic emission measurement.



1.3. Testing Location

Company: TA Technology (Shanghai) Co., Ltd.
Address: No.145, Jintang Rd, Tangzhen Industry Park, Pudong
City: Shanghai
Post code: 201201
Country: P. R. China
Contact: Xu Kai
Telephone: +86-021-50791141/2/3
Fax: +86-021-50791141/2/3-8000
Website: <http://www.ta-shanghai.com>
E-mail: xukai@ta-shanghai.com

2. General Description of Equipment under Test

Client Information

Applicant	Alcatel-Lucent Shanghai Bell Co.Ltd.
Applicant address	388-389#,Ningqiao Road,Pudong Jinqiao, Shanghai P. R. China
Manufacturer	TAICANG T&W ELECTRONICS CO., LTD
Manufacturer address	Jiangnan Road 89, Loudong Street, Taicang, Jiangsu, P. R. China

General information

EUT Description	
Model:	G-240W-F
IMEI:	/
Hardware Version:	V1.0
Software Version:	V1.0
Power Supply:	AC adapter
Antenna Type:	External Antenna
Antenna Connector:	A permanently attached antenna (meet with the standard FCC Part 15.203 requirement)
Antenna Gain:	5.00 dBi
Directional Gain:	5.00 dBi
Test Mode:	802.11b 802.11g, 802.11n(HT20/HT40);
Modulation Type:	802.11b: DSSS; 802.11g/n(HT20/HT40): OFDM
Max. Conducted Power	Wi-Fi 2.4G :14.09dBm
Operating Frequency Range(s)	802.11b/g/n(HT20): 2412 ~ 2462 MHz 802.11n(HT40): 2422 ~ 2452 MHz
EUT Accessory	
Adapter 1	Manufacturer: DONGGUAN SHILONG FUHUA ELECTRONIC CO., LTD. Model: UES18W3-120150SPAV Input power:100-240 VAC 50-60Hz 0.5A Output power:12.0V DC 1.5A
Adapter 2	Manufacturer: DONGGUAN SHILONG FUHUA ELECTRONIC CO., LTD. Model: UES18W3-120150SPAU



	Input power:100-240 VAC 50-60Hz 0.5A Output power:12.0V DC 1.5A
Adapter 3	Manufacturer: DONGGUAN SHILONG FUHUA ELECTRONIC CO., LTD. Model: UES18W3-120150SPABE Input power:100-240 VAC 50-60Hz 0.5A Output power:12.0V DC 1.5A
<p>Remark: 1.The information of the EUT is declared by the manufacturer. Please refer to the specifications or user manual for details.</p> <p>2. There is more than one adapter, each one should be applied throughout the compliance test respectively, however, only the worst case (Adapter 3) will be recorded in this report.</p>	

ONT Mnemonic	Kit Code	EMA Code	Part Description	Power Adaptor MPN
G-240W-F	3FE46649BB AA	3FE46597AB AA	GPON indoor ONT, 2POTS, 4GE, WIFI 100mW, SC/APC, VietTel Logo, 5dBi antenna. 1.5m CAT-5E Ethernet cable with RJ-45 endpoint, 1.5m RJ-11 cable, AC/DC power adapter, VietTel user manual	UES18W3-1201 50SPAV
G-240W-F	3FE46649BA AA	3FE46597AA AA	GPON indoor ONT, 2POTS, 4GE, WIFI 100mW, SC/APC, Nokia Logo, 5dBi antenna. 1.5m CAT-5E Ethernet cable with RJ-45 endpoint, 1.5m RJ-11 cable, AC/DC power adapter	UES18W3-1201 50SPAV
G-240W-F	3FE46649AA AA	3FE46597AC AA	GPON indoor ONT, 2POTS, 4GE, WIFI 100mW, SC/APC, Nokia Logo, 5dBi antenna. 1.5m CAT-5E Ethernet cable with RJ-45 endpoint, 1.5m RJ-11 cable, AC/DC power adapter	UES18W3-1201 50SPAU
G-240W-F	3FE46649CA AA	3FE46597AA AA	GPON indoor ONT, 2POTS, 4GE, WIFI 100mW, SC/APC, Nokia Logo, 5dBi antenna. 1.5m CAT-5E Ethernet cable with RJ-45 endpoint, 1.5m RJ-11 cable, AC/DC power adapter	UES18W3-1201 50SPABE

3. Applied Standards

According to the specifications of the manufacturer, it must comply with the requirements of the following standards:

Test standards

- **FCC CFR47 Part 15C (2016) Radio Frequency Devices**
- **ANSI C63.10 (2013)**
- **KDB 558074 D01 DTS Meas Guidance v04**
- **KDB 662911 D01 Multiple Transmitter Output v02r01**

4. Test Configuration

Test Mode

The EUT was programmed to be in continuously transmitting mode and the transmit duty cycle is not less than 98%.

The EUT has been associated with peripherals and configuration operated in a manner tended to maximize its emission characteristics in a typical application.

The radiated emission was measured in the following position: EUT stand-up position (Z axis), lie-down position (X, Y axis). The worst emission was found in stand-up position (Z axis) and the worst case was recorded.

In order to find the worst case condition, Pre-tests are needed at the presence of different data rate. Preliminary tests have been done on all the configuration for confirming worst case. Data rate below means worst-case rate of each test item.

Worst-case data rates are shown as following table.

Band	Data Rate
802.11b	1 Mbps
802.11g	6 Mbps
802.11n HT20	MCS0
802.11n HT40	MCS0

5. Test Case Results

5.1. Average Power Output –Conducted

Ambient condition

Temperature	Relative humidity	Pressure
23°C ~25°C	45%~50%	101.5kPa

Methods of Measurement

During the process of the testing, The EUT was connected to Spectrum Analyzer with a known loss. The EUT is max power transmission with proper modulation. The Average detector is used. We use Maximum Average Conducted Output Power Level Method in KDB 558074 D01/KDB662911 D01 for this test.

The conducted Power is measured at each antenna port. The measured results at the various antenna ports are then summed mathematically.

Test Setup

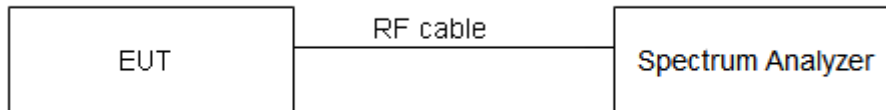

Limits

Rule Part 15.247 (b) (3) specifies that " For systems using digital modulation in the 902–928 MHz, 2400–2483.5 MHz: 1 Watt."

Average Output Power	≤ 1W (30dBm)
----------------------	--------------

Measurement Uncertainty

The assessed measurement uncertainty to ensure 95% confidence level for the normal distribution is with the coverage factor $k = 2$, $U = 0.44$ dB.

**Test Results****SISO****Antenna 1**

Network Standards	Carrier frequency (MHz)	Average Output Power (dBm)	Limit (dBm)	Conclusion
802.11b	2412	11.03	30	PASS
	2437	11.06	30	PASS
	2462	12.17	30	PASS
802.11g	2412	13.73	30	PASS
	2437	13.63	30	PASS
	2462	13.59	30	PASS
802.11n HT20	2412	10.61	30	PASS
	2437	10.38	30	PASS
	2462	10.43	30	PASS
802.11n HT40	2422	10.20	30	PASS
	2437	10.21	30	PASS
	2452	10.18	30	PASS

Antenna 2

Network Standards	Carrier frequency (MHz)	Average Output Power (dBm)	Limit (dBm)	Conclusion
802.11b	2412	13.09	30	PASS
	2437	12.74	30	PASS
	2462	12.71	30	PASS
802.11g	2412	14.09	30	PASS
	2437	13.64	30	PASS
	2462	13.66	30	PASS
802.11n HT20	2412	11.09	30	PASS
	2437	10.57	30	PASS
	2462	10.02	30	PASS
802.11n HT40	2422	9.99	30	PASS
	2437	10.02	30	PASS
	2452	9.83	30	PASS



MIMO

Network Standards	Carrier frequency (MHz)	Average Output Power (dBm)			Limit (dBm)	Conclusion
		MIMO Ant 1	MIMO Ant 2	MIMO Sum		
802.11n HT20	2412	10.58	10.09	13.35	30	PASS
	2437	10.58	10.25	13.43	30	PASS
	2462	10.40	10.40	13.41	30	PASS
802.11n HT40	2422	9.99	9.66	12.84	30	PASS
	2437	10.00	9.61	12.82	30	PASS
	2452	10.06	9.96	13.02	30	PASS

Antenna 1

802.11b, Carrier frequency (MHz): 2412

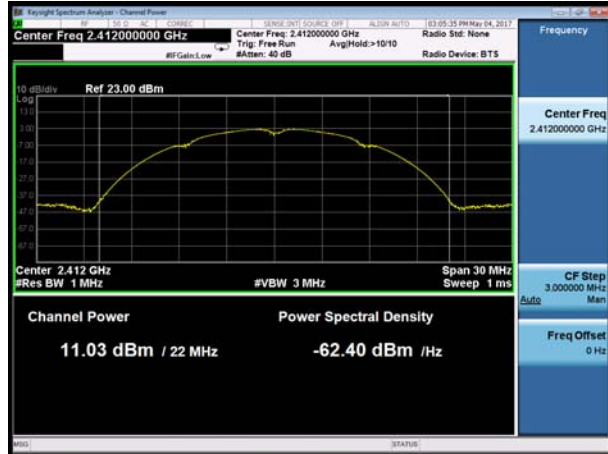

802.11g, Carrier frequency (MHz): 2412

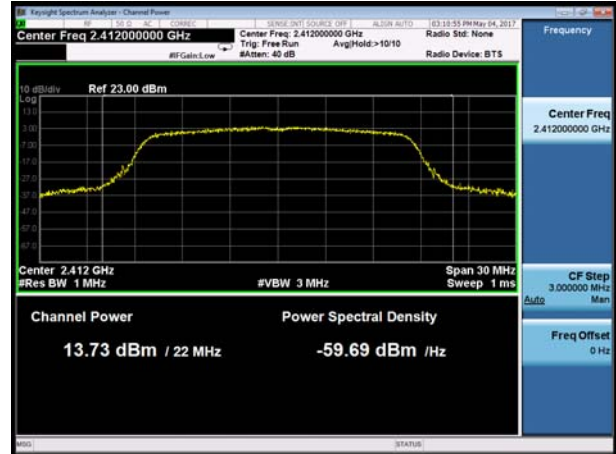

802.11b, Carrier frequency (MHz): 2437

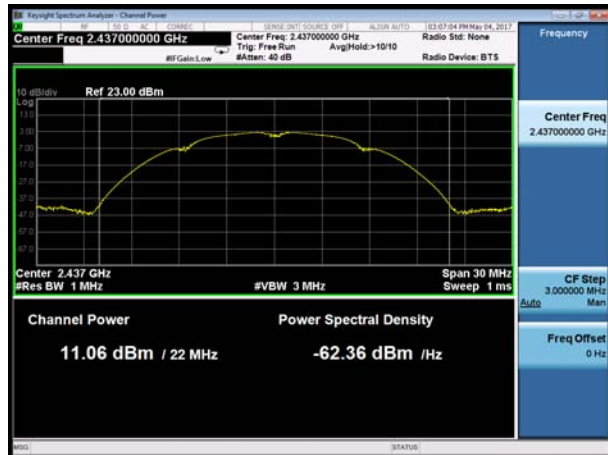

802.11g, Carrier frequency (MHz): 2437

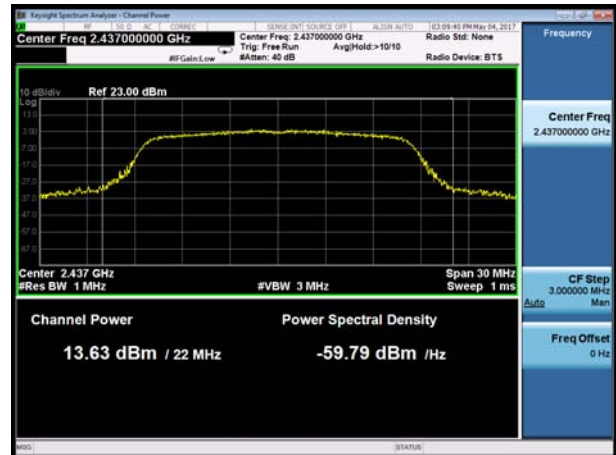

802.11b, Carrier frequency (MHz):2462

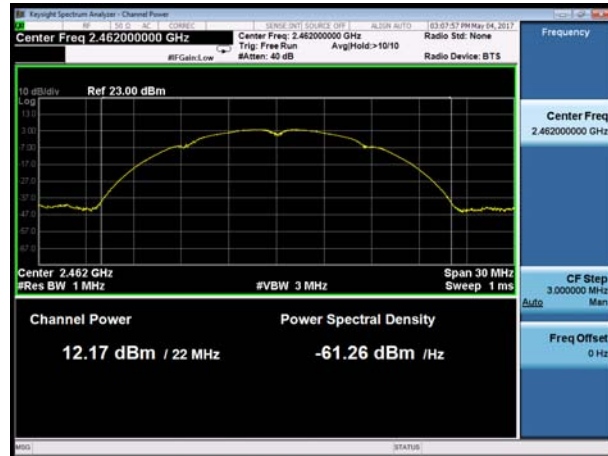

802.11g, Carrier frequency (MHz):2462



802.11n(HT20), Carrier frequency (MHz): 2412

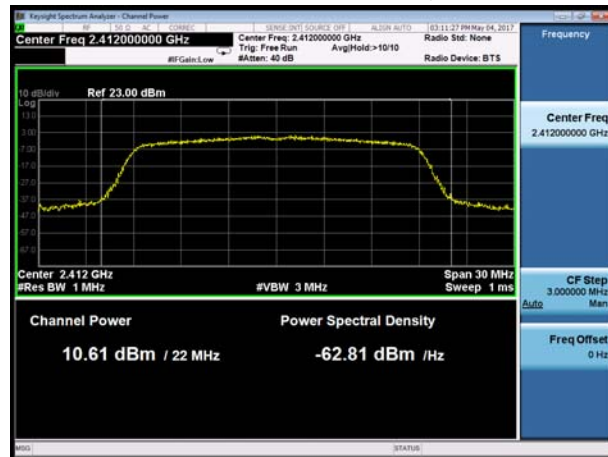

802.11n(HT40), Carrier frequency (MHz): 2422

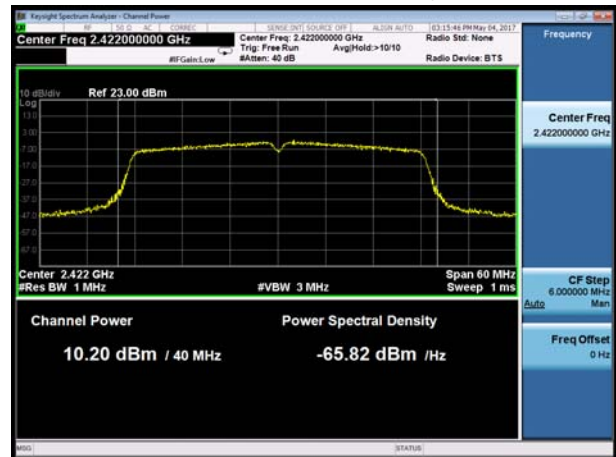

802.11n(HT20), Carrier frequency (MHz): 2437

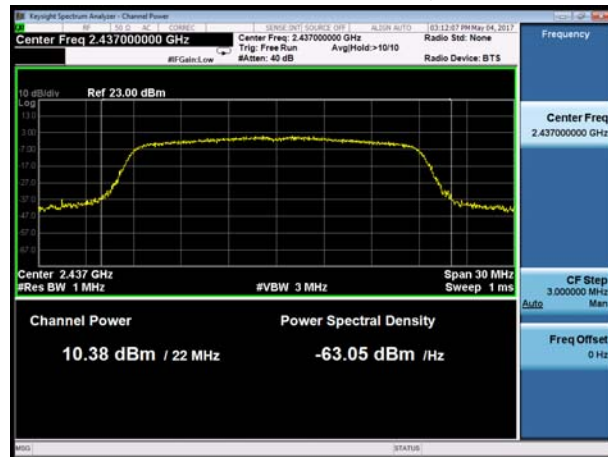

802.11n(HT40), Carrier frequency (MHz): 2437



802.11n(HT20), Carrier frequency (MHz):2462



802.11n(HT40), Carrier frequency (MHz):2452



Antenna 2

802.11b, Carrier frequency (MHz): 2412

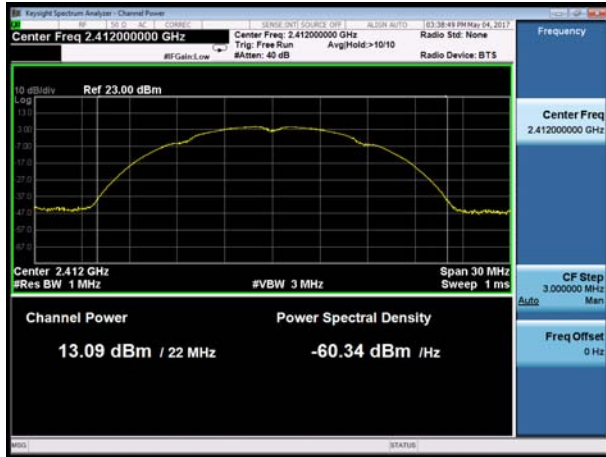

802.11g, Carrier frequency (MHz): 2412



802.11b, Carrier frequency (MHz): 2437

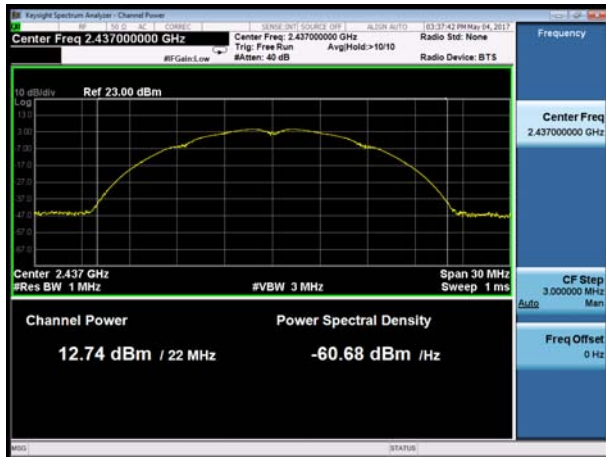

802.11g, Carrier frequency (MHz): 2437





802.11b, Carrier frequency (MHz):2462

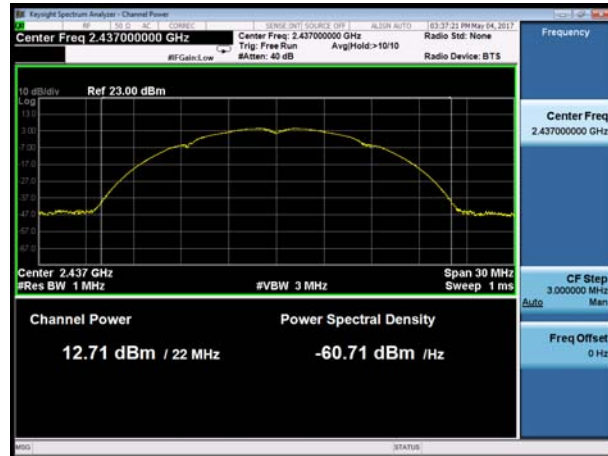

802.11g, Carrier frequency (MHz):2462



802.11n(HT20), Carrier frequency (MHz): 2412



802.11n(HT40), Carrier frequency (MHz): 2422



802.11n(HT20), Carrier frequency (MHz): 2437

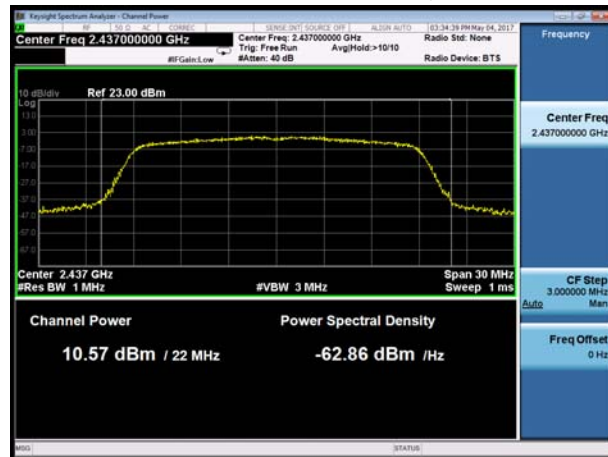

802.11n(HT40), Carrier frequency (MHz): 2437



802.11n(HT20), Carrier frequency (MHz):2462



802.11n(HT40), Carrier frequency (MHz):2452

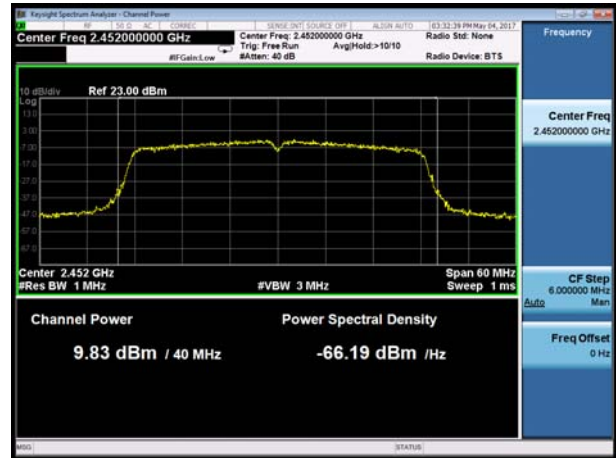

MIMO
Antenna 1

802.11n(HT20), Carrier frequency (MHz): 2412

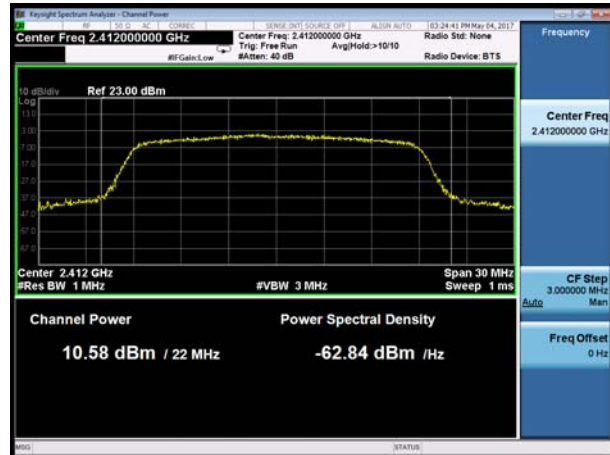

802.11n(HT40), Carrier frequency (MHz): 2422

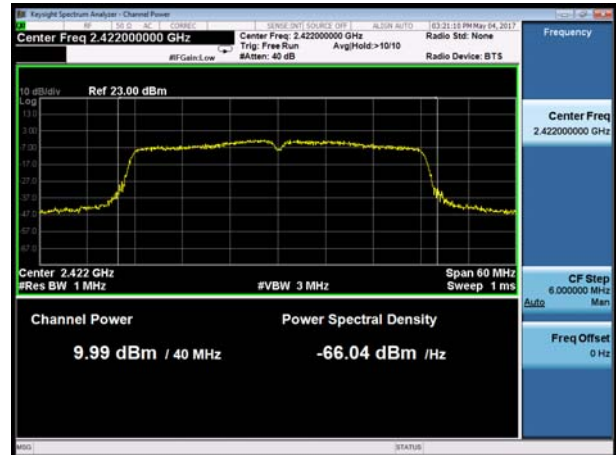

802.11n(HT20), Carrier frequency (MHz): 2437



802.11n(HT40), Carrier frequency (MHz): 2437

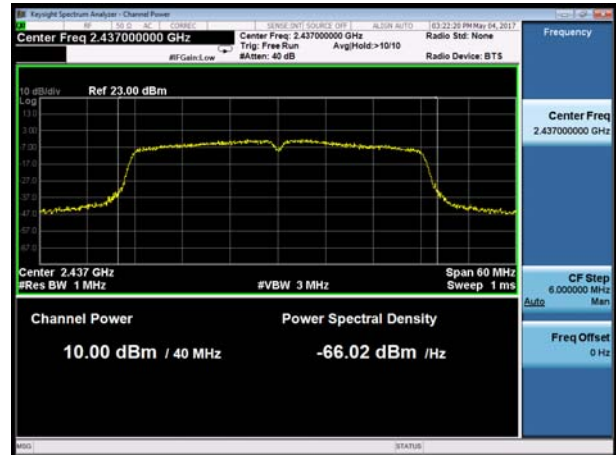

802.11n(HT20), Carrier frequency (MHz):2462



802.11n(HT40), Carrier frequency (MHz):2452



Antenna 2

802.11n(HT20), Carrier frequency (MHz): 2412



802.11n(HT40), Carrier frequency (MHz): 2422



802.11n(HT20), Carrier frequency (MHz): 2437

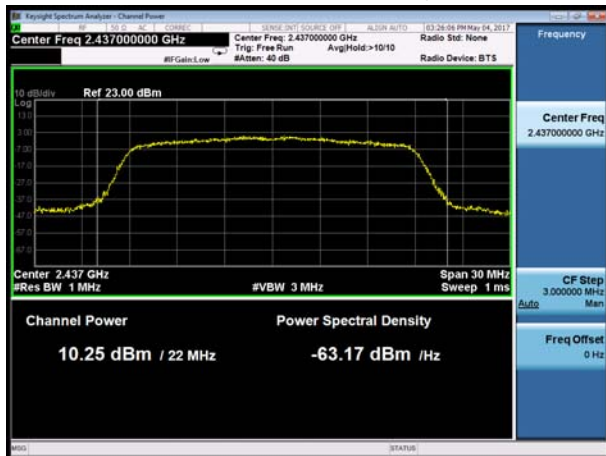

802.11n(HT40), Carrier frequency (MHz): 2437

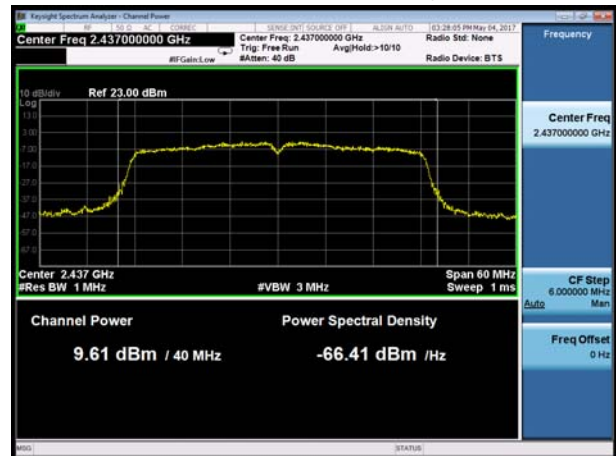

802.11n(HT20), Carrier frequency (MHz):2462

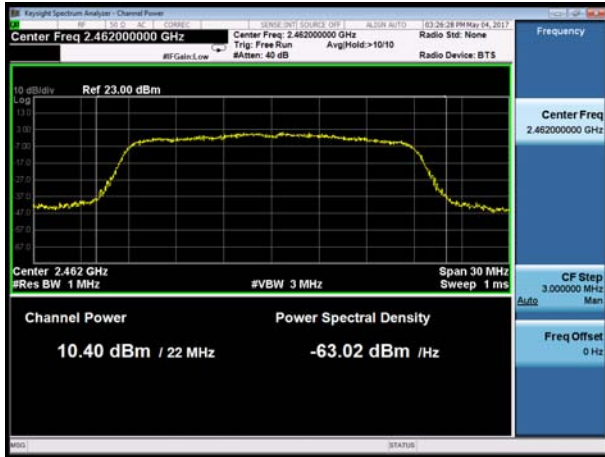

802.11n(HT40), Carrier frequency (MHz):2452



5.2. 6dB Bandwidth

Ambient condition

Temperature	Relative humidity	Pressure
23°C ~25°C	45%~50%	101.5kPa

Method of Measurement

The EUT was connected to the spectrum analyzer through an external attenuator (20dB) and a known loss cable. RBW is set to 100 kHz; VBW is set to 300 kHz on spectrum analyzer.

Test Setup

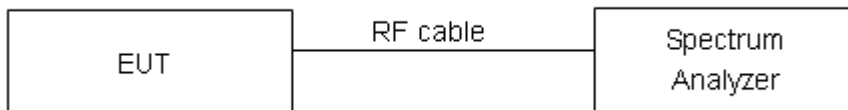

Limits

Rule Part 15.247 (a) (2) specifies that “Systems using digital modulation techniques may operate in the 902–928 MHz, 2400–2483.5 MHz bands. The minimum 6 dB bandwidth shall be at least 500 kHz.”

minimum 6 dB bandwidth	≥ 500 kHz
------------------------	-----------

Measurement Uncertainty

The assessed measurement uncertainty to ensure 95% confidence level for the normal distribution is with the coverage factor $k = 2$, $U = 936$ Hz.

**Test Results:****SISO****Antenna 1**

Network Standards	Carrier frequency (MHz)	Minimum 6 dB bandwidth (MHz)	99% bandwidth (MHz)	Limit(kHz)	Conclusion
802.11b	2412	9.078	14.181	500	PASS
	2437	9.076	14.185	500	PASS
	2462	9.510	14.242	500	PASS
802.11g	2412	16.310	16.362	500	PASS
	2437	16.320	16.349	500	PASS
	2462	16.070	16.374	500	PASS
802.11n HT20	2412	17.550	17.520	500	PASS
	2437	17.540	17.519	500	PASS
	2462	17.550	17.527	500	PASS
802.11n HT40	2422	35.890	35.795	500	PASS
	2437	35.370	35.725	500	PASS
	2452	35.040	35.764	500	PASS

Antenna 2

Network Standards	Carrier frequency (MHz)	Minimum 6 dB bandwidth (MHz)	99% bandwidth (MHz)	Limit(kHz)	Conclusion
802.11b	2412	9.078	14.181	500	PASS
	2437	9.076	14.185	500	PASS
	2462	9.510	14.242	500	PASS
802.11g	2412	16.310	16.362	500	PASS
	2437	16.320	16.349	500	PASS
	2462	16.070	16.374	500	PASS
802.11n HT20	2412	17.550	17.520	500	PASS
	2437	15.540	17.519	500	PASS
	2462	17.550	17.527	500	PASS
802.11n HT40	2422	35.890	35.795	500	PASS
	2437	35.370	35.725	500	PASS
	2452	35.040	35.764	500	PASS

**MIMO****Antenna 1**

Network Standards	Carrier frequency (MHz)	Minimum 6 dB bandwidth (MHz)	99% bandwidth (MHz)	Limit(kHz)	Conclusion
802.11n HT20	2412	15.100	17.489	500	PASS
	2437	15.040	17.476	500	PASS
	2462	15.110	17.490	500	PASS
802.11n HT40	2422	35.080	35.704	500	PASS
	2437	35.000	35.674	500	PASS
	2452	33.800	35.697	500	PASS

Antenna 2

Network Standards	Carrier frequency (MHz)	Minimum 6 dB bandwidth (MHz)	99% bandwidth (MHz)	Limit(kHz)	Conclusion
802.11n HT20	2412	15.100	17.489	500	PASS
	2437	15.040	17.476	500	PASS
	2462	15.110	17.490	500	PASS
802.11n HT40	2422	35.080	35.704	500	PASS
	2437	35.000	35.674	500	PASS
	2452	33.800	35.697	500	PASS



Antenna 1

802.11b, Carrier frequency (MHz): 2412



802.11g, Carrier frequency (MHz): 2412



802.11b, Carrier frequency (MHz): 2437



802.11g, Carrier frequency (MHz): 2437

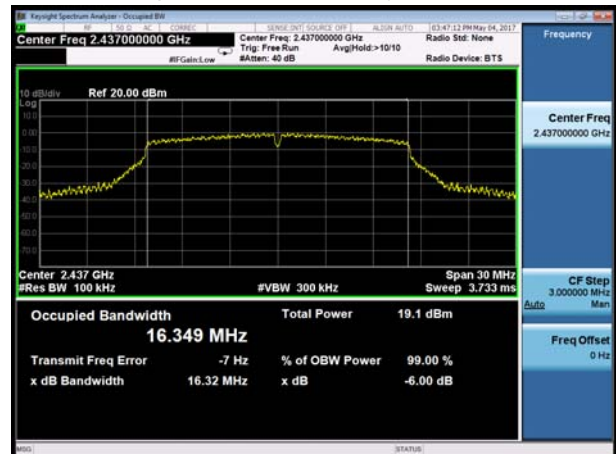

802.11b, Carrier frequency (MHz): 2462



802.11g, Carrier frequency (MHz): 2462





802.11n(HT20), Carrier frequency (MHz): 2412



802.11n(HT40), Carrier frequency (MHz): 2422



802.11n(HT20), Carrier frequency (MHz): 2437



802.11n(HT40), Carrier frequency (MHz): 2437



802.11n(HT20), Carrier frequency (MHz):2462



802.11n(HT40), Carrier frequency (MHz):2452





Antenna 2

802.11b, Carrier frequency (MHz): 2412



802.11g, Carrier frequency (MHz): 2412

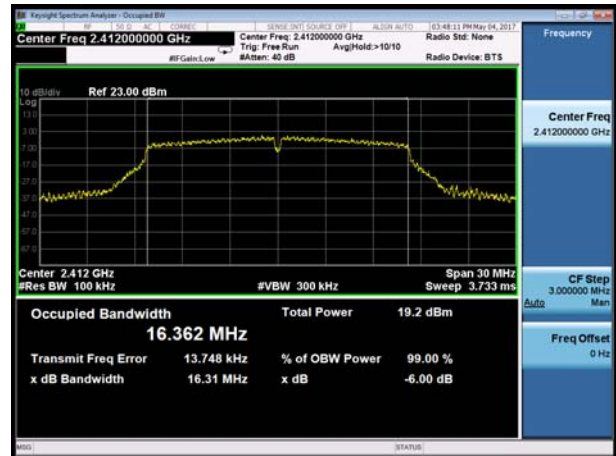

802.11b, Carrier frequency (MHz): 2437



802.11g, Carrier frequency (MHz): 2437



802.11b, Carrier frequency (MHz): 2462



802.11g, Carrier frequency (MHz): 2462



802.11n(HT20), Carrier frequency (MHz): 2412



802.11n(HT40), Carrier frequency (MHz): 2422



802.11n(HT20), Carrier frequency (MHz): 2437



802.11n(HT40), Carrier frequency (MHz): 2437



802.11n(HT20), Carrier frequency (MHz): 2462



802.11n(HT40), Carrier frequency (MHz): 2452





MIMO

Antenna 1

802.11n(HT20), Carrier frequency (MHz): 2412



802.11n(HT40), Carrier frequency (MHz): 2422



802.11n(HT20), Carrier frequency (MHz): 2437



802.11n(HT40), Carrier frequency (MHz): 2437



802.11n(HT20), Carrier frequency (MHz):2462



802.11n(HT40), Carrier frequency (MHz):2452

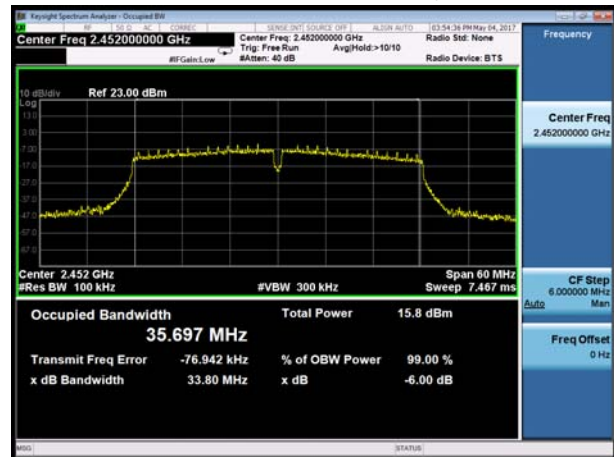

Antenna 2

802.11n(HT20), Carrier frequency (MHz): 2412

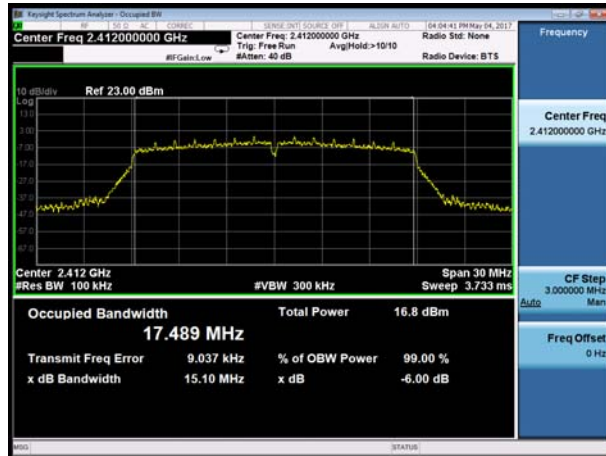

802.11n(HT40), Carrier frequency (MHz): 2422



802.11n(HT20), Carrier frequency (MHz): 2437



802.11n(HT40), Carrier frequency (MHz): 2437

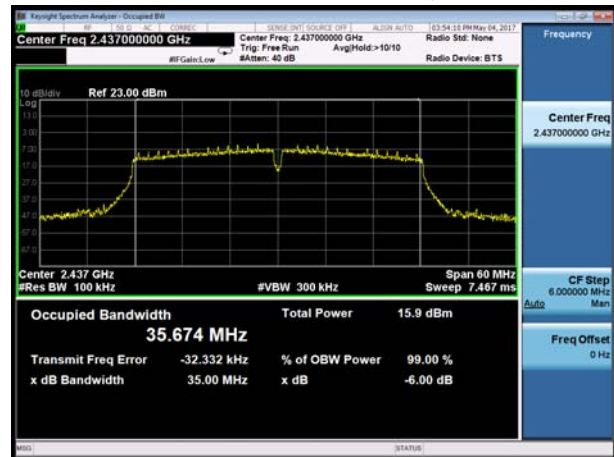

802.11n(HT20), Carrier frequency (MHz):2462



802.11n(HT40), Carrier frequency (MHz):2452



5.3. Band Edge

Ambient condition

Temperature	Relative humidity	Pressure
23°C ~25°C	45%~50%	101.5kPa

Method of Measurement

The EUT was connected to the spectrum analyzer through an external attenuator (20dB) and a known loss cable the band edge of the lowest and highest channels were measured. The peak detector is used and RBW is set to 100 kHz and VBW is set to 300 kHz on spectrum analyzer. Spectrum analyzer plots are included on the following pages.

Test Setup

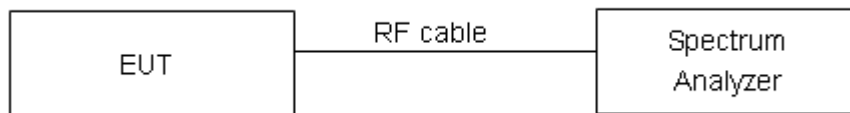

Limits

Rule Part 15.247(d) specifies that “In any 100 kHz bandwidth outside the frequency band in which the spread spectrum or digitally modulated intentional radiator is operating, the radio frequency power that is produced by the intentional radiator shall be at least 20 dB below that in the 100 kHz bandwidth within the band that contains the highest level of the desired power, based on either an RF conducted or a radiated measurement, provided the transmitter demonstrates compliance with the peak conducted power limits.”

Measurement Uncertainty

The assessed measurement uncertainty to ensure 95% confidence level for the normal distribution is with the coverage factor $k = 1.96$.

Frequency	Uncertainty
2GHz-3GHz	1.407 dB



Test Results:

SISO

Antenna 1

802.11b, Channel No.: 1

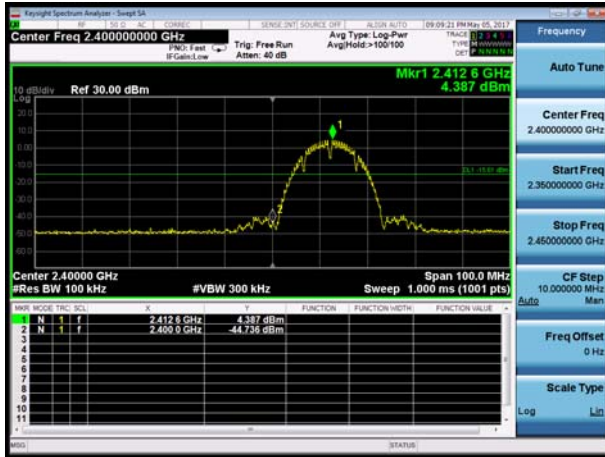

802.11b, Channel No.: 11

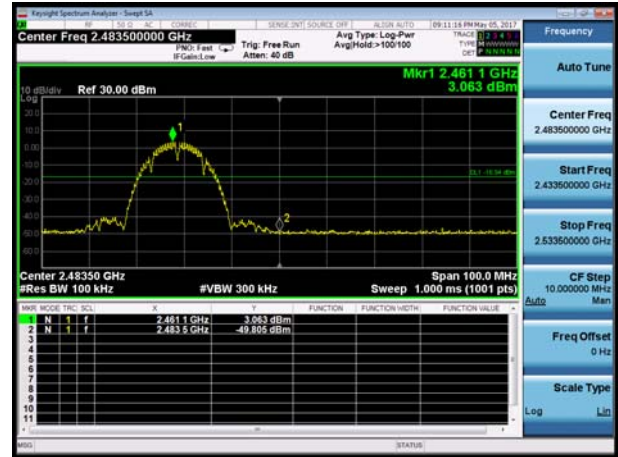

802.11g, Channel No.: 1

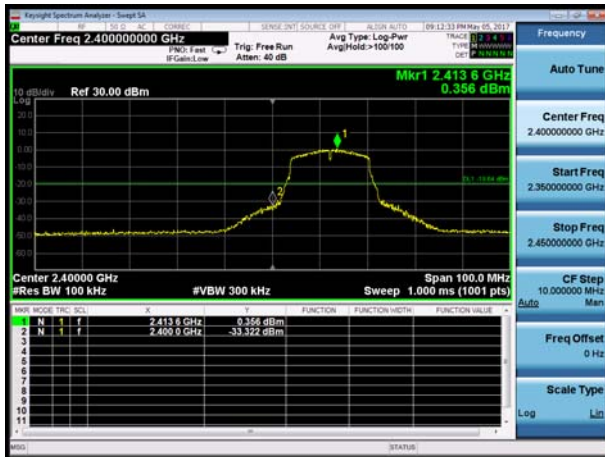

802.11g, Channel No.: 11

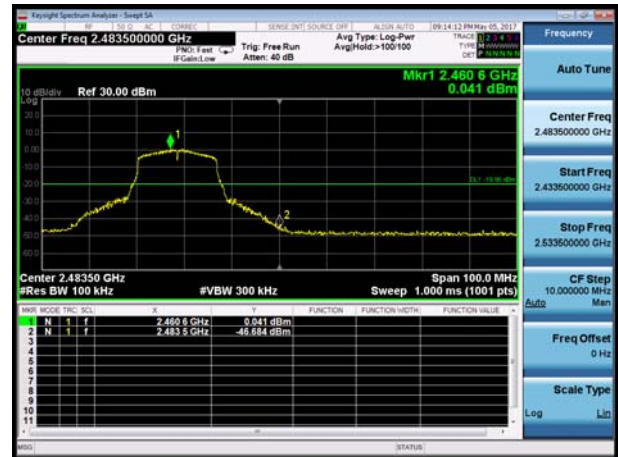

802.11n(HT20), Channel No.: 1

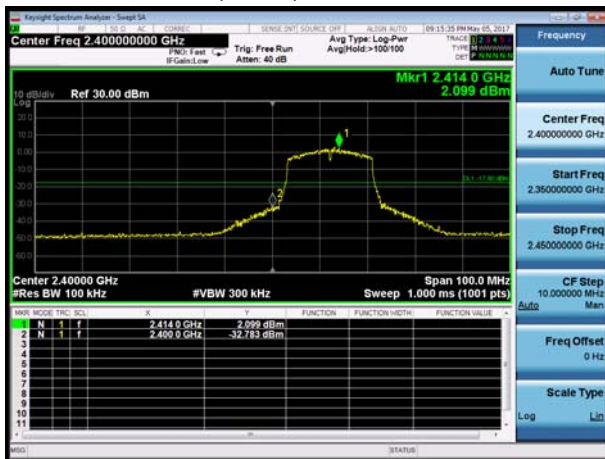

802.11n(HT20), Channel No.: 11

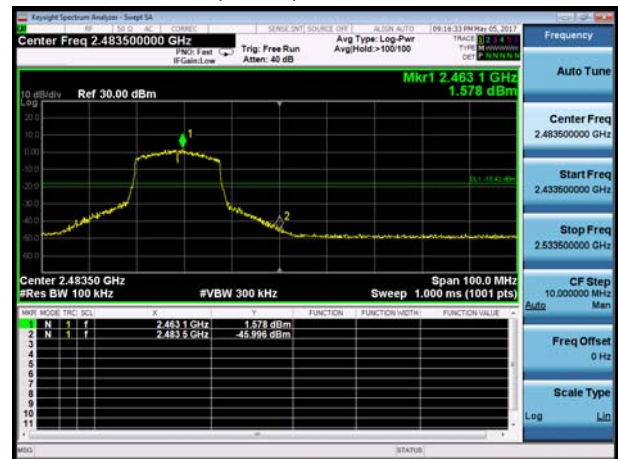



802.11n(HT40), Channel No.: 3



802.11n(HT40), Channel No.: 9



Antenna 2

802.11b, Channel No.: 1

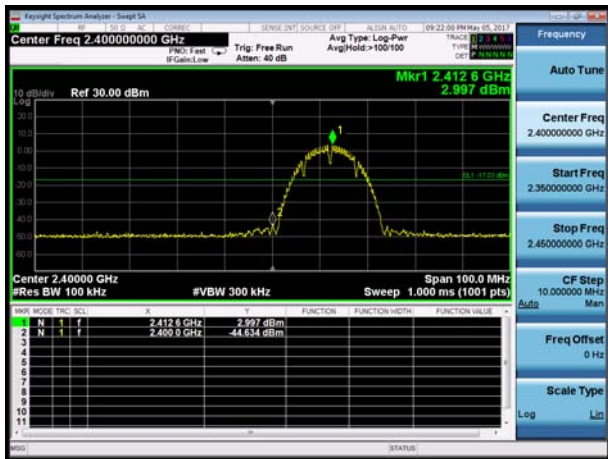

802.11b, Channel No.: 11

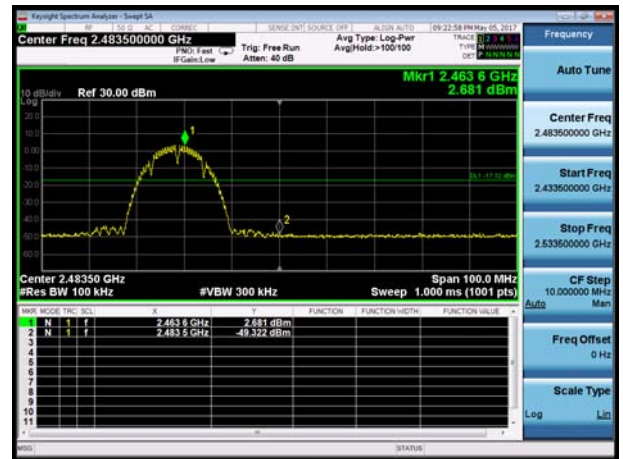

802.11g, Channel No.: 1

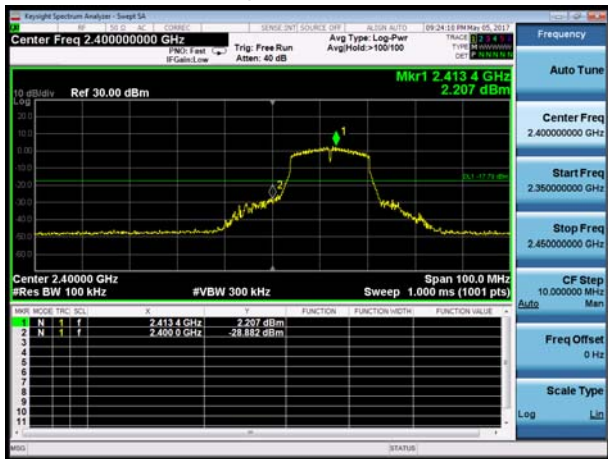

802.11g, Channel No.: 11

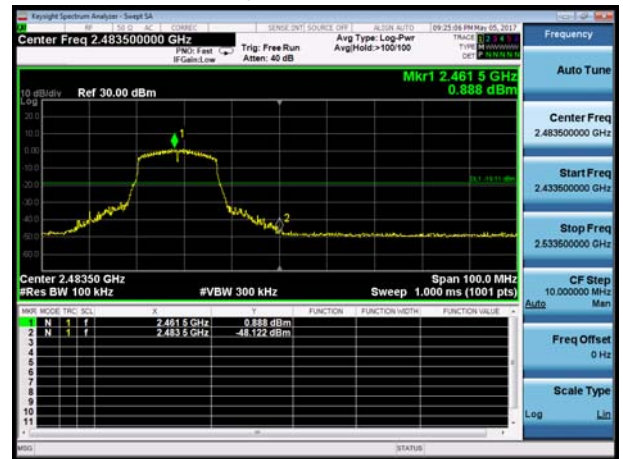

802.11n(HT20), Channel No.: 1

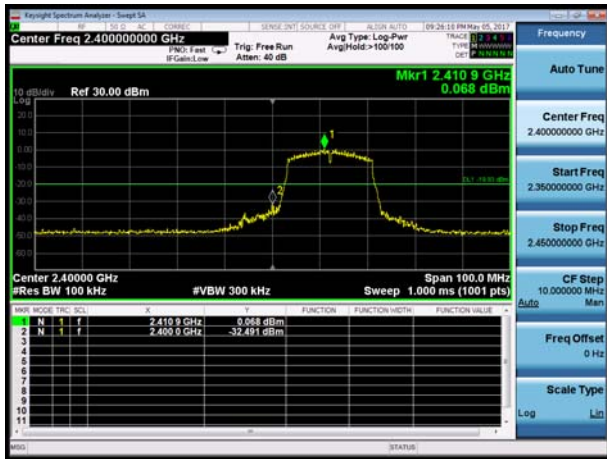

802.11n(HT20), Channel No.: 11

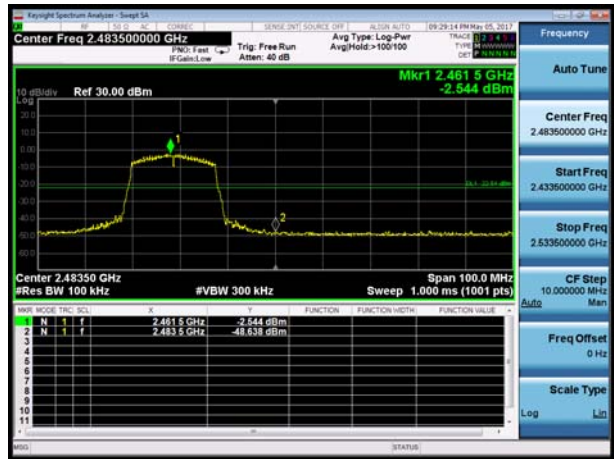

802.11n(HT40), Channel No.: 3



802.11n(HT40), Channel No.: 9



MIMO
Antenna 1

802.11n(HT20), Channel No.: 1

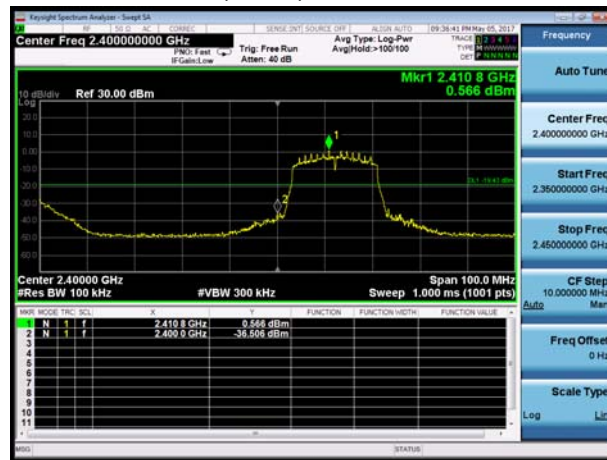

802.11n(HT20), Channel No.: 11

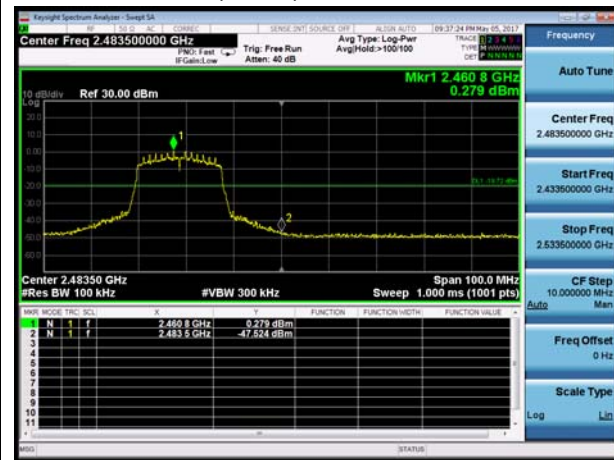



802.11n(HT40), Channel No.: 3

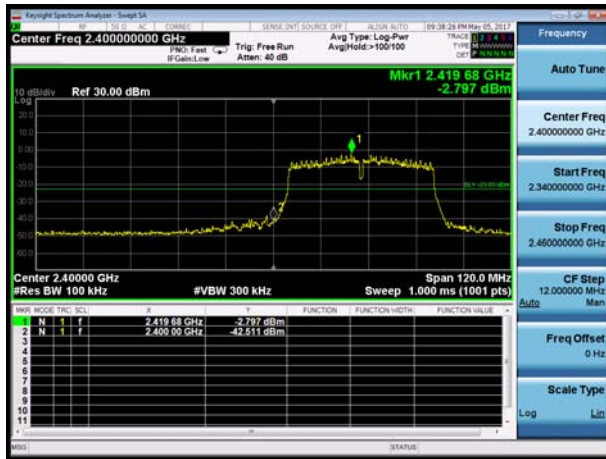

802.11n(HT40), Channel No.: 9



Antenna 2

802.11n(HT20), Channel No.: 1

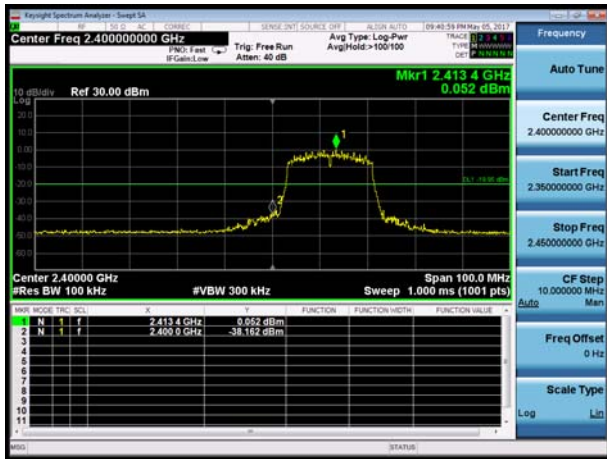

802.11n(HT20), Channel No.: 11



802.11n(HT40), Channel No.: 3

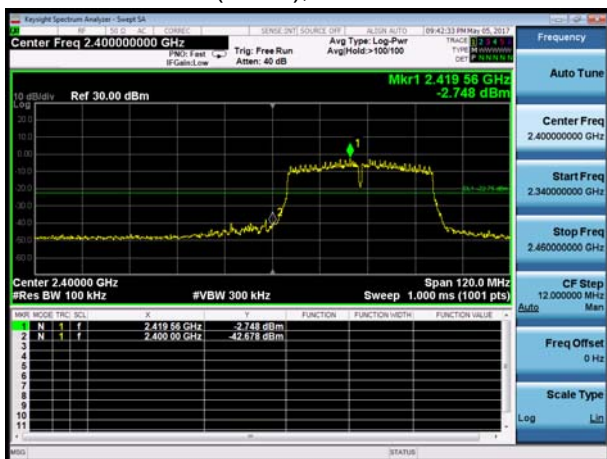

802.11n(HT40), Channel No.: 9



5.4. Power Spectral Density

Ambient condition

Temperature	Relative humidity	Pressure
23°C ~25°C	45%~50%	101.5kPa

Method of Measurement

The EUT was connected to the spectrum analyzer through an external attenuator (20dB) and a known loss cable.

RBW is set to 3 kHz and VBW is set to 10 kHz for BLE/ Wi-Fi 2.4G on spectrum analyzer.

Set the span to 1.5 times the DTS channel bandwidth. Sweep time = auto couple. Trace mode = max hold. The Average power spectral density is recorded.

The conducted Power is measured at each antenna port. The measured results at the various antenna ports are then summed mathematically.

Test setup

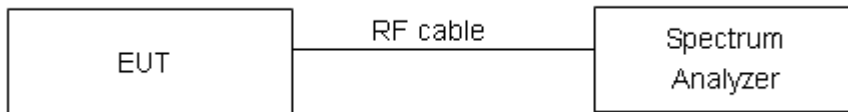

Limits

Rule Part 15.247(e) specifies that” For digitally modulated systems, the power spectral density conducted from the intentional radiator to the antenna shall not be greater than 8 dBm in any 3 kHz band during any time interval of continuous transmission. ”

Limits	≤ 8 dBm / 3kHz
--------	----------------

Measurement Uncertainty

The assessed measurement uncertainty to ensure 95% confidence level for the normal distribution is with the coverage factor $k = 2$, $U = 0.75\text{dB}$.

**Test Results:****SISO****Antenna 1**

Network Standards	Channel Number	Power Spectral Density (dBm / 3kHz)	Limit (dBm / 3kHz)	Conclusion
802.11b	1	-19.245	8	PASS
	6	-19.568	8	PASS
	11	-20.901	8	PASS
802.11g	1	-20.884	8	PASS
	6	-20.517	8	PASS
	11	-21.248	8	PASS
802.11n HT20	1	-21.040	8	PASS
	6	-21.083	8	PASS
	11	-21.651	8	PASS
802.11n HT40	3	-27.144	8	PASS
	6	-21.132	8	PASS
	9	-21.743	8	PASS

Antenna 2

Network Standards	Channel Number	Power Spectral Density (dBm / 3kHz)	Limit (dBm / 3kHz)	Conclusion
802.11b	1	-20.707	8	PASS
	6	-18.892	8	PASS
	11	-19.992	8	PASS
802.11g	1	-21.233	8	PASS
	6	-21.268	8	PASS
	11	-20.485	8	PASS
802.11n HT20	1	-19.747	8	PASS
	6	-21.529	8	PASS
	11	-25.336	8	PASS
802.11n HT40	3	-20.419	8	PASS
	6	-20.221	8	PASS
	9	-20.766	8	PASS

**MIMO**

Network Standards	Channel Number	Power Spectral Density (dBm / 3kHz)			Limit (dBm / 3kHz)	Conclusion
		Ant 1	Ant 2	MIMO		
802.11n HT20	1	-23.414	-23.101	-20.244	8	PASS
	6	-23.684	-22.968	-20.301	8	PASS
	11	-23.661	-23.085	-20.353	8	PASS
802.11n HT40	3	-26.785	-27.518	-24.126	8	PASS
	6	-26.679	-27.437	-24.031	8	PASS
	9	-26.867	-27.244	-24.041	8	PASS



SISO

Antenna 1

802.11b, Channel No.: 1



802.11g, Channel No.: 1



802.11b, Channel No.: 6



802.11g, Channel No.: 6



802.11b, Channel No.: 11



802.11g, Channel No.: 11





802.11n(HT20), Channel No. 1



802.11n(HT40), Channel No. 3



802.11n(HT20), Channel No. 6



802.11n(HT40), Channel No. 6

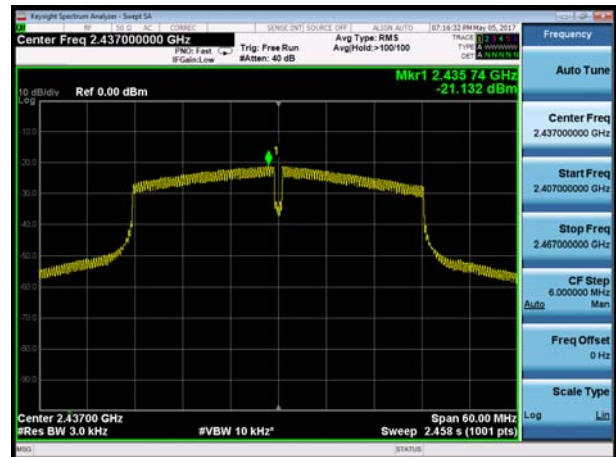

802.11n(HT20), Channel No. 11



802.11n(HT40), Channel No. 9

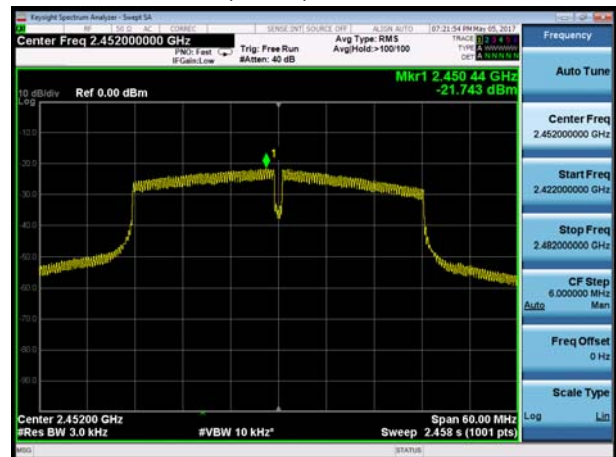



Antenna 2

802.11b, Channel No.: 1



802.11g, Channel No.: 1

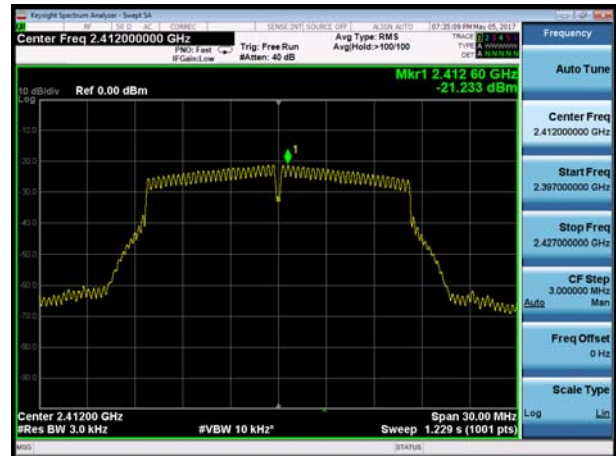

802.11b, Channel No.: 6



802.11g, Channel No.: 6



802.11b, Channel No.: 11



802.11g, Channel No.: 11





802.11n(HT20), Channel No. 1



802.11n(HT40), Channel No. 3

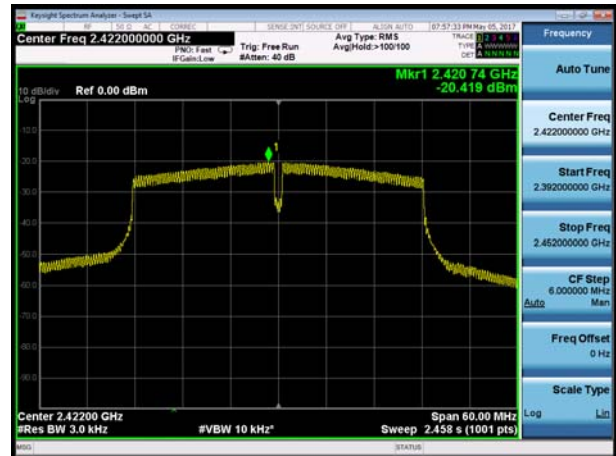

802.11n(HT20), Channel No. 6



802.11n(HT40), Channel No. 6

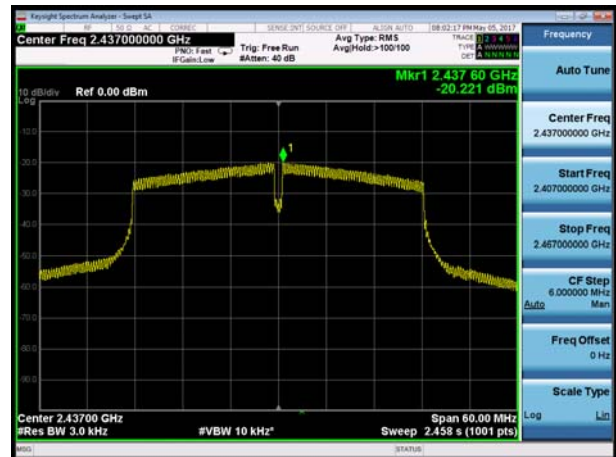

802.11n(HT20), Channel No. 11



802.11n(HT40), Channel No. 9





MIMO

Antenna 1

802.11n(HT20), Channel No. 1



802.11n(HT40), Channel No. 3



802.11n(HT20), Channel No. 6

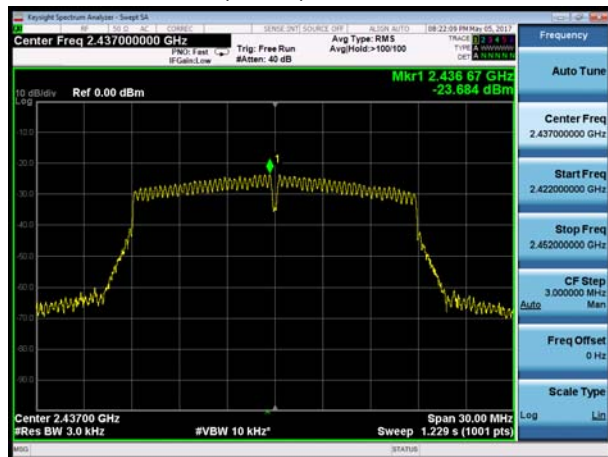

802.11n(HT40), Channel No. 6



802.11n(HT20), Channel No. 11

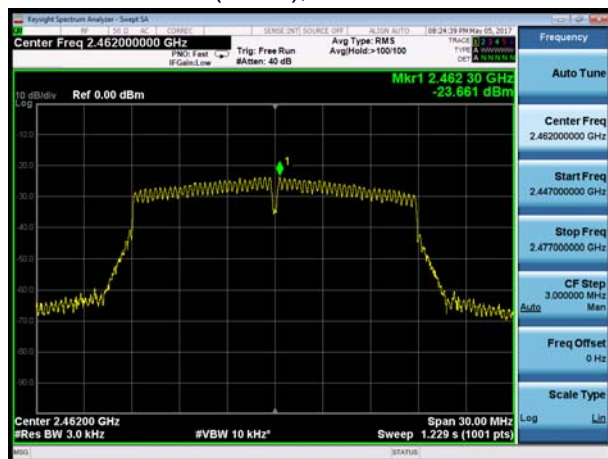

802.11n(HT40), Channel No. 9





Antenna 2

802.11n(HT20), Channel No. 1



802.11n(HT40), Channel No. 3



802.11n(HT20), Channel No. 6



802.11n(HT40), Channel No. 6



802.11n(HT20), Channel No. 11



802.11n(HT40), Channel No. 9



5.5. Spurious RF Conducted Emissions

Ambient condition

Temperature	Relative humidity	Pressure
23°C ~25°C	45%~50%	101.5kPa

Method of Measurement

The EUT was connected to the spectrum analyzer with a known loss. The spectrum analyzer scans from 30MHz to the 10th harmonic of the carrier. The peak detector is used. RBW and VBW are set to 100 kHz, Sweep is set to ATUO.

The test is in transmitting mode.

Test setup



Limits

Rule Part 15.247(d) pacifies that “In any 100 kHz bandwidth outside the frequency band in which the spread spectrum intentional radiator is operating, the radio frequency power that is produced by the intentional radiator shall be at least 20 dB below that in the 100 kHz bandwidth within the band that contains the highest level of the desired power.”

Network Standards		Carrier frequency (MHz)	Reference value (dBm)	Limit
Antenna 1	802.11b	2412	1.887	-18.113
		2437	2.484	-17.516
		2462	1.790	-18.210
	802.11g	2412	1.694	-18.306
		2437	2.271	-17.729
		2462	1.524	-18.476
	802.11n HT20	2412	-1.407	-21.407
		2437	-0.815	-20.815
		2462	-1.375	-21.375
802.11n HT40	2422	-4.558	-24.558	
	2437	-3.829	-23.829	
	2452	-3.723	-23.723	
Antenna 2	802.11b	2412	1.975	-18.025
		2437	2.524	-17.476
		2462	3.102	-16.898
	802.11g	2412	1.983	-18.017



		2437	2.861	-17.139
		2462	1.685	-18.315
		2412	-0.912	-20.912
	802.11n HT20	2437	-0.283	-20.283
		2462	-0.661	-20.661
		2422	-3.74	-23.740
	802.11n HT40	2437	-3.485	-23.485
		2452	-3.309	-23.309
		2412	-2.582	-22.582
MIMO	802.11n HT20	2437	-3.070	-23.070
		2462	-2.821	-22.821
		2422	-5.110	-25.110
	802.11n HT40	2437	-4.602	-24.602
		2452	-4.771	-24.771

Measurement Uncertainty

The assessed measurement uncertainty to ensure 95% confidence level for the normal distribution is with the coverage factor $k = 1.96$.

Frequency	Uncertainty
100kHz-2GHz	0.684 dB
2GHz-26GHz	1.407 dB

Test Results:

If disturbances were found more than 20dB below limit line, the mark is not required for the EUT.
The signal beyond the limit is carrier.

SISO

Antenna 1

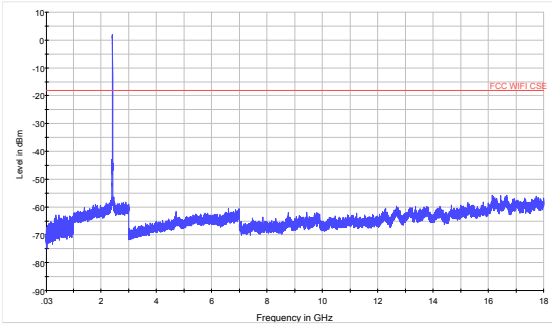

802.11b CH1 30MHz to 18GHz

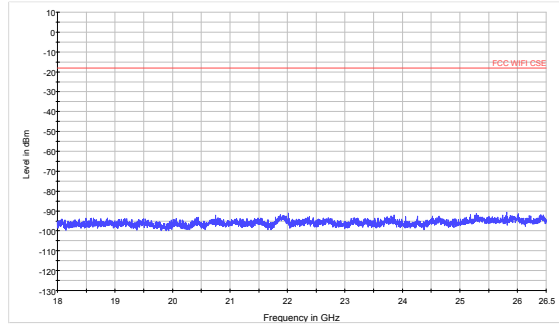

802.11b CH1 18GHz to 26.5GHz

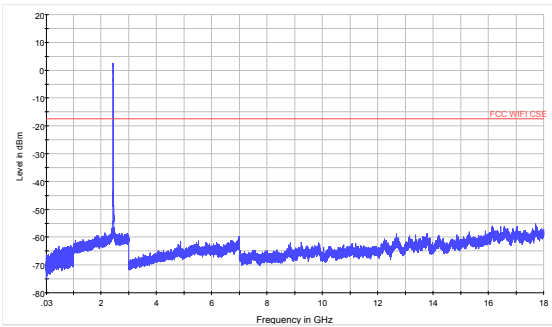

802.11b CH6 30MHz to 18GHz

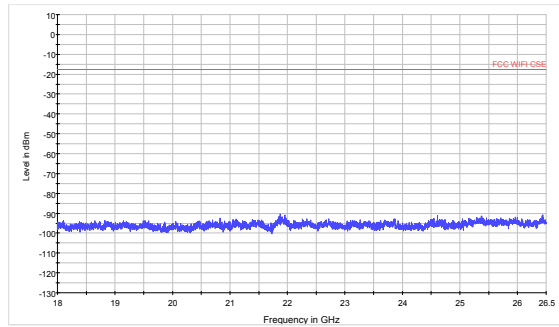

802.11b CH6 18GHz to 26.5GHz

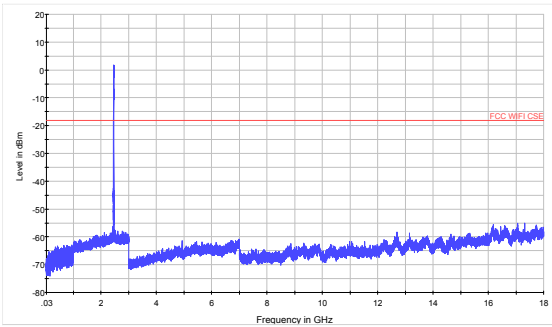

802.11b CH11 30MHz to 18GHz

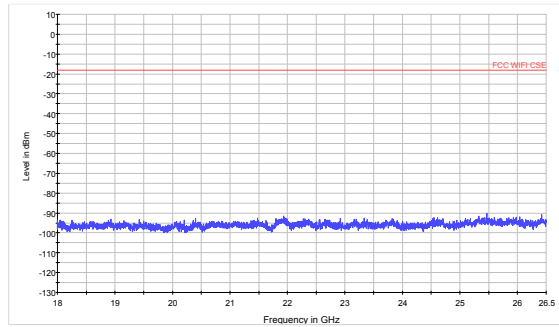

802.11b CH11 18GHz to 26.5GHz

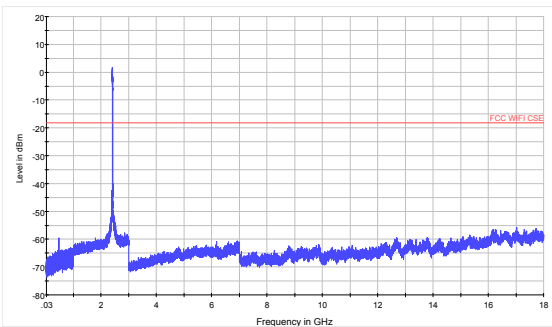

802.11g CH1 30MHz to 18GHz

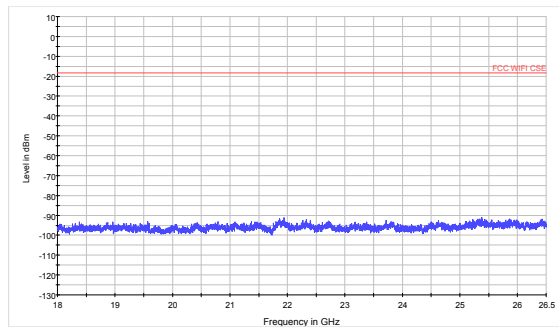

802.11g CH1 18GHz to 26.5GHz

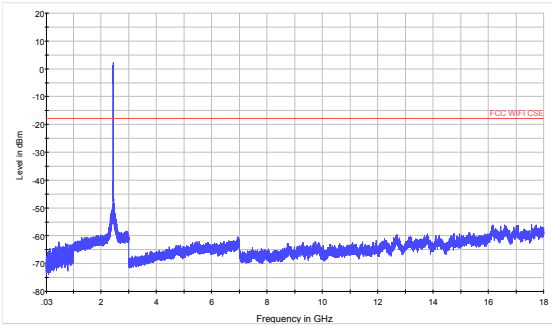

802.11g CH6 30MHz to 18GHz

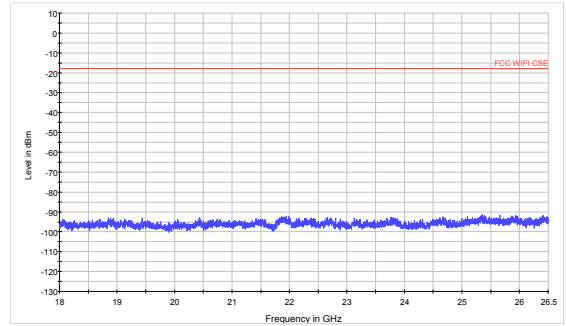

802.11g CH6 18GHz to 26.5GHz

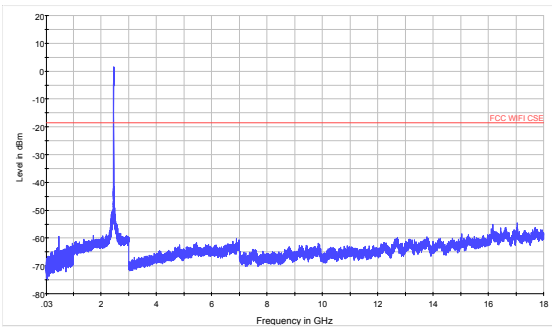

802.11g CH11 30MHz to 18GHz

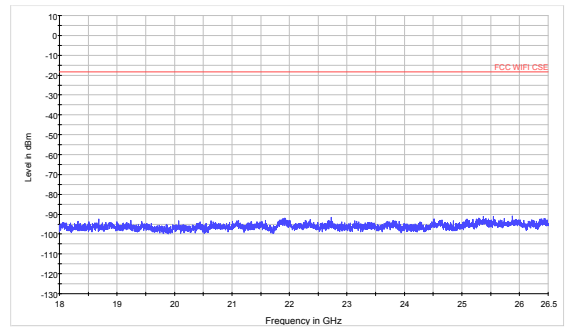

802.11g CH11 18GHz to 26.5GHz

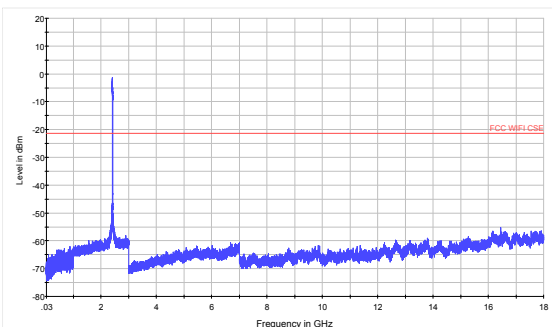

802.11n (HT20) CH1 30MHz to 18GHz

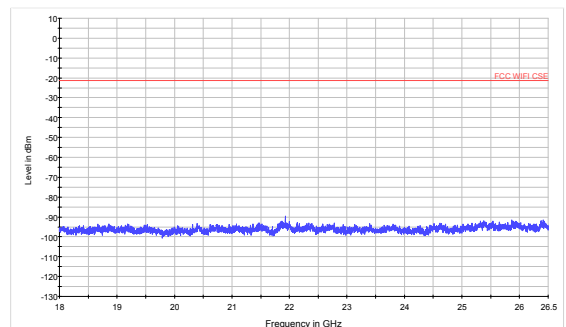

802.11n (HT20) CH1 18GHz to 26.5GHz

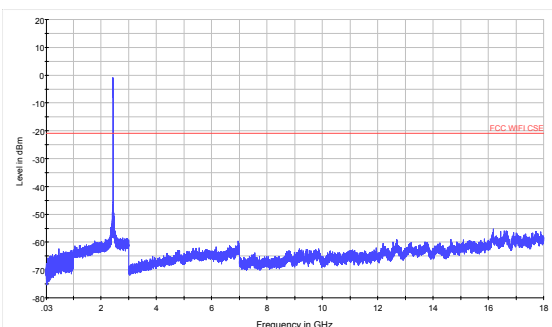

802.11n (HT20) CH6 30MHz to 18GHz

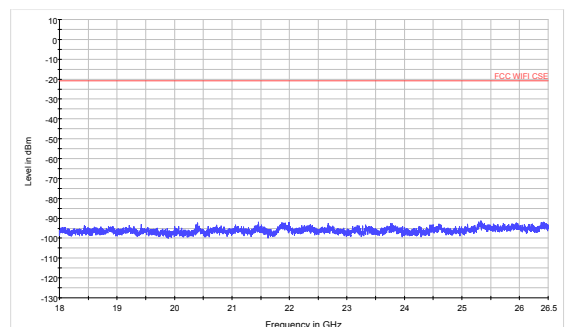

802.11n (HT20) CH6 18GHz to 26.5GHz

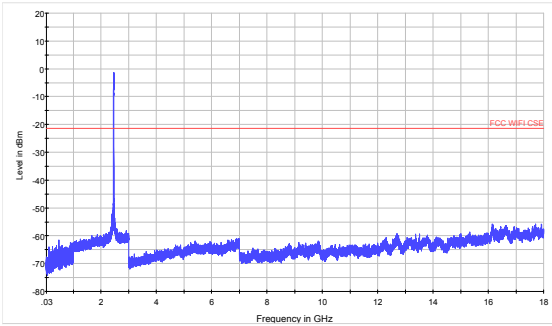

802.11n (HT20) CH11 30MHz to 18GHz

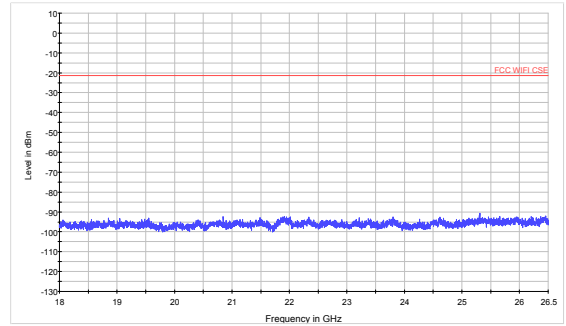

802.11n (HT20) CH11 18GHz to 26.5GHz

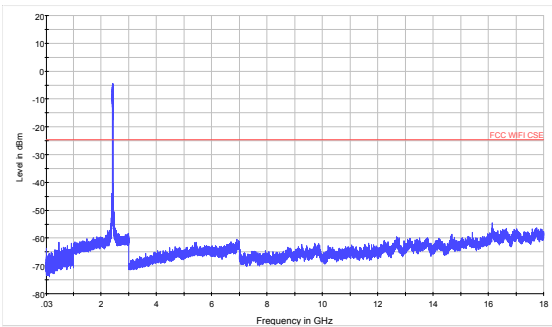

802.11n (HT40) CH3 30MHz to 18GHz

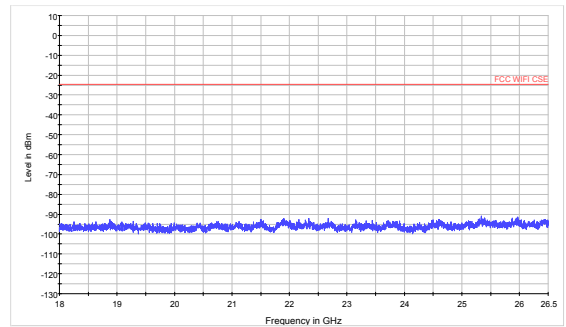

802.11n (HT40) CH3 18GHz to 26.5GHz

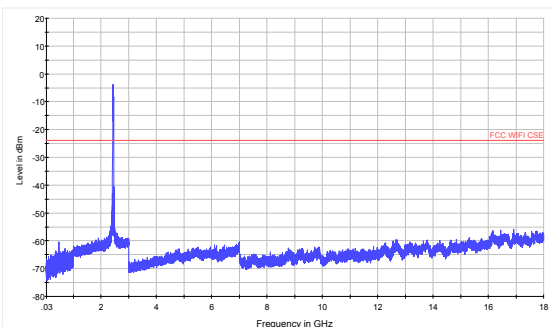

802.11n (HT40) CH6 30MHz to 18GHz

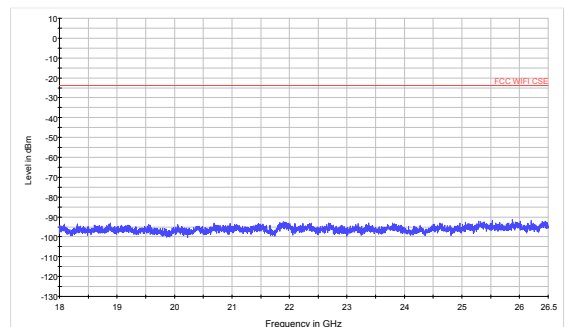

802.11n (HT40) CH6 18GHz to 26.5GHz

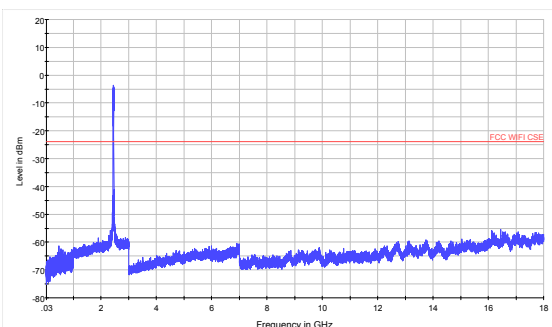

802.11n (HT40) CH9 30MHz to 18GHz

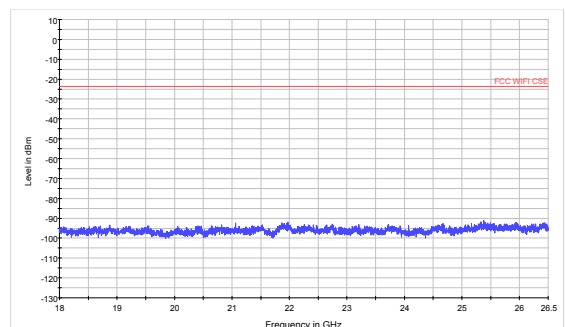

802.11n (HT40) CH9 18GHz to 26.5GHz



Antenna 2

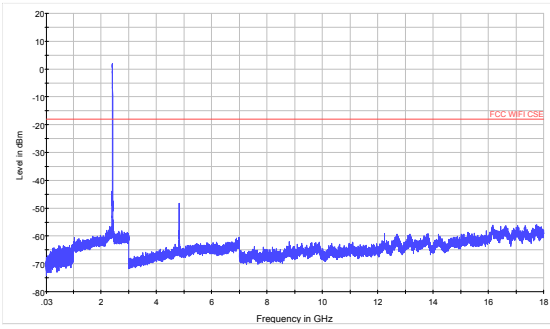

802.11b CH1 30MHz to 18GHz

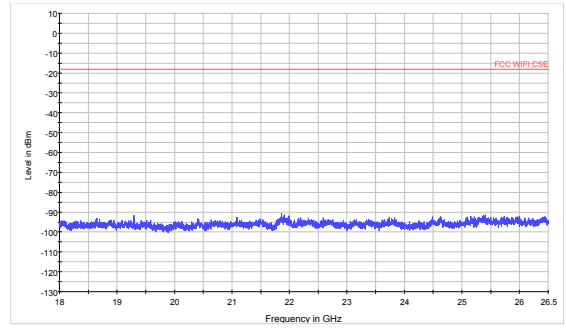

802.11b CH1 18GHz to 26.5GHz

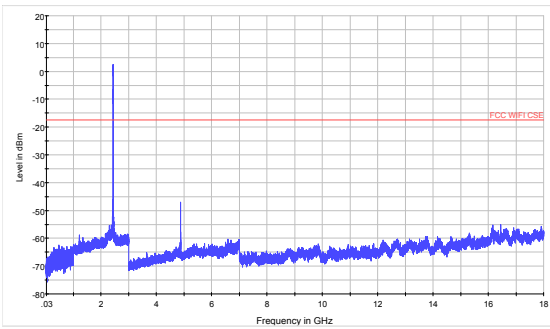

802.11b CH6 30MHz to 18GHz

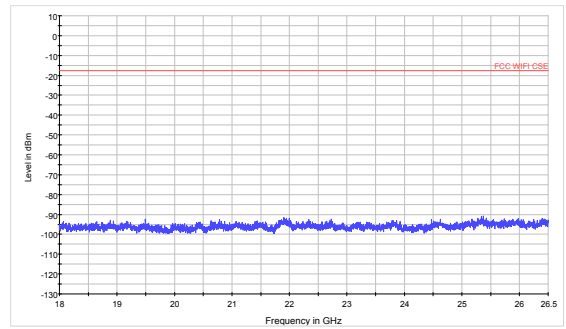

802.11b CH6 18GHz to 26.5GHz

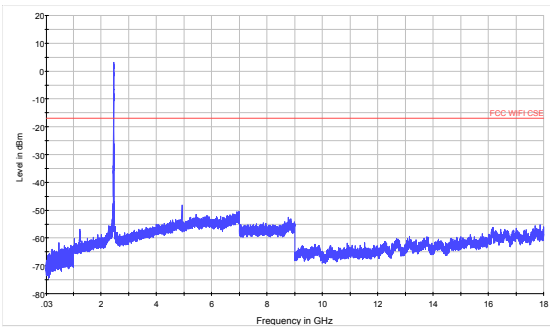

802.11b CH11 30MHz to 18GHz

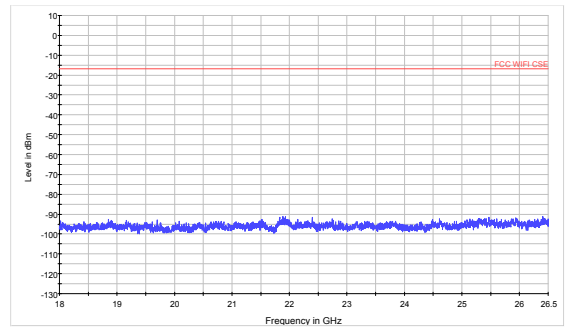

802.11b CH11 18GHz to 26.5GHz

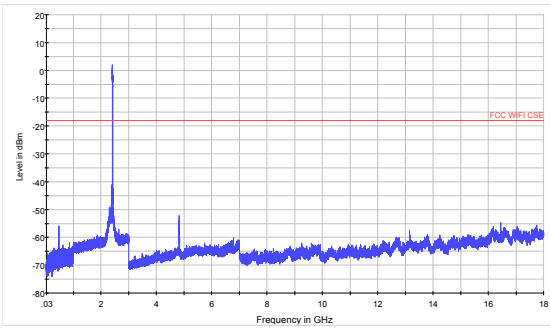

802.11g CH1 30MHz to 18GHz

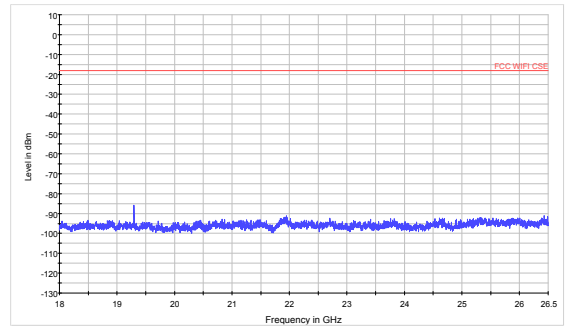

802.11g CH1 18GHz to 26.5GHz

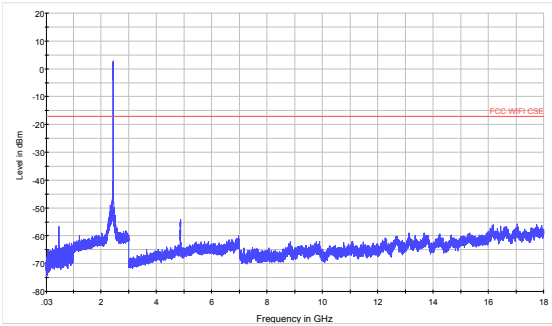

802.11g CH6 30MHz to 18GHz

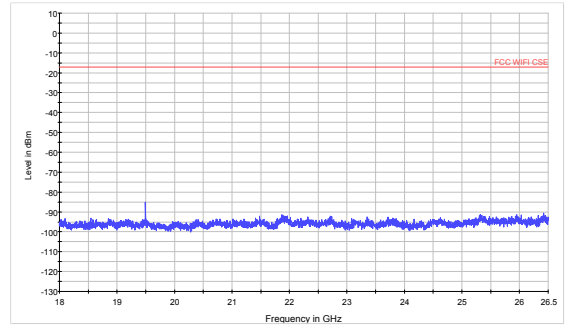

802.11g CH6 18GHz to 26.5GHz

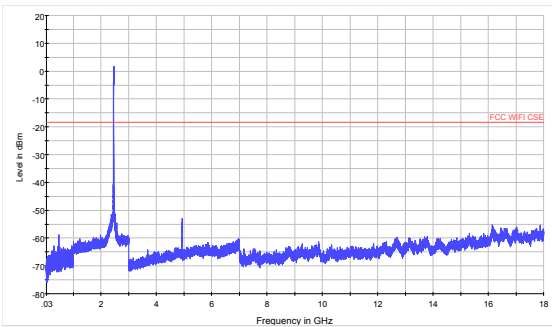

802.11g CH11 30MHz to 18GHz

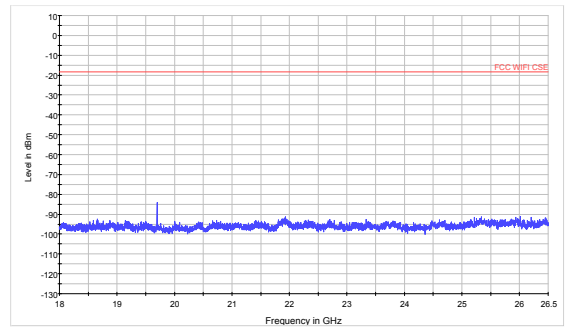

802.11g CH11 18GHz to 26.5GHz

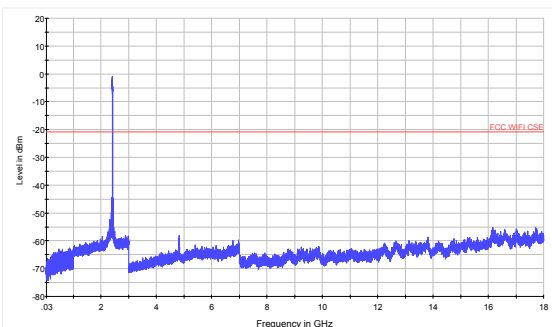

802.11n (HT20) CH1 30MHz to 18GHz

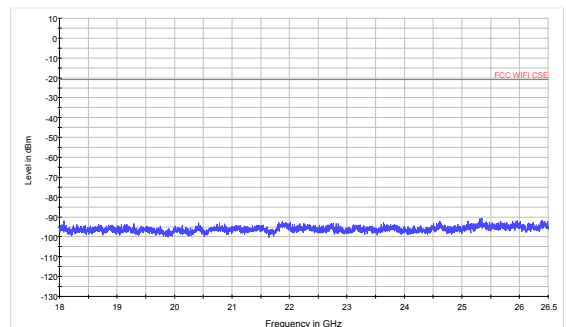

802.11n (HT20) CH1 18GHz to 26.5GHz

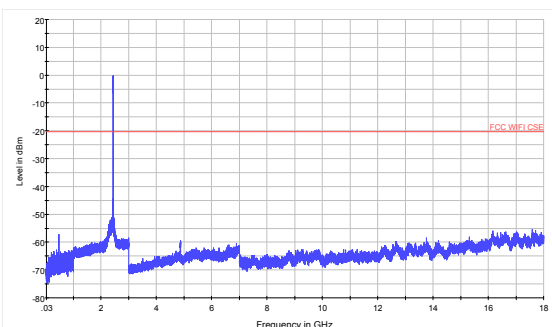

802.11n (HT20) CH6 30MHz to 18GHz

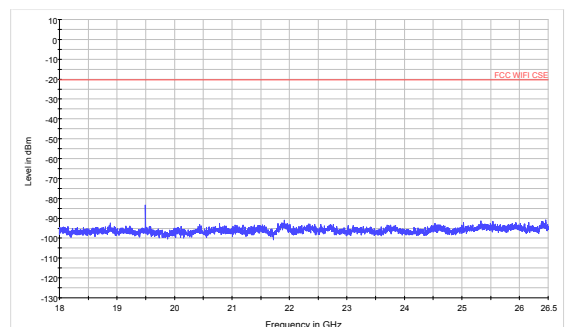

802.11n (HT20) CH6 18GHz to 26.5GHz

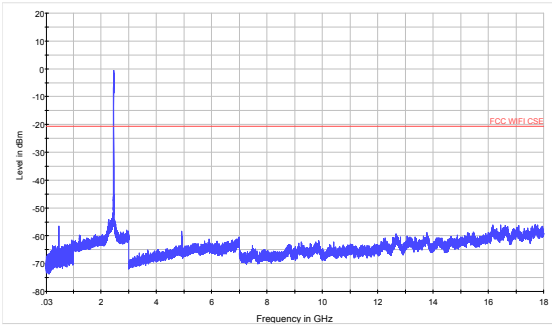

802.11n (HT20) CH11 30MHz to 18GHz

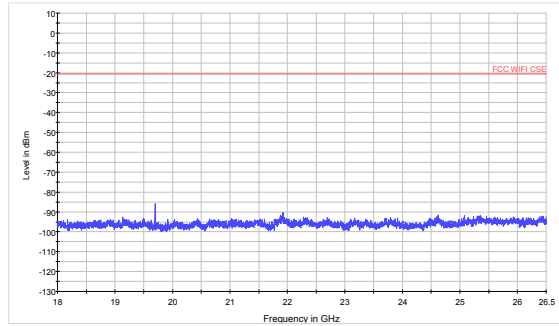

802.11n (HT20) CH11 18GHz to 26.5GHz

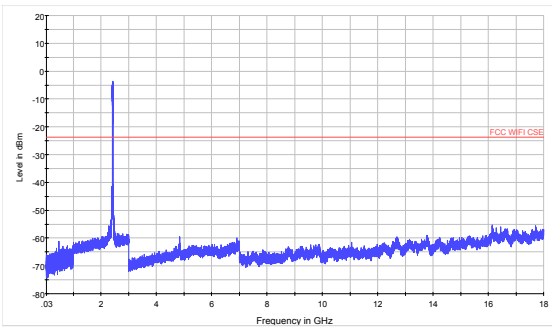

802.11n (HT40) CH3 30MHz to 18GHz

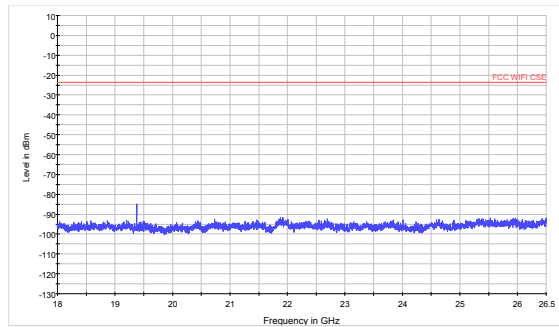

802.11n (HT40) CH3 18GHz to 26.5GHz

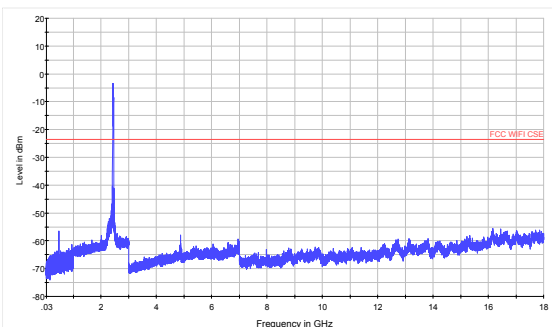

802.11n (HT40) CH6 30MHz to 18GHz

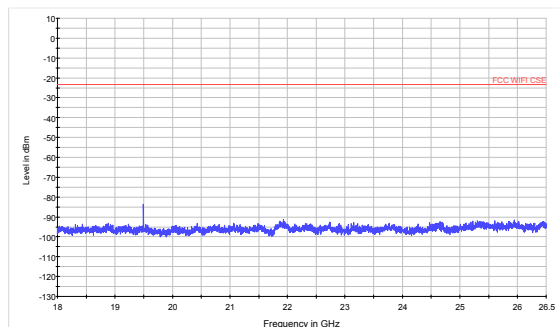

802.11n (HT40) CH6 18GHz to 26.5GHz

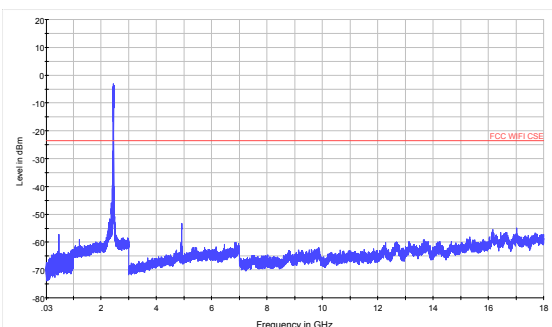

802.11n (HT40) CH9 30MHz to 18GHz

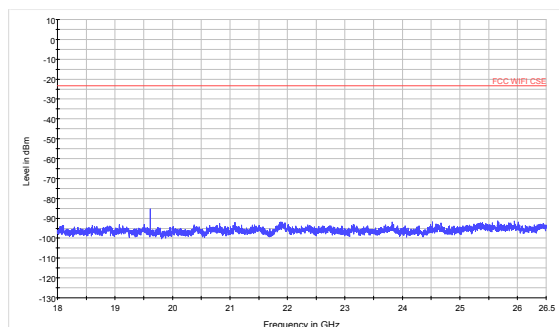

802.11n (HT40) CH9 18GHz to 26.5GHz

MIMO

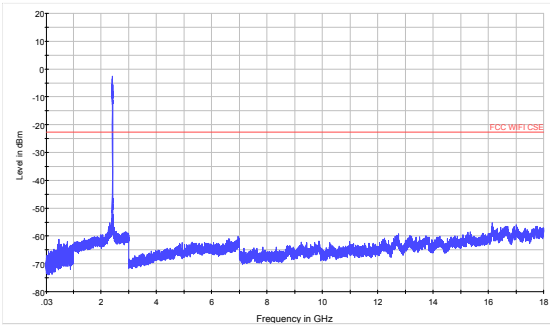

802.11n (HT20) CH1 30MHz to 18GHz

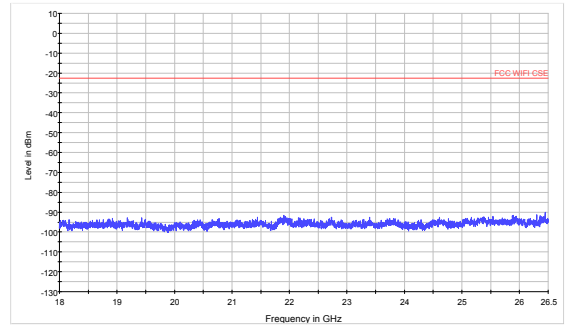

802.11n (HT20) CH1 18GHz to 26.5GHz

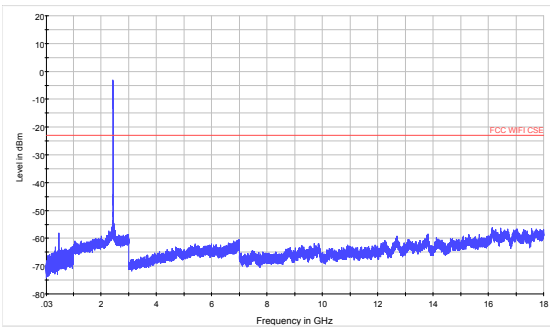

802.11n (HT20) CH6 30MHz to 18GHz

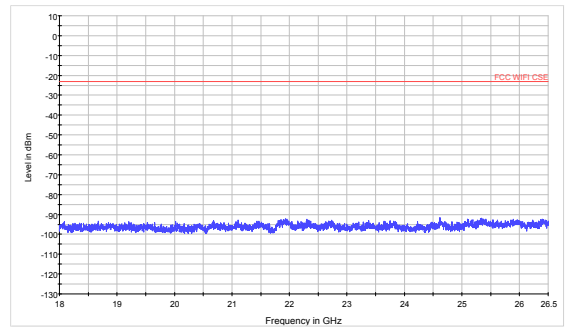

802.11n (HT20) CH6 18GHz to 26.5GHz

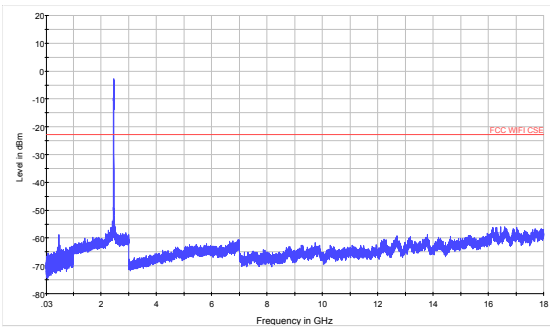

802.11n (HT20) CH11 30MHz to 18GHz

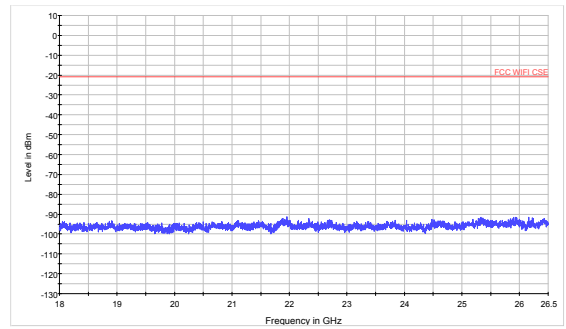

802.11n (HT20) CH11 18GHz to 26.5GHz

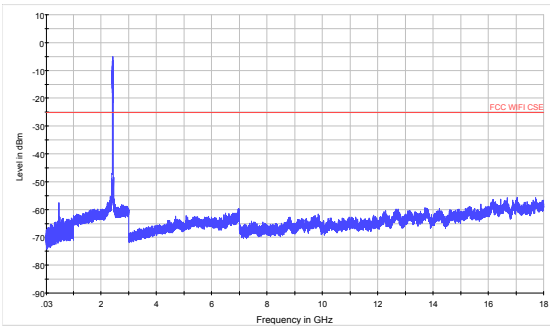

802.11n (HT40) CH3 30MHz to 18GHz

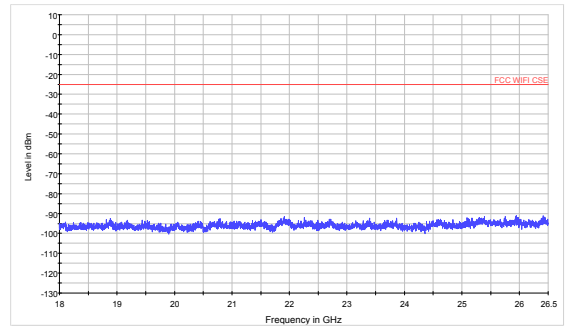

802.11n (HT40) CH3 18GHz to 26.5GHz

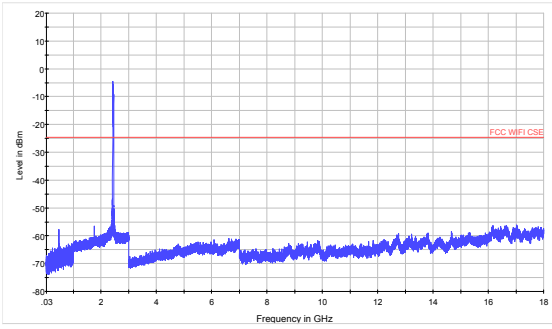

802.11n (HT40) CH6 30MHz to 18GHz

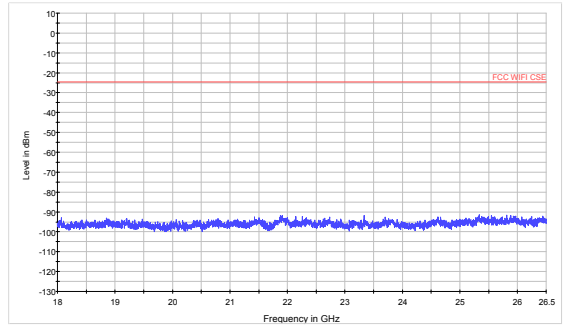

802.11n (HT40) CH6 18GHz to 26.5GHz

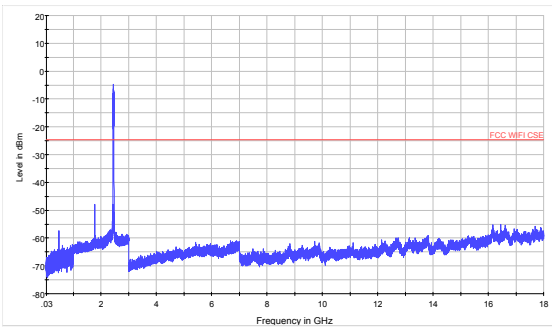

802.11n (HT40) CH9 30MHz to 18GHz

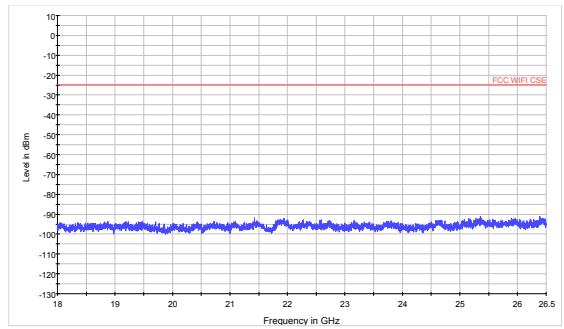

802.11n (HT40) CH9 18GHz to 26.5GHz

5.6. Radiated Emissions in the Restricted Band

Ambient condition

Temperature	Relative humidity	Pressure
23°C ~25°C	45%~50%	101.5kPa

Method of Measurement

The Equipment Under Test (EUT) was set up on a non-conductive table in the semi-anechoic chamber. The test was performed at the distance of 3 m between the EUT and the receiving antenna. The turntable shall be rotated from 0 to 360 degrees for detecting the maximum of radiated spurious signal level. The measurements shall be repeated with orthogonal polarization of the test antenna. RBW is set to 100kHz. The data of cable loss and antenna factor has been calibrated in full testing frequency range before the testing. Sweep the whole frequency band through the range from 9kHz to the 10th harmonic of the carrier, and the emissions less than 20 dB below the permissible value are reported.

Set the spectrum analyzer in the following:

- (a) PEAK: RBW=VBW=1MHz / Sweep=AUTO
- (b) AVERAGE: RBW=1MHz / VBW=1MHz / Sweep=AUTO

This setting method can refer to **KDB 558074**.

The field strength of spurious emission was measured in the following position: EUT stand-up position (Z axis), lie-down position (X, Y axis). The worst emission was found in stand-up position (Y axis) and the antenna is vertical.

The test is in transmitting mode.

Test setup

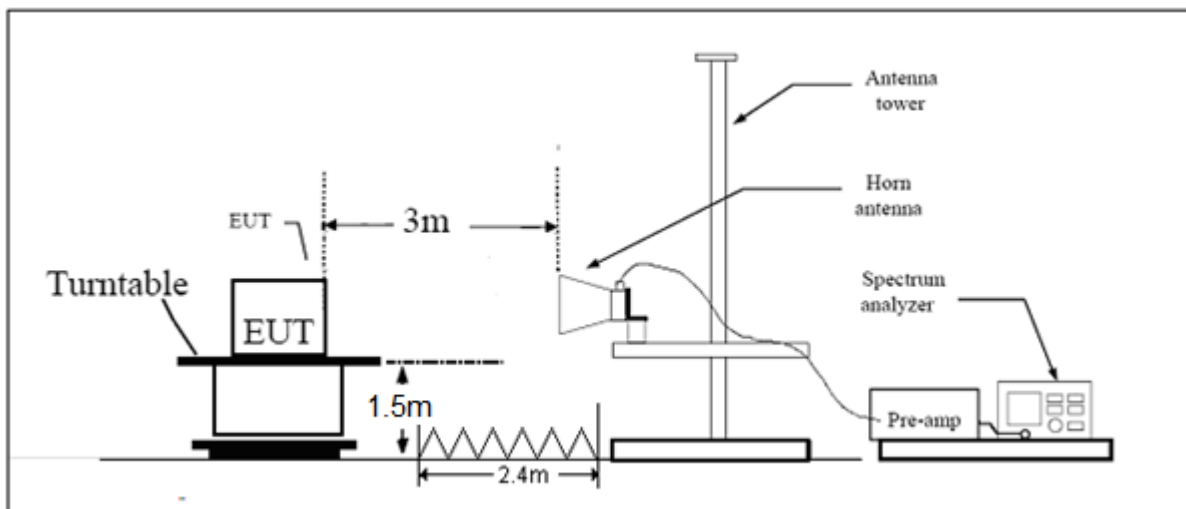

Note: Area side: 2.4mX3.6m

Limits

Spurious Radiated Emissions are permitted in any of the frequency bands listed below:

MHz	MHz	MHz	GHz
0.090 - 0.110	16.42 - 16.423	399.9 - 410	4.5 - 5.15
¹ 0.495 - 0.505	16.69475 - 16.69525	608 - 614	5.35 - 5.46
2.1735 - 2.1905	16.80425 - 16.80475	960 - 1240	7.25 - 7.75
4.125 - 4.128	25.5 - 25.67	1300 - 1427	8.025 - 8.5
4.17725 - 4.17775	37.5 - 38.25	1435 - 1626.5	9.0 - 9.2
4.20725 - 4.20775	73 - 74.6	1645.5 - 1646.5	9.3 - 9.5
6.215 - 6.218	74.8 - 75.2	1660 - 1710	10.6 - 12.7
6.26775 - 6.26825	108 - 121.94	1718.8 - 1722.2	13.25 - 13.4
6.31175 - 6.31225	123 - 138	2200 - 2300	14.47 - 14.5
8.291 - 8.294	149.9 - 150.05	2310 - 2390	15.35 - 16.2
8.362 - 8.366	156.52475 - 156.52525	2483.5 - 2500	17.7 - 21.4
8.37625 - 8.38675	156.7 - 156.9	2690 - 2900	22.01 - 23.12
8.41425 - 8.41475	162.0125 - 167.17	3260 - 3267	23.6 - 24.0
12.29 - 12.293	167.72 - 173.2	3332 - 3339	31.2 - 31.8
12.51975 - 12.52025	240 - 285	3345.8 - 3358	36.43 - 36.5
12.57675 - 12.57725	322 - 335.4	3600 - 4400	(²)
13.36 - 13.41			

Limit in restricted band

Frequency of emission (MHz)	Field strength(uV/m)	Field strength(dBuV/m)
30-88	100	40
88-216	150	43.5
216-960	200	46
Above960	500	54

§15.35(b)

There is also a limit on the radio frequency emissions, as measured using instrumentation with a peak detector function, corresponding to 20 dB above the maximum permitted average limit.

Peak Limit=74 dBuV/m

Average Limit=54 dBuV/m

Measurement Uncertainty

The assessed measurement uncertainty to ensure 95% confidence level for the normal distribution is with the coverage factor $k = 1.96$, $U = 3.55$ dB.

Test Results:

The signal beyond the limit is carrier.

Antenna 1

802.11b-Channel 1: Peak

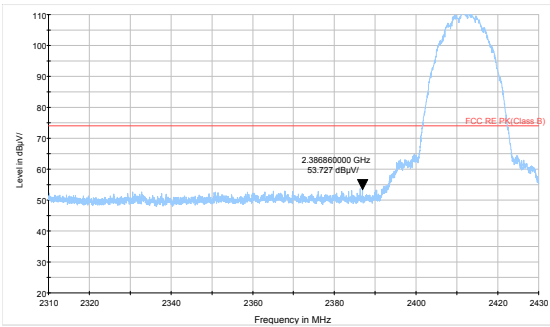

802.11b-Channel 11: Peak

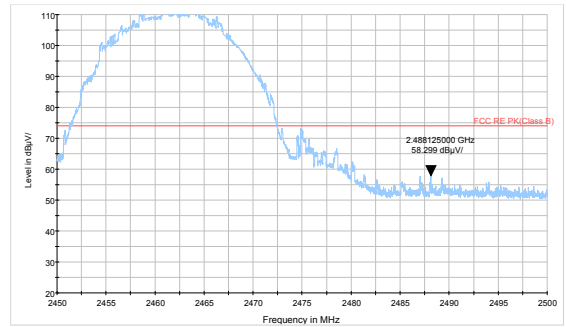

802.11b-Channel 1: Average

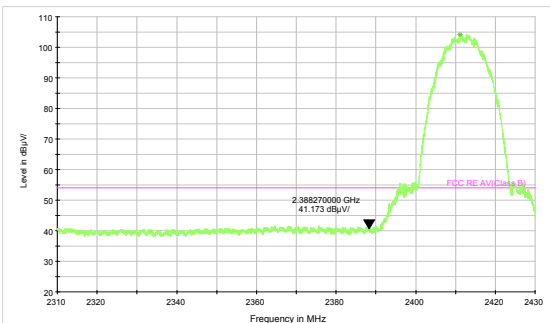

802.11b-Channel 11: Average

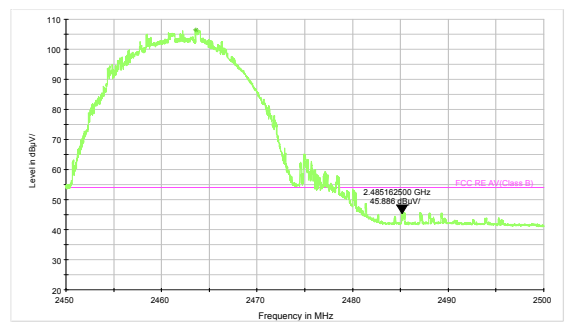

802.11g-Channel 1: Peak

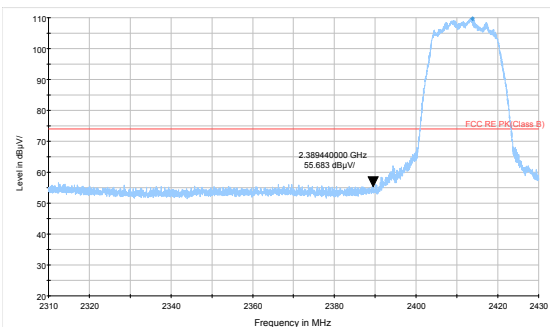

802.11g-Channel 11: Peak

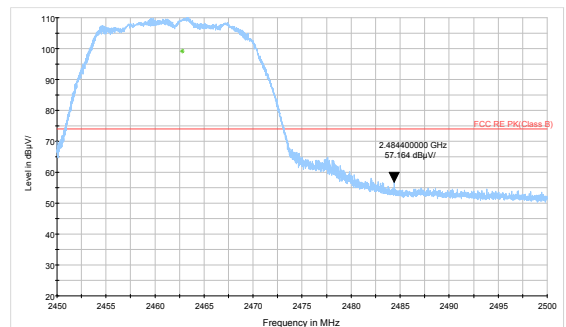

802.11g-Channel 1: Average

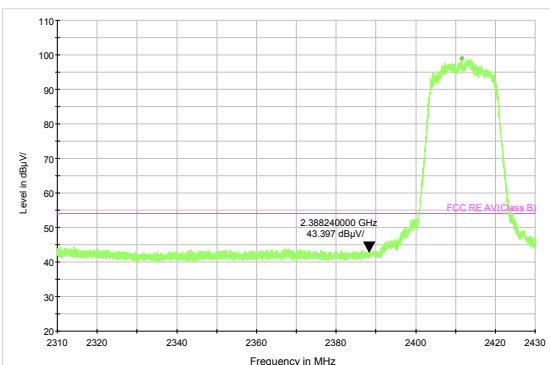

802.11g-Channel 11: Average

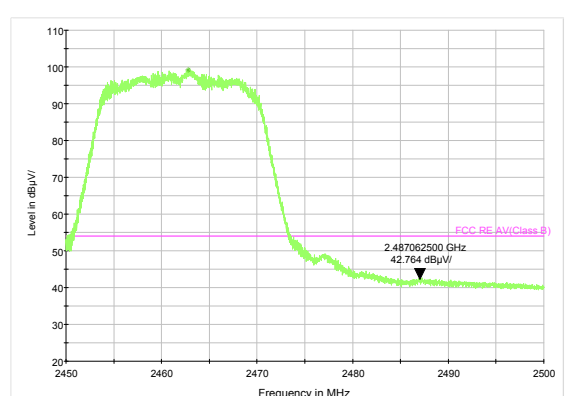



802.11n HT20 -Channel 1: Peak

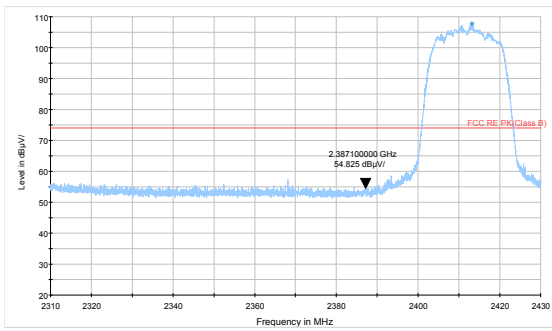

802.11n HT20-Channel 11: Peak

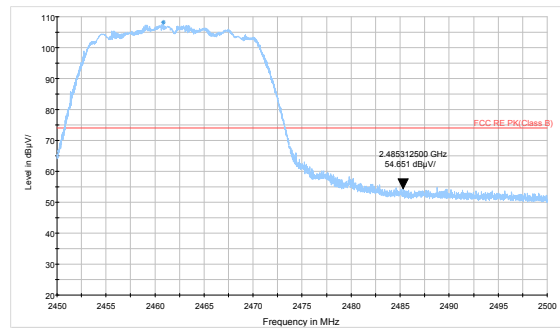

802.11n HT20-Channel 1: Average

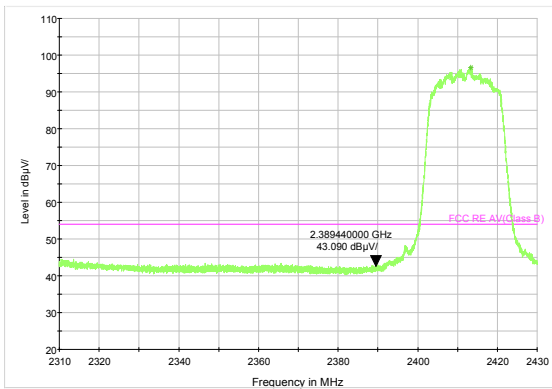

802.11n HT20-Channel 11: Average

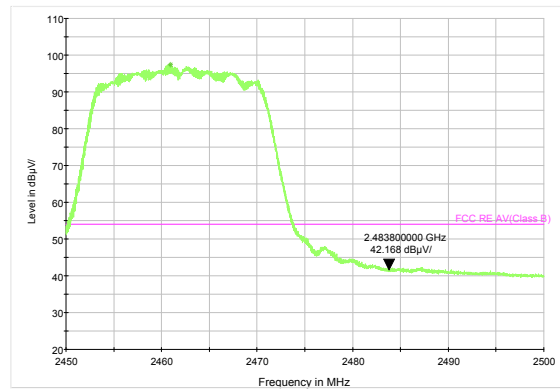

802.11n HT40 -Channel 3: Peak

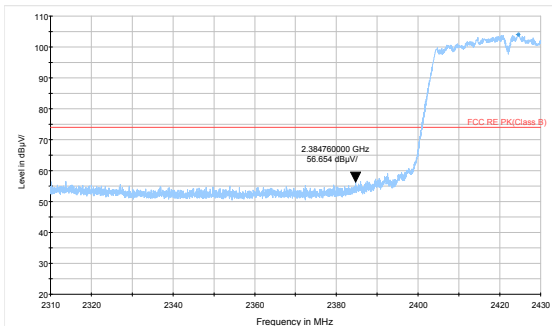

802.11n HT40-Channel 9: Peak

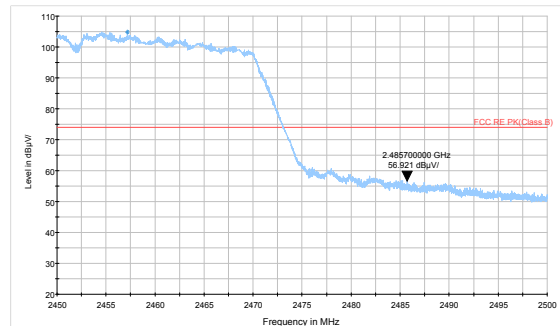

802.11n HT40-Channel 3: Average

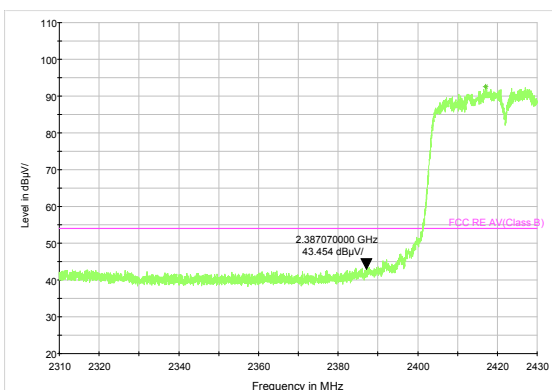

802.11n HT40-Channel 9: Average

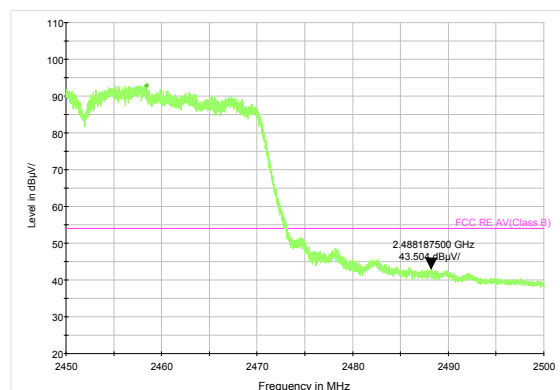

5.7. Radiates Emission

Ambient condition

Temperature	Relative humidity	Pressure
23°C ~25°C	45%~50%	102.5kPa

Method of Measurement

The test set-up was made in accordance to the general provisions of ANSI C63.10-2013. The Equipment Under Test (EUT) was set up on a non-conductive table in the semi-anechoic chamber. The test was performed at the distance of 3 m between the EUT and the receiving antenna. The radiated emissions measurements were made in a typical installation configuration.

Sweep the whole frequency band through the range from 9 kHz to the 10th harmonic of the carrier, and the emissions less than 20 dB below the permissible value are reported.

During the test, below 30MHz, the center of the loop shall be 1 meters; above 30MHz, the height of receive antenna shall be moved from 1 to 4 meters, and the antenna shall be performed under horizontal and vertical polarization. The turntable shall be rotated from 0 to 360 degrees for detecting the maximum of radiated spurious signal level. The measurements shall be repeated with orthogonal polarization of the test antenna. The data of cable loss and antenna factor has been calibrated in full testing frequency range before the testing.

Set the spectrum analyzer in the following:

Below 1GHz (detector: Peak and Quasi-Peak)

RBW=100 kHz / VBW=300 kHz / Sweep=AUTO

Above 1GHz (detector: Peak):

(a) PEAK: RBW=1MHz VBW=3MHz/ Sweep=AUTO

(b) AVERAGE: RBW=1MHz / VBW=3MHz / Sweep=AUTO

The radiated emission was measured in the following position: EUT stand-up position (Z axis), lie-down position (X, Y axis). The worst emission was found in stand-up position (Z axis) and the worst case was recorded.

The test is in transmitting mode.

Test setup
9KHz ~ 30MHz

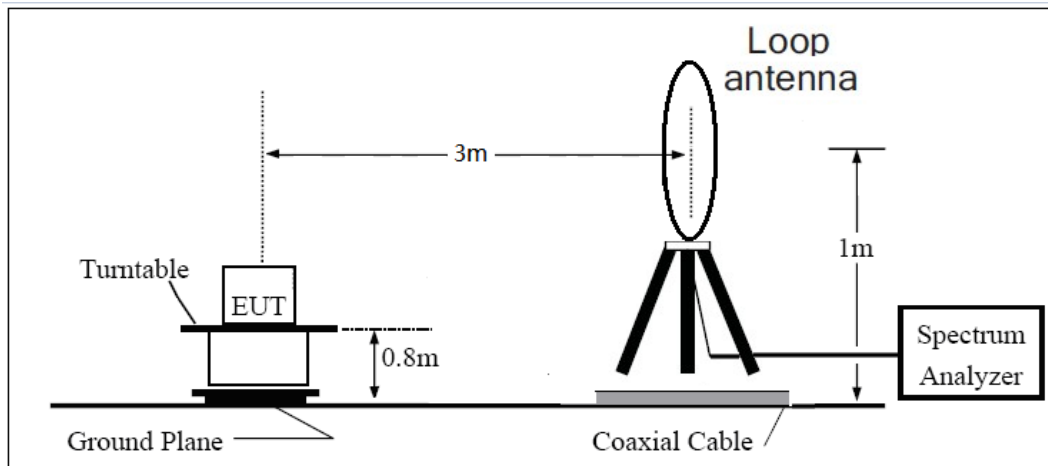

30MHz ~ 1GHz

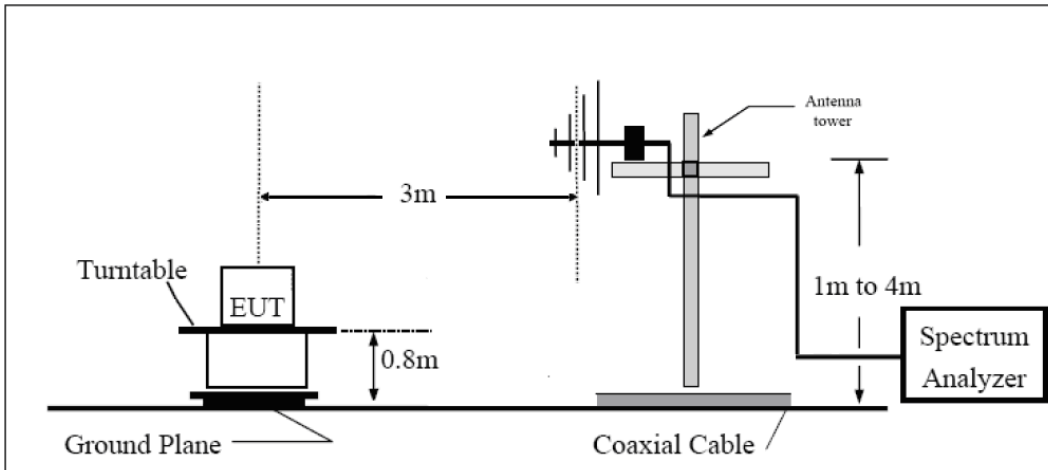

Above 1GHz

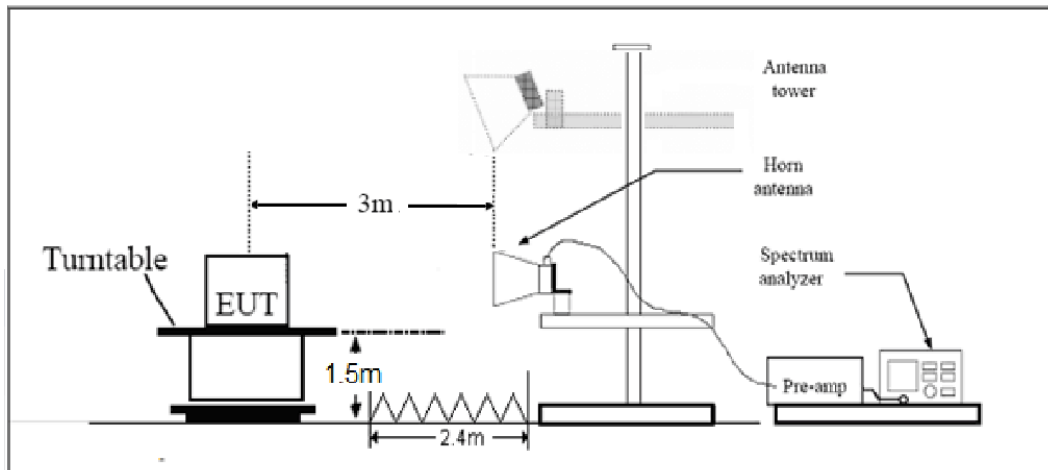

Note: Area side:2.4mX3.6m

Limits

Rule Part 15.247(d) specifies that “In addition, radiated emissions which fall in the restricted bands, as defined in § 15.205(a), must also comply with the radiated emission limits specified in § 15.209(a) (see § 15.205(c)).”

Limit in restricted band

Frequency of emission (MHz)	Field strength(uV/m)	Field strength(dBuV/m)
0.009–0.490	2400/F(kHz)	/
0.490–1.705	24000/F(kHz)	/
1.705–30.0	30	/
30-88	100	40
88-216	150	43.5
216-960	200	46
Above960	500	54

§15.35(b)

There is also a limit on the radio frequency emissions, as measured using instrumentation with a peak detector function, corresponding to 20 dB above the maximum permitted average limit.

Measurement Uncertainty

The assessed measurement uncertainty to ensure 95% confidence level for the normal distribution is with the coverage factor $k = 1.96$.

Frequency	Uncertainty
9KHz-30MHz	3.55 dB
30MHz-200MHz	4.19 dB
200MHz-1GHz	3.63 dB
Above 1GHz	3.68 dB

Test result

Sweep from 9 kHz to 30MHz, and the emissions more than 20 dB below the permissible value are not reported.

The following graphs display the maximum values of horizontal and vertical by software.

For above 1GHz, Blue trace uses the peak detection, Green trace uses the average detection.

WIFI b CH01_3-18GHz_Antenna 1

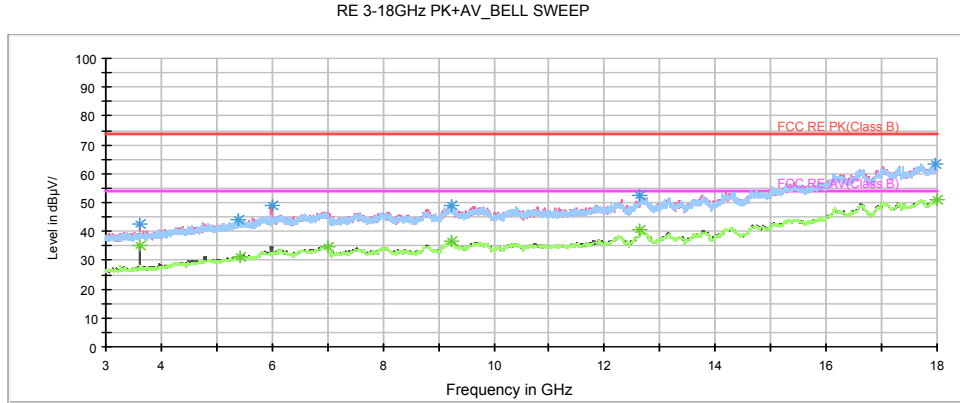

Frequency (MHz)	Average (dBuV/m)	Height (cm)	Polarization	Azimuth (deg)	Reading value (dBuV/m)	Correct Factor (dB)	Margin (dB)	Limit (dBuV/m)
12641.250000	40.5	305.0	V	301.0	26.0	14.5	13.5	54
18000.000000	51.2	400.0	V	0.0	25.7	25.5	2.8	54

Remark: 1. Correction Factor = Antenna factor+ Insertion loss (cable loss + amplifier gain)

WIFI b CH01_3-18GHz_Antenna 2

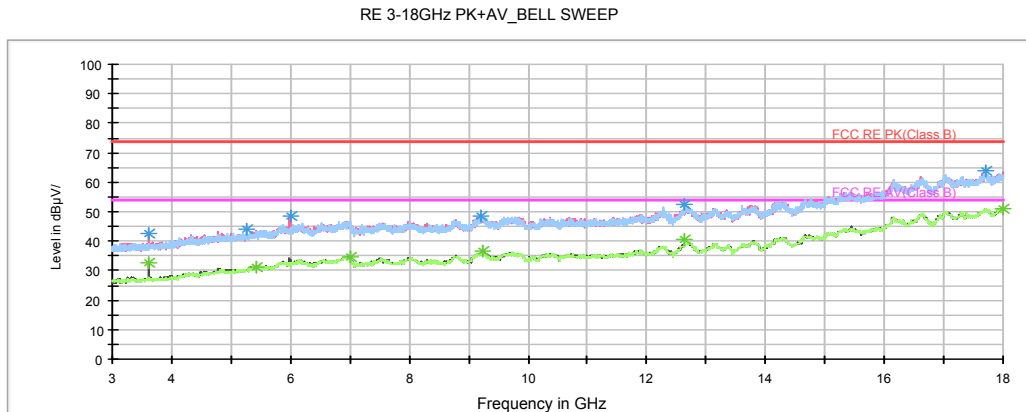

Frequency (MHz)	Average (dBuV/m)	Height (cm)	Polarization	Azimuth (deg)	Reading value (dBuV/m)	Correct Factor (dB)	Margin (dB)	Limit (dBuV/m)
12639.375000	40.4	105.0	V	328.0	25.9	14.5	13.6	54
18000.000000	51.2	305.0	V	191.0	25.7	25.5	2.8	54

Remark: 1. Correction Factor = Antenna factor+ Insertion loss (cable loss + amplifier gain)

After the pre test, Antenna 1 was selected as the worst condition.

Antenna 1
802.11b CH1

RE 30M-1GHz QP

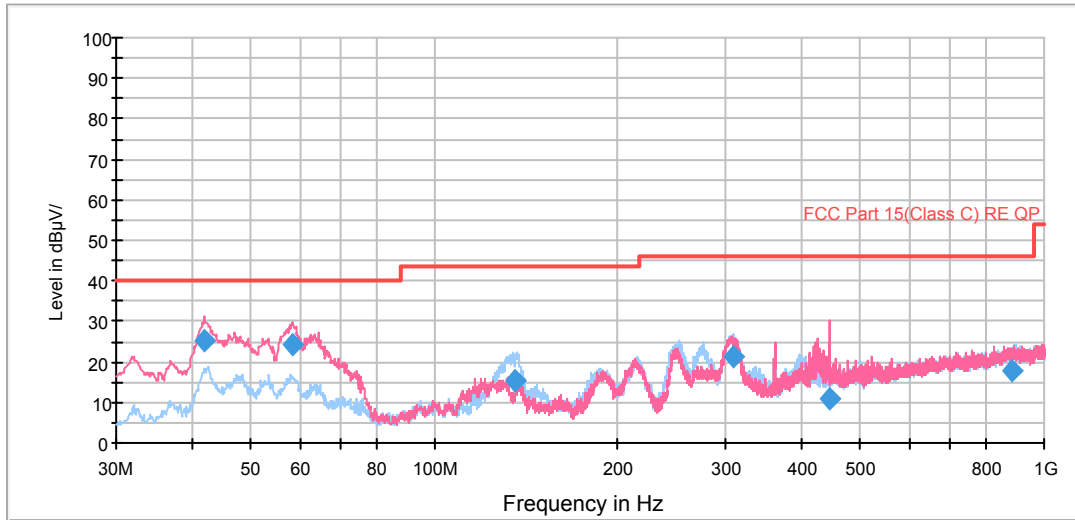

Radiates Emission from 30MHz to 1GHz

Frequency (MHz)	Quasi-Peak (dBuV/m)	Height (cm)	Polarization	Azimuth (deg)	Reading value (dBuV/m)	Correct Factor (dB)	Margin (dB)	Limit (dBuV/m)
41.987206	25.3	125.0	V	303.0	45.6	-20.3	14.7	40.0
58.508462	24.0	102.0	V	218.0	46.8	-22.8	16.0	40.0
135.063100	15.4	225.0	H	158.0	44.5	-29.1	28.1	43.5
309.593250	21.3	121.0	H	264.0	44.4	-23.1	24.7	46.0
443.964250	11.0	125.0	V	0.0	31.6	-20.6	35.0	46.0
888.035750	17.6	209.0	H	88.0	30.3	-12.7	28.4	46.0

- Remark:**
1. Quasi-Peak = Reading value + Correction factor
 2. Correction Factor = Antenna factor+ Insertion loss (cable loss+amplifier gain)
 3. Margin = Limit – Quasi-Peak