

FCC DFS Test Report

FCC ID: 2ADZRG240WB

This report concerns (check one): Original Grant Class II Change

Project No. : 1411C236
Equipment : GPON ONU
Model Name : G-240W-B
Applicant : Alcatel-Lucent Shanghai Bell Co. Ltd.
Address : 6B602, 388 Ningqiao Road Pudong, Shanghai

Date of Receipt : Nov. 24, 2014
Date of Test : Nov. 24, 2014 ~ Feb. 11, 2015
Issued Date : Feb. 12, 2015
Tested by : BTL Inc.

Testing Engineer : David Mao
(David Mao)

Technical Manager : Leo Hung
(Leo Hung)

Authorized Signatory : Steven Lu
(Steven Lu)

B T L I N C .

No.3, Jinshagang 1st Road, Shixia, Dalang Town, Dongguan,
Guangdong, China.

TEL: +86-769-8318-3000 FAX: +86-769-8319-6000

Declaration

BTL represents to the client that testing is done in accordance with standard procedures as applicable and that test instruments used has been calibrated with the standards traceable to National Measurement Laboratory (**NML**) of **R.O.C.**, or National Institute of Standards and Technology (**NIST**) of **U.S.A.**

BTL's reports apply only to the specific samples tested under conditions. It is manufacture's responsibility to ensure that additional production units of this model are manufactured with the identical electrical and mechanical components. **BTL** shall have no liability for any declarations, inferences or generalizations drawn by the client or others from **BTL** issued reports.

BTL's reports must not be used by the client to claim product endorsement by the authorities or any agency of the Government.

This report is the confidential property of the client. As a mutual protection to the clients, the public and **BTL-self**, extracts from the test report shall not be reproduced except in full with **BTL's** authorized written approval.

BTL's laboratory quality assurance procedures are in compliance with the **ISO Guide17025** requirements, and accredited by the conformity assessment authorities listed in this test report.

Limitation

For the use of the authority's logo is limited unless the Test Standard(s)/Scope(s)/Item(s) mentioned in this test report is (are) included in the conformity assessment authorities acceptance respective.

Table of Contents	Page
1 . CERTIFICATION	5
2 . EUT INFORMATION	6
2.1 EUT SPECIFICATION TABLE	6
2.4 EUT MAXIMUM AND MINIMUM E.I.R.P. POWER	8
3 .U-NII DFS RULE REQUIREMENTS	9
3.1 WORKING MODES AND REQUIRED TEST ITEMS	9
3.2 TEST LIMITS AND RADAR SIGNAL PARAMETERS	10
4 . TEST INSTRUMENTS	13
5 .EMC EMISSION TEST	14
5.1 DFS MEASUREMENT SYSTEM:	14
5.2 CALIBRATION OF DFS DETECTION THRESHOLD LEVEL:	16
5.3 DEVIATION FROM TEST STANDARD	16
6 . TEST RESULTS	17
6.1 SUMMARY OF TEST RESULT	17
6.2 DETELED TEST RESULTS	18
6.2.1 TEST MODE: DEVICE OPERATING IN MASTER MODE.	18
6.2.2 DFS DETECTION THRESHOLD	18
6.2.3 CHANNEL AVAILABILITY CHECK TIME	24
6.2.4CHANNEL CLOSING TRANSMISSION AND CHANNEL MOVE TIME WLAN TRAFFIC	33
6.2.5 NON- OCCUPANCY PERIOD	57
6.2.6 UNIFORM SPREADING	59
6.2.7 U-NII DETECTION BANDWIDTH	59

REPORT ISSUED HISTORY

Issued No.	Description	Issued Date
BTL-FCCP-3-1411C236	Original Report.	Feb. 12, 2015

1. CERTIFICATION

Equipment : GPON ONU
Brand Name : Alcatel-Lucent
Model Name : G-240W-B
Applicant : Alcatel-Lucent Shanghai Bell Co. Ltd.
Manufacturer : Alcatel-Lucent Shanghai Bell Co. Ltd.
Address : 6B602, 388 Ningqiao Road Pudong, Shanghai
Factory : 1. Taicang T&W Electronics Co.,Ltd.
2. Shenzhen Gongjin Electronics Co.,Ltd.
Address : 1. Jiangnan Road 89,Ludu Town,Taicang,Jiangsu 215412,P.R.China
2. No 2&3 Buildings, Mingwei Factory Area, Songgang Road West,No. A Building, 1#Songgang Road Songgang Sub-District,Shenzhen,Guangdong, 518105,P.R.China
Date of Test: : Nov. 24, 2014 ~ Feb. 12, 2015
Test Sample : ENGINEERING SAMPLE
Standard(s) : FCC Part 15, Subpart E (Section 15.407)
FCC KDB 789033 D02 General UNII Test Procedures New Rules v01

The above equipment has been tested and found compliance with the requirement of the relative standards by BTL Inc.

The test data, data evaluation, and equipment configuration contained in our test report (Ref No. BTL-FCCP-3-1411C236) were obtained utilizing the test procedures, test instruments, test sites that has been accredited by the Authority of TAF according to the ISO-17025 quality assessment standard and technical standard(s).

Test result included in this report is only for the DFS Mode part of the product.

2. EUT INFORMATION

2.1 EUT SPECIFICATION TABLE

Table 1: Specification of EUT

Product name	GPON ONU
Brand Name	Alcatel-Lucent
Model	G-240W-B
FCC ID	2ADZRG240WB
Software Version	FE56557AFBB29
Hardware Version	3FE 56756 BAAA
Operational Mode	Master
Operating Frequency Range	5260~5320MHz&5500~5700MHz
Modulation	OFDM

Note: This device was functioned as a Master Slave device during the DF

2.2 DESCRIPTION OF AVAILABLE ANTENNAS TO THE EUT

Table 2: Antenna list.

Ant.	Manufacturer	Model Name	Antenna Type	Connector	Gain (dBi)	Note
4	Airgain	N5x20B	Embedded	N/A	2.90	5GHz
5	Airgain	N5x20B	Embedded	N/A	2.90	5GHz
6	Airgain	N5x20B	Embedded	N/A	2.90	5GHz
7	Airgain	N5x20B	Embedded	N/A	2.90	5GHz

G-240W-B	KIT Part Number	EMA Part Number
	3FE56636AAAA	3FE56756BAAA
	3FE56636BAAA	3FE56756AABA
	3FE56636CAAA	3FE56756AABA
	3FE56636CBAA	3FE56756ABBA

2.3 CONDUCTED OUTPUT POWER AND EIRP POWER

TABLE 3: THE CONDUCTED OUTPUT POWER LIST

TX (11a)

FREQUENCY BAND (MHz)	MAX. POWER	
	OUTPUT POWER(dBm)	OUTPUT POWER(mW)
5260~5320	19.56	90.365
5500~5700	18.07	64.121

TX (11n 40MHz)

FREQUENCY BAND (MHz)	MAX. POWER	
	OUTPUT POWER(dBm)	OUTPUT POWER(mW)
5270~5310	23.19	208.449
5510~5670	22.60	181.970

TX (11ac 80 MHz)

FREQUENCY BAND (MHz)	MAX. POWER	
	OUTPUT POWER(dBm)	OUTPUT POWER(mW)
5290	18.14	65.163
5530	23.55	226.464

2.4 EUT MAXIMUM AND MINIMUM E.I.R.P. POWER

TABLE 4: THE MAX EIRP LIST

TX (11a)

FREQUENCY BAND (MHz)	MAX. POWER	
	OUTPUT POWER(dBm)	OUTPUT POWER(mW)
5260~5320	22.46	176.20
5500~5700	20.97	125.03

TX (11n40MHz)

FREQUENCY BAND (MHz)	MAX. POWER	
	OUTPUT POWER(dBm)	OUTPUT POWER(mW)
5270~5310	26.09	406.44
5510~5670	25.50	354.81

TX (11ac 80 MHz)

FREQUENCY BAND (MHz)	MAX. POWER	
	OUTPUT POWER(dBm)	OUTPUT POWER(mW)
5290	21.04	127.06
5530	26.45	441.57

3.U-NII DFS RULE REQUIREMENTS

3.1 WORKING MODES AND REQUIRED TEST ITEMS

The manufacturer shall state whether the UUT is capable of operating as a Master and/or a Client. If the UUT is capable of operating in more than one operating mode then each operating mode shall be tested separately. See tables 1 and 2 for the applicability of DFS requirements for each of the operational modes.

Table 5: Applicability of DFS requirements prior to use a channel

Requirement	Operational Mode		
	Master	Client without radar detection	Client with radar detection
Non-Occupancy Period	✓	Not required	✓
DFS Detection Threshold	✓	Not required	✓
Channel Availability Check Time	✓	Not required	Not required
Uniform Spreading	✓	Not required	Not required
U-NII Detection Bandwidth	✓	Not required	✓

Table 6: Applicability of DFS requirements during normal operation.

Requirement	Operational Mode		
	Master	Client without radar detection	Client with radar detection
DFS Detection Threshold	✓	Not required	✓
Channel Closing Transmission Time	✓	✓	✓
Channel Move Time	✓	✓	✓
U-NII Detection Bandwidth	✓	Not required	✓

3.2 TEST LIMITS AND RADAR SIGNAL PARAMETERS

DETECTION THRESHOLD VALUES

Table 7: DFS Detection Thresholds for Master Devices and Client Devices With Radar Detection.

Maximum Transmit Power	Value (See Notes 1 and 2)
EIRP \geq 200 milliwatt	-64 dBm
EIRP < 200 milliwatt and power spectral density < 10 dBm/MHz	-62 dBm
EIRP < 200 milliwatt that do not meet the power spectral density requirement	-64 dBm

Note 1: This is the level at the input of the receiver assuming a 0 dBi receive antenna.

Note 2: Throughout these test procedures an additional 1 dB has been added to the amplitude of the test transmission waveforms to account for variations in measurement equipment. This will ensure that the test signal is at or above the detection threshold level to trigger a DFS response.

Note3: EIRP is based on the highest antenna gain. For MIMO devices refer to KDB Publication 662911 D01.

Table 8: DFS Response Requirement Values

Parameter	Value
Non-occupancy period	Minimum 30 minutes
Channel Availability Check Time	60 seconds
Channel Move Time	10 seconds See Note 1.
Channel Closing Transmission Time	200 milliseconds + an aggregate of 60 milliseconds over remaining 10 second period. See Notes 1 and 2.
U-NII Detection Bandwidth	Minimum 100% of the UNII 99% transmission power bandwidth. See Note 3.

Note 1: Channel Move Time and the Channel Closing Transmission Time should be performed with Radar Type 0. The measurement timing begins at the end of the Radar Type 0 burst.

Note 2: The Channel Closing Transmission Time is comprised of 200 milliseconds starting at the beginning of the Channel Move Time plus any additional intermittent control signals required to facilitate a Channel move (an aggregate of 60 milliseconds) during the remainder of the 10 second period. The aggregate duration of control signals will not count quiet periods in between transmissions.

Note 3: During the U-NII Detection Bandwidth detection test, radar type 0 should be used. For each frequency step the minimum percentage of detection is 90 percent. Measurements are performed with no data traffic.

PARAMETERS OF DFS TEST SIGNALS

Step intervals of 0.1 microsecond for Pulse Width, 1 microsecond for PRI, 1 MHz for chirp width and 1 for the number of pulses will be utilized for the random determination of specific test waveforms.

Table 9: Short Pulse Radar Test Waveforms.

Radar Type	Pulse Width (μsec)	PRI (μsec)	Number of Pulses	Minimum Percentage of Successful Detection	Minimum Number of Trials
0	1	1428	18	See Note 1	See Note 1
1	1	Test A: 15 unique PRI values randomly selected from the list of 23 PRI values in Table 5a	Roundup $\left\{ \begin{array}{l} \left(\frac{1}{360} \right) \\ \left(\frac{19 \cdot 10^6}{\text{PRI}_{\mu\text{sec}}} \right) \end{array} \right\}$	60%	30
		Test B: 15 unique PRI values randomly selected within the range of 518-3066 μsec, with a minimum increment of 1 μsec, excluding PRI values selected in Test A			
2	1-5	150-230	23-29	60%	30
3	6-10	200-500	16-18	60%	30
4	11-20	200-500	12-16	60%	30
Aggregate (Radar Types 1-4)				80%	120
Note 1: Short Pulse Radar Type 0 should be used for the detection bandwidth test, channel move time, and channel closing time tests.					

A minimum of 30 unique waveforms are required for each of the Short Pulse Radar Types 2 through 4. If more than 30 waveforms are used for Short Pulse Radar Types 2 through 4, then each additional waveform must also be unique and not repeated from the previous waveforms. If more than 30 waveforms are used for Short Pulse Radar Type 1, then each additional waveform is generated with Test B and must also be unique and not repeated from the previous waveforms in Tests A or B.

Table 10: Long Pulse Radar Test Waveform

Radar Type	Pulse Width (μsec)	Chirp Width (MHz)	PRI (μsec)	Number of Pulses per Burst	Number of Bursts	Minimum Percentage of Successful Detection	Minimum Number of Trials
5	50-100	5-20	1000-2000	1-3	8-20	80%	30

Table 11: Frequency Hopping Radar Test Waveform

Radar Type	Pulse Width (μsec)	Chirp Width (MHz)	PRI (μsec)	Number of Pulses per Burst	Number of Bursts	Minimum Percentage of Successful Detection	Minimum Number of Trials
6	1	333	9	0.333	300	70%	30

4. TEST INSTRUMENTS

Table 1: Test instruments list.

DESCRIPTION	MANUFACTURER	MODEL NO.	Serial No	Calibration Until
EXA Spectrum Analyzer	Agilent	N9010A	MY50520044	2015-04-25
Signal Generator	Agilent	E4438C	My49071316	2015-04-25
POWER SPLITTER	Mini-Circuits	ZFRSC-123-S+	331000910	2015-04-25
POWER SPLITTER	Mini-Circuits	ZN4PD1-63-S+	SF933501045	2015-04-25
POWER SPLITTER	Mini-Circuits	ZN2PD-9G-S+	SF012700714	2015-04-25
attenuator	Mini-Circuits	VAT-30+	30912	2015-04-25
attenuator	Mini-Circuits	VAT-10+	30909	2015-04-25
Spectrum Analyzer	R&S	FSL 6	1004423	2015-11-02
PC	Dell 745	DCSM	G7K832X	--
Netbook	Hp	HSTNN-I69C-3	CNU02203XG	--

Note: Calibration interval of instruments listed above is one year.

5.EMC EMISSION TEST

5.1DFS MEASUREMENT SYSTEM:

CONDUCTED METHOD SYSTEM BLOCK DIAGRAM

Master Conducted Measurement

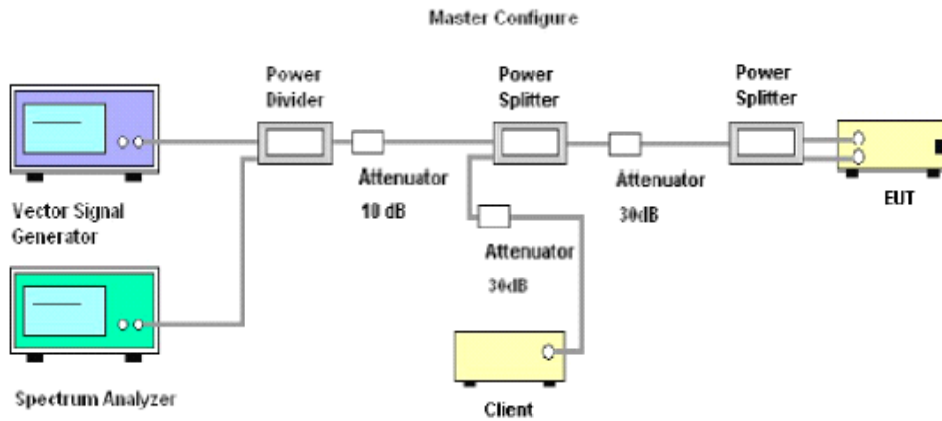

SYSTEM OVERVIEW

The short pulse and long pulse signal generating system utilizes the NTIA software. The Vector Signal Generator has been validated by the NTIA. The hopping signal generating system utilizes the CCS simulated hopping method and system, which has been validated by the DoD, FCC and NTIA. The software selects waveform parameters from within the bounds of the signal type on a random basis using uniform distribution.

The short pulse types 2, 3 and 4, and the long pulse type 5 parameters are randomized at run-time.

The hopping type 6 pulse parameters are fixed while the hopping sequence is based on the August 2005 NTIA Hopping Frequency List. The initial starting point randomized at run-time and each subsequent starting point is incremented by 475. Each frequency in the 100-length segment is compared to the boundaries of the EUT Detection Bandwidth and the software creates a hopping burst pattern in accordance with Section 7.4.1.3 Method #2 Simulated Frequency Hopping Radar Waveform Generating Subsystem of FCC 06-96. The frequency of the signal generator is incremented in 1 MHz steps from FL to FH for each successive trial. This incremental sequence is repeated as required to generate a minimum of 30 total trials and to maintain a uniform frequency distribution over the entire Detection Bandwidth.

The signal monitoring equipment consists of a spectrum analyzer set to display 8001 bins on the horizontal axis. The time-domain resolution is 2 msec / bin with a 16 second sweep time, meeting the 10 second short pulse reporting criteria. The aggregate ON time is calculated by multiplying the number of bins above a threshold during a particular observation period by the dwell time per bin, with the analyzer set to peak detection and max hold.

Should multiple RF ports be utilized for the Master and/or Slave devices (for example, for diversity or MIMO implementations), additional combiner/dividers are inserted between the Master Combiner/Divider and the pad connected to the Master Device (and/or between the Slave Combiner/Divider and the pad connected to the Slave Device). Additional pads are utilized such that there is one pad at each RF port on each EUT.

5.2 CALIBRATION OF DFS DETECTION THRESHOLD LEVEL:

A 50 ohm load is connected in place of the spectrum analyzer, and the spectrum analyzer is connected in place of the master device and the signal generator is set to CW mode. The amplitude of the signal generator is adjusted to yield a level of -62 dBm as measured on the spectrum analyzer.

Without changing any of the instrument settings, the spectrum analyzer is reconnected to the Common port of the Spectrum Analyzer Combiner/Divider. Measure the amplitude and calculate the difference from -62 dBm. Adjust the Reference Level Offset of the spectrum analyzer to this difference.

The spectrum analyzer displays the level of the signal generator as received at the antenna ports of the Master Device. The interference detection threshold may be varied from the calibrated value of -62 dBm and the spectrum analyzer will still indicate the level as received by the Master Device.

Set the signal generator to produce a radar waveform, trigger a burst manually and measure the level on the spectrum analyzer. Readjust the amplitude of the signal generator as required so that the peak level of the waveform is at a displayed level equal to the required or desired interference detection threshold. Separate signal generator amplitude settings are determined as required for each radar type.

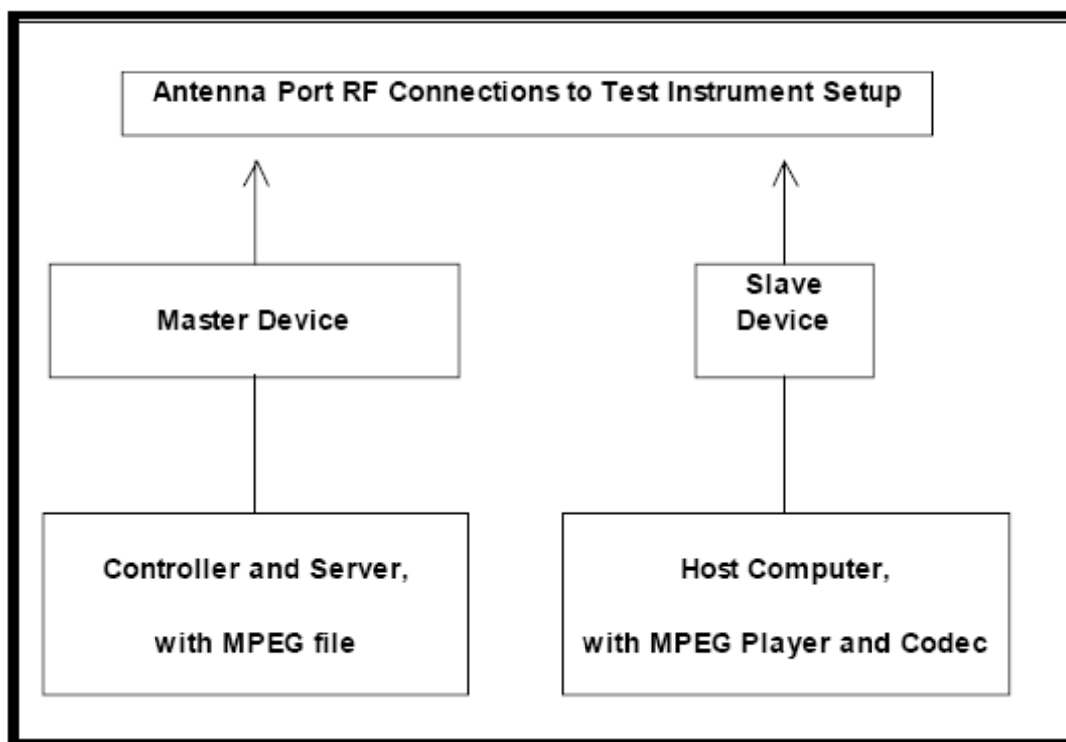

5.3 DEVIATION FROM TEST STANDARD

No deviation.

6. TEST RESULTS

6.1 SUMMARY OF TEST RESULT

Clause	Test Parameter	Remarks	Pass/Fail
15.407	DFS Detection Threshold	Applicable	Pass
15.407	Channel Availability Check Time	Applicable	Pass
15.407	Channel Move Time	Applicable	Pass
15.407	Channel Closing Transmission Time	Applicable	Pass
15.407	Non- Occupancy Period	Applicable	Pass
15.407	Uniform Spreading	Applicable	Pass
15.407	U-NII Detection Bandwidth	Applicable	Pass

6.2 DETELED TEST RESULTS

Clause	Test Parameter	Remarks	Pass/Fail
15.407	DFS Detection Threshold	Applicable	Pass
15.407	Channel Availability Check Time	Applicable	Pass
15.407	Channel Move Time	Applicable	Pass
15.407	Channel Closing Transmission Time	Applicable	Pass
15.407	Non- Occupancy Period	Applicable	Pass
15.407	Uniform Spreading	Applicable	Pass
15.407	U-NII Detection Bandwidth	Applicable	Pass

6.2.1 TEST MODE: DEVICE OPERATING IN MASTER MODE.

Master with injection at the Master. (Radar Test Waveforms are injected into the Master)

6.2.2 DFS DETECTION THRESHOLD

Calibration:

For a detection threshold level of -64dBm and the Master antenna gain is 2.9dBi, required detection threshold is -61.1 dBm (= -64+2.9).

Note: Maximum Transmit Power is more than 200 milliwatt in this report, so detection threshold level is -64dBm (please refer to Table 7 [page 9]).

Radar Signal 0

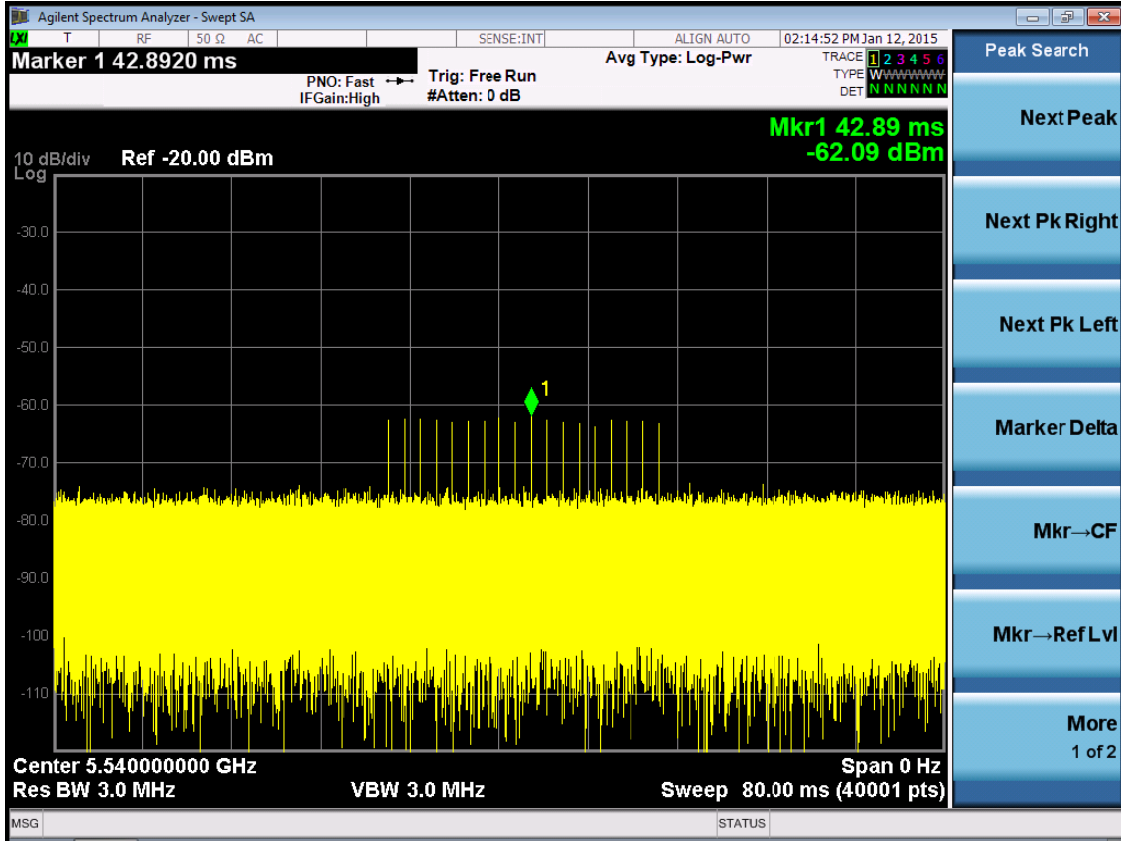

Radar Signal 1-A

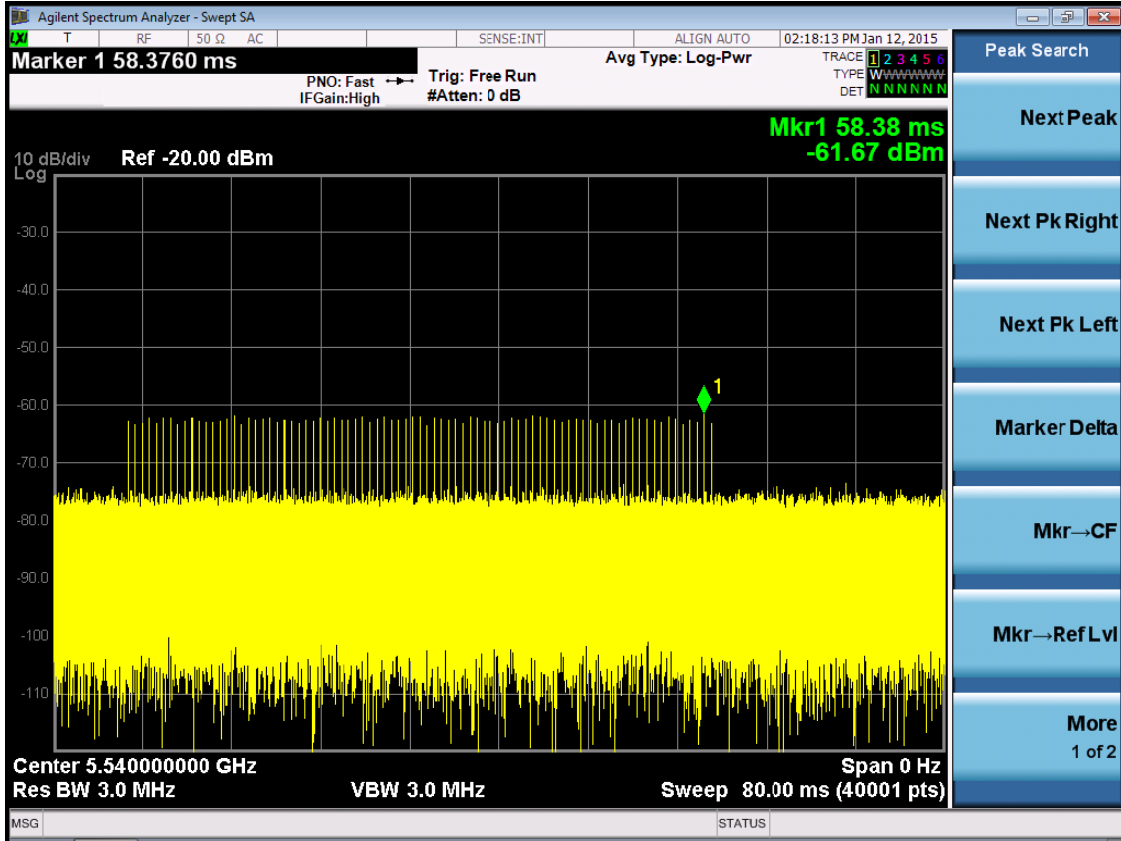

Radar Signal 1-B

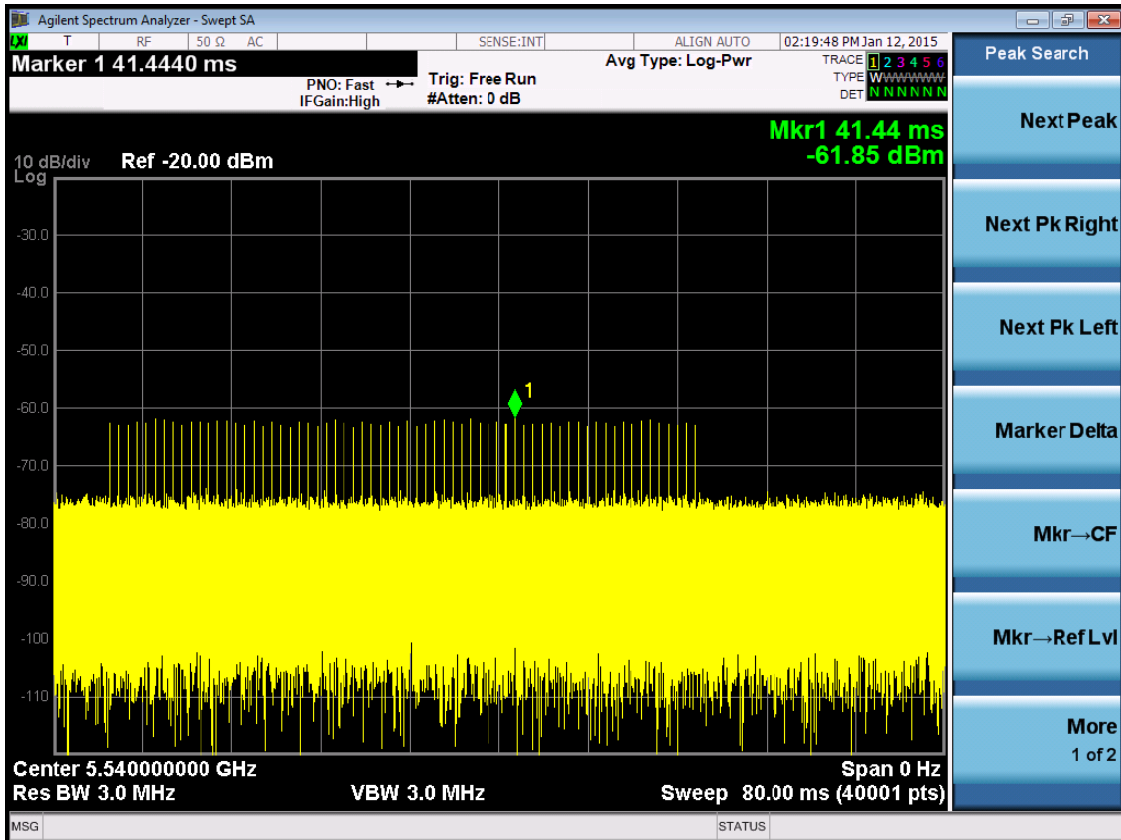

Radar Signal 2

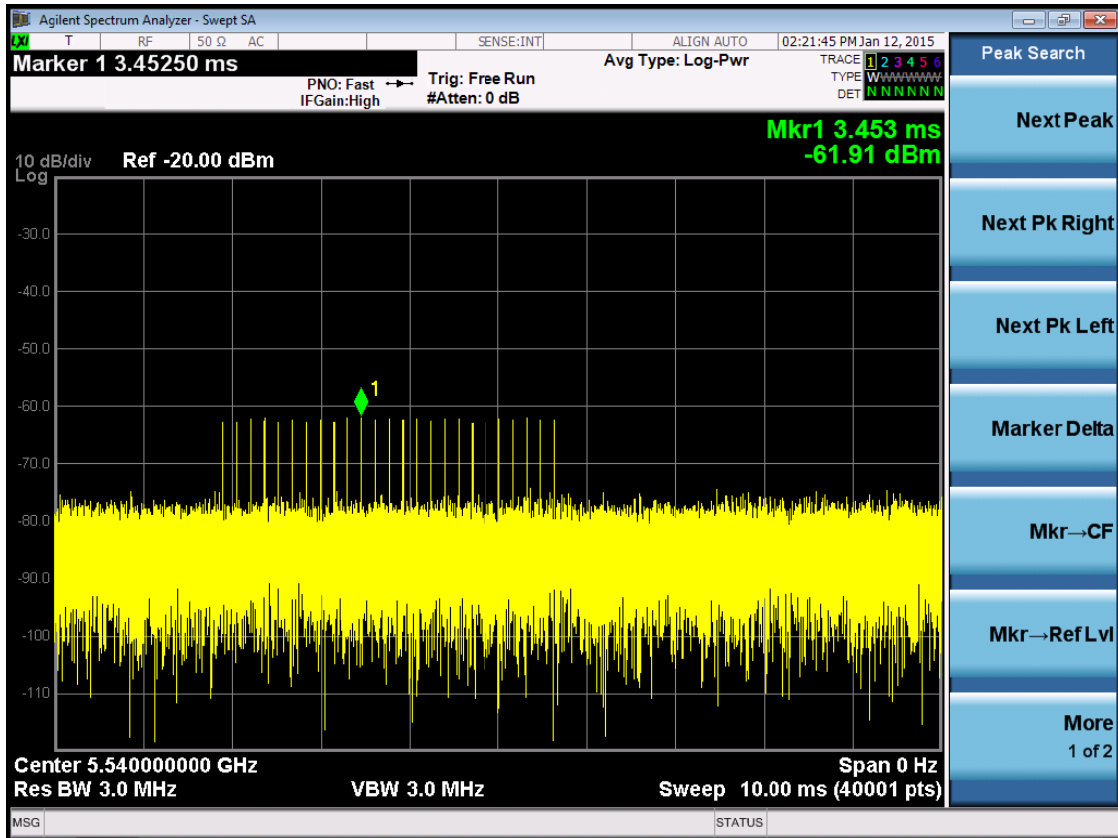

Radar Signal 3

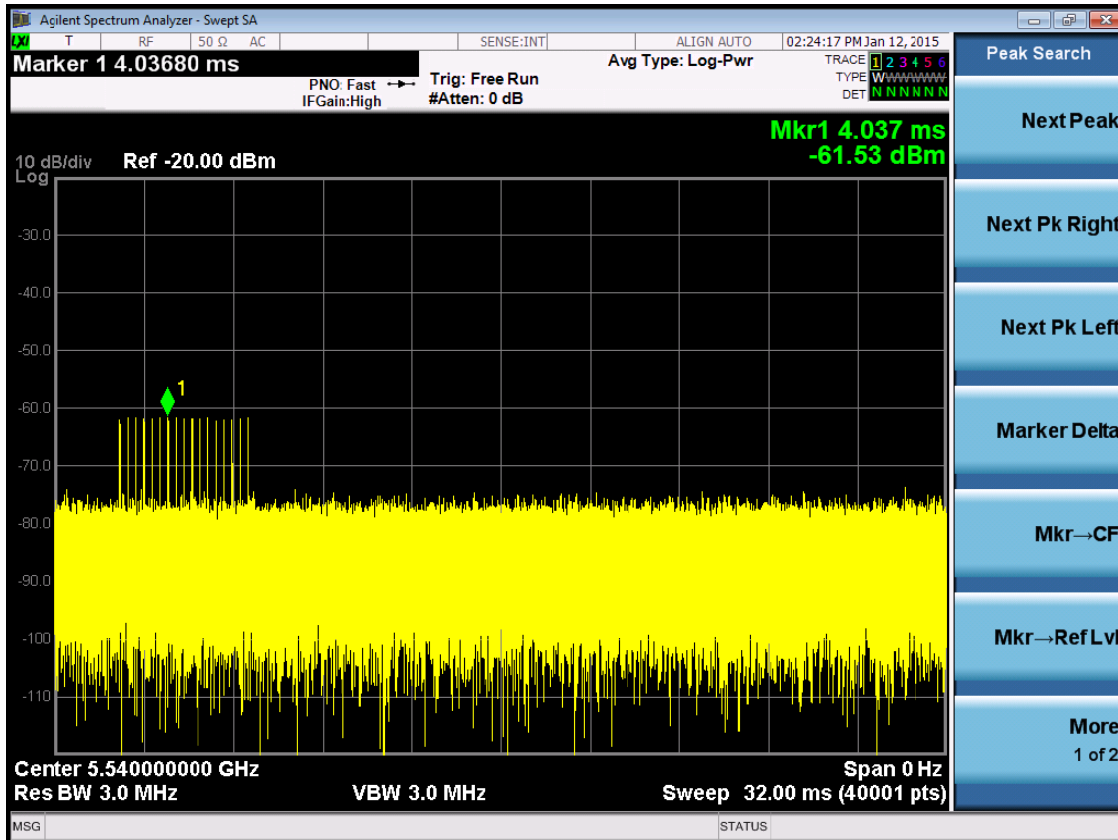

Radar Signal 4

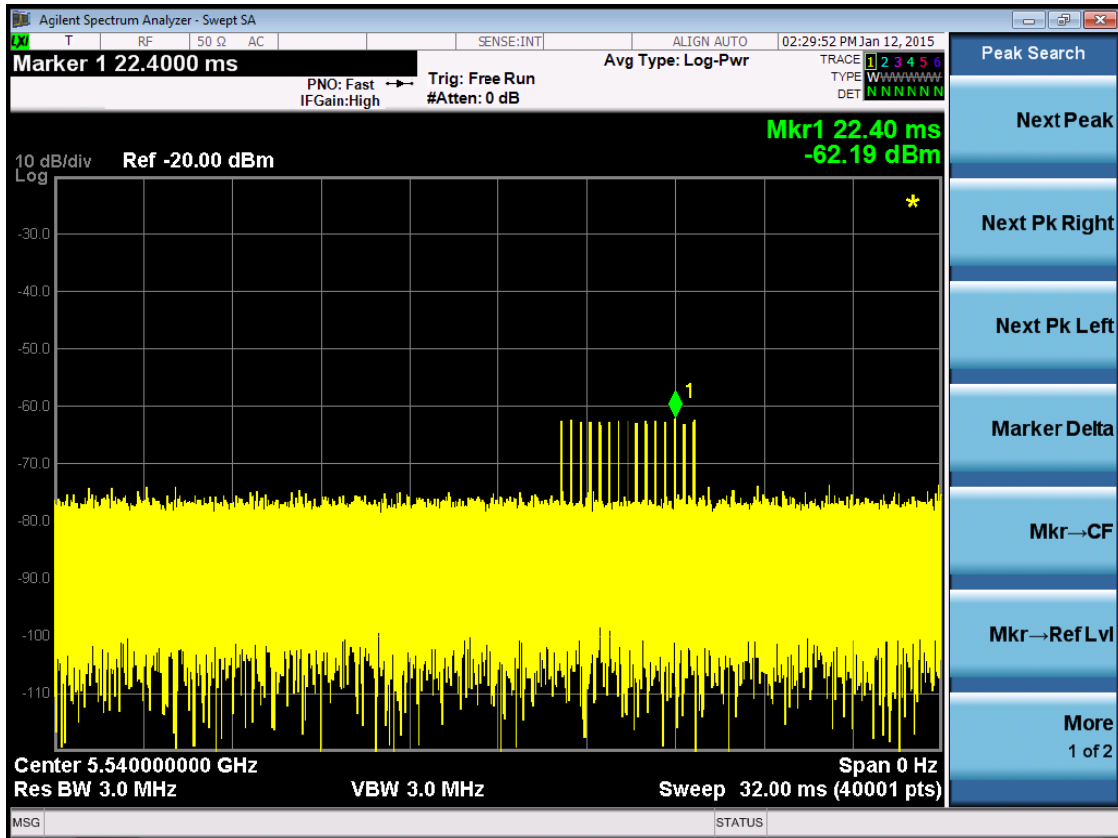

Radar Signal 5

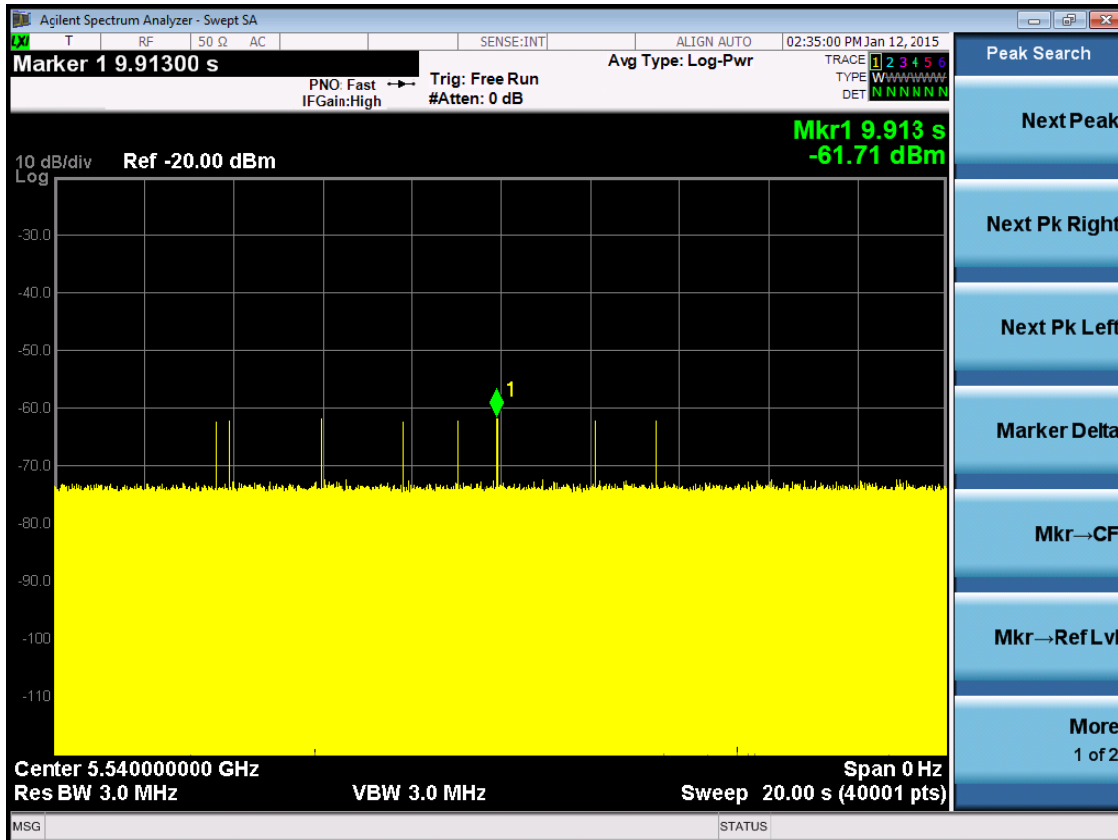

Radar Signal 6

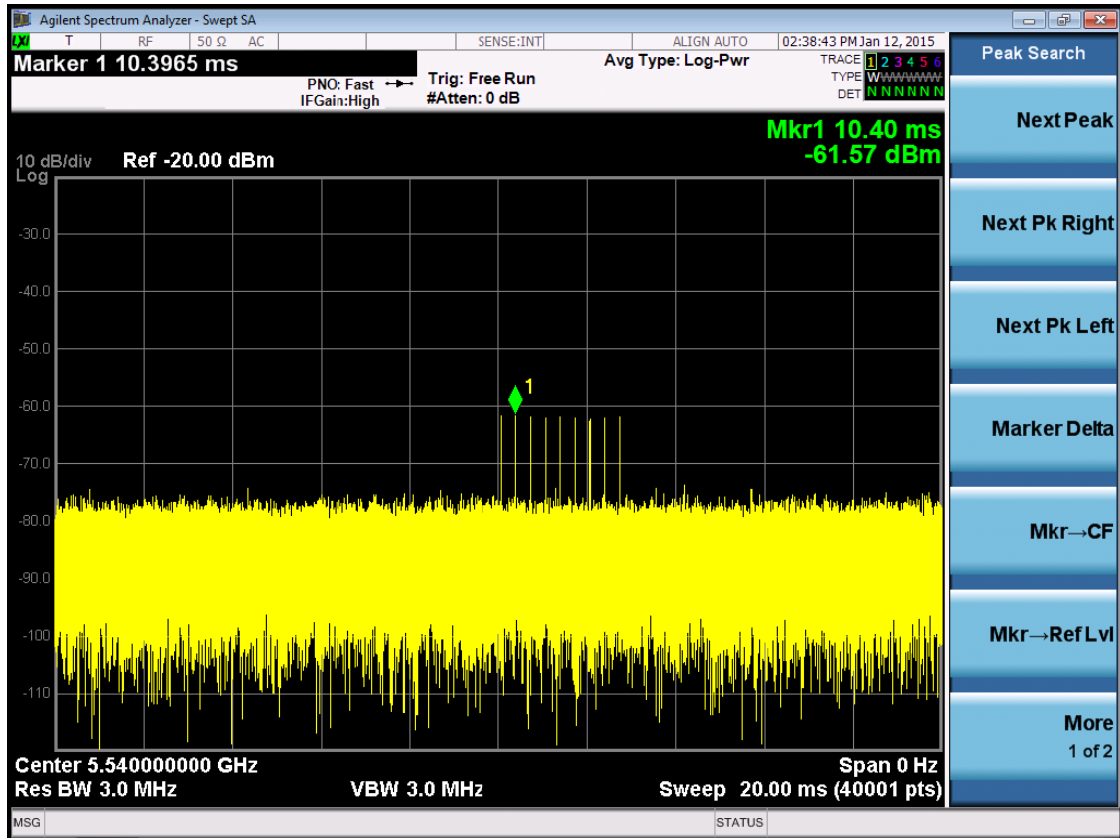

6.2.3 CHANNEL AVAILABILITY CHECK TIME

If the UUT successfully detected the radar burst, it should be observed as the UUT has no transmissions occurred until the UUT starts transmitting on another channel.

11a Mode

Initial Channel Availability Check Time

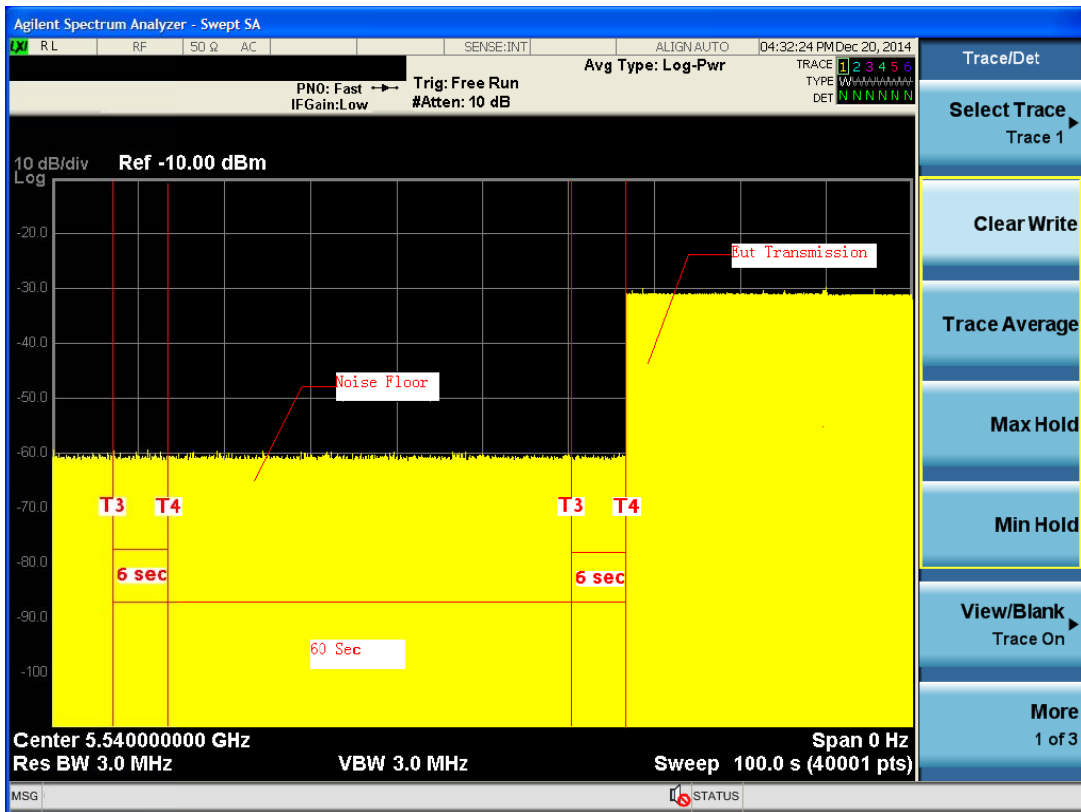

Note: T1 denotes the end of power-up time period is 6 second.

T4 denotes the end of Channel Availability Check time is 66 second. Channel Availability Check time is equal to (T4 – T1) 60 seconds.

11a Mode

Radar Burst at the Beginning of the Channel Availability Check Time

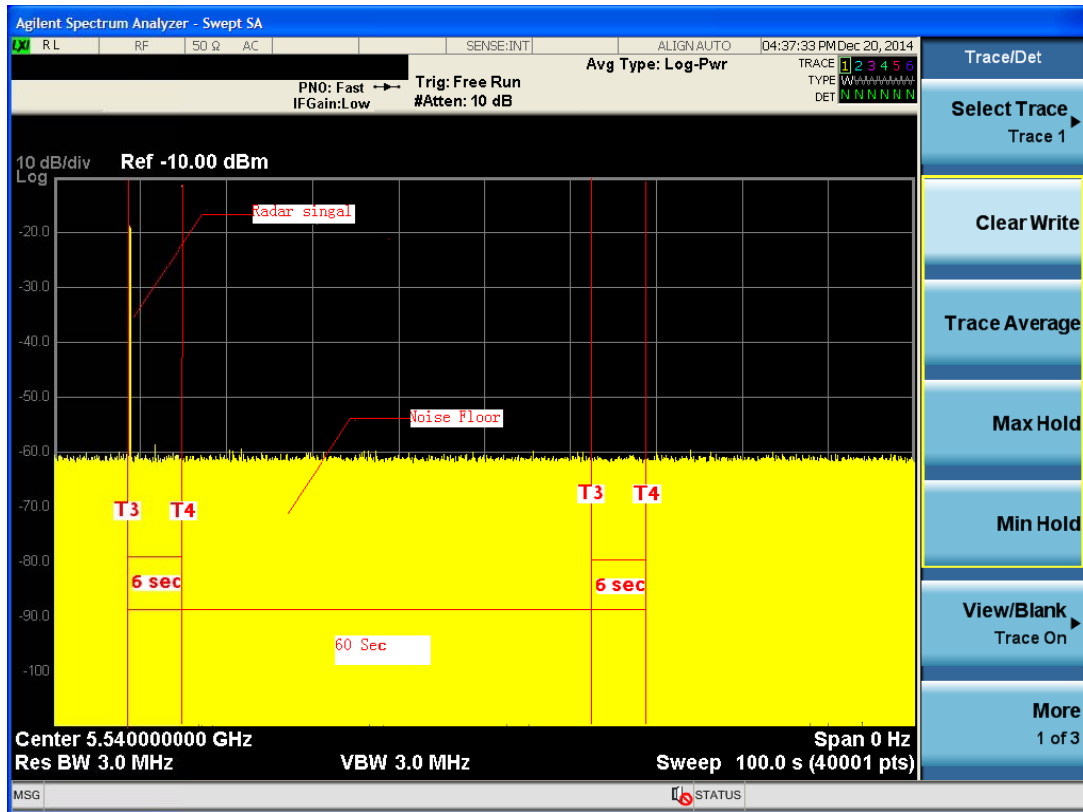

Note: T1 denotes the end of power up time period is 6 second.
 T2 denotes 12 second. the radar burst was commenced within a 6 second window starting from the end of power-up sequence.
 T4 denotes the 66 second.

11n 40MHz Mode

Initial Channel Availability Check Time

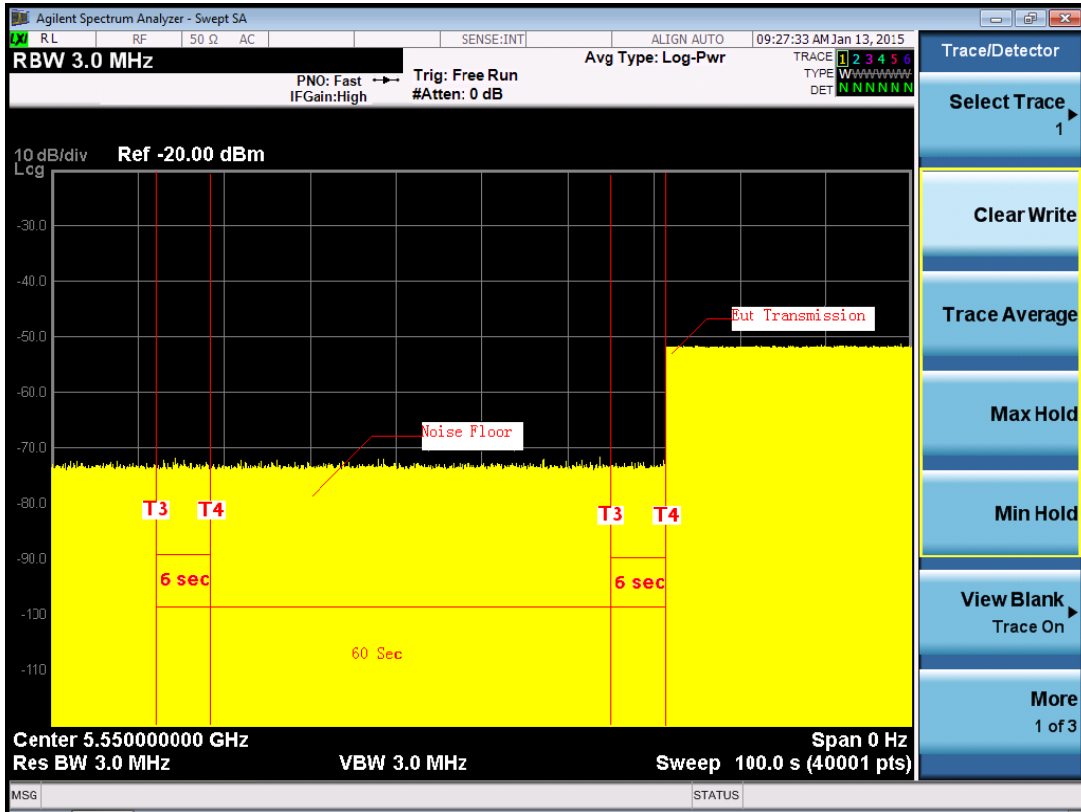

Note: T1 denotes the end of power-up time period is 6 second.
T4 denotes the end of Channel Availability Check time is 66 second. Channel Availability Check time is equal to (T4 – T1) 60 seconds.

11n 40MHz Mode

Radar Burst at the Beginning of the Channel Availability Check Time

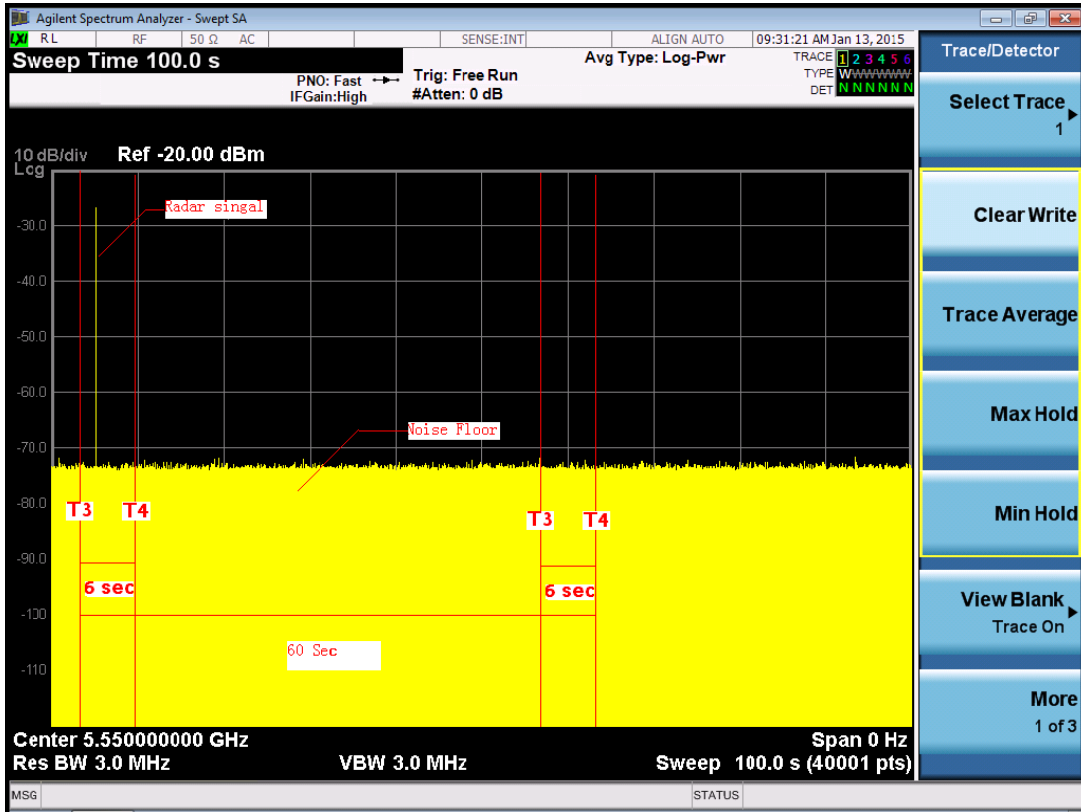

Note: T1 denotes the end of power up time period is 6 second.

T2 denotes 12 second. the radar burst was commenced within a 6 second window starting from the end of power-up sequence.

T4 denotes the 66 second.

11n 40MHz Mode

Radar Burst at the End of the Channel Availability Check Time

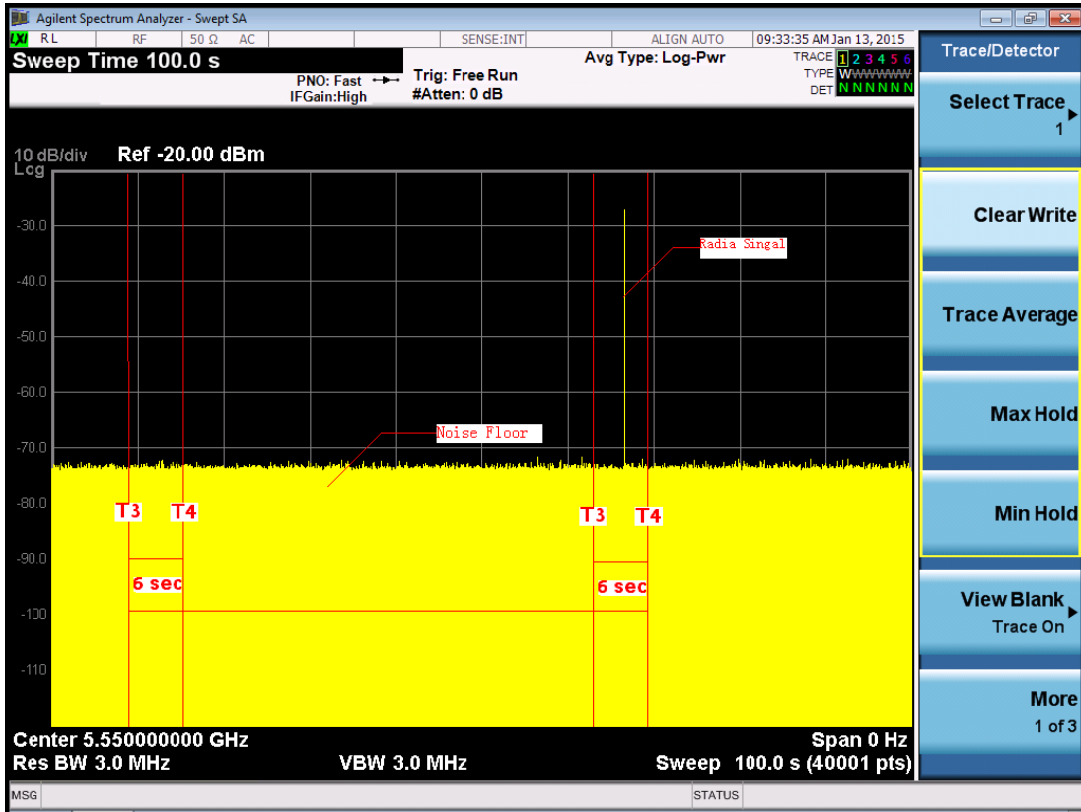

Note: T1 denotes the end of power up time period is 6 second.
T3 denotes 66 second and radar burst was commenced within 54thsecond to 60thsecond window starting from the end of power-up sequence.
T4 denotes the 66 second

11ac 80MHz Mode

Initial Channel Availability Check Time

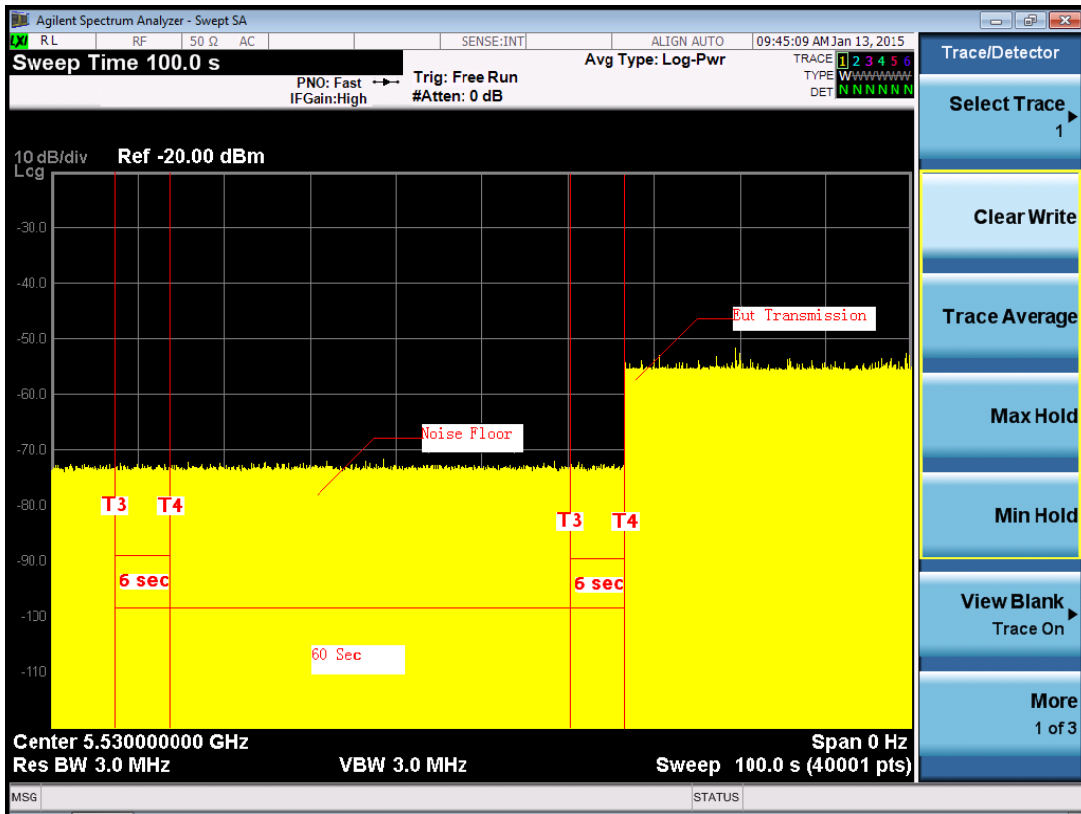

Note: T1 denotes the end of power-up time period is 6 second.
T4 denotes the end of Channel Availability Check time is 66 second. Channel Availability Check time is equal to (T4 – T1) 60 seconds.

11ac 80MHz Mode

Radar Burst at the Beginning of the Channel Availability Check Time

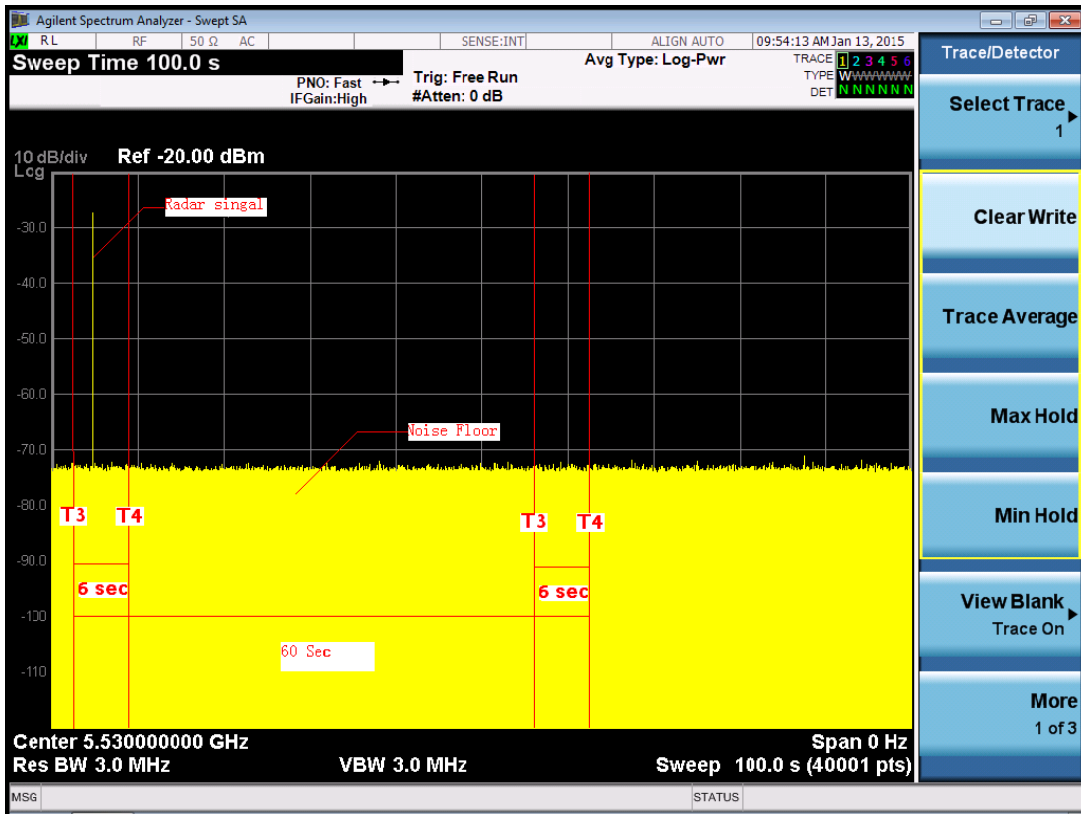

Note: T1 denotes the end of power up time period is 6 second.

T2 denotes 12 second. the radar burst was commenced within a 6 second window starting from the end of power-up sequence.

T4 denotes the 66 second.

11ac 80MHz Mode

Radar Burst at the End of the Channel Availability Check Time

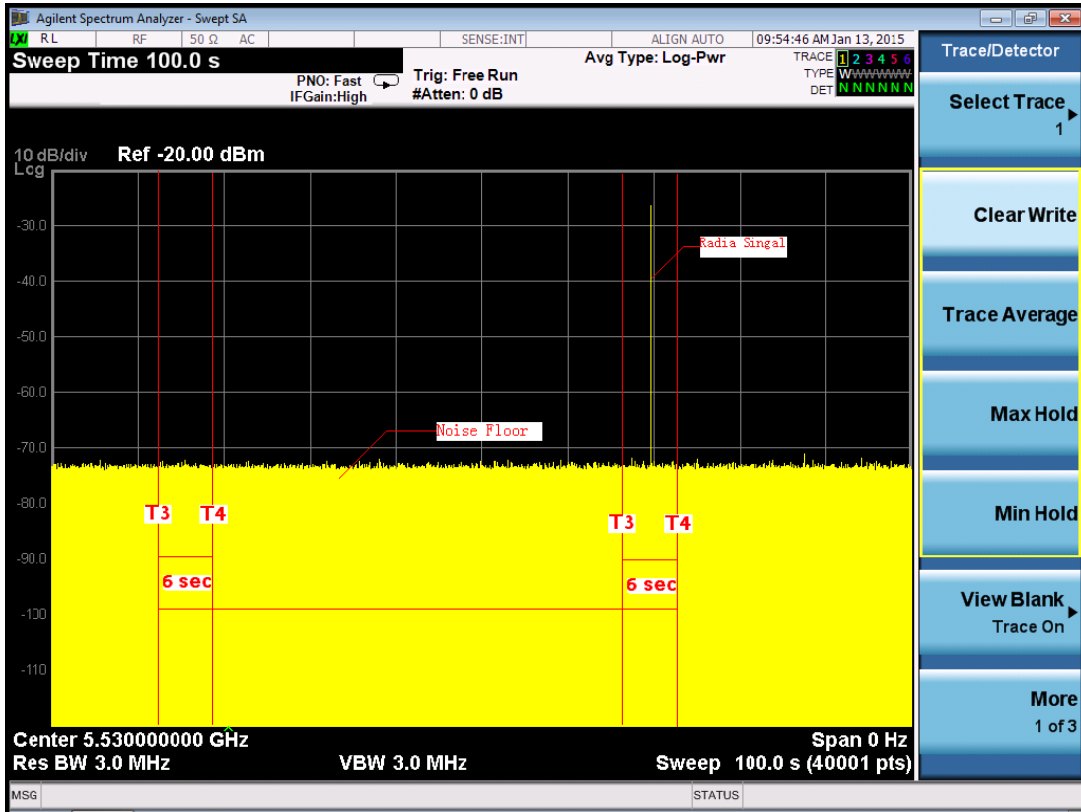

Note: T1 denotes the end of power up time period is 6 second.
 T3 denotes 66 second and radar burst was commenced within 54thsecond to 60thsecond window starting from the end of power-up sequence.
 T4 denotes the 66 second

6.2.4 CHANNEL CLOSING TRANSMISSION AND CHANNEL MOVE TIME WLAN TRAFFIC

TX (11a Mode)

Table 1: Short Pulse Radar Test Waveforms.

Radar Type	Pulse Width (µsec)	PRI (µsec)	Number of Pulses	Pass times	Fail times	Percentage of Successful Detection (%)
1	1	Test A: 15 unique PRI values randomly selected from the list of 23 PRI values in Table 5a Test B: 15 unique PRI values randomly selected within the range of 518-3066 µsec, with a minimum increment of 1 µsec, excluding PRI values selected in Test A	$\text{Roundup} \left\{ \begin{array}{l} \left(\frac{1}{360} \right) \\ \left(\frac{19 \cdot 10^6}{\text{PRI}_{\mu\text{sec}}} \right) \end{array} \right\}$	27	3	90
2	1-5	150-230	23-29	26	4	87
3	6-10	200-500	16-18	27	3	90
4	11-20	200-500	12-16	27	3	90
Aggregate (Radar Types 1-4)			-	107	13	89

Table 2: Long Pulse Radar Test Waveform

Radar Type	Pulse Width (µsec)	Chirp Width (MHz)	PRI (µsec)	Number of Pulses Per Burst	Number of Bursts	Pass times	Fail times	Percentage of Successful Detection (%)
5	50-100	5-20	1000-2000	1-3	8-20	28	2	93

Table 3: Frequency Hopping Radar Test Waveform

Radar Type	Pulse Width (µsec)	PRI (µsec)	Pulses per Hop	Hopping Rate (kHz)	Hopping Sequence Length (msec)	Pass times	Fail times	Percentage of Successful Detection (%)
6	1	333	9	0.333	300	27	3	90

TX (11a Mode)

Radar signal 0

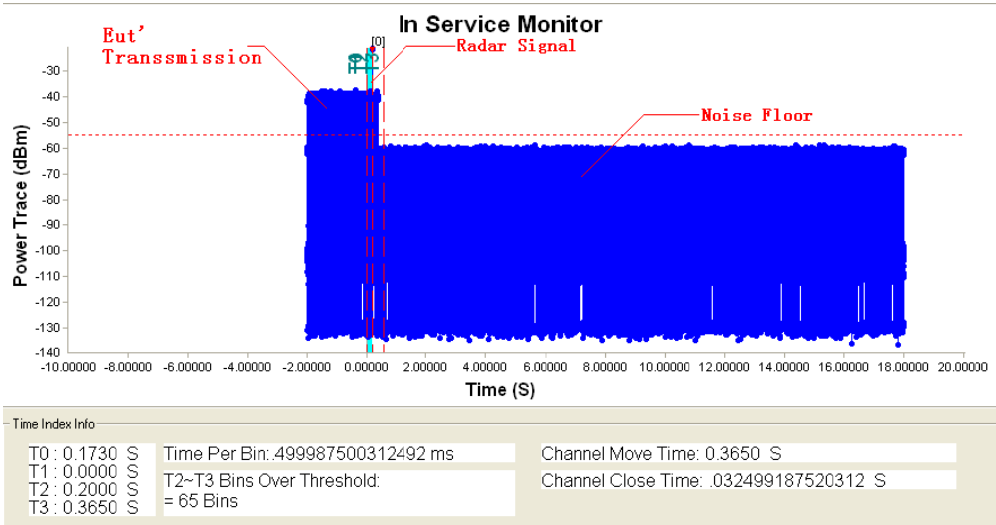

Note: T0 denotes the start of Channel Move Time upon the end of the last Radar burst.
 T1 denotes the data transmission time of 200ms from T0.
 T2 denotes the end of Channel Move Time.
 T3 denotes the 10 second from T0 to observe the aggregate duration of transmissions.

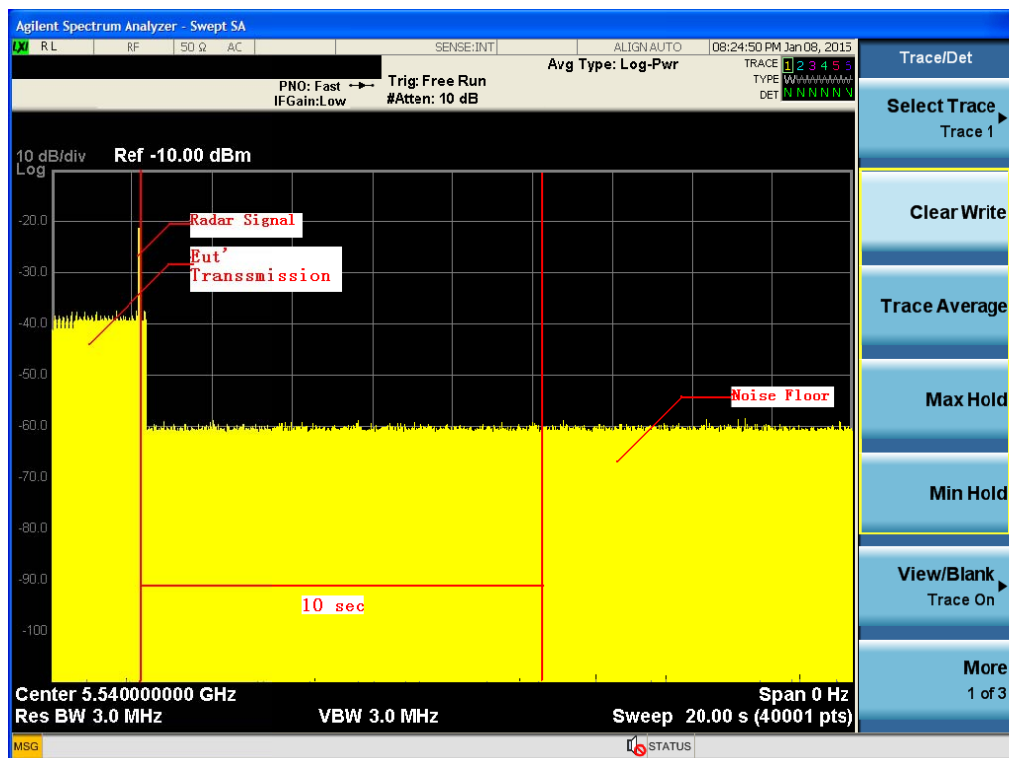

Note: An expanded plot for the device vacates the channel in the required 500ms

TX (11a Mode)

Radar1 Statical Performances				
Trial #	Pluse per Burst	Pluse Width(us)	PRI(us)	Detection(YES / No)
1	68	1.0u	778	YES
2	58	1.0u	918	YES
3	76	1.0u	698	YES
4	18	1.0u	3066	NO
5	81	1.0u	658	YES
6	76	1.0u	698	YES
7	59	1.0u	898	YES
8	65	1.0u	818	YES
9	18	1.0u	3066	NO
10	95	1.0u	558	YES
11	61	1.0u	878	YES
12	74	1.0u	718	YES
13	76	1.0u	698	YES
14	59	1.0u	898	YES
15	86	1.0u	618	YES
16	26	1.0u	2043	YES
17	52	1.0u	1026	YES
18	47	1.0u	1140	YES
19	18	1.0u	2995	YES
20	20	1.0u	2761	YES
21	30	1.0u	1817	YES
22	24	1.0u	2273	YES
23	22	1.0u	2421	YES
24	81	1.0u	656	YES
25	55	1.0u	969	YES
26	22	1.0u	2501	YES
27	46	1.0u	1168	YES
28	52	1.0u	1018	NO
29	19	1.0u	2880	YES
30	31	1.0u	1739	YES
Detection Rate :				90 %

Radar2 Statical Performances				
Trial #	Pluse per Burst	Pluse Width(us)	PRI(us)	Detection(YES / No)
1	24	3.4	173	YES
2	29	4.8	182	YES
3	29	2.4	211	YES
4	26	1.8	168	YES
5	25	2.6	175	NO
6	29	4.1	185	YES
7	23	1.3	156	YES
8	24	2.2	154	YES
9	26	4	199	NO
10	23	4.7	217	YES
11	25	3.7	161	YES
12	29	1.3	170	YES
13	29	1.4	159	YES
14	25	3.9	193	NO
15	27	1.2	159	YES
16	24	1.4	174	YES
17	25	2.6	180	YES
18	29	2.4	158	YES
19	25	3.7	208	YES
20	27	3.2	177	YES
21	23	2.6	172	YES
22	25	1.1	172	YES
23	29	1.6	183	YES
24	28	3.1	188	YES
25	29	3.8	230	YES
26	29	4.8	213	YES
27	25	2.1	198	YES
28	24	2.9	211	NO
29	25	2.2	213	YES
30	24	2	221	YES
				Detection Rate 87%

Radar3 Statical Performances				
Trial #	Pluse per Burst	Pluse Width(s)	PRI(us)	Detection(YES / No)
1	16	9.8	408	YES
2	17	9.5	390	YES
3	18	8.9	303	YES
4	16	6.5	346	YES
5	16	8.2	375	YES
6	16	9.7	419	YES
7	18	8.3	306	YES
8	17	6.8	391	YES
9	18	6.3	439	NO
10	16	9.6	327	YES
11	16	10	262	YES
12	18	6.5	343	YES
13	16	6.9	496	YES
14	17	9.4	412	NO
15	16	8.6	416	YES
16	18	6.1	336	YES
17	18	7.9	315	YES
18	18	7.4	320	YES
19	18	6.7	334	YES
20	18	8.2	500	YES
21	16	7.9	499	YES
22	16	7.7	268	NO
23	16	7.7	496	YES
24	16	8.7	287	YES
25	16	7.1	434	YES
26	18	9.4	250	YES
27	16	6	290	YES
28	18	7.7	470	YES
29	17	8.8	488	YES
30	17	6.3	478	YES
				Detection Rate 90%

Radar4 Statical Performances				
Trial #	Pluse per Burst	Pluse Width(us)	PRI(us)	Detection(YES / No)
1	12	18.2	474	YES
2	12	19.1	274	YES
3	14	15.7	288	YES
4	16	16.7	376	YES
5	15	15.3	392	YES
6	15	17.1	361	NO
7	15	17.8	303	YES
8	12	17.8	313	YES
9	13	12.7	252	YES
10	13	11.9	290	YES
11	14	11.5	472	YES
12	16	19.8	431	YES
13	16	19.8	431	NO
14	13	19.9	447	YES
15	16	15.5	439	YES
16	14	14.9	263	YES
17	16	17.7	297	YES
18	15	14.2	449	YES
19	13	11.7	253	YES
20	13	16.1	428	YES
21	14	11.7	427	NO
22	15	18.4	472	YES
23	15	20	254	YES
24	15	11.3	474	YES
25	14	17.5	343	YES
26	13	18.8	291	YES
27	14	19.6	394	YES
28	13	19.1	367	YES
29	114	18.8	441	YES
30	15	16.5	326	YES
				Detection Rate 90%

Radar5 Statical Performances		
Trial #	Test Signal name	Detection(YES / No)
1	LP_Signal_01	YES
2	LP_Signal_02	YES
3	LP_Signal_03	YES
4	LP_Signal_04	YES
5	LP_Signal_05	YES
6	LP_Signal_06	YES
7	LP_Signal_07	YES
8	LP_Signal_08	NO
9	LP_Signal_09	YES
10	LP_Signal_10	YES
11	LP_Signal_11	YES
12	LP_Signal_12	YES
13	LP_Signal_13	YES
14	LP_Signal_14	YES
15	LP_Signal_15	YES
16	LP_Signal_16	YES
17	LP_Signal_17	YES
18	LP_Signal_18	NO
19	LP_Signal_19	YES
20	LP_Signal_20	YES
21	LP_Signal_21	YES
22	LP_Signal_22	YES
23	LP_Signal_23	YES
24	LP_Signal_24	YES
25	LP_Signal_25	YES
26	LP_Signal_26	YES
27	LP_Signal_27	YES
28	LP_Signal_28	YES
29	LP_Signal_29	YES
30	LP_Signal_30	YES
		Detection Rate 93%

Radar6 Statical Performances		
Trial #	Hoping Frequency Sequence Name	Detection(YES / No)
1	HOP_FREQ_SEQ_01	YES
2	HOP_FREQ_SEQ_02	YES
3	HOP_FREQ_SEQ_03	YES
4	HOP_FREQ_SEQ_04	YES
5	HOP_FREQ_SEQ_05	NO
6	HOP_FREQ_SEQ_06	YES
7	HOP_FREQ_SEQ_07	YES
8	HOP_FREQ_SEQ_08	YES
9	HOP_FREQ_SEQ_09	YES
10	HOP_FREQ_SEQ_10	YES
11	HOP_FREQ_SEQ_11	YES
12	HOP_FREQ_SEQ_12	NO
13	HOP_FREQ_SEQ_13	YES
14	HOP_FREQ_SEQ_14	YES
15	HOP_FREQ_SEQ_15	YES
16	HOP_FREQ_SEQ_16	YES
17	HOP_FREQ_SEQ_17	YES
18	HOP_FREQ_SEQ_18	YES
19	HOP_FREQ_SEQ_19	YES
20	HOP_FREQ_SEQ_20	YES
21	HOP_FREQ_SEQ_21	YES
22	HOP_FREQ_SEQ_22	YES
23	HOP_FREQ_SEQ_23	YES
24	HOP_FREQ_SEQ_24	YES
25	HOP_FREQ_SEQ_25	NO
26	HOP_FREQ_SEQ_26	YES
27	HOP_FREQ_SEQ_27	YES
28	HOP_FREQ_SEQ_28	YES
29	HOP_FREQ_SEQ_29	YES
30	HOP_FREQ_SEQ_30	YES
		Detection Rate 90%

TX (11n 40MHz Mode)

Table 1: Short Pulse Radar Test Waveforms.

Radar Type	Pulse Width (µsec)	PRI (µsec)	Number of Pulses	Pass times	Fail times	Percentage of Successful Detection (%)
1	1	Test A: 15 unique PRI values randomly selected from the list of 23 PRI values in Table 5a <hr/> Test B: 15 unique PRI values randomly selected within the range of 518-3066 µsec, with a minimum increment of 1 µsec, excluding PRI values selected in Test A	$\text{Roundup} \left(\frac{1}{360} \cdot \frac{19 \cdot 10^6}{\text{PRI}_{\mu\text{sec}}} \right)$	28	2	93
2	1-5	150-230	23-29	27	3	90
3	6-10	200-500	16-18	27	3	90
4	11-20	200-500	12-16	28	2	93
Aggregate (Radar Types 1-4)			-	110	10	92

Table 2: Long Pulse Radar Test Waveform

Radar Type	Pulse Width (µsec)	PRI (µsec)	Pulses per Hop	Hopping Rate (kHz)	Hopping Sequence Length (msec)	Pass times	Fail times	Percentage of Successful Detection (%)
5	1	333	9	0.333	300	28	2	93

Table 3: Frequency Hopping Radar Test Waveform

Radar Type	Pulse Width (µsec)	PRI (µsec)	Pulses per Hop	Hopping Rate (kHz)	Hopping Sequence Length (msec)	Pass times	Fail times	Percentage of Successful Detection (%)
6	1	333	9	0.333	300	28	2	93

TX (11n 40MHz Mode)

Radar signal 0

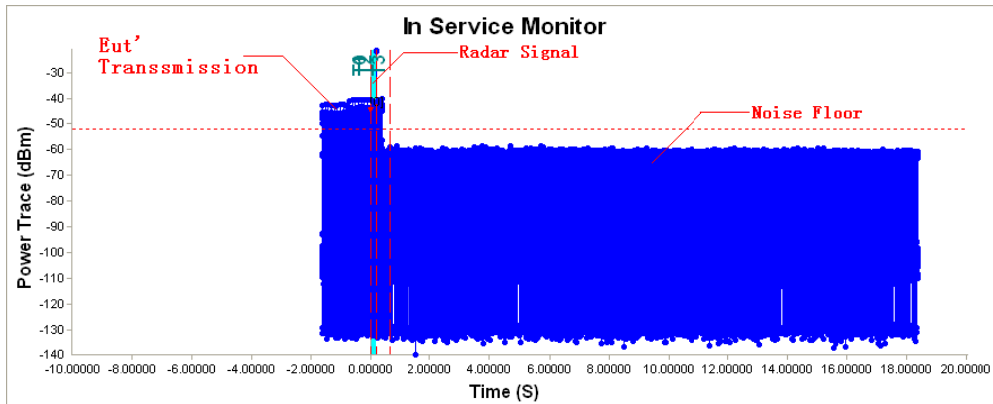

Time Index Info		
T0 : 0.1735 S	Time Per Bin: 499987500312492 ms	Channel Move Time: 0.8500 S
T1 : 0.0000 S	T2~T3 Bins Over Threshold: = 124 Bins	Channel Close Time: .061998450038749 S
T2 : 0.2000 S		
T3 : 0.8500 S		

Note: T0 denotes the start of Channel Move Time upon the end of the last Radar burst.
 T1 denotes the data transmission time of 200ms from T0.
 T2 denotes the end of Channel Move Time.
 T3 denotes the 10 second from T0 to observe the aggregate duration of transmissions.

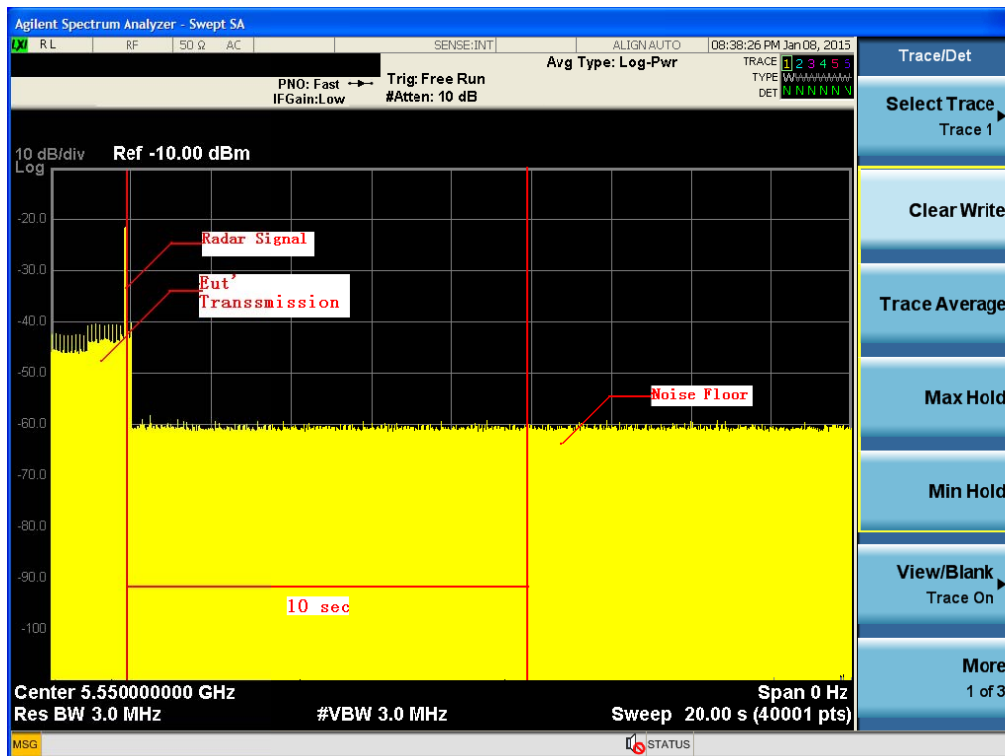

Note: An expanded plot for the device vacates the channel in the required 500ms

TX (11n 40MHz Mode)

Radar1 Static Performances				
Trial #	Pluse per Burst	Pluse Width(us)	PRI(us)	Detection(YES / No)
1	76	1.0u	698	YES
2	86	1.0u	618	YES
3	83	1.0u	638	YES
4	57	1.0u	938	YES
5	76	1.0u	698	YES
6	68	1.0u	778	YES
7	99	1.0u	538	YES
8	99	1.0u	538	YES
9	74	1.0u	718	YES
10	102	1.0u	518	YES
11	70	1.0u	758	YES
12	76	1.0u	698	YES
13	74	1.0u	718	YES
14	89	1.0u	598	YES
15	102	1.0u	518	NO
16	22	1.0u	2457	YES
17	53	1.0u	1002	YES
18	19	1.0u	2783	YES
19	24	1.0u	2227	YES
20	19	1.0u	2848	YES
21	26	1.0u	2036	YES
22	21	1.0u	2579	YES
23	44	1.0u	1209	NO
24	66	1.0u	810	YES
25	18	1.0u	2986	YES
26	28	1.0u	1913	YES
27	69	1.0u	768	YES
28	42	1.0u	1263	YES
29	27	1.0u	1988	YES
30	19	1.0u	2853	YES
Detection Rate 93%				

Radar2 Statical Performances				
Trial #	Pluse per Burst	Pluse Width(us)	PRI(us)	Detection(YES / No)
1	29	1.3	162	YES
2	28	2.5	219	YES
3	27	1.3	203	YES
4	23	2.3	172	YES
5	29	4.1	184	YES
6	25	4.5	190	YES
7	26	2.1	220	YES
8	24	1.5	204	YES
9	29	5	167	YES
10	28	1.5	174	YES
11	29	1.1	199	YES
12	25	3.8	185	NO
13	28	2.2	207	YES
14	29	3.6	229	YES
15	24	4.9	227	YES
16	23	1.6	197	YES
17	25	4.7	205	YES
18	23	2	203	YES
19	28	1.6	222	YES
20	27	1.3	194	NO
21	26	3.8	183	YES
22	29	3.7	154	YES
23	25	3.9	221	NO
24	28	3.1	175	YES
25	29	2.7	222	YES
26	23	3.7	160	YES
27	27	4.8	175	YES
28	23	2	218	YES
29	24	1.5	169	YES
30	26	1.4	192	YES
Detection Rate 90%				

Radar3 Statical Performances				
Trial #	Pluse per Burst	Pluse Width(s)	PRI(us)	Detection(YES / No)
1	18	8.5u	445	YES
2	17	8.0u	442	YES
3	17	8.6u	414	YES
4	17	8.4u	409	YES
5	16	9.3u	398	YES
6	16	8.0u	364	YES
7	16	9.6u	386	YES
8	16	8.0u	258	YES
9	16	8.8u	445	YES
10	17	7.6u	310	YES
11	17	7.9u	481	YES
12	16	8.0u	268	YES
13	18	9.9u	463	YES
14	17	8.6u	225	YES
15	18	8.2u	477	YES
16	17	8.7u	240	YES
17	17	9.0u	213	YES
18	16	9.8u	480	YES
19	16	7.9u	436	YES
20	16	9.3u	269	YES
21	16	7.2u	431	YES
22	17	7.2u	330	YES
23	17	6.9u	452	YES
24	18	6.0u	488	YES
25	16	8.3u	388	YES
26	17	8.2u	443	YES
27	17	6.6u	408	YES
28	16	8.8u	350	YES
29	18	9.5u	480	YES
30	16	9.8u	216	NO
Detection Rate 90%				

Radar4 Statical Performances				
Trial #	Pluse per Burst	Pluse Width(us)	PRI(us)	Detection(YES / No)
1	14	17.5u	405	YES
2	16	15.0u	463	YES
3	13	13.6u	330	YES
4	14	14.4u	410	YES
5	16	15.3u	398	YES
6	15	14.0u	365	YES
7	13	15.3u	367	NO
8	14	11.7u	319	YES
9	13	19.8u	274	YES
10	15	16.0u	377	YES
11	13	16.6u	463	YES
12	12	12.5u	445	YES
13	13	12.0u	445	YES
14	13	13.8u	405	YES
15	13	14.9u	409	YES
16	15	15.8u	436	YES
17	12	14.8u	447	YES
18	15	13.9u	400	YES
19	12	16.0u	481	YES
20	12	17.0u	496	YES
21	12	15.8u	463	YES
22	13	14.6u	445	YES
23	16	17.0u	442	NO
24	12	14.0u	485	YES
25	13	14.0u	260	YES
26	16	15.6u	280	YES
27	15	17.0u	450	YES
28	13	19.3u	330	YES
29	13	18.5u	470	YES
30	13	20.0u	335	YES
Detection Rate 93%				

Radar5 Statical Performances		
Trial #	Test Signal name	Detection(YES / No)
1	LP_Signal_01	YES
2	LP_Signal_02	YES
3	LP_Signal_03	YES
4	LP_Signal_04	YES
5	LP_Signal_05	YES
6	LP_Signal_06	YES
7	LP_Signal_07	YES
8	LP_Signal_08	YES
9	LP_Signal_09	YES
10	LP_Signal_10	NO
11	LP_Signal_11	YES
12	LP_Signal_12	YES
13	LP_Signal_13	YES
14	LP_Signal_14	YES
15	LP_Signal_15	YES
16	LP_Signal_16	YES
17	LP_Signal_17	YES
18	LP_Signal_18	YES
19	LP_Signal_19	YES
20	LP_Signal_20	YES
21	LP_Signal_21	YES
22	LP_Signal_22	YES
23	LP_Signal_23	NO
24	LP_Signal_24	YES
25	LP_Signal_25	YES
26	LP_Signal_26	YES
27	LP_Signal_27	YES
28	LP_Signal_28	YES
29	LP_Signal_29	YES
30	LP_Signal_30	YES
Detection Rate 93%		

Radar6 Statical Performances		
Trial #	Hoping Frequency Sequence Name	Detection(YES / No)
1	HOP_FREQ_SEQ_01	YES
2	HOP_FREQ_SEQ_02	YES
3	HOP_FREQ_SEQ_03	YES
4	HOP_FREQ_SEQ_04	YES
5	HOP_FREQ_SEQ_05	NO
6	HOP_FREQ_SEQ_06	YES
7	HOP_FREQ_SEQ_07	YES
8	HOP_FREQ_SEQ_08	YES
9	HOP_FREQ_SEQ_09	YES
10	HOP_FREQ_SEQ_10	YES
11	HOP_FREQ_SEQ_11	YES
12	HOP_FREQ_SEQ_12	YES
13	HOP_FREQ_SEQ_13	YES
14	HOP_FREQ_SEQ_14	YES
15	HOP_FREQ_SEQ_15	NO
16	HOP_FREQ_SEQ_16	YES
17	HOP_FREQ_SEQ_17	YES
18	HOP_FREQ_SEQ_18	YES
19	HOP_FREQ_SEQ_19	YES
20	HOP_FREQ_SEQ_20	YES
21	HOP_FREQ_SEQ_21	YES
22	HOP_FREQ_SEQ_22	YES
23	HOP_FREQ_SEQ_23	YES
24	HOP_FREQ_SEQ_24	YES
25	HOP_FREQ_SEQ_25	YES
26	HOP_FREQ_SEQ_26	YES
27	HOP_FREQ_SEQ_27	YES
28	HOP_FREQ_SEQ_28	YES
29	HOP_FREQ_SEQ_29	YES
30	HOP_FREQ_SEQ_30	YES
Detection Rate 93%		

TX (11ac 80MHz Mode)

Table 1: Short Pulse Radar Test Waveforms.

Radar Type	Pulse Width (µsec)	PRI (µsec)	Number of Pulses	Pass times	Fail times	Percentage of Successful Detection (%)
1	1	Test A: 15 unique PRI values randomly selected from the list of 23 PRI values in Table 5a <hr/> Test B: 15 unique PRI values randomly selected within the range of 518-3066 µsec, with a minimum increment of 1 µsec, excluding PRI values selected in Test A	$\text{Roundup} \left(\frac{1}{360} \cdot \frac{19 \cdot 10^6}{\text{PRI}_{\mu\text{sec}}} \right)$	27	3	90
2	1-5	150-230	23-29	26	4	87
3	6-10	200-500	16-18	27	3	90
4	11-20	200-500	12-16	27	3	90
Aggregate (Radar Types 1-4)			-	107	13	89

Table 2: Long Pulse Radar Test Waveform

Radar Type	Pulse Width (µsec)	Chirp Width (MHz)	PRI (µsec)	Number of Pulses Per Burst	Number of Bursts	Pass times	Fail times	Percentage of Successful Detection (%)
5	50-100	5-20	1000-2000	1-3	8-20	28	2	93

Table 3: Frequency Hopping Radar Test Waveform

Radar Type	Pulse Width (µsec)	PRI (µsec)	Pulses per Hop	Hopping Rate (kHz)	Hopping Sequence Length (msec)	Pass times	Fail times	Percentage of Successful Detection (%)
6	1	333	9	0.333	300	28	2	93

TX (11ac 80MHz Mode)
 Radar signal 0

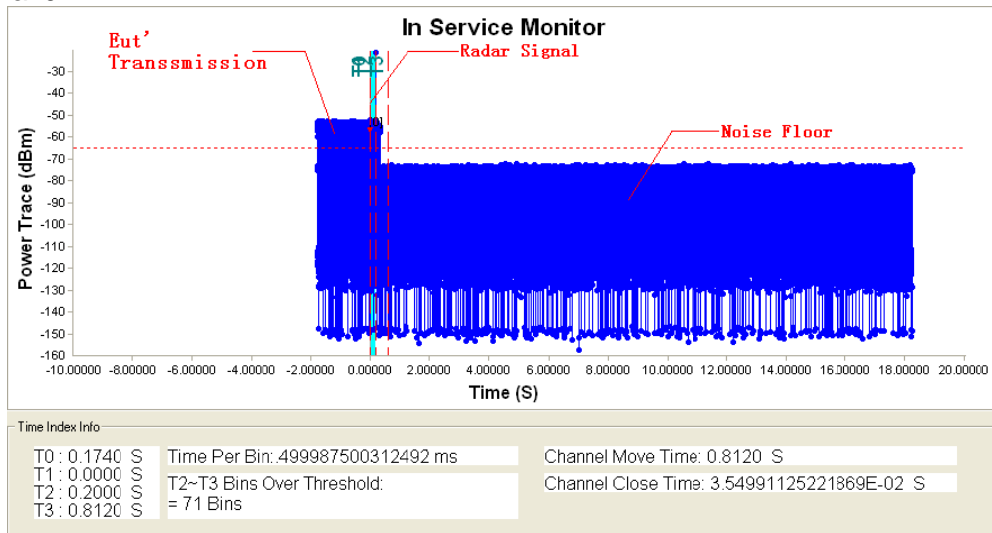

Note: T0 denotes the start of Channel Move Time upon the end of the last Radar burst.
 T1 denotes the data transmission time of 200ms from T0.
 T2 denotes the end of Channel Move Time.
 T3 denotes the 10 second from T0 to observe the aggregate duration of transmissions.

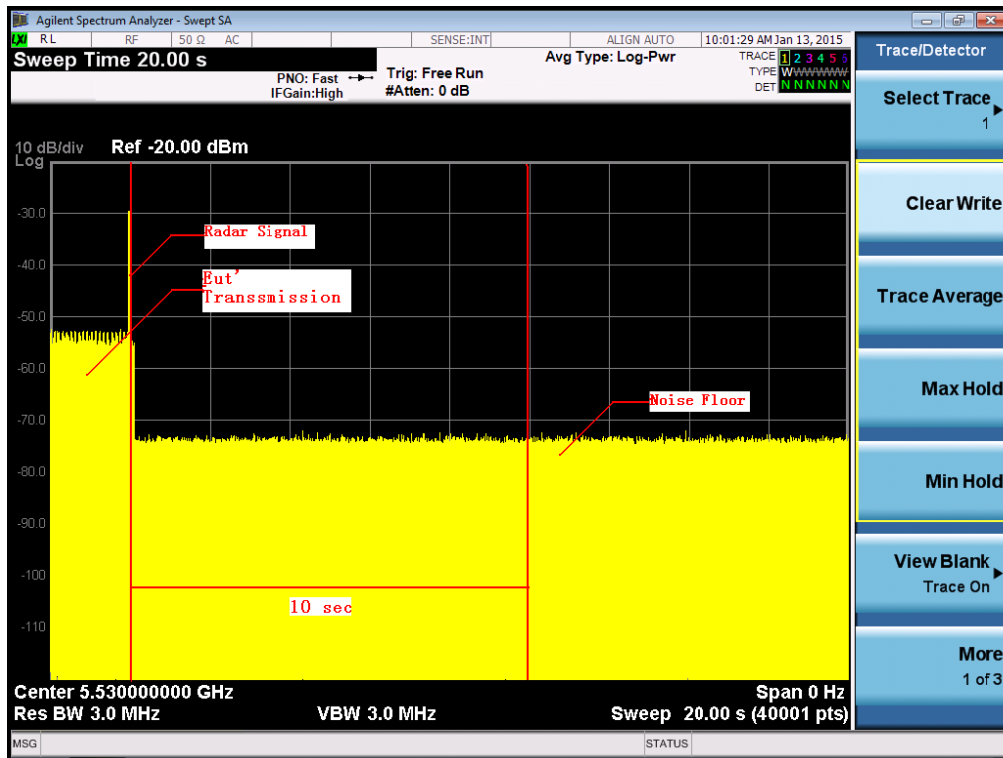

Note: An expanded plot for the device vacates the channel in the required 500ms

TX (11n 40MHz Mode)

Radar1 Static Performances				
Trial #	Pluse per Burst	Pluse Width(us)	PRI(us)	Detection(YES / No)
1	89	1.0u	598	YES
2	74	1.0u	718	YES
3	92	1.0u	578	YES
4	76	1.0u	698	YES
5	18	1.0u	3066	YES
6	62	1.0u	858	YES
7	18	1.0u	3066	NO
8	81	1.0u	658	YES
9	18	1.0u	3066	YES
10	83	1.0u	638	YES
11	99	1.0u	538	YES
12	76	1.0u	698	YES
13	92	1.0u	578	YES
14	63	1.0u	838	YES
15	58	1.0u	918	YES
16	27	1.0u	1988	NO
17	18	1.0u	3043	YES
18	38	1.0u	1393	YES
19	34	1.0u	1589	YES
20	23	1.0u	2308	YES
21	25	1.0u	2133	YES
22	34	1.0u	1582	YES
23	48	1.0u	1112	YES
24	53	1.0u	1005	YES
25	30	1.0u	1772	YES
26	21	1.0u	2598	NO
27	23	1.0u	2377	YES
28	41	1.0u	1292	YES
29	70	1.0u	763	YES
30	89	1.0u	598	YES
Detection Rate 90%				

Radar2 Statical Performances				
Trial #	Pluse per Burst	Pluse Width(us)	PRI(us)	Detection(YES / No)
1	27	1.9	225	YES
2	29	2.2	178	YES
3	27	1	174	YES
4	25	3.2	208	NO
5	25	3.2	185	YES
6	24	1.6	176	YES
7	29	1	181	YES
8	27	2.7	180	NO
9	26	2.6	166	YES
10	26	4.3	153	YES
11	26	1.8	229	YES
12	23	4.8	204	YES
13	23	1.4	216	YES
14	27	2.2	171	YES
15	23	2.5	173	YES
16	27	1.1	162	NO
17	28	2.3	173	YES
18	28	2.2	180	YES
19	23	3.6	164	YES
20	28	4.1	188	YES
21	24	4.6	219	YES
22	24	2.9	229	YES
23	28	2.4	201	YES
24	27	4.9	191	YES
25	25	3.7	160	YES
26	24	4.1	204	YES
27	27	1.9	200	NO
28	29	4.2	202	YES
29	25	1.9	154	YES
30	28	3.3	229	YES
Detection Rate 87%				

Radar3 Statical Performances				
Trial #	Pluse per Burst	Pluse Width(s)	PRI(us)	Detection(YES / No)
1	16	9.4	486	YES
2	16	6.8	282	YES
3	18	8.9	263	YES
4	17	8.2	433	YES
5	17	6.7	279	YES
6	16	7.1	492	YES
7	16	10	386	NO
8	18	6.1	304	YES
9	18	9.8	355	YES
10	17	6.7	388	YES
11	18	7.8	304	YES
12	16	6.1	491	YES
13	16	8.1	314	YES
14	17	9.5	293	YES
15	16	6.6	428	YES
16	17	7	330	YES
17	17	6.6	437	NO
18	16	9.4	419	YES
19	18	9.3	352	YES
20	18	6.4	412	YES
21	16	6.5	474	YES
22	17	7.7	344	YES
23	17	7.1	277	YES
24	17	9.4	438	YES
25	16	8.1	307	YES
26	17	9.4	379	YES
27	16	6.8	386	NO
28	17	6.6	276	YES
29	17	6.2	464	YES
30	18	7.7	470	YES
Detection Rate 90%				

Radar4 Statical Performances				
Trial #	Pluse per Burst	Pluse Width(us)	PRI(us)	Detection(YES / No)
1	13	15.6	419	YES
2	12	17.2	500	YES
3	14	15.1	388	YES
4	15	15	494	YES
5	15	15.2	411	YES
6	14	14.8	447	YES
7	15	14.8	252	NO
8	13	11.2	495	YES
9	13	13.8	264	YES
10	13	11.5	410	YES
11	16	17.2	426	YES
12	14	16.3	474	YES
13	16	19	344	YES
14	13	16.6	440	YES
15	16	18.2	457	YES
16	12	18.2	401	NO
17	13	12.1	478	YES
18	12	17.4	367	YES
19	16	17.6	432	YES
20	12	12.1	394	YES
21	14	19.2	373	YES
22	13	12.9	363	YES
23	16	11.3	263	YES
24	15	14.5	382	YES
25	15	12.8	372	YES
26	15	13.1	291	YES
27	13	12.5	432	YES
28	12	18.8	301	YES
29	15	12.1	308	NO
30	15	11.1	407	YES
Detection Rate 90%				

Radar5 Statical Performances		
Trial #	Test Signal name	Detection(YES / No)
1	LP_Signal_01	YES
2	LP_Signal_02	YES
3	LP_Signal_03	YES
4	LP_Signal_04	YES
5	LP_Signal_05	YES
6	LP_Signal_06	YES
7	LP_Signal_07	YES
8	LP_Signal_08	YES
9	LP_Signal_09	YES
10	LP_Signal_10	YES
11	LP_Signal_11	YES
12	LP_Signal_12	YES
13	LP_Signal_13	NO
14	LP_Signal_14	YES
15	LP_Signal_15	YES
16	LP_Signal_16	YES
17	LP_Signal_17	YES
18	LP_Signal_18	YES
19	LP_Signal_19	YES
20	LP_Signal_20	YES
21	LP_Signal_21	YES
22	LP_Signal_22	YES
23	LP_Signal_23	YES
24	LP_Signal_24	NO
25	LP_Signal_25	YES
26	LP_Signal_26	YES
27	LP_Signal_27	YES
28	LP_Signal_28	YES
29	LP_Signal_29	YES
30	LP_Signal_30	YES
Detection Rate 93%		

Radar6 Statical Performances		
Trial #	Hoping Frequency Sequence Name	Detection(YES / No)
1	HOP_FREQ_SEQ_01	YES
2	HOP_FREQ_SEQ_02	YES
3	HOP_FREQ_SEQ_03	YES
4	HOP_FREQ_SEQ_04	YES
5	HOP_FREQ_SEQ_05	YES
6	HOP_FREQ_SEQ_06	NO
7	HOP_FREQ_SEQ_07	YES
8	HOP_FREQ_SEQ_08	YES
9	HOP_FREQ_SEQ_09	YES
10	HOP_FREQ_SEQ_10	YES
11	HOP_FREQ_SEQ_11	YES
12	HOP_FREQ_SEQ_12	YES
13	HOP_FREQ_SEQ_13	YES
14	HOP_FREQ_SEQ_14	YES
15	HOP_FREQ_SEQ_15	YES
16	HOP_FREQ_SEQ_16	YES
17	HOP_FREQ_SEQ_17	YES
18	HOP_FREQ_SEQ_18	YES
19	HOP_FREQ_SEQ_19	YES
20	HOP_FREQ_SEQ_20	NO
21	HOP_FREQ_SEQ_21	YES
22	HOP_FREQ_SEQ_22	YES
23	HOP_FREQ_SEQ_23	YES
24	HOP_FREQ_SEQ_24	YES
25	HOP_FREQ_SEQ_25	YES
26	HOP_FREQ_SEQ_26	YES
27	HOP_FREQ_SEQ_27	YES
28	HOP_FREQ_SEQ_28	YES
29	HOP_FREQ_SEQ_29	YES
30	HOP_FREQ_SEQ_30	YES
Detection Rate 93%		

6.2.5 NON- OCCUPANCY PERIOD

During the 30 minutes observation time, UUT did not make any transmissions on a channel after a radar signal was detected on that channel by either the Channel Availability Check or the In-Service Monitoring.

5530 Non-Occupancy period

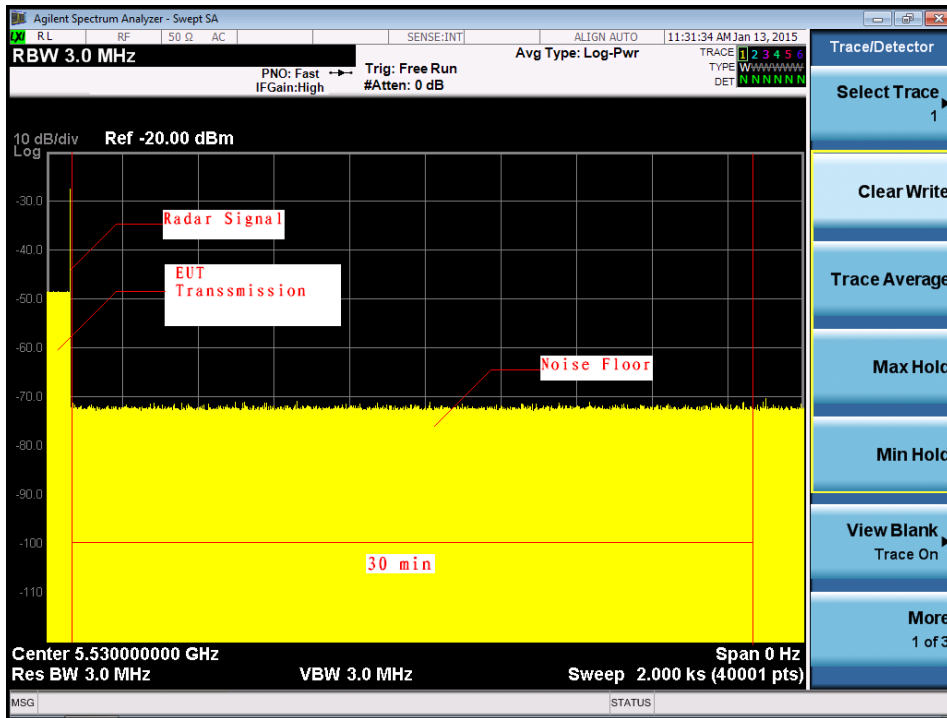

5540 Non-Occupancy period

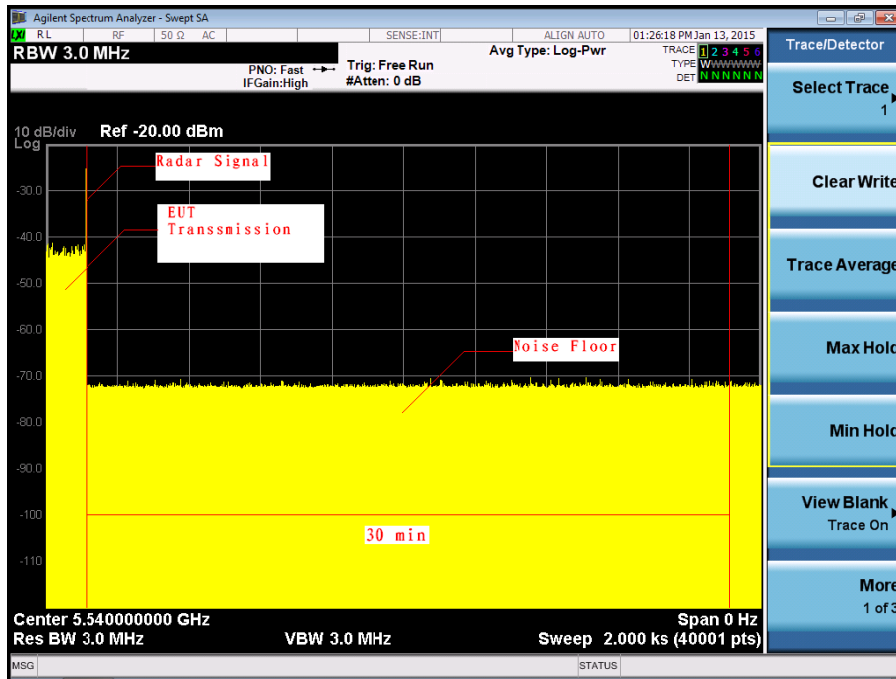

5550 Non-Occupancy period

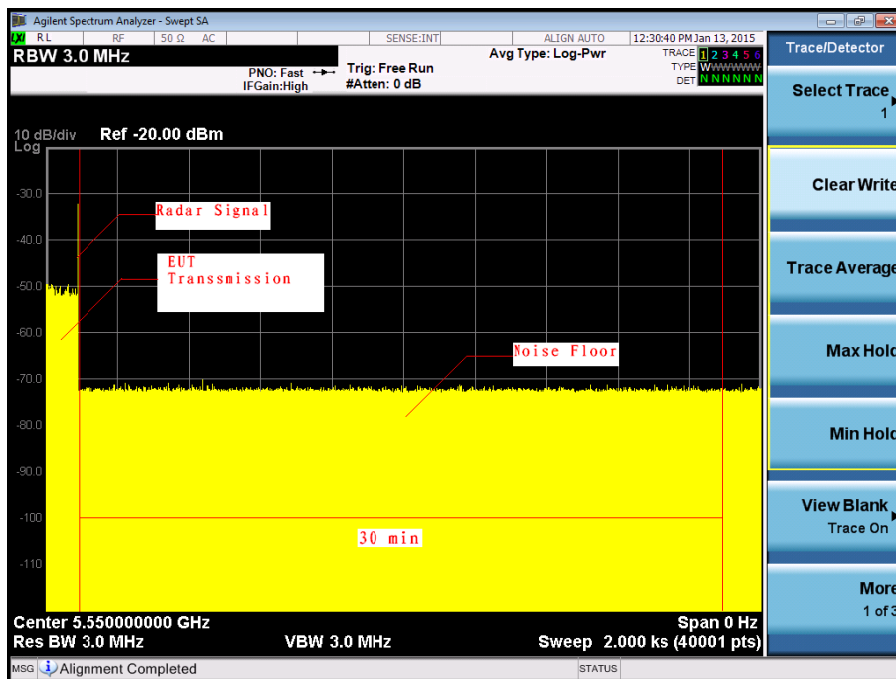

6.2.6 UNIFORM SPREADING

The intention of the uniform spreading is to provide, on aggregate, a uniform loading of the spectrum. The UUT using the bands 5250 to 5350MHz and 5470 to 5600 MHz channels so that the probability of selecting a given channel shall be the same for channels. The UUT will select channel by random mode and remember this channel when detect radar signal, so that will select unused channel by random mode.

6.2.7 U-NII DETECTION BANDWIDTH

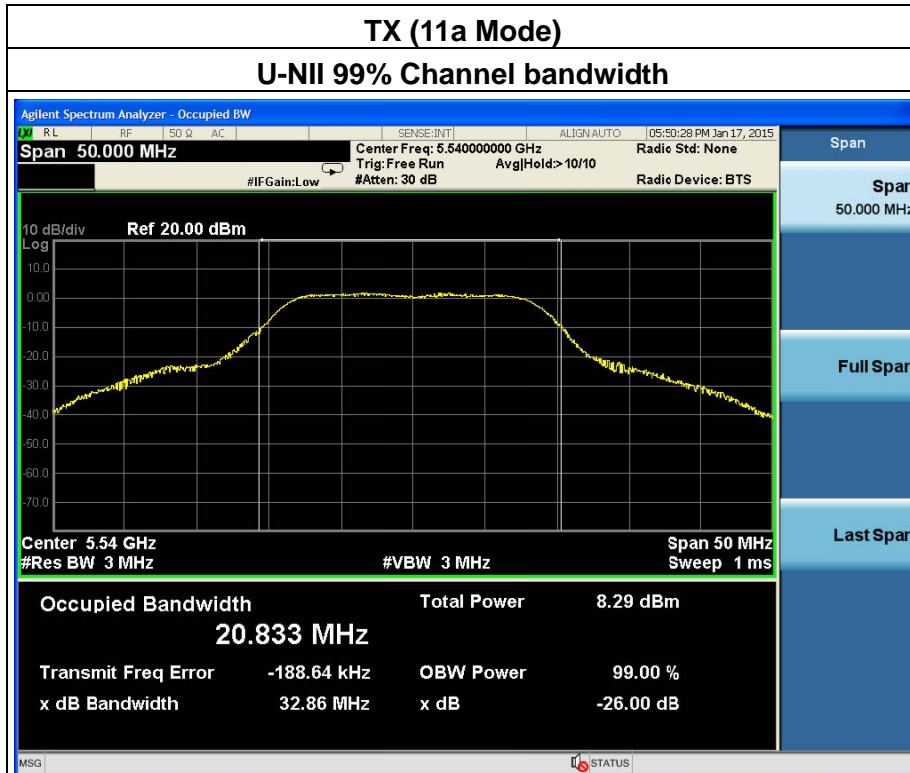

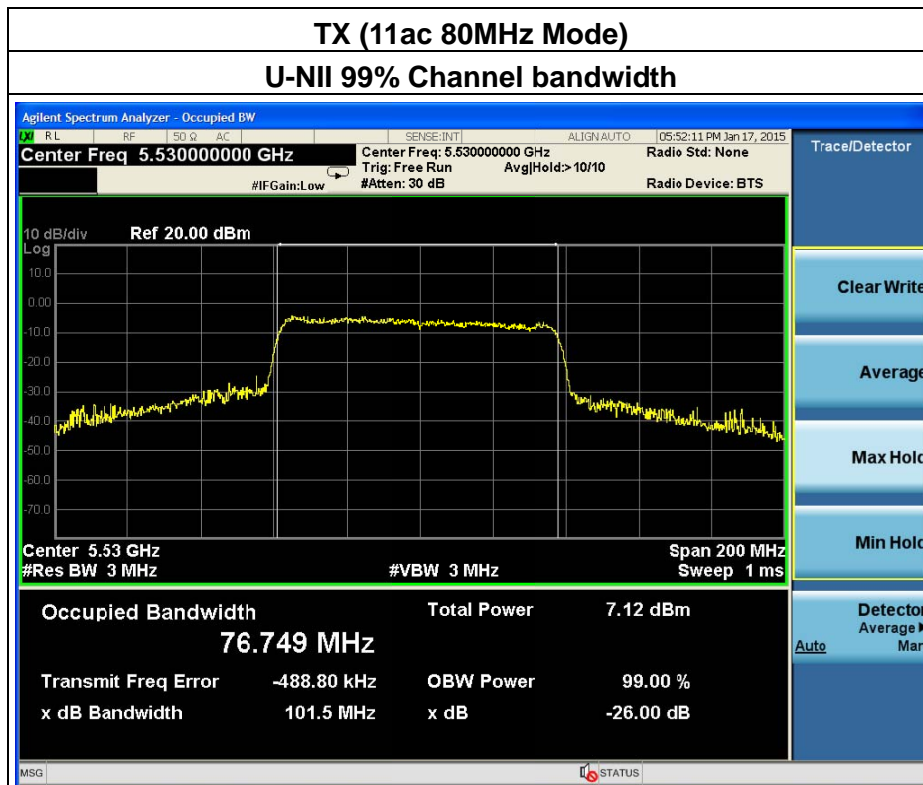
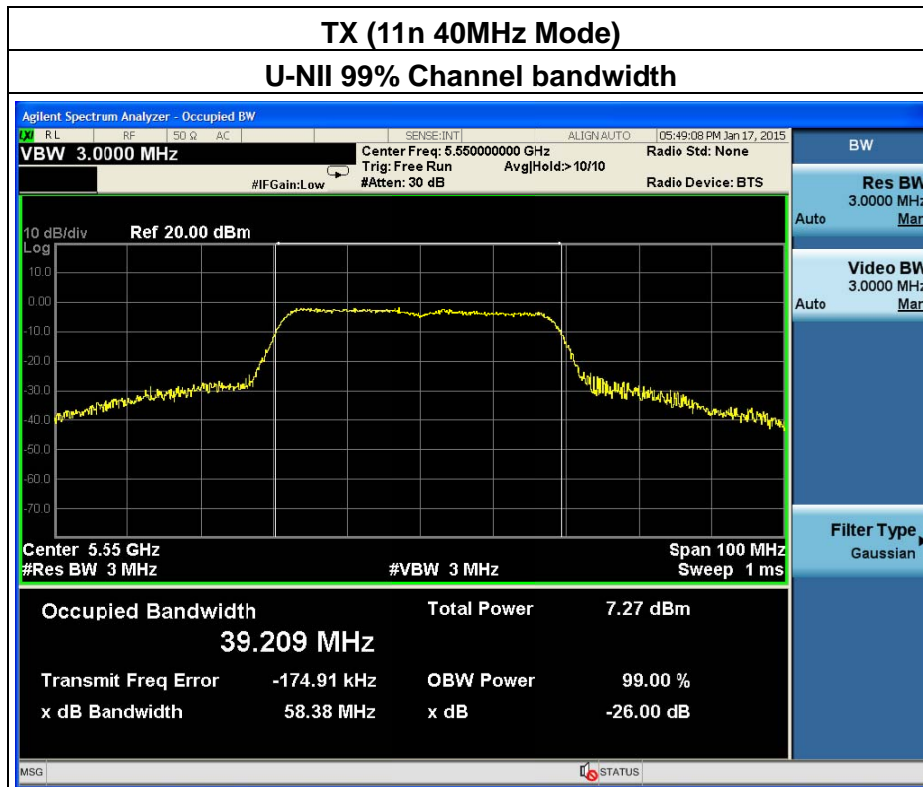

11a Mode

Detection Bandwith test transmission 20M											
EUT FREQUENCY	5540M										
EUT power bandwidth	20.83MHz										
Detection Bandwith limit(100%of EUT 99% Power bandwidth)	20.83										
Detection Bandwith(5549(FH)-5531(FL))	20										
Test Result	PASS										
Radar Freq (MHz)	DFS Detection Trials (1=Detection, 0= No Detection)										Detection Rate (%)
	1	2	3	4	5	6	7	8	9	10	
5529	1	0	0	1	1	0	0	0	1	1	50
5530	1	1	0	0	0	1	0	1	0	1	50
5531(FL)	1	1	1	1	1	1	1	1	1	1	100
5532	1	1	1	1	1	1	1	1	1	1	100
5533	1	1	1	1	1	1	1	1	1	1	100
5534	1	1	1	1	1	1	1	1	1	1	100
5535	1	1	1	1	1	1	1	1	1	1	100
5536	1	1	1	1	1	1	1	1	1	1	100
5537	1	1	1	1	1	1	1	1	1	1	100
5538	1	1	1	1	1	1	1	1	1	1	100
5539	1	1	1	1	1	1	1	1	1	1	100
5540	1	1	1	1	1	1	1	1	1	1	100
5541	1	1	1	1	1	1	1	1	1	1	100
5542	1	1	1	1	1	1	1	1	1	1	100
5543	1	1	1	1	1	1	1	1	1	1	100
5544	1	1	1	1	1	1	1	1	1	1	100
5545	1	1	1	1	1	1	1	1	1	1	100
5546	1	1	1	1	1	1	1	1	1	1	100
5547	1	1	1	1	1	1	1	1	1	1	100
5548	1	1	1	1	1	1	1	1	1	1	100
5549(FH)	1	1	1	1	1	1	1	1	1	1	100
5550	0	1	0	0	0	1	0	0	0	1	40
5551	1	0	1	0	0	0	1	0	1	1	50

11n 40MHz Mode

Detection Bandwidth test transmission		40M									
EUT FREQUENCY		5550M									
EUT power bandwidth		39.21MHz									
Detection Bandwidth limit(100%of EUT 99% Power bandwidth)		39.21									
Detection Bandwidth(5569(FH)-5531(FL))		40									
Test Result		PASS									
		DFS Detection Trials (1=Detection, 0= No Detection)									
Radar Freq (MHz)	1	2	3	4	5	6	7	8	9	10	Detection Rate (%)
5529	1	0	1	0	0	1	1	0	1	0	50
5530	1	1	1	0	1	0	1	0	1	0	60
5531(FL)	1	1	1	1	1	1	1	1	1	1	100
5532	1	1	1	1	1	1	1	1	1	1	100
5533	1	1	1	1	1	1	1	1	1	1	100
5534	1	1	1	1	1	1	1	1	1	1	100
5535	1	1	1	1	1	1	1	1	1	1	100
5536	1	1	1	1	1	1	1	1	1	1	100
5537	1	1	1	1	1	1	1	1	1	1	100
5538	1	1	1	1	1	1	1	1	1	1	100
5539	1	1	1	1	1	1	1	1	1	1	100
5540	1	1	1	1	1	1	1	1	1	1	100
5541	1	1	1	1	1	1	1	1	1	1	100
5542	1	1	1	1	1	1	1	1	1	1	100
5543	1	1	1	1	1	1	1	1	1	1	100
5544	1	1	1	1	1	1	1	1	1	1	100
5545	1	1	1	1	1	1	1	1	1	1	100
5546	1	1	1	1	1	1	1	1	1	1	100
5547	1	1	1	1	1	1	1	1	1	1	100
5548	1	1	1	1	1	1	1	1	1	1	100
5549	1	1	1	1	1	1	1	1	1	1	100
5550	1	1	1	1	1	1	1	1	1	1	100
5551	1	1	1	1	1	1	1	1	1	1	100
5552	1	1	1	1	1	1	1	1	1	1	100
5553	1	1	1	1	1	1	1	1	1	1	100
5554	1	1	1	1	1	1	1	1	1	1	100
5555	1	1	1	1	1	1	1	1	1	1	100
5556	1	1	1	1	1	1	1	1	1	1	100
5557	1	1	1	1	1	1	1	1	1	1	100
5558	1	1	1	1	1	1	1	1	1	1	100
5559	1	1	1	1	1	1	1	1	1	1	100
5560	1	1	1	1	1	1	1	1	1	1	100
5561	1	1	1	1	1	1	1	1	1	1	100
5562	1	1	1	1	1	1	1	1	1	1	100
5563	1	1	1	1	1	1	1	1	1	1	100
5564	1	1	1	1	1	1	1	1	1	1	100
5565	1	1	1	1	1	1	1	1	1	1	100
5566	1	1	1	1	1	1	1	1	1	1	100
5567	1	1	1	1	1	1	1	1	1	1	100
5568	1	1	1	1	1	1	1	1	1	1	100
5569(FL)	1	1	1	1	1	1	1	1	1	1	100
5570	1	0	1	1	0	1	0	0	1	0	50
5571	1	0	0	1	0	0	1	0	0	1	40

11ac 80MHz Mode

Detection Bandwidth test transmission		80M									
EUT FREQUENCY		5530M									
EUT power bandwidth		76.75									
Detection Bandwidth limit(100%of EUT 99% Power bandwidth)		76.75									
Detection Bandwidth(5570(FH)-5549(FL))		80									
Test Result	PASS										
	DFS Detection Trials (1=Detection, 0= No Detection)										
Radar Freq (MHz)	1	2	3	4	5	6	7	8	9	10	Detection Rate (%)
5489	1	0	0	0	1	0	1	0	0	0	30
5490	1	0	0	0	1	0	1	0	0	0	30
5491	1	0	0	0	1	0	1	0	0	0	30
5492(FL)	1	1	1	1	1	1	1	1	1	1	100
5493	1	1	1	1	1	1	1	1	1	1	100
5494	1	1	1	1	1	1	1	1	1	1	100
5495	1	1	1	1	1	1	1	1	1	1	100
5496	1	1	1	1	1	1	1	1	1	1	100
5497	1	1	1	1	1	1	1	1	1	1	100
5498	1	1	1	1	1	1	1	1	1	1	100
5499	1	1	1	1	1	1	1	1	1	1	100
5500	1	1	1	1	1	1	1	1	1	1	100
5501	1	1	1	1	1	1	1	1	1	1	100
5502	1	1	1	1	1	1	1	1	1	1	100
5503	1	1	1	1	1	1	1	1	1	1	100
5504	1	1	1	1	1	1	1	1	1	1	100
5505	1	1	1	1	1	1	1	1	1	1	100
5506	1	1	1	1	1	1	1	1	1	1	100
5507	1	1	1	1	1	1	1	1	1	1	100
5508	1	1	1	1	1	1	1	1	1	1	100
5509	1	1	1	1	1	1	1	1	1	1	100
5510	1	1	1	1	1	1	1	1	1	1	100
5511	1	1	1	1	1	1	1	1	1	1	100
5512	1	1	1	1	1	1	1	1	1	1	100
5513	1	1	1	1	1	1	1	1	1	1	100
5514	1	1	1	1	1	1	1	1	1	1	100
5515	1	1	1	1	1	1	1	1	1	1	100
5516	1	1	1	1	1	1	1	1	1	1	100
5517	1	1	1	1	1	1	1	1	1	1	100
5518	1	1	1	1	1	1	1	1	1	1	100
5519	1	1	1	1	1	1	1	1	1	1	100
5520	1	1	1	1	1	1	1	1	1	1	100
5521	1	1	1	1	1	1	1	1	1	1	100
5522	1	1	1	1	1	1	1	1	1	1	100
5523	1	1	1	1	1	1	1	1	1	1	100
5524	1	1	1	1	1	1	1	1	1	1	100
5525	1	1	1	1	1	1	1	1	1	1	100
5526	1	1	1	1	1	1	1	1	1	1	100
5527	1	1	1	1	1	1	1	1	1	1	100
5528	1	1	1	1	1	1	1	1	1	1	100
5529	1	1	1	1	1	1	1	1	1	1	100
5530	1	1	1	1	1	1	1	1	1	1	100
5531	1	1	1	1	1	1	1	1	1	1	100

5532	1	1	1	1	1	1	1	1	1	1	1	100
5533	1	1	1	1	1	1	1	1	1	1	1	100
5534	1	1	1	1	1	1	1	1	1	1	1	100
5535	1	1	1	1	1	1	1	1	1	1	1	100
5536	1	1	1	1	1	1	1	1	1	1	1	100
5537	1	1	1	1	1	1	1	1	1	1	1	100
5538	1	1	1	1	1	1	1	1	1	1	1	100
5539	1	1	1	1	1	1	1	1	1	1	1	100
5540	1	1	1	1	1	1	1	1	1	1	1	100
5541	1	1	1	1	1	1	1	1	1	1	1	100
5542	1	1	1	1	1	1	1	1	1	1	1	100
5543	1	1	1	1	1	1	1	1	1	1	1	100
5544	1	1	1	1	1	1	1	1	1	1	1	100
5545	1	1	1	1	1	1	1	1	1	1	1	100
5546	1	1	1	1	1	1	1	1	1	1	1	100
5547	1	1	1	1	1	1	1	1	1	1	1	100
5548	1	1	1	1	1	1	1	1	1	1	1	100
5549	1	1	1	1	1	1	1	1	1	1	1	100
5550	1	1	1	1	1	1	1	1	1	1	1	100
5551	1	1	1	1	1	1	1	1	1	1	1	100
5552	1	1	1	1	1	1	1	1	1	1	1	100
5553	1	1	1	1	1	1	1	1	1	1	1	100
5554	1	1	1	1	1	1	1	1	1	1	1	100
5555	1	1	1	1	1	1	1	1	1	1	1	100
5556	1	1	1	1	1	1	1	1	1	1	1	100
5557	1	1	1	1	1	1	1	1	1	1	1	100
5558	1	1	1	1	1	1	1	1	1	1	1	100
5559	1	1	1	1	1	1	1	1	1	1	1	100
5560	1	1	1	1	1	1	1	1	1	1	1	100
5561	1	1	1	1	1	1	1	1	1	1	1	100
5562	1	1	1	1	1	1	1	1	1	1	1	100
5563	1	1	1	1	1	1	1	1	1	1	1	100
5564	1	1	1	1	1	1	1	1	1	1	1	100
5565	1	1	1	1	1	1	1	1	1	1	1	100
5566	1	1	1	1	1	1	1	1	1	1	1	100
5567	1	1	1	1	1	1	1	1	1	1	1	100
5568(FL)	1	1	1	1	1	1	1	1	1	1	1	100
5569	0	1	0	0	0	0	1	0	0	0	0	0
5570	0	1	0	0	0	0	1	0	0	0	0	0
5571	0	1	0	0	0	0	1	0	0	0	0	0