

EMC TEST REPORT

Applicant Nokia Shanghai Bell Co., Ltd.
FCC ID 2ADZRG1426GA
Product NOKIA ONT
Brand NOKIA
Model G-1426G-A
Report No. R2305A0552-E1
Issue Date August 31, 2023

TA Technology (Shanghai) Co., Ltd. tested the above equipment in accordance with the requirements in **FCC Code CFR47 Part15B (2022)/ ANSI C63.4-2014**. The test results show that the equipment tested is capable of demonstrating compliance with the requirements as documented in this report.

Liu Wei

Prepared by: Liu Wei

Fan Guangchang

Approved by: Fan Guangchang

TA Technology (Shanghai) Co., Ltd.

Building 3, No.145, Jintang Rd, Pudong Shanghai, P.R.China

TEL: +86-021-50791141/2/3

FAX: +86-021-50791141/2/3-8000

Table of Contents

1	Test Laboratory.....	4
1.1	Notes of the Test Report.....	4
1.2	Test Facility.....	4
1.3	Testing Location.....	4
2	General Description of Equipment Under Test.....	5
2.1	Applicant and Manufacturer Information.....	5
2.2	General Information.....	5
2.3	Applied Standards.....	7
2.4	Test Mode.....	8
3	Test Case Results.....	9
3.1	Radiated Emission.....	9
3.2	Conducted Emission.....	26
4	Uncertainty Measurement.....	39
5	Main Test Instruments.....	40
	ANNEX A: The EUT Appearance.....	41
	ANNEX B: Test Setup Photos.....	42

Summary of measurement results

Number	Test Case	Clause in FCC Rules	Conclusion
1	Radiated Emission	FCC Part15.109, ANSI C63.4-2014	PASS
2	Conducted Emission	FCC Part15.107, ANSI C63.4-2014	PASS
Date of Testing: July 5, 2023 ~ August 2, 2023			
Date of Sample Received: July 4, 2023			
Note: All indications of Pass/Fail in this report are opinions expressed by TA Technology (Shanghai) Co., Ltd. based on interpretations and/or observations of test results. Measurement Uncertainties were not taken into account and are published for informational purposes only.			

1 Test Laboratory

1.1 Notes of the Test Report

This report shall not be reproduced in full or partial, without the written approval of **TA Technology (Shanghai) Co., Ltd.** The results documented in this report apply only to the tested sample, under the conditions and modes of operation as described herein. Measurement Uncertainties were not taken into account and are published for informational purposes only. This report is written to support regulatory compliance of the applicable standards stated above.

1.2 Test Facility

FCC (Designation number: CN1179, Test Firm Registration Number: 446626)

TA Technology (Shanghai) Co., Ltd. has been listed on the US Federal Communications Commission list of test facilities recognized to perform measurements.

A2LA (Certificate Number: 3857.01)

TA Technology (Shanghai) Co., Ltd. has been listed by American Association for Laboratory Accreditation to perform measurement.

1.3 Testing Location

Company: TA Technology (Shanghai) Co., Ltd.
Address: Building 3, No.145, Jintang Rd, Pudong Shanghai, P.R.China
City: Shanghai
Post code: 201201
Country: P. R. China
Contact: Fan Guangchang
Telephone: +86-021-50791141/2/3
Fax: +86-021-50791141/2/3-8000
Website: <http://www.ta-shanghai.com>
E-mail: fanguangchang@ta-shanghai.com

2 General Description of Equipment Under Test

2.1 Applicant and Manufacturer Information

Applicant	Nokia Shanghai Bell Co., Ltd.
Applicant address	No.388, Ningqiao Rd, Pilot Free Trade Zone Shanghai, 201206 P.R. China
Manufacturer	Nokia of America Corporation
Manufacturer address	2301 Sugar Bush Rd. Raleigh, NC 27612

2.2 General Information

EUT Description			
Device Type	Movable Device		
Model	G-1426G-A		
SN	ALCLFCC9557A		
HW Version	PEM2		
SW Version	3TN00383		
Power Rating	DC 12V		
Connecting I/O Port(s)	Please refer to the User's Manual.		
Antenna Type	Wi-Fi 2.4G	External Antenna	
		PCB onboard Antenna	
	Wi-Fi 5G	External Antenna	
Frequency	Band	Tx (MHz)	Rx (MHz)
	Wi-Fi 2.4G	2400 ~ 2483.5	2400 ~ 2483.5
	Wi-Fi 5G (U-NII-1)	5150 ~ 5250	5150 ~ 5250
	Wi-Fi 5G (U-NII-2A)	5250 ~ 5350	5250 ~ 5350
	Wi-Fi 5G (U-NII-2C)	5470 ~ 5725	5470 ~ 5725
	Wi-Fi 5G (U-NII-3)	5725 ~ 5850	5725 ~ 5850
EUT Accessory			
Adapter 1	Manufacturer: SHENZHEN RUIDE ELECTRONIC INDUSTRIAL CO.,LTD Model: RD1201500-C55-198MG Part Number: BW120150-UC6C-LL05; BW120150-UC6C-HH00		
Adapter 2	Manufacturer: SHENZHEN RUIDE ELECTRONIC INDUSTRIAL CO.,LTD Model: RD1201500-C55-198OG Part Number: BW120150-EC6C-LL05; BW120150-EC6C-HH00		
Adapter 3	Manufacturer: SHENZHEN RUIDE ELECTRONIC INDUSTRIAL CO.,LTD Model: RD1201500-C55-198YG		

	Part Number: BW120150-YC6C-LL05
Adapter 4	Manufacturer: XIAMEN KELI ELECTRONICS CO.,LTD Model: KL-WA120150-H1 Part Number: SW-WB330TEA; SW-WB330TEC
Adapter 5	Manufacturer: XIAMEN KELI ELECTRONICS CO.,LTD Model: KL-AD3060VA Part Number: SW-WB330TC6; SW-WB330TC7
Adapter 6	Manufacturer: XIAMEN KELI ELECTRONICS CO.,LTD Model: KL-AD3060VAB Part Number: SW-WB330BA
Note: 1. The EUT is sent from the applicant to TA and the information of the EUT is declared by the applicant.	

Configuration	Configuration 1	Configuration 2
Model	G-1426G-A	G-1426G-A
USB	with USB	without USB
Others	the same	
During the test, the preliminary test was performed in all Configuration, Configuration 1 is selected as the worst condition. The test data of the worst-case condition was recorded in this report.		

Auxiliary test equipment

No.	Name	Brand name	Model
1	Testcenter	Spirent	SPT-C1
2	OLT	NOKIA	7362 ISAM DF-16GW
3	Telephone	BOTEL	HCD6238(20)P/TSDL13
4	U-Disk	SanDisk	Cruzer Blade 32GB/SDCZ74-032G-Z35
5	PC (1)	HP	EliteBook 745 G3
6	PC (2), PC (3)	ThinkPad	T480

Hardware code information

Configuration List:			
Brand Name	Model Name	ONT Package Part Number (KIT Code)	ONT Enclosure Part Number (EMA Code)
NOKIA	G-1426G-A	3TN00456XXXX (X can be any letter from A to Z or blank)	3TN00384XXXX (X can be any letter from A to Z or blank)
Explanation of the part number: XXXX in the part number varies according to different customer markets, the products have no differences on hardware, which have no impact on the EMC and Safety.			

2.3 Applied Standards

According to the specifications of the manufacturer, it must comply with the requirements of the following standards:

Test standards

FCC Code CFR47 Part15B (2022)

ANSI C63.4-2014

2.4 Test Mode

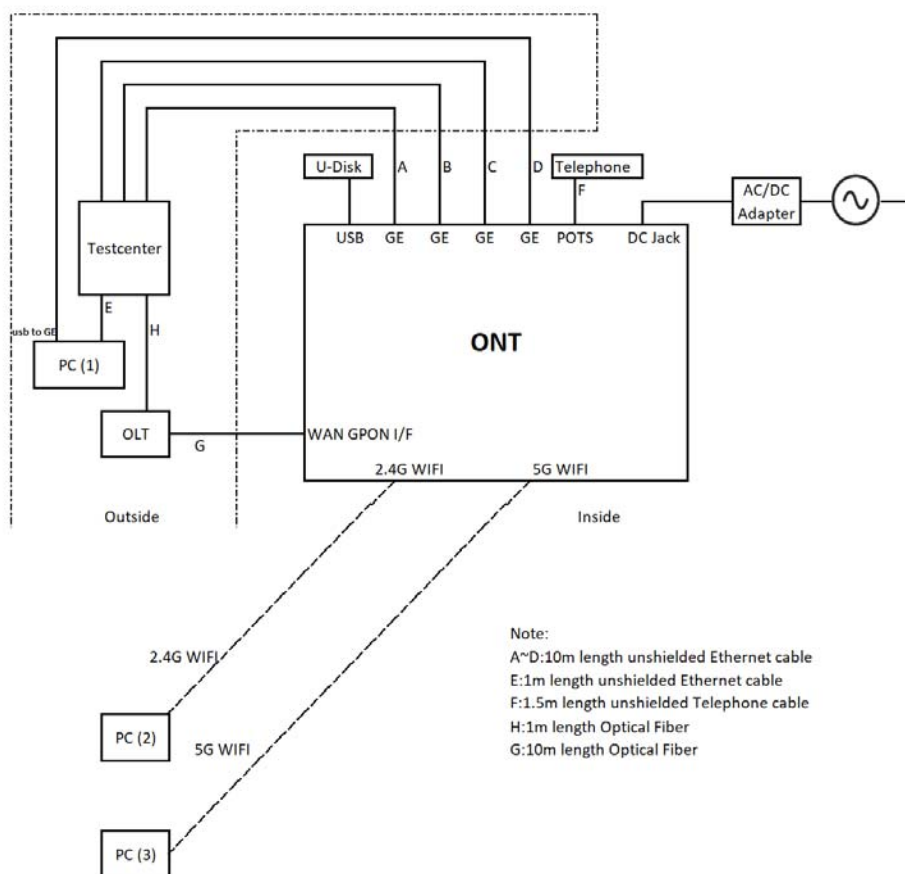

3 Test Case Results

3.1 Radiated Emission

Ambient Condition

Temperature	Relative humidity
15°C~35°C	30%~60%

Methods of Measurement

The EUT is placed on a non-metallic table 0.8m above the horizontal metal reference ground plane. The distance between EUT and receive antenna should be 3 meters. During the test, the EUT was operating in its typical mode. The test method is according to ANSI C63.4-2014. Sweep the whole frequency band through the range from 30MHz to the 5th harmonic of the carrier. During the test, the height of receive antenna shall be moved from 1 to 4 meters, and the antenna shall be performed under horizontal and vertical polarization. The turn table shall be rotated from 0 to 360 degrees for detecting the maximum of radiated signal level.

The data of cable loss and antenna factor has been calibrated in full testing frequency range before the testing. During the test, the EUT is worked at maximum output power.

Set the spectrum analyzer in the following:

Below 1GHz:

RBW=100 kHz / VBW=300 kHz / Sweep=AUTO

Above 1GHz:

(a) PEAK Detector: RBW=1MHz / VBW=3MHz/ Sweep=AUTO

(b) AVERAGE Detector: RBW=1MHz / VBW=3MHz / Sweep=AUTO

The radiated emission was measured in the following position: EUT stand-up position (Z axis), lie-down position (X, Y axis). The worst emission was found in lie-down position (X axis) and the worst case was recorded.

During the test, EUT is connected to a laptop via a USB cable in the case of Transfer Data mode. The EUT is used as the peripheral equipment of the PC. The data is transferred from EUT to PC; PC is connected to server via a long LAN cable.

Test Setup

Below 1GHz

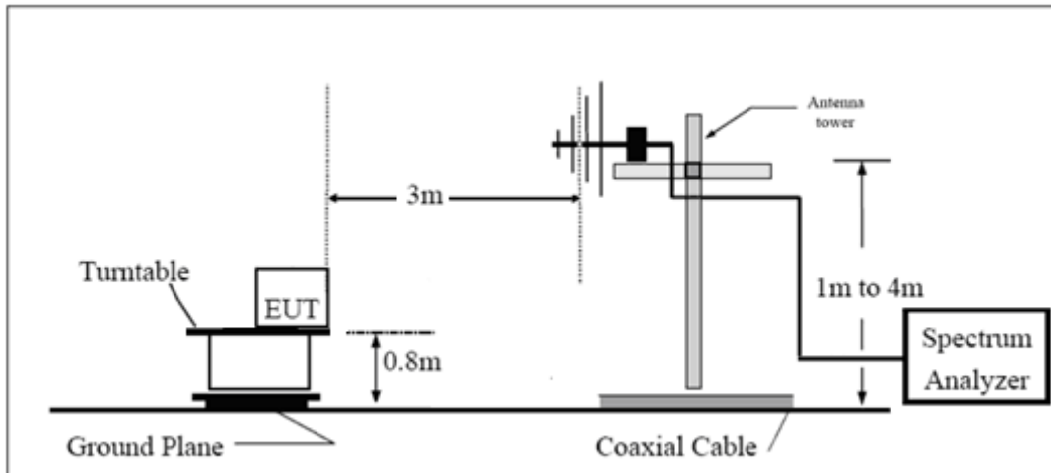

Above 1GHz

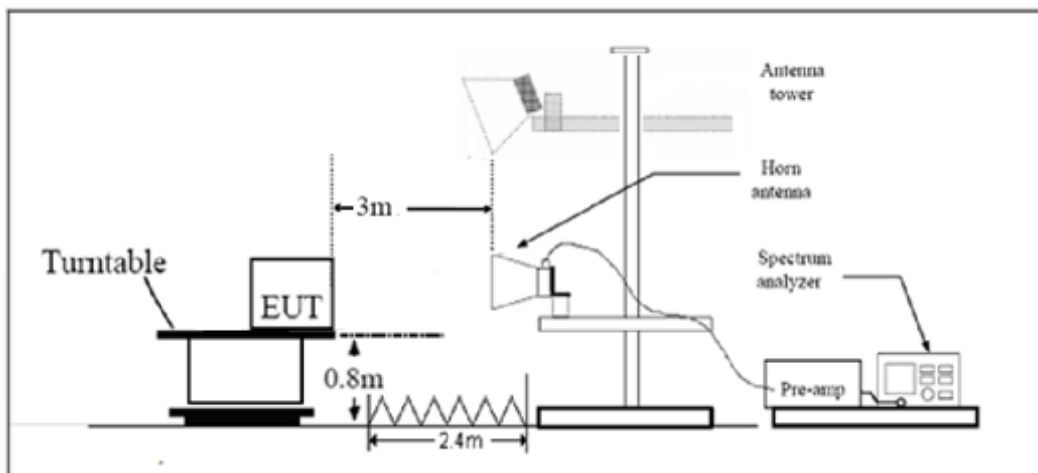

Note: Area side: 2.4mX3.6m

Antenna Tower meets ANSI C63.4 requirements for measurements above 1 GHz by keeping the antenna aimed at the EUT during the antenna's ascent/ descent along the antenna mast.

Limits
Class B

Frequency (MHz)	Field Strength (dB μ V/m)	Detector
30 -88	40.0	Quasi-peak
88-216	43.5	Quasi-peak
216 – 960	46.0	Quasi-peak
960-1000	54.0	Quasi-peak
1000-5 th harmonic of the highest frequency or 40GHz, which is lower	54 74	Average Peak

Frequency range of radiated measurements

Highest frequency generated or used in the device or on which the device operates or tunes (MHz)	Upper frequency of measurement range (MHz)
Below 1.705	30
1.705-108	1000
108-500	2000
500-1000	5000
Above 1000	5th harmonic of the highest frequency or 40 GHz, whichever is lower.

Test Results

Sweep the whole frequency band through the range from 30MHz to the 5th harmonic of the carrier.

The following graphs display the maximum values of horizontal and vertical by software.
For above 1GHz, Blue trace uses the peak detection, Green trace uses the average detection.

A symbol (dB μ V/m) in the test plot below means (dB μ V/m)

A symbol (dB V/) in the test plot below means (dB μ V/m)

US

Adapter 1

BW120150-UC6C-LL05 is the worst case

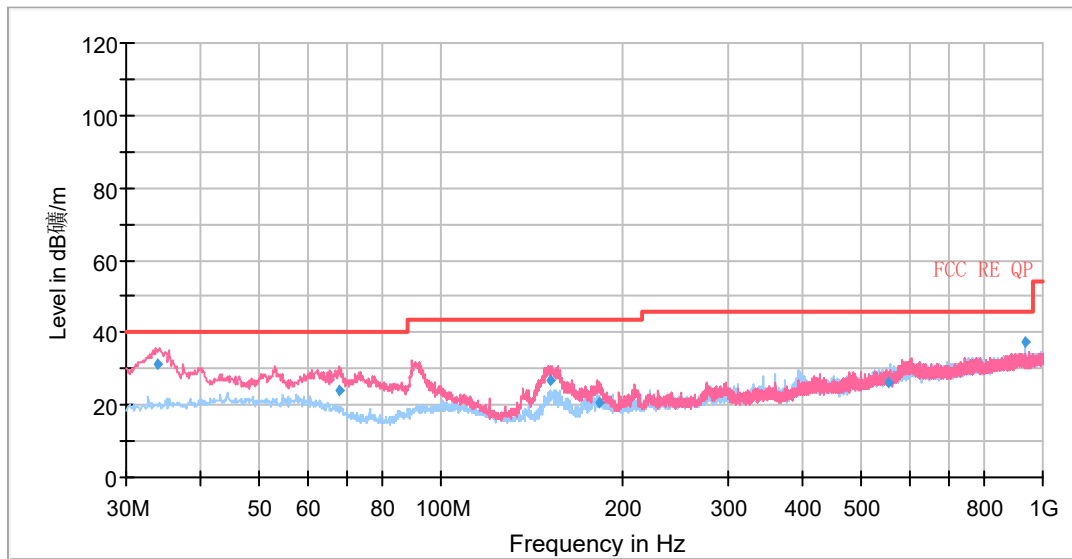

Radiated Emission from 30MHz to 1GHz

Frequency (MHz)	Quasi-Peak (dB μ V/m)	Limit (dB μ V/m)	Margin (dB)	Height (cm)	Polarization	Azimuth (deg)	Correct Factor (dB)
33.81	31.44	40.00	8.56	100.0	V	76.00	13
67.61	23.82	40.00	16.18	104.0	V	0.00	11
151.53	26.97	43.50	16.53	103.0	V	336.00	9
182.96	20.87	43.50	22.63	103.0	V	212.00	12
554.29	26.50	46.00	19.50	100.0	H	85.00	21
933.00	37.33	46.00	8.67	100.0	H	1.00	26

Remark: 1. Correction Factor = Antenna factor + Insertion loss(cable loss+amplifier gain)

2. Margin = Limit – Quasi-Peak

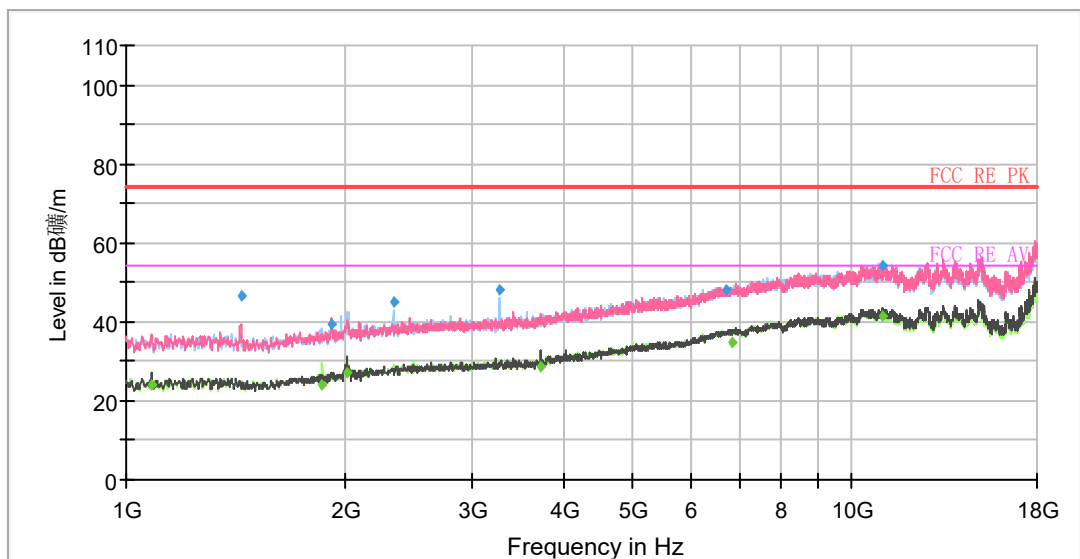

Note: The signal beyond the limit is carrier.

Radiated Emission from 1GHz to 18GHz

Frequency (MHz)	MaxPeak (dBµV/m)	Average (dBµV/m)	Limit (dB µ V/m)	Margin (dB)	Meas. Time (ms)	Height (cm)	Pol	Azimuth (deg)	Corr. (dB/m)
1082.88	---	23.91	54.00	30.09	1000.00	103.0	V	164.00	-20
1437.75	46.66	---	74.00	27.34	1000.00	100.0	V	96.00	-18
1864.88	---	23.86	54.00	30.14	1000.00	100.0	H	9.00	-17
1915.88	39.58	---	74.00	34.42	1000.00	191.0	V	1.00	-17
2015.75	---	27.04	54.00	26.96	1000.00	103.0	V	192.00	-17
2332.38	45.05	---	74.00	28.95	1000.00	210.0	H	336.00	-16
3265.25	47.89	---	74.00	26.11	1000.00	100.0	H	62.00	-14
3730.63	---	28.41	54.00	25.59	1000.00	109.0	H	284.00	-13
6720.50	47.97	---	74.00	26.03	1000.00	109.0	H	62.00	-2
6848.00	---	34.90	54.00	19.10	1000.00	198.0	H	175.00	-1
11027.88	---	41.50	54.00	12.50	1000.00	104.0	V	305.00	4
11030.00	54.41	---	74.00	19.59	1000.00	190.0	H	350.00	4

Remark: 1. Correction Factor = Antenna factor + Insertion loss (cable loss + amplifier gain)

2. Peak Margin = Limit - MAX Peak/ Average

EU

Adapter 2

BW120150-EC6C-HH00 is the worst case

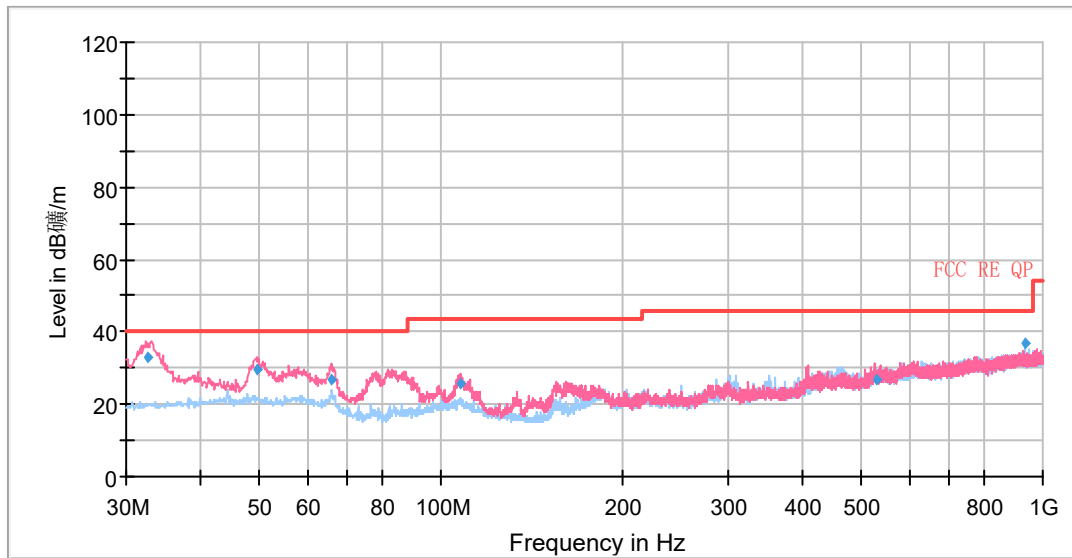

Radiated Emission from 30MHz to 1GHz

Frequency (MHz)	Quasi-Peak (dBµV/m)	Limit (dBµV/m)	Margin (dB)	Height (cm)	Polarization	Azimuth (deg)	Correct Factor (dB)
32.58	32.72	40.00	7.28	100.0	V	82.00	13
49.43	29.50	40.00	10.50	102.0	V	126.00	14
65.96	27.02	40.00	12.98	102.0	V	258.00	12
107.54	25.63	43.50	17.87	100.0	V	70.00	13
529.29	26.74	46.00	19.26	102.0	V	216.00	20
933.00	36.68	46.00	9.32	100.0	H	22.00	26

Remark: 1. Correction Factor = Antenna factor + Insertion loss(cable loss+amplifier gain)

2. Margin = Limit – Quasi-Peak

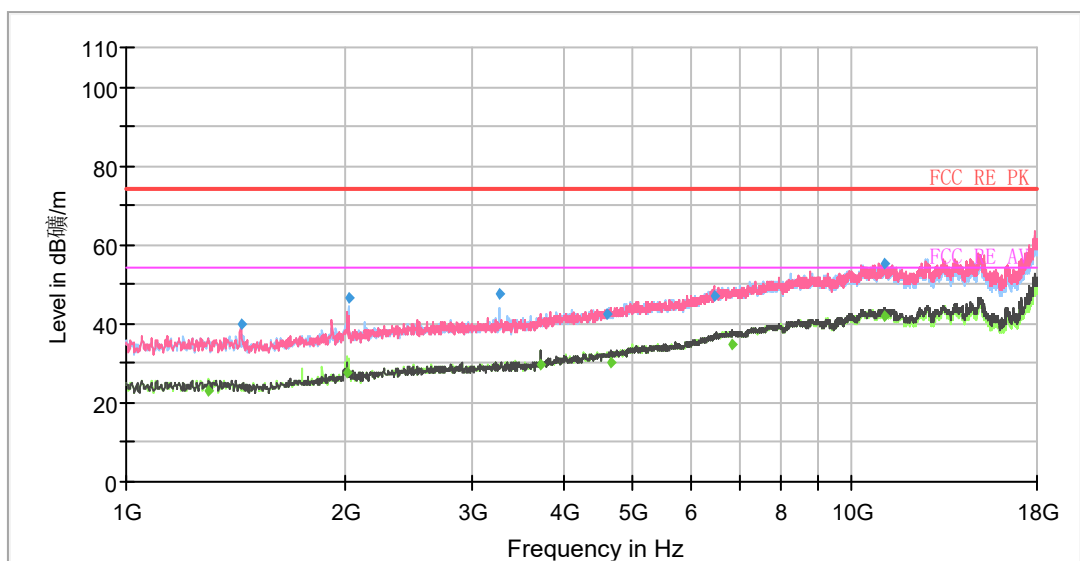

Note: The signal beyond the limit is carrier.

Radiated Emission from 1GHz to 18GHz

Frequency (MHz)	MaxPeak (dBµV/m)	Average (dBµV/m)	Limit (dB µ V/m)	Margin (dB)	Meas. Time (ms)	Height (cm)	Pol	Azimuth (deg)	Corr. (dB/m)
1299.63	---	23.10	54.00	30.90	1000.00	191.0	H	353.00	-19
1439.88	39.97	---	74.00	34.03	1000.00	104.0	V	146.00	-18
2013.63	---	27.49	54.00	26.51	1000.00	110.0	H	163.00	-17
2022.13	46.31	---	74.00	27.69	1000.00	101.0	H	153.00	-17
3265.25	47.74	---	74.00	26.26	1000.00	109.0	H	1.00	-14
3730.63	---	29.48	54.00	24.52	1000.00	100.0	H	291.00	-13
4591.25	42.49	---	74.00	31.51	1000.00	198.0	V	92.00	-9
4644.38	---	30.01	54.00	23.99	1000.00	100.0	H	327.00	-9
6450.63	47.18	---	74.00	26.82	1000.00	198.0	V	207.00	-3
6850.13	---	34.88	54.00	19.12	1000.00	100.0	V	253.00	-1
11083.13	55.31	---	74.00	18.69	1000.00	193.0	V	222.00	4
11089.50	---	41.89	54.00	12.11	1000.00	102.0	V	250.00	4

Remark: 1. Correction Factor = Antenna factor + Insertion loss (cable loss + amplifier gain)

2. Peak Margin = Limit - MAX Peak/ Average

UK
Adapter 3
BW120150-YC6C-LL05

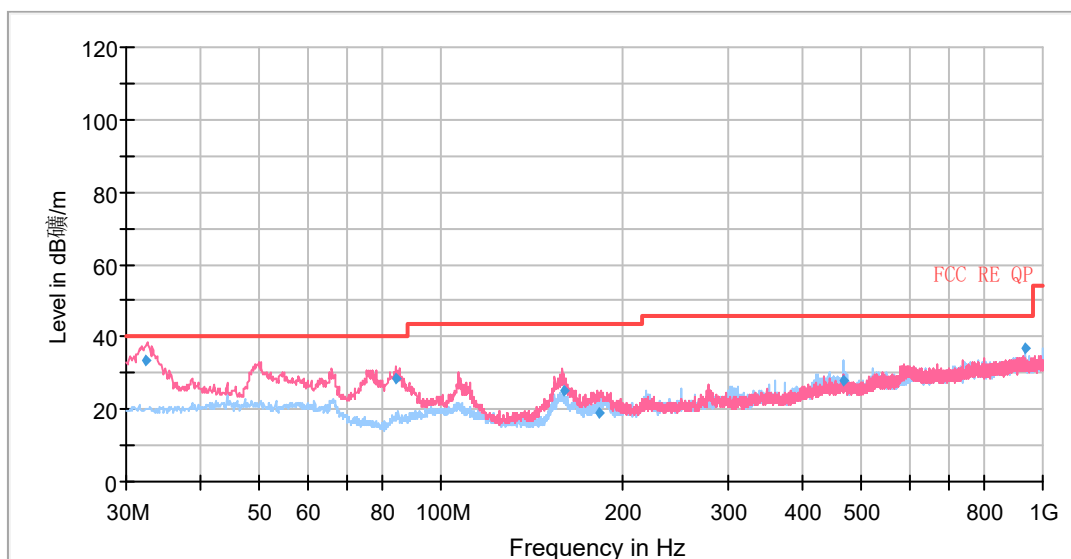

Radiated Emission from 30MHz to 1GHz

Frequency (MHz)	Quasi-Peak (dBµV/m)	Limit (dBµV/m)	Margin (dB)	Height (cm)	Polarization	Azimuth (deg)	Correct Factor (dB)
32.38	33.65	40.00	6.35	100.0	V	83.00	13
84.06	28.49	40.00	11.51	123.0	V	112.00	9
160.02	25.23	43.50	18.27	103.0	V	8.00	10
183.20	19.14	43.50	24.36	100.0	V	214.00	12
466.49	28.03	46.00	17.97	208.0	H	2.00	19
933.00	36.61	46.00	9.39	100.0	H	2.00	26

Remark: 1. Correction Factor = Antenna factor + Insertion loss(cable loss+amplifier gain)
2. Margin = Limit – Quasi-Peak

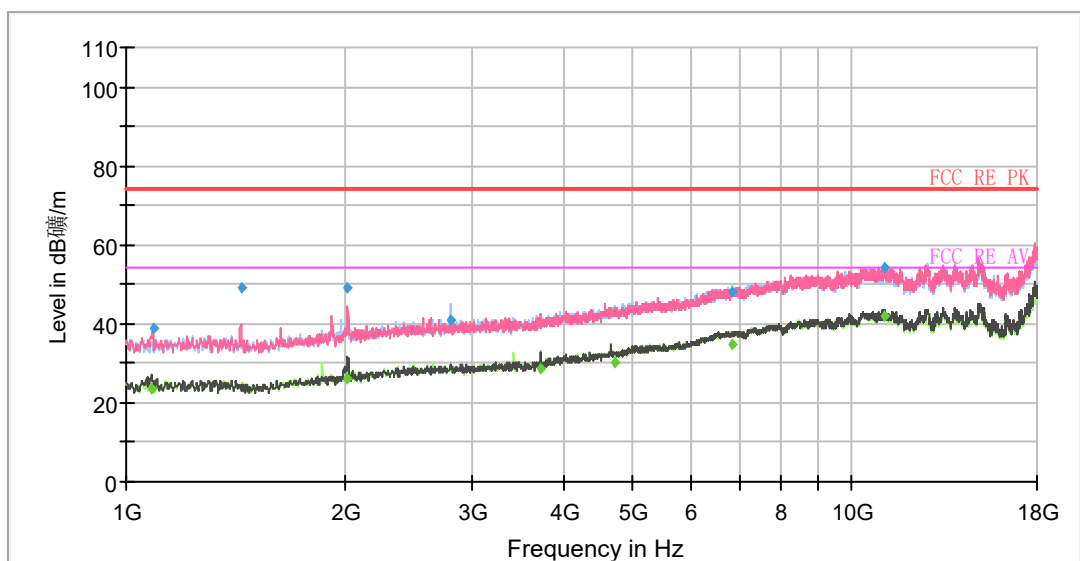

Note: The signal beyond the limit is carrier.

Radiated Emission from 1GHz to 18GHz

Frequency (MHz)	MaxPeak (dBµV/m)	Average (dBµV/m)	Limit (dB µ V/m)	Margin (dB)	Meas. Time (ms)	Height (cm)	Pol	Azimuth (deg)	Corr. (dB/m)
1085.00	---	23.30	54.00	30.70	1000.00	109.0	V	205.00	-20
1089.25	38.68	---	74.00	35.32	1000.00	102.0	V	201.00	-20
1439.88	49.01	---	74.00	24.99	1000.00	102.0	V	170.00	-18
2020.00	---	25.97	54.00	28.03	1000.00	198.0	V	186.00	-17
2020.00	49.19	---	74.00	24.81	1000.00	190.0	V	180.00	-17
2797.75	40.73	---	74.00	33.27	1000.00	109.0	H	136.00	-15
3730.63	---	28.41	54.00	25.59	1000.00	198.0	H	41.00	-13
4723.00	---	29.98	54.00	24.02	1000.00	100.0	H	78.00	-9
6850.13	48.08	---	74.00	25.92	1000.00	110.0	H	0.00	-1
6850.13	---	34.95	54.00	19.05	1000.00	210.0	H	76.00	-1
11085.25	---	42.03	54.00	11.97	1000.00	109.0	V	258.00	4
11087.38	54.41	---	74.00	19.59	1000.00	198.0	H	96.00	4

Remark: 1. Correction Factor = Antenna factor + Insertion loss (cable loss + amplifier gain)

2. Peak Margin = Limit - MAX Peak/ Average

US

Adapter 4

SW-WB330TEC is the worst case

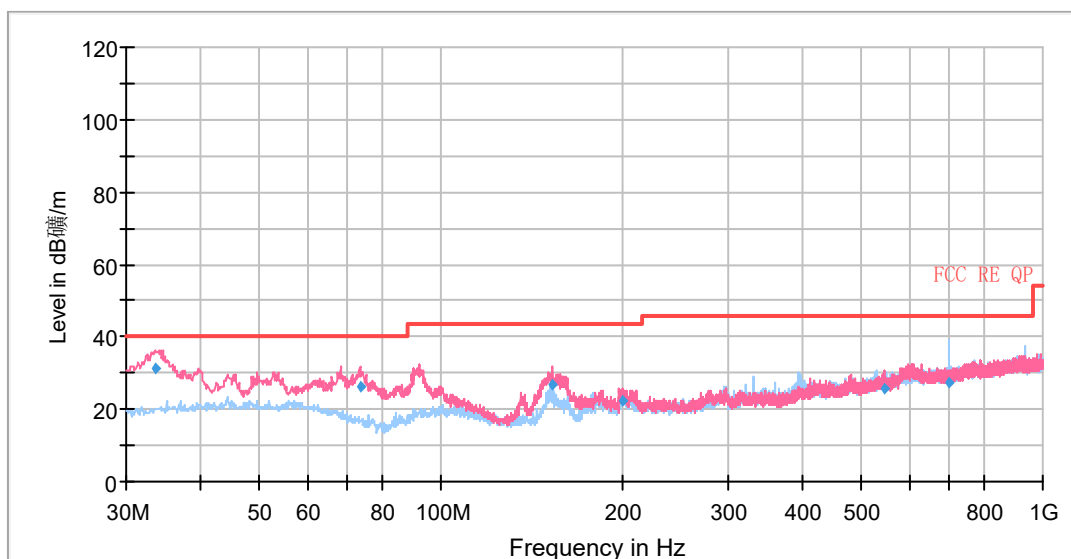

Radiated Emission from 30MHz to 1GHz

Frequency (MHz)	Quasi-Peak (dBµV/m)	Limit (dBµV/m)	Margin (dB)	Height (cm)	Polarization	Azimuth (deg)	Correct Factor (dB)
33.68	31.10	40.00	8.90	102.0	V	248.00	13
73.68	26.32	40.00	13.68	103.0	V	289.00	9
153.46	26.72	43.50	16.78	101.0	V	184.00	10
200.00	22.12	43.50	21.38	103.0	V	328.00	12
543.98	25.67	46.00	20.33	100.0	V	2.00	20
699.85	27.58	46.00	18.42	116.0	H	58.00	23

Remark: 1. Correction Factor = Antenna factor + Insertion loss(cable loss+amplifier gain)

2. Margin = Limit – Quasi-Peak

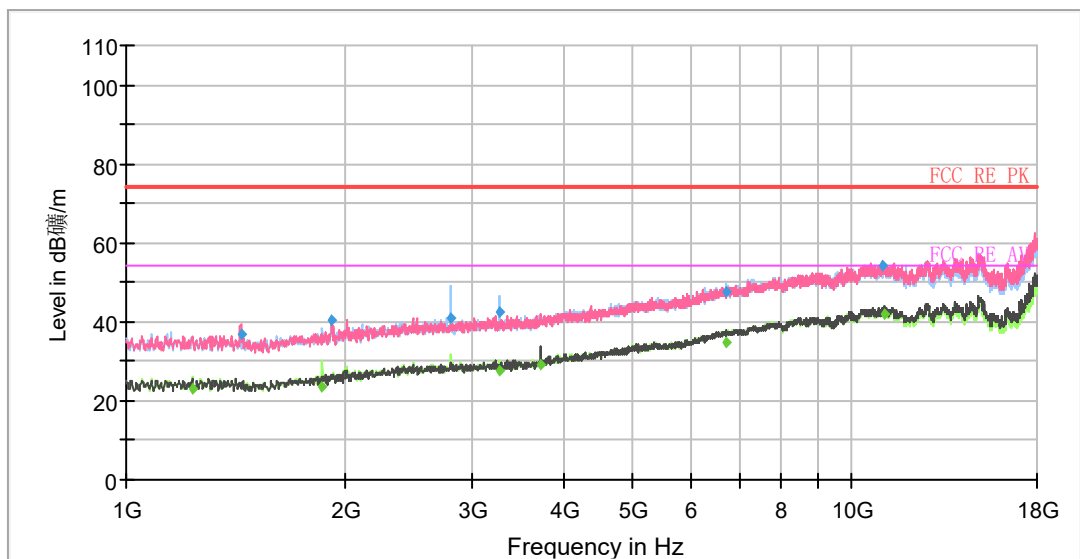

Note: The signal beyond the limit is carrier.

Radiated Emission from 1GHz to 18GHz

Frequency (MHz)	MaxPeak (dBµV/m)	Average (dBµV/m)	Limit (dB µ V/m)	Margin (dB)	Meas. Time (ms)	Height (cm)	Pol	Azimuth (deg)	Corr. (dB/m)
1233.75	---	23.01	54.00	30.99	1000.00	109.0	H	0.00	-19
1437.75	36.86	---	74.00	37.14	1000.00	100.0	V	22.00	-18
1864.88	---	23.57	54.00	30.43	1000.00	100.0	H	346.00	-17
1918.00	40.59	---	74.00	33.41	1000.00	103.0	V	184.00	-17
2797.75	40.74	---	74.00	33.26	1000.00	100.0	H	130.00	-15
3265.25	---	27.50	54.00	26.50	1000.00	100.0	H	135.00	-14
3265.25	42.57	---	74.00	31.43	1000.00	109.0	H	136.00	-14
3730.63	---	29.15	54.00	24.85	1000.00	100.0	V	10.00	-13
6729.00	47.54	---	74.00	26.46	1000.00	191.0	H	300.00	-2
6731.13	---	34.67	54.00	19.33	1000.00	210.0	V	280.00	-2
11044.88	54.40	---	74.00	19.60	1000.00	109.0	V	349.00	4
11087.38	---	42.03	54.00	11.97	1000.00	109.0	V	72.00	4

Remark: 1. Correction Factor = Antenna factor + Insertion loss (cable loss + amplifier gain)

2. Peak Margin = Limit - MAX Peak/ Average

EU

Adapter 5

SW-WB330TC6 is the worst case

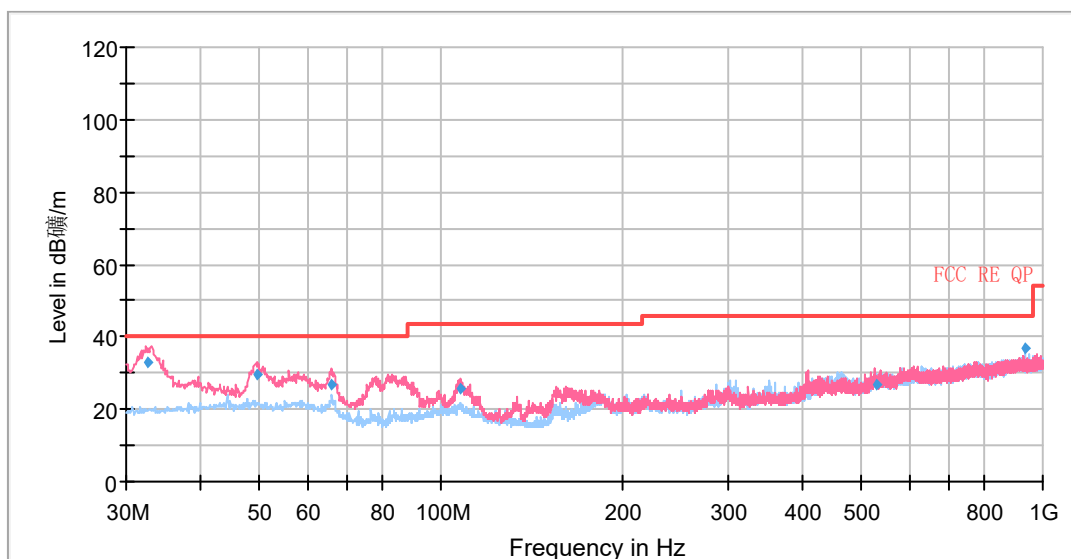

Radiated Emission from 30MHz to 1GHz

Frequency (MHz)	Quasi-Peak (dBµV/m)	Limit (dBµV/m)	Margin (dB)	Height (cm)	Polarization	Azimuth (deg)	Correct Factor (dB)
32.58	32.72	40.00	7.28	100.0	V	82.00	13
49.43	29.50	40.00	10.50	102.0	V	126.00	14
65.96	27.02	40.00	12.98	102.0	V	258.00	12
107.54	25.63	43.50	17.87	100.0	V	70.00	13
529.29	26.74	46.00	19.26	102.0	V	216.00	20
933.00	36.68	46.00	9.32	100.0	H	22.00	26

Remark: 1. Correction Factor = Antenna factor + Insertion loss(cable loss+amplifier gain)

2. Margin = Limit – Quasi-Peak

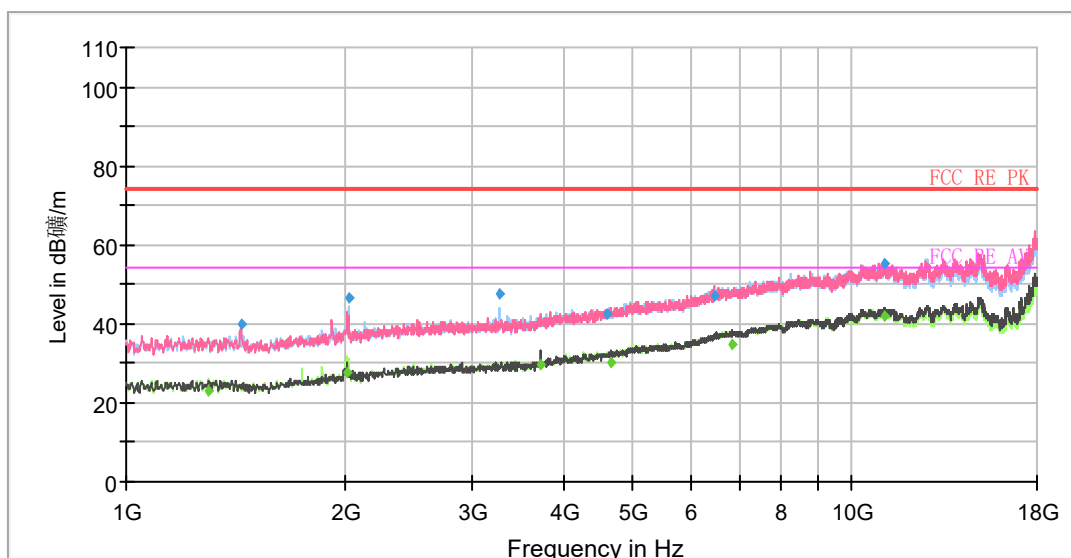

Note: The signal beyond the limit is carrier.

Radiated Emission from 1GHz to 18GHz

Frequency (MHz)	MaxPeak (dBµV/m)	Average (dBµV/m)	Limit (dB µ V/m)	Margin (dB)	Meas. Time (ms)	Height (cm)	Pol	Azimuth (deg)	Corr. (dB/m)
1299.63	---	23.10	54.00	30.90	1000.00	191.0	H	353.00	-19
1439.88	39.97	---	74.00	34.03	1000.00	104.0	V	146.00	-18
2013.63	---	27.49	54.00	26.51	1000.00	110.0	H	163.00	-17
2022.13	46.31	---	74.00	27.69	1000.00	101.0	H	153.00	-17
3265.25	47.74	---	74.00	26.26	1000.00	109.0	H	1.00	-14
3730.63	---	29.48	54.00	24.52	1000.00	100.0	H	291.00	-13
4591.25	42.49	---	74.00	31.51	1000.00	198.0	V	92.00	-9
4644.38	---	30.01	54.00	23.99	1000.00	100.0	H	327.00	-9
6450.63	47.18	---	74.00	26.82	1000.00	198.0	V	207.00	-3
6850.13	---	34.88	54.00	19.12	1000.00	100.0	V	253.00	-1
11083.13	55.31	---	74.00	18.69	1000.00	193.0	V	222.00	4
11089.50	---	41.89	54.00	12.11	1000.00	102.0	V	250.00	4

Remark: 1. Correction Factor = Antenna factor + Insertion loss (cable loss + amplifier gain)

2. Peak Margin = Limit - MAX Peak/ Average

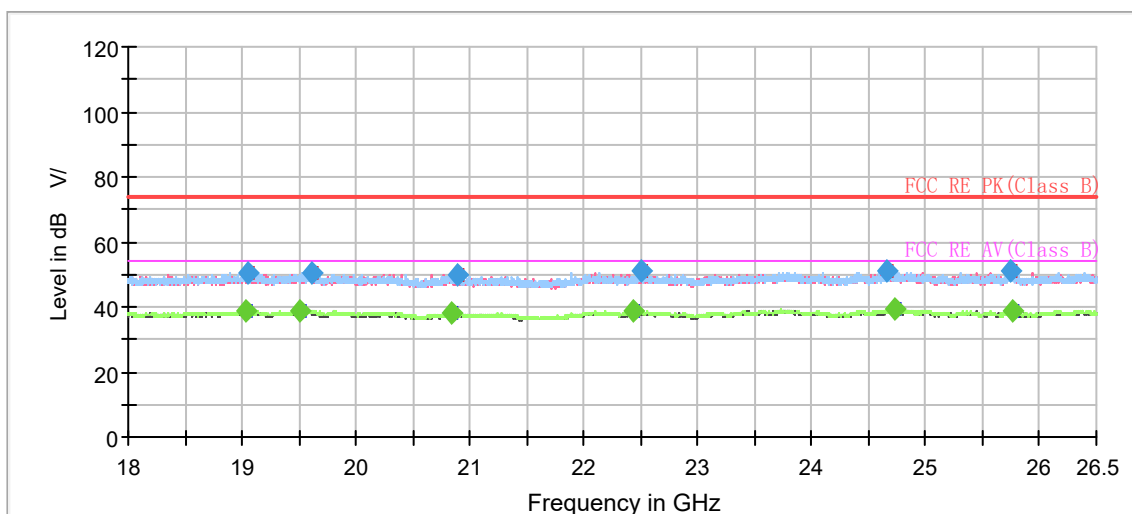

Radiated Emission from 18GHz to 26.5GHz

Frequency (MHz)	MaxPeak (dBμV/m)	Average (dBμV/m)	Limit (dB μ V/m)	Margin (dB)	Meas. Time (ms)	Height (cm)	Pol	Azimuth (deg)	Corr. (dB/m)
19030.625000	---	38.97	54.00	15.03	500.0	100.0	H	291.0	-5.6
19043.375000	50.37	---	74.00	23.63	500.0	200.0	H	6.0	-5.6
19509.812500	---	38.89	54.00	15.11	500.0	100.0	H	161.0	-5.3
19615.000000	50.68	---	74.00	23.32	500.0	200.0	V	128.0	-5.3
20847.500000	---	38.15	54.00	15.85	500.0	200.0	V	88.0	-5.1
20886.812500	50.05	---	74.00	23.95	500.0	200.0	V	58.0	-5.1
22439.125000	---	38.68	54.00	15.32	500.0	100.0	H	175.0	-4.0
22502.875000	50.81	---	74.00	23.19	500.0	100.0	H	156.0	-3.9
24654.437500	50.93	---	74.00	23.07	500.0	100.0	H	9.0	-2.2
24732.000000	---	39.38	54.00	14.62	500.0	100.0	H	132.0	-2.1
25747.750000	51.23	---	74.00	22.77	500.0	100.0	H	296.0	-2.6
25757.312500	---	39.02	54.00	14.98	500.0	100.0	H	306.0	-2.6

Remark: 1. Correction Factor = Antenna factor + Insertion loss (cable loss + amplifier gain)

2. Peak Margin = Limit -MAX Peak/ Average

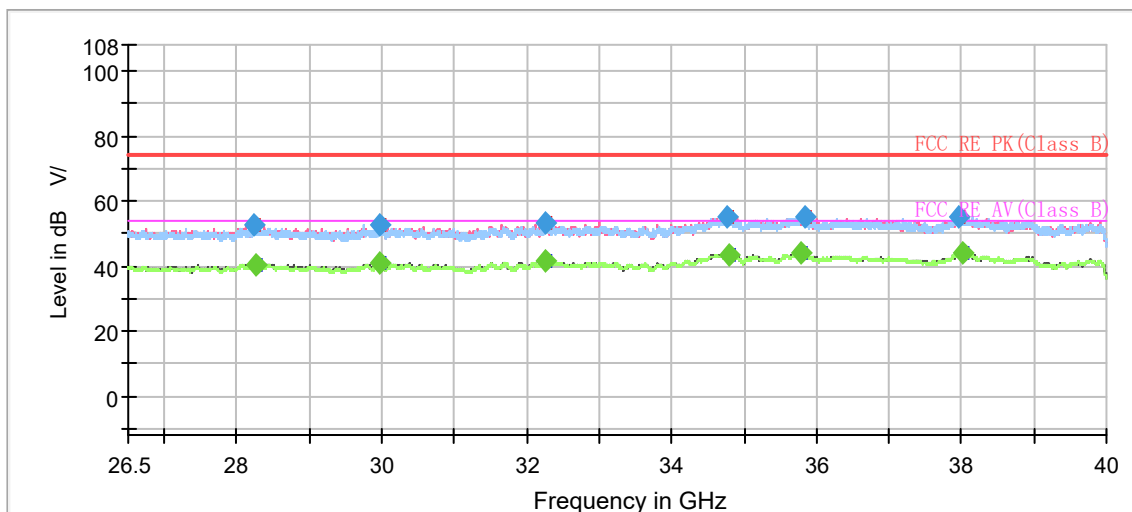

Note: The signal beyond the limit is carrier.
Radiated Emission from 26.5GHz to 40GHz

Frequency (MHz)	MaxPeak (dBμV/m)	Average (dBμV/m)	Limit (dB μ V/m)	Margin (dB)	Meas. Time (ms)	Height (cm)	Pol	Azimuth (deg)	Corr. (dB/m)
28229.687500	52.66	---	74.00	21.34	500.0	200.0	V	314.0	-0.1
28263.437500	---	40.48	54.00	13.52	500.0	200.0	V	349.0	0.0
29969.500000	52.43	---	74.00	21.57	500.0	100.0	H	317.0	-0.4
29974.562500	---	40.68	54.00	13.32	500.0	100.0	H	266.0	-0.4
32262.812500	---	41.38	54.00	12.62	500.0	200.0	V	280.0	-1.2
32264.500000	52.95	---	74.00	21.05	500.0	200.0	V	314.0	-1.2
34773.812500	55.10	---	74.00	18.90	500.0	200.0	V	0.0	3.0
34787.312500	---	43.47	54.00	10.53	500.0	100.0	H	17.0	3.0
35777.875000	---	43.85	54.00	10.15	500.0	200.0	V	153.0	3.2
35847.062500	55.31	---	74.00	18.69	500.0	200.0	V	169.0	3.3
37973.312500	55.10	---	74.00	18.90	500.0	100.0	H	61.0	3.6
38015.500000	---	43.89	54.00	10.11	500.0	200.0	H	125.0	3.7

Remark: 1. Correction Factor = Antenna factor + Insertion loss (cable loss + amplifier gain)
2. Peak Margin = Limit - MAX Peak/ Average

UK
Adapter 6
SW-WB330BA

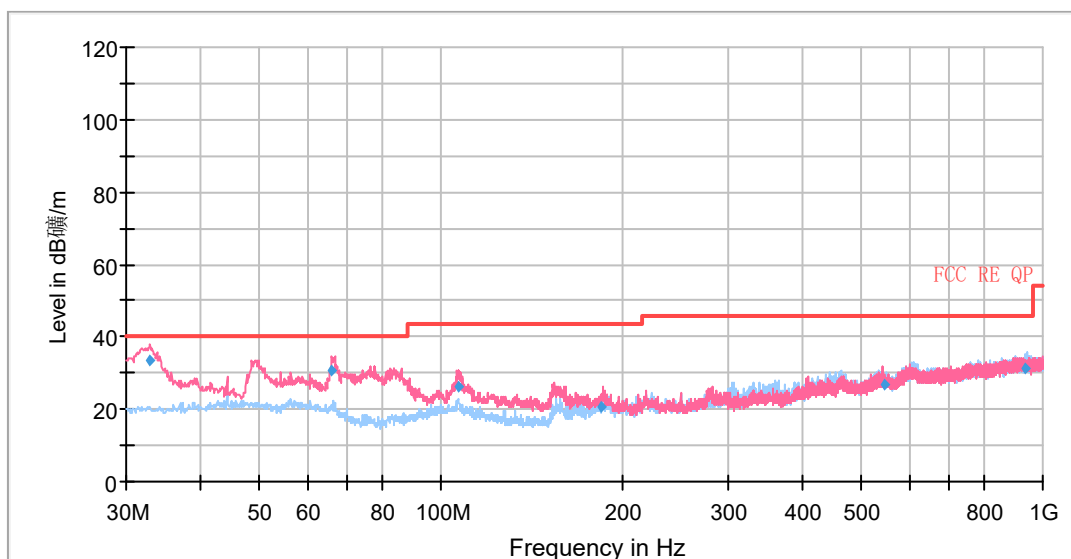

Radiated Emission from 30MHz to 1GHz

Frequency (MHz)	Quasi-Peak (dBµV/m)	Limit (dBµV/m)	Margin (dB)	Height (cm)	Polarization	Azimuth (deg)	Correct Factor (dB)
32.75	33.59	40.00	6.41	100.0	V	107.00	13
65.88	30.58	40.00	9.42	101.0	V	262.00	12
106.66	26.46	43.50	17.04	100.0	V	24.00	13
185.20	20.44	43.50	23.06	223.0	V	206.00	12
544.01	26.71	46.00	19.29	201.0	V	38.00	20
934.60	31.30	46.00	14.70	202.0	H	326.00	26

Remark: 1. Correction Factor = Antenna factor + Insertion loss(cable loss+amplifier gain)
2. Margin = Limit – Quasi-Peak

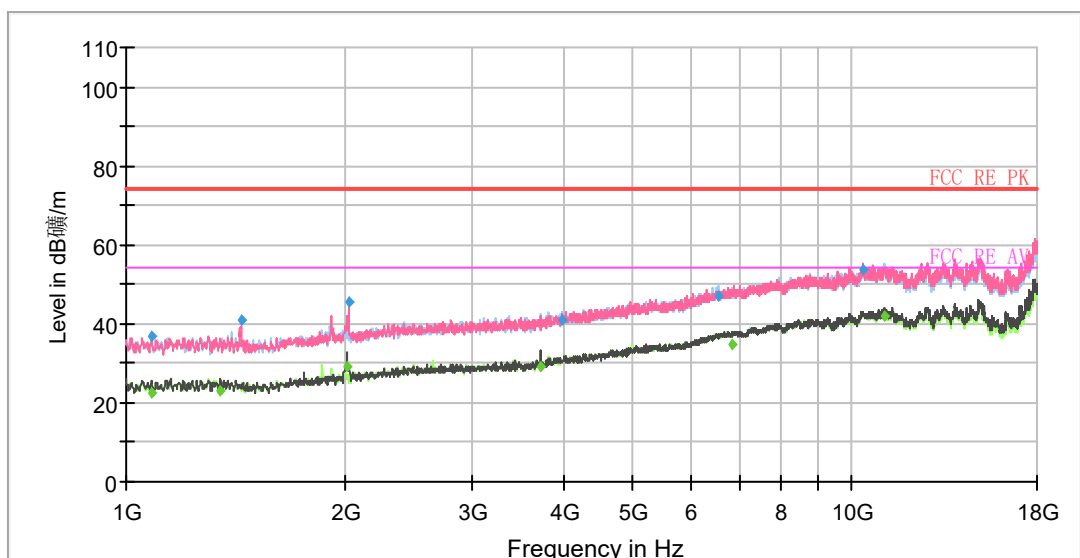

Note: The signal beyond the limit is carrier.

Radiated Emission from 1GHz to 18GHz

Frequency (MHz)	MaxPeak (dBµV/m)	Average (dBµV/m)	Limit (dB µ V/m)	Margin (dB)	Meas. Time (ms)	Height (cm)	Pol	Azimuth (deg)	Corr. (dB/m)
1082.88	37.00	---	74.00	37.00	1000.00	102.0	V	205.00	-20
1082.88	---	22.49	54.00	31.51	1000.00	210.0	H	173.00	-20
1350.63	---	22.96	54.00	31.04	1000.00	100.0	V	16.00	-19
1437.75	40.71	---	74.00	33.29	1000.00	100.0	V	183.00	-18
2011.50	---	29.13	54.00	24.88	1000.00	191.0	V	185.00	-17
2024.25	45.67	---	74.00	28.33	1000.00	204.0	V	184.00	-17
3730.63	---	29.13	54.00	24.87	1000.00	100.0	H	294.00	-13
3989.88	40.99	---	74.00	33.01	1000.00	110.0	H	151.00	-11
6548.38	46.84	---	74.00	27.16	1000.00	210.0	H	115.00	-2
6852.25	---	34.87	54.00	19.13	1000.00	210.0	V	242.00	-1
10373.38	53.94	---	74.00	20.06	1000.00	190.0	V	289.00	3
11085.25	---	41.99	54.00	12.01	1000.00	110.0	V	8.00	4

Remark: 1. Correction Factor = Antenna factor + Insertion loss (cable loss + amplifier gain)

2. Peak Margin = Limit - MAX Peak/ Average

3.2 Conducted Emission

Ambient Condition

Temperature	Relative humidity
15°C~35°C	30%~60%

Methods of Measurement

The EUT is placed on a non-metallic table of 80cm height above the horizontal metal reference ground plane. During the test, the EUT was operating in its typical mode. The test method is according to ANSI C63.4-2014. Connect the AC power line of the EUT to the L.I.S.N. Use EMI receiver to detect the average and Quasi-peak value. RBW is set to 9 kHz, VBW is set to 30kHz. The measurement result should include both L line and N line.

During the test, EUT is connected to a laptop via a USB cable in the case of Transfer Data mode. The EUT is used as the peripheral equipment of the PC. The data is transferred from EUT to PC; PC is connected to server via a long LAN cable.

Test Setup

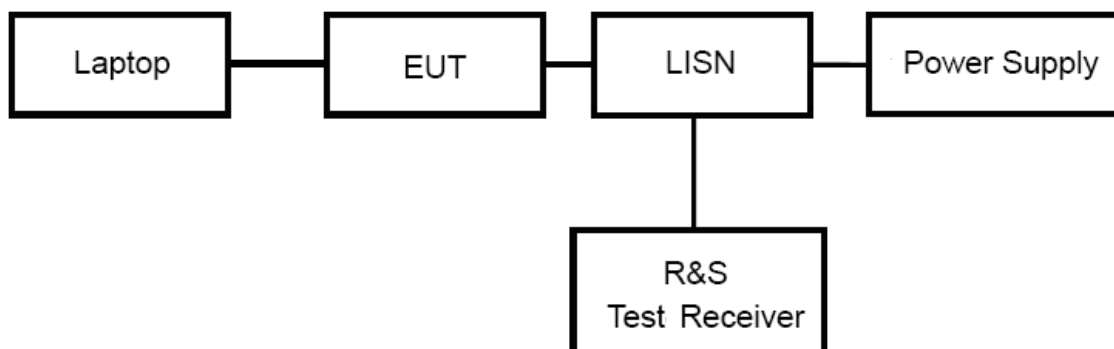

Note: Power Supply is AC Power source and it is used to change the voltage 120V/60Hz.

Limits

Frequency (MHz)	Class A (dBμV)		Class B (dBμV)	
	Quasi-peak	Average	Quasi-peak	Average
0.15 - 0.5	79	66	66 to 56 *	56 to 46*
0.5 - 5	73	60	56	46
5 - 30	73	60	60	50

*: Decreases with the logarithm of the frequency.

Note: The EUT should meet CLASS B limit.

Test Results

Following plots, Blue trace uses the peak detection; Green trace uses the average detection.

US

Adapter 1

BW120150-UC6C-HH00 is the worst case

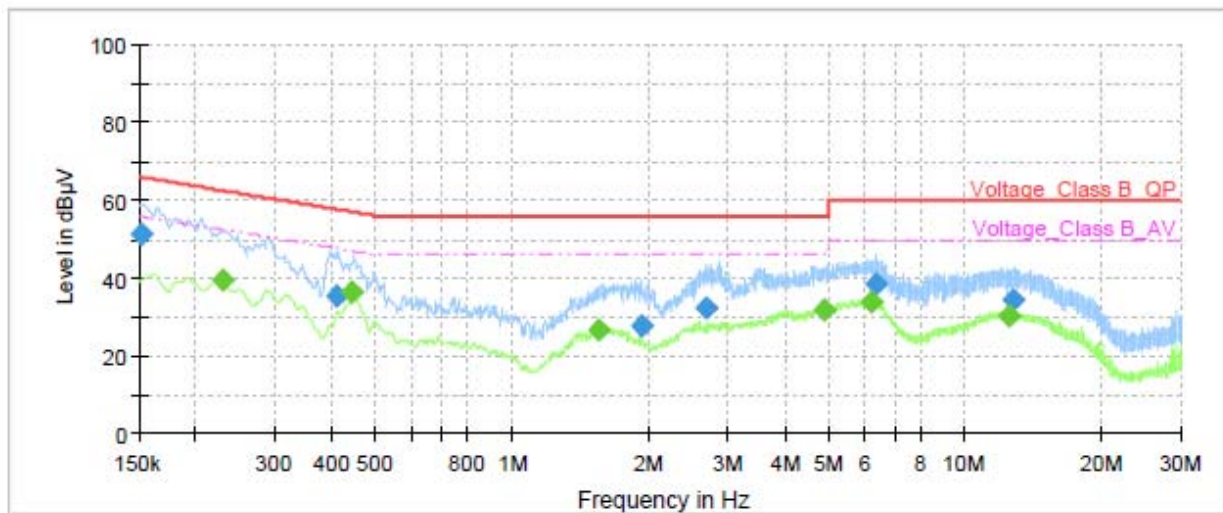

Frequency (MHz)	QuasiPeak (dBµV)	Average (dBµV)	Limit (dBµV)	Margin (dB)	Meas. Time (ms)	Bandwidth (kHz)	Line	Filter	Corr. (dB)
0.15	51.19	---	65.88	14.69	1000.0	9.000	L1	ON	21.0
0.23	---	39.41	52.50	13.09	1000.0	9.000	L1	ON	21.1
0.41	35.42	---	57.63	22.21	1000.0	9.000	L1	ON	21.0
0.44	---	36.33	46.97	10.64	1000.0	9.000	L1	ON	20.9
1.55	---	26.48	46.00	19.52	1000.0	9.000	L1	ON	19.9
1.94	27.90	---	56.00	28.10	1000.0	9.000	L1	ON	19.7
2.68	32.17	---	56.00	23.83	1000.0	9.000	L1	ON	19.6
4.90	---	31.96	46.00	14.04	1000.0	9.000	L1	ON	19.5
6.23	---	33.74	50.00	16.26	1000.0	9.000	L1	ON	19.5
6.35	38.59	---	60.00	21.41	1000.0	9.000	L1	ON	19.5
12.55	---	30.01	50.00	19.99	1000.0	9.000	L1	ON	19.6
12.74	34.41	---	60.00	25.59	1000.0	9.000	L1	ON	19.6

Remark: Correct factor=cable loss + LISN factor

L line

Conducted Emission from 150 KHz to 30 MHz

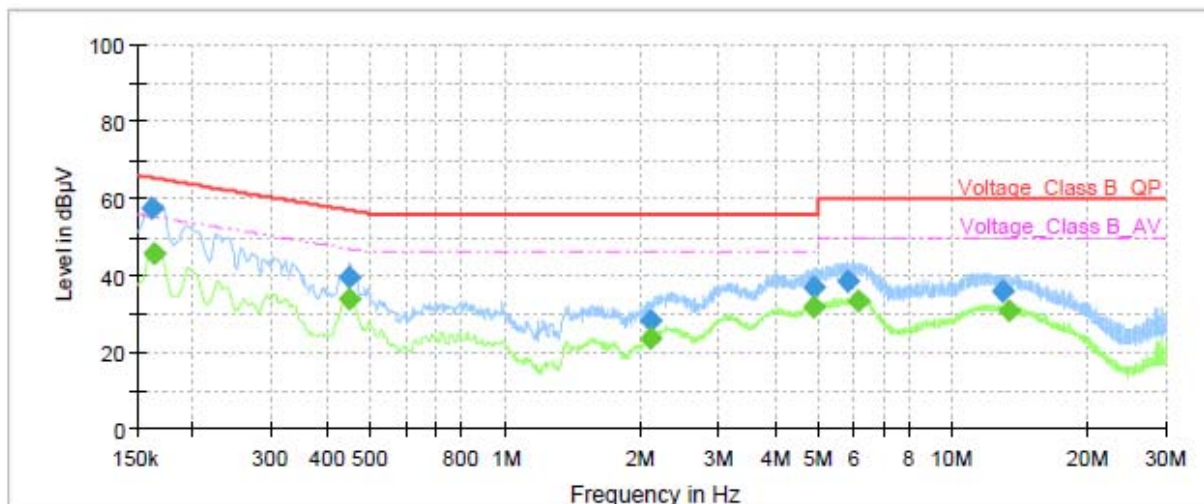

Frequency (MHz)	QuasiPeak (dBµV)	Average (dBµV)	Limit (dBµV)	Margin (dB)	Meas. Time (ms)	Bandwidth (kHz)	Line	Filter	Corr. (dB)
0.16	57.51	---	65.40	7.89	1000.0	9.000	N	ON	21.0
0.16	---	45.81	55.28	9.47	1000.0	9.000	N	ON	21.0
0.45	---	33.80	46.89	13.09	1000.0	9.000	N	ON	20.9
0.45	39.27	---	56.89	17.62	1000.0	9.000	N	ON	20.9
2.11	28.06	---	56.00	27.94	1000.0	9.000	N	ON	19.7
2.11	---	23.75	46.00	22.25	1000.0	9.000	N	ON	19.7
4.88	---	31.60	46.00	14.40	1000.0	9.000	N	ON	19.5
4.91	36.96	---	56.00	19.04	1000.0	9.000	N	ON	19.5
5.81	38.47	---	60.00	21.53	1000.0	9.000	N	ON	19.5
6.17	---	33.33	50.00	16.67	1000.0	9.000	N	ON	19.5
12.91	35.76	---	60.00	24.24	1000.0	9.000	N	ON	19.6
13.42	---	30.90	50.00	19.10	1000.0	9.000	N	ON	19.6

Remark: Correct factor=cable loss + LISN factor

N line

Conducted Emission from 150 KHz to 30 MHz

EU
Adapter 2
BW120150-EC6C-HH00 is the worst case

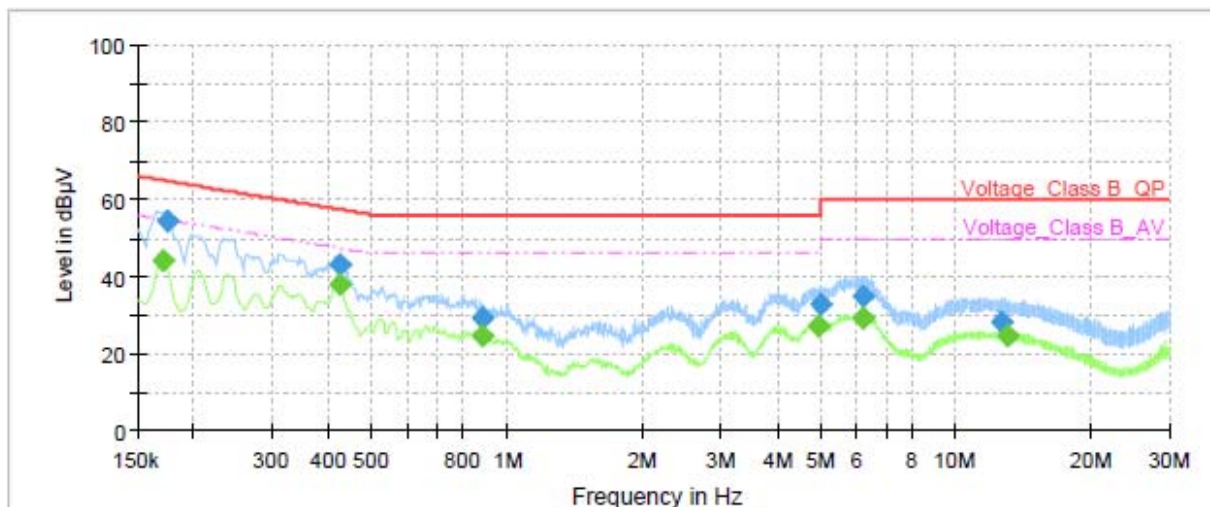

Frequency (MHz)	QuasiPeak (dBµV)	Average (dBµV)	Limit (dBµV)	Margin (dB)	Meas. Time (ms)	Bandwidth (kHz)	Line	Filter	Corr. (dB)
0.17	---	44.12	54.95	10.83	1000.0	9.000	L1	ON	21.0
0.17	54.40	---	64.73	10.33	1000.0	9.000	L1	ON	21.1
0.42	---	38.06	47.40	9.34	1000.0	9.000	L1	ON	20.9
0.42	42.91	---	57.36	14.45	1000.0	9.000	L1	ON	20.9
0.88	29.10	---	56.00	26.90	1000.0	9.000	L1	ON	20.3
0.88	---	24.39	46.00	21.61	1000.0	9.000	L1	ON	20.3
4.96	---	27.10	46.00	18.90	1000.0	9.000	L1	ON	19.5
4.99	32.91	---	56.00	23.09	1000.0	9.000	L1	ON	19.5
6.22	---	29.38	50.00	20.62	1000.0	9.000	L1	ON	19.5
6.25	34.81	---	60.00	25.19	1000.0	9.000	L1	ON	19.5
12.61	28.43	---	60.00	31.57	1000.0	9.000	L1	ON	19.6
13.07	---	24.53	50.00	25.47	1000.0	9.000	L1	ON	19.6

Remark: Correct factor=cable loss + LISN factor

L line

Conducted Emission from 150 KHz to 30 MHz

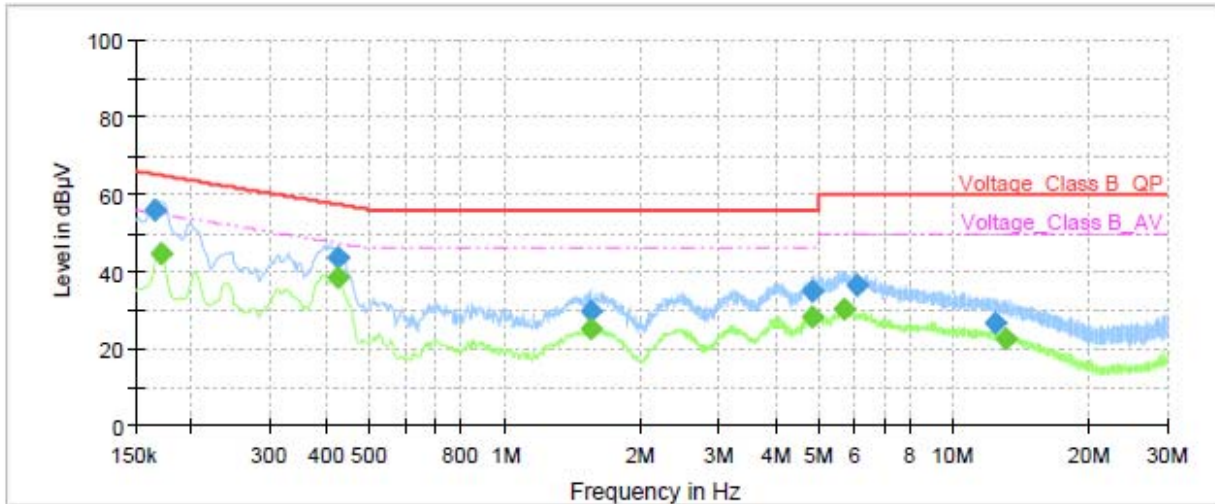

Frequency (MHz)	QuasiPeak (dBµV)	Average (dBµV)	Limit (dBµV)	Margin (dB)	Meas. Time (ms)	Bandwidth (kHz)	Line	Filter	Corr. (dB)
0.17	56.13	---	65.17	9.04	1000.0	9.000	N	ON	21.0
0.17	---	44.54	54.95	10.41	1000.0	9.000	N	ON	21.0
0.42	---	38.63	47.36	8.73	1000.0	9.000	N	ON	20.9
0.42	43.63	---	57.36	13.73	1000.0	9.000	N	ON	20.9
1.55	29.84	---	56.00	26.16	1000.0	9.000	N	ON	19.9
1.55	---	25.22	46.00	20.78	1000.0	9.000	N	ON	19.9
4.84	---	28.38	46.00	17.62	1000.0	9.000	N	ON	19.5
4.86	34.76	---	56.00	21.24	1000.0	9.000	N	ON	19.5
5.72	---	30.26	50.00	19.74	1000.0	9.000	N	ON	19.5
6.06	36.19	---	60.00	23.81	1000.0	9.000	N	ON	19.5
12.42	26.89	---	60.00	33.11	1000.0	9.000	N	ON	19.6
13.12	---	22.62	50.00	27.38	1000.0	9.000	N	ON	19.6

Remark: Correct factor=cable loss + LISN factor

N line

Conducted Emission from 150 KHz to 30 MHz

UK
Adapter 3
BW120150-YC6C-LL05

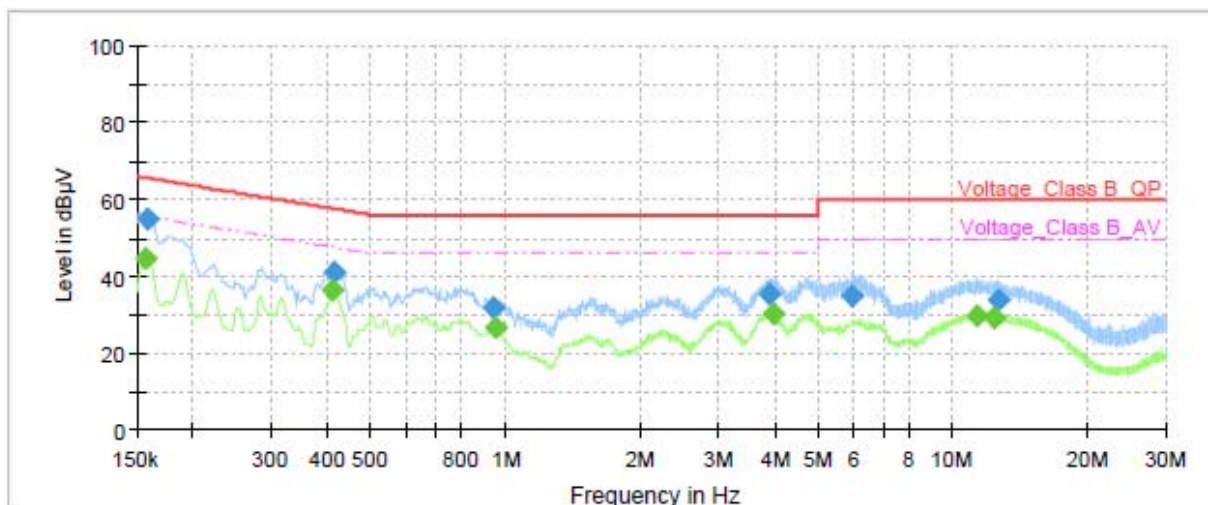

Frequency (MHz)	QuasiPeak (dBµV)	Average (dBµV)	Limit (dBµV)	Margin (dB)	Meas. Time (ms)	Bandwidth (kHz)	Line	Filter	Corr. (dB)
0.16	---	44.87	55.63	10.76	1000.0	9.000	L1	ON	21.0
0.16	54.93	---	65.52	10.59	1000.0	9.000	L1	ON	21.0
0.41	---	36.29	47.63	11.34	1000.0	9.000	L1	ON	21.0
0.41	41.22	---	57.58	16.36	1000.0	9.000	L1	ON	21.0
0.94	31.66	---	56.00	24.34	1000.0	9.000	L1	ON	20.3
0.96	---	26.44	46.00	19.56	1000.0	9.000	L1	ON	20.3
3.89	35.50	---	56.00	20.50	1000.0	9.000	L1	ON	19.5
3.96	---	30.12	46.00	15.88	1000.0	9.000	L1	ON	19.5
5.97	34.71	---	60.00	25.29	1000.0	9.000	L1	ON	19.5
11.33	---	29.75	50.00	20.25	1000.0	9.000	L1	ON	19.5
12.42	---	29.47	50.00	20.53	1000.0	9.000	L1	ON	19.6
12.61	33.90	---	60.00	26.10	1000.0	9.000	L1	ON	19.6

Remark: Correct factor=cable loss + LISN factor

L line

Conducted Emission from 150 KHz to 30 MHz

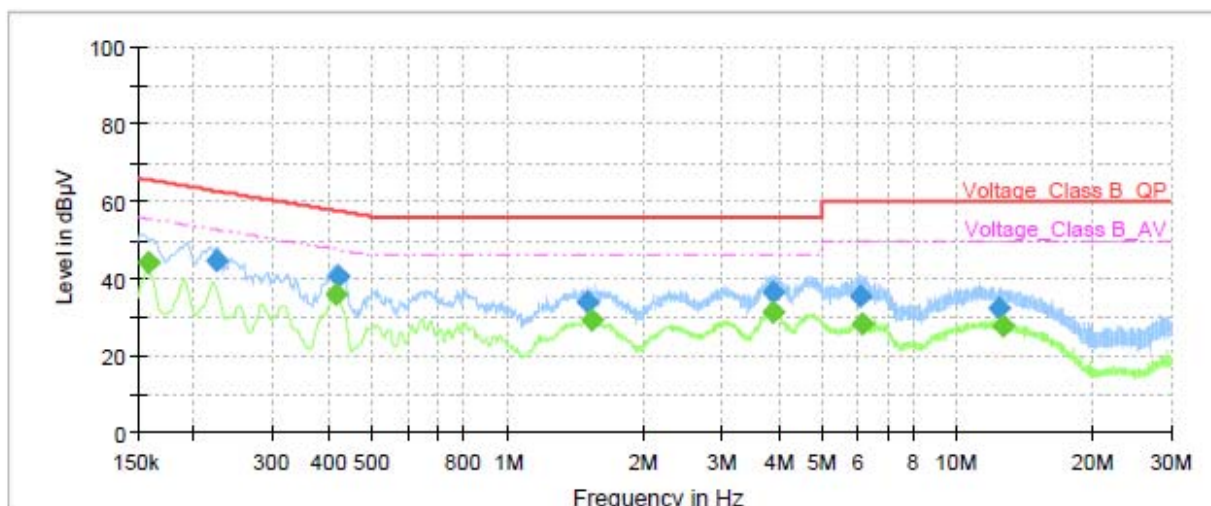

Frequency (MHz)	QuasiPeak (dBµV)	Average (dBµV)	Limit (dBµV)	Margin (dB)	Meas. Time (ms)	Bandwidth (kHz)	Line	Filter	Corr. (dB)
0.16	---	44.32	55.52	11.20	1000.0	9.000	N	ON	21.0
0.22	44.58	---	62.66	18.08	1000.0	9.000	N	ON	21.1
0.42	---	36.14	47.54	11.40	1000.0	9.000	N	ON	21.0
0.42	40.69	---	57.49	16.80	1000.0	9.000	N	ON	21.0
1.51	33.79	---	56.00	22.21	1000.0	9.000	N	ON	19.9
1.53	---	29.27	46.00	16.73	1000.0	9.000	N	ON	19.9
3.88	---	31.07	46.00	14.93	1000.0	9.000	N	ON	19.5
3.89	36.32	---	56.00	19.68	1000.0	9.000	N	ON	19.5
6.09	35.47	---	60.00	24.53	1000.0	9.000	N	ON	19.5
6.16	---	28.27	50.00	21.73	1000.0	9.000	N	ON	19.5
12.42	32.33	---	60.00	27.67	1000.0	9.000	N	ON	19.6
12.61	---	27.79	50.00	22.21	1000.0	9.000	N	ON	19.6

Remark: Correct factor=cable loss + LISN factor

N line

Conducted Emission from 150 KHz to 30 MHz

US
Adapter 4
SW-WB330TEA is the worst case

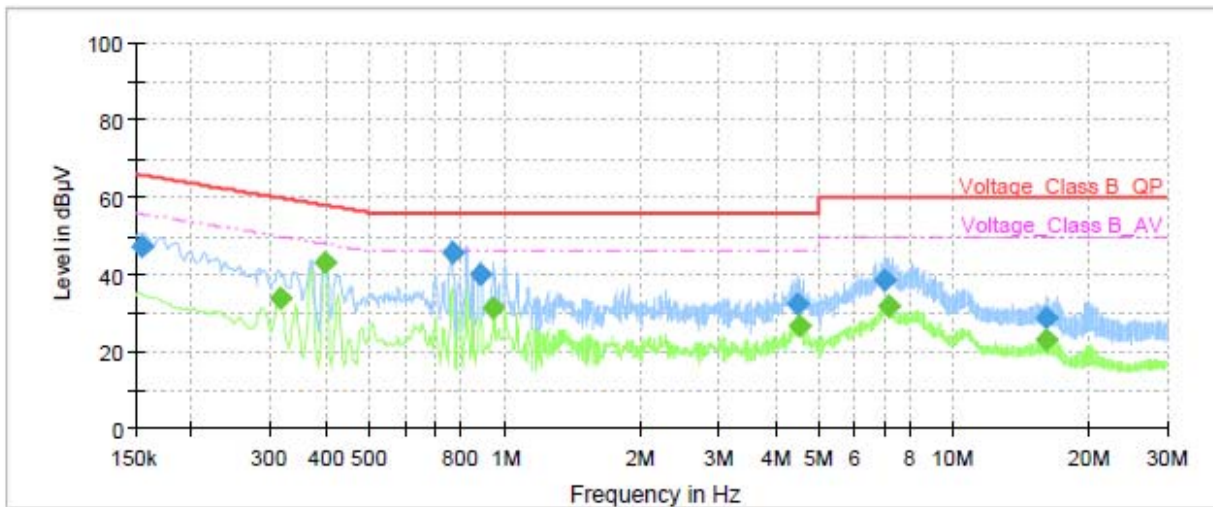

Frequency (MHz)	QuasiPeak (dBµV)	Average (dBµV)	Limit (dBµV)	Margin (dB)	Meas. Time (ms)	Bandwidth (kHz)	Line	Filter	Corr. (dB)
0.15	47.25	---	65.75	18.50	1000.0	9.000	L1	ON	21.0
0.31	---	33.67	49.86	16.19	1000.0	9.000	L1	ON	21.0
0.40	---	43.07	47.95	4.88	1000.0	9.000	L1	ON	21.0
0.76	45.66	---	56.00	10.34	1000.0	9.000	L1	ON	20.4
0.88	40.15	---	56.00	15.85	1000.0	9.000	L1	ON	20.3
0.94	---	31.14	46.00	14.86	1000.0	9.000	L1	ON	20.3
4.50	32.44	---	56.00	23.56	1000.0	9.000	L1	ON	19.5
4.52	---	26.90	46.00	19.10	1000.0	9.000	L1	ON	19.5
6.98	38.37	---	60.00	21.63	1000.0	9.000	L1	ON	19.5
7.14	---	31.90	50.00	18.10	1000.0	9.000	L1	ON	19.5
16.10	---	23.03	50.00	26.97	1000.0	9.000	L1	ON	19.6
16.10	28.89	---	60.00	31.11	1000.0	9.000	L1	ON	19.6

Remark: Correct factor=cable loss + LISN factor

L line

Conducted Emission from 150 KHz to 30 MHz

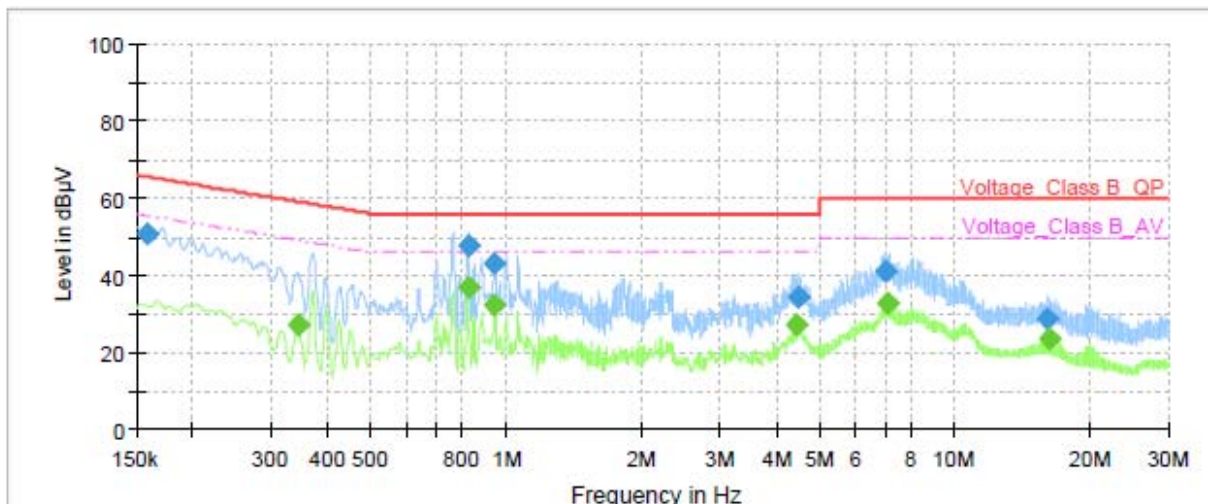

Frequency (MHz)	QuasiPeak (dBµV)	Average (dBµV)	Limit (dBµV)	Margin (dB)	Meas. Time (ms)	Bandwidth (kHz)	Line	Filter	Corr. (dB)
0.16	50.60	---	65.52	14.92	1000.0	9.000	N	ON	21.0
0.34	---	27.17	49.12	21.95	1000.0	9.000	N	ON	21.0
0.82	---	36.88	46.00	9.12	1000.0	9.000	N	ON	20.4
0.82	47.75	---	56.00	8.25	1000.0	9.000	N	ON	20.4
0.94	---	32.24	46.00	13.76	1000.0	9.000	N	ON	20.3
0.94	42.83	---	56.00	13.17	1000.0	9.000	N	ON	20.3
4.46	---	27.00	46.00	19.00	1000.0	9.000	N	ON	19.5
4.50	34.36	---	56.00	21.64	1000.0	9.000	N	ON	19.5
7.02	40.99	---	60.00	19.01	1000.0	9.000	N	ON	19.5
7.08	---	32.74	50.00	17.26	1000.0	9.000	N	ON	19.5
16.04	28.96	---	60.00	31.04	1000.0	9.000	N	ON	19.7
16.35	---	23.65	50.00	26.35	1000.0	9.000	N	ON	19.7

Remark: Correct factor=cable loss + LISN factor

N line

Conducted Emission from 150 KHz to 30 MHz

EU
Adapter 5
SW-WB330TC6 is the worst case

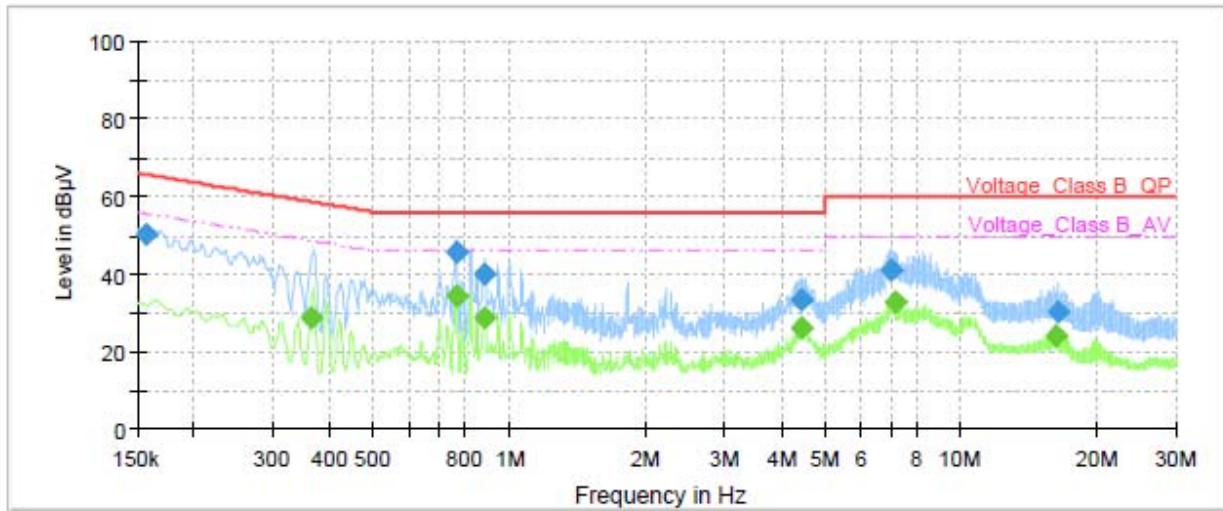

Frequency (MHz)	QuasiPeak (dBµV)	Average (dBµV)	Limit (dBµV)	Margin (dB)	Meas. Time (ms)	Bandwidth (kHz)	Line	Filter	Corr. (dB)
0.16	50.25	---	65.63	15.38	1000.0	9.000	L1	ON	21.0
0.36	---	28.78	48.69	19.91	1000.0	9.000	L1	ON	21.0
0.76	---	34.17	46.00	11.83	1000.0	9.000	L1	ON	20.4
0.76	45.45	---	56.00	10.55	1000.0	9.000	L1	ON	20.4
0.88	---	28.69	46.00	17.31	1000.0	9.000	L1	ON	20.3
0.88	40.16	---	56.00	15.84	1000.0	9.000	L1	ON	20.3
4.46	33.57	---	56.00	22.43	1000.0	9.000	L1	ON	19.5
4.46	---	25.98	46.00	20.02	1000.0	9.000	L1	ON	19.5
7.02	41.21	---	60.00	18.79	1000.0	9.000	L1	ON	19.5
7.14	---	32.79	50.00	17.21	1000.0	9.000	L1	ON	19.5
16.28	---	24.02	50.00	25.98	1000.0	9.000	L1	ON	19.6
16.40	30.11	---	60.00	29.89	1000.0	9.000	L1	ON	19.7

Remark: Correct factor=cable loss + LISN factor

L line

Conducted Emission from 150 KHz to 30 MHz

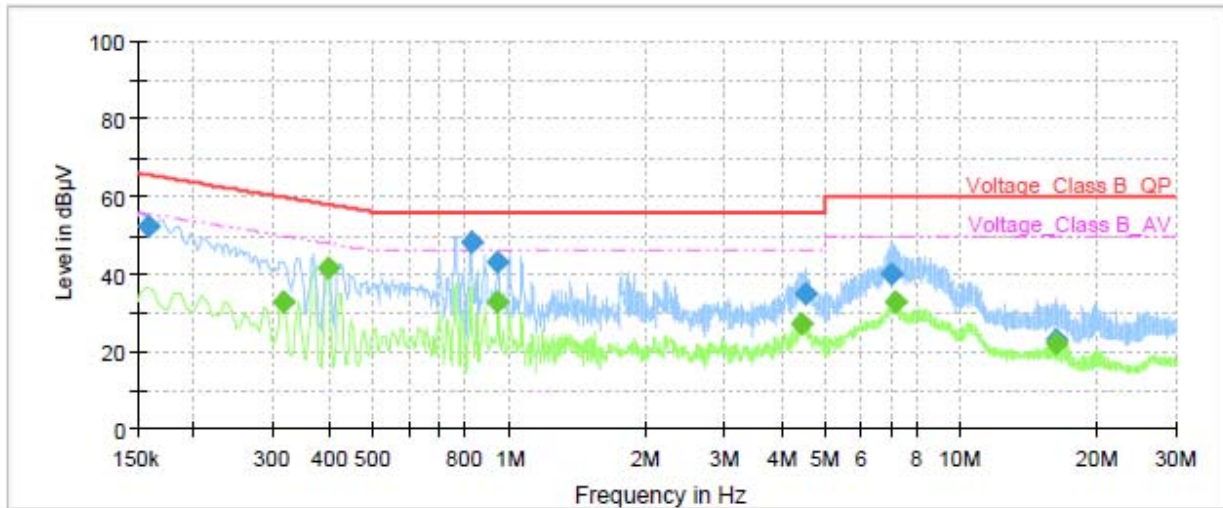

Frequency (MHz)	QuasiPeak (dBµV)	Average (dBµV)	Limit (dBµV)	Margin (dB)	Meas. Time (ms)	Bandwidth (kHz)	Line	Filter	Corr. (dB)
0.16	52.24	---	65.52	13.28	1000.0	9.000	N	ON	21.0
0.31	---	32.94	49.86	16.92	1000.0	9.000	N	ON	21.0
0.40	---	41.48	47.95	6.47	1000.0	9.000	N	ON	21.0
0.82	48.05	---	56.00	7.95	1000.0	9.000	N	ON	20.4
0.94	---	32.96	46.00	13.04	1000.0	9.000	N	ON	20.3
0.94	43.18	---	56.00	12.82	1000.0	9.000	N	ON	20.3
4.45	---	26.98	46.00	19.02	1000.0	9.000	N	ON	19.5
4.52	34.74	---	56.00	21.26	1000.0	9.000	N	ON	19.5
6.99	39.75	---	60.00	20.25	1000.0	9.000	N	ON	19.5
7.14	---	33.01	50.00	16.99	1000.0	9.000	N	ON	19.5
16.22	---	22.02	50.00	27.98	1000.0	9.000	N	ON	19.7
16.24	23.17	---	60.00	36.83	1000.0	9.000	N	ON	19.7

Remark: Correct factor=cable loss + LISN factor

N line

Conducted Emission from 150 KHz to 30 MHz

UK
Adapter 6
SW-WB330BA

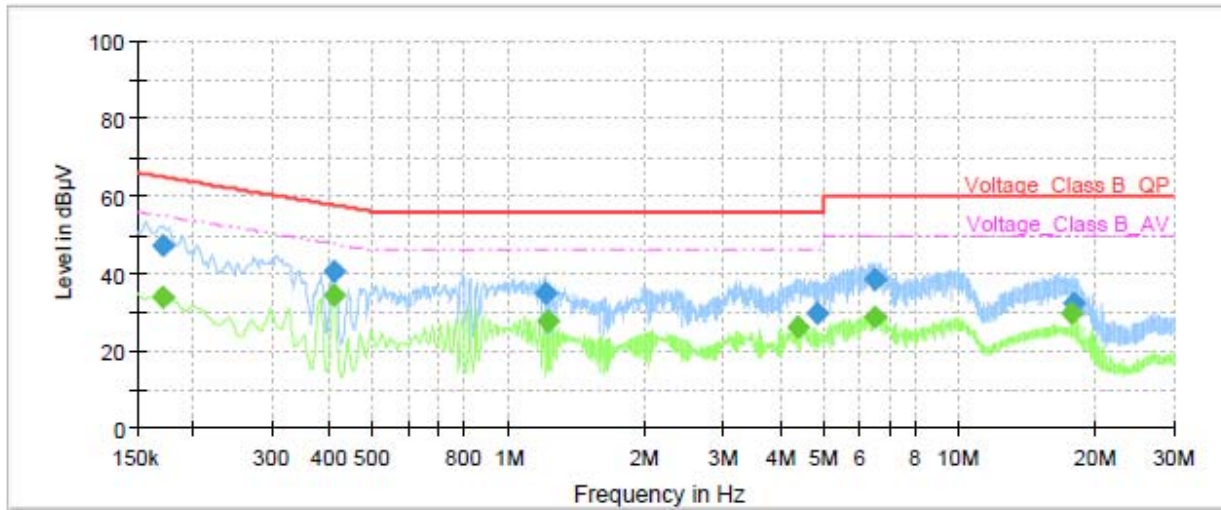

Frequency (MHz)	QuasiPeak (dBµV)	Average (dBµV)	Limit (dBµV)	Margin (dB)	Meas. Time (ms)	Bandwidth (kHz)	Line	Filter	Corr. (dB)
0.17	---	33.83	54.95	21.12	1000.0	9.000	L1	ON	21.0
0.17	47.15	---	64.95	17.80	1000.0	9.000	L1	ON	21.0
0.41	---	34.41	47.67	13.26	1000.0	9.000	L1	ON	21.0
0.41	40.36	---	57.67	17.31	1000.0	9.000	L1	ON	21.0
1.20	35.09	---	56.00	20.91	1000.0	9.000	L1	ON	20.1
1.23	---	27.56	46.00	18.44	1000.0	9.000	L1	ON	20.1
4.40	---	26.15	46.00	19.85	1000.0	9.000	L1	ON	19.5
4.86	29.78	---	56.00	26.22	1000.0	9.000	L1	ON	19.5
6.48	---	28.49	50.00	21.51	1000.0	9.000	L1	ON	19.5
6.49	38.54	---	60.00	21.46	1000.0	9.000	L1	ON	19.5
17.69	---	29.93	50.00	20.07	1000.0	9.000	L1	ON	19.7
17.94	32.37	---	60.00	27.63	1000.0	9.000	L1	ON	19.7

Remark: Correct factor=cable loss + LISN factor

L line

Conducted Emission from 150 KHz to 30 MHz

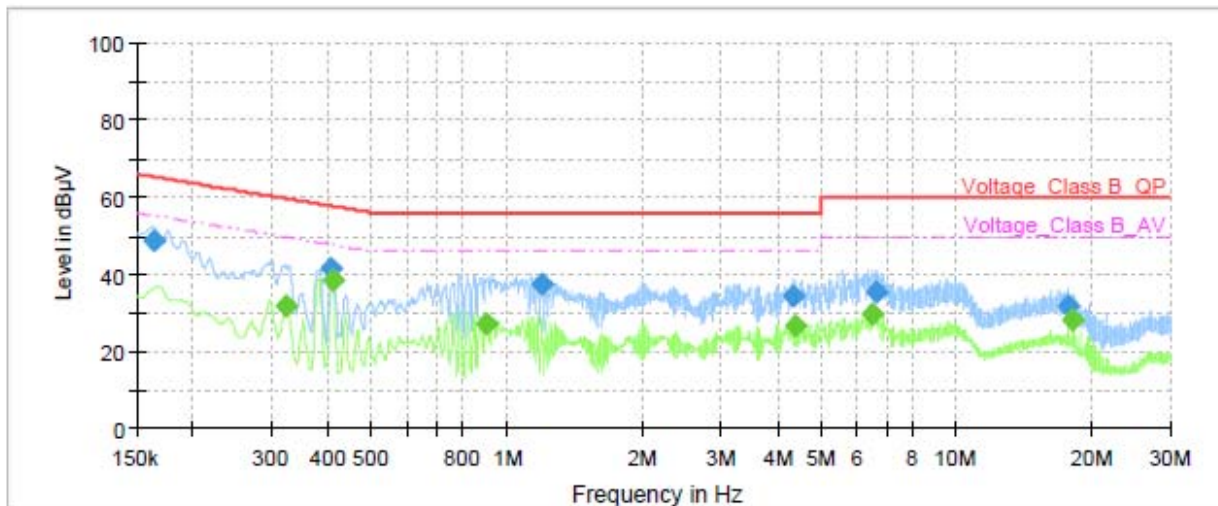

Frequency (MHz)	QuasiPeak (dBµV)	Average (dBµV)	Limit (dBµV)	Margin (dB)	Meas. Time (ms)	Bandwidth (kHz)	Line	Filter	Corr. (dB)
0.16	48.94	---	65.28	16.34	1000.0	9.000	N	ON	21.0
0.32	---	31.93	49.62	17.69	1000.0	9.000	N	ON	21.0
0.41	41.75	---	57.72	15.97	1000.0	9.000	N	ON	21.0
0.41	---	38.68	47.67	8.99	1000.0	9.000	N	ON	21.0
0.90	---	27.07	46.00	18.93	1000.0	9.000	N	ON	20.3
1.19	37.65	---	56.00	18.35	1000.0	9.000	N	ON	20.1
4.34	34.39	---	56.00	21.61	1000.0	9.000	N	ON	19.5
4.37	---	26.73	46.00	19.27	1000.0	9.000	N	ON	19.5
6.52	---	29.59	50.00	20.41	1000.0	9.000	N	ON	19.5
6.67	35.23	---	60.00	24.77	1000.0	9.000	N	ON	19.5
17.70	32.04	---	60.00	27.96	1000.0	9.000	N	ON	19.7
18.24	---	28.23	50.00	21.77	1000.0	9.000	N	ON	19.7

Remark: Correct factor=cable loss + LISN factor

N line

Conducted Emission from 150 KHz to 30 MHz

4 Uncertainty Measurement

Case	Uncertainty	Factor k
Radiated Emission 30MHz – 200MHz	4.17 dB	1.96
Radiated Emission 200MHz – 1GHz	4.84 dB	1.96
Radiated Emission 1GHz – 18GHz	4.35 dB	1.96
Radiated Emission 18GHz – 26.5GHz	5.90 dB	1.96
Radiated Emission 26.5GHz – 40GHz	5.92 dB	1.96
Conducted Emission	2.57 dB	2

5 Main Test Instruments

Name of Equipment	Manufacturer	Type/Model	Serial Number	Calibration Date	Expiration Time
Radiated Emission					
EMI Test Receiver	R&S	ESCI3	100948	2023-05-12	2024-05-11
Signal Analyzer	R&S	FSV40	101298	2023-05-12	2024-05-11
TRILOG Broadband Antenna	SCHWARZBECK	VULB 9163	01111	2022-10-25	2025-10-24
Horn Antenna	R&S	HF907	102723	2021-07-24	2024-07-23
Horn Antenna	ETS-Lindgren	3160-09	00102643	2021-10-10	2024-10-09
Horn Antenna	STEATITE	QSH-SL-26-40-K-15	16779	2023-01-17	2026-01-16
Software	R&S	EMC32	9.26.01	/	/
Conducted Emission					
Artificial main network	R&S	ENV216	102191	2022-12-13	2024-12-09
EMI Test Receiver	R&S	ESR	101667	2023-05-12	2024-05-11
Software	R&S	EMC32	10.35.10	/	/

ANNEX A: The EUT Appearance

The EUT Appearance are submitted separately.

ANNEX B: Test Setup Photos

The Test Setup Photos are submitted separately.

***** END OF REPORT *****