

RE 18-26.5GHz PK+AV

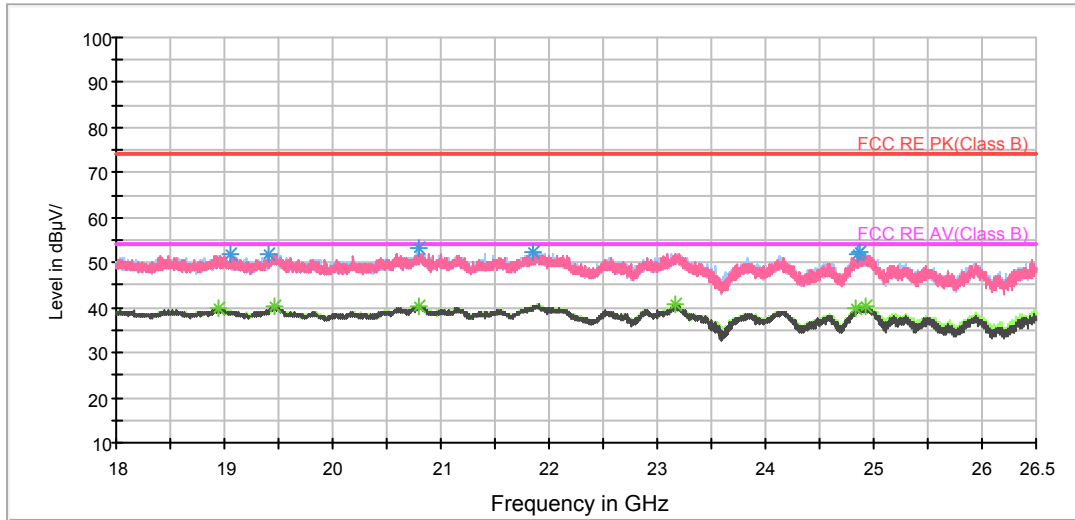

Radiates Emission from 18GHz to 26GHz

Frequency (MHz)	Peak (dBuV/m)	Polarization	Azimuth (deg)	Reading value (dBuV/m)	Correct Factor (dB)	Margin (dB)	Limit (dBuV/m)
19058.250000	51.8	H	0.0	52.2	-0.4	22.2	74
19405.687500	51.8	V	284.0	51.8	0.0	22.2	74
20795.437500	53.2	V	155.0	55.1	-1.9	20.8	74
21844.125000	52.2	H	215.0	54.1	-1.9	21.8	74
24843.562500	51.7	V	0.0	51.4	0.3	22.3	74
24864.812500	52.3	V	246.0	51.9	0.4	21.7	74

Remark: 1. Correction Factor = Antenna factor+ Insertion loss (cable loss + amplifier gain)

Frequency (MHz)	Average (dBuV/m)	Polarization	Azimuth (deg)	Reading value (dBuV/m)	Correct Factor (dB)	Margin (dB)	Limit (dBuV/m)
18942.437500	39.6	V	256.0	39.6	0.0	14.4	54
19470.500000	40.5	V	29.0	40.4	0.1	13.5	54
20797.562500	40.4	V	74.0	42.3	-1.9	13.6	54
23158.437500	40.8	H	0.0	40.9	-0.1	13.2	54
24842.500000	39.7	V	38.0	39.4	0.3	14.3	54
24927.500000	40.3	H	278.0	39.6	0.7	13.7	54

Remark: 1. Correction Factor = Antenna factor+ Insertion loss (cable loss + amplifier gain)



802.11g CH6

FCC RE 0.03-1GHz QP Class B

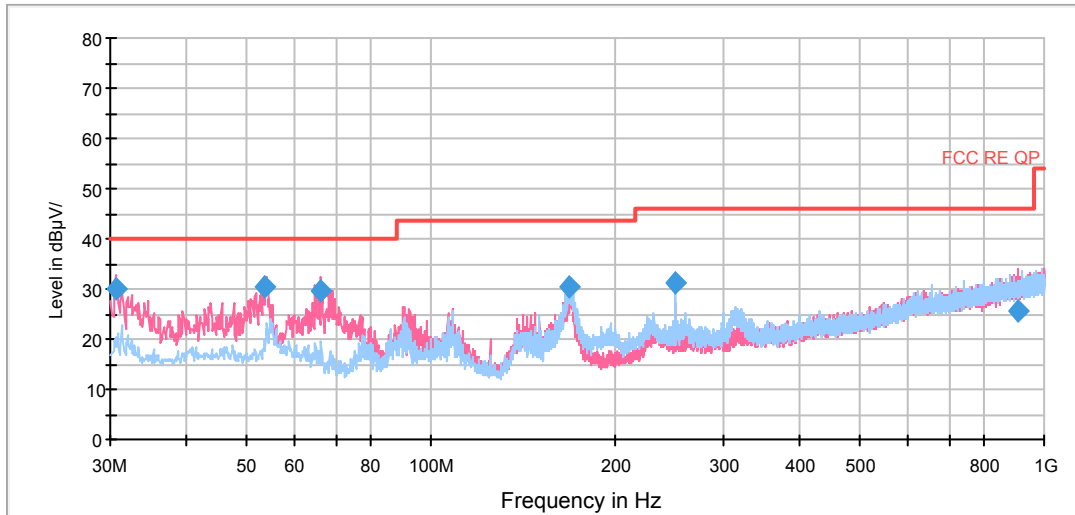

Radiates Emission from 30MHz to 1GHz

Frequency (MHz)	Quasi-Peak (dBuV/m)	Height (cm)	Polarization	Azimuth (deg)	Reading value (dBuV/m)	Correct Factor (dB)	Margin (dB)	Limit (dBuV/m)
30.606250	30.2	100.0	V	325.0	18.1	12.1	9.8	40.0
53.568750	30.4	100.0	V	57.0	17.6	12.8	9.6	40.0
66.293750	29.8	113.0	V	68.0	19.6	10.2	10.2	40.0
168.582500	30.4	202.0	H	128.0	20.2	10.2	13.1	43.5
249.987500	31.3	125.0	H	92.0	16.9	14.4	14.7	46.0
907.201250	25.5	189.0	V	185.0	-1.5	27.0	20.5	46.0

- Remark: 1. Quasi-Peak = Reading value + Correction factor
 2. Correction Factor = Antenna factor+ Insertion loss(cable loss+amplifier gain)
 3. Margin = Limit – Quasi-Peak

RE 1G-3GHz PK+AV

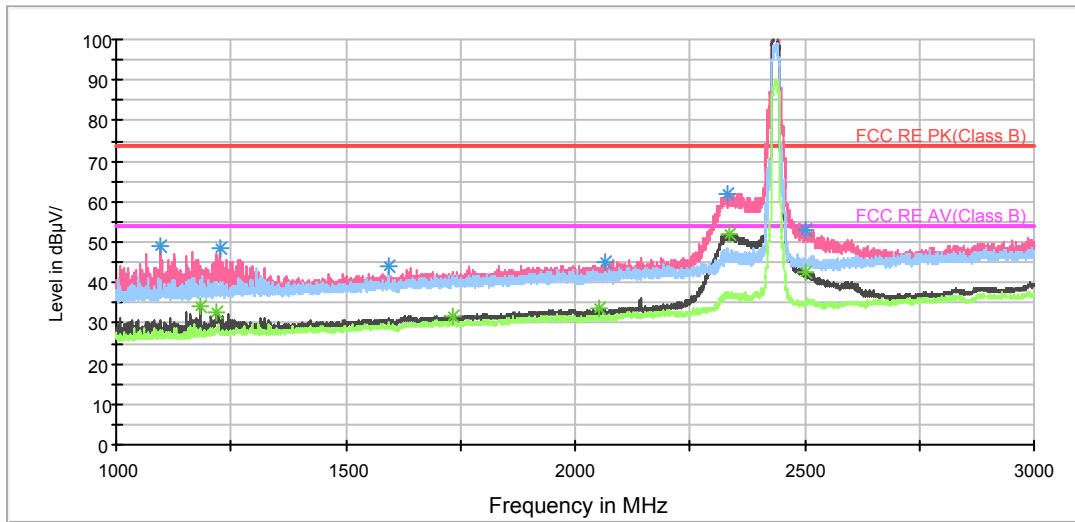

Note: The signal beyond the limit is carrier.

Radiates Emission from 1GHz to 3GHz

Frequency (MHz)	Peak (dBuV/m)	Height (cm)	Polarization	Azimuth (deg)	Reading value (dBuV/m)	Correct Factor (dB)	Margin (dB)	Limit (dBuV/m)
1095.250000	48.8	100.0	V	329.0	57.7	-8.9	25.2	74
1225.000000	48.7	100.0	V	314.0	56.5	-7.8	25.3	74
1593.500000	44.2	100.0	H	189.0	50.6	-6.4	29.8	74
2067.500000	45.1	100.0	V	314.0	48.2	-3.1	28.9	74
2333.500000	62.0	100.0	V	92.0	63.4	-1.4	12.0	74
2502.500000	52.8	100.0	V	114.0	53.0	-0.2	21.2	74

Remark: 1. Correction Factor = Antenna factor+ Insertion loss (cable loss + amplifier gain)

Frequency (MHz)	Average (dBuV/m)	Height (cm)	Polarization	Azimuth (deg)	Reading value (dBuV/m)	Correct Factor (dB)	Margin (dB)	Limit (dBuV/m)
1182.500000	34.0	100.0	V	314.0	42.0	-8.0	20.0	54
1218.750000	32.8	100.0	V	329.0	40.7	-7.9	21.2	54
1731.500000	31.6	100.0	V	233.0	36.4	-4.8	22.4	54
2052.750000	33.7	100.0	V	292.0	36.9	-3.2	20.3	54
2334.500000	51.9	100.0	V	92.0	53.3	-1.4	2.1	54
2501.250000	42.7	100.0	V	114.0	42.9	-0.2	11.3	54

Remark: 1. Correction Factor = Antenna factor+ Insertion loss (cable loss + amplifier gain)

RE 3-18GHz PK+AV

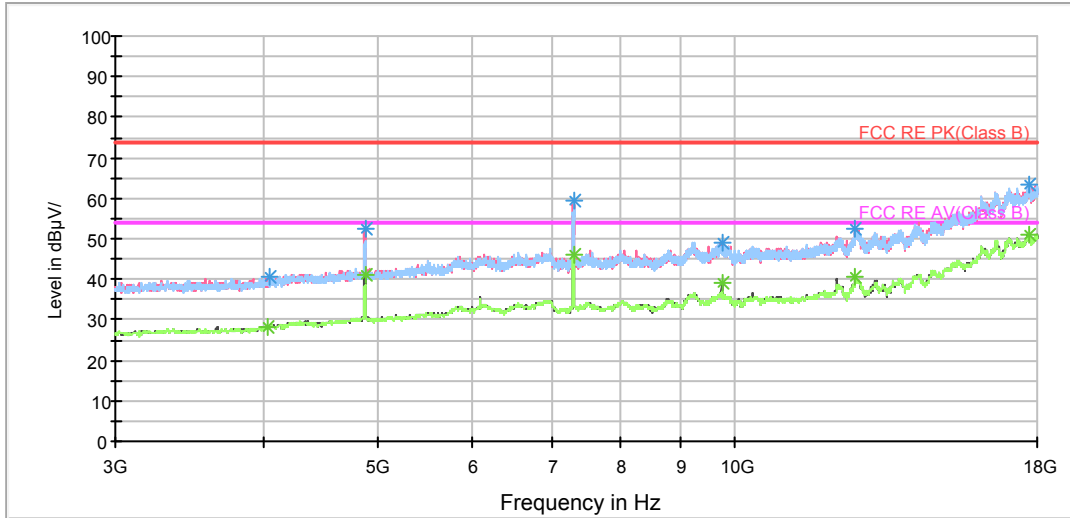

Radiates Emission from 3GHz to 18GHz

Frequency (MHz)	Peak (dBuV/m)	Height (cm)	Polarization	Azimuth (deg)	Reading value (dBuV/m)	Correct Factor (dB)	Margin (dB)	Limit (dBuV/m)
4042.500000	40.4	205.0	V	62.0	41.4	-1.0	33.6	74
4876.875000	52.4	205.0	V	269.0	50.6	1.8	21.6	74
7316.250000	59.2	205.0	H	342.0	52.2	7.0	14.8	74
9748.125000	49.2	205.0	V	84.0	39.4	9.8	24.8	74
12639.375000	52.6	205.0	V	84.0	38.1	14.5	21.4	74
17696.250000	63.3	205.0	H	252.0	38.6	24.7	10.7	74

Remark: 1. Correction Factor = Antenna factor+ Insertion loss (cable loss + amplifier gain)

Frequency (MHz)	Average (dBuV/m)	Height (cm)	Polarization	Azimuth (deg)	Reading value (dBuV/m)	Correct Factor (dB)	Margin (dB)	Limit (dBuV/m)
4031.250000	28.3	205.0	V	0.0	29.4	-1.1	25.7	54
4875.000000	41.2	205.0	V	269.0	39.4	1.8	12.8	54
7312.500000	45.9	205.0	H	342.0	38.9	7.0	8.1	54
9748.125000	39.2	205.0	V	84.0	29.4	9.8	14.8	54
12643.125000	40.7	105.0	H	316.0	26.3	14.4	13.3	54
17703.750000	51.2	105.0	H	177.0	26.5	24.7	2.8	54

Remark: 1. Correction Factor = Antenna factor+ Insertion loss (cable loss + amplifier gain)

RE 18-26.5GHz PK+AV

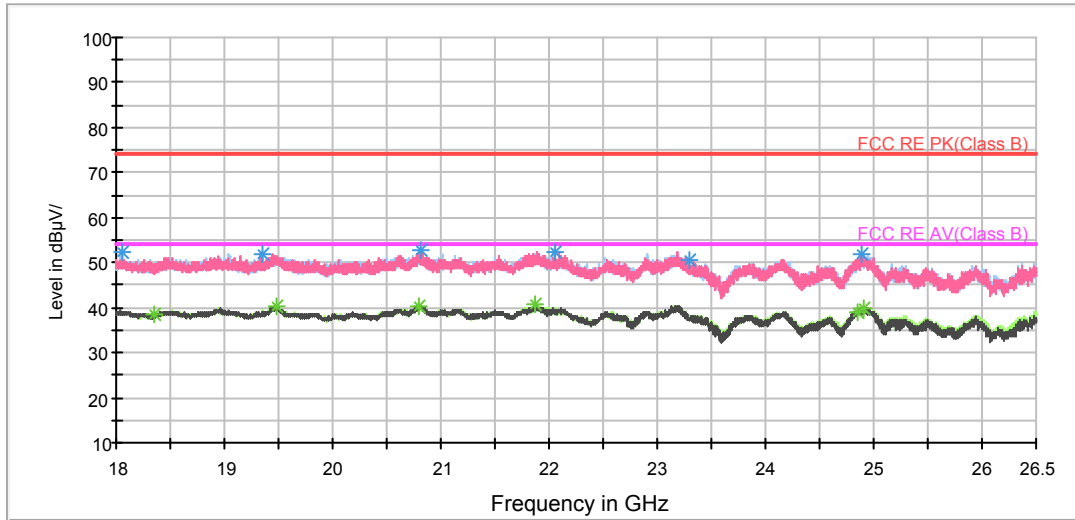

Radiates Emission from 18GHz to 26GHz

Frequency (MHz)	Peak (dBuV/m)	Polarization	Azimuth (deg)	Reading value (dBuV/m)	Correct Factor (dB)	Margin (dB)	Limit (dBuV/m)
18047.812500	52.1	H	0.0	50.7	1.4	21.9	74
19354.687500	52.0	H	259.0	52.1	-0.1	22.0	74
20818.812500	52.9	V	118.0	55.0	-2.1	21.1	74
22047.062500	52.4	H	0.0	53.8	-1.4	21.6	74
23295.500000	50.5	H	183.0	50.6	-0.1	23.5	74
24880.750000	51.9	H	211.0	51.4	0.5	22.1	74

Remark: 1. Correction Factor = Antenna factor+ Insertion loss (cable loss + amplifier gain)

Frequency (MHz)	Average (dBuV/m)	Polarization	Azimuth (deg)	Reading value (dBuV/m)	Correct Factor (dB)	Margin (dB)	Limit (dBuV/m)
18344.250000	38.6	H	221.0	37.9	0.7	15.4	54
19472.625000	40.3	H	334.0	40.2	0.1	13.7	54
20800.750000	40.3	V	43.0	42.3	-2.0	13.7	54
21878.125000	40.7	V	320.0	42.4	-1.7	13.3	54
24843.562500	39.2	H	316.0	38.9	0.3	14.8	54
24904.125000	39.9	H	87.0	39.3	0.6	14.1	54

Remark: 1. Correction Factor = Antenna factor+ Insertion loss (cable loss + amplifier gain)



802.11g CH11

FCC RE 0.03-1GHz QP Class B

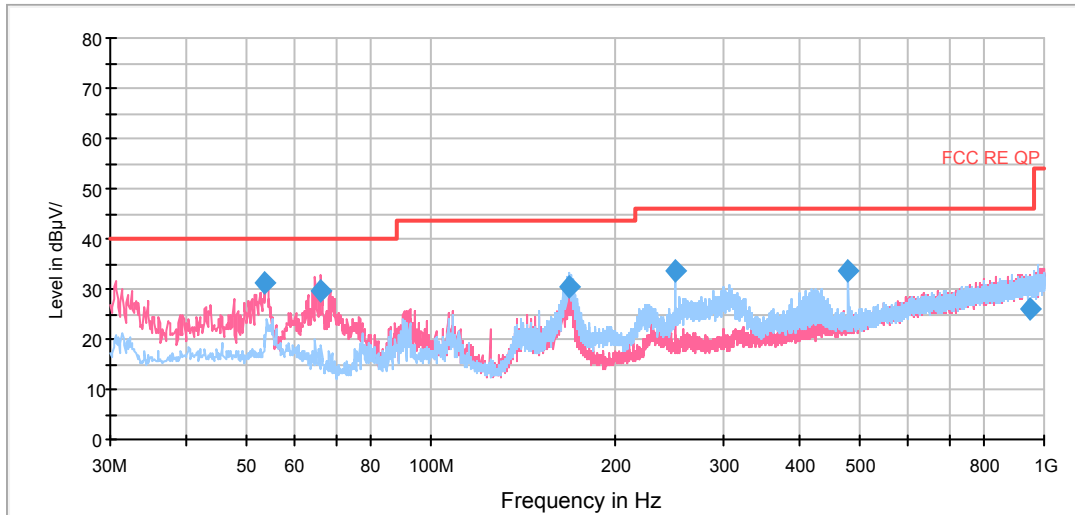

Radiates Emission from 30MHz to 1GHz

Frequency (MHz)	Quasi-Peak (dBuV/m)	Height (cm)	Polarization	Azimuth (deg)	Reading value (dBuV/m)	Correct Factor (dB)	Margin (dB)	Limit (dBuV/m)
53.562500	31.2	100.0	V	38.0	18.4	12.8	8.8	40.0
66.253750	29.8	114.0	V	22.0	19.6	10.2	10.2	40.0
168.223750	30.4	175.0	H	128.0	20.2	10.2	13.1	43.5
249.988750	33.7	125.0	H	101.0	19.3	14.4	12.3	46.0
479.998750	33.6	175.0	H	95.0	13.4	20.2	12.4	46.0
951.021250	26.0	175.0	V	135.0	-1.3	27.3	20.0	46.0

- Remark: 1. Quasi-Peak = Reading value + Correction factor
 2. Correction Factor = Antenna factor+ Insertion loss(cable loss+amplifier gain)
 3. Margin = Limit – Quasi-Peak

RE 1G-3GHz PK+AV

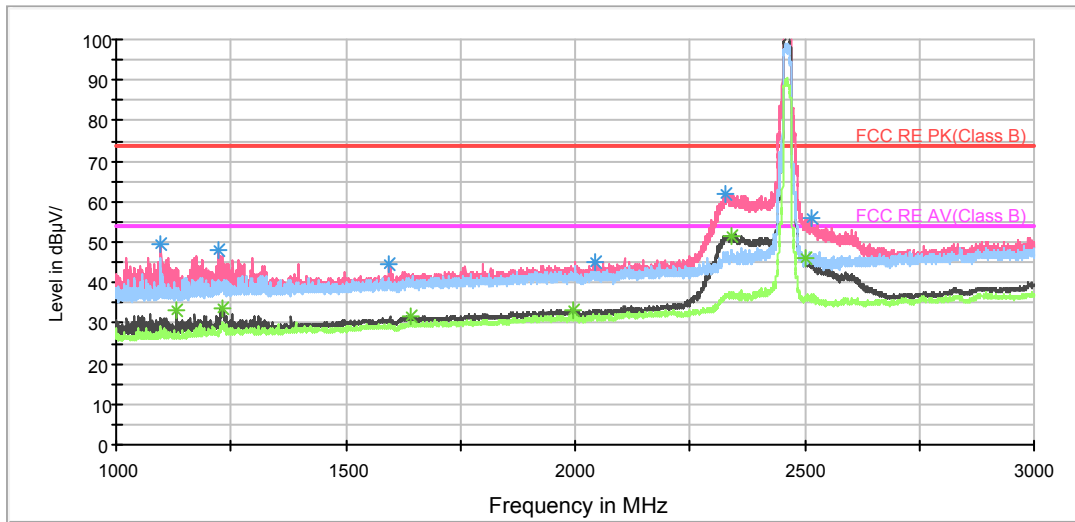

Note: The signal beyond the limit is carrier.

Radiates Emission from 1GHz to 3GHz

Frequency (MHz)	Peak (dBuV/m)	Height (cm)	Polarization	Azimuth (deg)	Reading value (dBuV/m)	Correct Factor (dB)	Margin (dB)	Limit (dBuV/m)
1096.000000	49.4	100.0	V	280.0	58.3	-8.9	24.6	74
1224.000000	47.9	100.0	V	325.0	55.7	-7.8	26.1	74
1592.750000	44.7	100.0	V	317.0	51.1	-6.4	29.3	74
2045.750000	45.3	100.0	V	303.0	48.5	-3.2	28.7	74
2326.250000	61.8	100.0	V	81.0	63.4	-1.6	12.2	74
2516.000000	55.9	100.0	V	72.0	56.1	-0.2	18.1	74

Remark: 1. Correction Factor = Antenna factor+ Insertion loss (cable loss + amplifier gain)

Frequency (MHz)	Average (dBuV/m)	Height (cm)	Polarization	Azimuth (deg)	Reading value (dBuV/m)	Correct Factor (dB)	Margin (dB)	Limit (dBuV/m)
1131.250000	32.9	100.0	V	310.0	41.3	-8.4	21.1	54
1232.250000	33.8	100.0	V	0.0	41.6	-7.8	20.2	54
1642.500000	31.7	100.0	V	0.0	36.5	-4.8	22.3	54
1994.000000	33.4	100.0	V	0.0	36.6	-3.2	20.6	54
2339.250000	51.7	100.0	V	81.0	53.0	-1.3	2.3	54
2503.000000	45.9	100.0	V	112.0	46.1	-0.2	8.1	54

Remark: 1. Correction Factor = Antenna factor+ Insertion loss (cable loss + amplifier gain)

RE 3-18GHz PK+AV

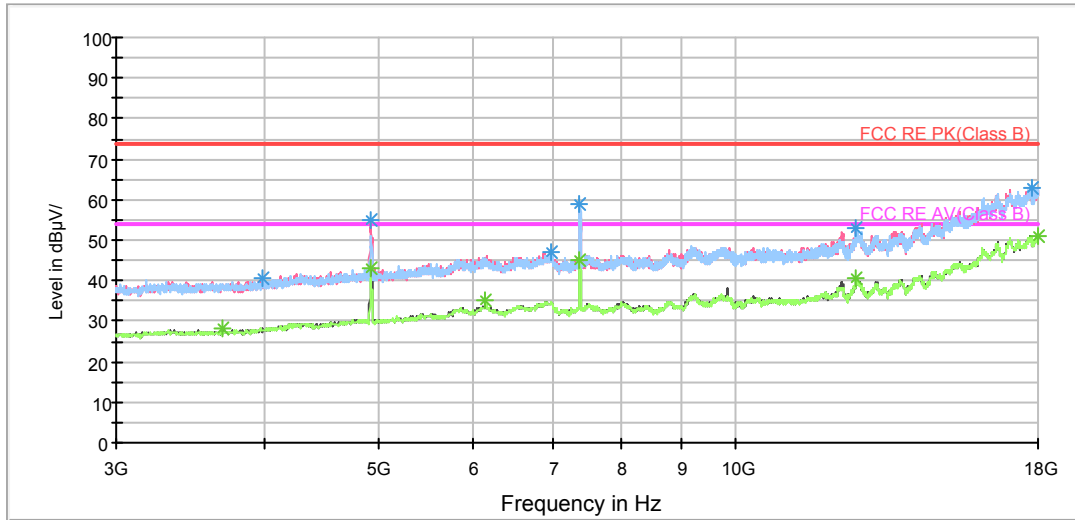

Radiates Emission from 3GHz to 18GHz

Frequency (MHz)	Peak (dBuV/m)	Height (cm)	Polarization	Azimuth (deg)	Reading value (dBuV/m)	Correct Factor (dB)	Margin (dB)	Limit (dBuV/m)
3984.375000	40.8	105.0	V	0.0	41.8	-1.0	33.2	74
4918.125000	55.2	205.0	V	268.0	53.3	1.9	18.8	74
6978.750000	47.1	105.0	V	0.0	40.8	6.3	26.9	74
7391.250000	58.8	205.0	H	347.0	51.9	6.9	15.2	74
12639.375000	52.8	105.0	H	0.0	38.3	14.5	21.2	74
17763.750000	62.8	205.0	V	16.0	38.5	24.3	11.2	74

Remark: 1. Correction Factor = Antenna factor+ Insertion loss (cable loss + amplifier gain)

Frequency (MHz)	Average (dBuV/m)	Height (cm)	Polarization	Azimuth (deg)	Reading value (dBuV/m)	Correct Factor (dB)	Margin (dB)	Limit (dBuV/m)
3693.750000	28.4	105.0	V	298.0	30.0	-1.6	25.6	54
4921.875000	43.0	205.0	V	268.0	41.1	1.9	11.0	54
6153.750000	35.4	205.0	V	0.0	29.8	5.6	18.6	54
7387.500000	44.9	205.0	H	347.0	37.9	7.0	9.1	54
12641.250000	40.7	105.0	V	160.0	26.2	14.5	13.3	54
18000.000000	51.1	205.0	V	198.0	25.6	25.5	2.9	54

Remark: 1. Correction Factor = Antenna factor+ Insertion loss (cable loss + amplifier gain)

RE 18-26.5GHz PK+AV

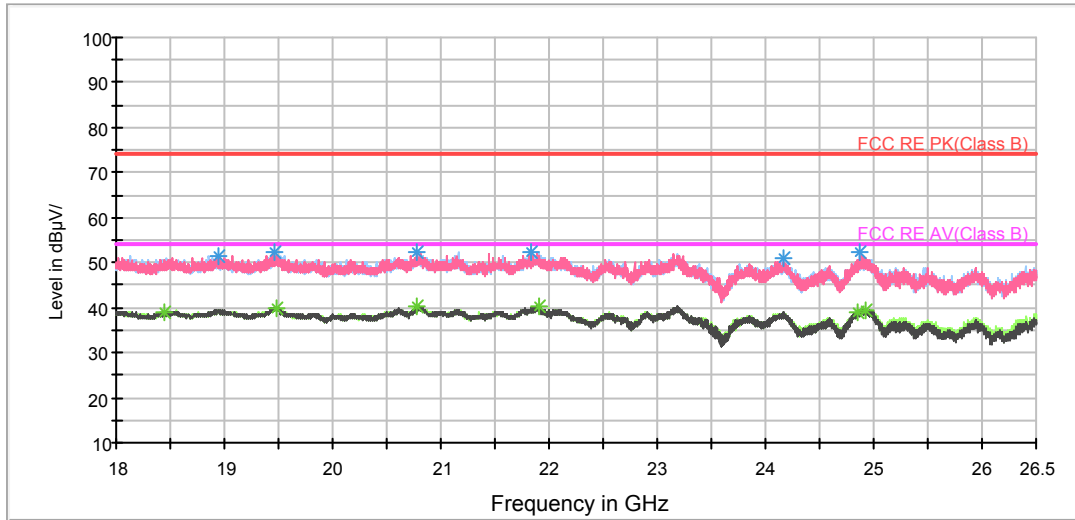

Radiates Emission from 18GHz to 26GHz

Frequency (MHz)	Peak (dBuV/m)	Polarization	Azimuth (deg)	Reading value (dBuV/m)	Correct Factor (dB)	Margin (dB)	Limit (dBuV/m)
18950.937500	51.5	H	259.0	51.5	0.0	22.5	74
19464.125000	52.2	H	58.0	52.1	0.1	21.8	74
20786.937500	52.5	V	120.0	54.4	-1.9	21.5	74
21840.937500	52.3	V	103.0	54.2	-1.9	21.7	74
24167.812500	50.8	H	0.0	51.5	-0.7	23.2	74
24870.125000	52.2	H	0.0	51.8	0.4	21.8	74

Remark: 1. Correction Factor = Antenna factor+ Insertion loss (cable loss + amplifier gain)

Frequency (MHz)	Average (dBuV/m)	Polarization	Azimuth (deg)	Reading value (dBuV/m)	Correct Factor (dB)	Margin (dB)	Limit (dBuV/m)
18442.000000	39.0	H	0.0	38.5	0.5	15.0	54
19473.687500	40.0	H	322.0	39.9	0.1	14.0	54
20783.750000	40.2	V	201.0	42.1	-1.9	13.8	54
21907.875000	40.4	H	186.0	41.9	-1.5	13.6	54
24843.562500	39.2	V	40.0	38.9	0.3	14.8	54
24928.562500	39.5	H	204.0	38.8	0.7	14.5	54

Remark: 1. Correction Factor = Antenna factor+ Insertion loss (cable loss + amplifier gain)

MIMO

802.11n (HT20) CH1

FCC RE 0.03-1GHz QP Class B

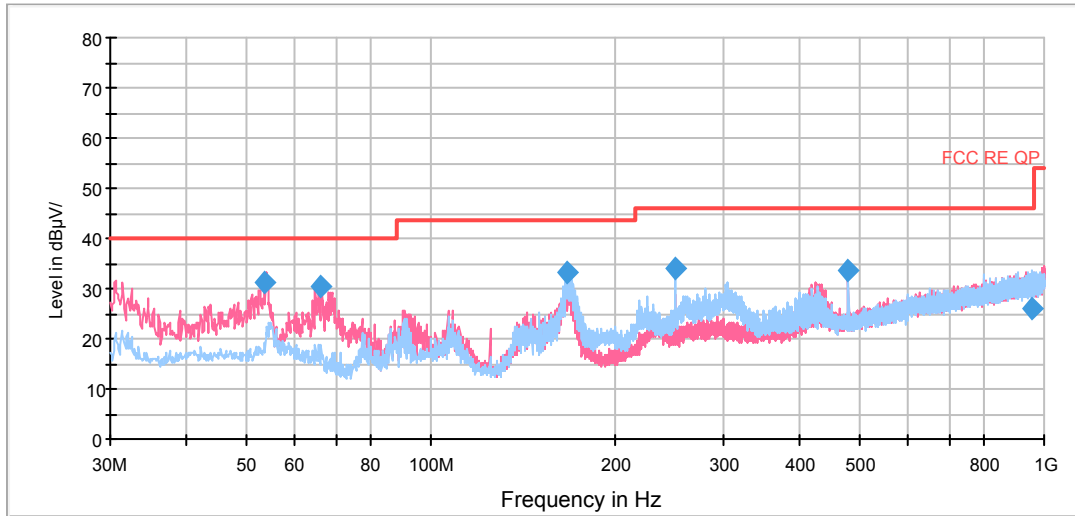

Radiates Emission from 30MHz to 1GHz

Frequency (MHz)	Quasi-Peak (dBuV/m)	Height (cm)	Polarization	Azimuth (deg)	Reading value (dBuV/m)	Correct Factor (dB)	Margin (dB)	Limit (dBuV/m)
53.566250	31.1	100.0	V	30.0	18.3	12.8	8.9	40.0
66.293750	30.3	114.0	V	62.0	20.1	10.2	9.7	40.0
167.295000	33.2	175.0	H	111.0	23.0	10.2	10.3	43.5
249.987500	34.0	125.0	H	90.0	19.6	14.4	12.0	46.0
479.998750	33.5	175.0	H	95.0	13.3	20.2	12.5	46.0
953.963750	26.0	175.0	H	55.0	-1.2	27.2	20.0	46.0

- Remark:**
1. Quasi-Peak = Reading value + Correction factor
 2. Correction Factor = Antenna factor+ Insertion loss(cable loss+amplifier gain)
 3. Margin = Limit – Quasi-Peak

RE 1G-3GHz PK+AV

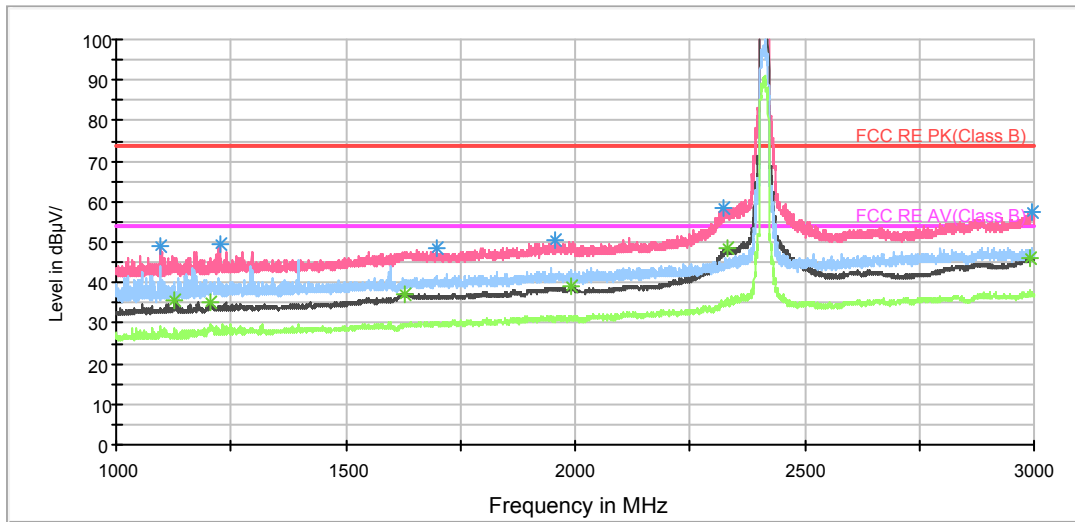

Note: The signal beyond the limit is carrier.

Radiates Emission from 1GHz to 3GHz

Frequency (MHz)	Peak (dBuV/m)	Height (cm)	Polarization	Azimuth (deg)	Reading value (dBuV/m)	Correct Factor (dB)	Margin (dB)	Limit (dBuV/m)
1096.750000	48.9	100.0	V	0.0	57.8	-8.9	25.1	74
1225.000000	49.4	100.0	V	328.0	57.2	-7.8	24.6	74
1700.000000	48.5	100.0	V	342.0	53.4	-4.9	25.5	74
1954.250000	50.7	100.0	V	263.0	54.3	-3.6	23.3	74
2322.250000	58.5	100.0	V	56.0	60.2	-1.7	15.5	74
2997.250000	57.7	100.0	V	357.0	55.4	2.3	16.3	74

Remark: 1. Correction Factor = Antenna factor+ Insertion loss (cable loss + amplifier gain)

Frequency (MHz)	Average (dBuV/m)	Height (cm)	Polarization	Azimuth (deg)	Reading value (dBuV/m)	Correct Factor (dB)	Margin (dB)	Limit (dBuV/m)
1127.750000	35.5	100.0	V	314.0	43.9	-8.4	18.5	54
1203.750000	35.1	100.0	V	342.0	43.3	-8.2	18.9	54
1629.250000	37.3	100.0	V	248.0	42.0	-4.7	16.7	54
1992.750000	39.0	100.0	V	357.0	42.3	-3.3	15.0	54
2331.250000	48.3	100.0	V	154.0	49.8	-1.5	5.7	54
2990.750000	46.2	100.0	V	342.0	44.0	2.2	7.8	54

Remark: 1. Correction Factor = Antenna factor+ Insertion loss (cable loss + amplifier gain)

RE 3-18GHz PK+AV

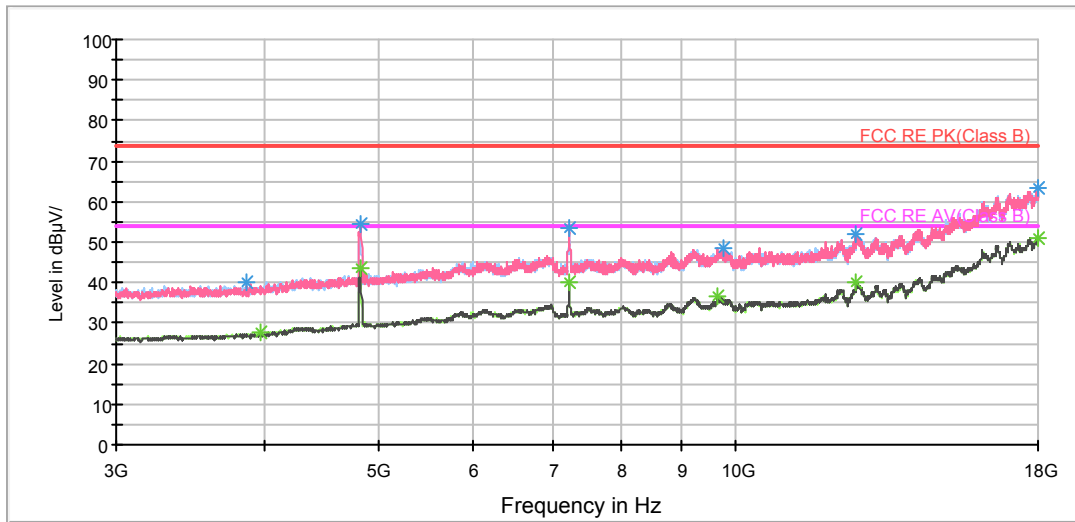

Radiates Emission from 3GHz to 18GHz

Frequency (MHz)	Peak (dBuV/m)	Height (cm)	Polarization	Azimuth (deg)	Reading value (dBuV/m)	Correct Factor (dB)	Margin (dB)	Limit (dBuV/m)
3862.500000	40.2	200.0	H	86.0	41.7	-1.5	33.8	74
4824.375000	54.7	200.0	V	43.0	53.3	1.4	19.3	74
7233.750000	53.6	200.0	V	319.0	46.8	6.8	20.4	74
9753.750000	48.4	100.0	V	0.0	38.7	9.7	25.6	74
12646.875000	52.0	100.0	H	295.0	37.7	14.3	22.0	74
17992.500000	63.2	200.0	V	297.0	37.9	25.3	10.8	74

Remark: 1. Correction Factor = Antenna factor+ Insertion loss (cable loss + amplifier gain)

Frequency (MHz)	Average (dBuV/m)	Height (cm)	Polarization	Azimuth (deg)	Reading value (dBuV/m)	Correct Factor (dB)	Margin (dB)	Limit (dBuV/m)
3971.250000	27.6	100.0	V	0.0	28.5	-0.9	26.4	54
4822.500000	43.5	100.0	V	20.0	42.2	1.3	10.5	54
7235.625000	39.9	200.0	H	86.0	33.1	6.8	14.1	54
9648.750000	36.5	200.0	V	0.0	26.7	9.8	17.5	54
12639.375000	40.3	200.0	V	319.0	25.8	14.5	13.7	54
18000.000000	51.0	100.0	H	114.0	25.5	25.5	3.0	54

Remark: 1. Correction Factor = Antenna factor+ Insertion loss (cable loss + amplifier gain)

RE 18-26.5GHz PK+AV

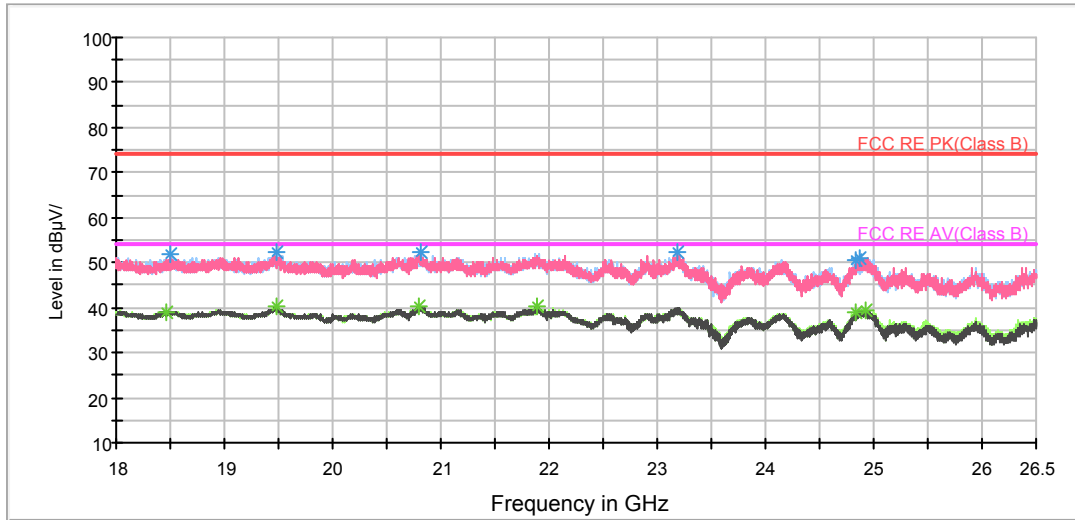

Radiates Emission from 18GHz to 26GHz

Frequency (MHz)	Peak (dBuV/m)	Polarization	Azimuth (deg)	Reading value (dBuV/m)	Correct Factor (dB)	Margin (dB)	Limit (dBuV/m)
18507.875000	51.9	V	119.0	51.6	0.3	22.1	74
19484.312500	52.1	H	0.0	52.0	0.1	21.9	74
20810.312500	52.4	V	57.0	54.4	-2.0	21.6	74
23183.937500	52.2	V	129.0	52.3	-0.1	21.8	74
24834.000000	50.4	H	0.0	50.2	0.2	23.6	74
24862.687500	50.9	V	101.0	50.5	0.4	23.1	74

Remark: 1. Correction Factor = Antenna factor+ Insertion loss (cable loss + amplifier gain)

Frequency (MHz)	Average (dBuV/m)	Polarization	Azimuth (deg)	Reading value (dBuV/m)	Correct Factor (dB)	Margin (dB)	Limit (dBuV/m)
18466.437500	38.9	V	65.0	38.5	0.4	15.1	54
19487.500000	40.1	H	0.0	40.0	0.1	13.9	54
20789.062500	40.1	V	83.0	42.0	-1.9	13.9	54
21887.687500	40.1	H	345.0	41.7	-1.6	13.9	54
24838.250000	38.7	H	219.0	38.4	0.3	15.3	54
24917.937500	39.6	V	129.0	38.9	0.7	14.4	54

Remark: 1. Correction Factor = Antenna factor+ Insertion loss (cable loss + amplifier gain)



802.11n (HT20) CH6

FCC RE 0.03-1GHz QP Class B

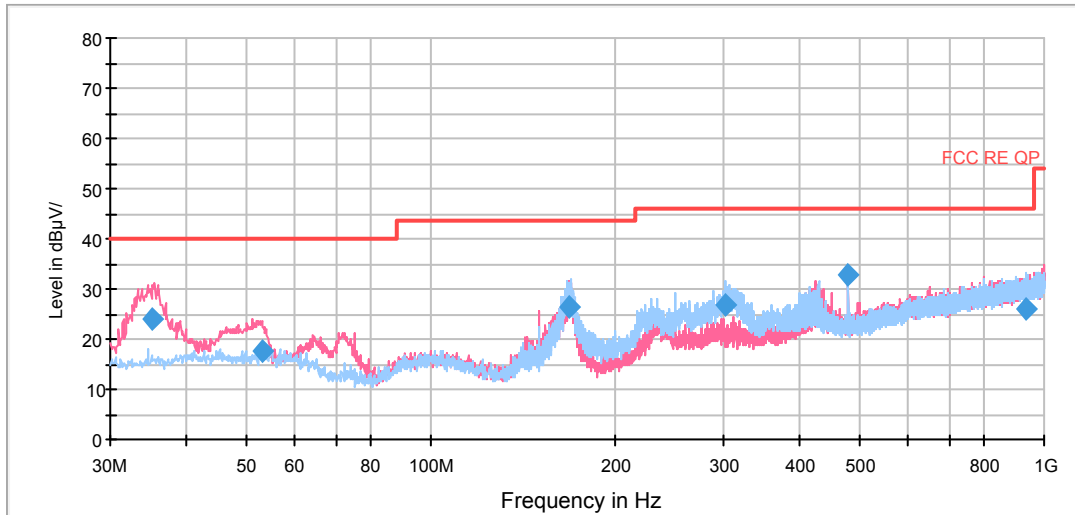

Radiates Emission from 30MHz to 1GHz

Frequency (MHz)	Quasi-Peak (dBuV/m)	Height (cm)	Polarization	Azimuth (deg)	Reading value (dBuV/m)	Correct Factor (dB)	Margin (dB)	Limit (dBuV/m)
35.016250	24.0	100.0	V	0.0	11.9	12.1	16.0	40.0
53.286250	17.4	100.0	V	142.0	4.6	12.8	22.6	40.0
168.390000	26.5	125.0	H	33.0	16.3	10.2	17.0	43.5
301.477500	26.9	100.0	H	268.0	11.1	15.8	19.1	46.0
479.998750	32.7	100.0	V	238.0	12.5	20.2	13.3	46.0
937.997500	25.9	100.0	H	130.0	-1.3	27.2	20.1	46.0

- Remark: 1. Quasi-Peak = Reading value + Correction factor
 2. Correction Factor = Antenna factor+ Insertion loss(cable loss+amplifier gain)
 3. Margin = Limit – Quasi-Peak

RE 1G-3GHz PK+AV

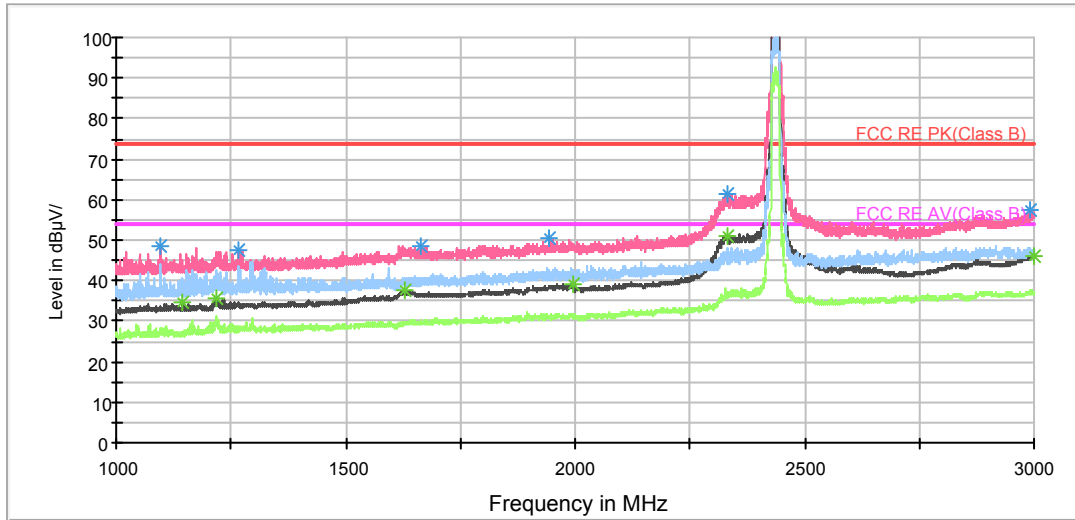

Note: The signal beyond the limit is carrier.

Radiates Emission from 1GHz to 3GHz

Frequency (MHz)	Peak (dBuV/m)	Height (cm)	Polarization	Azimuth (deg)	Reading value (dBuV/m)	Correct Factor (dB)	Margin (dB)	Limit (dBuV/m)
1096.750000	48.5	100.0	V	0.0	57.4	-8.9	25.5	74
1266.750000	47.5	100.0	V	281.0	55.2	-7.7	26.5	74
1662.750000	48.8	100.0	V	324.0	54.0	-5.2	25.2	74
1941.750000	50.4	100.0	V	227.0	53.9	-3.5	23.6	74
2332.750000	61.5	100.0	V	99.0	62.9	-1.4	12.5	74
2992.250000	57.4	100.0	V	0.0	55.2	2.2	16.6	74

Remark: 1. Correction Factor = Antenna factor+ Insertion loss (cable loss + amplifier gain)

Frequency (MHz)	Average (dBuV/m)	Height (cm)	Polarization	Azimuth (deg)	Reading value (dBuV/m)	Correct Factor (dB)	Margin (dB)	Limit (dBuV/m)
1145.750000	34.6	100.0	V	310.0	43.1	-8.5	19.4	54
1217.250000	35.7	100.0	V	0.0	43.6	-7.9	18.3	54
1630.750000	37.4	100.0	V	340.0	42.1	-4.7	16.6	54
1994.750000	39.0	100.0	V	235.0	42.2	-3.2	15.0	54
2334.000000	50.9	100.0	V	99.0	52.3	-1.4	3.1	54
2998.250000	46.2	100.0	V	99.0	43.9	2.3	7.8	54

Remark: 1. Correction Factor = Antenna factor+ Insertion loss (cable loss + amplifier gain)

RE 3-18GHz PK+AV

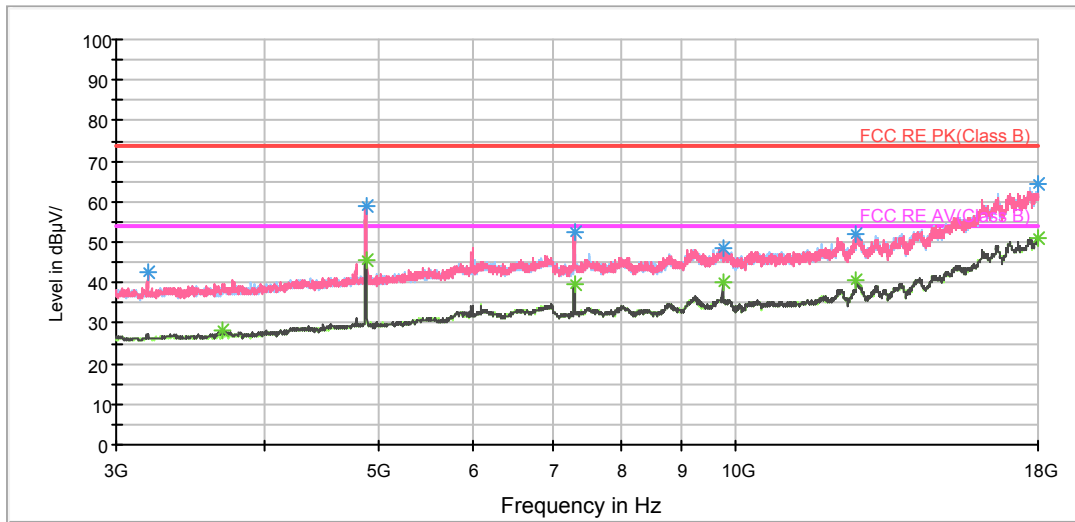

Radiates Emission from 3GHz to 18GHz

Frequency (MHz)	Peak (dBuV/m)	Height (cm)	Polarization	Azimuth (deg)	Reading value (dBuV/m)	Correct Factor (dB)	Margin (dB)	Limit (dBuV/m)
3193.125000	42.7	100.0	V	224.0	45.6	-2.9	31.3	74
4873.125000	59.0	100.0	V	20.0	57.2	1.8	15.0	74
7308.750000	52.7	200.0	H	87.0	45.7	7.0	21.3	74
9748.125000	48.4	200.0	V	44.0	38.6	9.8	25.6	74
12645.000000	52.1	100.0	H	120.0	37.7	14.4	21.9	74
17996.250000	64.2	200.0	V	228.0	38.8	25.4	9.8	74

Remark: 1. Correction Factor = Antenna factor+ Insertion loss (cable loss + amplifier gain)

Frequency (MHz)	Average (dBuV/m)	Height (cm)	Polarization	Azimuth (deg)	Reading value (dBuV/m)	Correct Factor (dB)	Margin (dB)	Limit (dBuV/m)
3693.750000	28.3	100.0	V	246.0	29.9	-1.6	25.7	54
4873.125000	45.7	100.0	V	20.0	43.9	1.8	8.3	54
7306.875000	39.4	200.0	H	87.0	32.4	7.0	14.6	54
9748.125000	40.0	200.0	V	44.0	30.2	9.8	14.0	54
12641.250000	40.4	200.0	V	319.0	25.9	14.5	13.6	54
18000.000000	51.1	100.0	H	0.0	25.6	25.5	2.9	54

Remark: 1. Correction Factor = Antenna factor+ Insertion loss (cable loss + amplifier gain)

RE 18-26.5GHz PK+AV

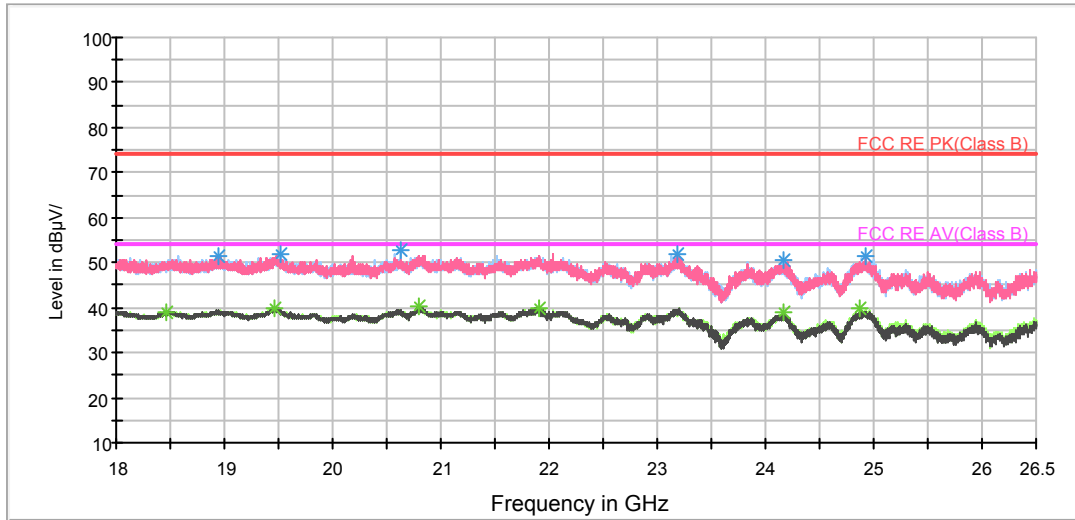

Radiates Emission from 18GHz to 26GHz

Frequency (MHz)	Peak (dBuV/m)	Polarization	Azimuth (deg)	Reading value (dBuV/m)	Correct Factor (dB)	Margin (dB)	Limit (dBuV/m)
18944.562500	51.4	H	0.0	51.4	0.0	22.6	74
19517.250000	52.0	H	215.0	52.0	0.0	22.0	74
20623.312500	52.6	H	151.0	53.8	-1.2	21.4	74
23178.625000	51.8	V	87.0	51.9	-0.1	22.2	74
24165.687500	50.4	H	151.0	51.1	-0.7	23.6	74
24928.562500	51.4	V	143.0	50.7	0.7	22.6	74

Remark: 1. Correction Factor = Antenna factor+ Insertion loss (cable loss + amplifier gain)

Frequency (MHz)	Average (dBuV/m)	Polarization	Azimuth (deg)	Reading value (dBuV/m)	Correct Factor (dB)	Margin (dB)	Limit (dBuV/m)
18461.125000	39.1	V	31.0	38.7	0.4	14.9	54
19469.437500	40.0	H	0.0	39.9	0.1	14.0	54
20790.125000	40.2	V	162.0	42.1	-1.9	13.8	54
21898.312500	40.0	H	244.0	41.6	-1.6	14.0	54
24165.687500	38.9	V	60.0	39.6	-0.7	15.1	54
24871.187500	39.7	H	188.0	39.3	0.4	14.3	54

Remark: 1. Correction Factor = Antenna factor+ Insertion loss (cable loss + amplifier gain)

802.11n (HT20) CH11

FCC RE 0.03-1GHz QP Class B

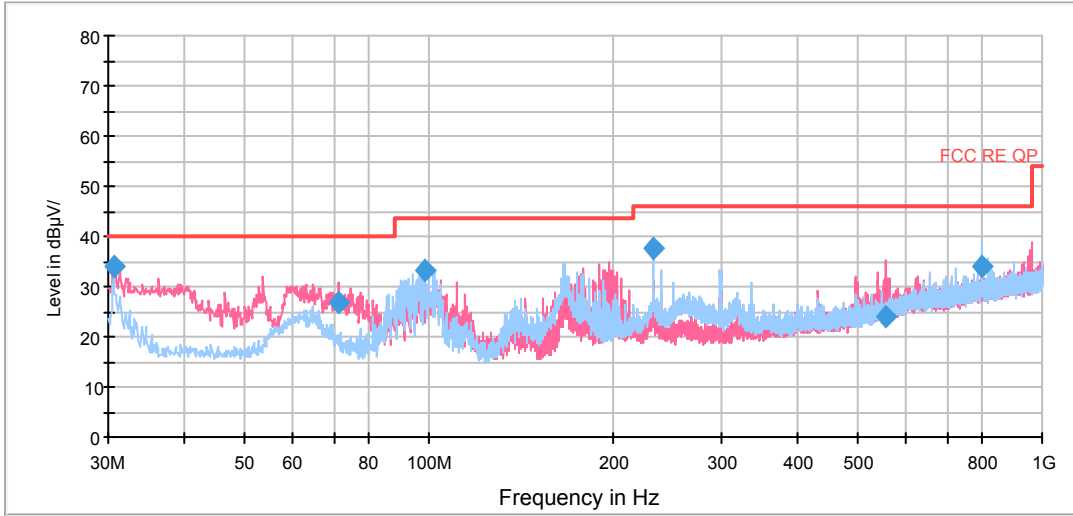

Radiates Emission from 30MHz to 1GHz

Frequency (MHz)	Quasi-Peak (dBuV/m)	Height (cm)	Polarization	Azimuth (deg)	Reading value (dBuV/m)	Correct Factor (dB)	Margin (dB)	Limit (dBuV/m)
30.606250	33.8	100.0	V	57.0	21.7	12.1	6.2	40.0
71.426250	26.8	100.0	V	22.0	18.2	8.6	13.2	40.0
98.425000	33.4	189.0	H	308.0	20.3	13.1	10.1	43.5
232.366250	37.5	125.0	H	268.0	24.1	13.4	8.5	46.0
555.940000	24.1	100.0	V	10.0	2.3	21.8	21.9	46.0
796.628750	33.9	113.0	H	22.0	9.0	24.9	12.1	46.0

- Remark: 1. Quasi-Peak = Reading value + Correction factor
 2. Correction Factor = Antenna factor+ Insertion loss(cable loss+amplifier gain)
 3. Margin = Limit – Quasi-Peak

RE 1G-3GHz PK+AV

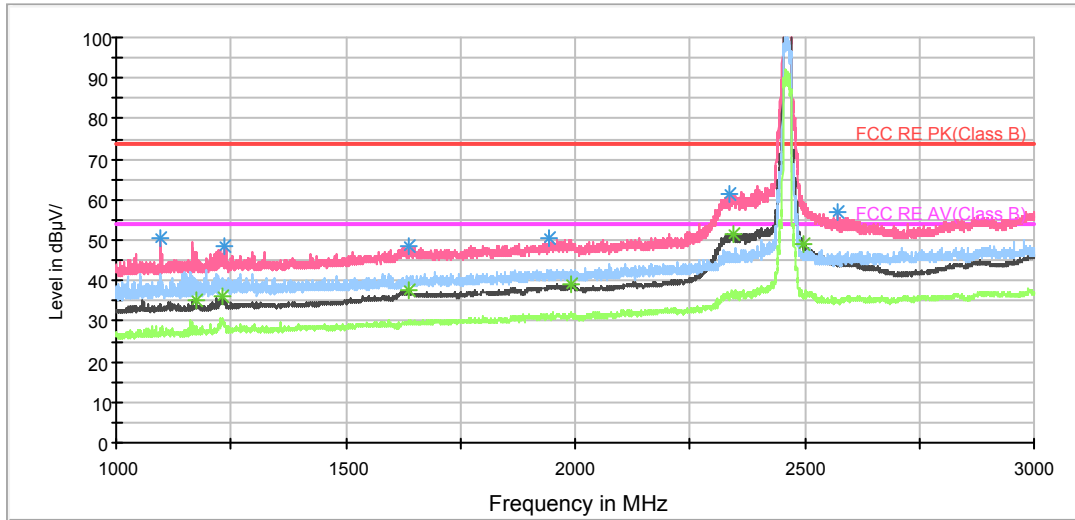

Note: The signal beyond the limit is carrier.

Radiates Emission from 1GHz to 3GHz

Frequency (MHz)	Peak (dBuV/m)	Height (cm)	Polarization	Azimuth (deg)	Reading value (dBuV/m)	Correct Factor (dB)	Margin (dB)	Limit (dBuV/m)
1097.250000	50.5	100.0	V	245.0	59.4	-8.9	23.5	74
1233.750000	48.3	100.0	V	0.0	56.1	-7.8	25.7	74
1635.750000	48.4	100.0	V	348.0	53.1	-4.7	25.6	74
1942.750000	50.3	100.0	V	113.0	53.7	-3.4	23.7	74
2337.500000	61.5	100.0	V	91.0	62.8	-1.3	12.5	74
2573.500000	56.8	100.0	V	154.0	57.4	-0.6	17.2	74

Remark: 1. Correction Factor = Antenna factor+ Insertion loss (cable loss + amplifier gain)

Frequency (MHz)	Average (dBuV/m)	Height (cm)	Polarization	Azimuth (deg)	Reading value (dBuV/m)	Correct Factor (dB)	Margin (dB)	Limit (dBuV/m)
1174.500000	35.2	100.0	V	319.0	43.2	-8.0	18.8	54
1233.250000	36.2	100.0	V	0.0	44.0	-7.8	17.8	54
1639.500000	37.5	100.0	V	268.0	42.2	-4.7	16.5	54
1990.750000	39.0	100.0	V	297.0	42.3	-3.3	15.0	54
2343.250000	51.4	100.0	V	91.0	52.7	-1.3	2.6	54
2499.500000	48.9	100.0	V	147.0	49.1	-0.2	5.1	54

Remark: 1. Correction Factor = Antenna factor+ Insertion loss (cable loss + amplifier gain)

RE 3-18GHz PK+AV

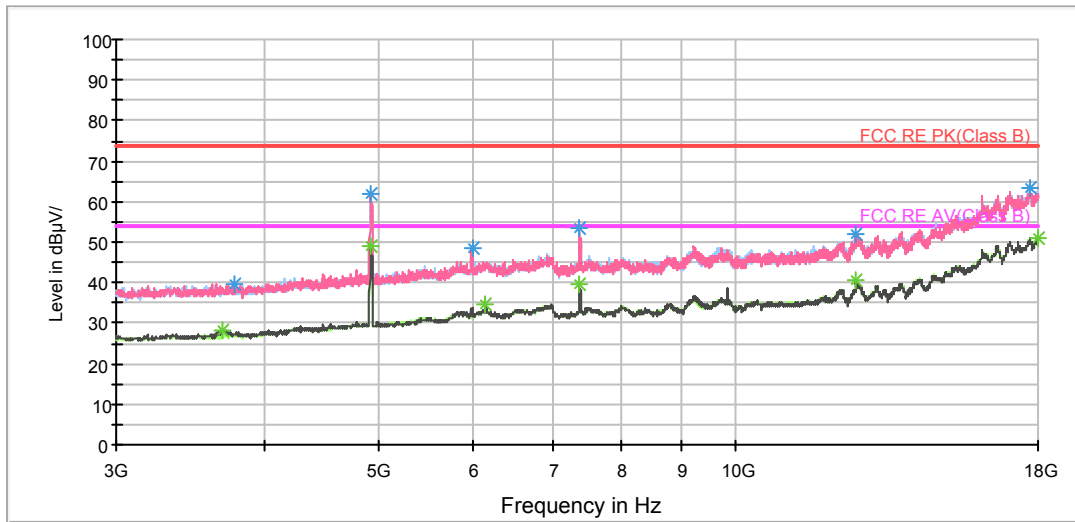

Radiates Emission from 3GHz to 18GHz

Frequency (MHz)	Peak (dBuV/m)	Height (cm)	Polarization	Azimuth (deg)	Reading value (dBuV/m)	Correct Factor (dB)	Margin (dB)	Limit (dBuV/m)
3768.750000	39.7	200.0	H	177.0	41.4	-1.7	34.3	74
4921.875000	61.7	100.0	V	15.0	59.8	1.9	12.3	74
5992.500000	48.3	100.0	V	222.0	43.4	4.9	25.7	74
7385.625000	53.6	200.0	V	182.0	46.6	7.0	20.4	74
12641.250000	51.7	100.0	V	0.0	37.2	14.5	22.3	74
17715.000000	63.4	200.0	H	43.0	38.8	24.6	10.6	74

Remark: 1. Correction Factor = Antenna factor+ Insertion loss (cable loss + amplifier gain)

Frequency (MHz)	Average (dBuV/m)	Height (cm)	Polarization	Azimuth (deg)	Reading value (dBuV/m)	Correct Factor (dB)	Margin (dB)	Limit (dBuV/m)
3690.000000	28.3	100.0	V	15.0	30.0	-1.7	25.7	54
4923.750000	48.8	100.0	V	15.0	46.9	1.9	5.2	54
6153.750000	34.4	200.0	V	0.0	28.8	5.6	19.6	54
7387.500000	39.5	200.0	V	159.0	32.5	7.0	14.5	54
12641.250000	40.4	100.0	V	0.0	25.9	14.5	13.6	54
18000.000000	51.1	200.0	V	0.0	25.6	25.5	2.9	54

Remark: 1. Correction Factor = Antenna factor+ Insertion loss (cable loss + amplifier gain)



RE 18-26.5GHz PK+AV

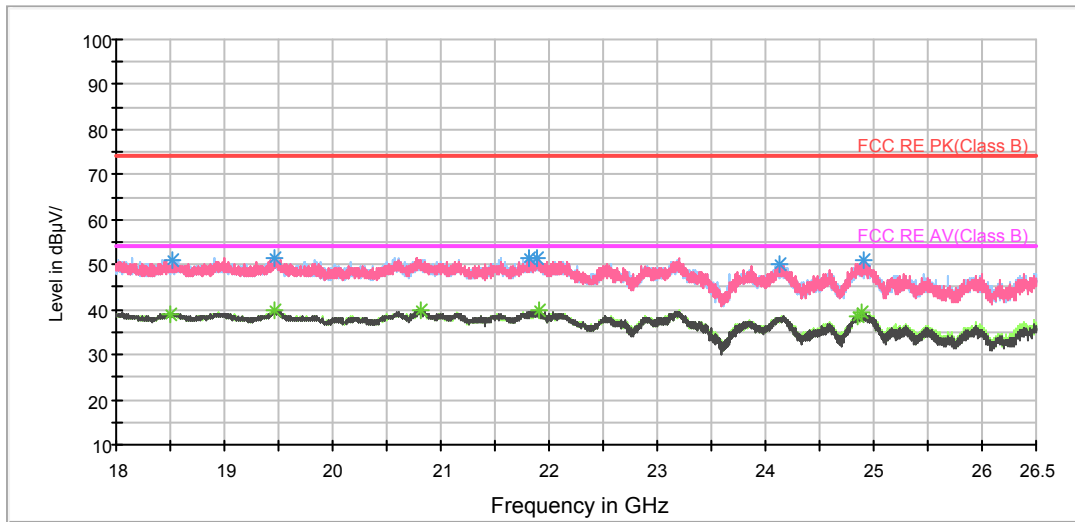

Radiates Emission from 18GHz to 26GHz

Frequency (MHz)	Peak (dBuV/m)	Polarization	Azimuth (deg)	Reading value (dBuV/m)	Correct Factor (dB)	Margin (dB)	Limit (dBuV/m)
18514.250000	51.0	H	348.0	50.7	0.3	23.0	74
19465.187500	51.2	H	123.0	51.1	0.1	22.8	74
21812.250000	51.6	H	239.0	53.6	-2.0	22.4	74
21897.250000	51.5	V	246.0	53.1	-1.6	22.5	74
24130.625000	50.2	H	0.0	50.8	-0.6	23.8	74
24914.750000	50.8	H	0.0	50.1	0.7	23.2	74

Remark: 1. Correction Factor = Antenna factor+ Insertion loss (cable loss + amplifier gain)

Frequency (MHz)	Average (dBuV/m)	Polarization	Azimuth (deg)	Reading value (dBuV/m)	Correct Factor (dB)	Margin (dB)	Limit (dBuV/m)
18507.875000	39.0	H	137.0	38.7	0.3	15.0	54
19468.375000	39.7	H	239.0	39.6	0.1	14.3	54
20810.312500	40.0	H	321.0	42.0	-2.0	14.0	54
21901.500000	39.7	H	211.0	41.3	-1.6	14.3	54
24843.562500	38.6	H	137.0	38.3	0.3	15.4	54
24887.125000	39.3	H	152.0	38.8	0.5	14.7	54

Remark: 1. Correction Factor = Antenna factor+ Insertion loss (cable loss + amplifier gain)



802.11n (HT40) CH3

FCC RE 0.03-1GHz QP Class B

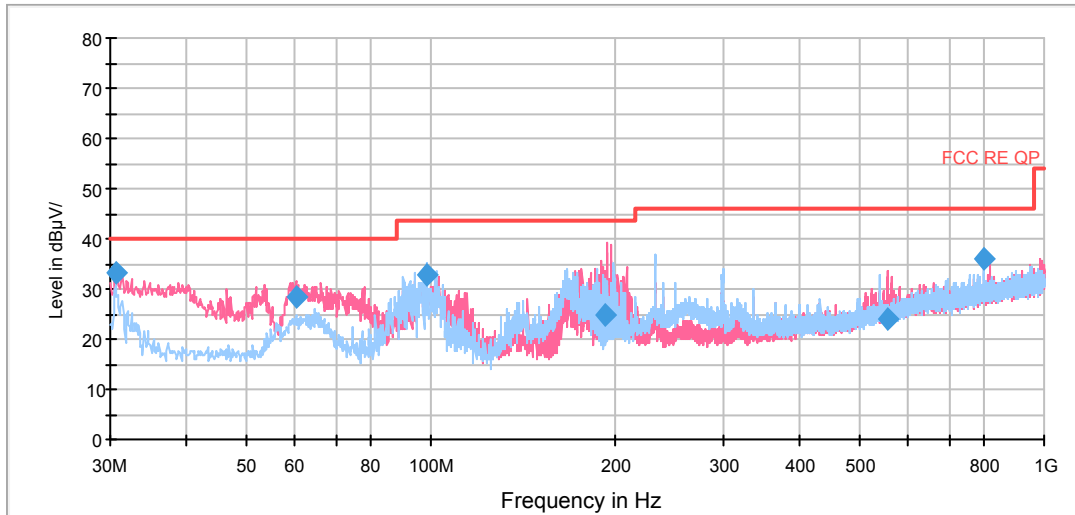

Radiates Emission from 30MHz to 1GHz

Frequency (MHz)	Quasi-Peak (dBuV/m)	Height (cm)	Polarization	Azimuth (deg)	Reading value (dBuV/m)	Correct Factor (dB)	Margin (dB)	Limit (dBuV/m)
30.606250	33.4	100.0	V	70.0	21.3	12.1	6.6	40.0
60.231250	28.3	125.0	V	47.0	15.9	12.4	11.7	40.0
98.425000	33.0	175.0	H	301.0	19.9	13.1	10.5	43.5
193.005000	24.8	100.0	V	344.0	13.0	11.8	18.7	43.5
554.970000	24.2	100.0	V	356.0	2.4	21.8	21.8	46.0
798.200000	36.0	113.0	H	36.0	11.7	24.3	10.0	46.0

- Remark: 1. Quasi-Peak = Reading value + Correction factor
 2. Correction Factor = Antenna factor+ Insertion loss(cable loss+amplifier gain)
 3. Margin = Limit – Quasi-Peak

RE 1G-3GHz PK+AV

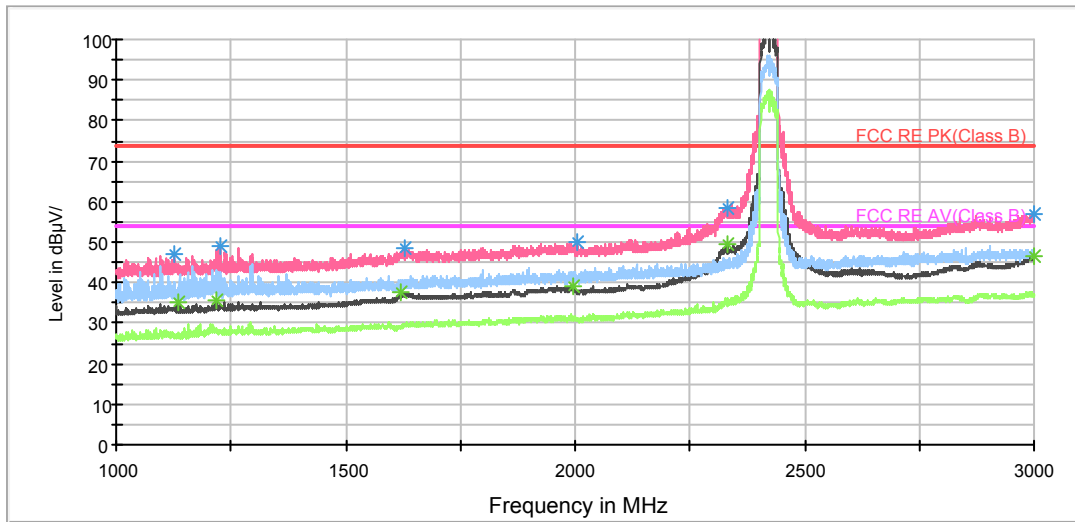

Note: The signal beyond the limit is carrier.

Radiates Emission from 1GHz to 3GHz

Frequency (MHz)	Peak (dBuV/m)	Height (cm)	Polarization	Azimuth (deg)	Reading value (dBuV/m)	Correct Factor (dB)	Margin (dB)	Limit (dBuV/m)
1128.500000	47.2	100.0	V	301.0	55.6	-8.4	26.8	74
1225.500000	49.2	100.0	V	358.0	57.0	-7.8	24.8	74
1627.250000	48.5	100.0	V	301.0	53.3	-4.8	25.5	74
2005.500000	50.0	100.0	V	272.0	53.5	-3.5	24.0	74
2333.000000	58.6	100.0	V	80.0	60.0	-1.4	15.4	74
2999.750000	56.8	100.0	V	235.0	54.5	2.3	17.2	74

Remark: 1. Correction Factor = Antenna factor+ Insertion loss (cable loss + amplifier gain)

Frequency (MHz)	Average (dBuV/m)	Height (cm)	Polarization	Azimuth (deg)	Reading value (dBuV/m)	Correct Factor (dB)	Margin (dB)	Limit (dBuV/m)
1133.250000	35.1	100.0	V	301.0	43.5	-8.4	18.9	54
1220.500000	35.7	100.0	V	345.0	43.6	-7.9	18.3	54
1621.500000	37.5	100.0	V	280.0	42.3	-4.8	16.5	54
1993.500000	39.1	100.0	V	294.0	42.4	-3.3	14.9	54
2333.250000	49.3	100.0	V	55.0	50.7	-1.4	4.7	54
2998.250000	46.4	100.0	V	358.0	44.1	2.3	7.6	54

Remark: 1. Correction Factor = Antenna factor+ Insertion loss (cable loss + amplifier gain)



RE 3-18GHz PK+AV

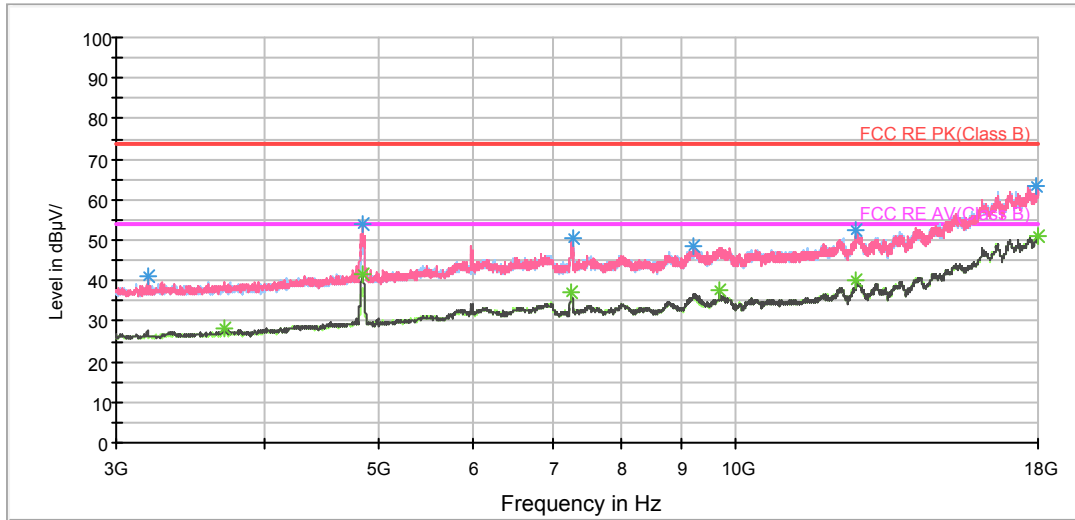

Radiates Emission from 3GHz to 18GHz

Frequency (MHz)	Peak (dBuV/m)	Height (cm)	Polarization	Azimuth (deg)	Reading value (dBuV/m)	Correct Factor (dB)	Margin (dB)	Limit (dBuV/m)
3193.125000	41.0	100.0	V	269.0	43.9	-2.9	33.0	74
4843.125000	53.8	200.0	V	44.0	52.2	1.6	20.2	74
7286.250000	50.5	200.0	H	86.0	43.5	7.0	23.5	74
9213.750000	48.3	100.0	V	246.0	38.3	10.0	25.7	74
12635.625000	52.3	100.0	H	342.0	38.2	14.1	21.7	74
17928.750000	63.2	200.0	H	132.0	37.8	25.4	10.8	74

Remark: 1. Correction Factor = Antenna factor+ Insertion loss (cable loss + amplifier gain)

Frequency (MHz)	Average (dBuV/m)	Height (cm)	Polarization	Azimuth (deg)	Reading value (dBuV/m)	Correct Factor (dB)	Margin (dB)	Limit (dBuV/m)
3699.375000	28.2	100.0	V	246.0	29.8	-1.6	25.8	54
4843.125000	41.5	100.0	V	19.0	39.9	1.6	12.5	54
7261.875000	37.0	200.0	H	63.0	29.9	7.1	17.0	54
9688.125000	37.8	200.0	V	161.0	28.3	9.5	16.2	54
12643.125000	40.2	100.0	H	0.0	25.8	14.4	13.8	54
17998.125000	51.2	200.0	H	0.0	25.8	25.4	2.8	54

Remark: 1. Correction Factor = Antenna factor+ Insertion loss (cable loss + amplifier gain)

RE 18-26.5GHz PK+AV

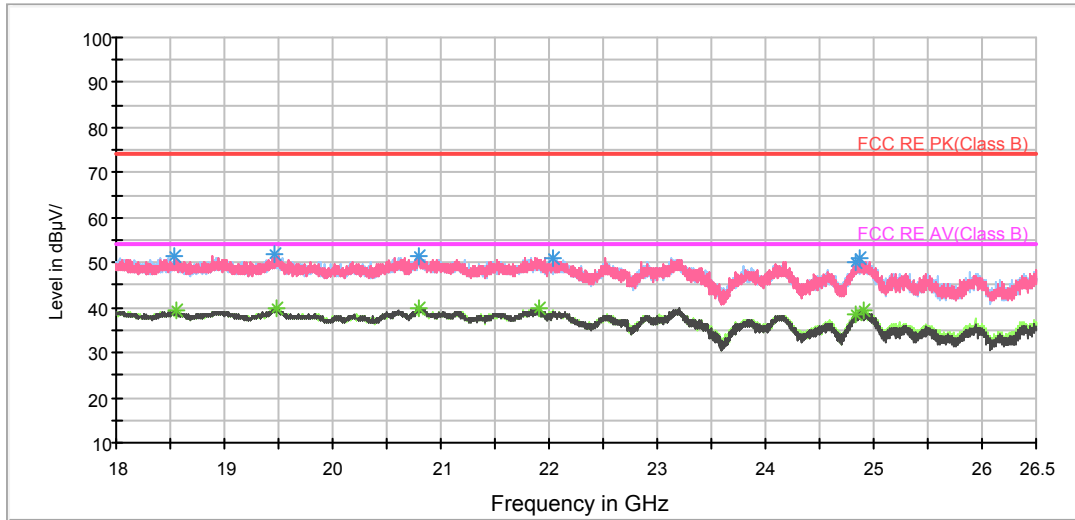

Radiates Emission from 18GHz to 26GHz

Frequency (MHz)	Peak (dBuV/m)	Polarization	Azimuth (deg)	Reading value (dBuV/m)	Correct Factor (dB)	Margin (dB)	Limit (dBuV/m)
18539.750000	51.6	V	143.0	51.3	0.3	22.4	74
19471.562500	52.1	H	136.0	52.0	0.1	21.9	74
20803.937500	51.6	V	49.0	53.6	-2.0	22.4	74
22037.500000	51.2	H	0.0	52.6	-1.4	22.8	74
24827.625000	50.0	H	330.0	49.8	0.2	24.0	74
24875.437500	51.1	H	0.0	50.6	0.5	22.9	74

Remark: 1. Correction Factor = Antenna factor+ Insertion loss (cable loss + amplifier gain)

Frequency (MHz)	Average (dBuV/m)	Polarization	Azimuth (deg)	Reading value (dBuV/m)	Correct Factor (dB)	Margin (dB)	Limit (dBuV/m)
18551.437500	39.3	H	0.0	39.1	0.2	14.7	54
19473.687500	39.9	H	318.0	39.8	0.1	14.1	54
20800.750000	40.0	V	291.0	42.0	-2.0	14.0	54
21901.500000	39.8	H	330.0	41.4	-1.6	14.2	54
24840.375000	38.4	V	0.0	38.1	0.3	15.6	54
24911.562500	39.3	H	318.0	38.6	0.7	14.7	54

Remark: 1. Correction Factor = Antenna factor+ Insertion loss (cable loss + amplifier gain)



802.11n (HT40) CH6

FCC RE 0.03-1GHz QP Class B

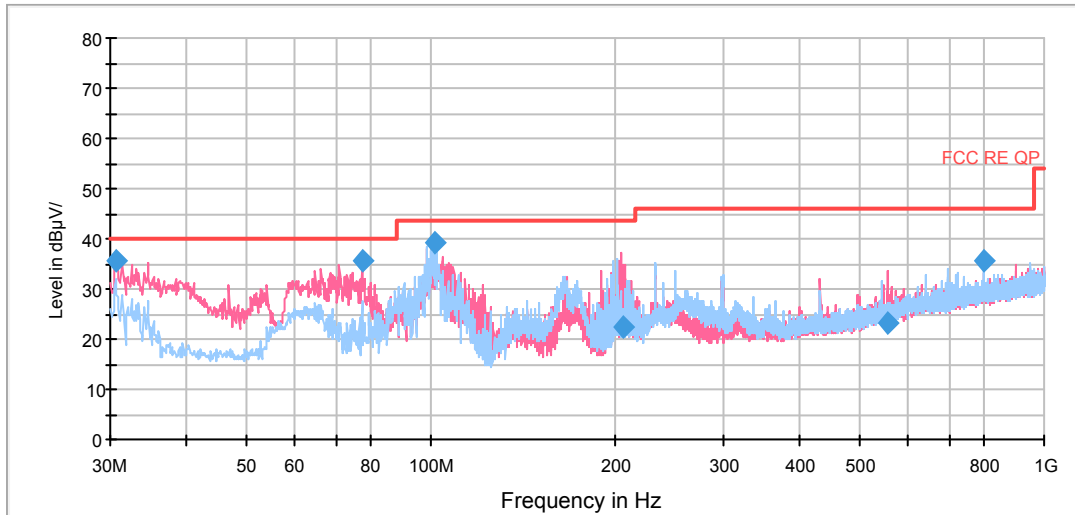

Radiates Emission from 30MHz to 1GHz

Frequency (MHz)	Quasi-Peak (dBuV/m)	Height (cm)	Polarization	Azimuth (deg)	Reading value (dBuV/m)	Correct Factor (dB)	Margin (dB)	Limit (dBuV/m)
30.606250	35.8	100.0	V	42.0	23.7	12.1	4.2	40.0
77.206250	35.4	114.0	V	72.0	26.8	8.6	4.6	40.0
101.861250	39.1	200.0	H	58.0	26.0	13.1	4.4	43.5
205.160000	22.5	175.0	V	11.0	10.2	12.3	21.0	43.5
557.431250	23.3	100.0	V	0.0	1.5	21.8	22.7	46.0
796.623750	35.4	100.0	H	292.0	10.5	24.9	10.6	46.0

- Remark: 1. Quasi-Peak = Reading value + Correction factor
 2. Correction Factor = Antenna factor+ Insertion loss(cable loss+amplifier gain)
 3. Margin = Limit – Quasi-Peak

RE 1G-3GHz PK+AV

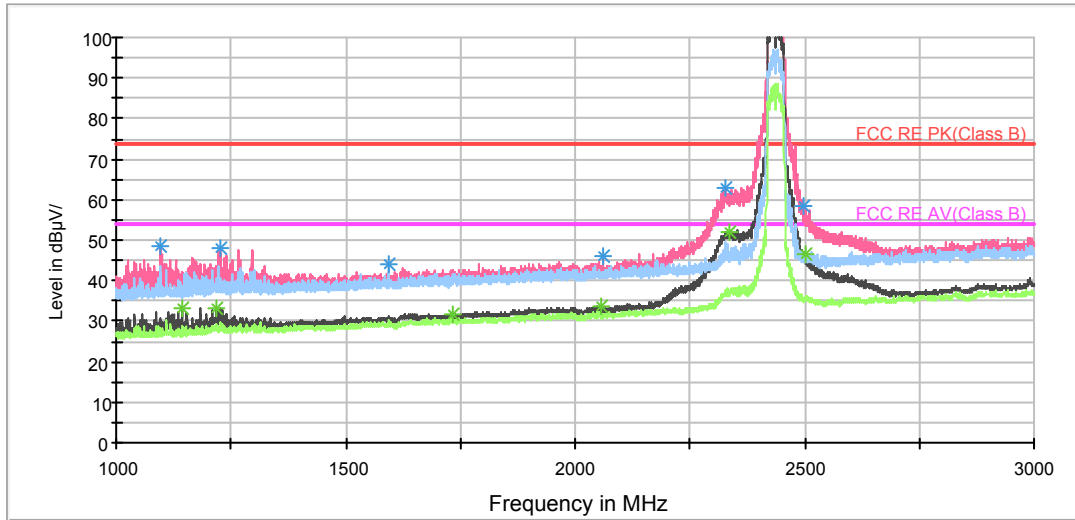

Note: The signal beyond the limit is carrier.

Radiates Emission from 1GHz to 3GHz

Frequency (MHz)	Peak (dBuV/m)	Height (cm)	Polarization	Azimuth (deg)	Reading value (dBuV/m)	Correct Factor (dB)	Margin (dB)	Limit (dBuV/m)
1097.750000	48.4	100.0	V	333.0	57.3	-8.9	25.6	74
1226.500000	48.0	100.0	V	341.0	55.8	-7.8	26.0	74
1593.250000	43.9	100.0	H	251.0	50.3	-6.4	30.1	74
2059.250000	46.1	100.0	V	297.0	49.2	-3.1	27.9	74
2327.000000	62.7	100.0	V	89.0	64.3	-1.6	11.3	74
2499.750000	58.4	100.0	V	144.0	58.6	-0.2	15.6	74

Remark: 1. Correction Factor = Antenna factor+ Insertion loss (cable loss + amplifier gain)

Frequency (MHz)	Average (dBuV/m)	Height (cm)	Polarization	Azimuth (deg)	Reading value (dBuV/m)	Correct Factor (dB)	Margin (dB)	Limit (dBuV/m)
1142.250000	33.3	100.0	V	312.0	41.8	-8.5	20.7	54
1217.000000	33.3	100.0	V	297.0	41.2	-7.9	20.7	54
1732.000000	31.7	100.0	V	290.0	36.5	-4.8	22.3	54
2058.000000	33.5	100.0	V	319.0	36.7	-3.2	20.5	54
2334.500000	51.9	100.0	V	89.0	53.3	-1.4	2.1	54
2502.250000	46.3	100.0	V	355.0	46.5	-0.2	7.7	54

Remark: 1. Correction Factor = Antenna factor+ Insertion loss (cable loss + amplifier gain)



RE 3-18GHz PK+AV

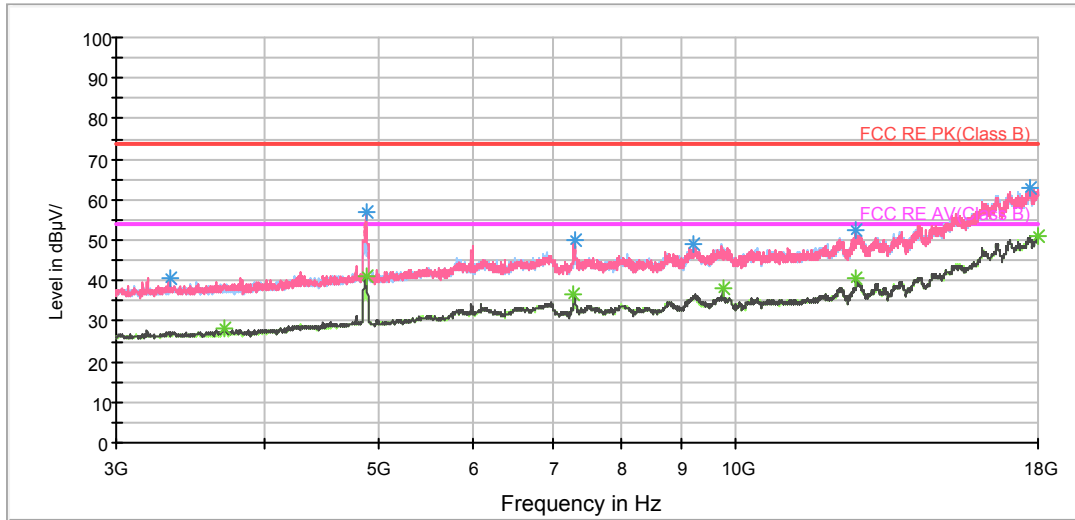

Radiates Emission from 3GHz to 18GHz

Frequency (MHz)	Peak (dBuV/m)	Height (cm)	Polarization	Azimuth (deg)	Reading value (dBuV/m)	Correct Factor (dB)	Margin (dB)	Limit (dBuV/m)
3326.250000	40.7	100.0	V	267.0	42.8	-2.1	33.3	74
4873.125000	56.9	200.0	V	228.0	55.1	1.8	17.1	74
7308.750000	50.1	100.0	V	106.0	43.1	7.0	23.9	74
9211.875000	48.9	100.0	H	303.0	38.8	10.1	25.1	74
12643.125000	52.6	200.0	V	44.0	38.2	14.4	21.4	74
17696.250000	62.7	200.0	H	223.0	38.0	24.7	11.3	74

Remark: 1. Correction Factor = Antenna factor+ Insertion loss (cable loss + amplifier gain)

Frequency (MHz)	Average (dBuV/m)	Height (cm)	Polarization	Azimuth (deg)	Reading value (dBuV/m)	Correct Factor (dB)	Margin (dB)	Limit (dBuV/m)
3695.625000	28.1	100.0	V	316.0	29.7	-1.6	25.9	54
4875.000000	41.1	200.0	V	44.0	39.3	1.8	12.9	54
7305.000000	36.8	200.0	H	87.0	29.8	7.0	17.2	54
9748.125000	38.2	100.0	V	39.0	28.4	9.8	15.8	54
12641.250000	40.4	100.0	V	267.0	25.9	14.5	13.6	54
18000.000000	51.1	200.0	H	132.0	25.6	25.5	2.9	54

Remark: 1. Correction Factor = Antenna factor+ Insertion loss (cable loss + amplifier gain)

RE 18-26.5GHz PK+AV

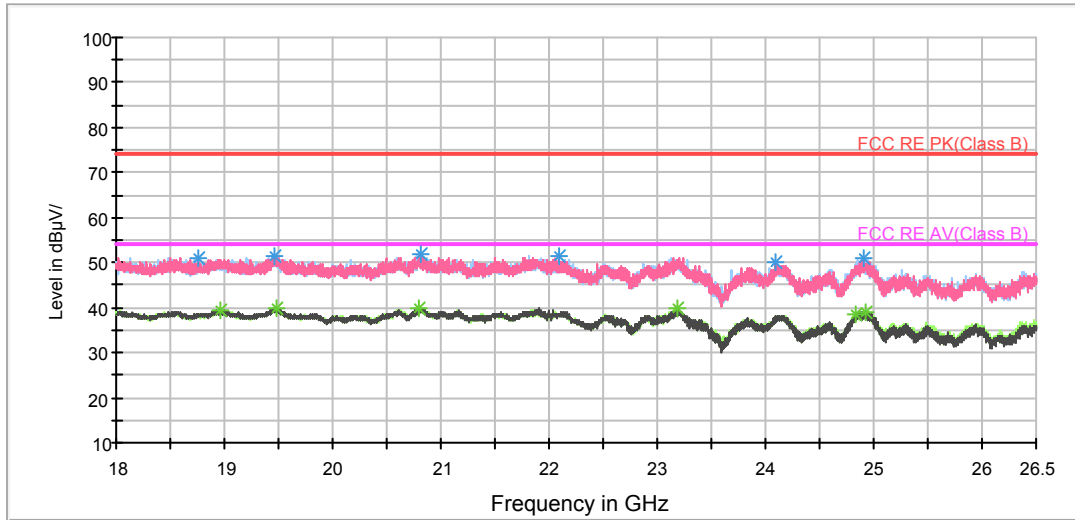

Radiates Emission from 18GHz to 26GHz

Frequency (MHz)	Peak (dBuV/m)	Polarization	Azimuth (deg)	Reading value (dBuV/m)	Correct Factor (dB)	Margin (dB)	Limit (dBuV/m)
18760.750000	51.0	H	0.0	51.0	0.0	23.0	74
19470.500000	51.5	H	347.0	51.4	0.1	22.5	74
20807.125000	51.7	H	0.0	53.7	-2.0	22.3	74
22084.250000	51.4	V	0.0	52.9	-1.5	22.6	74
24098.750000	50.2	V	136.0	50.7	-0.5	23.8	74
24913.687500	50.9	V	301.0	50.2	0.7	23.1	74

Remark: 1. Correction Factor = Antenna factor+ Insertion loss (cable loss + amplifier gain)

Frequency (MHz)	Average (dBuV/m)	Polarization	Azimuth (deg)	Reading value (dBuV/m)	Correct Factor (dB)	Margin (dB)	Limit (dBuV/m)
18963.687500	39.4	H	187.0	39.4	0.0	14.6	54
19474.750000	40.0	H	281.0	39.9	0.1	14.0	54
20789.062500	39.8	V	0.0	41.7	-1.9	14.2	54
23188.187500	39.8	H	0.0	39.9	-0.1	14.2	54
24837.187500	38.4	H	0.0	38.1	0.3	15.6	54
24925.375000	38.9	H	227.0	38.2	0.7	15.1	54

Remark: 1. Correction Factor = Antenna factor+ Insertion loss (cable loss + amplifier gain)



802.11n (HT40) CH9

FCC RE 0.03-1GHz QP Class B

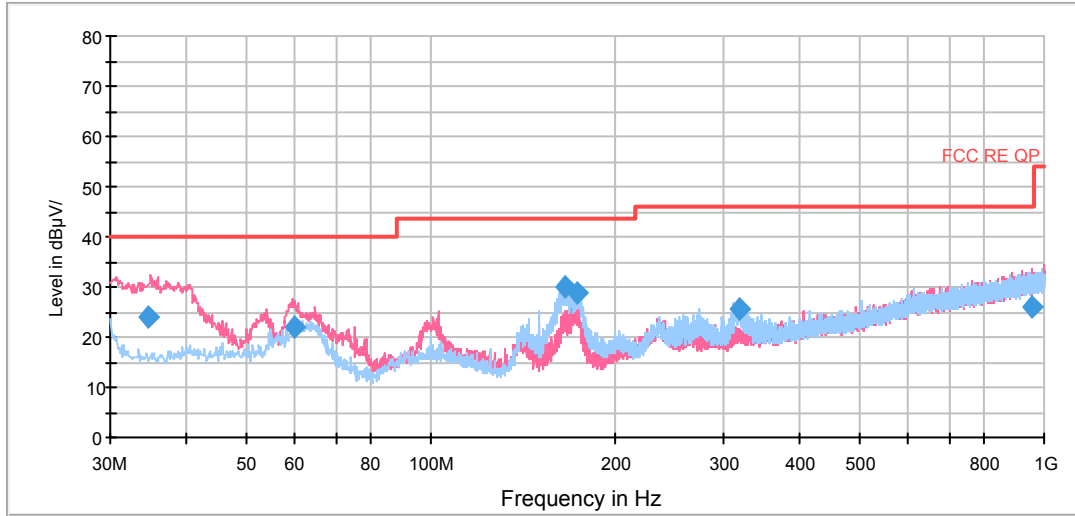

Radiates Emission from 30MHz to 1GHz

Frequency (MHz)	Quasi-Peak (dBuV/m)	Height (cm)	Polarization	Azimuth (deg)	Reading value (dBuV/m)	Correct Factor (dB)	Margin (dB)	Limit (dBuV/m)
34.531250	24.0	225.0	V	2.0	12.1	11.9	16.0	40.0
59.903750	22.2	114.0	V	64.0	9.6	12.6	17.8	40.0
164.991250	30.0	202.0	H	80.0	19.9	10.1	13.5	43.5
172.878750	28.6	189.0	H	111.0	18.2	10.4	14.9	43.5
317.483750	25.4	100.0	H	105.0	9.3	16.1	20.6	46.0
955.546250	26.1	125.0	V	295.0	-1.2	27.3	19.9	46.0

- Remark: 1. Quasi-Peak = Reading value + Correction factor
 2. Correction Factor = Antenna factor+ Insertion loss(cable loss+amplifier gain)
 3. Margin = Limit – Quasi-Peak

RE 1G-3GHz PK+AV

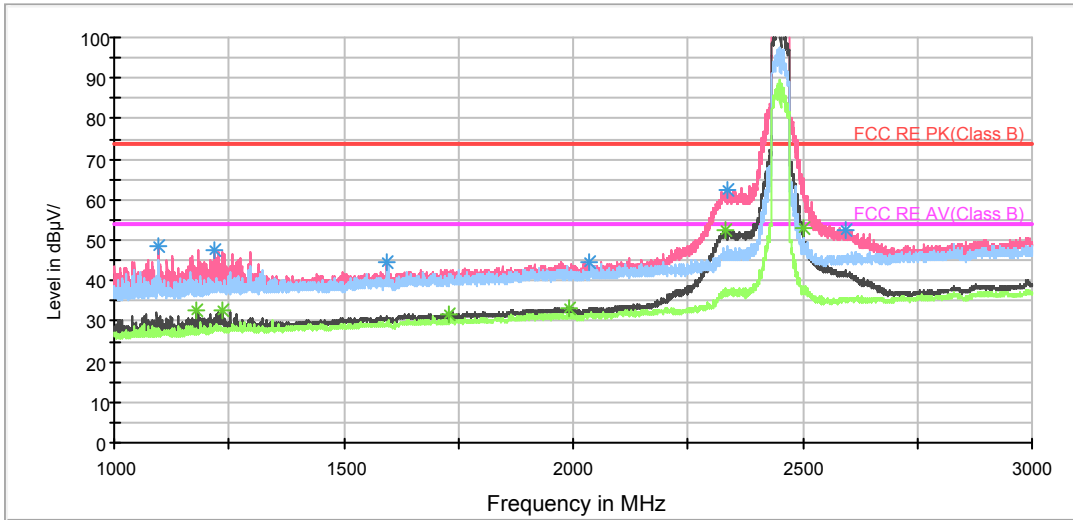

Note: The signal beyond the limit is carrier.

Radiates Emission from 1GHz to 3GHz

Frequency (MHz)	Peak (dBuV/m)	Height (cm)	Polarization	Azimuth (deg)	Reading value (dBuV/m)	Correct Factor (dB)	Margin (dB)	Limit (dBuV/m)
1096.000000	48.7	100.0	V	343.0	57.6	-8.9	25.3	74
1219.500000	47.4	100.0	V	291.0	55.3	-7.9	26.6	74
1593.250000	44.5	100.0	V	98.0	50.9	-6.4	29.5	74
2035.500000	44.7	100.0	V	291.0	48.0	-3.3	29.3	74
2335.000000	62.6	100.0	V	98.0	64.0	-1.4	11.4	74
2592.750000	52.6	100.0	V	74.0	52.5	0.1	21.4	74

Remark: 1. Correction Factor = Antenna factor+ Insertion loss (cable loss + amplifier gain)

Frequency (MHz)	Average (dBuV/m)	Height (cm)	Polarization	Azimuth (deg)	Reading value (dBuV/m)	Correct Factor (dB)	Margin (dB)	Limit (dBuV/m)
1177.500000	32.5	100.0	V	335.0	40.5	-8.0	21.5	54
1234.750000	32.9	100.0	V	356.0	40.8	-7.9	21.1	54
1730.500000	31.8	100.0	V	240.0	36.7	-4.9	22.2	54
1992.500000	33.4	100.0	V	233.0	36.7	-3.3	20.6	54
2332.750000	52.3	100.0	V	90.0	53.7	-1.4	1.7	54
2500.250000	53.0	100.0	V	153.0	53.2	-0.2	1.0	54

Remark: 1. Correction Factor = Antenna factor+ Insertion loss (cable loss + amplifier gain)

RE 3-18GHz PK+AV

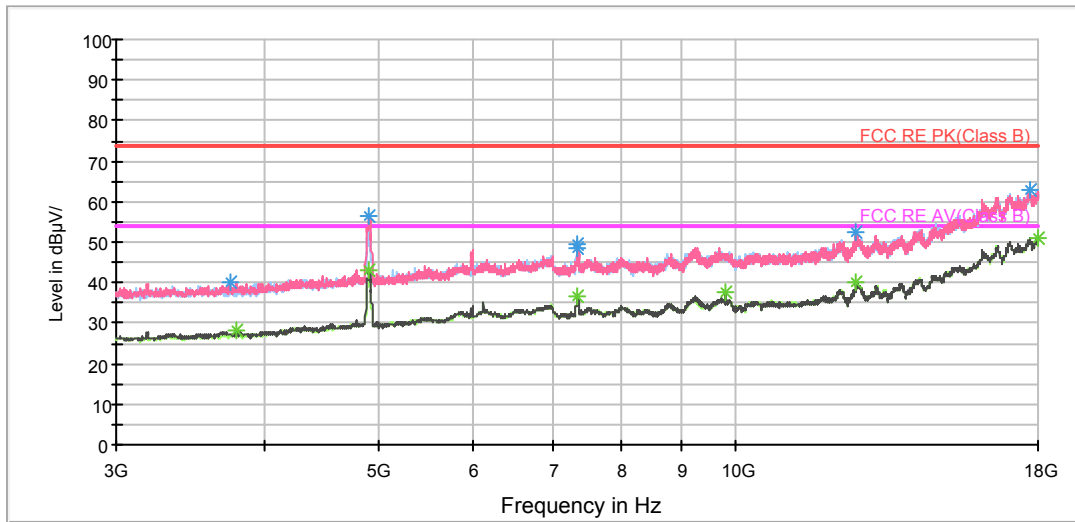

Radiates Emission from 3GHz to 18GHz

Frequency (MHz)	Peak (dBuV/m)	Height (cm)	Polarization	Azimuth (deg)	Reading value (dBuV/m)	Correct Factor (dB)	Margin (dB)	Limit (dBuV/m)
3738.750000	40.1	200.0	V	0.0	41.8	-1.7	33.9	74
4901.250000	56.5	200.0	V	44.0	54.6	1.9	17.5	74
7344.375000	48.7	100.0	V	109.0	41.7	7.0	25.3	74
7355.625000	49.5	100.0	V	109.0	42.5	7.0	24.5	74
12643.125000	52.4	100.0	H	319.0	38.0	14.4	21.6	74
17703.750000	63.0	200.0	H	222.0	38.3	24.7	11.0	74

Remark: 1. Correction Factor = Antenna factor+ Insertion loss (cable loss + amplifier gain)

Frequency (MHz)	Average (dBuV/m)	Height (cm)	Polarization	Azimuth (deg)	Reading value (dBuV/m)	Correct Factor (dB)	Margin (dB)	Limit (dBuV/m)
3787.500000	28.1	100.0	V	17.0	29.9	-1.8	25.9	54
4905.000000	43.2	100.0	V	17.0	41.3	1.9	10.8	54
7348.125000	36.5	200.0	H	86.0	29.5	7.0	17.5	54
9808.125000	37.7	100.0	V	40.0	27.8	9.9	16.3	54
12639.375000	40.2	200.0	H	109.0	25.7	14.5	13.8	54
18000.000000	50.9	200.0	V	274.0	25.4	25.5	3.1	54

Remark: 1. Correction Factor = Antenna factor+ Insertion loss (cable loss + amplifier gain)

RE 18-26.5GHz PK+AV

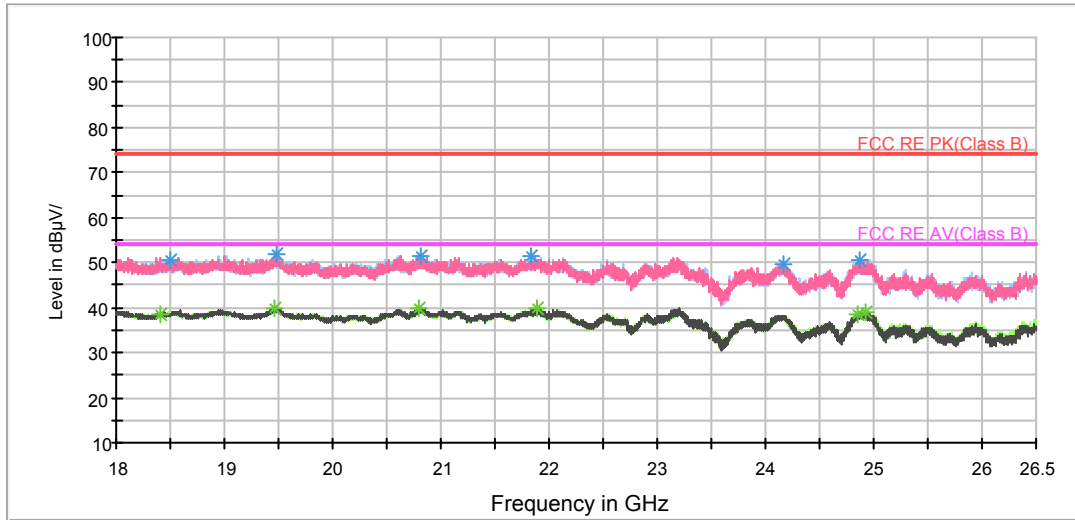

Radiates Emission from 18GHz to 26GHz

Frequency (MHz)	Peak (dBuV/m)	Polarization	Azimuth (deg)	Reading value (dBuV/m)	Correct Factor (dB)	Margin (dB)	Limit (dBuV/m)
18490.875000	50.6	H	342.0	50.2	0.4	23.4	74
19480.062500	52.1	H	329.0	52.0	0.1	21.9	74
20811.375000	51.5	H	0.0	53.5	-2.0	22.5	74
21842.000000	51.3	H	139.0	53.2	-1.9	22.7	74
24162.500000	49.8	H	329.0	50.5	-0.7	24.2	74
24873.312500	50.6	V	51.0	50.1	0.5	23.4	74

Remark: 1. Correction Factor = Antenna factor+ Insertion loss (cable loss + amplifier gain)

Frequency (MHz)	Average (dBuV/m)	Polarization	Azimuth (deg)	Reading value (dBuV/m)	Correct Factor (dB)	Margin (dB)	Limit (dBuV/m)
18398.437500	38.4	H	342.0	37.8	0.6	15.6	54
19466.250000	39.9	V	65.0	39.8	0.1	14.1	54
20790.125000	39.8	V	0.0	41.7	-1.9	14.2	54
21887.687500	39.8	V	92.0	41.4	-1.6	14.2	54
24843.562500	38.5	H	261.0	38.2	0.3	15.5	54
24916.875000	39.0	H	98.0	38.3	0.7	15.0	54

Remark: 1. Correction Factor = Antenna factor+ Insertion loss (cable loss + amplifier gain)

5.8. Conducted Emission

Ambient condition

Temperature	Relative humidity	Pressure
23°C ~25°C	45%~50%	101.5kPa

Methods of Measurement

The EUT is placed on a non-metallic table of 80cm height above the horizontal metal reference ground plane. During the test, the EUT was operating in its typical mode. The test method is according to ANSI C63.10-2013. Connect the AC power line of the EUT to the L.I.S.N. Use EMI receiver to detect the average and Quasi-peak value. RBW is set to 9 kHz, VBW is set to 30kHz. The measurement result should include both L line and N line.

The test is in transmitting mode.

Test Setup

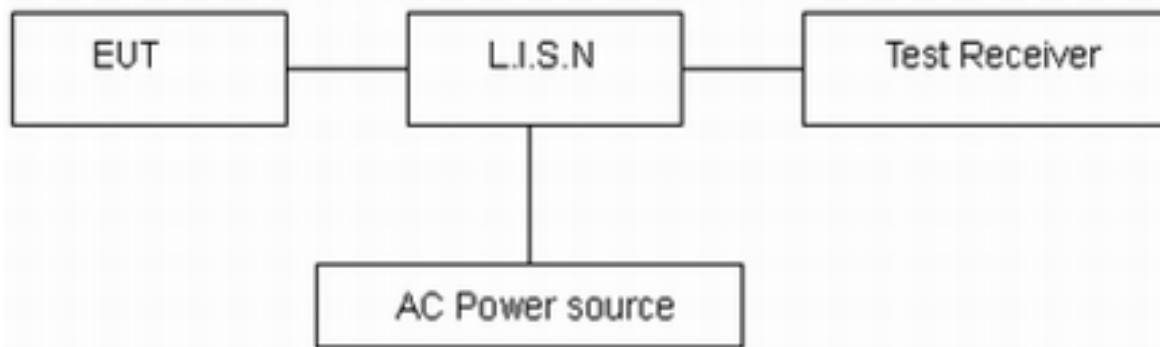

Note: AC Power source is used to change the voltage 110V/60Hz.

Limits

Frequency (MHz)	Conducted Limits(dBμV)	
	Quasi-peak	Average
0.15 - 0.5	66 to 56 *	56 to 46*
0.5 - 5	56	46
5 - 30	60	50

*: Decreases with the logarithm of the frequency.

Measurement Uncertainty

The assessed measurement uncertainty to ensure 95% confidence level for the normal distribution is with the coverage factor $k = 1.96$, $U = 2.69$ dB.



Test Results:

Following plots, Blue trace uses the peak detection and Green trace uses the average detection.

SISO Antenna 1

802.11b, Channel No.: 1

L Line

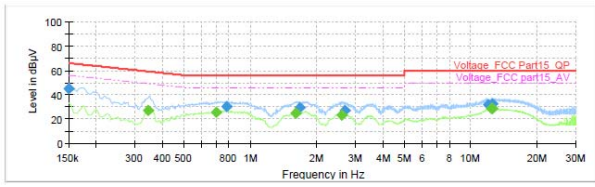

Final Result

Table with 10 columns: Frequency (MHz), QuasiPeak (dBµV), Average (dBµV), Limit (dBµV), Margin (dB), Meas. Time (ms), Bandwidth (kHz), Line, Filter, Corr. (dB). Contains 14 rows of test data.

N Line

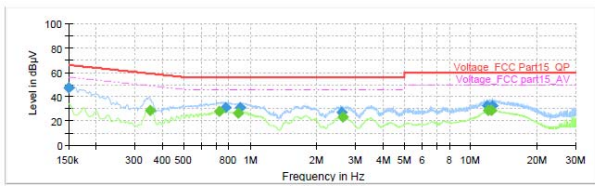

Final Result

Table with 10 columns: Frequency (MHz), QuasiPeak (dBµV), Average (dBµV), Limit (dBµV), Margin (dB), Meas. Time (ms), Bandwidth (kHz), Line, Filter, Corr. (dB). Contains 14 rows of test data.

802.11b, Channel No.: 6

L Line

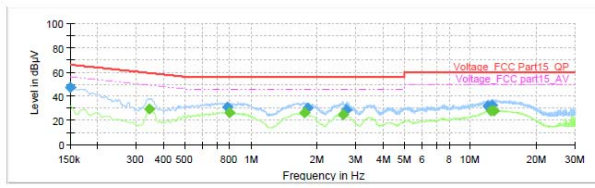

Final Result

Table with 10 columns: Frequency (MHz), QuasiPeak (dBµV), Average (dBµV), Limit (dBµV), Margin (dB), Meas. Time (ms), Bandwidth (kHz), Line, Filter, Corr. (dB). Contains 14 rows of test data.

N Line

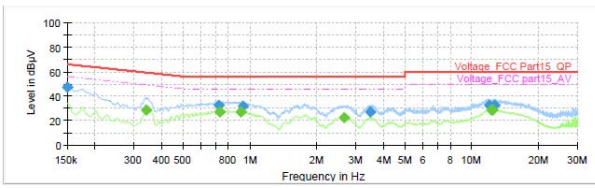

Final Result

Table with 10 columns: Frequency (MHz), QuasiPeak (dBµV), Average (dBµV), Limit (dBµV), Margin (dB), Meas. Time (ms), Bandwidth (kHz), Line, Filter, Corr. (dB). Contains 14 rows of test data.

802.11b, Channel No.: 11

L Line

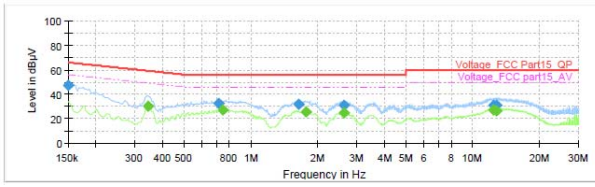

Final Result

Table with 10 columns: Frequency (MHz), QuasiPeak (dBµV), Average (dBµV), Limit (dBµV), Margin (dB), Meas. Time (ms), Bandwidth (kHz), Line, Filter, Corr. (dB). Contains 14 rows of test data.



N Line

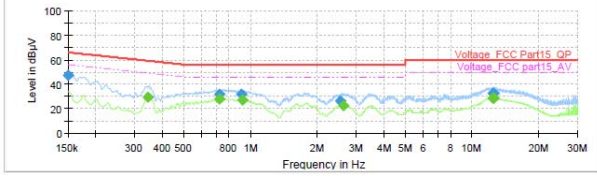

Final Result

Table with 10 columns: Frequency (MHz), QuasiPeak (dBµV), Average (dBµV), Limit (dBµV), Margin (dB), Meas. Time (ms), Bandwidth (kHz), Line, Filter, Corr. (dB). Contains 15 rows of test data.

802.11g, Channel No.: 1

L Line

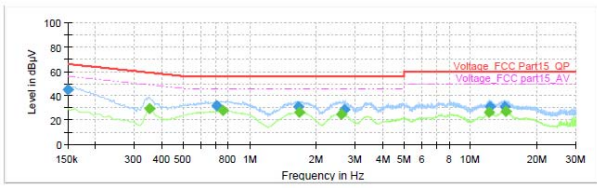

Final Result

Table with 10 columns: Frequency (MHz), QuasiPeak (dBµV), Average (dBµV), Limit (dBµV), Margin (dB), Meas. Time (ms), Bandwidth (kHz), Line, Filter, Corr. (dB). Contains 15 rows of test data.

N Line

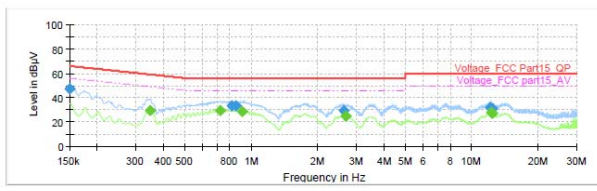

Final Result

Table with 10 columns: Frequency (MHz), QuasiPeak (dBµV), Average (dBµV), Limit (dBµV), Margin (dB), Meas. Time (ms), Bandwidth (kHz), Line, Filter, Corr. (dB). Contains 15 rows of test data.

802.11g, Channel No.: 6

L Line

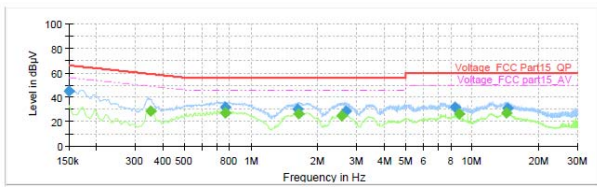

Final Result

Table with 10 columns: Frequency (MHz), QuasiPeak (dBµV), Average (dBµV), Limit (dBµV), Margin (dB), Meas. Time (ms), Bandwidth (kHz), Line, Filter, Corr. (dB). Contains 15 rows of test data.

N Line

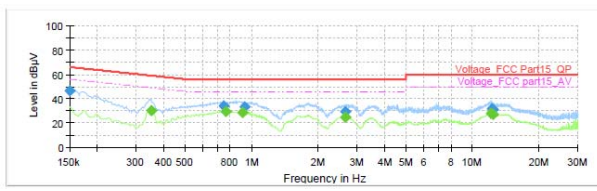

Final Result

Table with 10 columns: Frequency (MHz), QuasiPeak (dBµV), Average (dBµV), Limit (dBµV), Margin (dB), Meas. Time (ms), Bandwidth (kHz), Line, Filter, Corr. (dB). Contains 15 rows of test data.



802.11g, Channel No.: 11

L Line

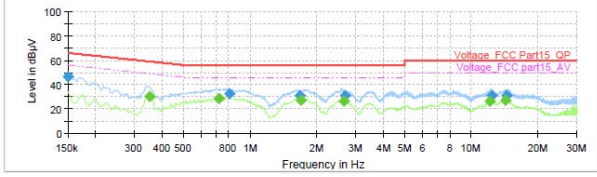

Final Result

Frequency (MHz)	QuasiPeak (dBµV)	Average (dBµV)	Limit (dBµV)	Margin (dB)	Meas. Time (ms)	Bandwidth (kHz)	Line	Filter	Corr. (dB)
0.150000	46.89	---	66.00	19.11	1000.0	9.000	L1	ON	19.1
0.352500	---	29.88	48.90	19.03	1000.0	9.000	L1	ON	19.2
0.723750	---	28.38	46.00	17.62	1000.0	9.000	L1	ON	19.2
0.802500	32.19	---	56.00	23.81	1000.0	9.000	L1	ON	19.2
1.677750	31.25	---	56.00	24.75	1000.0	9.000	L1	ON	19.2
1.691250	---	26.87	46.00	19.13	1000.0	9.000	L1	ON	19.2
2.663250	---	26.25	46.00	19.75	1000.0	9.000	L1	ON	19.0
2.683500	30.92	---	56.00	25.08	1000.0	9.000	L1	ON	19.0
12.129000	---	26.62	50.00	23.38	1000.0	9.000	L1	ON	19.4
12.327000	30.68	---	60.00	29.32	1000.0	9.000	L1	ON	19.4
14.221500	---	27.22	50.00	22.78	1000.0	9.000	L1	ON	19.5
14.489250	31.20	---	60.00	28.80	1000.0	9.000	L1	ON	19.5

N Line

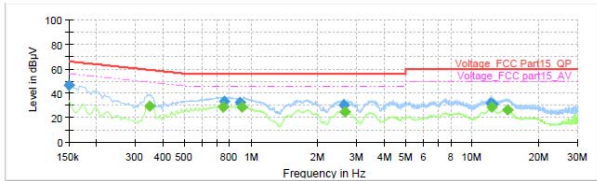

Final Result

Frequency (MHz)	QuasiPeak (dBµV)	Average (dBµV)	Limit (dBµV)	Margin (dB)	Meas. Time (ms)	Bandwidth (kHz)	Line	Filter	Corr. (dB)
0.150000	46.87	---	66.00	19.13	1000.0	9.000	N	ON	19.1
0.348000	---	29.77	49.01	19.24	1000.0	9.000	N	ON	19.2
0.748500	---	29.01	46.00	16.99	1000.0	9.000	N	ON	19.2
0.755250	33.21	---	56.00	22.79	1000.0	9.000	N	ON	19.2
0.890250	32.86	---	56.00	23.14	1000.0	9.000	N	ON	19.2
0.912750	---	29.03	46.00	16.97	1000.0	9.000	N	ON	19.2
2.627250	29.94	---	56.00	26.06	1000.0	9.000	N	ON	19.0
2.658750	---	25.17	46.00	20.83	1000.0	9.000	N	ON	19.0
12.099750	31.65	---	60.00	28.35	1000.0	9.000	N	ON	19.4
12.189750	---	28.54	50.00	21.46	1000.0	9.000	N	ON	19.4
12.347250	31.27	---	60.00	28.73	1000.0	9.000	N	ON	19.4
14.354250	---	26.72	50.00	23.28	1000.0	9.000	N	ON	19.4

MIMO

802.11n(HT20), Channel No.: 1

L Line

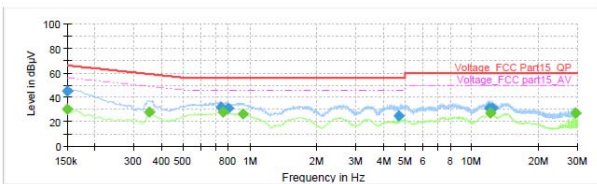

Final Result

Frequency (MHz)	QuasiPeak (dBµV)	Average (dBµV)	Limit (dBµV)	Margin (dB)	Meas. Time (ms)	Bandwidth (kHz)	Line	Filter	Corr. (dB)
0.150000	---	30.04	56.00	25.96	1000.0	9.000	L1	ON	19.1
0.150000	45.20	---	66.00	20.80	1000.0	9.000	L1	ON	19.1
0.352500	---	27.57	48.90	21.34	1000.0	9.000	L1	ON	19.2
0.737250	32.06	---	56.00	23.94	1000.0	9.000	L1	ON	19.2
0.753000	---	28.03	46.00	17.97	1000.0	9.000	L1	ON	19.2
0.798000	31.15	---	56.00	24.85	1000.0	9.000	L1	ON	19.2
0.933000	---	26.62	46.00	19.38	1000.0	9.000	L1	ON	19.2
4.701750	24.99	---	56.00	31.01	1000.0	9.000	L1	ON	19.1
11.985000	30.95	---	60.00	29.05	1000.0	9.000	L1	ON	19.4
12.115500	---	27.27	50.00	22.73	1000.0	9.000	L1	ON	19.4
12.363000	30.67	---	60.00	29.33	1000.0	9.000	L1	ON	19.4
29.235750	---	26.79	50.00	23.21	1000.0	9.000	L1	ON	19.8

N Line

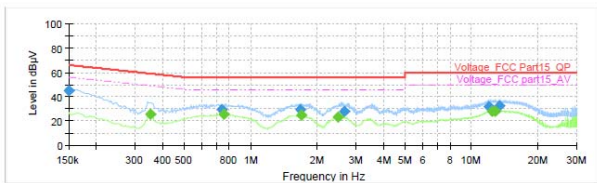

Final Result

Frequency (MHz)	QuasiPeak (dBµV)	Average (dBµV)	Limit (dBµV)	Margin (dB)	Meas. Time (ms)	Bandwidth (kHz)	Line	Filter	Corr. (dB)
0.150000	44.76	---	66.00	21.24	1000.0	9.000	N	ON	19.1
0.350250	---	25.34	48.96	23.62	1000.0	9.000	N	ON	19.2
0.737250	29.42	---	56.00	26.58	1000.0	9.000	N	ON	19.2
0.753000	---	25.53	46.00	20.47	1000.0	9.000	N	ON	19.2
1.668750	29.08	---	56.00	26.92	1000.0	9.000	N	ON	19.2
1.693500	---	24.99	46.00	21.01	1000.0	9.000	N	ON	19.2
2.496750	---	22.92	46.00	23.08	1000.0	9.000	N	ON	19.0
2.654250	27.75	---	56.00	28.25	1000.0	9.000	N	ON	19.0
11.933250	31.55	---	60.00	28.45	1000.0	9.000	N	ON	19.4
12.419250	---	28.20	50.00	21.80	1000.0	9.000	N	ON	19.4
12.828750	---	28.18	50.00	21.82	1000.0	9.000	N	ON	19.5
13.357500	32.62	---	60.00	27.38	1000.0	9.000	N	ON	19.5

802.11n(HT20), Channel No.: 6

L Line

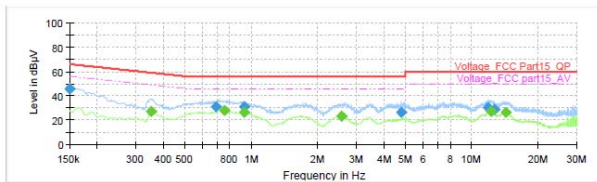

Final Result

Frequency (MHz)	QuasiPeak (dBµV)	Average (dBµV)	Limit (dBµV)	Margin (dB)	Meas. Time (ms)	Bandwidth (kHz)	Line	Filter	Corr. (dB)
0.150000	45.42	---	66.00	20.58	1000.0	9.000	L1	ON	19.1
0.352500	---	27.19	48.90	21.72	1000.0	9.000	L1	ON	19.2
0.690000	30.95	---	56.00	25.05	1000.0	9.000	L1	ON	19.3
0.753000	---	27.81	46.00	18.19	1000.0	9.000	L1	ON	19.2
0.930750	31.15	---	56.00	24.85	1000.0	9.000	L1	ON	19.2
0.933000	---	26.46	46.00	19.54	1000.0	9.000	L1	ON	19.2
2.566500	---	23.08	46.00	22.92	1000.0	9.000	L1	ON	19.0
4.791750	26.04	---	56.00	29.96	1000.0	9.000	L1	ON	19.1
11.836500	30.20	---	60.00	29.81	1000.0	9.000	L1	ON	19.4
12.201000	---	27.25	50.00	22.75	1000.0	9.000	L1	ON	19.4
12.682500	28.51	---	60.00	31.49	1000.0	9.000	L1	ON	19.5
14.336250	---	26.13	50.00	23.87	1000.0	9.000	L1	ON	19.5



N Line

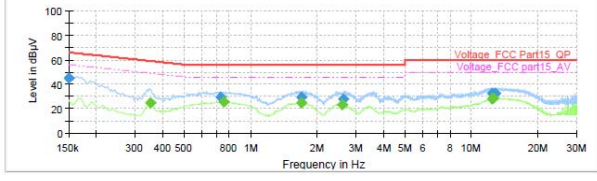

Final Result

Frequency (MHz)	QuasiPeak (dBµV)	Average (dBµV)	Limit (dBµV)	Margin (dB)	Meas. Time (ms)	Bandwidth (kHz)	Line	Filter	Corr. (dB)
0.150000	44.97	---	66.00	21.03	1000.0	9.000	N	ON	19.1
0.350250	---	25.05	48.96	23.91	1000.0	9.000	N	ON	19.2
0.735000	29.21	---	56.00	26.79	1000.0	9.000	N	ON	19.2
0.753000	---	25.36	46.00	20.64	1000.0	9.000	N	ON	19.2
1.689000	29.10	---	56.00	26.90	1000.0	9.000	N	ON	19.2
1.693500	---	25.06	46.00	20.94	1000.0	9.000	N	ON	19.2
2.589000	---	23.43	46.00	22.57	1000.0	9.000	N	ON	19.0
2.522750	27.82	---	56.00	28.18	1000.0	9.000	N	ON	19.0
12.383250	---	28.16	50.00	21.84	1000.0	9.000	N	ON	19.4
12.423750	32.28	---	60.00	27.72	1000.0	9.000	N	ON	19.4
12.504750	---	28.37	50.00	21.63	1000.0	9.000	N	ON	19.4
12.754500	32.25	---	60.00	27.75	1000.0	9.000	N	ON	19.5

802.11n(HT20), Channel No.: 11

L Line

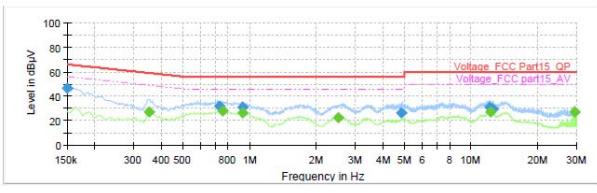

Final Result

Frequency (MHz)	QuasiPeak (dBµV)	Average (dBµV)	Limit (dBµV)	Margin (dB)	Meas. Time (ms)	Bandwidth (kHz)	Line	Filter	Corr. (dB)
0.150000	46.15	---	66.00	19.85	1000.0	9.000	L1	ON	19.1
0.352500	---	27.25	48.90	21.65	1000.0	9.000	L1	ON	19.2
0.735000	31.82	---	56.00	24.18	1000.0	9.000	L1	ON	19.2
0.755250	---	27.53	46.00	18.47	1000.0	9.000	L1	ON	19.2
0.930750	31.05	---	56.00	24.95	1000.0	9.000	L1	ON	19.2
0.933000	---	26.65	46.00	19.35	1000.0	9.000	L1	ON	19.2
2.519250	---	22.78	46.00	23.22	1000.0	9.000	L1	ON	19.0
4.839000	26.61	---	56.00	29.39	1000.0	9.000	L1	ON	19.1
12.176250	31.37	---	60.00	28.63	1000.0	9.000	L1	ON	19.4
12.196500	---	27.31	50.00	22.69	1000.0	9.000	L1	ON	19.4
12.489000	29.64	---	60.00	30.36	1000.0	9.000	L1	ON	19.4
29.235750	---	27.19	50.00	22.81	1000.0	9.000	L1	ON	19.8

N Line

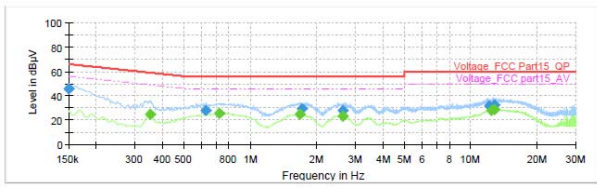

Final Result

Frequency (MHz)	QuasiPeak (dBµV)	Average (dBµV)	Limit (dBµV)	Margin (dB)	Meas. Time (ms)	Bandwidth (kHz)	Line	Filter	Corr. (dB)
0.150000	45.98	---	66.00	20.02	1000.0	9.000	N	ON	19.1
0.350250	---	25.05	48.96	23.91	1000.0	9.000	N	ON	19.2
0.627000	28.15	---	56.00	27.85	1000.0	9.000	N	ON	19.3
0.721500	---	25.21	46.00	20.79	1000.0	9.000	N	ON	19.2
1.573250	---	25.05	46.00	20.95	1000.0	9.000	N	ON	19.2
1.709250	29.11	---	56.00	26.89	1000.0	9.000	N	ON	19.2
2.618250	27.82	---	56.00	28.18	1000.0	9.000	N	ON	19.0
2.631750	---	23.32	46.00	22.68	1000.0	9.000	N	ON	19.0
12.068250	31.92	---	60.00	28.08	1000.0	9.000	N	ON	19.4
12.322500	---	28.13	50.00	21.87	1000.0	9.000	N	ON	19.4
12.745500	32.66	---	60.00	27.34	1000.0	9.000	N	ON	19.5
12.810750	---	28.37	50.00	21.64	1000.0	9.000	N	ON	19.5

802.11n(HT40), Channel No.: 3

L Line

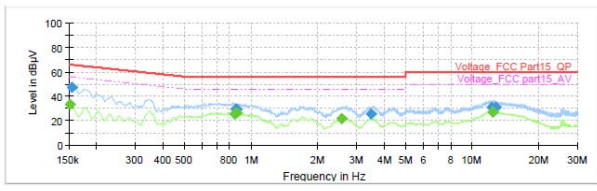

Final Result

Frequency (MHz)	QuasiPeak (dBµV)	Average (dBµV)	Limit (dBµV)	Margin (dB)	Meas. Time (ms)	Bandwidth (kHz)	Line	Filter	Corr. (dB)
0.152250	---	33.56	55.88	22.32	1000.0	9.000	L1	ON	19.0
0.154500	46.94	---	65.75	18.81	1000.0	9.000	L1	ON	19.1
0.843900	---	25.94	46.00	20.06	1000.0	9.000	L1	ON	19.2
0.849750	29.72	---	56.00	26.28	1000.0	9.000	L1	ON	19.2
0.858750	29.81	---	56.00	26.19	1000.0	9.000	L1	ON	19.2
0.863250	---	26.18	46.00	19.82	1000.0	9.000	L1	ON	19.2
2.577750	---	21.54	46.00	24.46	1000.0	9.000	L1	ON	19.0
3.500250	25.32	---	56.00	30.68	1000.0	9.000	L1	ON	19.1
12.219000	31.09	---	60.00	28.91	1000.0	9.000	L1	ON	19.4
12.356250	---	27.15	50.00	22.85	1000.0	9.000	L1	ON	19.4
12.410250	---	27.18	50.00	22.83	1000.0	9.000	L1	ON	19.4
12.734250	31.00	---	60.00	29.00	1000.0	9.000	L1	ON	19.5

N Line

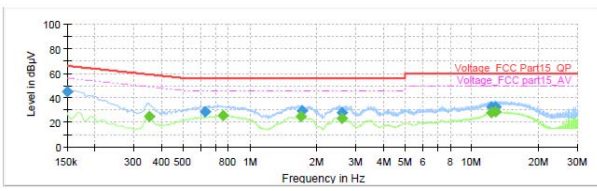

Final Result

Frequency (MHz)	QuasiPeak (dBµV)	Average (dBµV)	Limit (dBµV)	Margin (dB)	Meas. Time (ms)	Bandwidth (kHz)	Line	Filter	Corr. (dB)
0.150000	45.35	---	66.00	20.65	1000.0	9.000	N	ON	19.1
0.350250	---	25.02	48.96	23.93	1000.0	9.000	N	ON	19.2
0.629250	28.95	---	56.00	27.05	1000.0	9.000	N	ON	19.3
0.755250	---	25.28	46.00	20.72	1000.0	9.000	N	ON	19.2
1.686750	---	24.99	46.00	21.01	1000.0	9.000	N	ON	19.2
1.711500	29.08	---	56.00	26.92	1000.0	9.000	N	ON	19.2
2.595750	---	23.54	46.00	22.46	1000.0	9.000	N	ON	19.0
2.607000	28.04	---	56.00	27.96	1000.0	9.000	N	ON	19.0
12.246000	---	28.01	50.00	21.99	1000.0	9.000	N	ON	19.4
12.309000	32.30	---	60.00	27.70	1000.0	9.000	N	ON	19.4
12.747750	---	28.37	50.00	21.63	1000.0	9.000	N	ON	19.5
12.750000	32.76	---	60.00	27.24	1000.0	9.000	N	ON	19.5



802.11n(HT40), Channel No.: 6

L Line

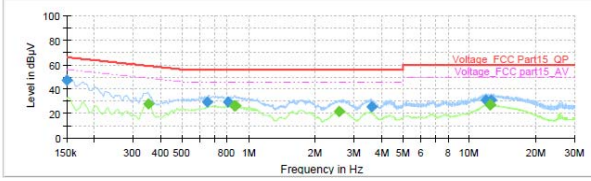

Final Result

Frequency (MHz)	QuasiPeak (dBµV)	Average (dBµV)	Limit (dBµV)	Margin (dB)	Meas. Time (ms)	Bandwidth (kHz)	Line	Filter	Corr. (dB)
0.150000	46.94	---	66.00	19.06	1000.0	9.000	L1	ON	19.1
0.350250	---	27.82	48.96	21.14	1000.0	9.000	L1	ON	19.2
0.645000	29.54	---	56.00	26.46	1000.0	9.000	L1	ON	19.3
0.809250	29.27	---	56.00	26.73	1000.0	9.000	L1	ON	19.2
0.863250	---	26.11	46.00	19.89	1000.0	9.000	L1	ON	19.2
0.867750	---	26.16	46.00	19.84	1000.0	9.000	L1	ON	19.2
2.577750	---	21.58	46.00	24.42	1000.0	9.000	L1	ON	19.0
3.510500	25.26	---	56.00	30.74	1000.0	9.000	L1	ON	19.1
11.886000	30.98	---	60.00	29.02	1000.0	9.000	L1	ON	19.4
12.430500	---	27.14	50.00	22.86	1000.0	9.000	L1	ON	19.4
12.432750	---	27.16	50.00	22.84	1000.0	9.000	L1	ON	19.4
12.576750	31.08	---	60.00	28.92	1000.0	9.000	L1	ON	19.5

N Line

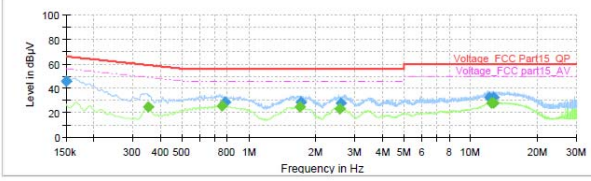

Final Result

Frequency (MHz)	QuasiPeak (dBµV)	Average (dBµV)	Limit (dBµV)	Margin (dB)	Meas. Time (ms)	Bandwidth (kHz)	Line	Filter	Corr. (dB)
0.150000	45.82	---	66.00	20.18	1000.0	9.000	N	ON	19.1
0.350250	---	24.76	48.96	24.20	1000.0	9.000	N	ON	19.2
0.755250	---	25.30	46.00	20.70	1000.0	9.000	N	ON	19.2
0.784500	28.95	---	56.00	27.05	1000.0	9.000	N	ON	19.2
1.695750	---	25.01	46.00	20.99	1000.0	9.000	N	ON	19.2
1.720500	28.82	---	56.00	27.18	1000.0	9.000	N	ON	19.2
2.580000	---	23.46	46.00	22.54	1000.0	9.000	N	ON	19.0
2.607000	27.79	---	56.00	28.21	1000.0	9.000	N	ON	19.0
12.135750	32.28	---	60.00	27.72	1000.0	9.000	N	ON	19.4
12.387750	---	28.19	50.00	21.81	1000.0	9.000	N	ON	19.4
12.648750	32.30	---	60.00	27.70	1000.0	9.000	N	ON	19.4
12.693750	---	28.22	50.00	21.78	1000.0	9.000	N	ON	19.4

802.11n(HT40), Channel No.: 9

L Line

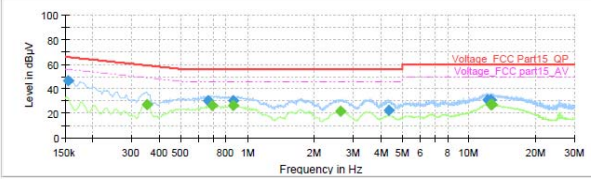

Final Result

Frequency (MHz)	QuasiPeak (dBµV)	Average (dBµV)	Limit (dBµV)	Margin (dB)	Meas. Time (ms)	Bandwidth (kHz)	Line	Filter	Corr. (dB)
0.154500	46.68	---	65.75	19.07	1000.0	9.000	L1	ON	19.1
0.350250	---	27.41	48.96	21.55	1000.0	9.000	L1	ON	19.2
0.660750	29.95	---	56.00	26.05	1000.0	9.000	L1	ON	19.3
0.694500	---	26.17	46.00	19.83	1000.0	9.000	L1	ON	19.3
0.861000	30.04	---	56.00	25.96	1000.0	9.000	L1	ON	19.2
0.863250	---	26.24	46.00	19.76	1000.0	9.000	L1	ON	19.2
2.613750	---	21.60	46.00	24.40	1000.0	9.000	L1	ON	19.0
4.321500	22.79	---	56.00	33.21	1000.0	9.000	L1	ON	19.1
12.102000	31.11	---	60.00	28.89	1000.0	9.000	L1	ON	19.4
12.457500	---	27.09	50.00	22.91	1000.0	9.000	L1	ON	19.4
12.538500	31.11	---	60.00	28.89	1000.0	9.000	L1	ON	19.4
12.590250	---	27.03	50.00	22.97	1000.0	9.000	L1	ON	19.5

N Line

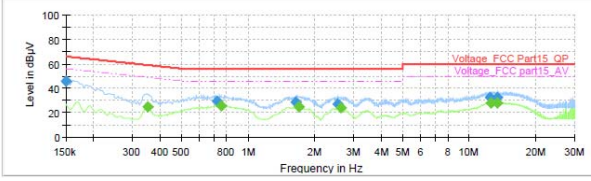

Final Result

Frequency (MHz)	QuasiPeak (dBµV)	Average (dBµV)	Limit (dBµV)	Margin (dB)	Meas. Time (ms)	Bandwidth (kHz)	Line	Filter	Corr. (dB)
0.150000	45.47	---	66.00	20.53	1000.0	9.000	N	ON	19.1
0.350250	---	24.82	48.96	24.14	1000.0	9.000	N	ON	19.2
0.723750	29.44	---	56.00	26.56	1000.0	9.000	N	ON	19.2
0.753000	---	25.32	46.00	20.68	1000.0	9.000	N	ON	19.2
1.635000	28.42	---	56.00	27.58	1000.0	9.000	N	ON	19.2
1.700250	---	25.00	46.00	21.00	1000.0	9.000	N	ON	19.2
2.530500	27.29	---	56.00	28.71	1000.0	9.000	N	ON	19.0
2.613750	---	23.70	46.00	22.30	1000.0	9.000	N	ON	19.0
12.349500	32.36	---	60.00	27.64	1000.0	9.000	N	ON	19.4
12.480000	---	28.21	50.00	21.79	1000.0	9.000	N	ON	19.4
13.359750	32.66	---	60.00	27.34	1000.0	9.000	N	ON	19.5
13.362000	---	28.19	50.00	21.81	1000.0	9.000	N	ON	19.5



6. Main Test Instruments

Name	Type	Manufacturer	Serial Number	Calibration Date	Expiration Time
Spectrum Analyzer	FSV30	R&S	100815	2016-12-16	2017-12-15
EMI Test Receiver	ESCI	R&S	100948	2017-05-20	2018-05-19
TRILOG Broadband Antenna	VULB 9163	Schwarzbeck	9163-201	2014-12-06	2017-12-05
Double Ridged Waveguide Horn Antenna	HF907	R&S	100126	2014-12-06	2017-12-05
Loop Antenna	FMZB1519	SCHWARZBECK	1519-047	2017-02-18	2020-02-17
Standard Gain Horn	3160-09	ETS-Lindgren	00102644	2015-01-30	2018-01-29
EMI Test Receiver	ESCS30	R&S	100138	2016-12-16	2017-12-15
LISN	ENV216	R&S	101171	2016-12-17	2019-12-16
Spectrum Analyzer	N9010A	Agilent	MY47191109	2017-05-20	2018-05-19
RF Cable	SMA 15cm	Agilent	0001	2017-02-06	2017-08-05

*****END OF REPORT *****

ANNEX A: EUT Appearance and Test Setup

A.1 EUT Appearance



Picture 1-1: EUT



Adapter 1

Picture 1-2: Adapter

Picture 1 EUT and Accessory

A.2 Test Setup



30M Hz-1GHz

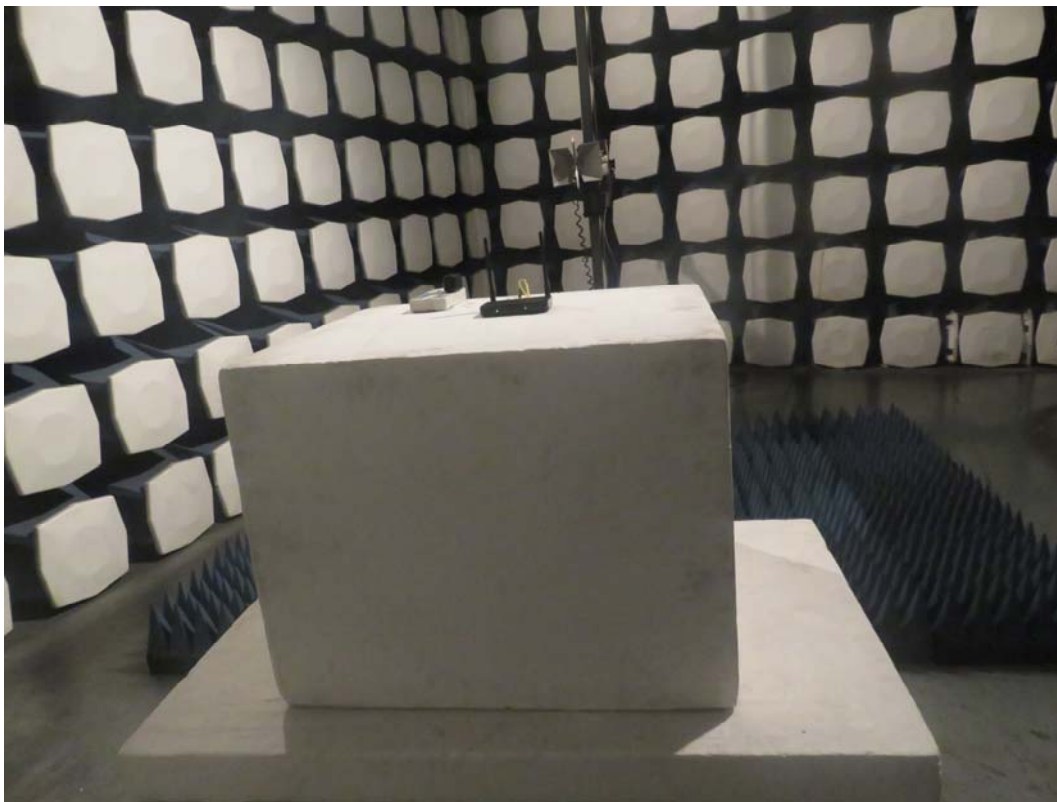

Above 1GHz

Picture 2 Radiated Emission Test Setup

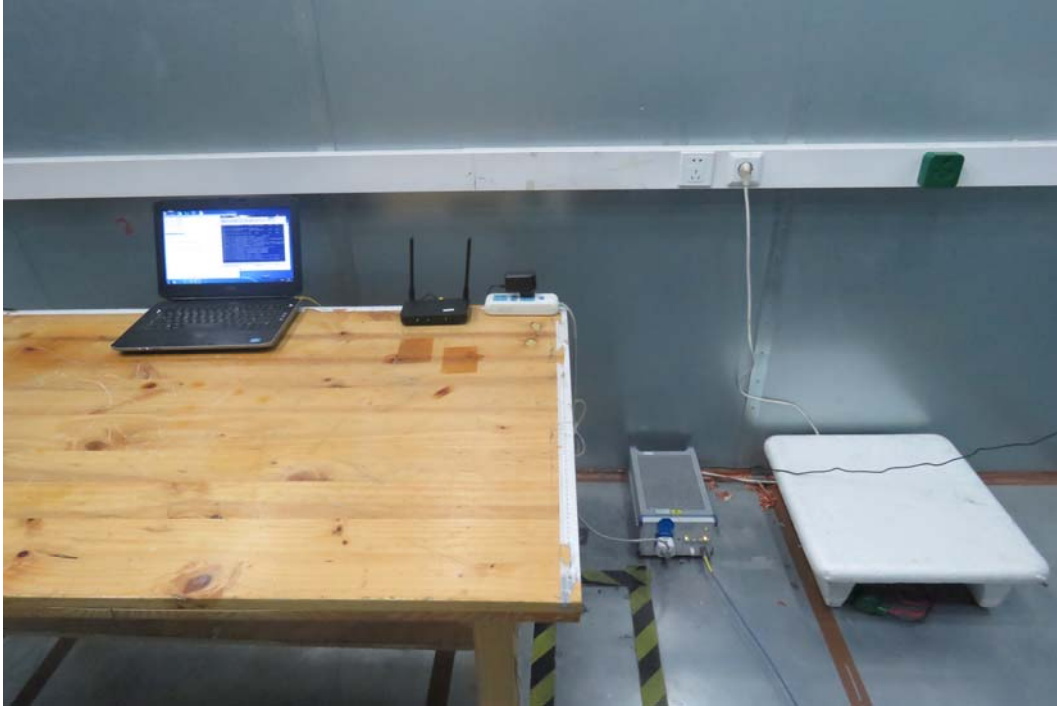

Picture 3 Conducted Emission Test Setup