

FCC&ISED RF TEST REPORT

No. 170201711SHA-001

Applicant : Alcatel-Lucent Shanghai Bell Co., Ltd.
388-389#, Ningqiao Road, Pudong Jinqiao, Shanghai, China

Manufacturer : Alcatel-Lucent Shanghai Bell Co.,Ltd.
388-389#, Ningqiao Road, Pudong Jinqiao, Shanghai, China

Product Name : Digital Home CPE

Type/Model : A-240Z-A

EMA Code : 3FE 46615 AAAA

TEST RESULT : PASS

SUMMARY

The equipment complies with the requirements according to the following standard(s) or specification:

47CFR Part 15 (2016): Radio Frequency Devices (Subpart C)

ANSI C63.10 (2013): American National Standard of Procedures for Compliance Testing of Unlicensed Wireless Devices

RSS-247 Issue 2 (February 2017): Digital Transmission Systems (DTSs), Frequency Hopping Systems (FHSs) and Licence-Exempt Local Area Network (LE-LAN) Devices

RSS-Gen Issue 4 (November 2014): General Requirements for Compliance of Radio Apparatus

Date of issue: June 7, 2017

Prepared by:

Wade Zhang (Project Engineer)

Reviewed by:

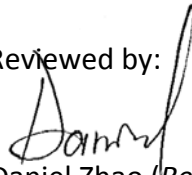
Daniel Zhao (Reviewer)

Description of Test Facility

Name: Intertek Testing Service Limited Shanghai
Address: Building No.86, 1198 Qinzhou Road (North), Shanghai 200233, P.R. China

FCC Registration Number: 236597
IC Assigned Code: 2402B-1

Name of contact: Jonny Jing
Tel: 86 21 61278271
Fax: 86 21 54262353

Content

SUMMARY.....	1
DESCRIPTION OF TEST FACILITY.....	2
1 GENERAL INFORMATION.....	4
1.1 DESCRIPTION OF CLIENT	4
1.2 IDENTIFICATION OF THE EUT	4
1.3 TECHNICAL SPECIFICATION	4
2 TEST SPECIFICATIONS.....	5
2.1 STANDARDS OR SPECIFICATION	5
2.2 MODE OF OPERATION DURING THE TEST	5
2.3 TEST SOFTWARE LIST	6
2.4 TEST PERIPHERALS LIST	6
2.5 INSTRUMENT LIST	7
2.6 TEST SUMMARY	8
2.7 MEASUREMENT UNCERTAINTY	9
3 MINIMUM 6DB BANDWIDTH	10
3.1 LIMIT	10
3.2 TEST CONFIGURATION.....	10
3.3 TEST PROCEDURE AND TEST SETUP.....	10
3.4 TEST PROTOCOL.....	11
4 MAXIMUM CONDUCTED OUTPUT POWER	18
4.1 TEST LIMIT	18
4.2 TEST CONFIGURATION.....	18
4.3 TEST PROCEDURE AND TEST SETUP	18
4.4 TEST PROTOCOL	19
5 POWER SPECTRUM DENSITY	20
5.1 TEST LIMIT	20
5.2 TEST CONFIGURATION.....	20
5.3 TEST PROCEDURE AND TEST SETUP	21
5.4 TEST PROTOCOL.....	22
6 EMISSION OUTSIDE THE FREQUENCY BAND	32
6.1 TEST LIMIT	32
6.2 TEST CONFIGURATION.....	32
6.3 TEST PROCEDURE AND TEST SETUP	33
6.4 TEST PROTOCOL.....	34
7 RADIATED EMISSIONS.....	47
7.1 TEST LIMIT	47
7.2 TEST CONFIGURATION.....	47
7.3 TEST PROCEDURE AND TEST SETUP	48
7.4 TEST PROTOCOL.....	49
8 POWER LINE CONDUCTED EMISSION.....	53
8.1 LIMIT	53
8.2 TEST CONFIGURATION	53
8.3 TEST PROCEDURE AND TEST SET UP	54
8.4 TEST PROTOCOL	55

1 GENERAL INFORMATION

1.1 Description of Client

Applicant : Alcatel-Lucent Shanghai Bell Co., Ltd.
388-389#, Ningqiao Road, Pudong Jinqiao, Shanghai, China
Manufacturer : Alcatel-Lucent Shanghai Bell Co., Ltd.
388-389#, Ningqiao Road, Pudong Jinqiao, Shanghai, China

1.2 Identification of the EUT

Product Name : Digital Home CPE
Type/model : A-240Z-A
FCC ID : 2ADZRA240ZA
IC : 21694-A240ZA

1.3 Technical Specification

Operation Frequency : 2400~2483.5 MHz
Band
Type of Modulation : DBPSK, DQPSK, CCK, BPSK, QPSK, 16-QAM,
64-QAM
EUT Modes of Modulation : 802.11b, 802.11g, 802.11n(HT20), 802.11n(HT40)
Channel Number : 11Channels for 802.11b, 802.11g and 802.11n(HT20),
7 Channels for 802.11n(HT40)
Description of EUT : The EUT is a digital home CPE, it support WIFI, ZigBee and Z-
Wave, and there have only one model, we test it and listed the
WIFI 2.4G band results in this report.
Antenna : PCB antenna, 3dBi max Peak gain, FAF connector
Rating : 100-240V, 50/60Hz
Category of EUT : Class B
EUT type : Table top
 Floor standing
Sample received date : March 6, 2017
Date of test : March 6, 2017 to April 18, 2017

2 TEST SPECIFICATIONS

2.1 Standards or specification

47CFR Part 15 (2016)
 ANSI C63.10 (2013)
 RSS-247 Issue 2 (February 2017)
 RSS-Gen Issue 4 (November 2014)
 KDB 558074 (v04)
 KDB 662911 D01 (v02r01)

2.2 Mode of operation during the test

While testing transmitting mode of EUT, the internal modulation and continuously transmission was applied.

The lowest, middle and highest channel were tested as representatives.

Frequency Band (MHz)	Mode	Lowest (MHz)	Middle (MHz)	Highest (MHz)
2400-2483.5	802.11b	2412	2437	2462
	802.11g	2412	2437	2462
	802.11n(HT20)	2412	2437	2462
	802.11n(HT40)	2422	2437	2452

MIMO Function Description:

Mode	Tx/Rx Function	Beamforming function	Directional gain
802.11b	1Tx/1Rx	NO	3dBi
802.11g	1Tx/1Rx	NO	3dBi
802.11n(HT20)	2Tx/2Rx	NO	3dBi
802.11n(HT40)	2Tx/2Rx	NO	3dBi

Note: all transmit signals are completely uncorrelated with each other, Directional gain= G_{ANT} .

Data rate VS Power:

The pre-scan for the conducted power with all rates in each modulation and bands was used, and the worst case was found and used in all test cases.

After this pre-scan, we choose the following table of the data rate as the worst case.

Frequency Band (MHz)	Mode	Worst case data rate
2400-2483.5	802.11b	1Mbps
	802.11g	6Mbps
	802.11n(HT20)	MCS0
	802.11n(HT40)	MCS0

2.3 Test software list

Test Items	Software	Manufacturer	Version
Conducted emission	ESxS-K1	R&S	V2.1.0
Radiated emission	ES-K1	R&S	V1.71

2.4 Test peripherals list

Item No.	Name	Band and Model	Description
1	Laptop computer	HP ProBook 6470b	100-240V AC, 50/60Hz

2.5 Instrument list

Selected	Equipment	Type	Manu.	Internal no.	Cal. Date	Due date
<input checked="" type="checkbox"/>	PXA Analyzer	N9030A	Agilent	EC5338	2017/3/3	2018/3/2
<input checked="" type="checkbox"/>	Vector SG	N5182B	Agilent	EC5175	2017/3/3	2018/3/2
<input checked="" type="checkbox"/>	Power sensor	U2021XA	Agilent	EC5338-1	2017/3/3	2018/3/2
<input checked="" type="checkbox"/>	MXG Analog SG	N5181A	Agilent	EC5338-2	2017/3/3	2018/3/2
<input checked="" type="checkbox"/>	Power meter	N1911A/N1921A	Agilent	EC4318	2016/5/18	2017/5/17
<input checked="" type="checkbox"/>	EMI Receiver	ESCS 30	R&S	EC 2107	2016/10/19	2017/10/18
<input checked="" type="checkbox"/>	A.M.N.	ESH2-Z5	R&S	EC 3119	2015/12/16	2017/12/15
<input checked="" type="checkbox"/>	I.S.N.	FCC-TLISN-T8-02	FCC	EC3756	2017/2/15	2018/2/14
<input checked="" type="checkbox"/>	EMI chamber	3m	Albatross	EC 3048	2016/9/10	2017/9/9
<input checked="" type="checkbox"/>	Test Receiver	ESIB 26	R&S	EC 3045	2016/10/19	2017/10/18
<input checked="" type="checkbox"/>	Test Receiver	ESCI 7	R&S	EC4501	2017/2/23	2018/2/22
<input checked="" type="checkbox"/>	Bilog Antenna	CBL 6112D	TESEQ	EC 4206	2016/6/2	2017/6/1
<input checked="" type="checkbox"/>	Horn antenna	HF 906	R&S	EC 3049	2016/9/24	2017/9/23
<input checked="" type="checkbox"/>	Horn antenna	HAP18-26W	TOYO	EC 4792-3	2016/6/12	2017/6/11
<input checked="" type="checkbox"/>	Pre-amplifier	Pre-amp 18	R&S	EC 5262	2016/6/30	2017/6/29
<input checked="" type="checkbox"/>	Pre-amplifier	Tpa0118-40	R&S	EC 4792-2	2017/4/10	2018/4/9
<input checked="" type="checkbox"/>	Shielded room	-	Zhongyu	EC 2838	2017/1/8	2018/1/7

2.6 Test Summary

This report applies to tested sample only. The test results have been compared directly with the limits, and the measurement uncertainty is recorded. This report shall not be reproduced in part without written approval of Intertek Testing Service Shanghai Limited.

TEST ITEM	FCC REFERANCE	IC REFERANCE	RESULT
Minimum 6dB Bandwidth & Occupied bandwidth	15.247(a)(2)	RSS-247 Issue 2 Clause 5.2	Pass
Maximum peak output power	15.247(b)	RSS-247 Issue 2 Clause 5.4	Pass
Power spectrum density	15.247(e)	RSS-247 Issue 2 Clause 5.2	Pass
Radiated emission	15.205 & 15.209	RSS-247 Issue 2 Clause 5.5	Pass
Emission outside the frequency band	15.247(d)	RSS-Gen Issue 4 Clause 8.9	Pass
Power line conducted emission	15.207	RSS-Gen Issue 4 Clause 8.8	Pass
Occupied bandwidth	-	RSS-Gen Issue 4 Clause 6.6	Tested

Notes: 1: NA =Not Applicable

2: This report is for the exclusive use of Intertek's Client and is provided pursuant to the agreement between Intertek and its Client. Intertek's responsibility and liability are limited to the terms and conditions of the agreement. Intertek assumes no liability to any party, other than to the Client in accordance with the agreement, for any loss, expense or damage occasioned by the use of this report. Only the Client is authorized to permit copying or distribution of this report and then only in its entirety. Any use of the Intertek name or one of its marks for the sale or advertisement of the tested material, product or service must first be approved in writing by Intertek. The observations and test results in this report are relevant only to the sample tested. This report by itself does not imply that the material, product, or service is or has ever been under an Intertek certification program.

2.7 Measurement uncertainty

The measurement uncertainty represents an expanded uncertainty expressed at approximately the 95% confidence level using a coverage factor of k=2.

Test item	Measurement uncertainty
Maximum peak output power	$\pm 0.74\text{dB}$
Radiated Emissions in restricted frequency bands below 1GHz	$\pm 4.90\text{dB}$
Radiated Emissions in restricted frequency bands above 1GHz	$\pm 5.02\text{dB}$
Emission outside the frequency band	$\pm 2.89\text{dB}$
Power line conducted emission	$\pm 3.19\text{dB}$

3 Minimum 6dB Bandwidth

Test result: Pass

3.1 Limit

For systems using digital modulation techniques that may operate in the 902 - 928 MHz, 2400 - 2483.5 MHz and 5725 - 5850 MHz bands, the minimum 6 dB bandwidth shall be at least 500 kHz.

3.2 Test Configuration

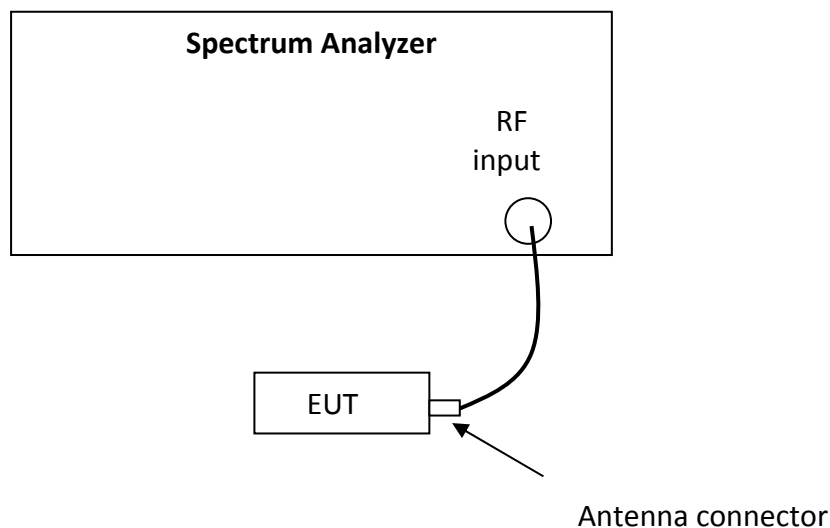

3.3 Test Procedure and test setup

The minimum 6dB bandwidth per FCC §15.247(a)(2) is measured using the Spectrum Analyzer according to DTS test procedure of "KDB558074 D01 DTS Meas Guidance" for compliance to FCC 47CFR 15.247 requirements (clause 8.2).

- a) Set RBW = 100 kHz.
- b) Set the video bandwidth (VBW) $\geq 3 \times$ RBW.
- c) Detector = Peak.
- d) Trace mode = max hold.
- e) Sweep = auto couple.
- f) Allow the trace to stabilize.
- g) Measure the maximum width of the emission that is constrained by the frequencies associated with the two outermost amplitude points (upper and lower frequencies) that are attenuated by 6 dB relative to the maximum level measured in the fundamental emission.

3.4 Test Protocol

Temperature: 25 °C

Relative Humidity: 55 %

Mode	Channel	Minimum 6dB Bandwidth (MHz)	Limits (MHz)
802.11b	L	8.115	> 0.5
	M	8.096	> 0.5
	H	8.107	> 0.5
802.11g	L	15.96	> 0.5
	M	16.08	> 0.5
	H	16.37	> 0.5
802.11n (HT20)	L	17.55	> 0.5
	M	17.61	> 0.5
	H	17.64	> 0.5
802.11n (HT40)	L	35.17	> 0.5
	M	35.19	> 0.5
	H	35.20	> 0.5

Mode	Channel	99% Occupy Bandwidth (MHz)	Limits (MHz)
802.11b	L	10.060	> 0.5
	M	10.048	> 0.5
	H	10.056	> 0.5
802.11g	L	16.511	> 0.5
	M	16.509	> 0.5
	H	16.533	> 0.5
802.11n (HT20)	L	17.643	> 0.5
	M	17.696	> 0.5
	H	17.677	> 0.5
802.11n (HT40)	L	36.039	> 0.5
	M	36.054	> 0.5
	H	35.995	> 0.5

Test Plots:

802.11b-2412MHz

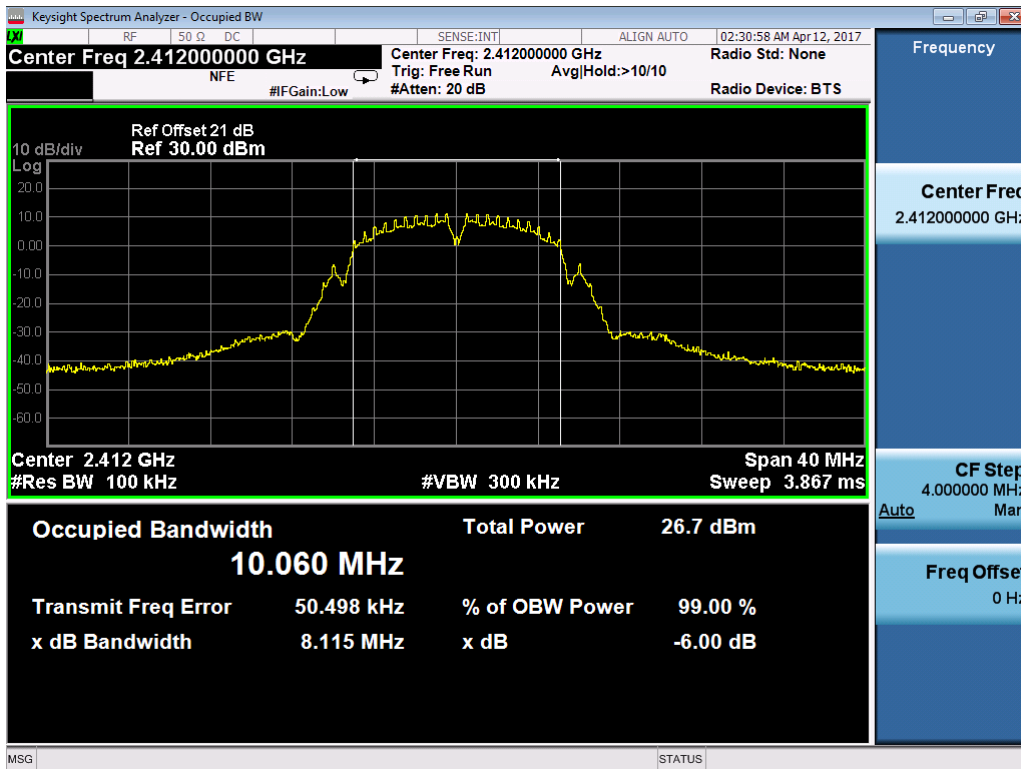

802.11b-2437MHz

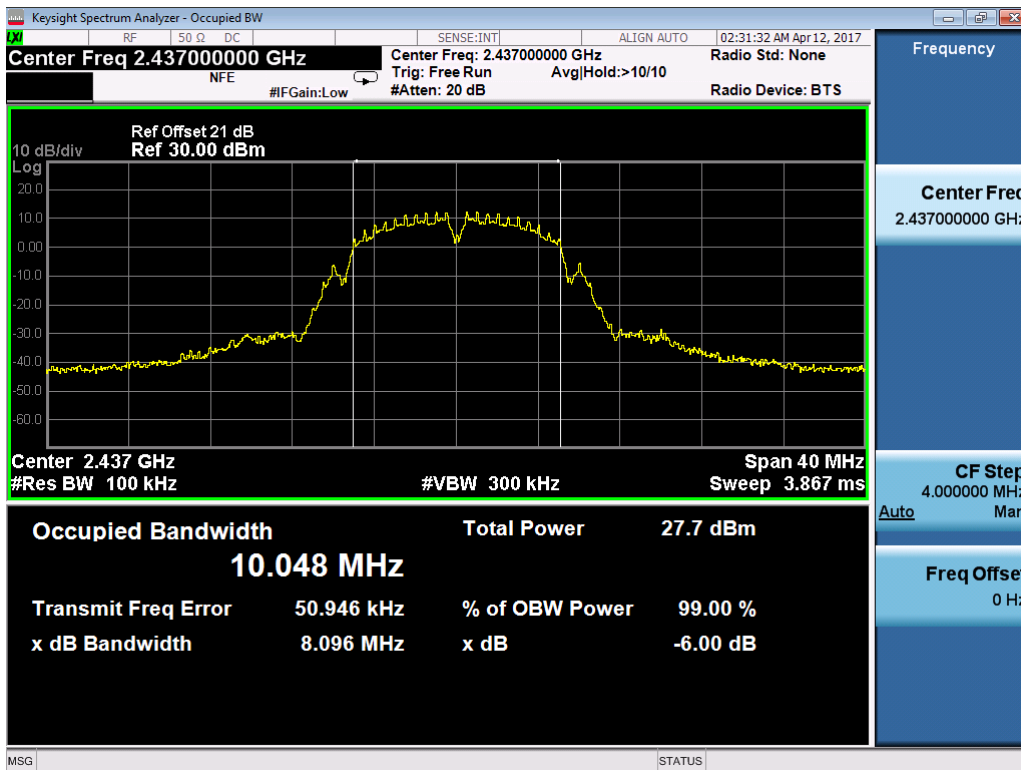

802.11b-2462MHz

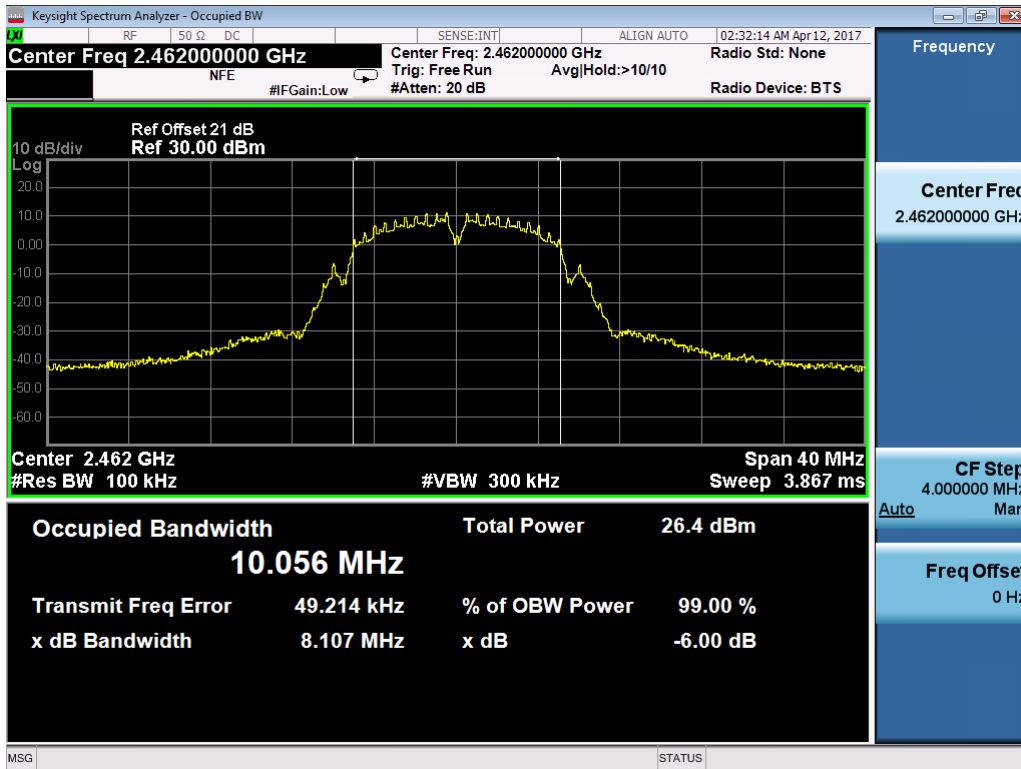

802.11g-2412MHz

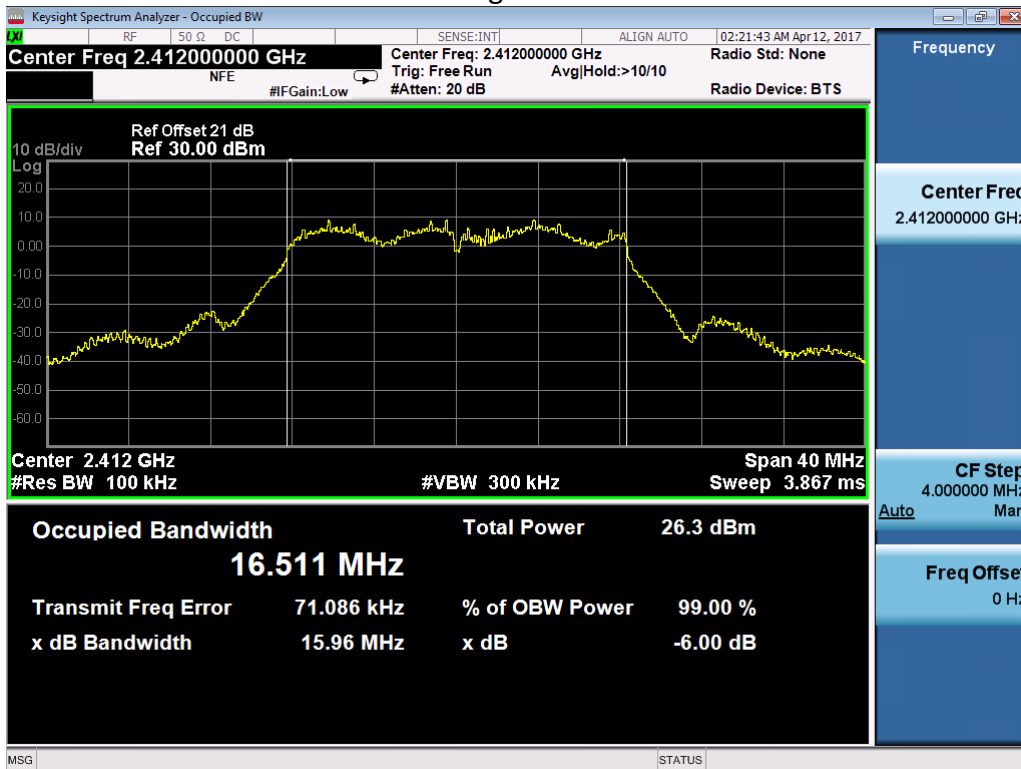

802.11g-2437MHz

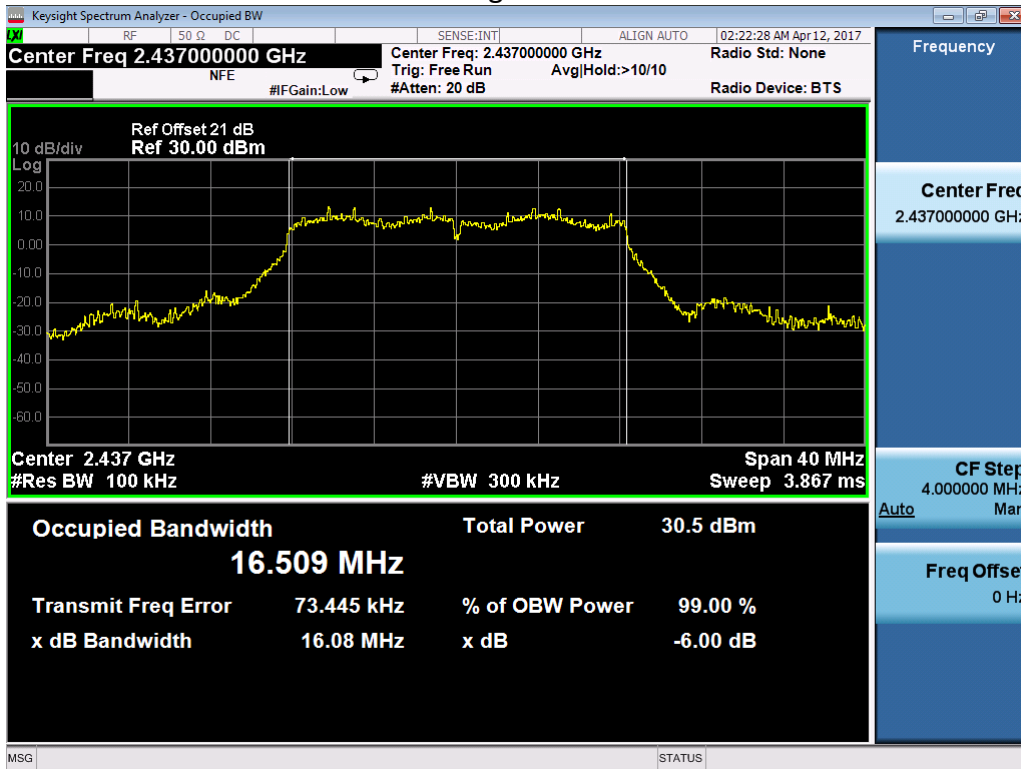

802.11g-2462MHz

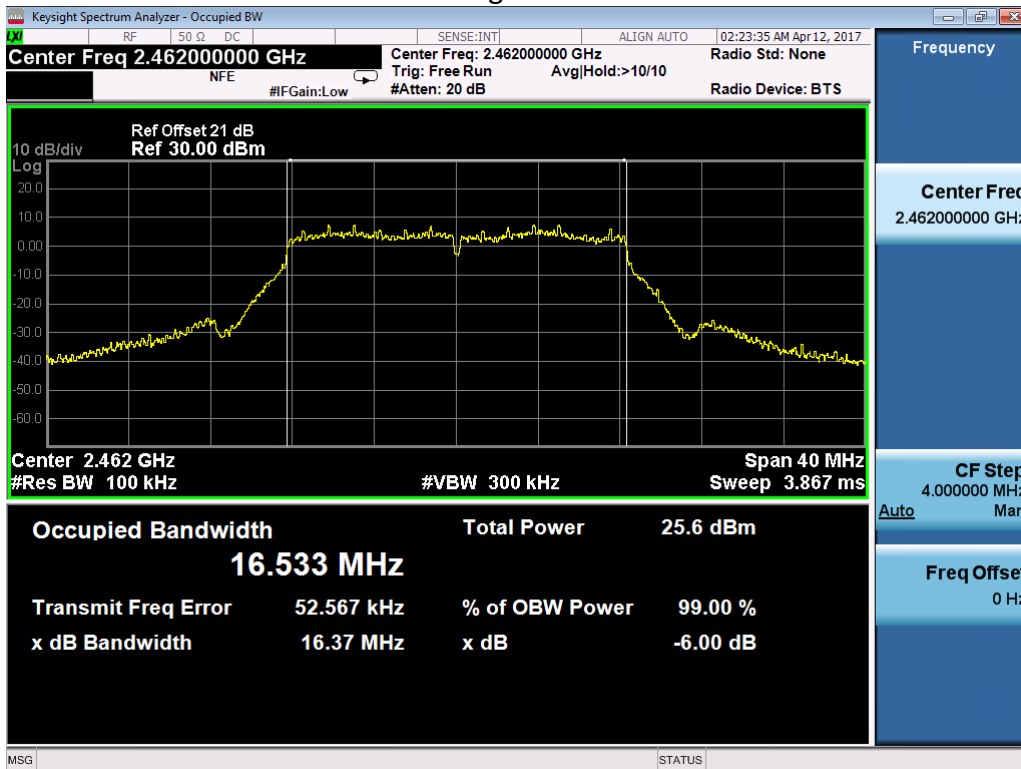

802.11n20-2412MHz

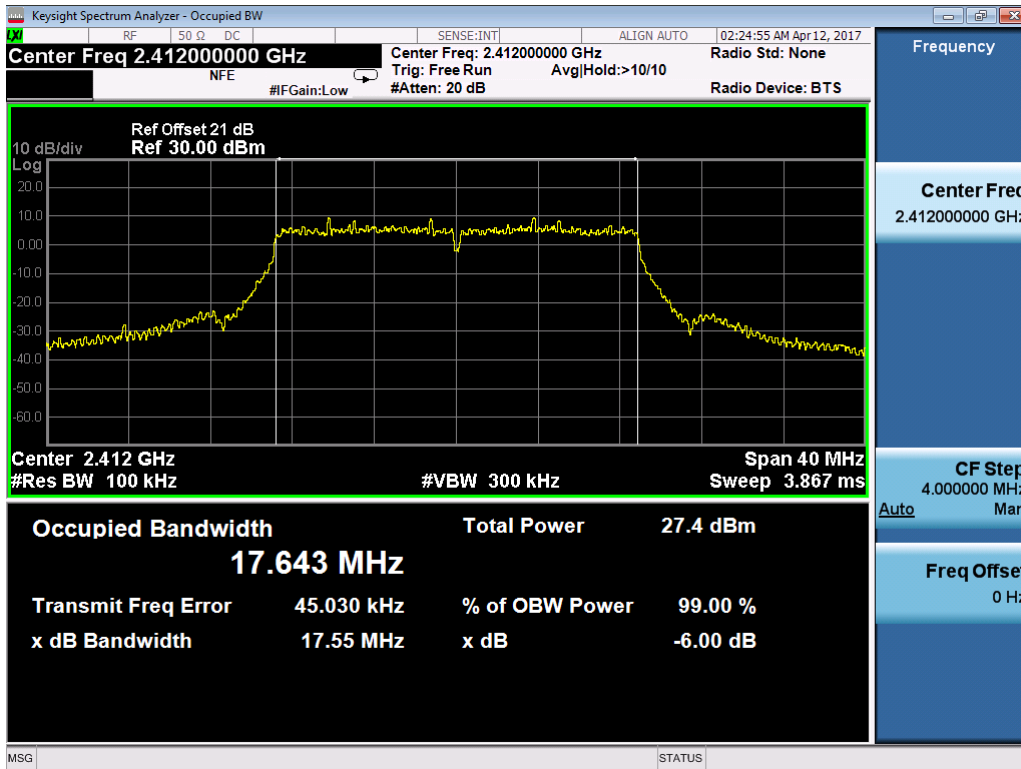

802.11n20-2437MHz

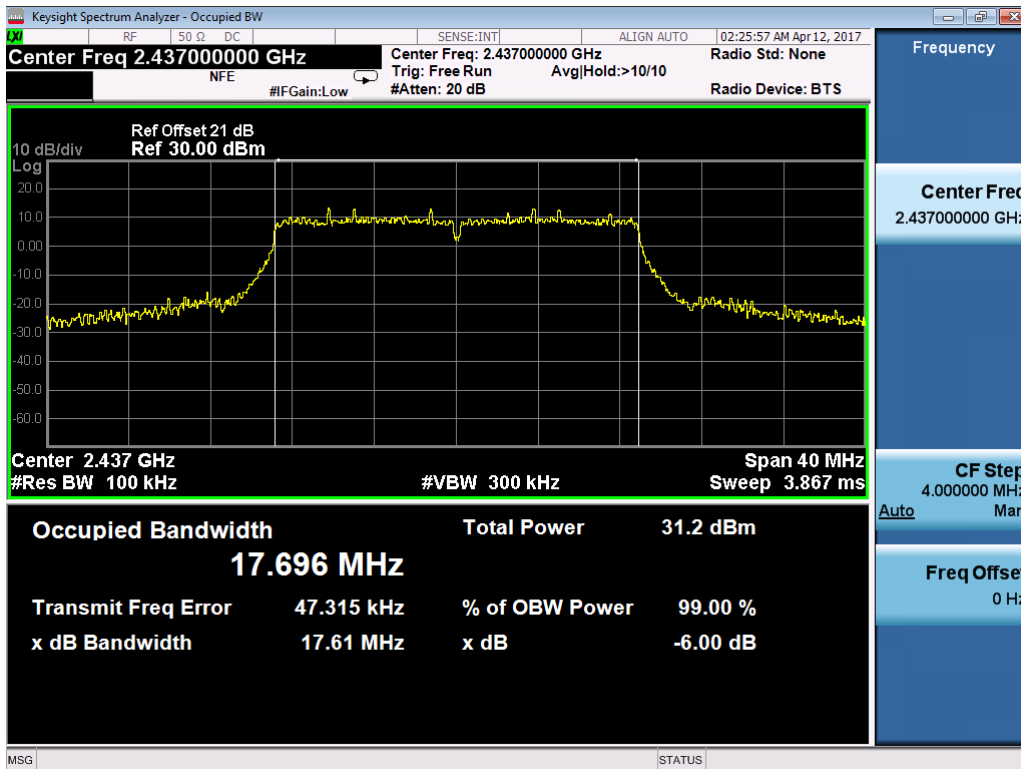

802.11n20-2462MHz

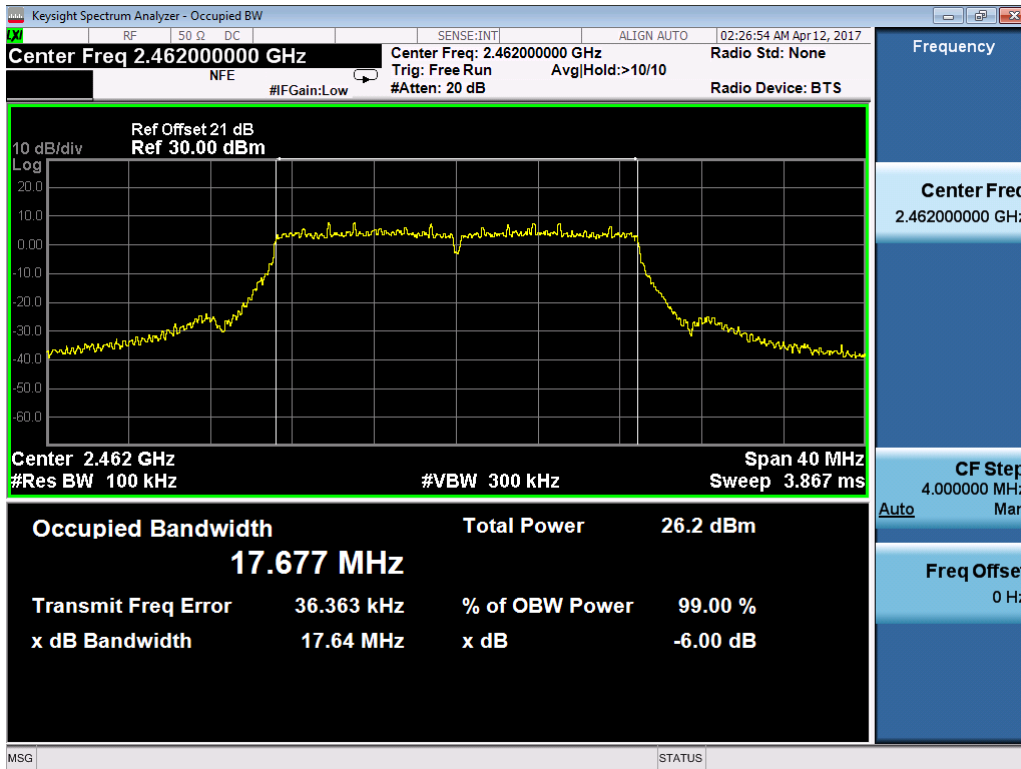

802.11n40-2422MHz

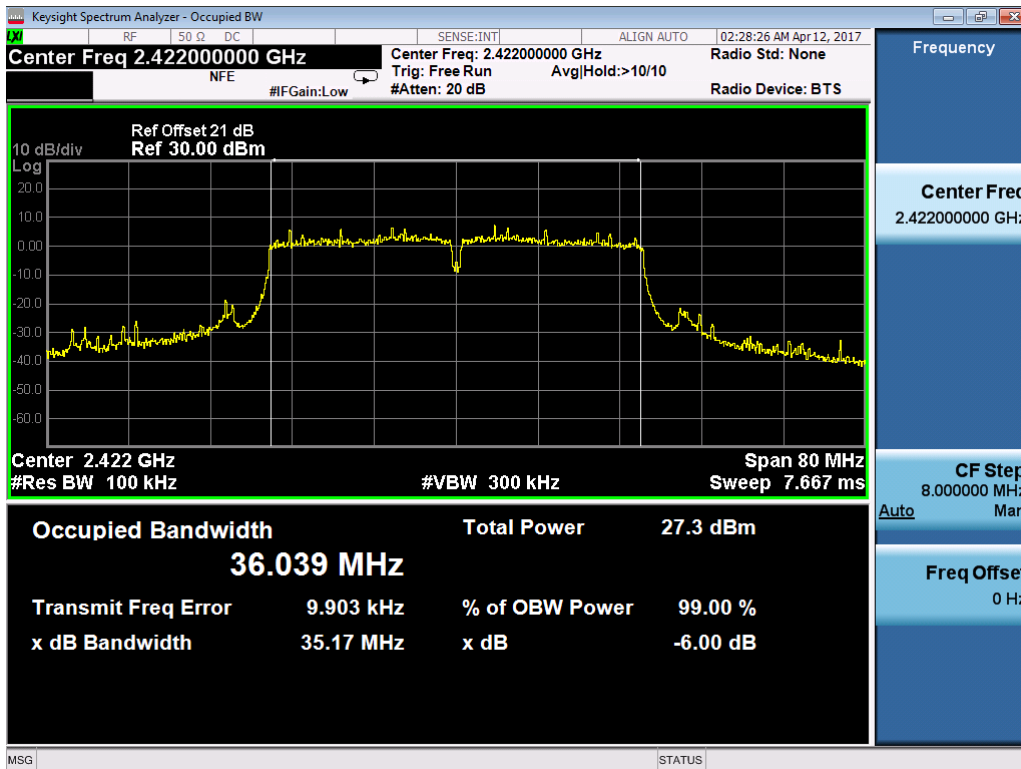

802.11n40-2437MHz

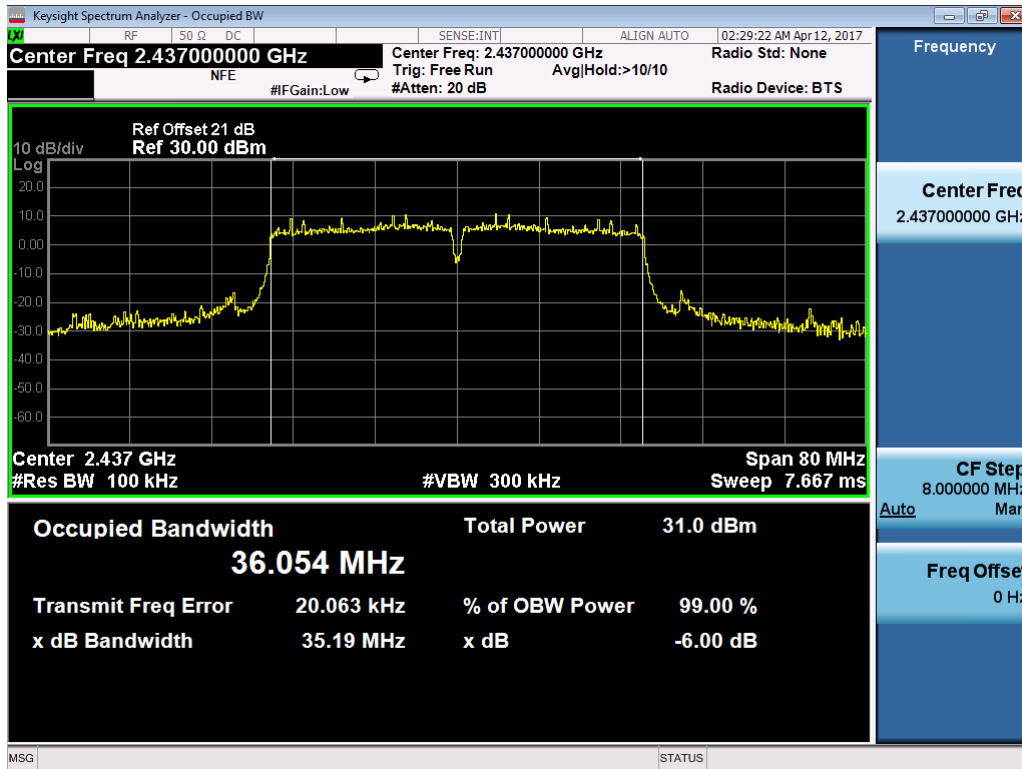

802.11n40-2452MHz

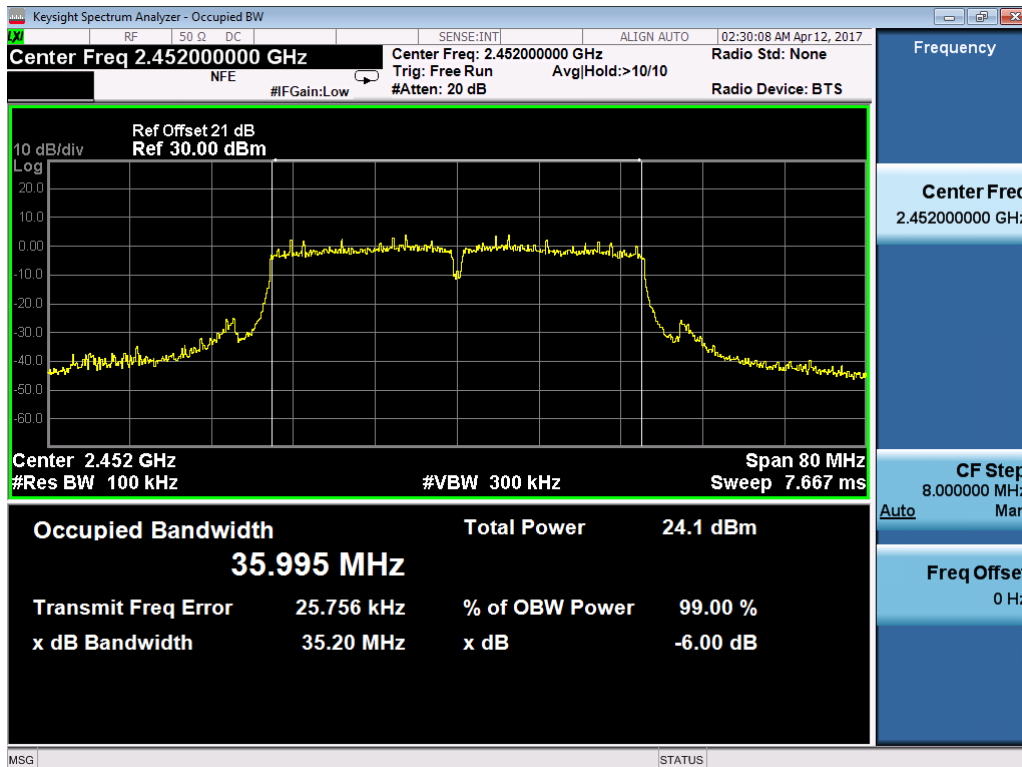

4 Maximum Conducted Output power

Test result: Pass

4.1 Test limit

- For frequency hopping systems operating in the 2400-2483.5 MHz band employing at least 75 non-overlapping hopping channels, and all frequency hopping systems in the 5725-5850 MHz band: 1 watt
- For all other frequency hopping systems in the 2400-2483.5 MHz band: 0.125 watts
- For systems using digital modulation in the 902-928 MHz, 2400-2483.5 MHz, and 5725-5850 MHz bands: 1 Watt and the e.i.r.p. shall not exceed 4 W.

If the transmitting antenna of directional gain greater than 6dBi is used, the power shall be reduced by the amount in dB that the directional gain of the antenna exceeds 6dBi. If there have a beam forming type, the limit should be the minimum of 30dBm and 30+ (6 –antenna gain-beam forming gain).

4.2 Test Configuration

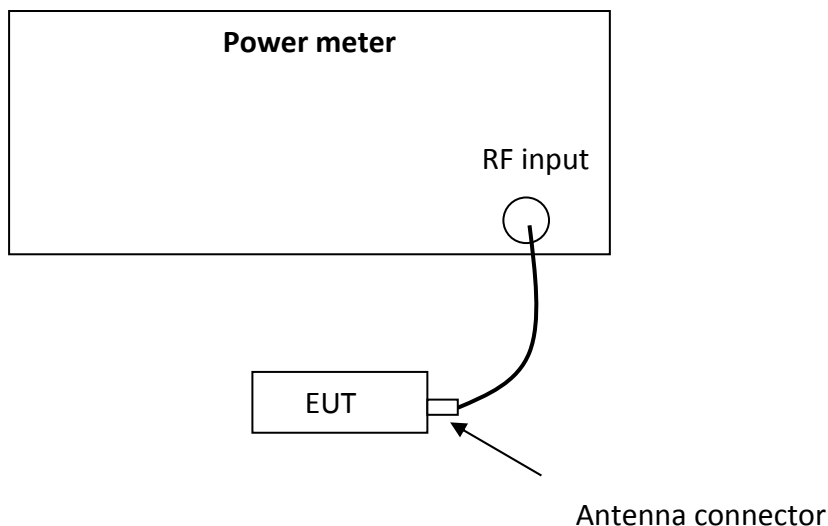

4.3 Test procedure and test setup

The EUT was tested according to DTS test procedure of "KDB558074 D01 DTS Meas Guidance" for compliance to FCC 47CFR 15.247 requirements (clause 9.2.3 PM Method.).

4.4 Test protocol

Temperature: 25 °C

Relative Humidity: 55 %

Mode	Channel	Corrected Reading (dBm)		Limit (dBm)	Result
		Ant 0	Ant 1		
802.11b	L	19.72	19.32	30.00	Pass
	M	20.82	20.17	30.00	Pass
	H	19.53	19.13	30.00	Pass
802.11g	L	22.76	20.95	30.00	Pass
	M	24.43	23.68	30.00	Pass
	H	22.03	18.79	30.00	Pass

Mode	Channel	Corrected Reading (dBm)		Total Power (dBm)	Limit (dBm)	Margin (dBm)
		Ant 0	Ant 1			
802.11n (HT20)	L	19.86	19.83	22.86	30.00	Pass
	M	23.88	23.02	26.48	30.00	Pass
	H	19.28	19.44	22.37	30.00	Pass
802.11n (HT40)	L	19.41	19.84	22.64	30.00	Pass
	M	23.53	23.96	26.76	30.00	Pass
	H	16.75	18.22	20.56	30.00	Pass

Conclusion: The maximum EIRP = 26.76dBm+3dBm = 29.76dBm = 0.946W which is lower than the limit of 4W listed in RSS-247.

5 Power spectrum density

Test result: Pass

5.1 Test limit

For digitally modulated systems, the power spectral density conducted from the intentional radiator to the antenna shall not be greater than 8dBm in any 3kHz band during any time interval of continuous transmission.

If the transmitting antenna of directional gain greater than 6dBi is used, the power shall be reduced by the amount in dB that the directional gain of the antenna exceeds 6dBi. If there have a beam forming type, the limit should be the minimum of 8dBm/3kHz and $8 + (6 - \text{antenna gain} - \text{beam forming gain})$.

5.2 Test Configuration

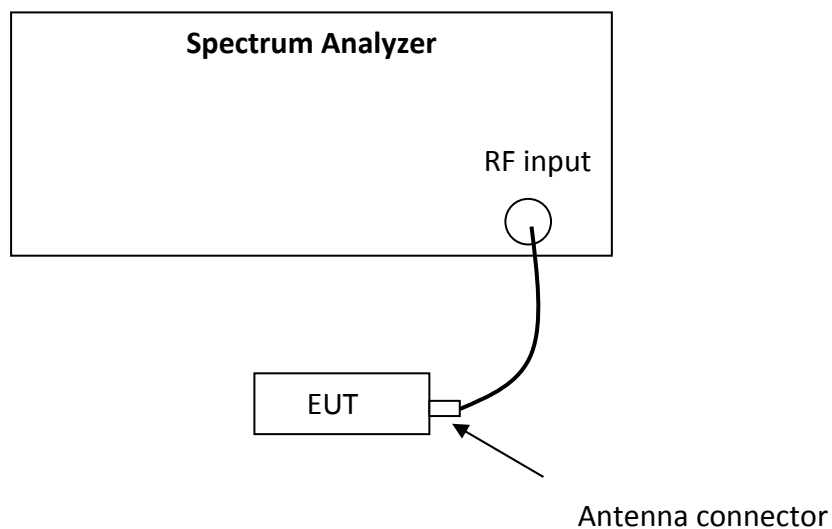

5.3 Test procedure and test setup

The power output per FCC §15.247(e) was tested according to DTS test procedure of “KDB558074 D01 DTS Meas Guidance” (clause 10.2) for compliance to FCC 47CFR 15.247 requirements.

- a) Set analyzer center frequency to DTS channel center frequency.
- b) Set the span to 1.5 times the *DTS bandwidth*.
- c) Set the RBW to: $3 \text{ kHz} \leq \text{RBW} \leq 100 \text{ kHz}$.
- d) Set the VBW $\geq 3 \times \text{RBW}$.
- e) Detector = peak.
- f) Sweep time = auto couple.
- g) Trace mode = max hold.
- h) Allow trace to fully stabilize.
- i) Use the peak marker function to determine the maximum amplitude level within the RBW.
- j) If measured value exceeds limit, reduce RBW (no less than 3 kHz) and repeat.

5.4 Test Protocol

Temperature: 25 °C

Relative Humidity: 55 %

Mode	Channel	Corrected Reading (dBm/10kHz)		Limit (dBm /3kHz)	Result
		Port 0	Port 1		
802.11b	L	-6.732	-	8	Pass
	M	-5.733	-	8	Pass
	H	-6.871	-	8	Pass
802.11g	L	-6.363	-	8	Pass
	M	-4.223	-	8	Pass
	H	-7.033	-	8	Pass

Mode	Channel	Corrected Reading (dBm/10kHz)		Total PSD (dBm /10kHz)	Limit (dBm /3kHz)	Result
		Port 0	Port 1			
802.11n (HT20)	L	-9.133	-9.027	-6.07	8	Pass
	M	-5.601	-6.011	-2.79	8	Pass
	H	-12.569	-9.644	-7.85	8	Pass
802.11n (HT40)	L	-11.561	-9.974	-7.69	8	Pass
	M	-7.830	-6.443	-4.07	8	Pass
	H	-13.079	-12.795	-9.92	8	Pass

Test Plots:

802.11b-2412MHz

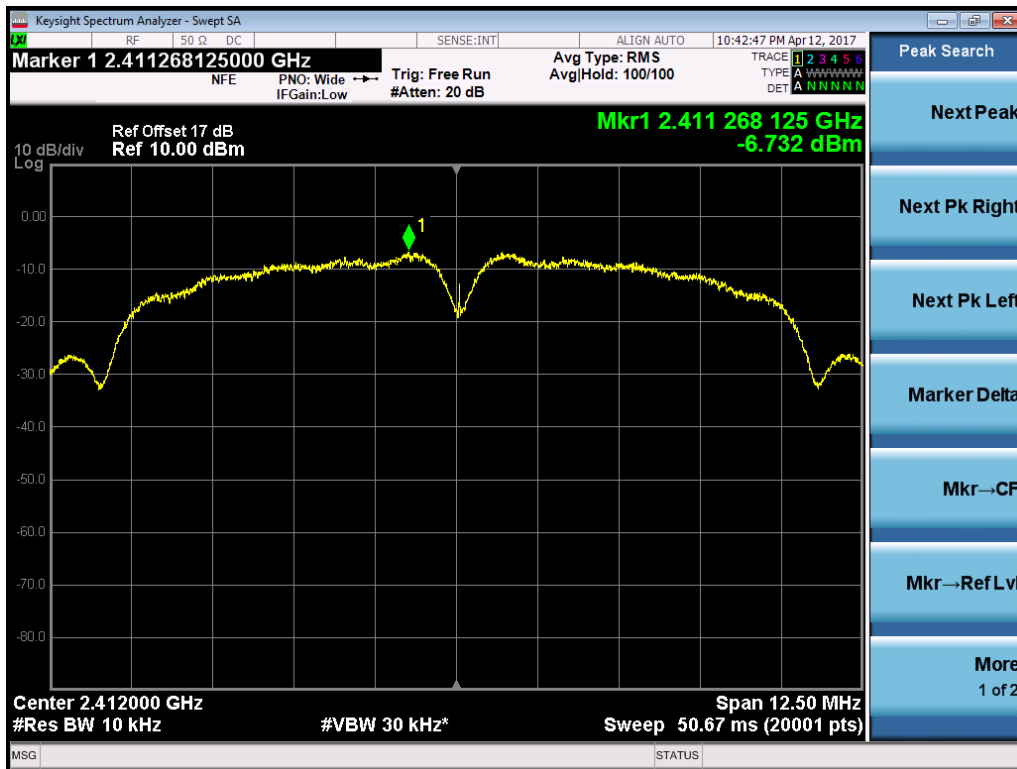

802.11b-2437MHz



802.11b-2462MHz



802.11g-2412MHz

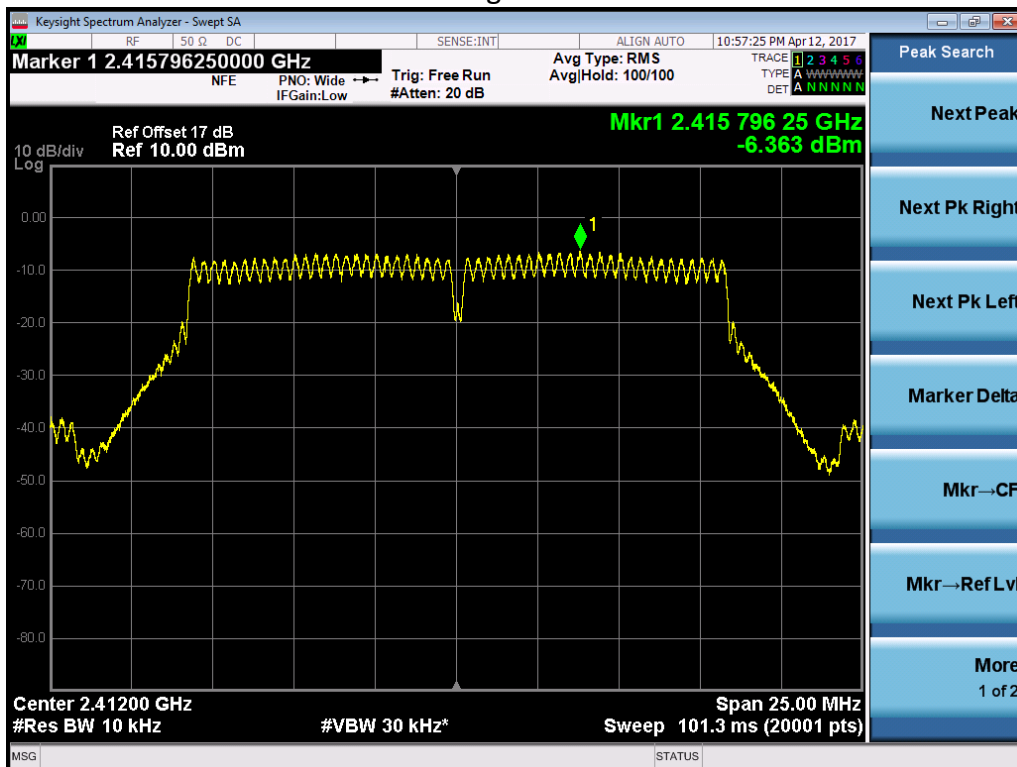

802.11g-2437MHz

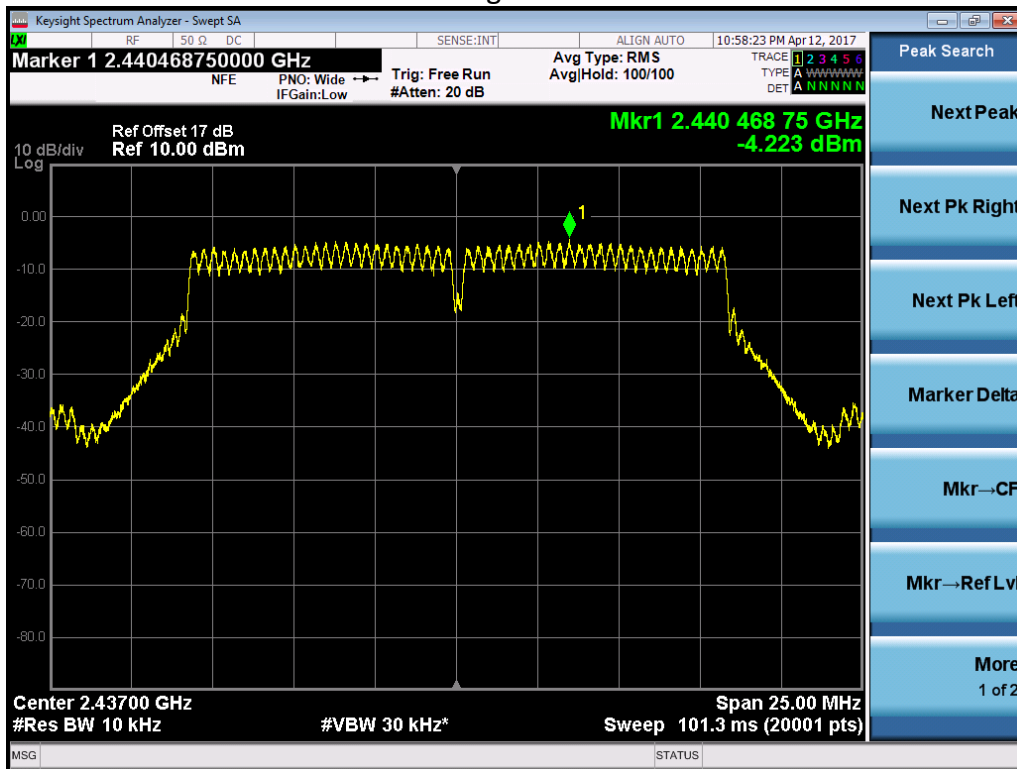

802.11g-2462MHz

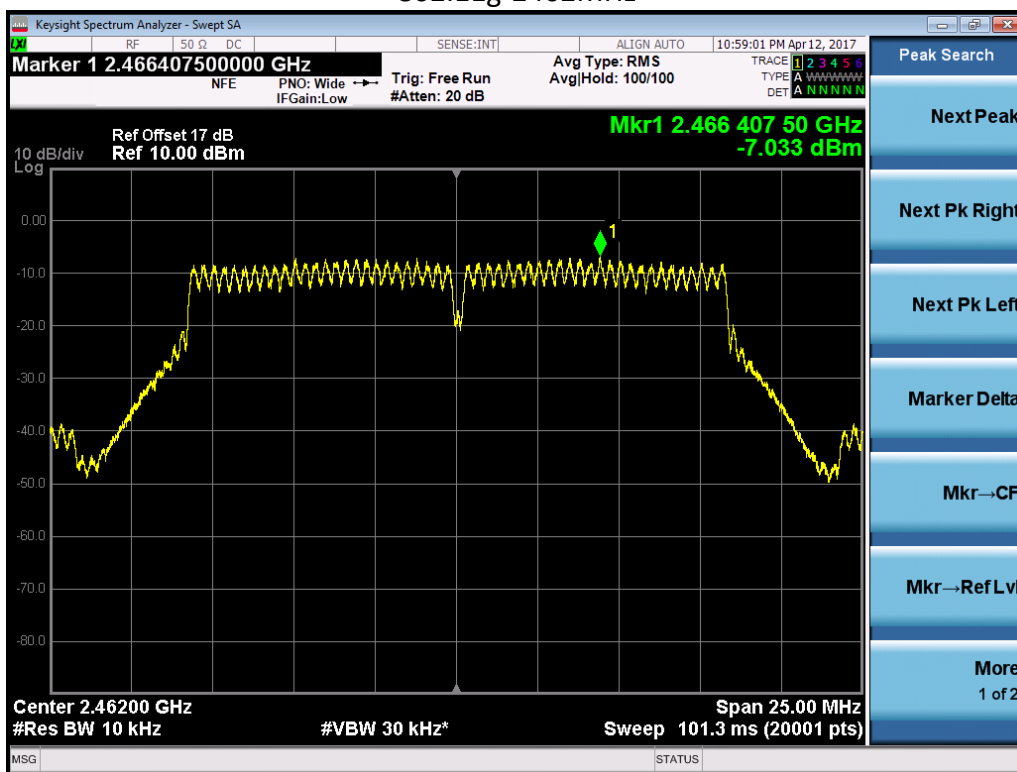

Ant 0
802.11n20-2412MHz

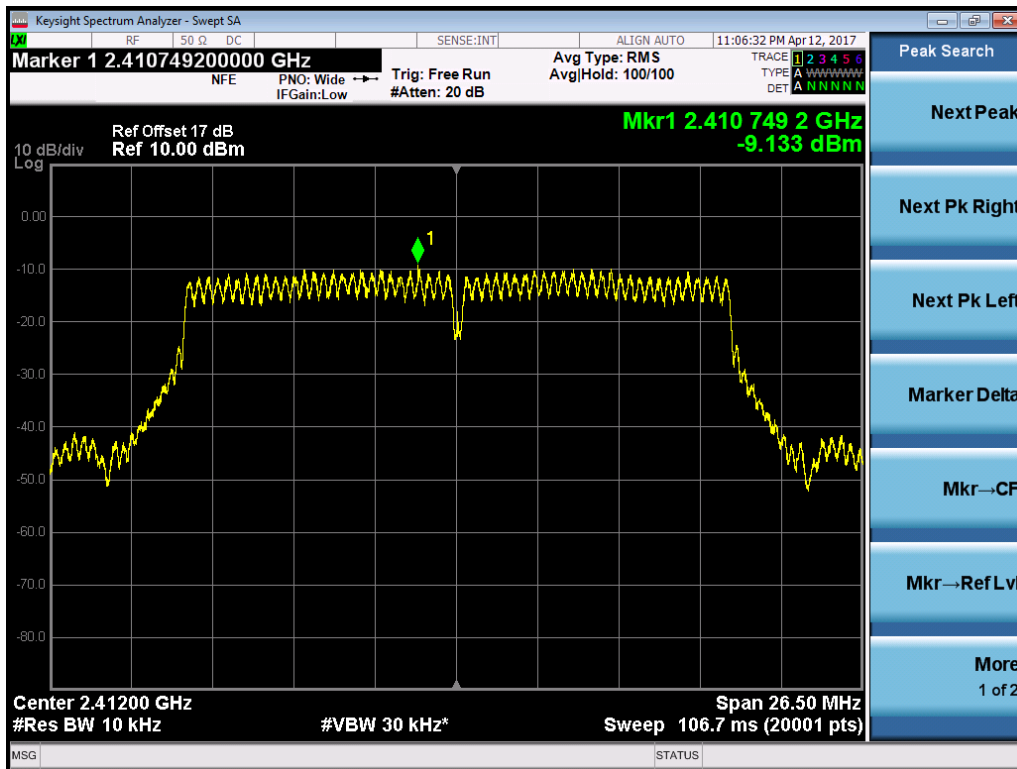

802.11n20-2437MHz

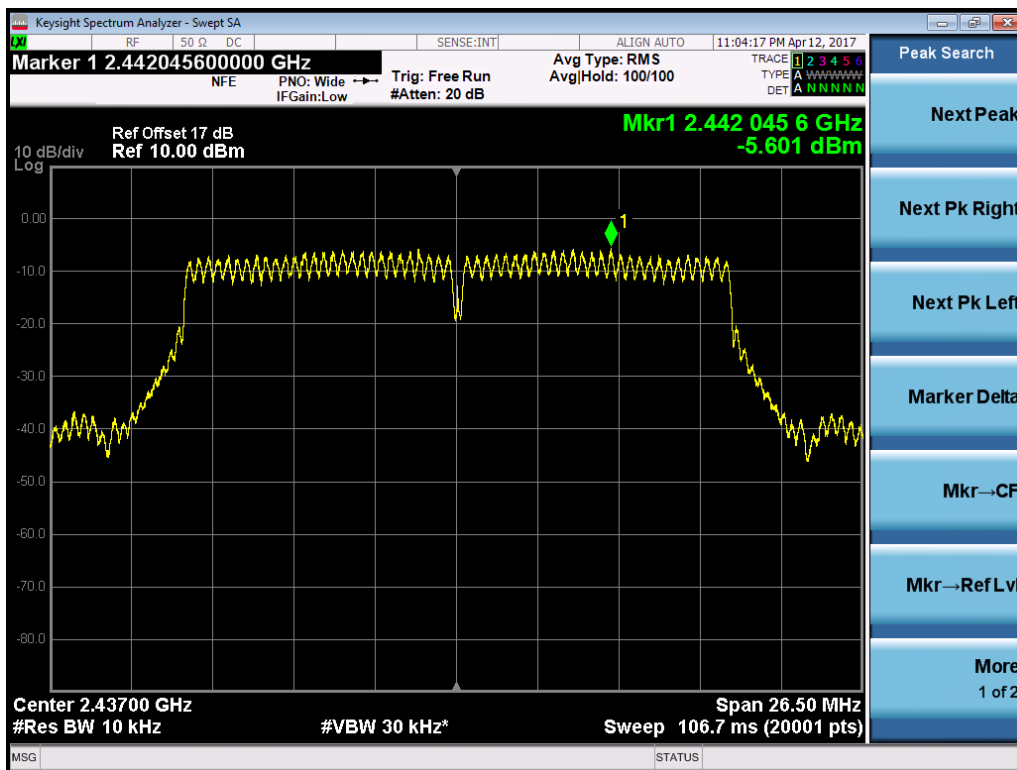

802.11n20-2462MHz

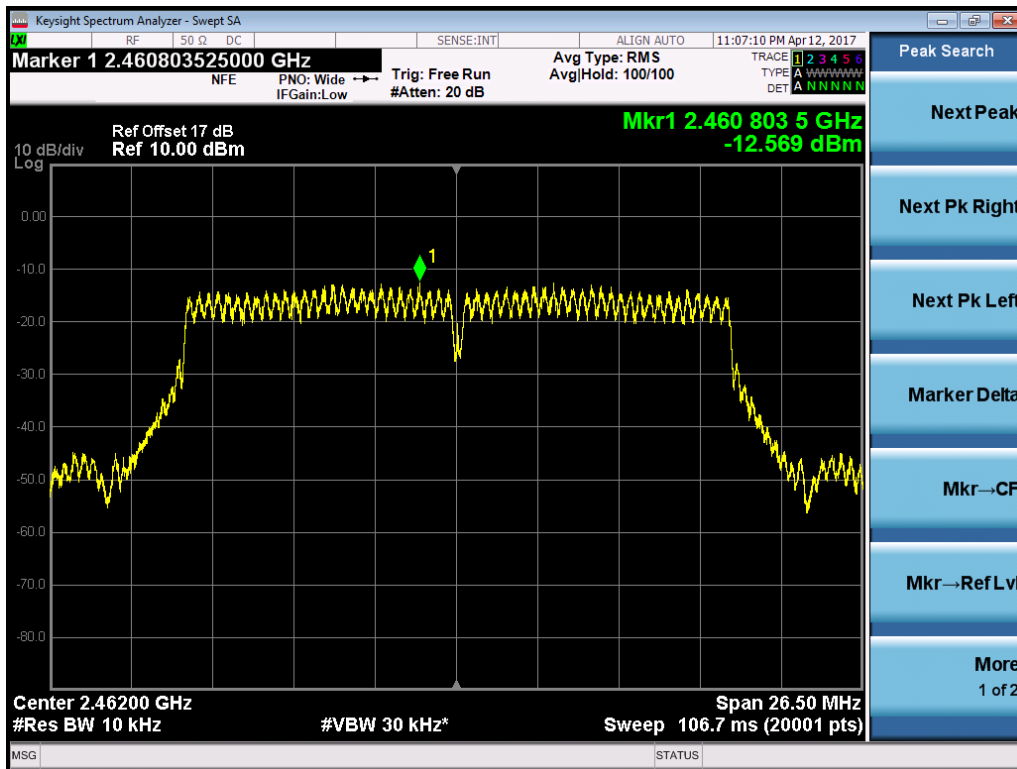

802.11n40-2422MHz

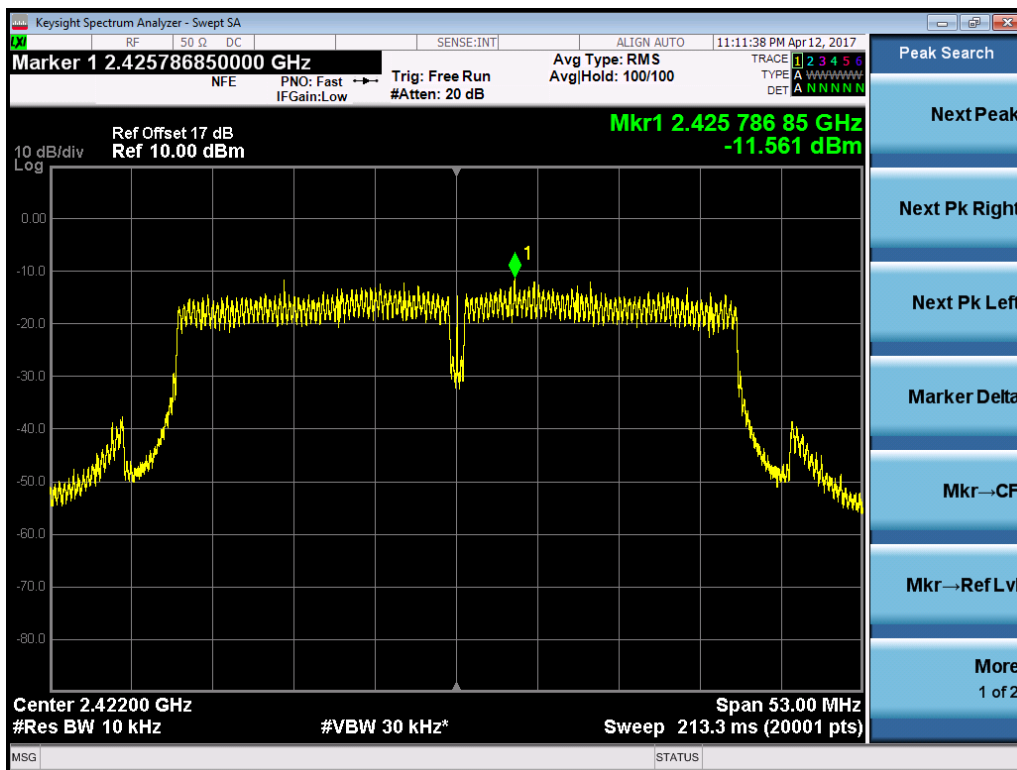

802.11n40-2437MHz

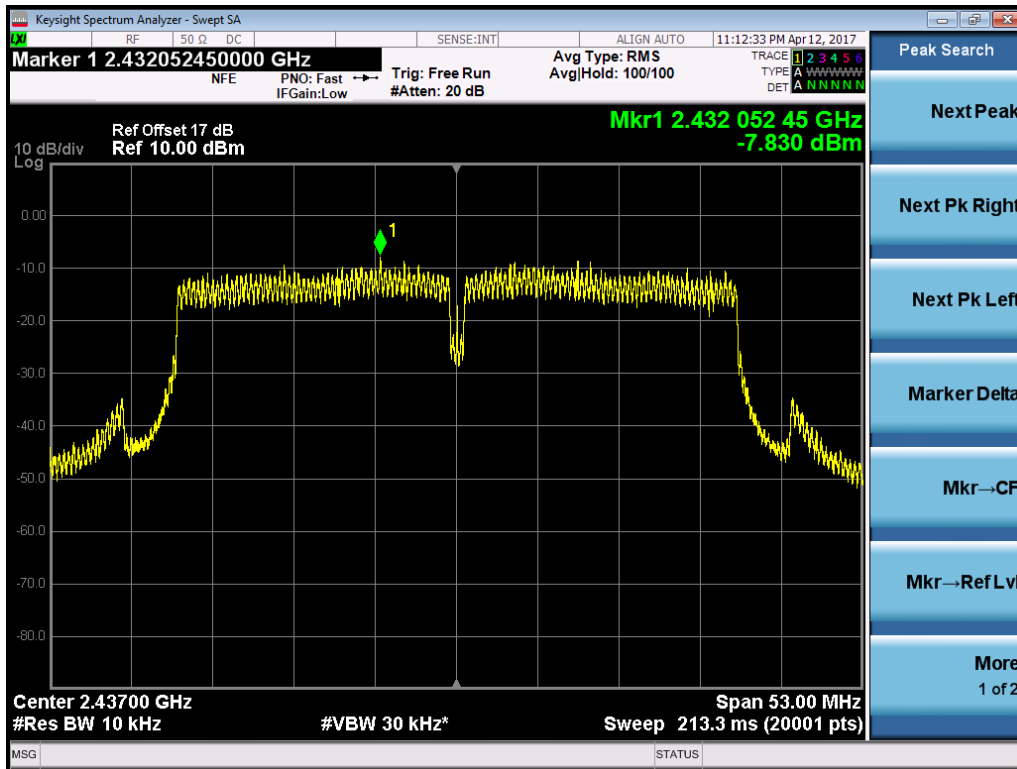

802.11n40-2452MHz

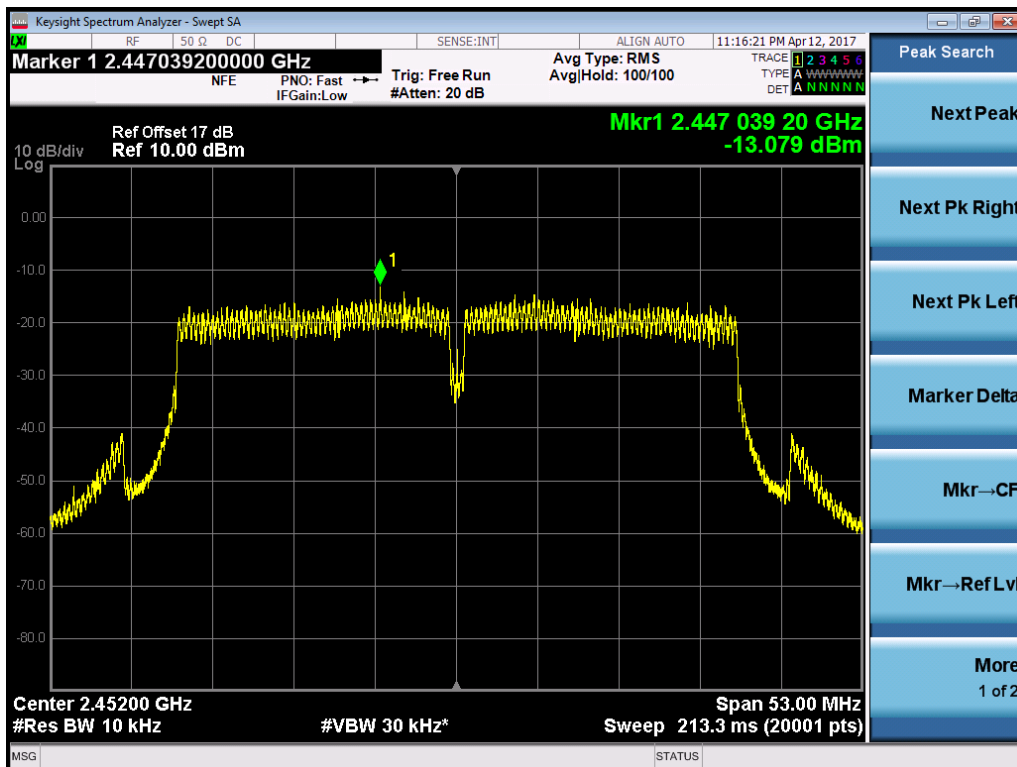

Ant 1
802.11n20-2412MHz

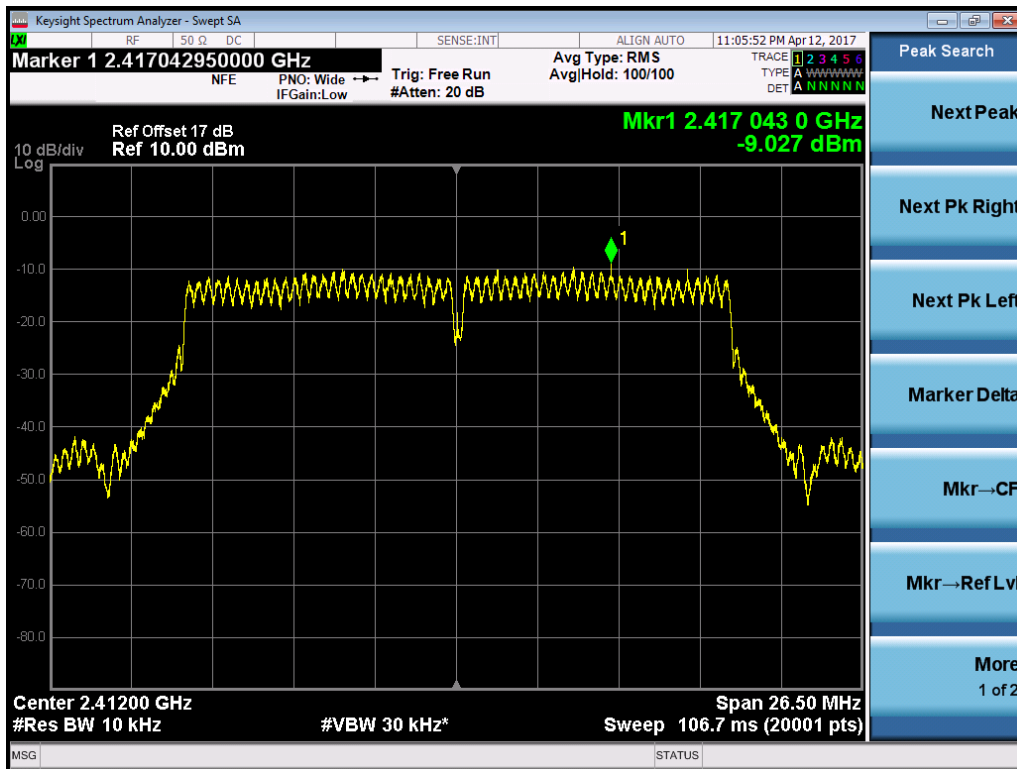

802.11n20-2437MHz

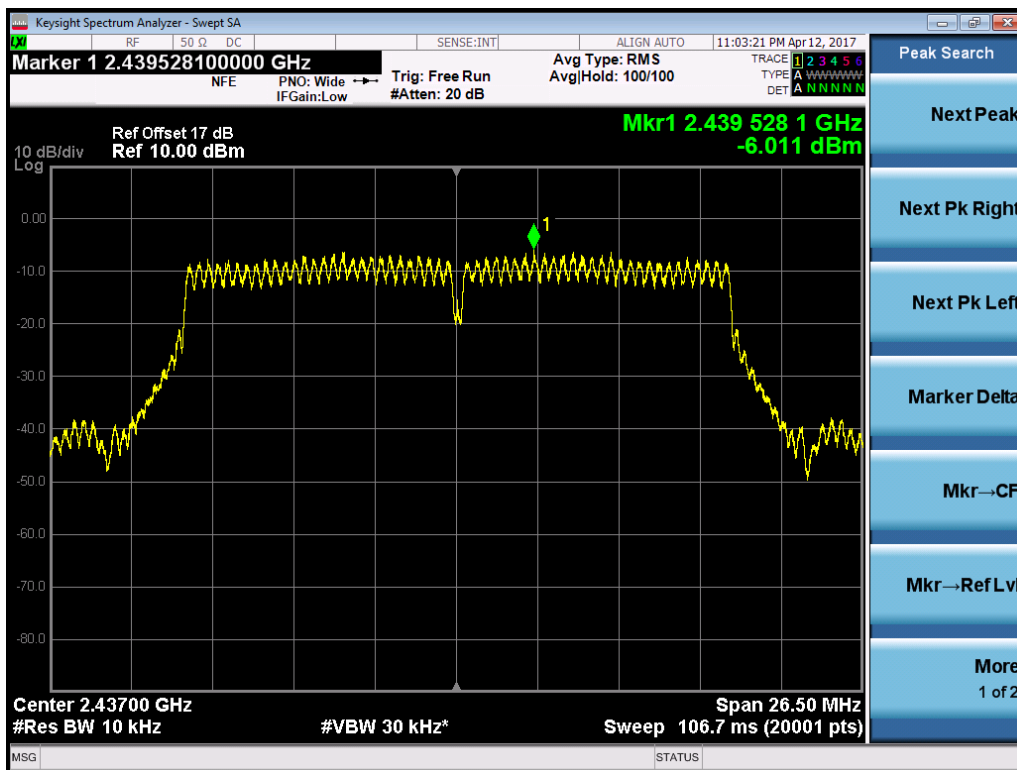

802.11n20-2462MHz

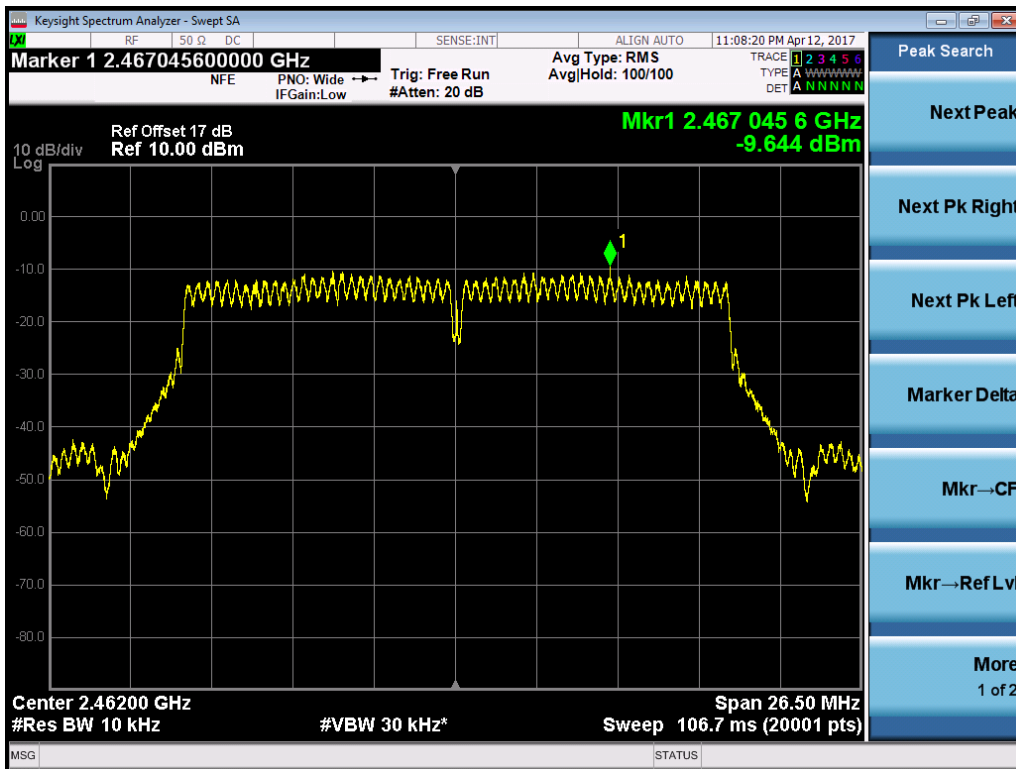

802.11n40-2422MHz

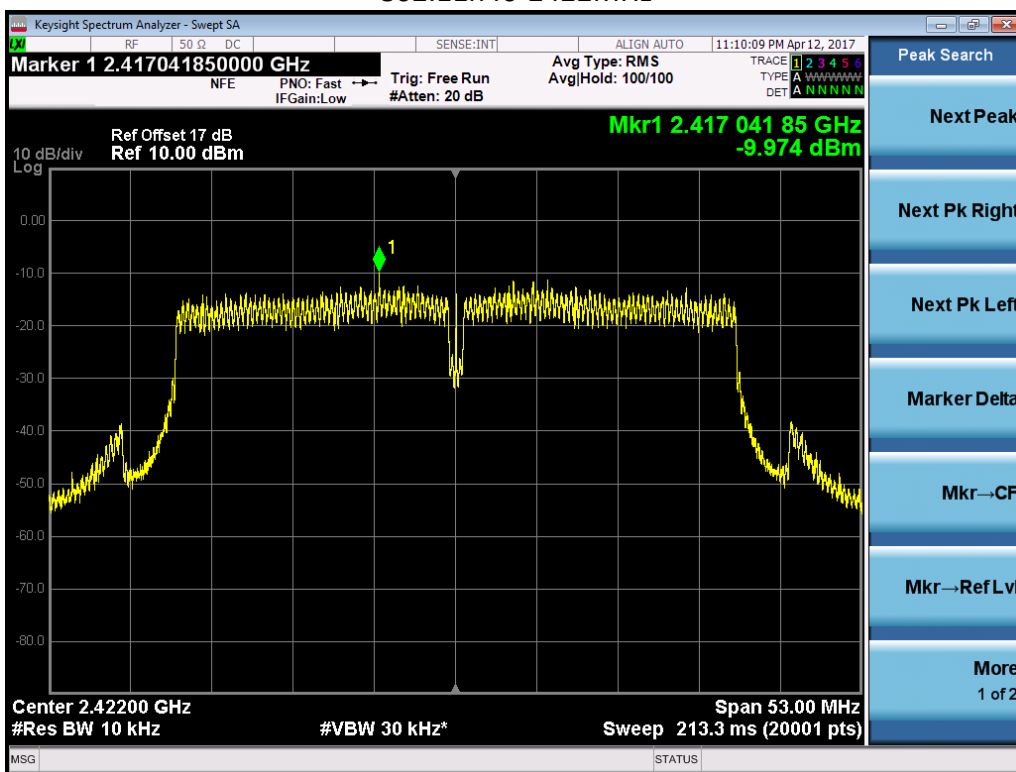

802.11n40-2437MHz

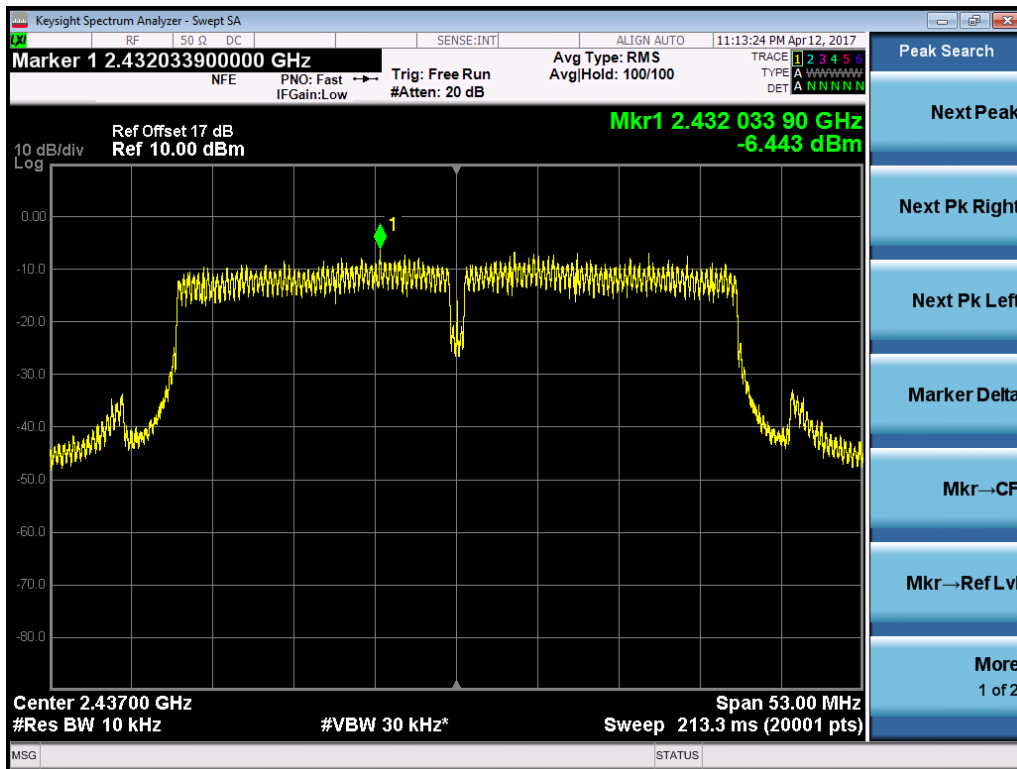

802.11n40-2452MHz

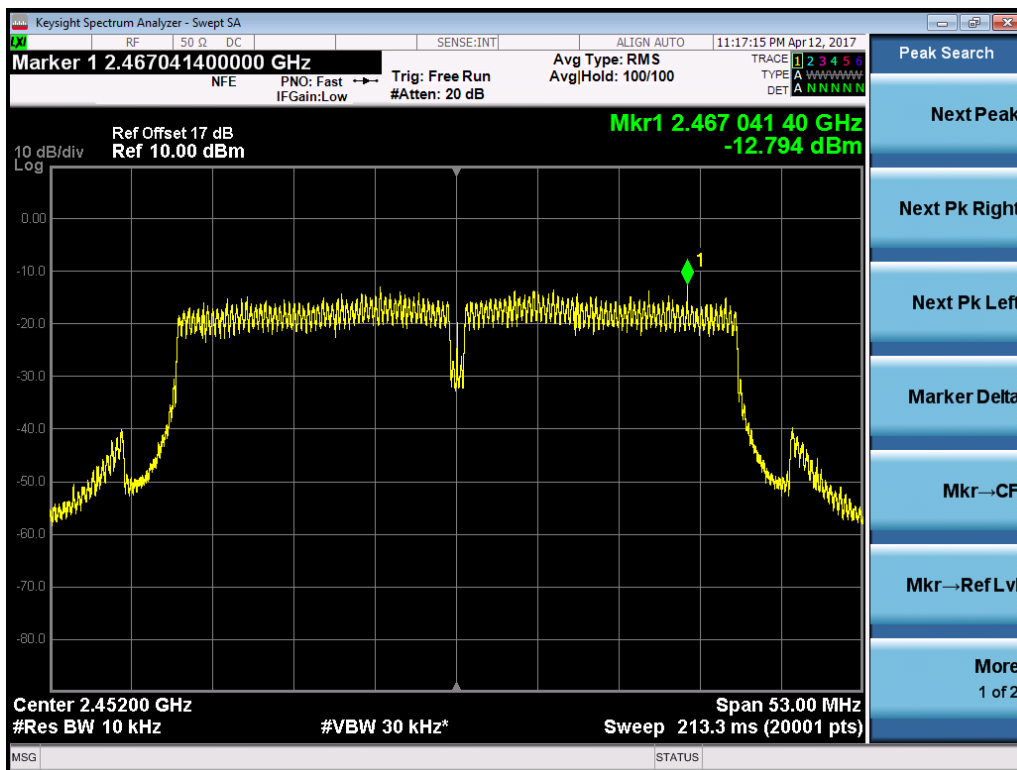

6 Emission outside the frequency band

Test result: Pass

6.1 Test limit

In any 100 kHz bandwidth outside the frequency band in which the spread spectrum intentional radiator is operating, the radio frequency power that is produced by the intentional radiator shall be at least 30 dB below that in the 100 kHz bandwidth within the band that contains the highest level of the desired power.

6.2 Test Configuration

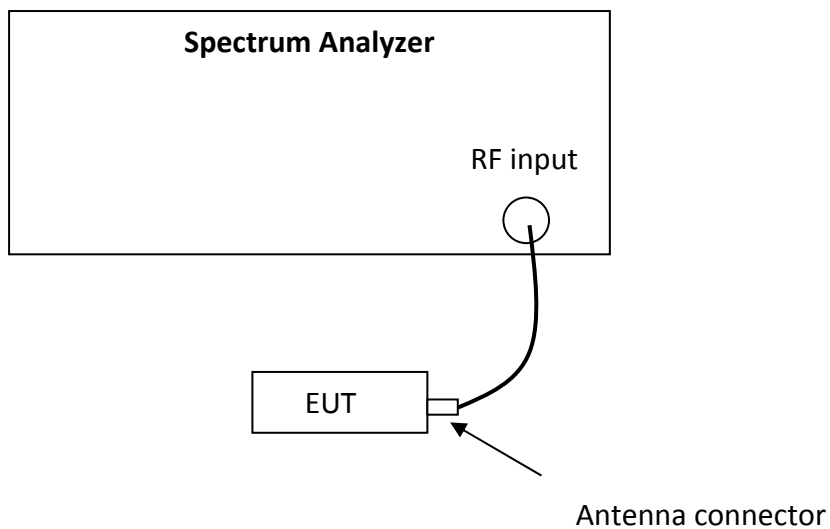

6.3 Test procedure and test setup

The EUT was tested according to DTS test procedure of “KDB558074 D01 DTS Meas Guidance” (clause 11.0) for compliance to FCC 47CFR 15.247 requirements.

Reference level measurement

Establish a reference level by using the following procedure:

- a) Set instrument center frequency to DTS channel center frequency.
- b) Set the span to ≥ 1.5 times the *DTS bandwidth*.
- c) Set the RBW = 100 kHz.
- d) Set the VBW $\geq 3 \times$ RBW.
- e) Detector = peak.
- f) Sweep time = auto couple.
- g) Trace mode = max hold.
- h) Allow trace to fully stabilize.
- i) Use the peak marker function to determine the maximum PSD level.

Note that the channel found to contain the maximum PSD level can be used to establish the reference level.

Emission level measurement

- a) Set the center frequency and span to encompass frequency range to be measured.
- b) Set the RBW = 100 kHz.
- c) Set the VBW $\geq 3 \times$ RBW.
- d) Detector = peak.
- e) Sweep time = auto couple.
- f) Trace mode = max hold.
- g) Allow trace to fully stabilize.
- h) Use the peak marker function to determine the maximum amplitude level.

Ensure that the amplitude of all unwanted emissions outside of the authorized frequency band (excluding restricted frequency bands) are attenuated by at least the minimum requirements specified in 11.1 a) or 11.1 b). Report the three highest emissions relative to the limit.

6.4 Test Protocol

Temperature: 25 °C

Relative Humidity: 55 %

Mode	Channel	Results	Limits (dB)
802.11b	L	Pass	≥20
	M	Pass	≥20
	H	Pass	≥20
802.11g	L	Pass	≥20
	M	Pass	≥20
	H	Pass	≥20

Mode	Channel	Results		Limits (dB)
		Port 0	Port 1	
802.11n (HT20)	L	Pass	Pass	≥20
	M	Pass	Pass	≥20
	H	Pass	Pass	≥20
802.11n (HT40)	L	Pass	Pass	≥20
	M	Pass	Pass	≥20
	H	Pass	Pass	≥20

Test Plots of Reference level:

802.11b

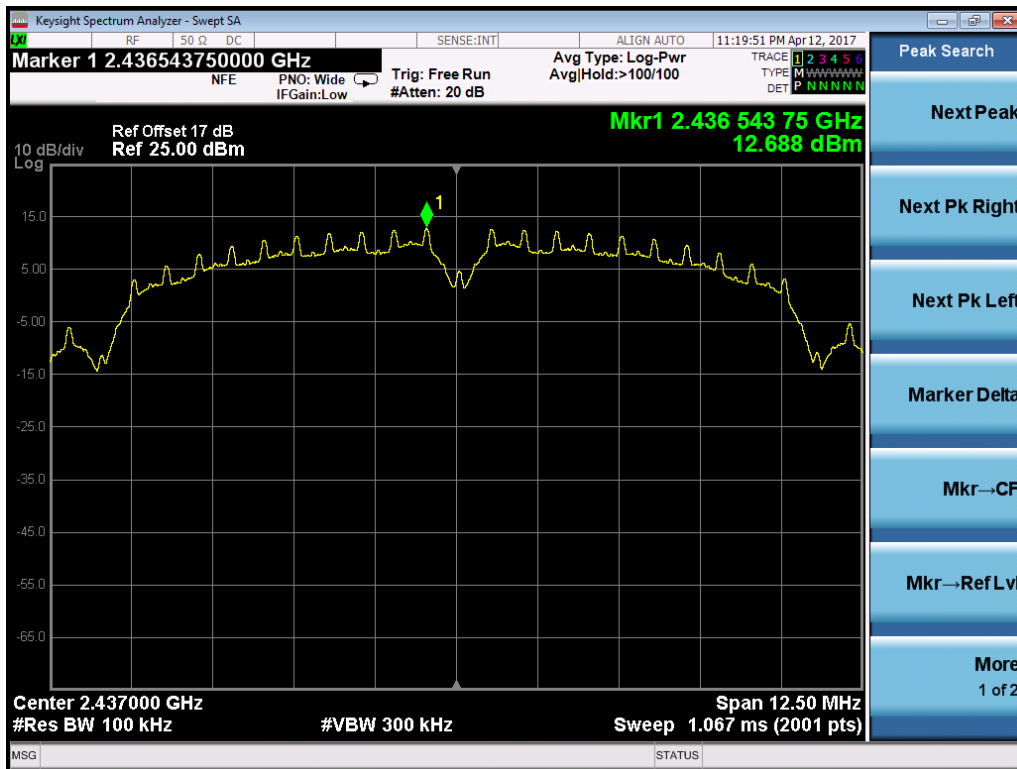

802.11g

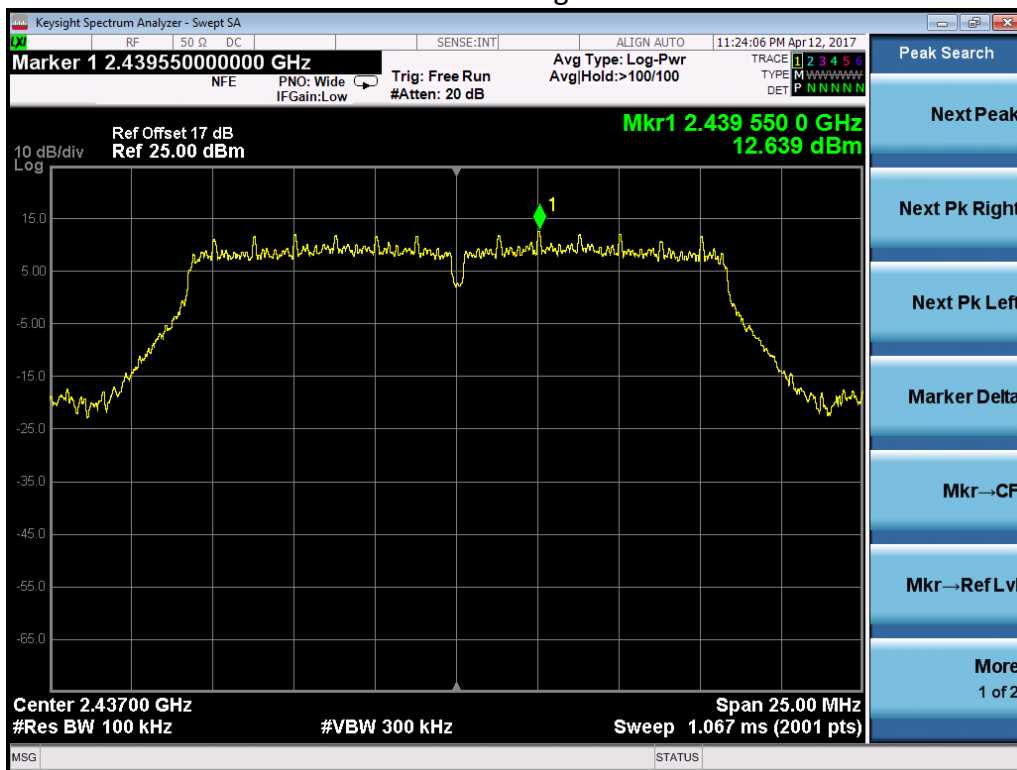

802.11n20

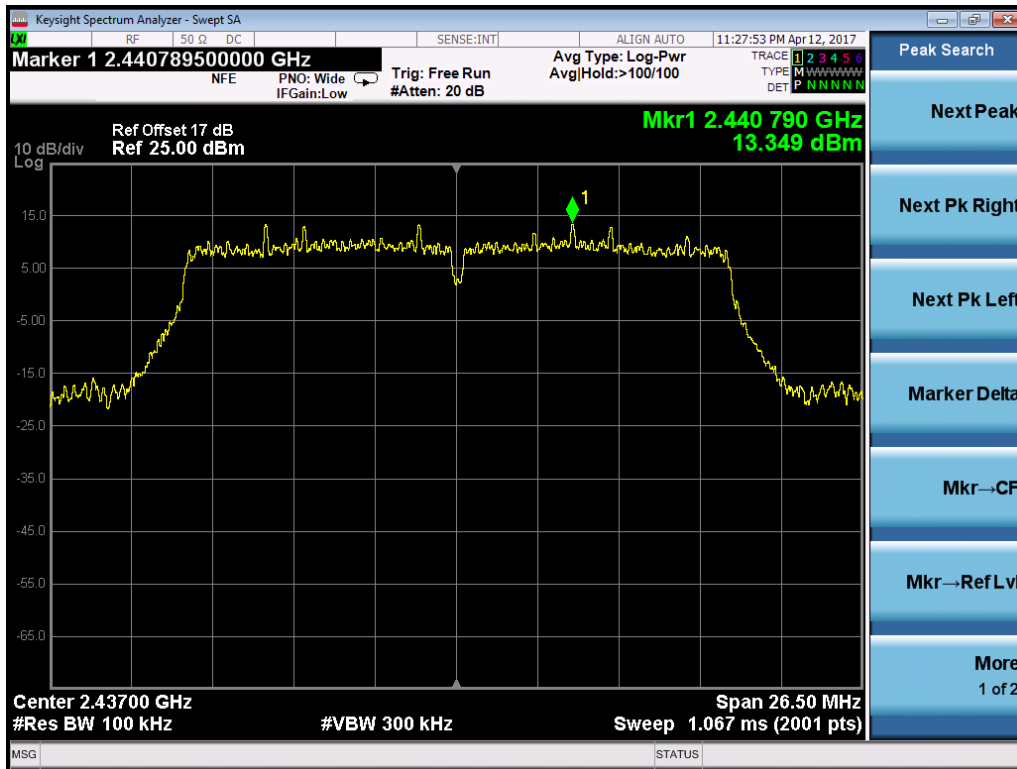

802.11n40

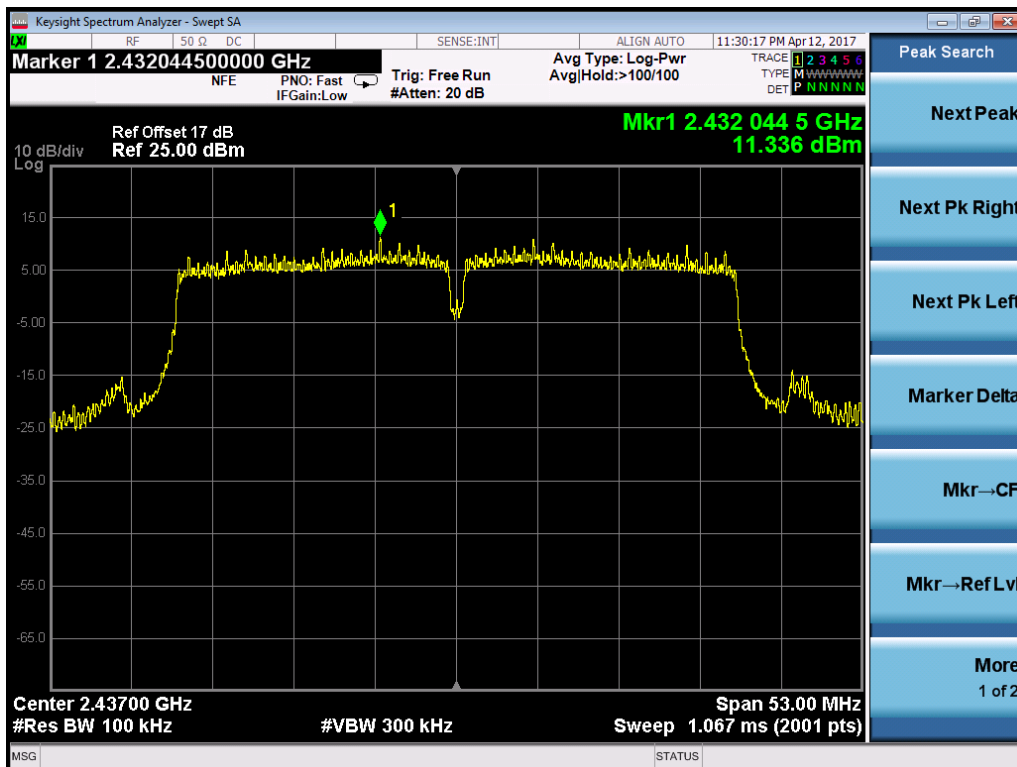

Test Plots of Band edge:

802.11b-2412MHz

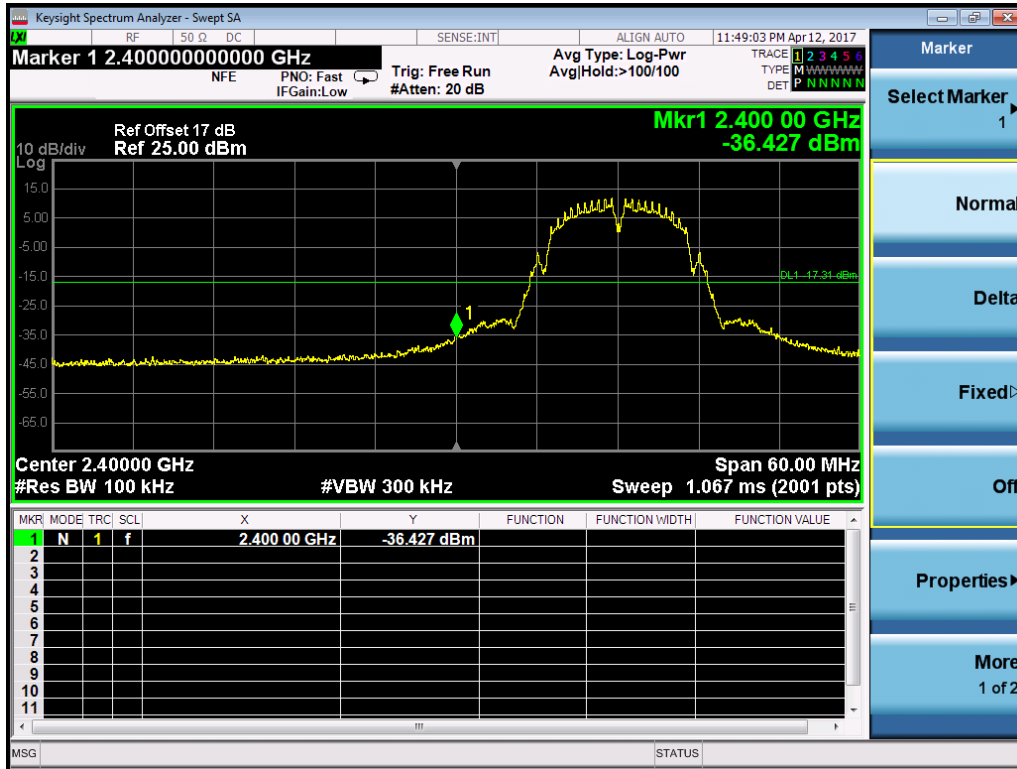

802.11b-2462MHz

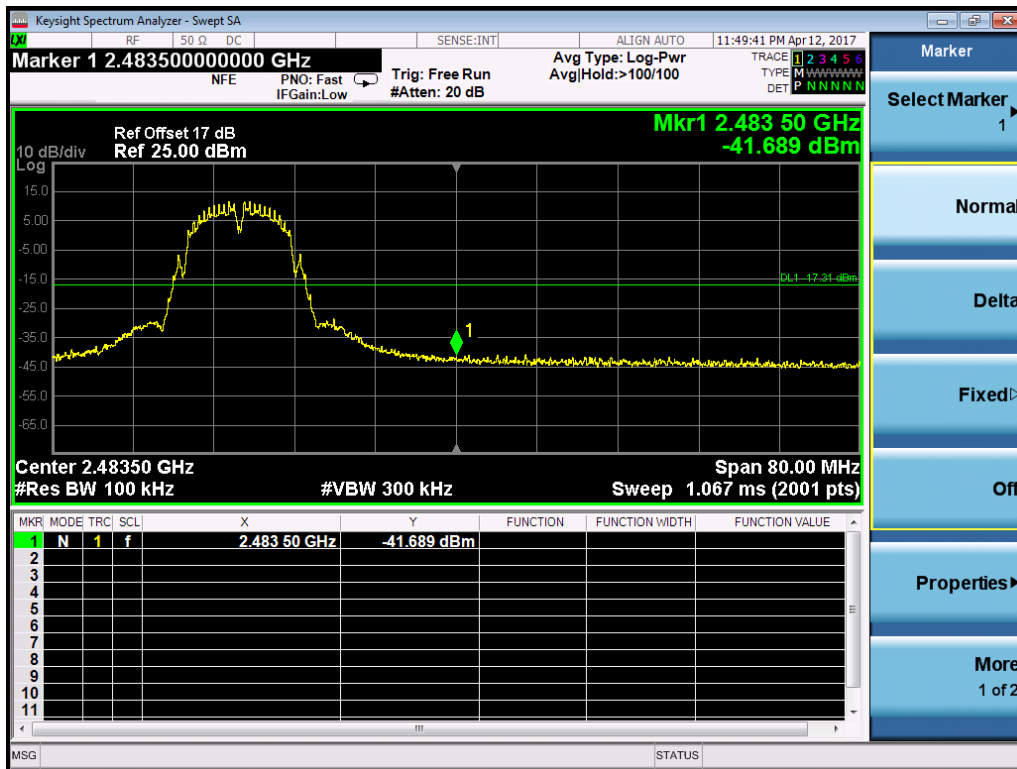

802.11g-2412MHz

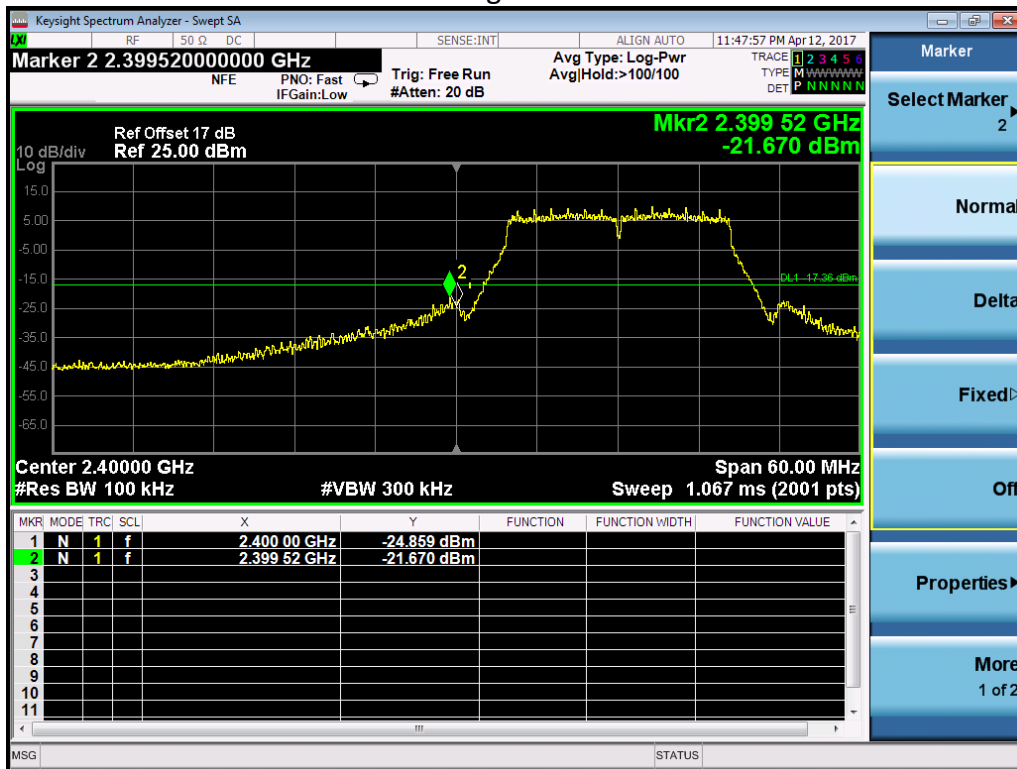

802.11g-2462MHz

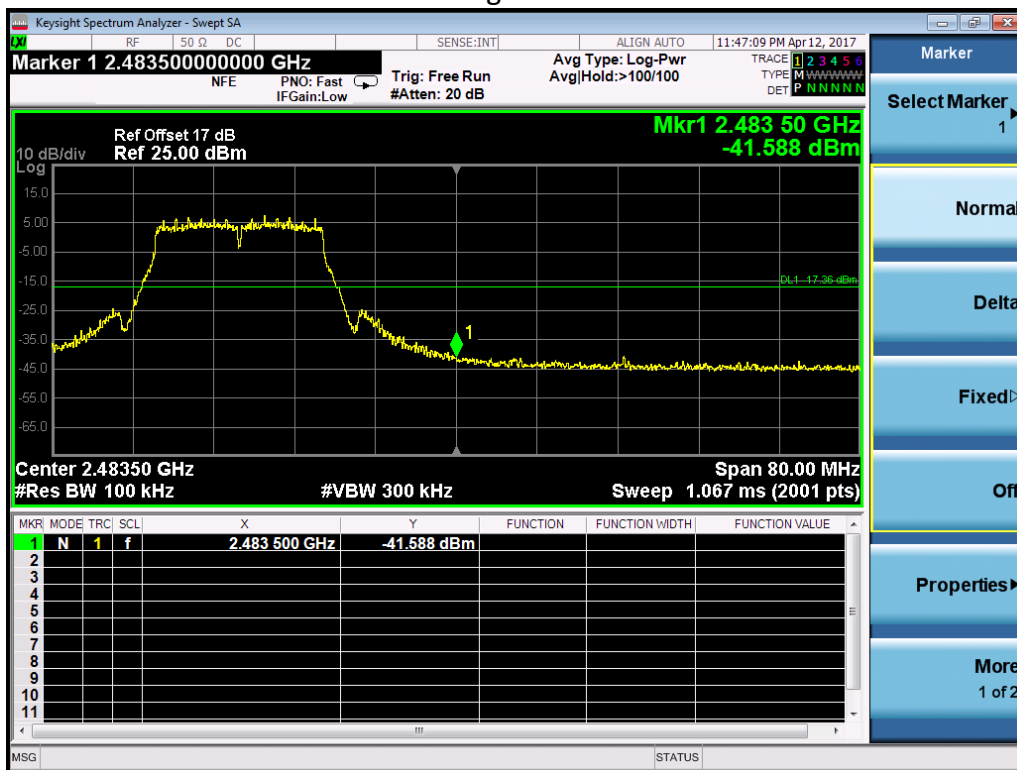

802.11n20-2412MHz

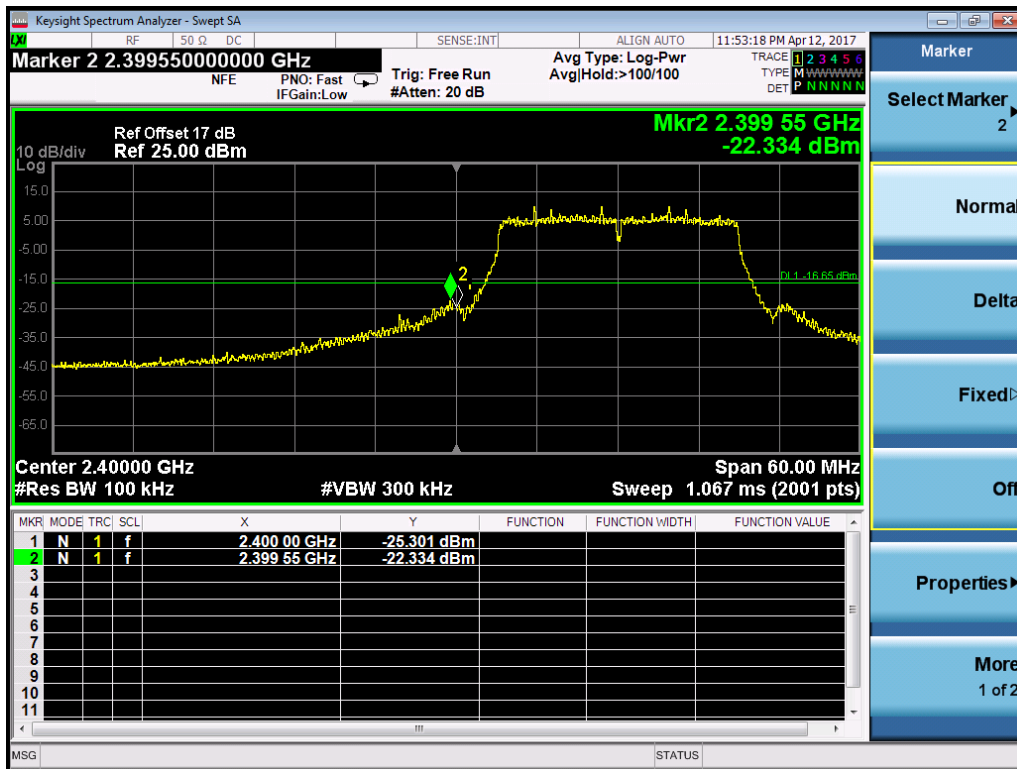

802.11n20-2462MHz

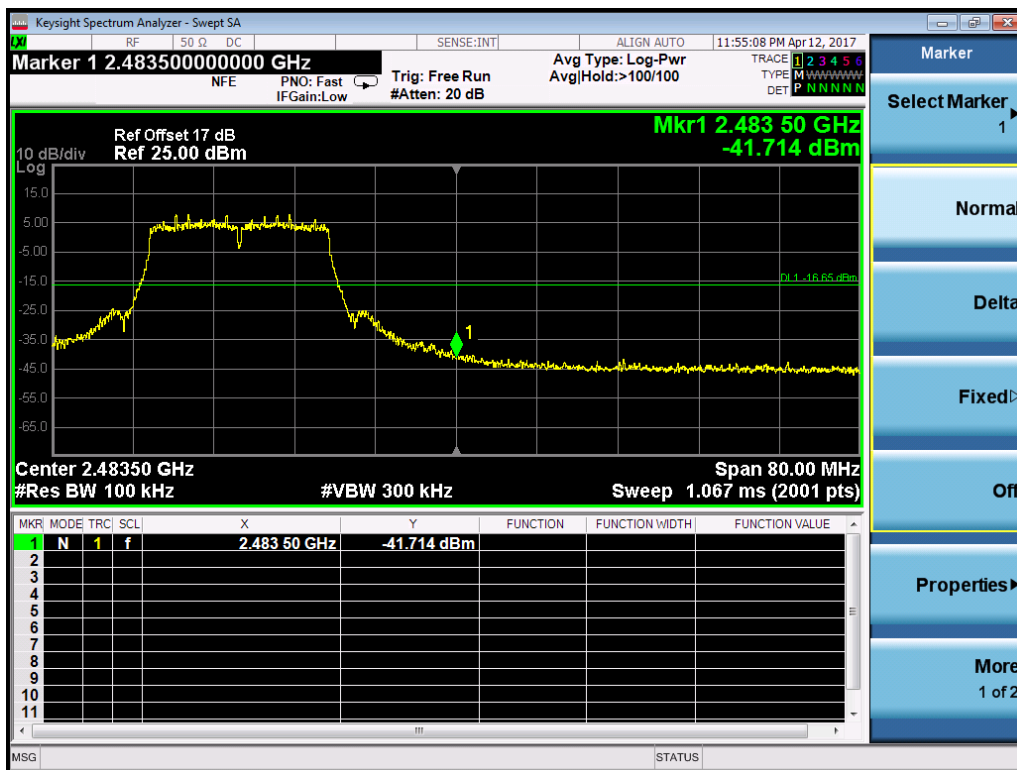

802.11n40-2422MHz



802.11n40-2452MHz



Test Plots of Spurious emission:

802.11b-2412MHz

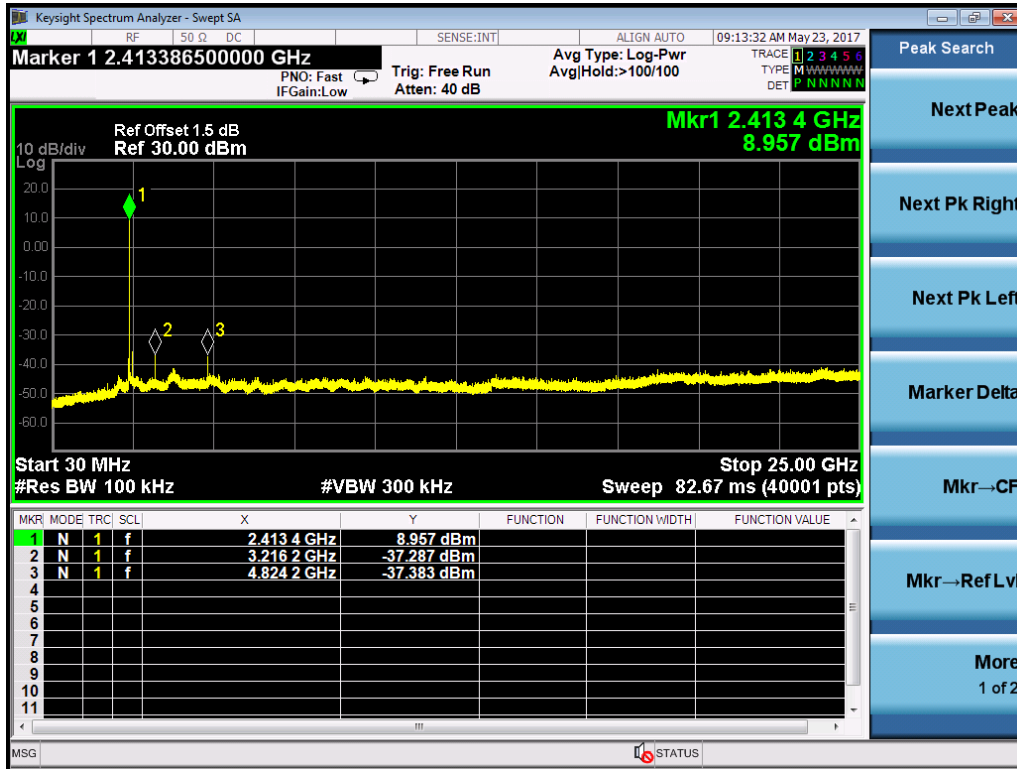

802.11b-2437MHz

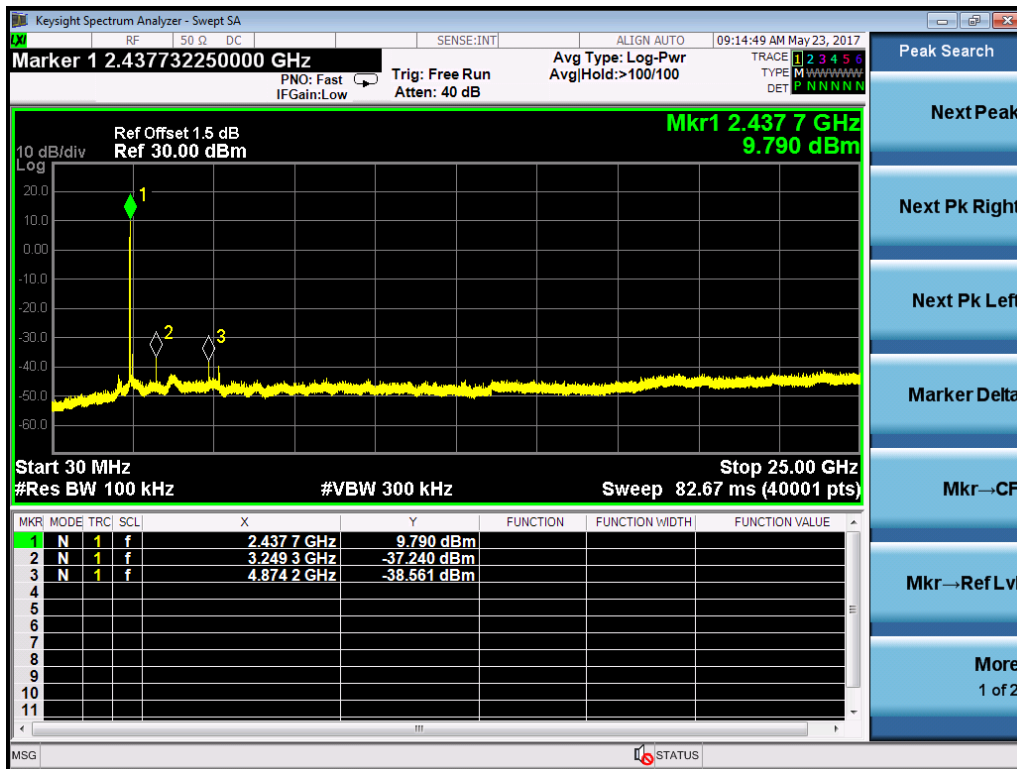

802.11b-2462MHz

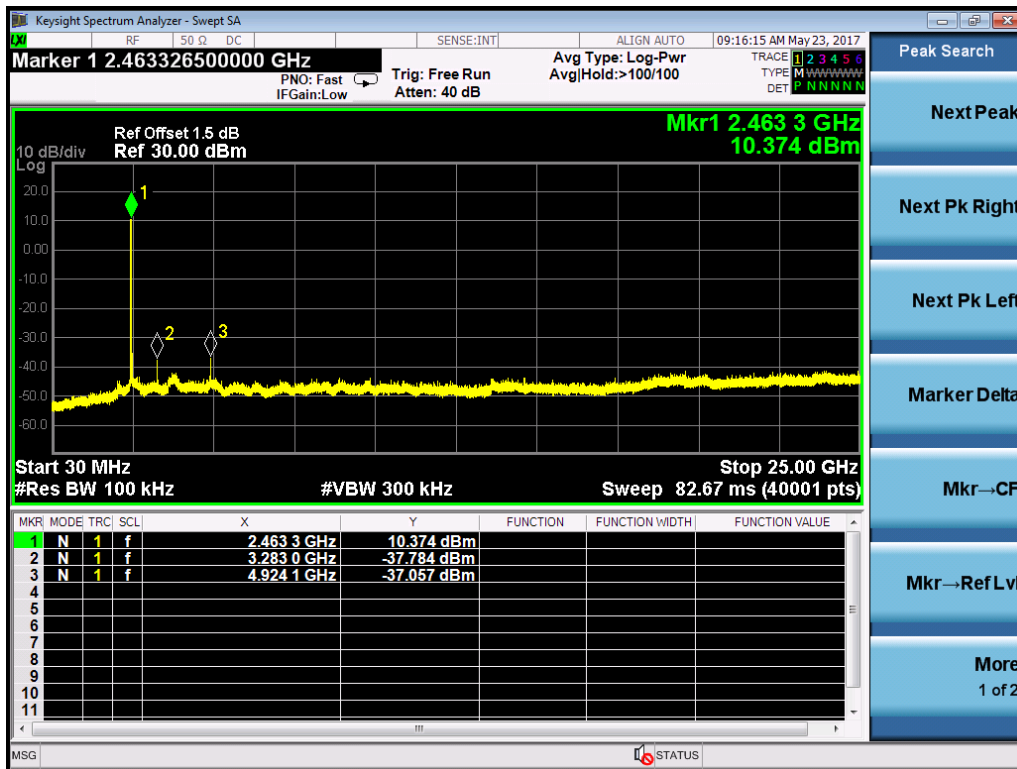

802.11g-2412MHz

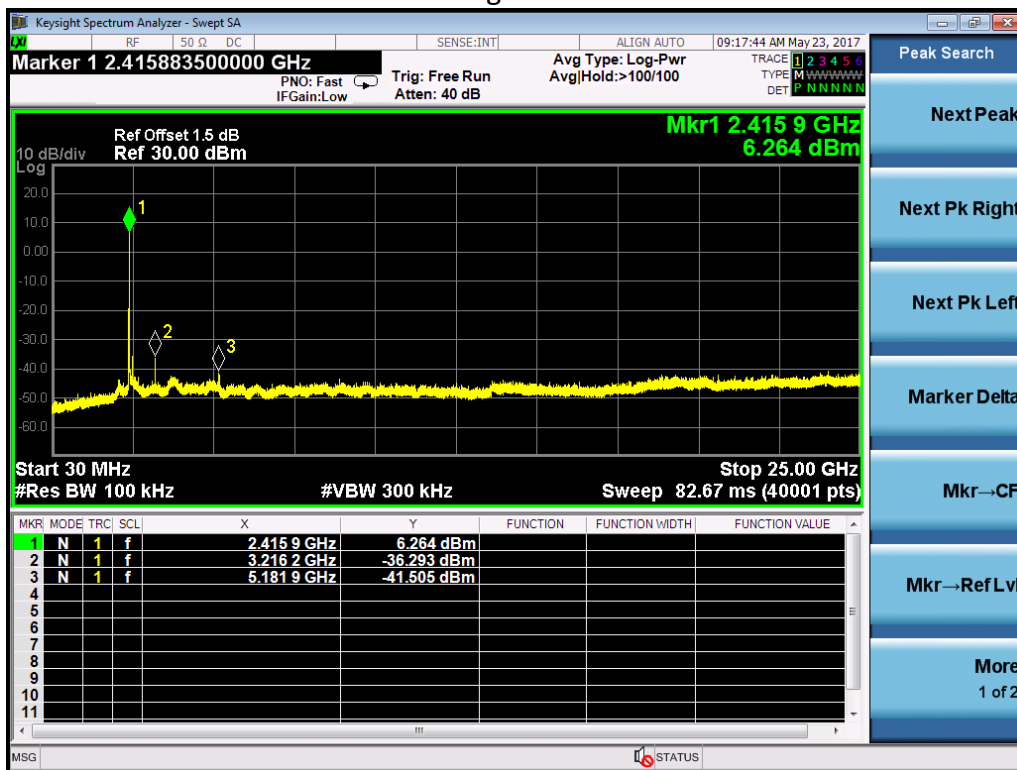

802.11g-2437MHz

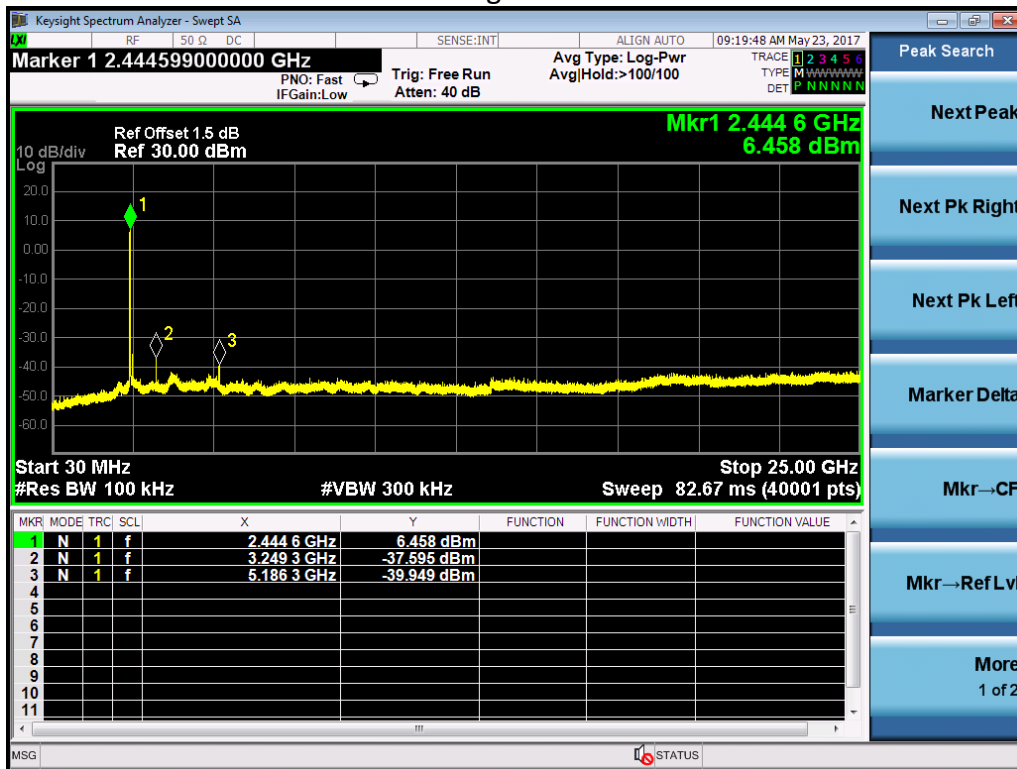

802.11g-2462MHz

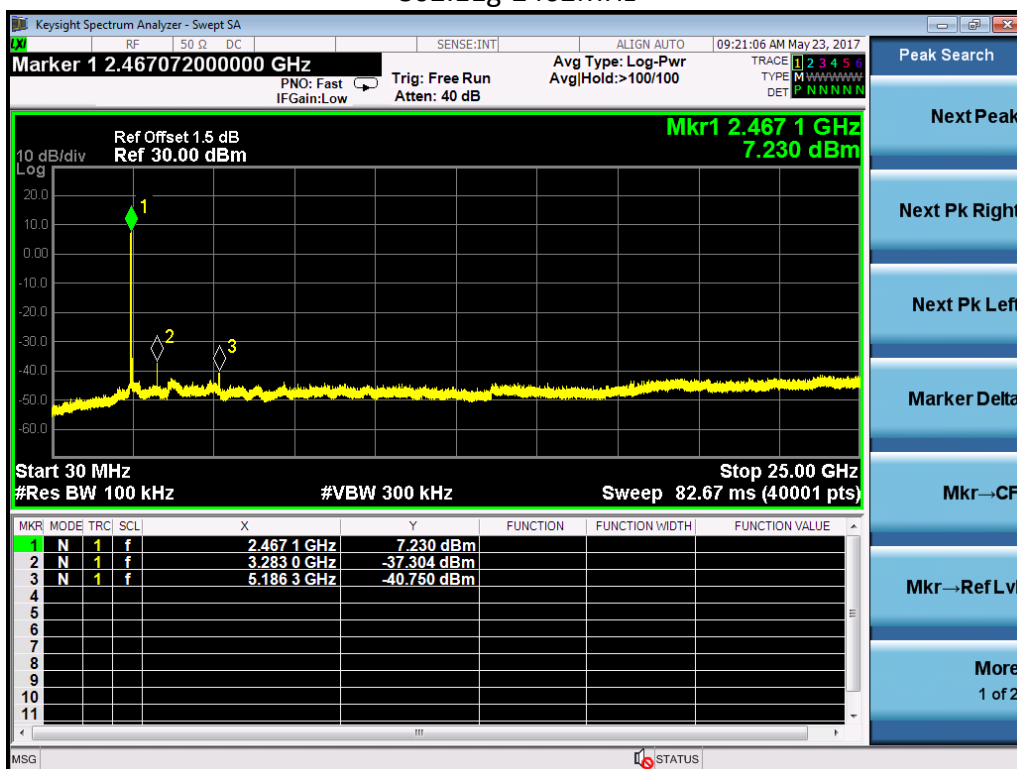

802.11n20-2412MHz

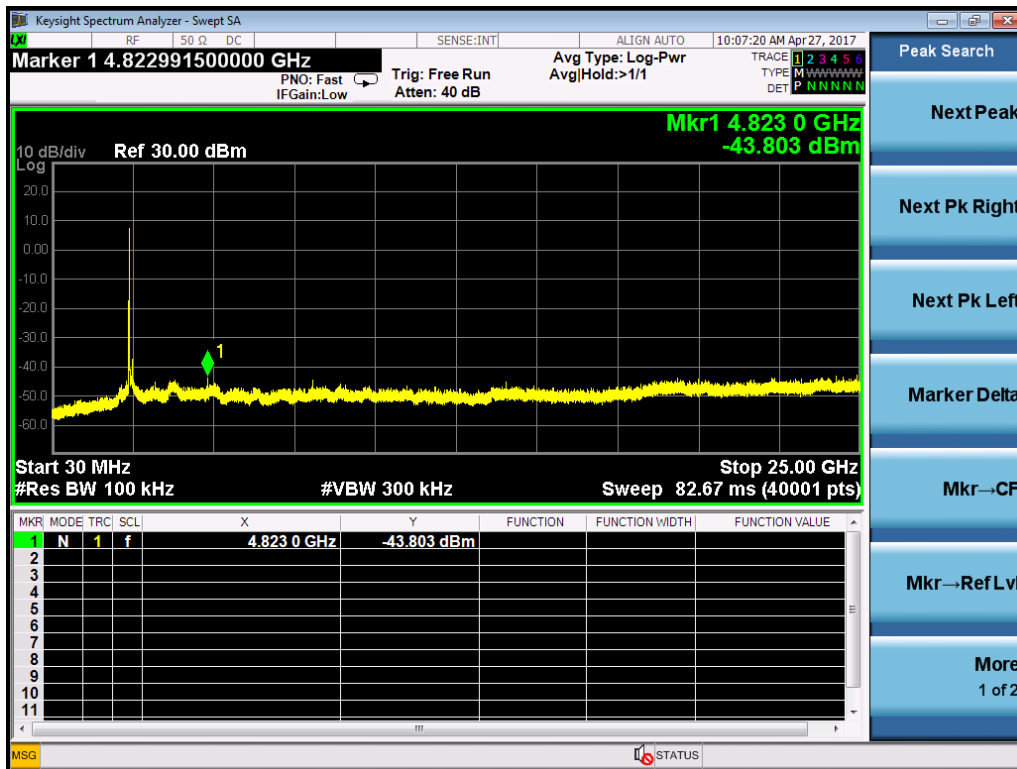

802.11n20-2437MHz

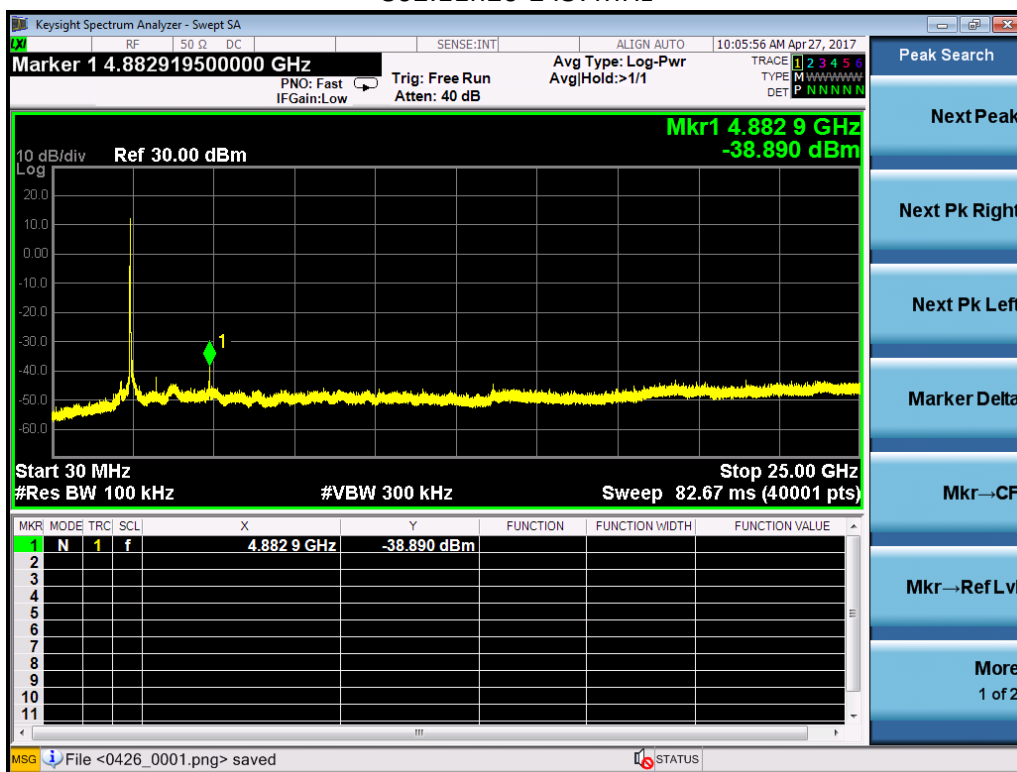

802.11n20-2462MHz

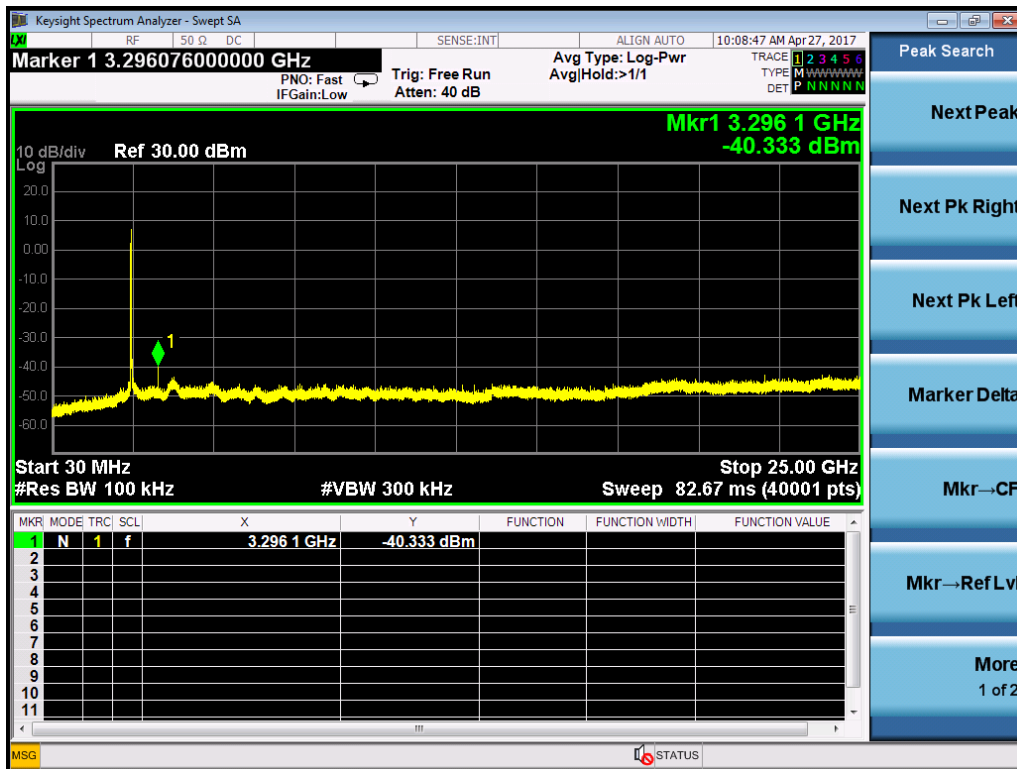

802.11n40-2422MHz

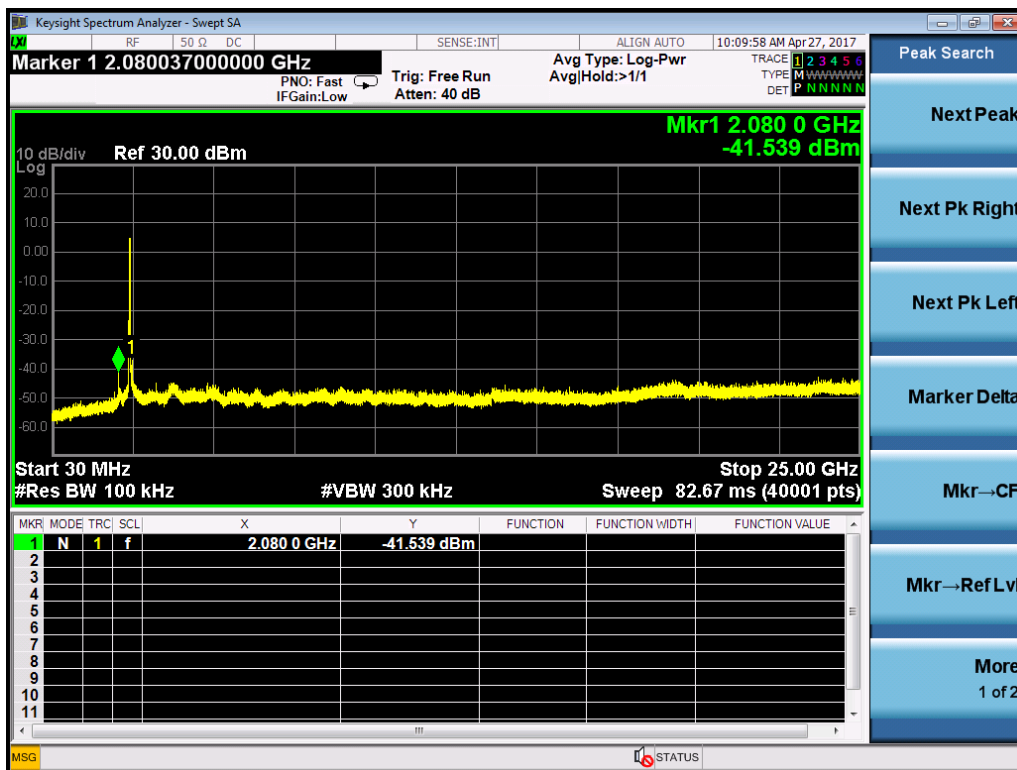

802.11n40-2437MHz

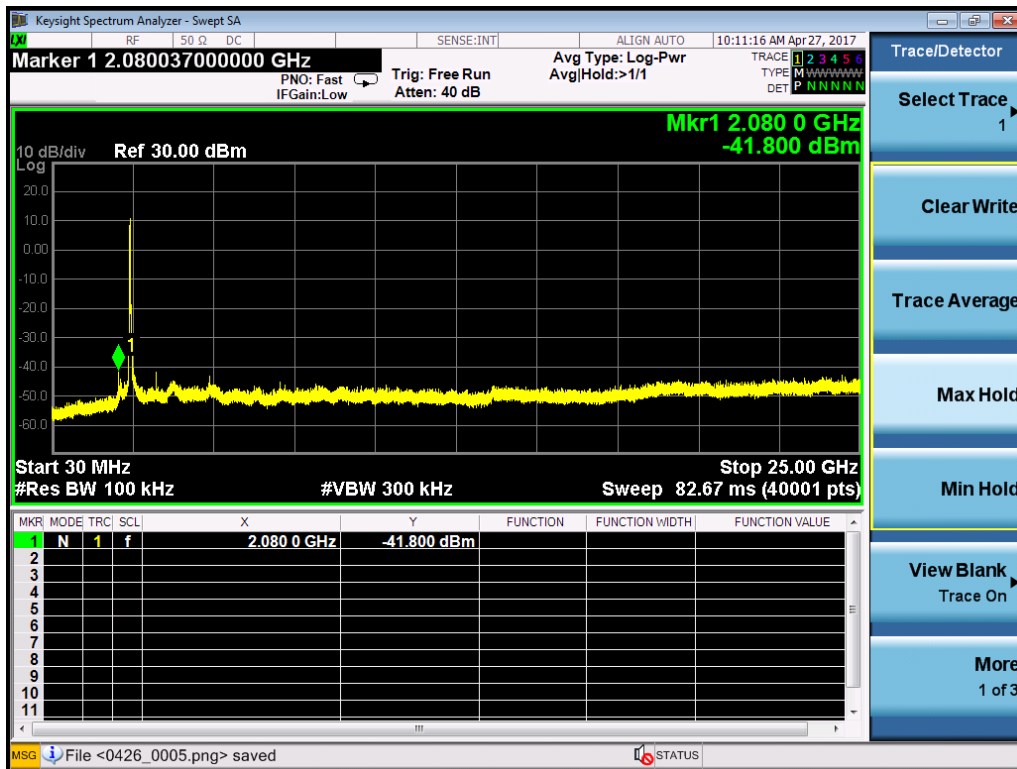

802.11n40-2452MHz

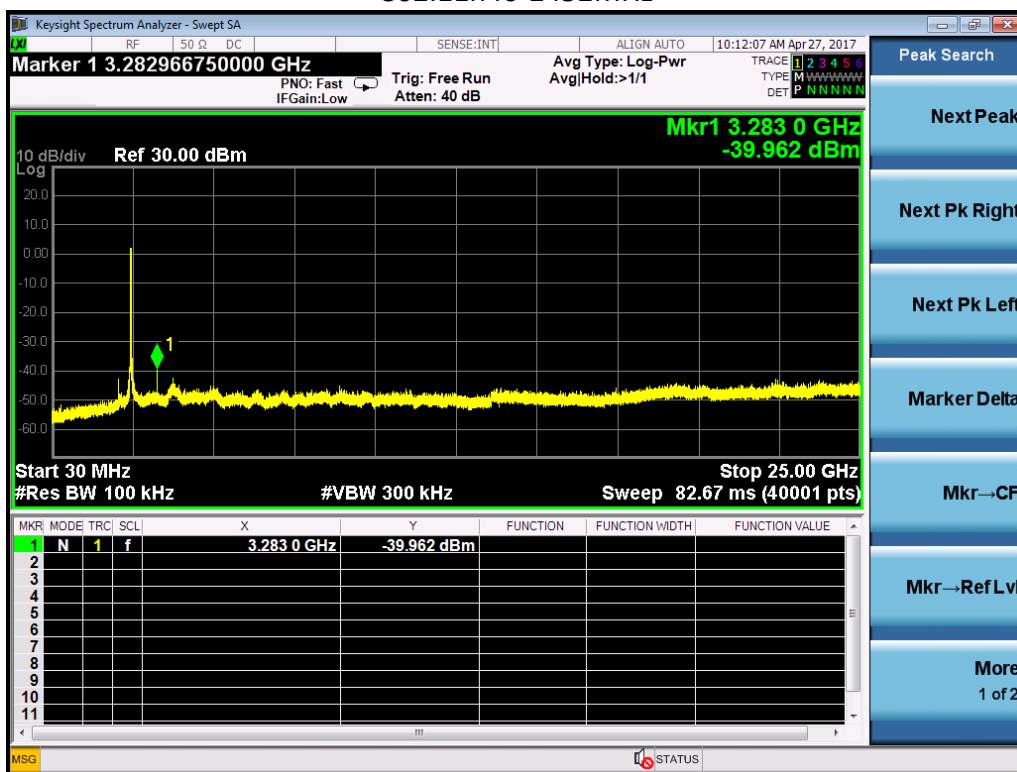

7 Radiated Emissions

Test result: Pass

7.1 Test limit

The radiated emissions which fall in the restricted bands, as defined in §15.205(a), must also comply with the radiated emission limits specified in §15.209(a) showed as below:

Frequencies (MHz)	Field Strength (microvolts/meter)	Measurement Distance (meters)
0.009 ~ 0.490	2400/F(kHz)	300
0.490 ~ 1.705	24000/F(kHz)	30
1.705 ~ 30.0	30	30
30 ~ 88	100	3
88 ~ 216	150	3
216 ~ 960	200	3
Above 960	500	3

7.2 Test Configuration

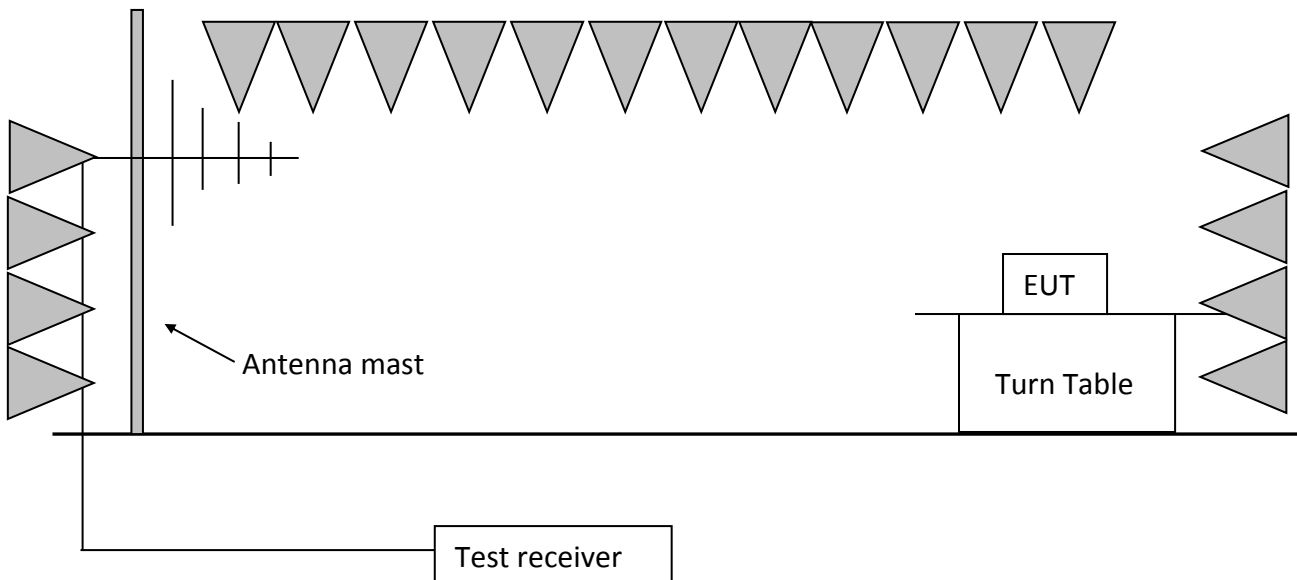

7.3 Test procedure and test setup

The measurement was applied in a semi-anechoic chamber. While testing for spurious emission higher than 1GHz, if applied, the pre-amplifier would be equipped just at the output terminal of the antenna.

Tabletop devices shall be placed on a nonconducting platform with nominal top surface dimensions 1 m by 1.5 m. For emissions testing at or below 1 GHz, the table height shall be 80 cm above the reference ground plane. For emission measurements above 1 GHz, the table height shall be 1.5 m.

The turntable rotated 360 degrees to determine the position of the maximum emission level. The EUT was set 3 meters away from the receiving antenna which was mounted on an antenna mast. The antenna moved up and down between from 1meter to 4 meters to find out the maximum emission level.

The EUT was tested according to DTS test procedure of KDB558074 D01 DTS "Meas Guidance" for compliance to FCC 47CFR 15.247 requirements.

The radiated emission was measured using the Spectrum Analyzer with the resolutions bandwidth set as:

RBW = 300 Hz, VBW = 1 kHz (9 kHz~150 kHz);
RBW = 10 kHz, VBW = 30 kHz (150 kHz~30MHz);
RBW = 100 kHz, VBW = 300 kHz (30MHz~1GHz for PK)
RBW = 1MHz, VBW = 3MHz (>1GHz for PK);

Remark:

1. Factor= Antenna Factor + Cable Loss (-Amplifier, is employed)
2. Measured level= Original Receiver Reading + Factor
3. Margin = Limit – Measured level
4. If the PK measured level is lower than AV limit, the AV test can be elided.

Example:

Assuming Antenna Factor = 30.20dB/m, Cable Loss = 2.00dB,
Gain of Preamplifier = 32.00dB, Original Receiver Reading = 10dBuV.
Then Factor = 30.20 + 2.00 – 32.00 = 0.20dB/m;
Measured level = 10dBuV + 0.20dB/m = 10.20dBuV/m
Assuming limit = 54dBuV/m,
Measured level = 10.20dBuV/m, then Margin = 54 - 10.20 = 43.80dBuV/m.

7.4 Test Protocol

Temperature: 25 °C
Relative Humidity: 55 %

The low frequency, which started from 9 kHz to 30MHz, was pre-scanned and the result which was 20dB lower than the limit line per 15.31(o) was not reported.

The worst waveform from 30MHz to 1000MHz is listed as below:

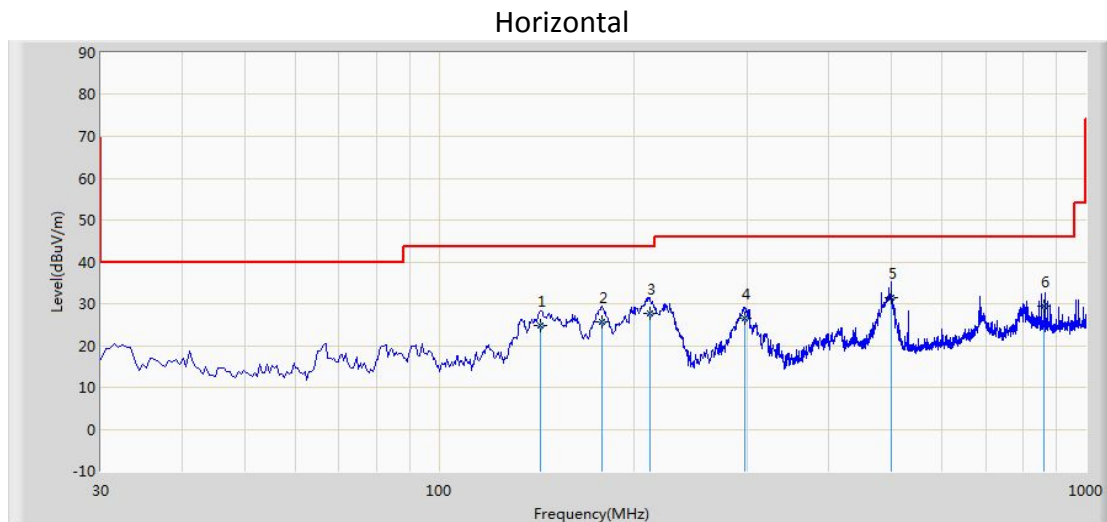

No	Flag	Mark	Frequency (MHz)	Measure Level (dBuV/m)	Reading Level (dBuV)	Over Limit (dB)	Limit (dBuV/m)	Factor (dB)	Type
1			143.490	24.849	10.120	-18.651	43.500	14.729	QP
2			178.960	25.532	12.580	-17.968	43.500	12.952	QP
3			211.875	27.763	16.350	-15.737	43.500	11.414	QP
4			297.560	26.649	12.410	-19.351	46.000	14.239	QP
5		*	499.630	31.331	12.856	-14.669	46.000	18.475	QP
6			863.256	29.336	5.520	-16.664	46.000	23.816	QP

Note: Measure Level (dBuV/m) = Reading Level (dBuV) + Factor (dB)

Factor (dB) = Cable Loss (dB) + Antenna Factor (dB/m).

Vertical

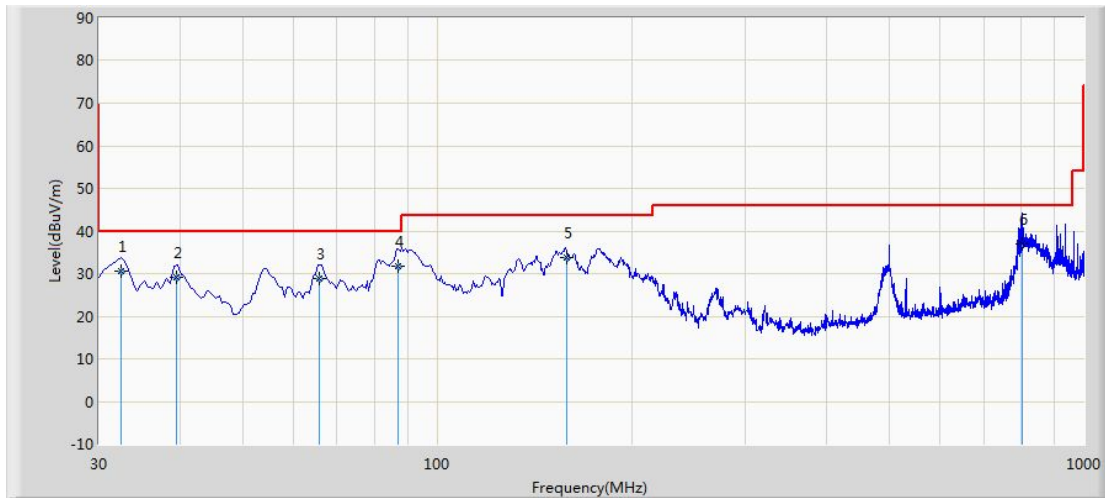

No	Flag	Mark	Frequency (MHz)	Measure Level (dBuV/m)	Reading Level (dBuV)	Over Limit (dB)	Limit (dBuV/m)	Factor (dB)	Type
1			32.425	30.564	16.856	-9.436	40.000	13.708	QP
2			39.526	29.010	14.526	-10.990	40.000	14.484	QP
3			65.850	28.799	16.526	-11.201	40.000	12.273	QP
4		*	86.850	31.678	21.526	-8.322	40.000	10.153	QP
5			158.400	33.816	18.630	-9.684	43.500	15.186	QP
6			802.646	37.036	13.800	-8.964	46.000	23.237	QP

Note: Measure Level (dBuV/m) = Reading Level (dBuV) + Factor (dB)

Factor (dB) = Cable Loss (dB) + Antenna Factor (dB/m).

Test result above 1GHz:

The emission was conducted from 1GHz to 25GHz.

802.11b:

CH	Antenna	Frequency (MHz)	Measure Level (dBuV/m)	Reading Level (dBuV)	Over Limit (dB)	Limit (dBuV/m)	Factor (dB)	Type
L	H	2390.000	58.574	27.371	-15.426	74.000	31.203	PK
	H	2390.000	46.015	14.812	-7.985	54.000	31.203	AV
	V	4824.000	53.440	50.740	-0.560	54.000	2.700	AV
	V	4825.000	54.281	51.581	-19.719	74.000	2.700	PK
M	V	4874.175	53.363	50.690	-0.637	54.000	2.674	AV
	V	4876.000	55.519	52.844	-18.481	74.000	2.675	PK
H	V	2483.500	64.831	33.638	-9.169	74.000	31.194	PK
	V	2483.500	52.632	21.439	-1.368	54.000	31.194	AV
	V	4924.000	53.694	50.930	-0.306	54.000	2.765	AV
	V	4927.000	55.749	52.979	-18.251	74.000	2.770	PK

802.11g:

CH	Antenna	Frequency (MHz)	Measure Level (dBuV/m)	Reading Level (dBuV)	Over Limit (dB)	Limit (dBuV/m)	Factor (dB)	Type
L	V	2390.000	71.783	40.580	-2.217	74.000	31.203	PK
	V	2390.000	52.993	21.790	-1.007	54.000	31.203	AV
	V	4816.500	54.039	51.342	-19.961	74.000	2.697	PK
	V	4825.750	41.730	39.030	-12.270	54.000	2.700	AV
M	V	4871.400	46.781	44.110	-7.219	54.000	2.671	AV
	V	4876.000	59.093	56.418	-14.907	74.000	2.675	PK
	V	7307.000	62.004	54.012	-11.996	74.000	7.992	PK
	V	7311.650	47.816	39.810	-6.184	54.000	8.006	AV
H	V	2483.500	68.219	37.026	-5.781	74.000	31.194	PK
	V	2483.500	46.775	15.582	-7.225	54.000	31.194	AV
	V	4926.550	40.409	37.640	-13.591	54.000	2.768	AV
	V	4927.000	53.319	50.549	-20.681	74.000	2.770	PK

802.11n (HT20):

CH	Antenna	Frequency (MHz)	Measure Level (dBuV/m)	Reading Level (dBuV)	Over Limit (dB)	Limit (dBuV/m)	Factor (dB)	Type
L	V	2390.000	70.542	39.339	-3.458	74.000	31.203	PK
	V	2390.000	52.150	20.947	-1.850	54.000	31.203	AV
	V	4822.650	41.699	39.000	-12.301	54.000	2.700	AV
	V	4825.000	53.562	50.862	-20.438	74.000	2.700	PK
M	V	4872.850	51.462	48.790	-2.538	54.000	2.672	AV
	V	4876.000	57.931	55.256	-16.069	74.000	2.675	PK
H	V	2483.500	69.988	38.795	-4.012	74.000	31.194	PK
	V	2483.500	53.293	22.100	-0.707	54.000	31.194	AV
	V	4922.875	40.802	38.040	-13.198	54.000	2.762	AV
	V	4927.000	53.911	51.141	-20.089	74.000	2.770	PK

802.11n (HT40):

CH	Antenna	Frequency (MHz)	Measure Level (dBuV/m)	Reading Level (dBuV)	Over Limit (dB)	Limit (dBuV/m)	Factor (dB)	Type
L	V	2390.000	68.984	37.781	-5.016	74.000	31.203	PK
	V	2390.000	53.202	21.999	-0.798	54.000	31.203	AV
	V	4850.500	51.844	49.165	-22.156	74.000	2.679	PK
	V	7281.500	48.718	40.737	-25.282	74.000	7.981	PK
M	V	4867.500	55.204	52.536	-18.796	74.000	2.667	PK
	V	4875.300	42.324	39.650	-11.676	54.000	2.674	AV
H	V	2483.500	66.449	35.256	-7.551	74.000	31.194	PK
	V	2483.500	53.604	22.411	-0.396	54.000	31.194	AV
	V	4910.000	46.572	43.833	-27.428	74.000	2.739	PK
	V	7375.000	47.494	39.600	-26.506	74.000	7.894	PK

8 Power line conducted emission

Test result: Pass

8.1 Limit

Frequency of Emission (MHz)	Conducted Limit (dBuV)	
	QP	AV
0.15-0.5	66 to 56*	56 to 46 *
0.5-5	56	46
5-30	60	50

* Decreases with the logarithm of the frequency.

8.2 Test configuration

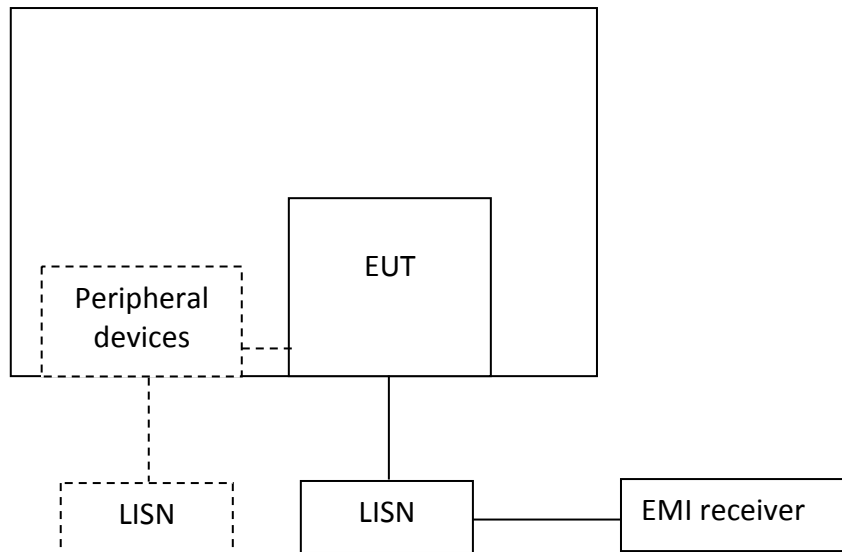

For table top equipment, wooden support is 0.8m height table

For floor standing equipment, wooden support is 0.1m height rack.

8.3 Test procedure and test set up

Measured levels of ac power-line conducted emission shall be the emission voltages from the voltage probe, where permitted, or across the 50 Ω LISN port (to which the EUT is connected), where permitted, terminated into a 50 Ω measuring instrument. All emission voltage and current measurements shall be made on each current-carrying conductor at the plug end of the EUT power cord by the use of mating plugs and receptacles on the LISN, if used. Equipment shall be tested with power cords that are normally supplied or recommended by the manufacturer and that have electrical and shielding characteristics that are the same as those cords normally supplied or recommended by the manufacturer. For those measurements using a LISN, the 50 Ω measuring port is terminated by a measuring instrument having 50 Ω input impedance. All other ports are terminated in 50 Ω loads.

Tabletop devices shall be placed on a platform of nominal size 1 m by 1.5 m, raised 80 cm above the reference ground plane. The vertical conducting plane or wall of an RF-shielded (screened) room shall be located 40 cm to the rear of the EUT. Floor-standing devices shall be placed either directly on the reference ground-plane or on insulating material as described in ANSI C63.4. All other surfaces of tabletop or floor-standing EUTs shall be at least 80 cm from any other grounded conducting surface, including the case or cases of one or more LISNs.

The bandwidth of the test receiver is set at 9 kHz.

8.4 Test protocol

Temperature: 22 °C
Relative Humidity: 52 %

L line:

Test Curve:

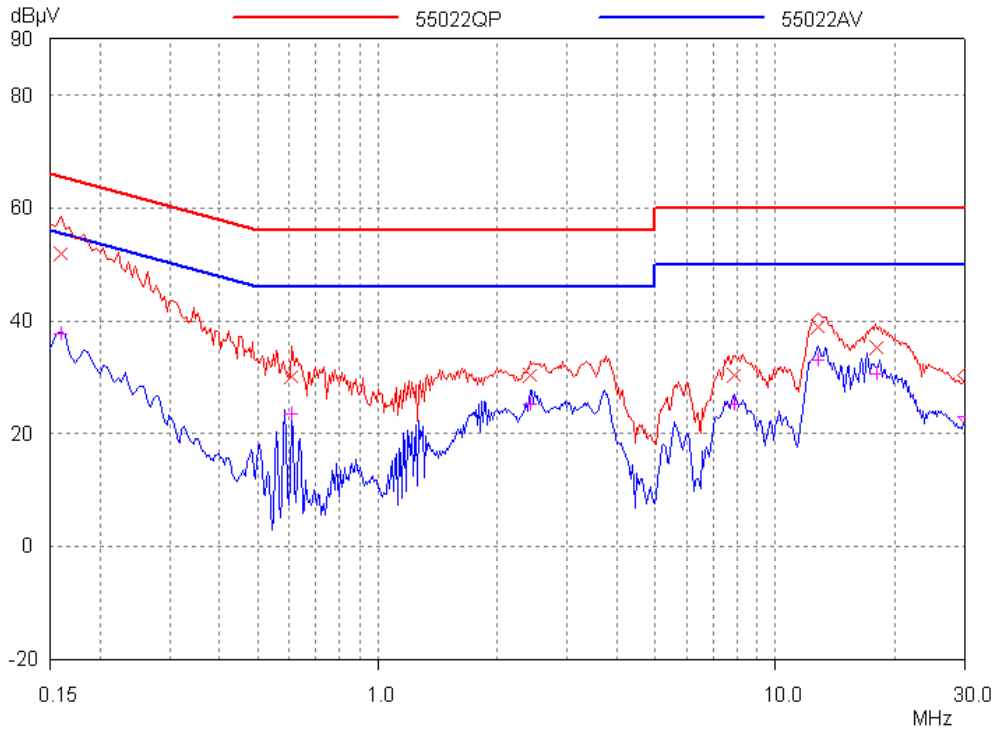

Test Data:

Frequency (MHz)	Quasi-peak			Frequency (MHz)	Average		
	Level dB(µV)	Limit dB(µV)	Margin dB		Level dB(µV)	Limit dB(µV)	Margin dB
0.159	52.00	65.52	13.52	0.159	37.66	55.52	17.86
0.6045	30.03	56.00	25.97	0.6045	23.60	46.00	22.40
2.4045	30.43	56.00	25.57	2.4045	25.16	46.00	20.84
7.8225	30.41	60.00	29.59	7.8225	25.28	50.00	24.72
12.714	38.89	60.00	21.11	12.714	32.96	50.00	17.04
17.889	35.15	60.00	24.85	17.889	30.52	50.00	19.48

N line:

Test Curve:

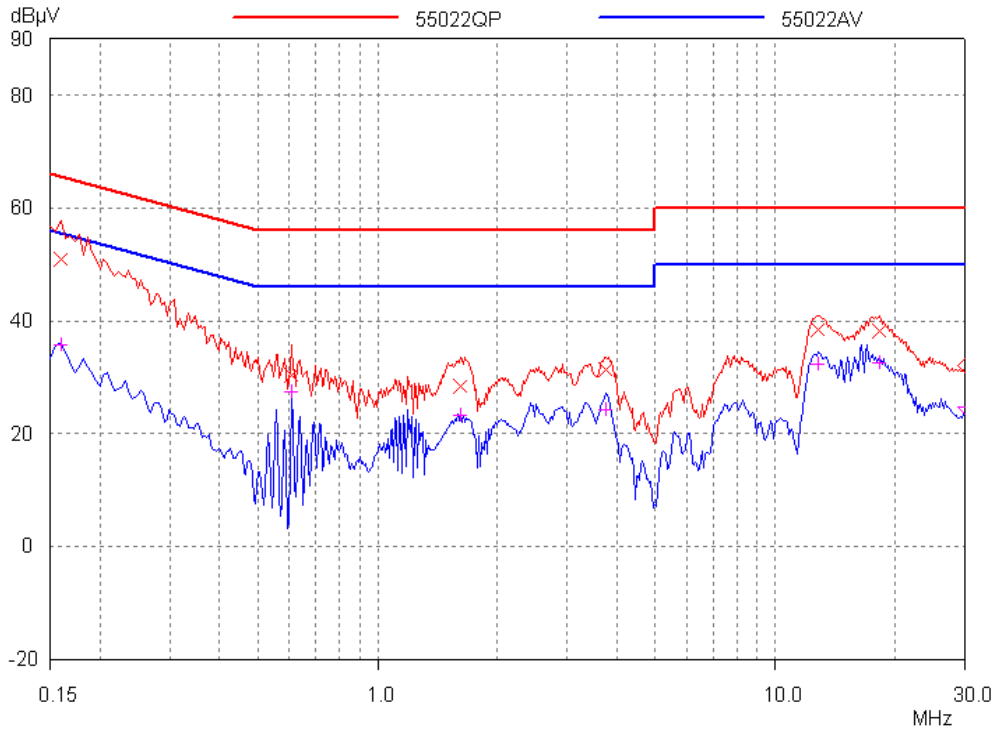

Test Data:

Frequency (MHz)	Quasi-peak			Frequency (MHz)	Average		
	Level dB(µV)	Limit dB(µV)	Margin dB		Level dB(µV)	Limit dB(µV)	Margin dB
0.159	51.01	65.52	14.51	0.159	35.72	0.159	35.72
0.609	30.45	56.00	25.55	0.609	27.35	0.609	27.35
1.6125	28.50	56.00	27.50	1.6125	23.23	1.6125	23.23
3.723	31.45	56.00	24.55	3.723	24.31	3.723	24.31
12.777	38.36	60.00	21.64	12.777	32.27	12.777	32.27
18.276	38.14	60.00	21.86	18.276	32.44	18.276	32.44