

FCC RF TEST REPORT
No. 170201711SHA-002

Applicant : Alcatel-Lucent Shanghai Bell Co.,Ltd.
388-389#, Ningqiao Road, Pudong Jinqiao, Shanghai, China

Manufacturer : Alcatel-Lucent Shanghai Bell Co.,Ltd.
388-389#, Ningqiao Road, Pudong Jinqiao, Shanghai, China

Product Name : Digital Home CPE

Type/Model : A-240Z-A

EMA Code : 3FE 46615 AAAA

TEST RESULT : PASS

SUMMARY

The equipment complies with the requirements according to the following standard(s) or specification:

47CFR Part 15 (2016): Radio Frequency Devices (Subpart E)

ANSI C63.10 (2013): American National Standard of Procedures for Compliance Testing of Unlicensed Wireless Devices

Date of issue: June 7, 2017

Prepared by:

Wade Zhang (Project Engineer)

Reviewed by:

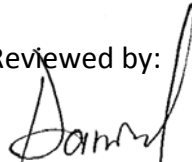
Daniel Zhao (Reviewer)

Description of Test Facility

Name: Intertek Testing Service Limited Shanghai
Address: Building No.86, 1198 Qinzhou Road (North), Shanghai 200233, P.R. China

FCC Registration Number: 236597

IC Assigned Code: 2402B-1

Name of contact: Jonny Jing

Tel: 86 21 61278271

Fax: 86 21 54262353

Content

SUMMARY.....	1
DESCRIPTION OF TEST FACILITY.....	2
1 GENERAL INFORMATION.....	5
1.1 DESCRIPTION OF CLIENT	5
1.2 IDENTIFICATION OF THE EUT	5
1.3 TECHNICAL SPECIFICATION	5
2 TEST SPECIFICATIONS.....	6
2.1 STANDARDS OR SPECIFICATION.....	6
2.2 MODE OF OPERATION DURING THE TEST	6
2.3 TEST SOFTWARE LIST	10
2.4 TEST PERIPHERALS LIST	10
2.5 INSTRUMENT LIST	10
2.6 TEST SUMMARY	11
3 26 DB BANDWIDTH & EMISSION BANDWIDTH (99%).....	12
3.1 TEST LIMIT	12
3.2 TEST CONFIGURATION.....	12
3.3 TEST PROCEDURE AND TEST SETUP	12
3.4 TEST PROTOCOL	14
4 MAXIMUM CONDUCTED OUTPUT POWER	19
4.1 TEST LIMIT	19
4.2 TEST CONFIGURATION.....	20
4.3 TEST PROCEDURE AND TEST SETUP	20
4.4 TEST PROTOCOL	21
5 POWER SPECTRUM DENSITY	23
5.1 TEST LIMIT	23
5.2 TEST CONFIGURATION.....	23
5.3 TEST PROCEDURE AND TEST SETUP	24
5.4 TEST PROTOCOL.....	25
6 MINIMUM 6DB BANDWIDTH	54
6.1 LIMIT	54
6.2 TEST CONFIGURATION.....	54
6.3 TEST PROCEDURE AND TEST SETUP.....	54
6.4 TEST PROTOCOL.....	55
7 RADIATED EMISSIONS.....	60
7.1 TEST LIMIT	60
7.2 TEST CONFIGURATION.....	61
7.3 TEST PROCEDURE AND TEST SETUP	62
7.4 TEST PROTOCOL.....	63
8 POWER LINE CONDUCTED EMISSION.....	72
8.1 LIMIT	72
8.2 TEST CONFIGURATION	72
8.3 TEST PROCEDURE AND TEST SET UP	73
8.4 TEST PROTOCOL	74
9 FREQUENCY STABILITY	76

9.1	LIMIT	76
9.2	BLOCK DIAGRAM OF TEST SETUP.....	76
9.3	TEST PROCEDURE AND TEST SETUP	76
9.4	TEST PROTOCOL.....	77
9.5	MEASUREMENT UNCERTAINTY	77

1 GENERAL INFORMATION

1.1 Description of Client

Applicant : Alcatel-Lucent Shanghai Bell Co., Ltd.
388-389#, Ningqiao Road, Pudong Jinqiao, Shanghai, China
Manufacturer : Alcatel-Lucent Shanghai Bell Co., Ltd.
388-389#, Ningqiao Road, Pudong Jinqiao, Shanghai, China

1.2 Identification of the EUT

Product Name : Digital Home CPE
Type/model : A-240Z-A
FCC ID : 2ADZRA240ZA

1.3 Technical Specification

Operation Frequency : 5150 ~ 5250MHz,
Band : 5725 ~ 5850MHz
Type of Modulation : OFDM(BPSK, QPSK, 16QAM, 64QAM, 256QAM)
EUT Modes of Modulation : 802.11a, 802.11n/ac(HT20),
802.11n/ac(HT40), 802.11ac(VHT80)
Channel Number : For 5150 ~ 5250MHz band: Channel 36 – 48;
For 5725 ~ 5850MHz band: Channel 149 - 165
Description of EUT : The EUT is a digital home CPE, it support WIFI, ZigBee and Z-Wave, and there have only one model, we test it and listed the WIFI 5G band results in this report.
Antenna : PCB antenna, 3dBi max Peak gain, FAF connector
Rating : 100-240V, 50/60Hz
Category of EUT : Class B
EUT type : Table top
 Floor standing
Sample received date : March 6, 2017
Date of test : March 6, 2017 to April 18, 2017

2 TEST SPECIFICATIONS

2.1 Standards or specification

47CFR Part 15 (2016)
ANSI C63.10 (2013)
KDB 789033 D02 v01r04

2.2 Mode of operation during the test

While testing transmitting mode of EUT, the internal modulation and continuously transmission was applied.

The lowest, middle and highest channel were tested as representatives.

Frequency Band (MHz)	Mode	Lowest (MHz)	Middle (MHz)	Highest (MHz)
5150~5250MHz	802.11a	5180	5220	5240
	802.11n20	5180	5220	5240
	802.11n40	5190	/	5230
	802.11ac80	/	5210	/
5725~5850MHz	802.11a	5745	5785	5825
	802.11n20	5745	5785	5825
	802.11n40	5755	/	5795
	802.11ac80	/	5775	/

MIMO Function Description:

Mode	Tx/Rx Function	Beamforming Function	Directional gain
802.11a	1Tx/1Rx	No	3dBi
802.11n20	4Tx/4Rx	No	3dBi
802.11n40	4Tx/4Rx	No	3dBi
802.11ac80	4Tx/4Rx	No	3dBi

Note: all transmit signals are completely uncorrelated with each other, Directional gain= G_{ANT} .

Data rate VS Power:

The pre-scan for the conducted power with all rates in each modulation and bands was used, and the worst case was found and used in all test cases.

After this pre-scan, we choose the following table of the data rate as the worst case.

Frequency Band (MHz)	Mode	Worst case data rate
5150~5250	802.11a	6Mbps
	802.11n20	MCS24
	802.11n40	MCS24
	802.11ac80	MCS0NSS4
5725~5850	802.11a	6Mbps
	802.11n20	MCS24
	802.11n40	MCS24
	802.11ac80	MCS0NSS4

Duty cycle:

Mode	Duty cycle (%)	Duty cycle factor (dB)
802.11a	95.07	0.22
802.11n20	94.91	0.23
802.11n40	90.33	0.44
802.11ac80	84.37	0.74

802.11a

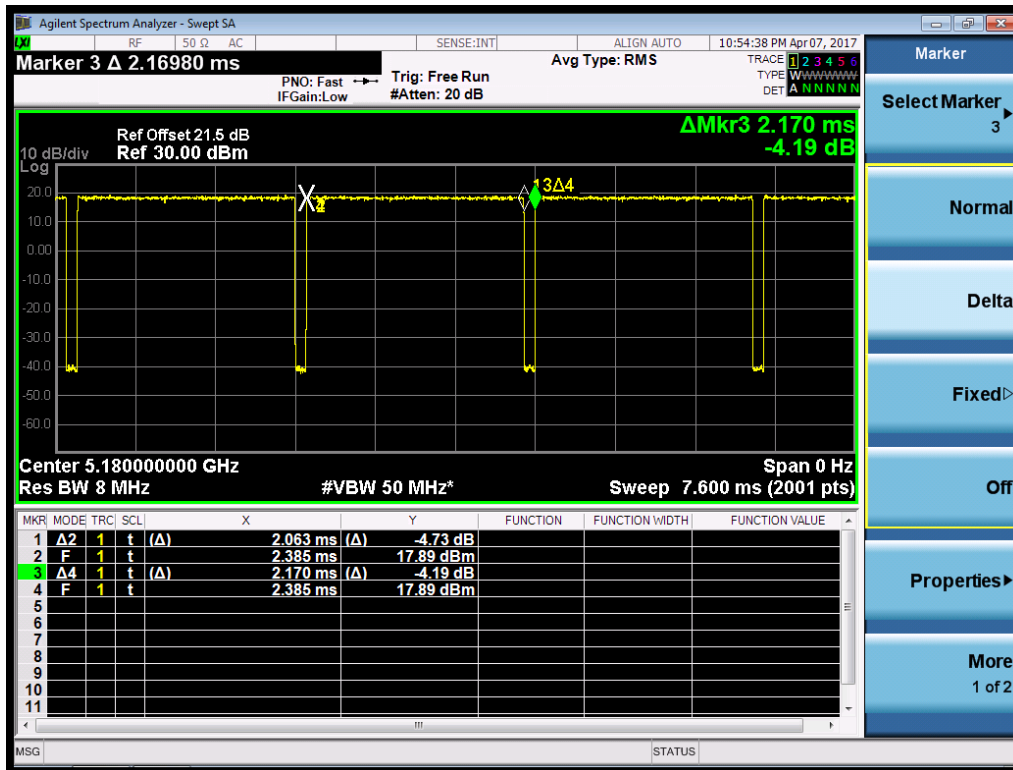

802.11n20

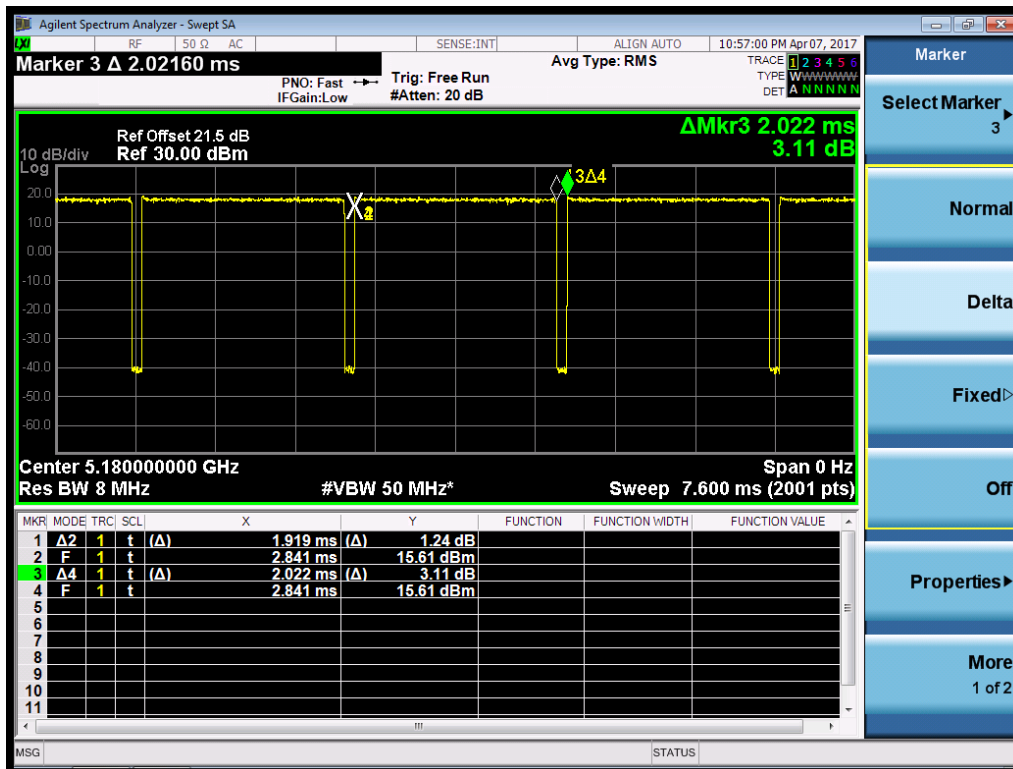

2.3 Test software list

Test Items	Software	Manufacturer	Version
Conducted emission	ESxS-K1	R&S	V2.1.0
Radiated emission	ES-K1	R&S	V1.71

2.4 Test peripherals list

Item No.	Name	Band and Model	Description
1	Laptop computer	HP ProBook 6470b	100-240V AC, 50/60Hz

2.5 Instrument list

Selected	Equipment	Type	Manu.	Internal no.	Cal. Date	Due date
<input checked="" type="checkbox"/>	PXA Analyzer	N9030A	Agilent	EC5338	2017/3/3	2018/3/2
<input checked="" type="checkbox"/>	Vector SG	N5182B	Agilent	EC5175	2017/3/3	2018/3/2
<input checked="" type="checkbox"/>	Power sensor	U2021XA	Agilent	EC5338-1	2017/3/3	2018/3/2
<input checked="" type="checkbox"/>	MXG Analog SG	N5181A	Agilent	EC5338-2	2017/3/3	2018/3/2
<input checked="" type="checkbox"/>	Power meter	N1911A/N1921A	Agilent	EC4318	2016/5/18	2017/5/17
<input checked="" type="checkbox"/>	EMI Receiver	ESCS 30	R&S	EC 2107	2016/10/19	2017/10/18
<input checked="" type="checkbox"/>	A.M.N.	ESH2-Z5	R&S	EC 3119	2015/12/16	2017/12/15
<input checked="" type="checkbox"/>	I.S.N.	FCC-TLISN-T8-02	FCC	EC3756	2017/2/15	2018/2/14
<input checked="" type="checkbox"/>	EMI chamber	3m	Albatross	EC 3048	2016/9/10	2017/9/9
<input checked="" type="checkbox"/>	Test Receiver	ESIB 26	R&S	EC 3045	2016/10/19	2017/10/18
<input checked="" type="checkbox"/>	Test Receiver	ESCI 7	R&S	EC4501	2017/2/23	2018/2/22
<input checked="" type="checkbox"/>	Bilog Antenna	CBL 6112D	TESEQ	EC 4206	2016/6/2	2017/6/1
<input checked="" type="checkbox"/>	Horn antenna	HF 906	R&S	EC 3049	2016/9/24	2017/9/23
<input checked="" type="checkbox"/>	Horn antenna	HAP18-26W	TOYO	EC 4792-3	2016/6/12	2017/6/11
<input checked="" type="checkbox"/>	Pre-amplifier	Pre-amp 18	R&S	EC 5262	2016/6/30	2017/6/29
<input checked="" type="checkbox"/>	Pre-amplifier	Tpa0118-40	R&S	EC 4792-2	2017/4/10	2018/4/9
<input checked="" type="checkbox"/>	Shielded room	-	Zhongyu	EC 2838	2017/1/8	2018/1/7

2.6 Test Summary

This report applies to tested sample only. The test results have been compared directly with the limits, and the measurement uncertainty is recorded. This report shall not be reproduced in part without written approval of Intertek Testing Service Shanghai Limited.

TEST ITEM	FCC REFERANCE	RESULT
Maximum Conducted Output Power	15.407(a)	Pass
Power spectral density	15.407(a)	Pass
Minimum 6dB Bandwidth	15.407(e)	Pass
Radiated emission	15.407 (b) 15.205, 15.209	Pass
Power line conducted emission	15.207	Pass
26 dB Bandwidth & Emission Bandwidth (99%)	15.403(i)	Tested

Notes: 1: NA =Not Applicable

2: This report is for the exclusive use of Intertek's Client and is provided pursuant to the agreement between Intertek and its Client. Intertek's responsibility and liability are limited to the terms and conditions of the agreement. Intertek assumes no liability to any party, other than to the Client in accordance with the agreement, for any loss, expense or damage occasioned by the use of this report. Only the Client is authorized to permit copying or distribution of this report and then only in its entirety. Any use of the Intertek name or one of its marks for the sale or advertisement of the tested material, product or service must first be approved in writing by Intertek. The observations and test results in this report are relevant only to the sample tested. This report by itself does not imply that the material, product, or service is or has ever been under an Intertek certification program.

3 26 dB Bandwidth & Emission Bandwidth (99%)

Test Status: Tested

3.1 Test limit

None

3.2 Test Configuration

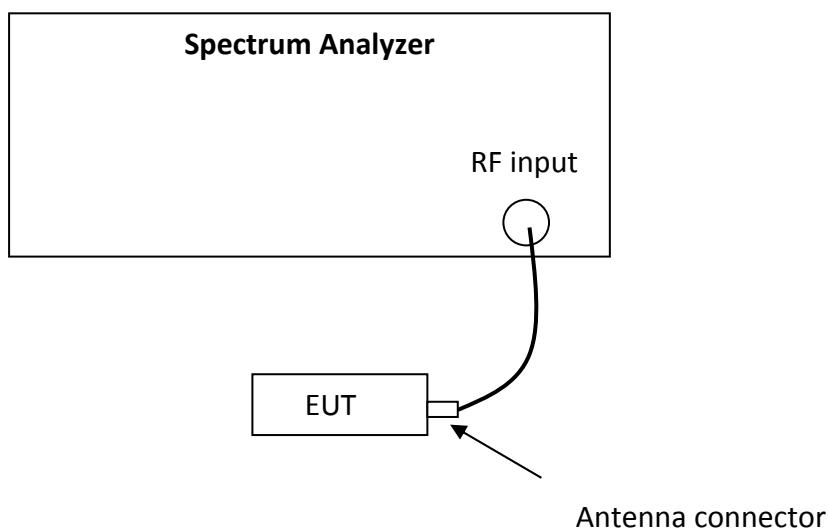

3.3 Test procedure and test setup

The bandwidth was measured from the antenna port of the EUT according to the measurement method refer to KDB 789033D02: section C.

Emission Bandwidth (EBW)

- a) Set RBW = approximately 1% of the emission bandwidth.
- b) Set the VBW > RBW.
- c) Detector = Peak.
- d) Trace mode = max hold.
- e) Measure the maximum width of the emission that is 26 dB down from the maximum of the emission. Compare this with the RBW setting of the analyzer. Readjust RBW and repeat measurement as needed until the RBW/EBW ratio is approximately 1%.

99 Percent Occupied Bandwidth

The following procedure shall be used for measuring (99 %) power bandwidth:

1. Set center frequency to the nominal EUT channel center frequency.
2. Set span = 1.5 times to 5.0 times the OBW.
3. Set RBW = 1 % to 5 % of the OBW
4. Set VBW $\geq 3 \cdot$ RBW
5. Video averaging is not permitted. Where practical, a sample detection and single sweep mode shall be used. Otherwise, peak detection and max hold mode (until the trace stabilizes) shall be used.
6. Use the 99 % power bandwidth function of the instrument (if available).
7. If the instrument does not have a 99 % power bandwidth function, the trace data points are recovered and directly summed in power units. The recovered amplitude data points, beginning at the lowest frequency, are placed in a running sum until 0.5 % of the total is reached; that frequency is recorded as the lower frequency. The process is repeated until 99.5 % of the total is reached; that frequency is recorded as the upper frequency. The 99% occupied bandwidth is the difference between these two frequencies.

3.4 Test protocol

Temperature : 25 °C
Relative Humidity : 55 %

Frequency Band	Mode	Frequency (MHz)	26 dB Bandwidth (MHz)	99% Bandwidth (MHz)
U-NII 1	802.11a	5180	21.26	16.733
		5220	21.18	16.703
		5240	20.79	16.712
	802.11n20	5180	21.39	17.864
		5220	21.38	17.836
		5240	21.35	17.866
	802.11n40	5190	39.91	36.306
		5230	39.69	36.292
	802.11ac80	5210	79.91	75.049

Test Plots:

802.11a-5180MHz

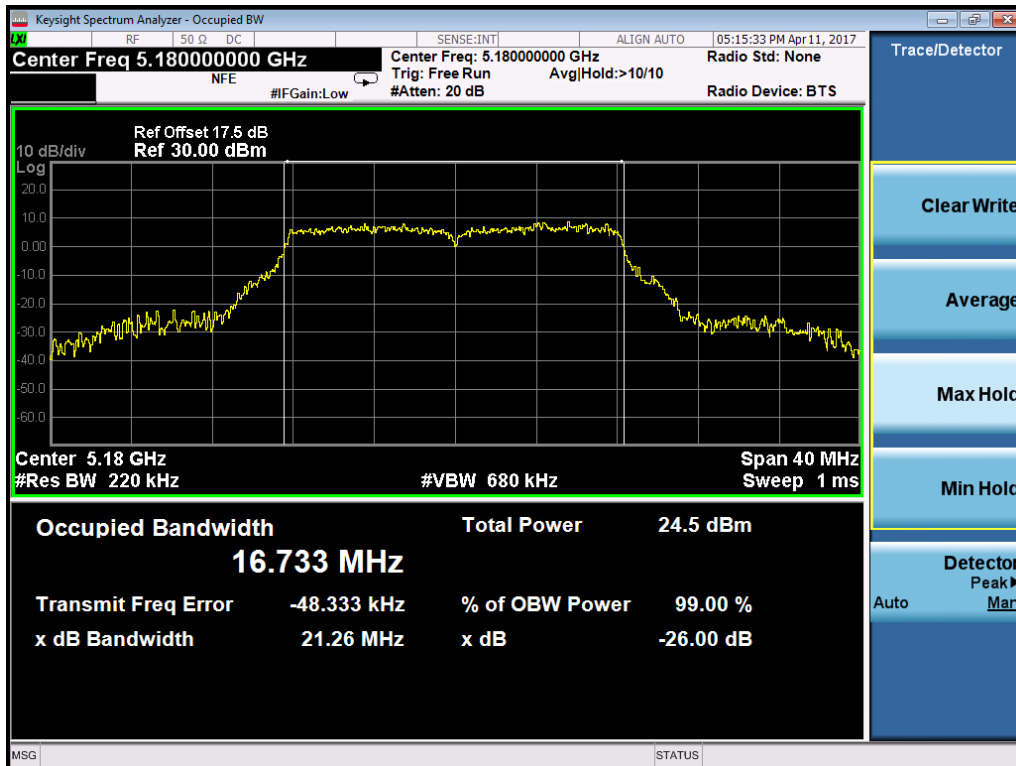

802.11a-5220MHz

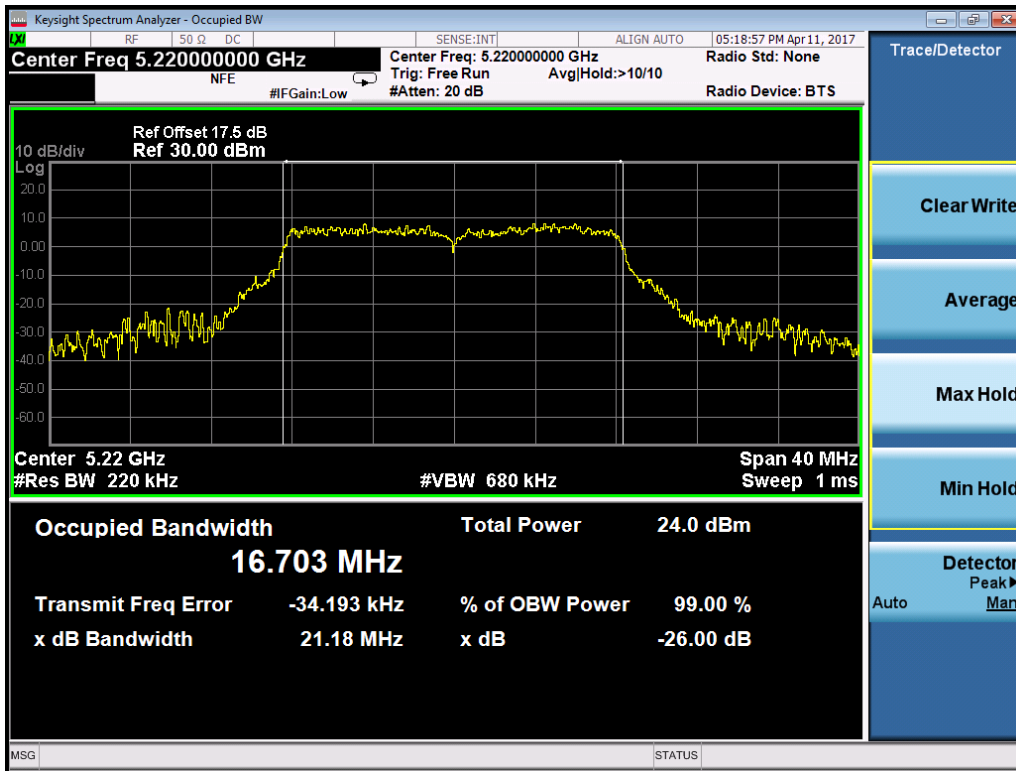

802.11a-5240MHz

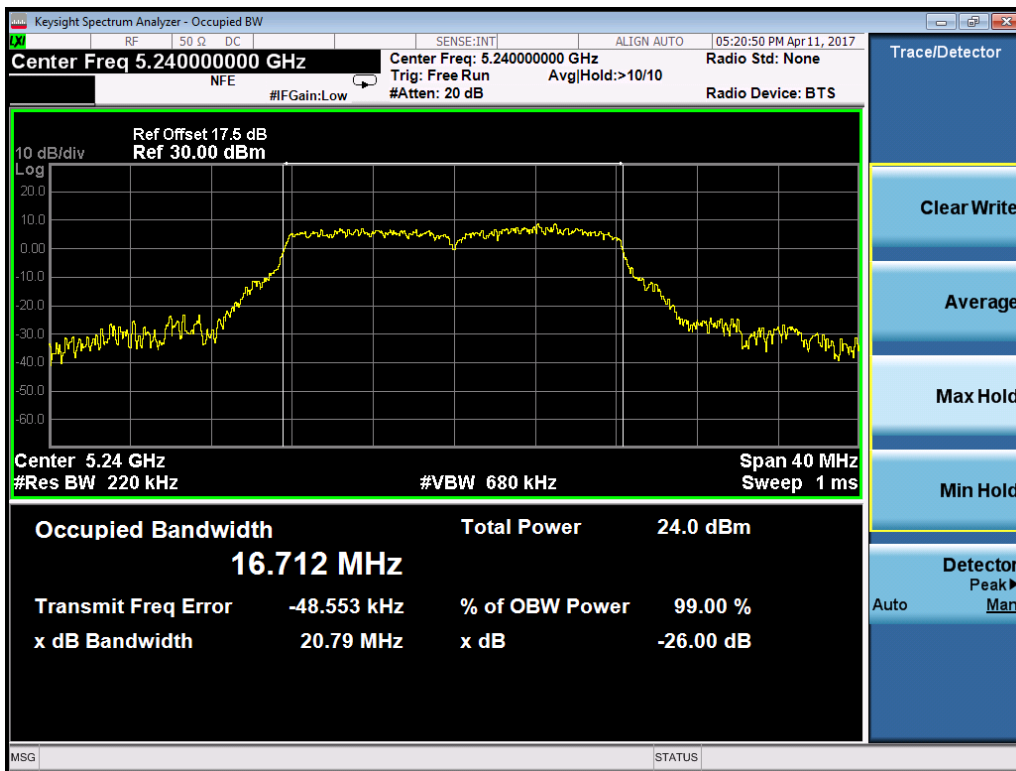

802.11n20-5180MHz

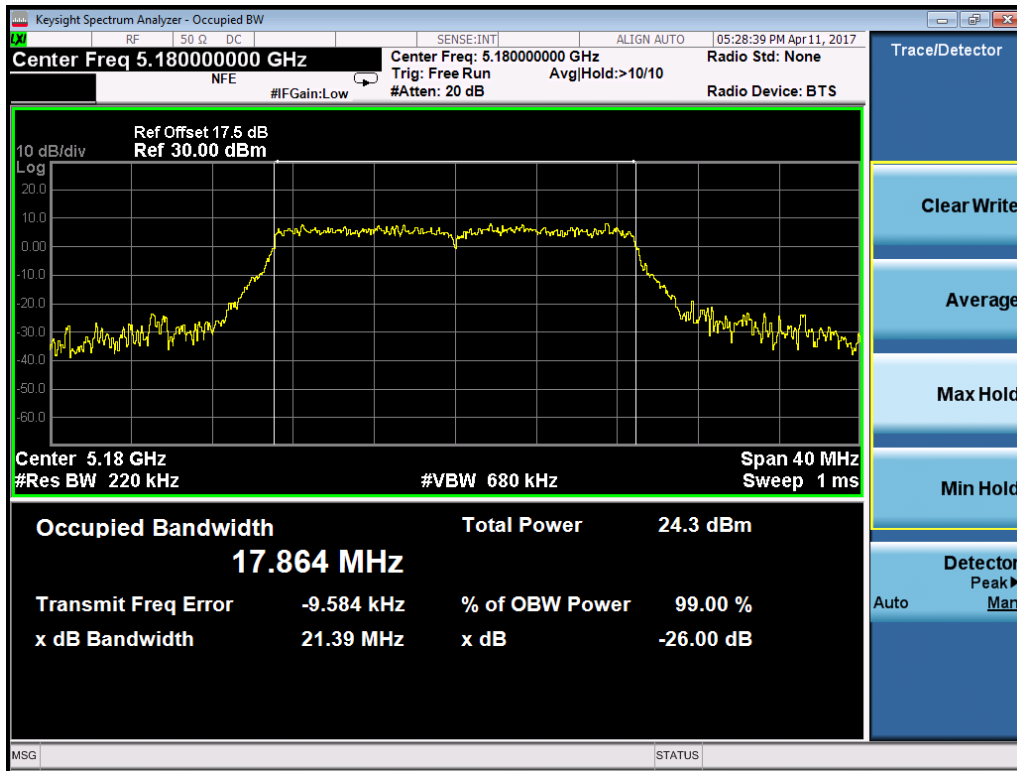

802.11n20-5220MHz

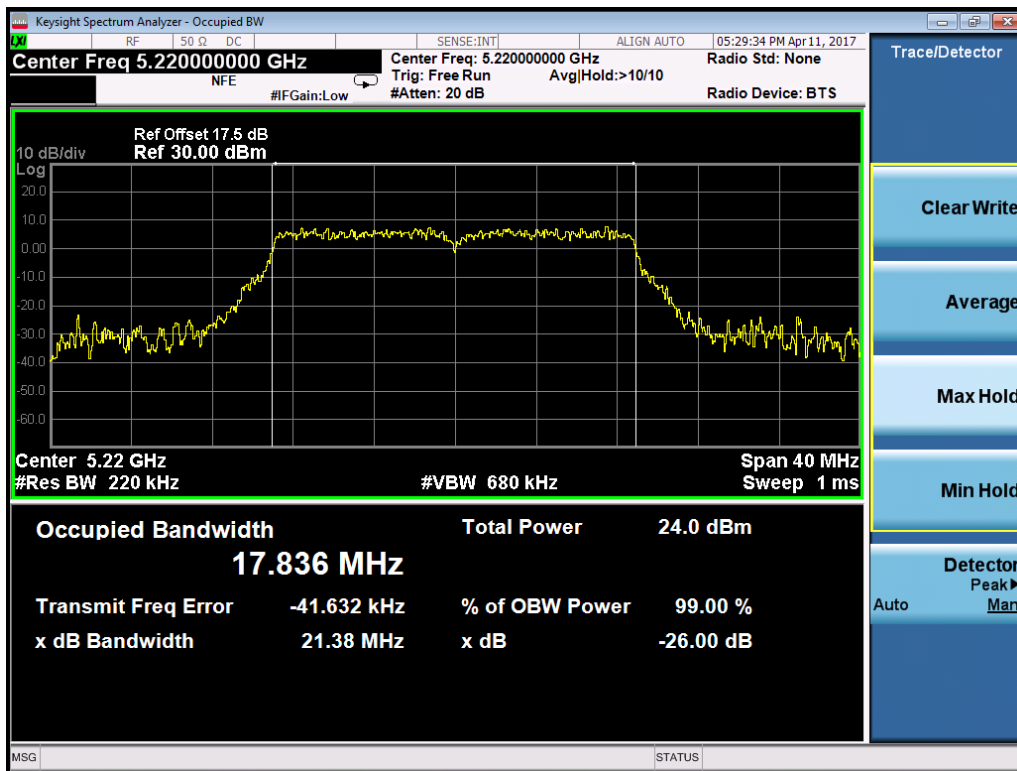

802.11n20-5240MHz

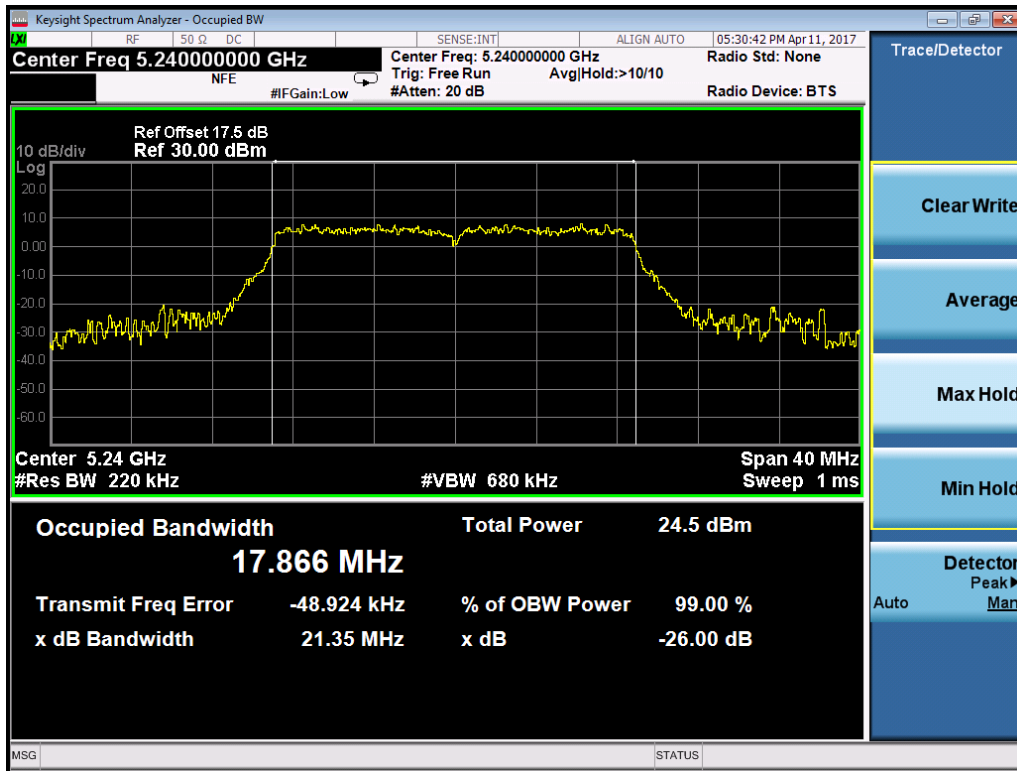

802.11n40-5190MHz

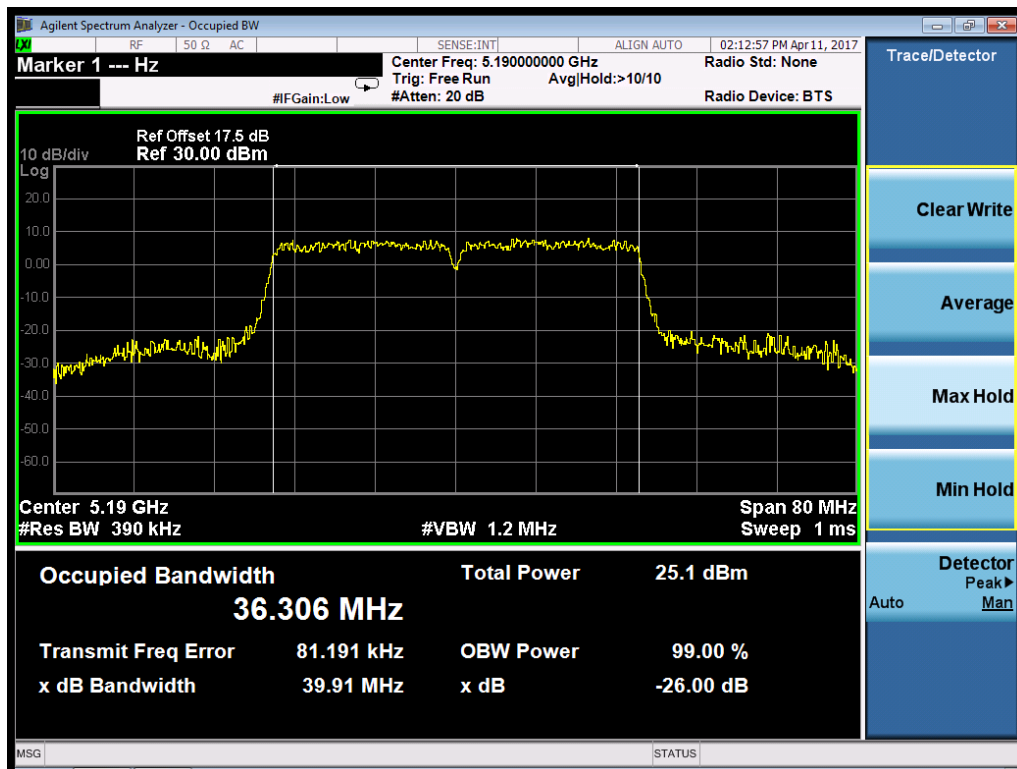

802.11n40-5230MHz

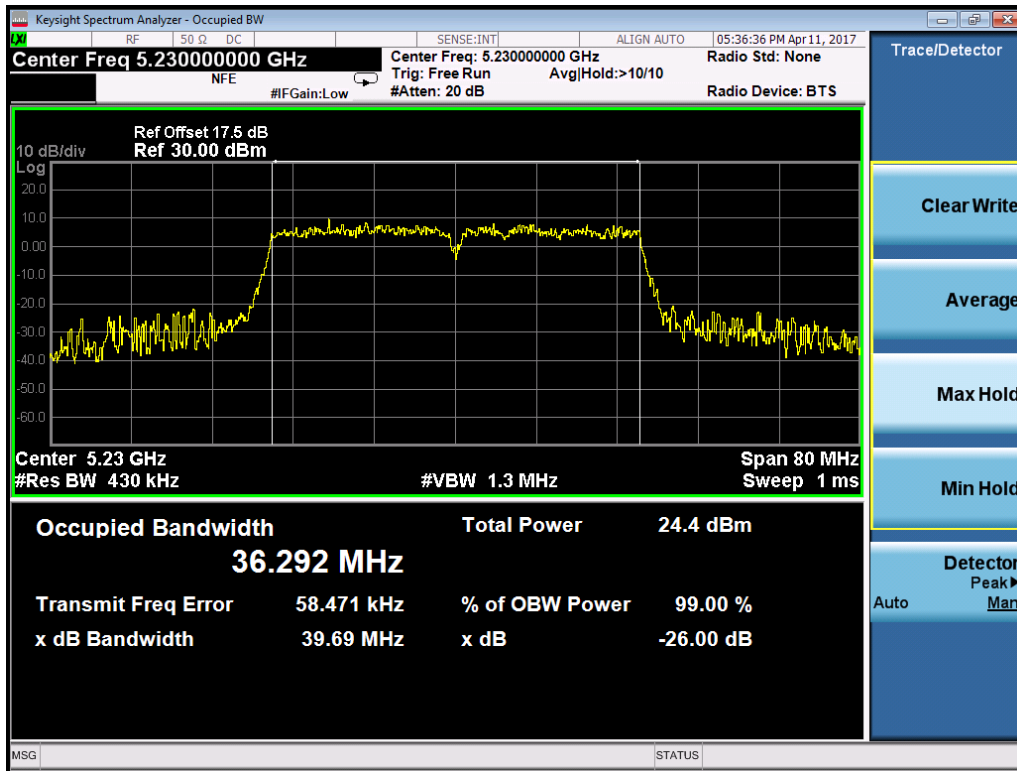

802.11ac80-5210MHz

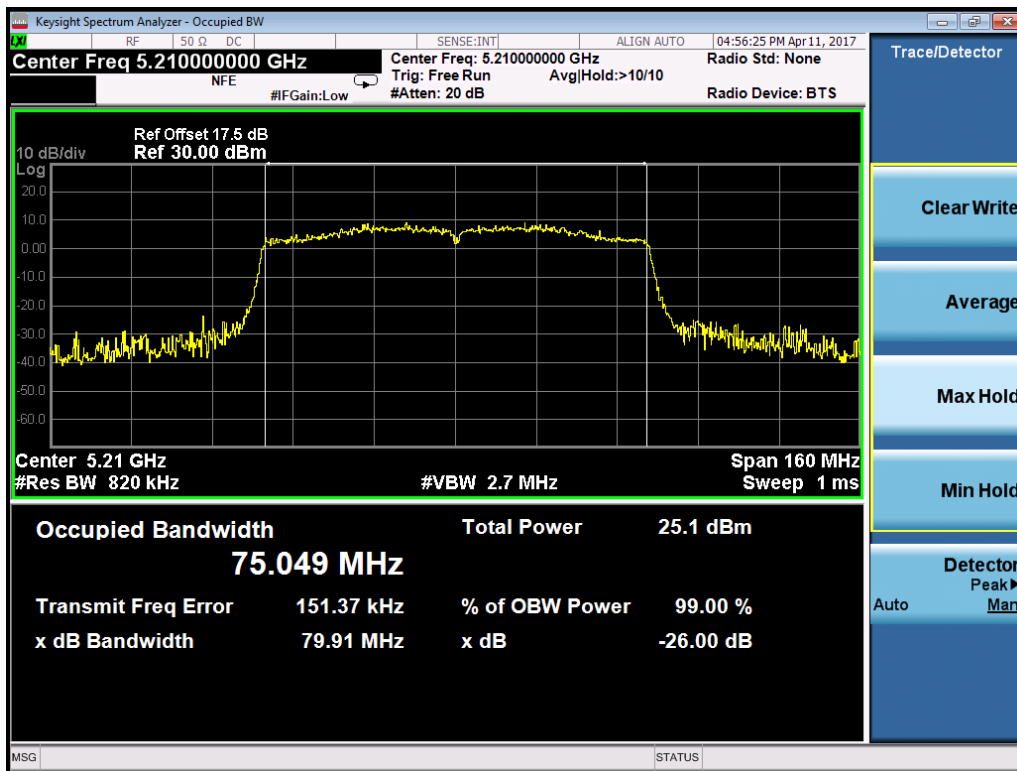

4 Maximum Conducted Output Power

Test result: Pass

4.1 Test limit

For an outdoor access point operating in the band 5.15-5.25 GHz, the maximum conducted output power over the frequency band of operation shall not exceed 1 W provided the maximum antenna gain does not exceed 6 dBi.

The maximum e.i.r.p.at any elevation angle above 30 degrees from the horizon must not exceed 125 mW (21 dBm).

For an indoor access point operating in the band 5.15-5.25 GHz, the maximum conducted output power over the frequency band of operation shall not exceed 1 W provided the maximum antenna gain does not exceed 6 dBi.

For fixed point-to-point access points operating in the band 5.15-5.25 GHz, the maximum conducted output power over the frequency band of operation shall not exceed 1 W.

For mobile and portable client devices in the 5.15-5.25 GHz band, the maximum conducted output power over the frequency band of operation shall not exceed 250 mW provided the maximum antenna gain does not exceed 6 dBi.

For the 5.25-5.35 GHz and 5.47-5.725 GHz bands, the maximum conducted output power over the frequency bands of operation shall not exceed the lesser of 250 mW or $11 \text{ dBm} + 10 \log B$, where B is the 26 dB emission bandwidth in megahertz.

For the band 5.725-5.85 GHz, the maximum conducted output power over the frequency band of operation shall not exceed 1 W.

If transmitting antennas of directional gain greater than 6dBi are used, the maximum conducted output power shall be reduced by the amount in dB that the directional gain of the antenna exceeds 6dBi.

4.2 Test Configuration

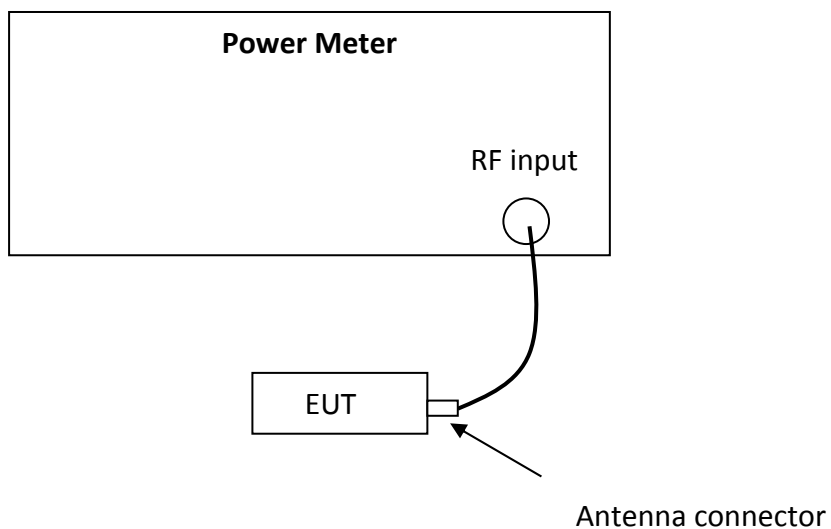

4.3 Test procedure and test setup

The power output per FCC §15.407(a) was measured from the antenna port of the EUT according to the measurement method refer to KDB 789033D02: Method PM.

4.4 Test protocol

Temperature : 25 °C
Relative Humidity : 55 %

U-NII-1 Band Conducted Power:

Mode	Frequency (MHz)	Corrected Reading + Duty cycle factor (dBm)				Max Power (dBm)	Limit (dBm)
		Port 0	Port 1	Port 2	Port 3		
802.11 a	5180	20.04	21.15	21.31	21.94	21.94	30.00
	5200	21.84	22.71	23.07	23.51	23.51	30.00
	5240	21.82	22.76	23.04	23.61	23.61	30.00

Mode	Frequency (MHz)	Corrected Reading + Duty cycle factor (dBm)				Total Power (dBm)	Limit (dBm)
		Port 0	Port 1	Port 2	Port 3		
802.11n20	5180	20.50	21.22	21.31	22.14	27.35	30.00
	5200	22.18	22.92	22.90	24.01	29.07	30.00
	5240	22.17	22.90	22.91	23.83	29.01	30.00
802.11n40	5190	17.36	18.01	17.96	18.86	24.10	30.00
	5230	22.86	23.33	23.47	24.49	29.60	30.00
802.11ac80	5210	16.78	17.54	17.84	18.45	23.71	30.00

Note: Total power = $10 * \lg(10^{\text{port 0} / 10} + 10^{\text{port 1} / 10} + 10^{\text{port 2} / 10} + 10^{\text{port 3} / 10})$.

U-NII-3 Band Conducted Power:

Mode	Frequency (MHz)	Corrected Reading + Duty cycle factor (dBm)				Max Power (dBm)	Limit (dBm)
		Port 0	Port 1	Port 2	Port 3		
802.11 a	5745	20.41	21.19	21.57	21.16	21.57	30.00
	5785	20.14	21.08	21.51	21.04	21.51	30.00
	5825	20.12	20.65	21.13	20.81	21.13	30.00

Mode	Frequency (MHz)	Corrected Reading + Duty cycle factor (dBm)				Total Power (dBm)	Limit (dBm)
		Port 0	Port 1	Port 2	Port 3		
802.11n20	5745	20.83	20.65	20.97	21.21	26.94	30.00
	5785	20.73	20.28	21.05	21.14	26.83	30.00
	5825	20.26	20.38	20.83	21.04	26.66	30.00
802.11n40	5755	21.36	21.27	21.27	21.85	27.46	30.00
	5795	20.79	20.94	21.21	21.54	27.15	30.00
802.11ac80	5775	19.05	19.61	19.74	20.21	25.69	30.00

Note: Total power = $10 * \lg(10^{\text{port 0} / 10} + 10^{\text{port 1} / 10} + 10^{\text{port 2} / 10} + 10^{\text{port 3} / 10})$.

5 Power spectrum density

Test result: Pass

5.1 Test limit

For an outdoor access point operating in the band 5.15-5.25 GHz, the maximum power spectral density shall not exceed 17 dBm in any 1 megahertz band.

For an indoor access point operating in the band 5.15-5.25 GHz, the maximum power spectral density shall not exceed 17 dBm in any 1 megahertz band.

For mobile and portable client devices in the 5.15-5.25 GHz band, the maximum power spectral density shall not exceed 11 dBm in any 1 megahertz band.

For the 5.25-5.35 GHz and 5.47-5.725 GHz bands, the maximum power spectral density shall not exceed 11 dBm in any 1 megahertz band.

For the band 5.725-5.85 GHz, the maximum power spectral density shall not exceed 30 dBm in any 500 kHz band.

If the transmitting antenna of directional gain greater than 6dBi is used, the power shall be reduced by the amount in dB that the directional gain of the antenna exceeds 6dBi. If there have a beam forming type, the limit should be the less of original and original + (6 - antenna gain - beamforming gain).

5.2 Test Configuration

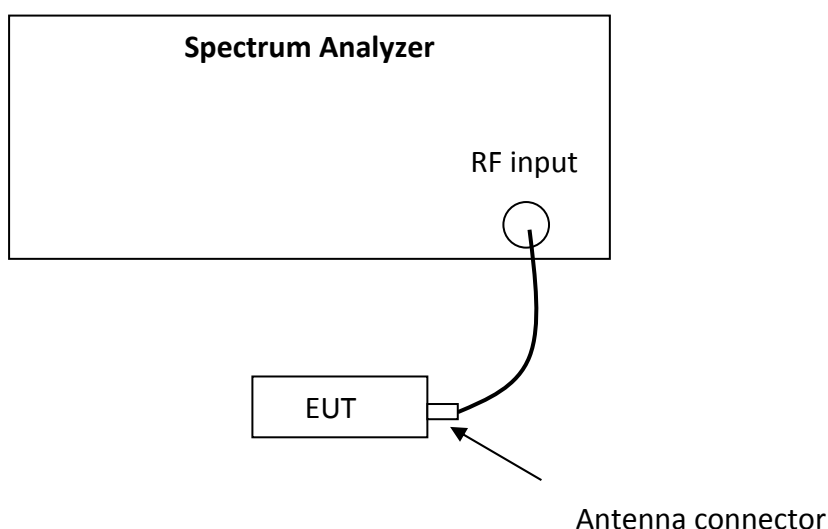

5.3 Test procedure and test setup

The power spectral density per FCC §15.407(a) was measured from the antenna port of the EUT according to the measurement method refer to KDB 789033D02: section F.

1. Create an average power spectrum for the EUT operating mode being tested by following the instructions in section II.E.2. for measuring maximum conducted output power using a spectrum analyzer or EMI receiver: select the appropriate test method (SA-1, SA-2, SA-3, or alternatives to each) and apply it up to, but not including, the step labeled, "Compute power...". (This procedure is required even if the maximum conducted output power measurement was performed using a power meter, method PM.)
2. Use the peak search function on the instrument to find the peak of the spectrum and record its value.
3. Make the following adjustments to the peak value of the spectrum, if applicable: a) If Method SA-2 or SA-2 Alternative was used, add $10 \log(1/x)$, where x is the duty cycle, to the peak of the spectrum. b) If Method SA-3 Alternative was used and the linear mode was used in step II.E.2.g)(viii), add 1 dB to the final result to compensate for the difference between linear averaging and power averaging.
4. The result is the Maximum PSD over 1 MHz reference bandwidth.
5. For devices operating in the bands 5.15-5.25 GHz, 5.25-5.35 GHz, and 5.47-5.725 GHz, the above procedures make use of 1 MHz RBW to satisfy directly the 1 MHz reference bandwidth specified in § 15.407(a)(5). For devices operating in the band 5.725-5.85 GHz, the rules specify a measurement bandwidth of 500 kHz. Many spectrum analyzers do not have 500 kHz RBW, thus a narrower RBW may need to be used. The rules permit the use of a RBWs less than 1 MHz, or 500 kHz, "provided that the measured power is integrated over the full reference bandwidth" to show the total power over the specified measurement bandwidth (*i.e.*, 1 MHz, or 500 kHz). If measurements are performed using a reduced resolution bandwidth (< 1 MHz, or < 500 kHz) and integrated over 1 MHz, or 500 kHz bandwidth, the following adjustments to the procedures apply:
 - a) Set $RBW \geq 1/T$, where T is defined in section II.B.I.a).
 - b) Set $VBW \geq 3 RBW$.
 - c) If measurement bandwidth of Maximum PSD is specified in 500 kHz, add $10 \log(500 \text{ kHz} / RBW)$ to the measured result, whereas $RBW (< 500 \text{ kHz})$ is the reduced resolution bandwidth of the spectrum analyzer set during measurement.
 - d) If measurement bandwidth of Maximum PSD is specified in 1 MHz, add $10 \log(1 \text{ MHz} / RBW)$ to the measured result, whereas $RBW (< 1 \text{ MHz})$ is the reduced resolution bandwidth of spectrum analyzer set during measurement.
 - e) Care must be taken to ensure that the measurements are performed during a period of continuous transmission or are corrected upward for duty cycle.

Note: As a practical matter, it is recommended to use reduced RBW of 100 kHz for the sections 5.c) and 5.d) above, since $RBW=100 \text{ kHz}$ is available on nearly all spectrum analyzers.

5.4 Test Protocol

Temperature: 25 °C
Relative Humidity: 55 %

U-NII-1 Band:

Mode	Frequency (MHz)	Duty cycle Factor (dB)	Corrected Reading + Duty cycle factor (dBm/MHz)				Max Power (dBm/MHz)	Limit (dBm/MHz)
			Port0	Port1	Port2	Port3		
802.11 a	5180	0.22	-	-	10.16	-	10.16	17.00
	5220	0.22	-	-	11.40	-	11.40	17.00
	5240	0.22	-	-	11.15	-	11.15	17.00

Note: The port 2 was chosen to test as representative.

Mode	Frequency (MHz)	Duty cycle Factor (dB)	Corrected Reading (dBm/MHz)				Total Power (dBm/MHz)	Limit (dBm/MHz)
			Port0	Port1	Port2	Port3		
802.11n20	5180	0.23	7.27	8.21	8.45	9.16	14.57	17.00
	5220	0.23	9.32	9.97	10.23	10.98	16.41	17.00
	5240	0.23	9.55	10.27	10.63	10.95	16.63	17.00
802.11n40	5190	0.44	1.06	1.72	1.58	3.10	8.40	17.00
	5230	0.44	7.23	7.98	7.84	9.09	14.55	17.00
802.11ac80	5210	0.74	-1.18	-0.43	-0.74	0.30	6.28	17.00

Note: Total power = $10 * \lg(10^{\text{port 0} / 10} + 10^{\text{port 1} / 10} + 10^{\text{port 2} / 10} + 10^{\text{port 3} / 10}) + \text{Duty cycle factor}$.

Test Plots:

802.11a-5180MHz

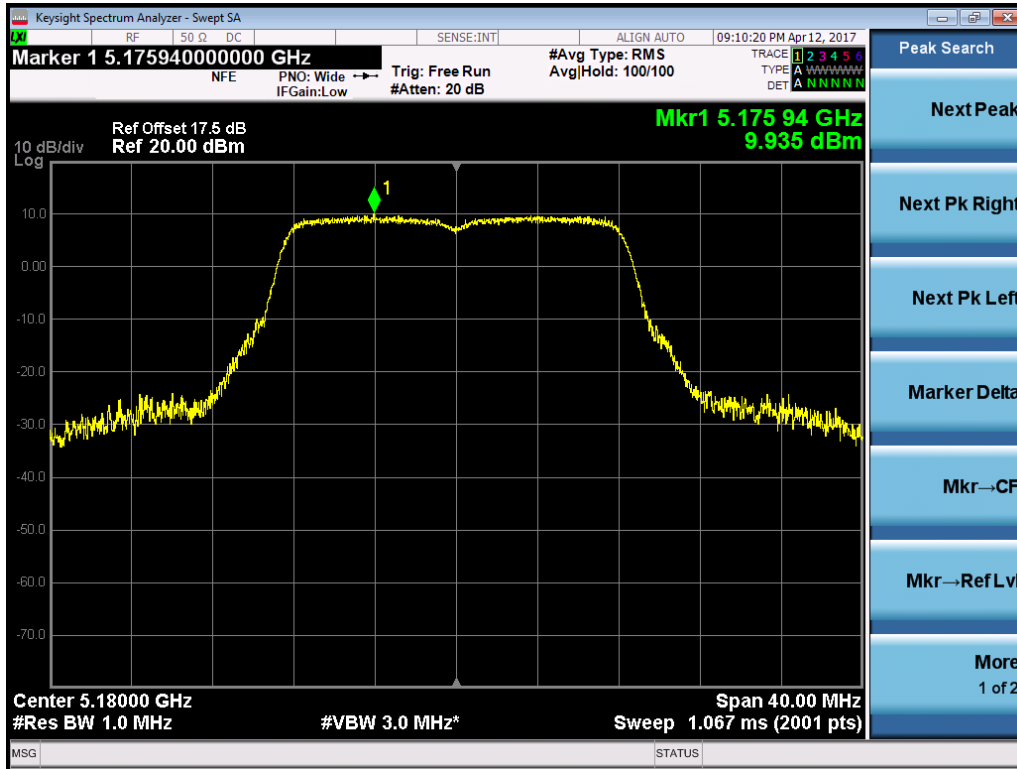

802.11a-5220MHz

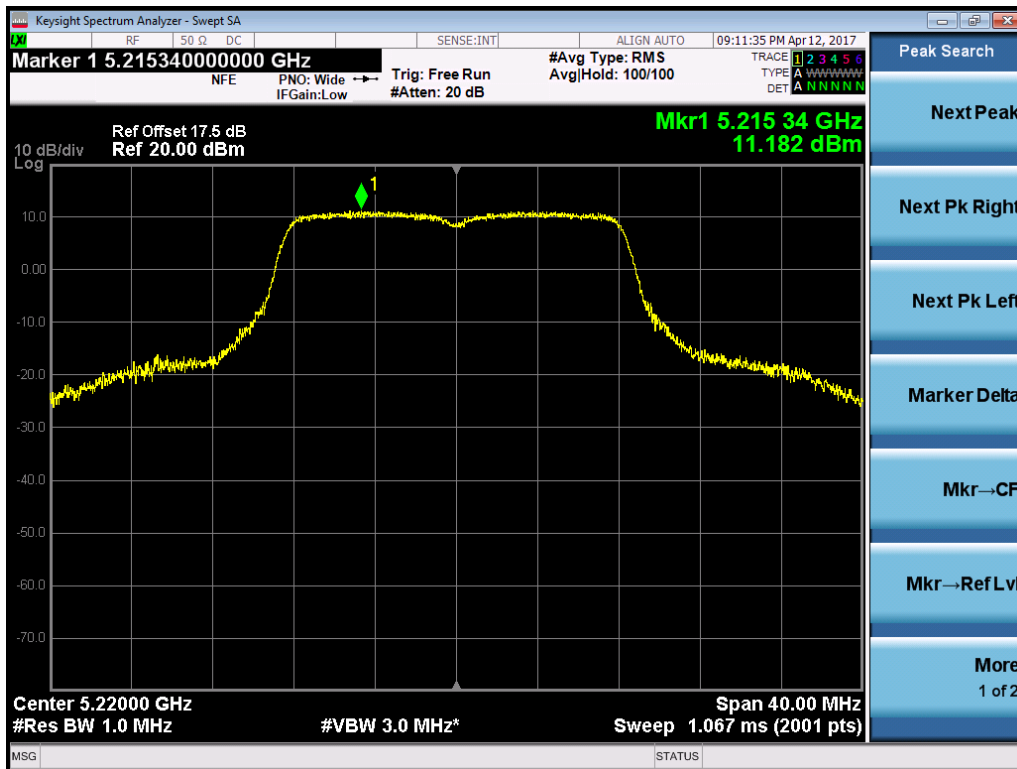

802.11a-5240MHz

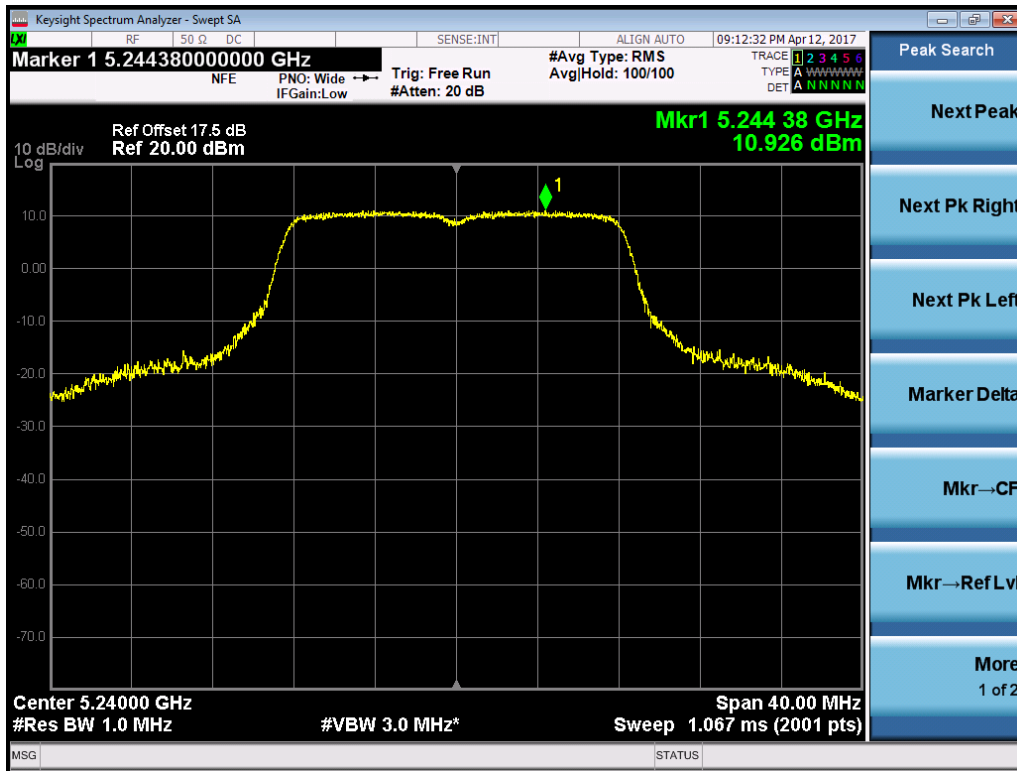

Antenna port 0

802.11n20-5180MHz

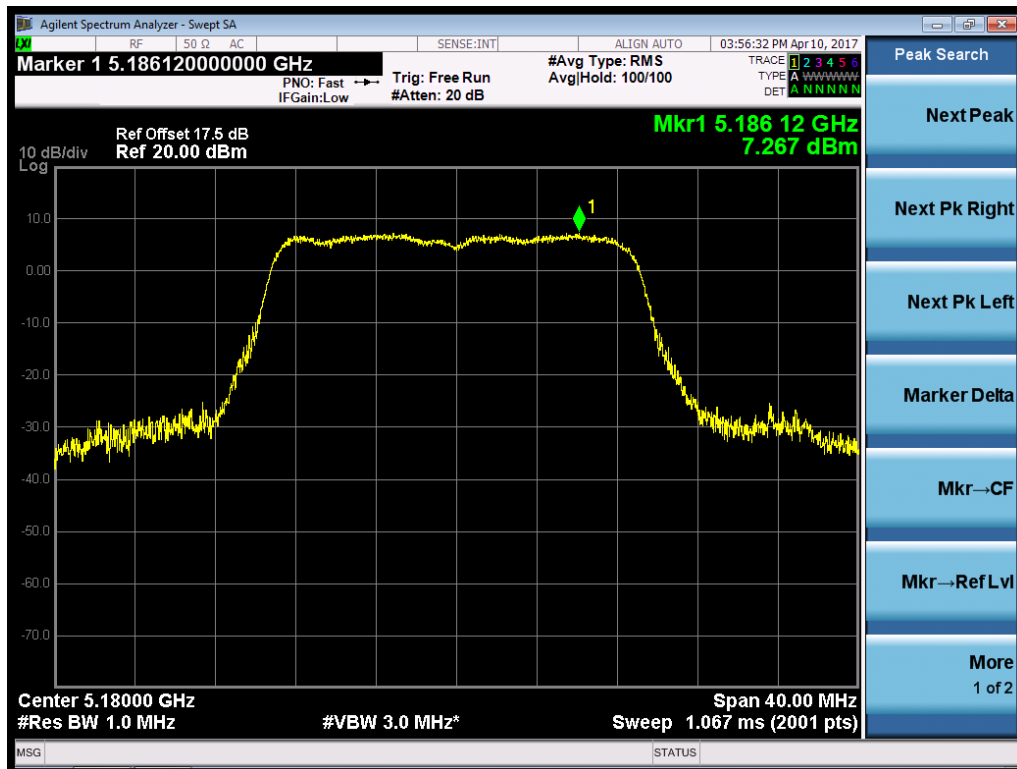

802.11n20-5220MHz

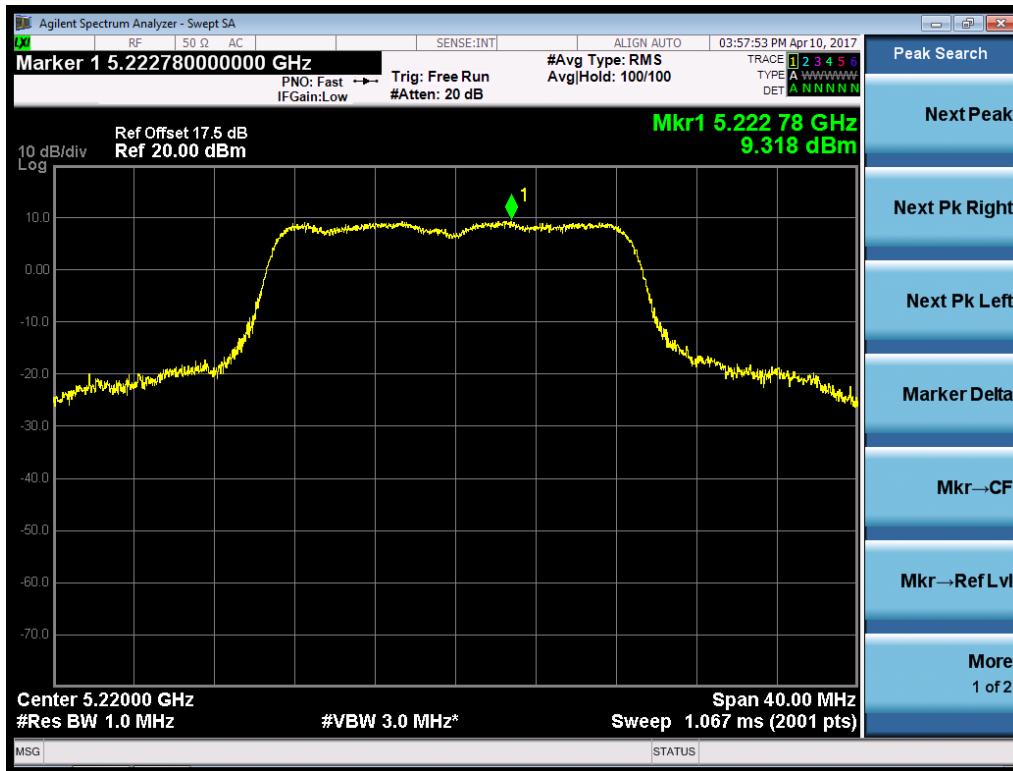

802.11n20-5240MHz



802.11n40-5190MHz

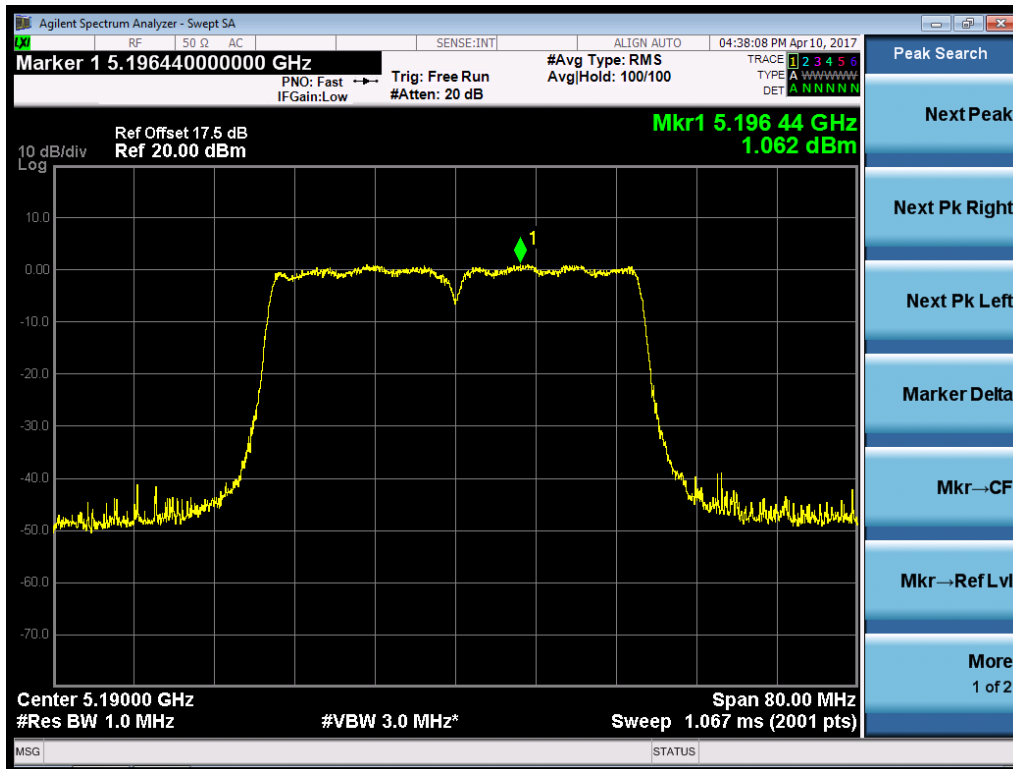

802.11n40-5230MHz



802.11ac80-5210MHz

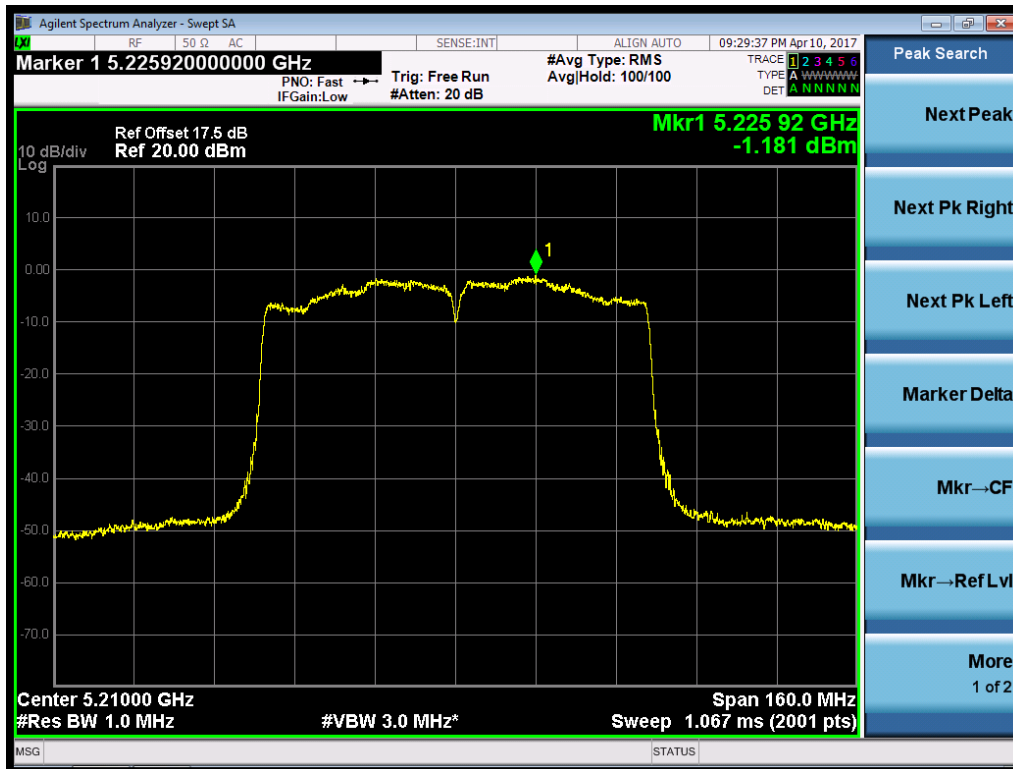

Antenna port 1

802.11n20-5180MHz



802.11n20-5220MHz

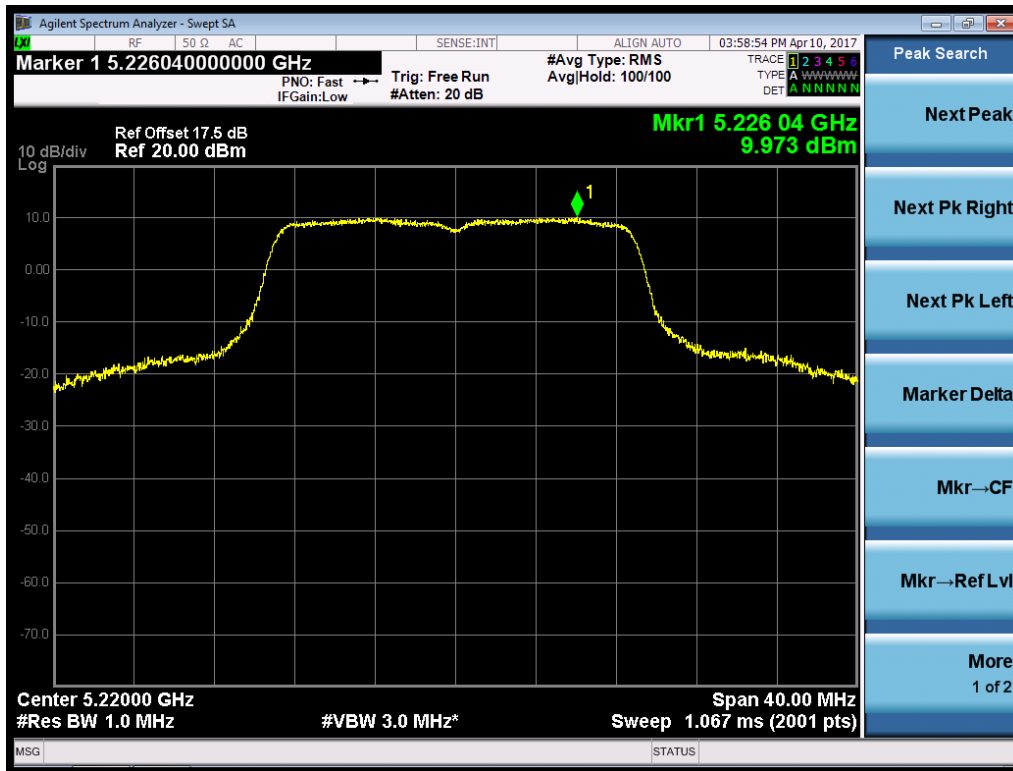

802.11n20-5240MHz

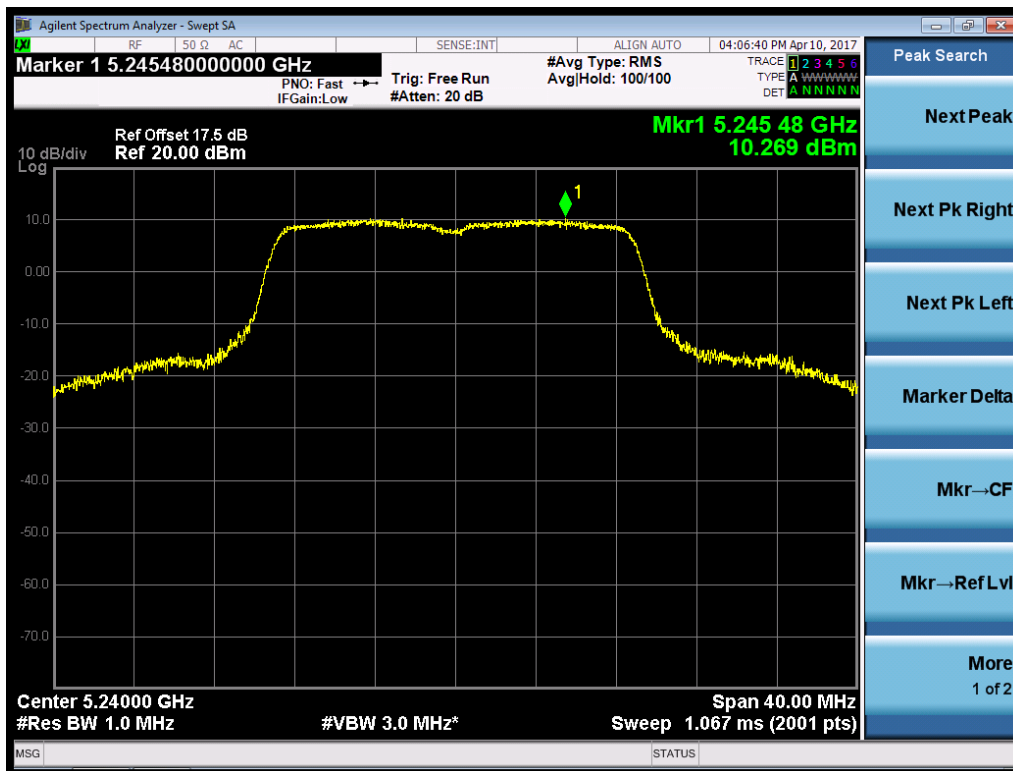

802.11n40-5190MHz

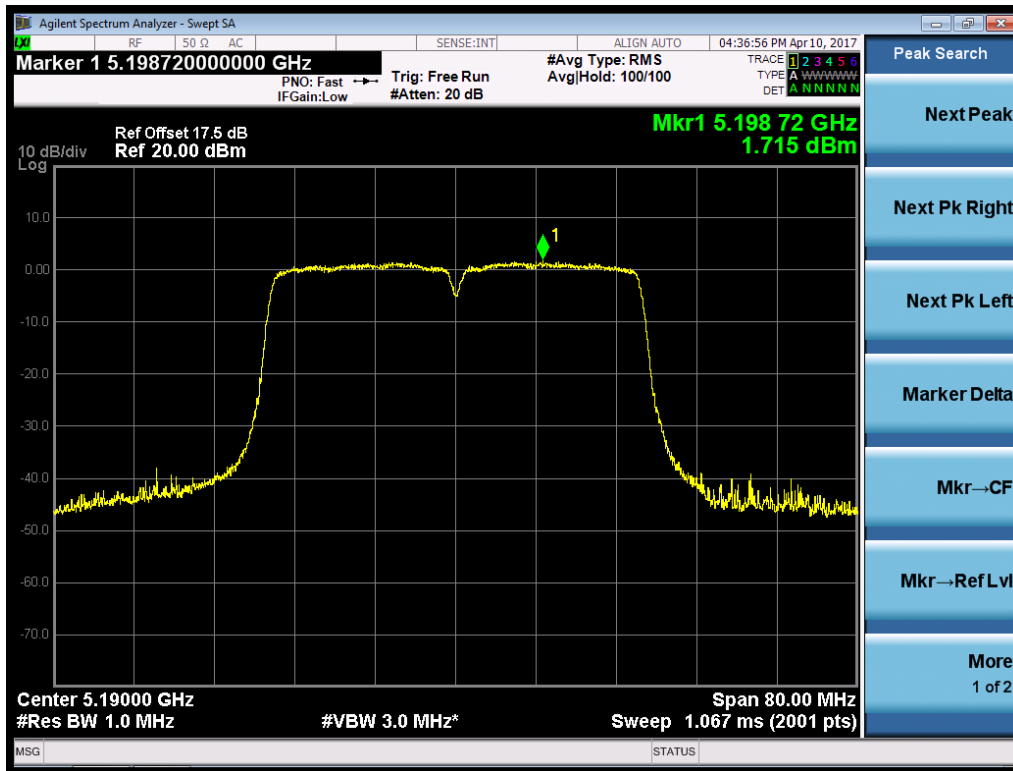

802.11n40-5230MHz

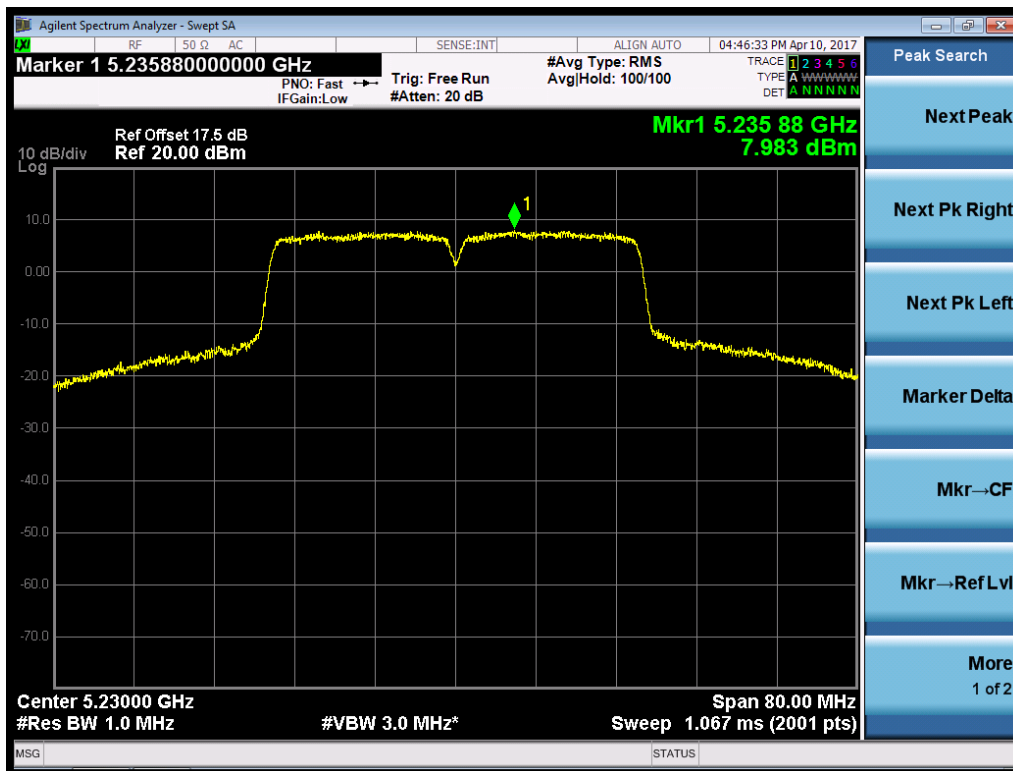

802.11ac80-5210MHz

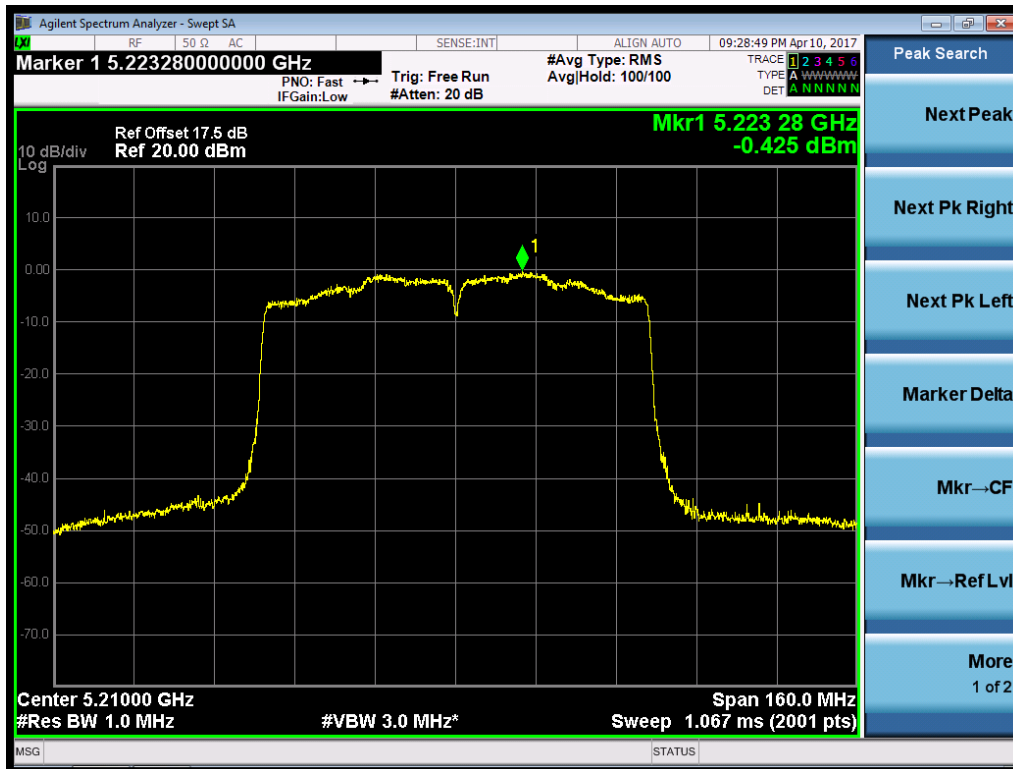

Antenna port 2

802.11n20-5180MHz

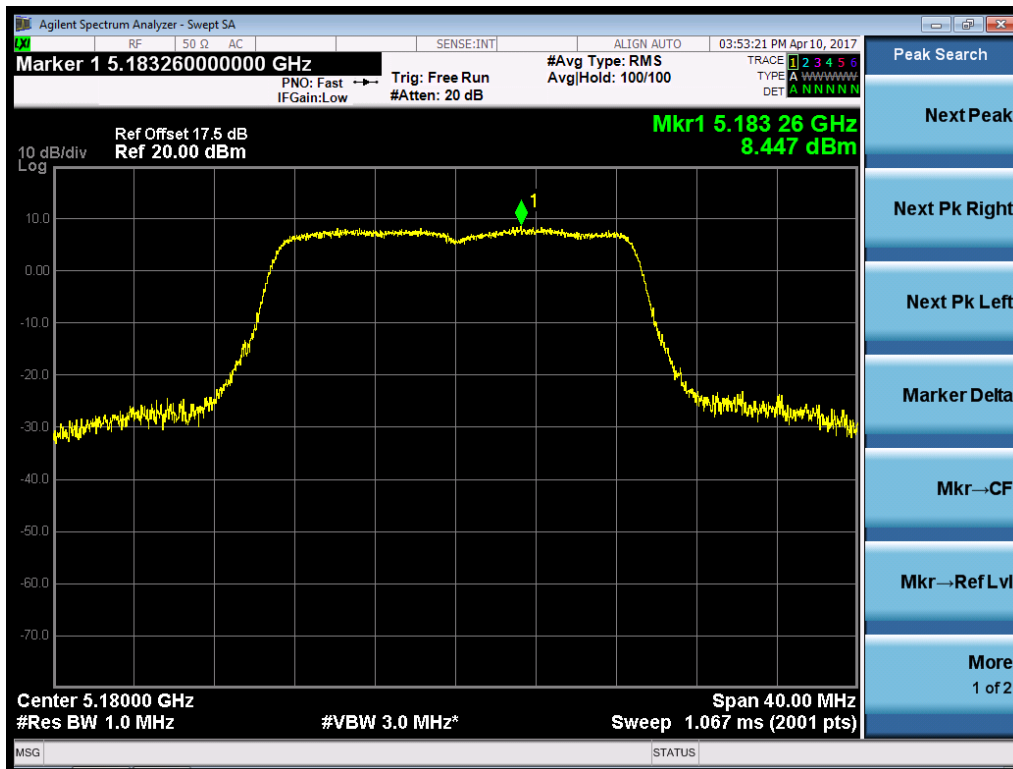

802.11n20-5220MHz

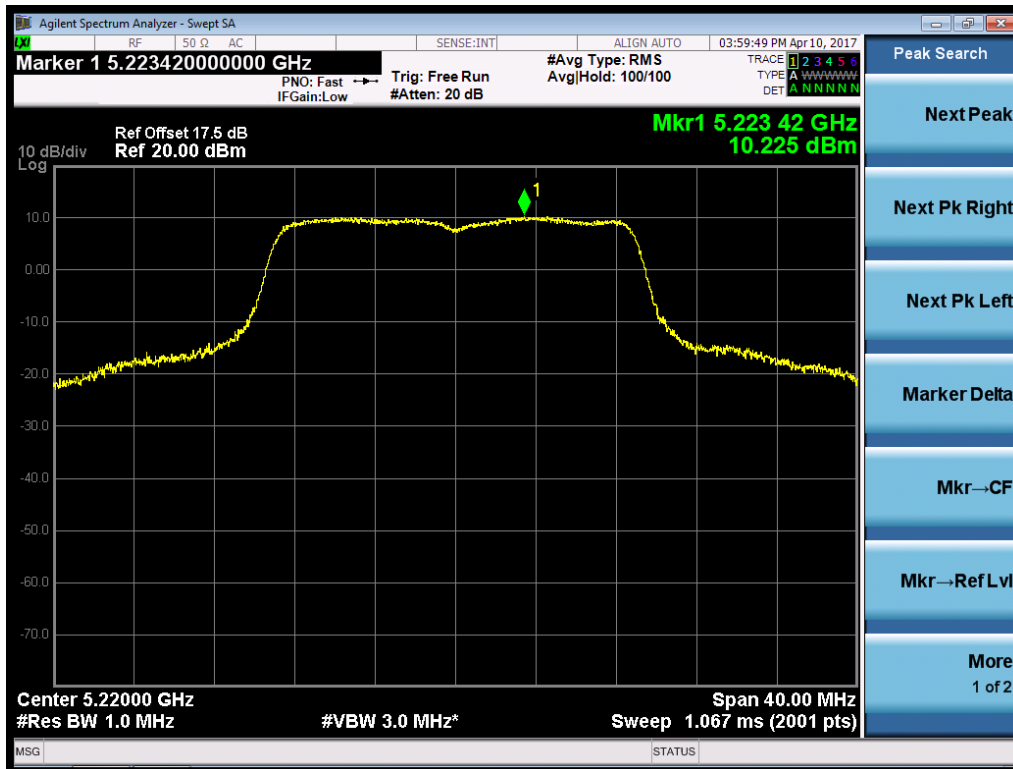

802.11n20-5240MHz

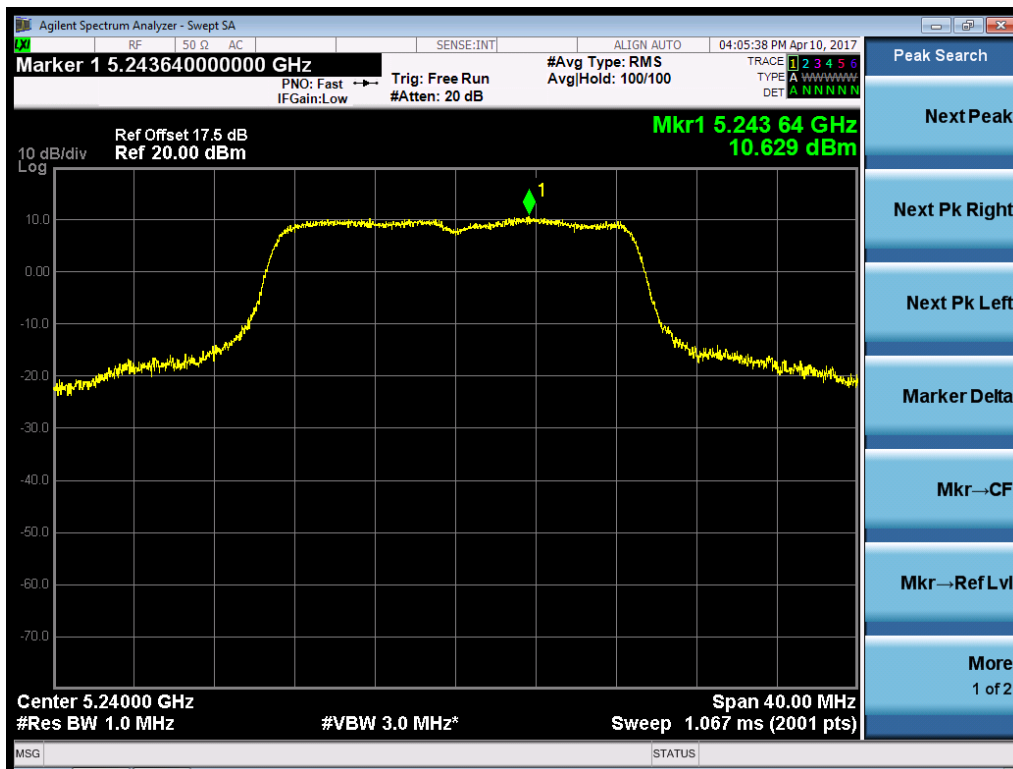

802.11n40-5190MHz

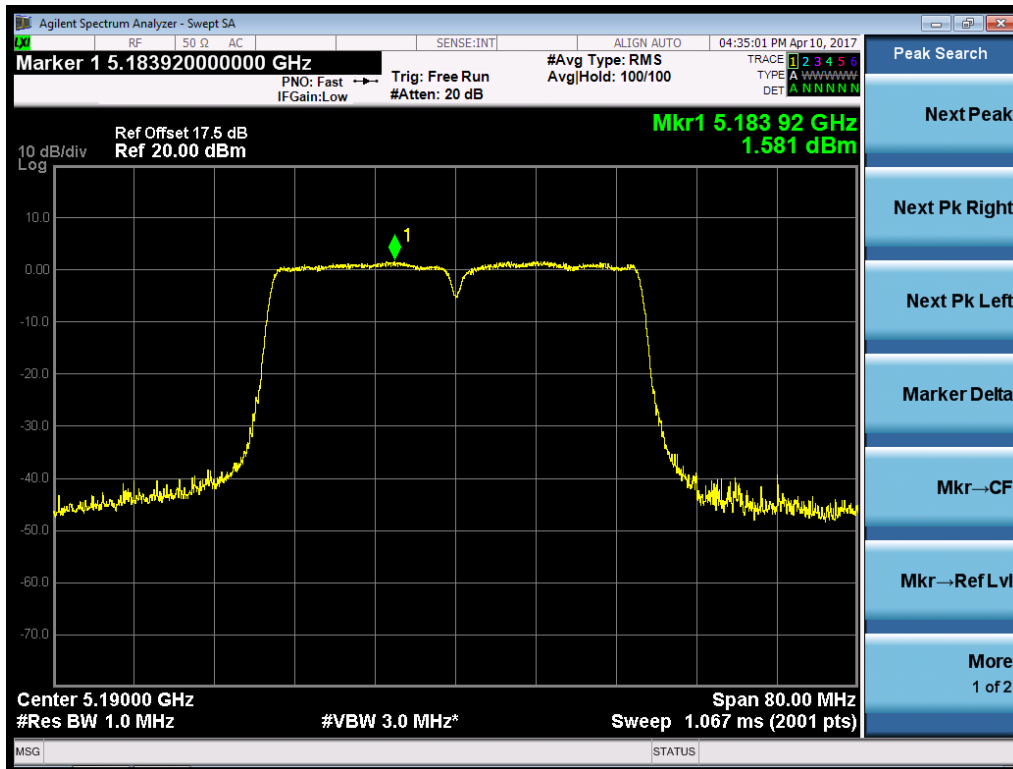

802.11n40-5230MHz



802.11ac80-5210MHz

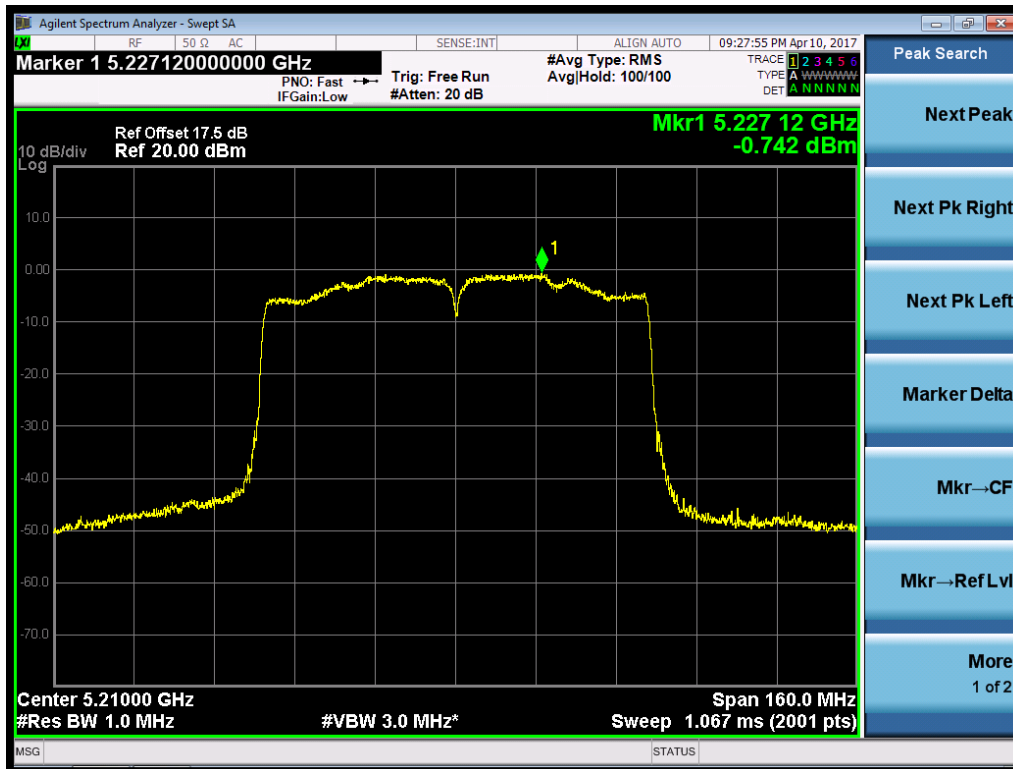

Antenna port 3

802.11n20-5180MHz

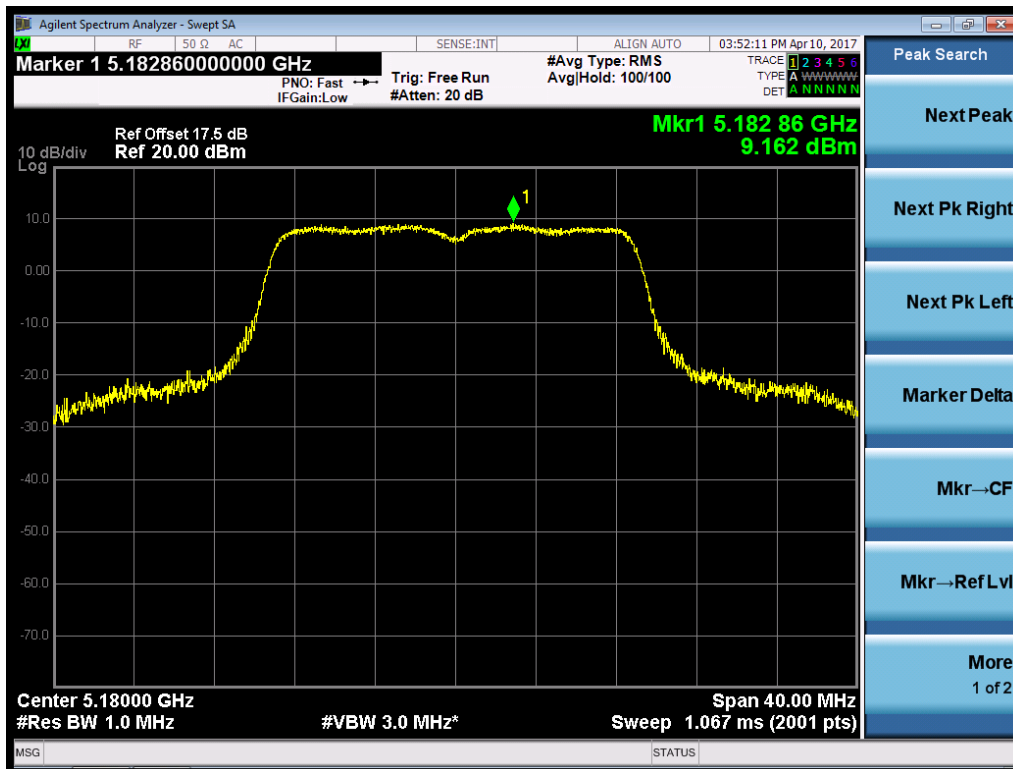

802.11n20-5220MHz

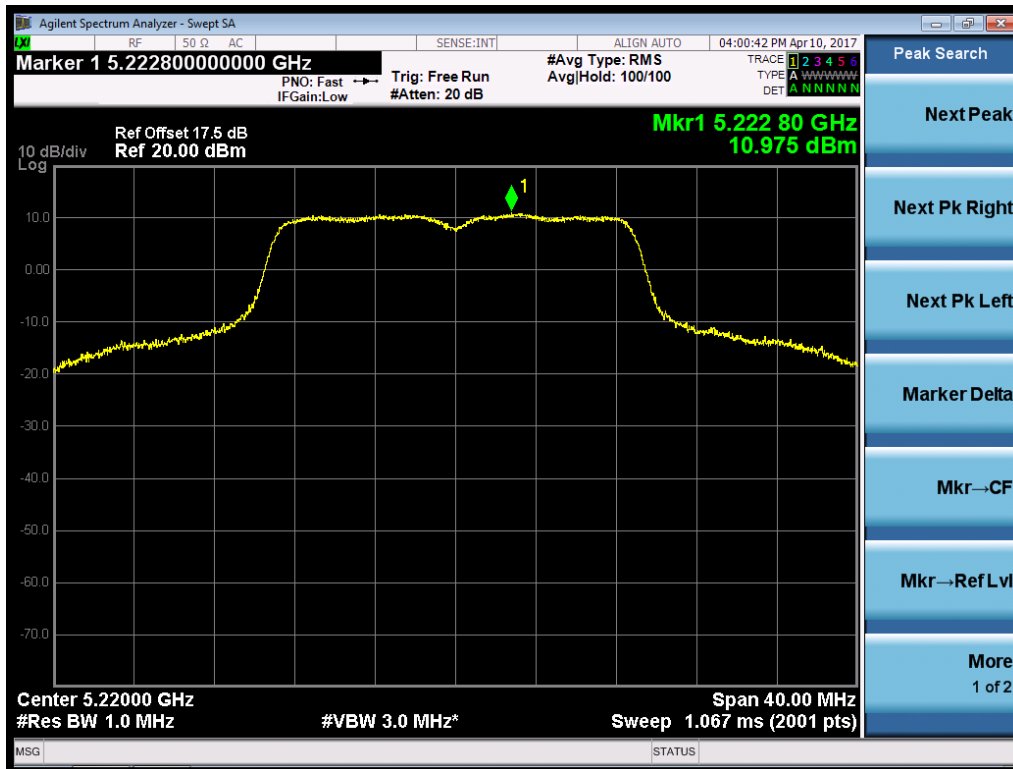

802.11n20-5240MHz

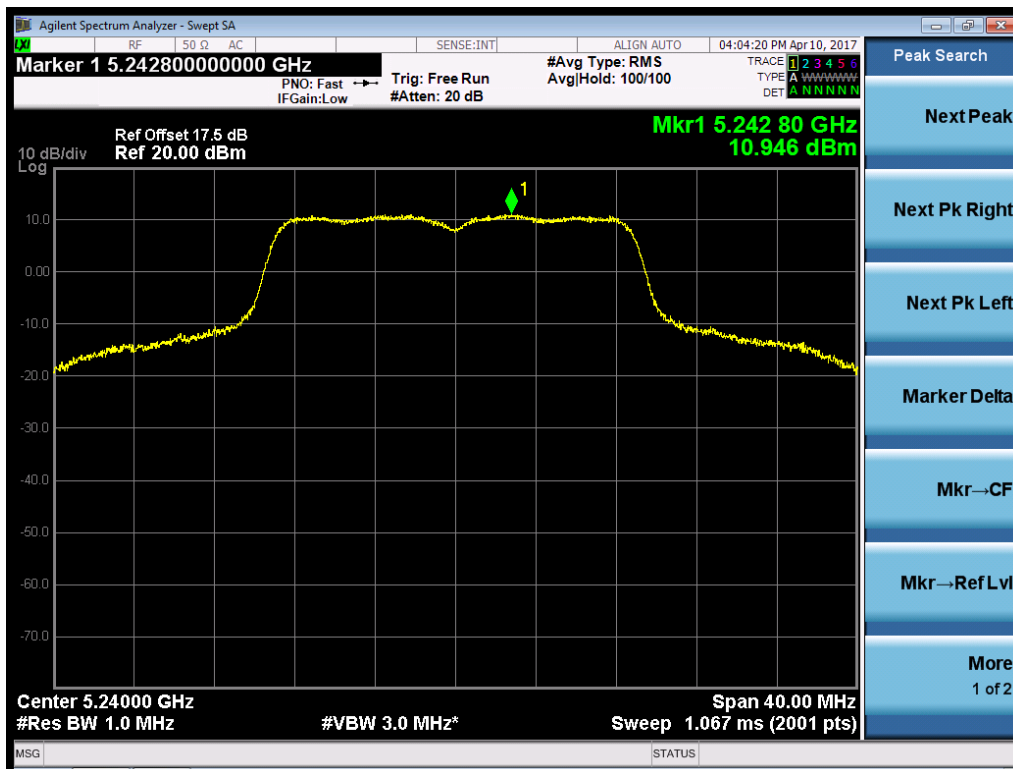

802.11n40-5190MHz

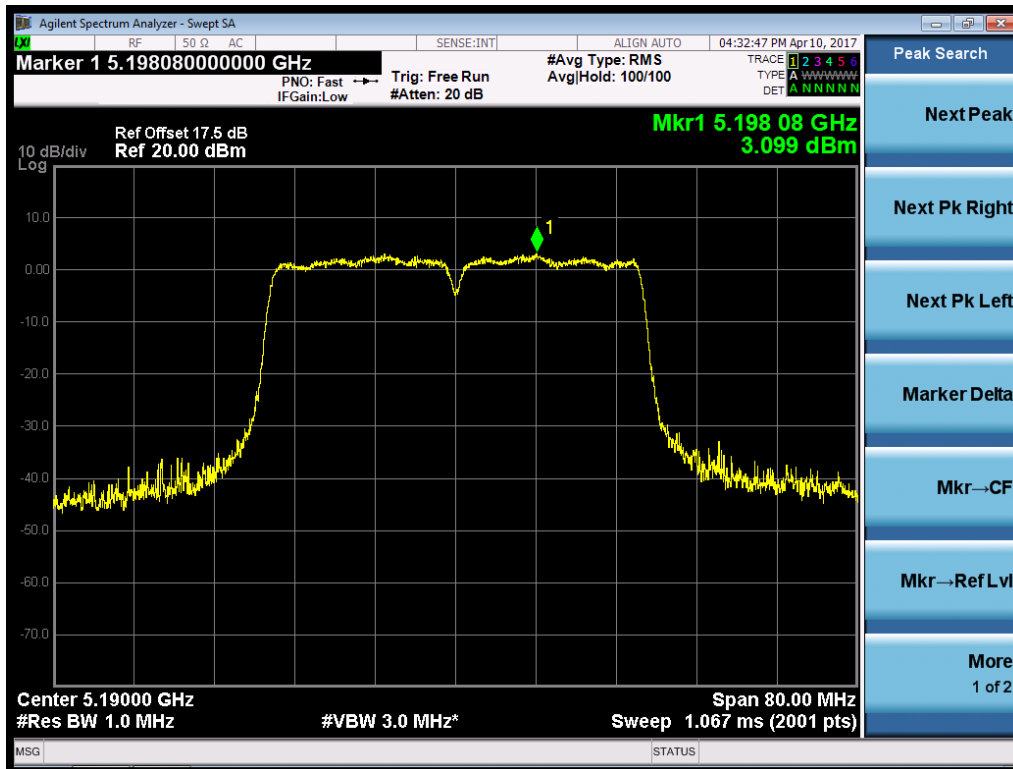

802.11n40-5230MHz

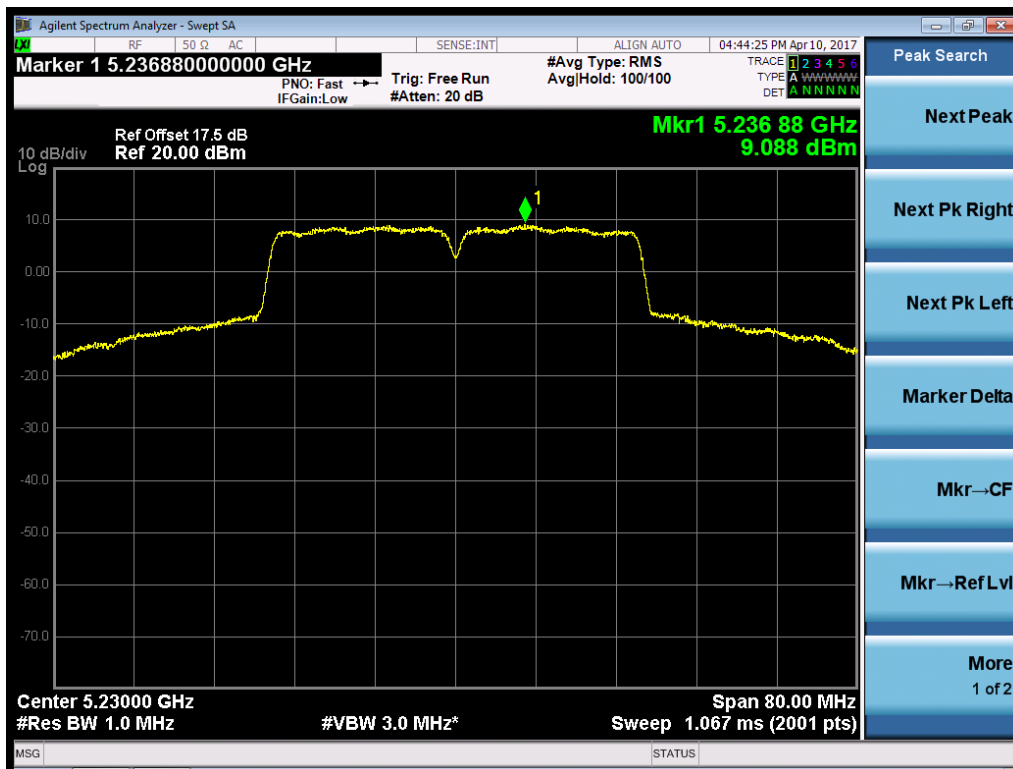

802.11ac80-5210MHz

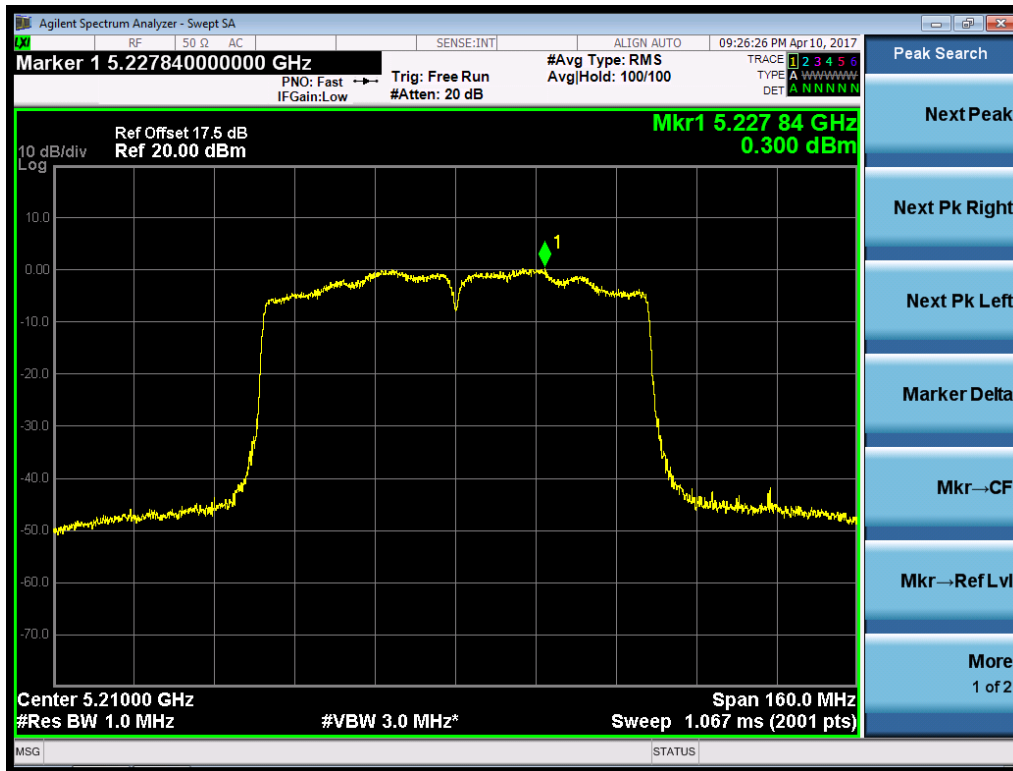

U-NII-3 Band:

Mode	Freq. (MHz)	Duty cycle Factor (dBm)	Constant Factor (dB)	Corrected Reading + Duty cycle factor + Constant factor (dBm/MHz)				Max PSD (dBm/500KHz)	Limit (dBm/500KHz)
				Port 0	Port 1	Port 2	Port 3		
802.11 a	5745	0.22	6.99	-	-	9.36	-	9.36	30.00
	5785	0.22	6.99	-	-	9.53	-	9.53	30.00
	5825	0.22	6.99	-	-	9.43	-	9.43	30.00

Note: The port 2 was chosen to test as representative.

Mode	Freq. (MHz)	Duty cycle Factor (dBm)	Constant Factor (dB)	Corrected Reading (dBm/100kHz)				Total PSD (dBm/500KHz)	Limit (dBm/500KHz)
				Port 0	Port 1	Port 2	Port 3		
802.11n20	5745	0.23	6.99	1.96	1.79	2.12	2.31	15.29	30.00
	5785	0.23	6.99	1.32	1.39	1.81	1.96	14.87	30.00
	5825	0.23	6.99	0.75	0.38	1.09	1.40	14.16	30.00
802.11n40	5755	0.44	6.99	-0.43	-0.23	-0.49	-0.15	13.13	30.00
	5795	0.44	6.99	-1.49	-1.47	-1.54	-0.95	12.10	30.00
802.11ac80	5775	0.74	6.99	1.91	1.80	2.74	2.96	16.13	30.00

Note: Total power = $10 * \lg(10^{\text{port 0} / 10} + 10^{\text{port 1} / 10} + 10^{\text{port 2} / 10} + 10^{\text{port 3} / 10}) + \text{Duty cycle factor} + \text{Constant factor}$.

Test Plots:

802.11a-5745MHz

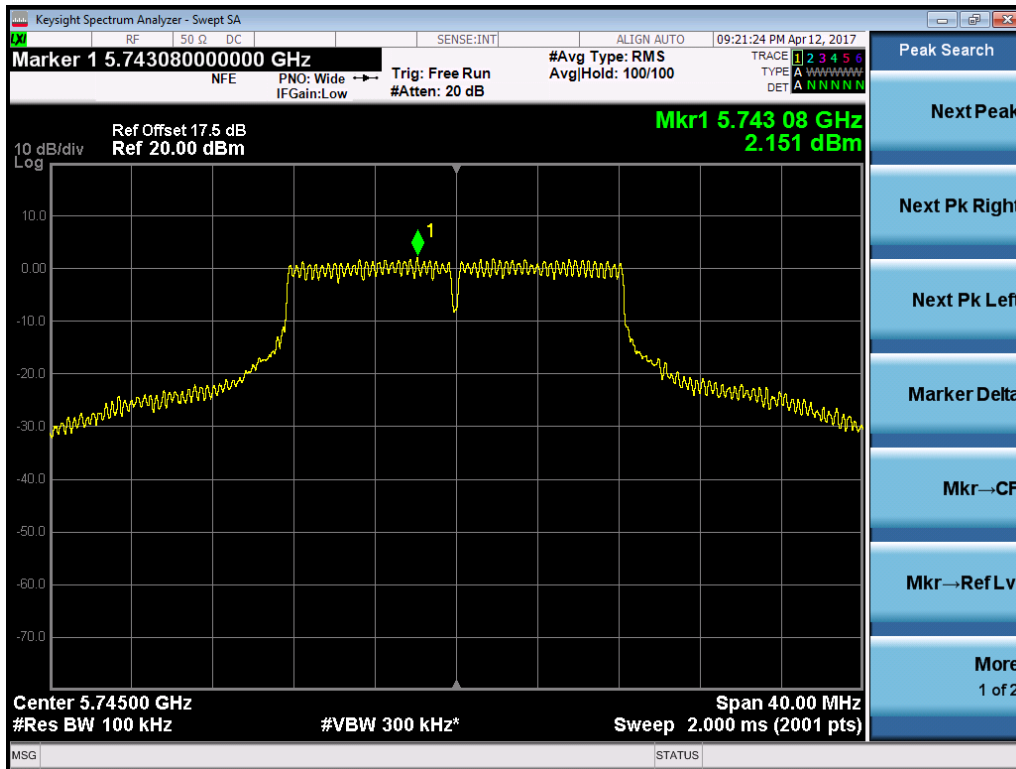

802.11a-5785MHz

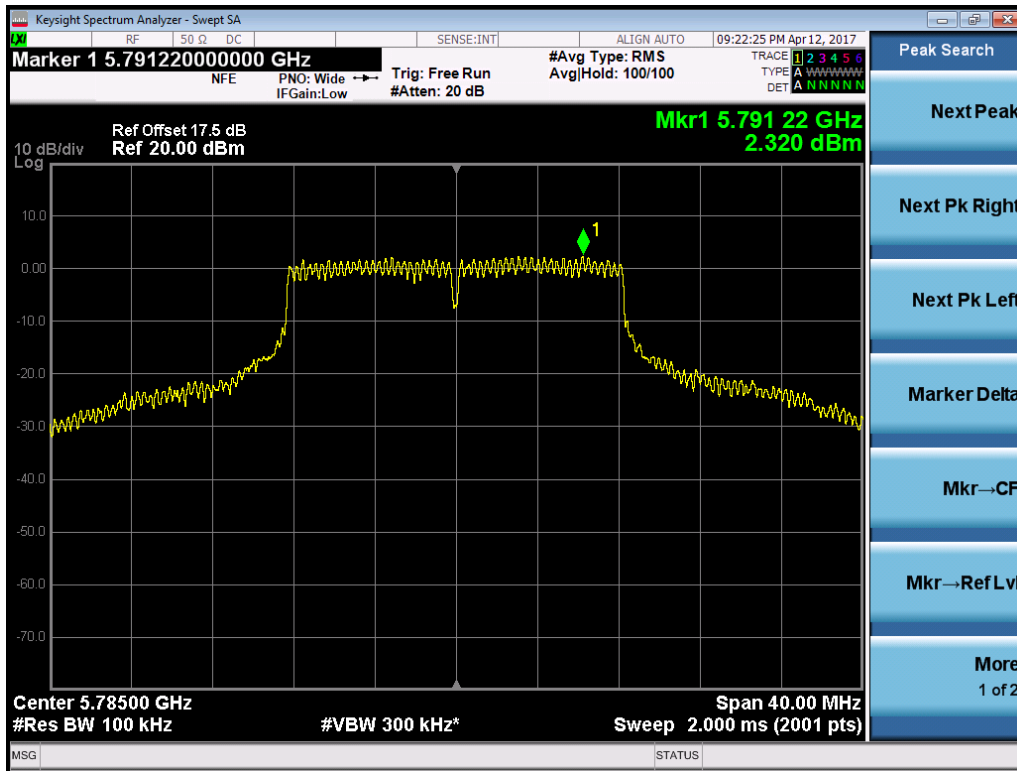

802.11a-5825MHz

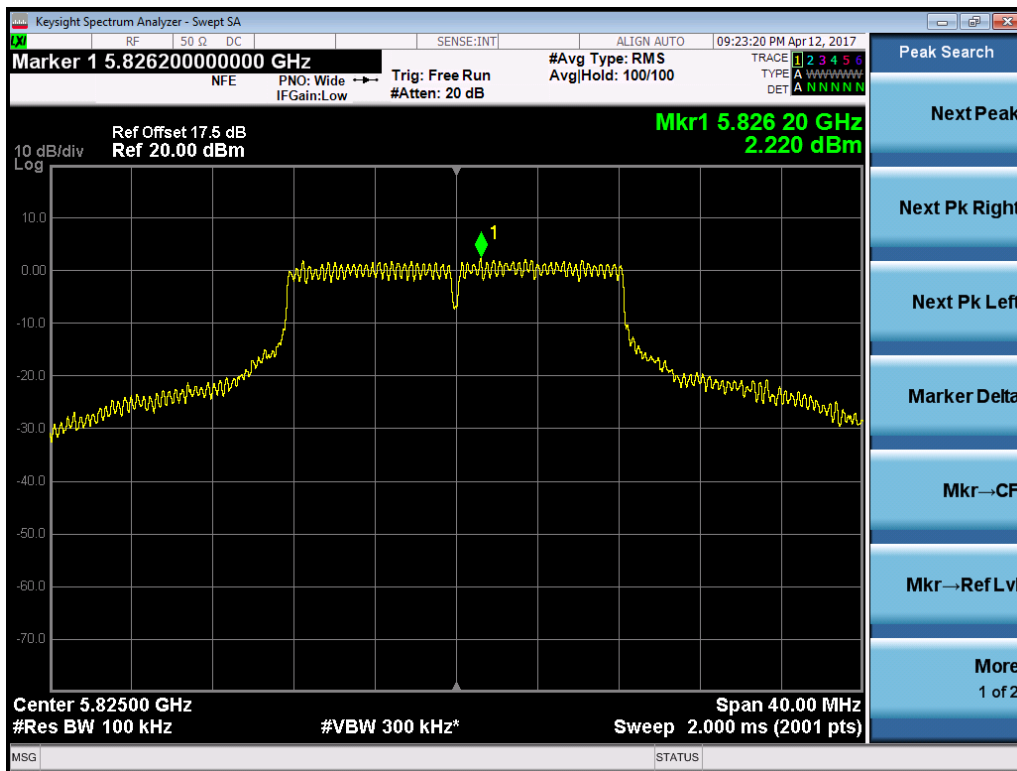

Antenna port 0
802.11n20-5745MHz



802.11n20-5785MHz



802.11n20-5825MHz



802.11n40-5755MHz



802.11n40-5795MHz



802.11ac80-5775MHz



Antenna port 1
802.11n20-5745MHz

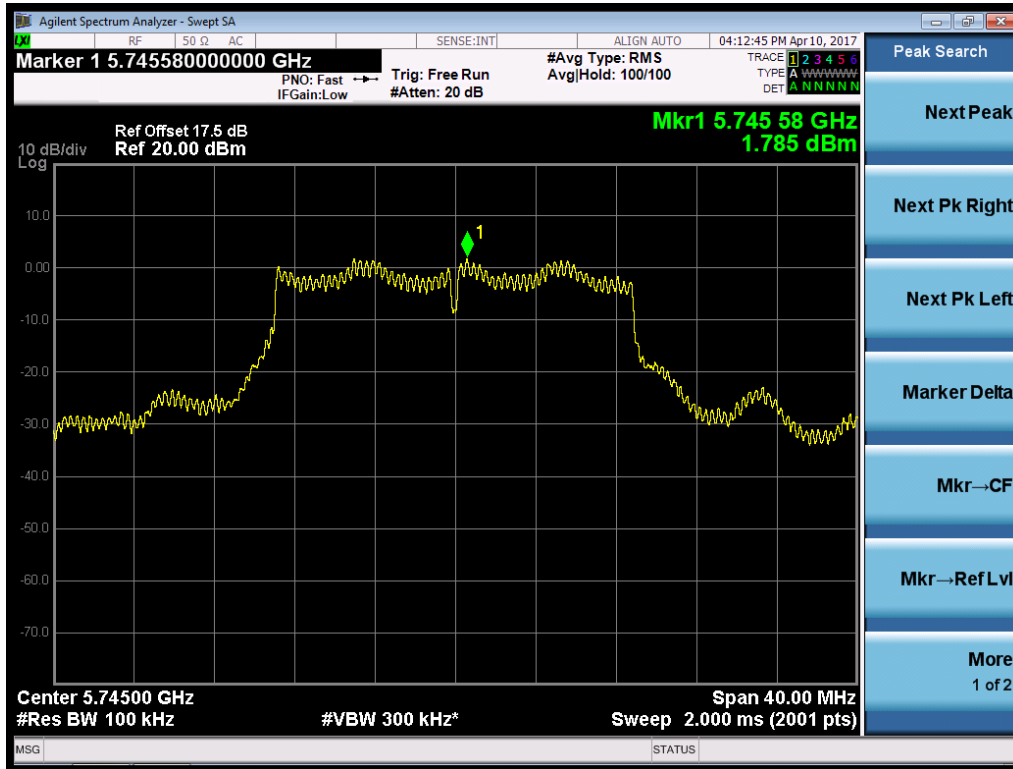

802.11n20-5785MHz

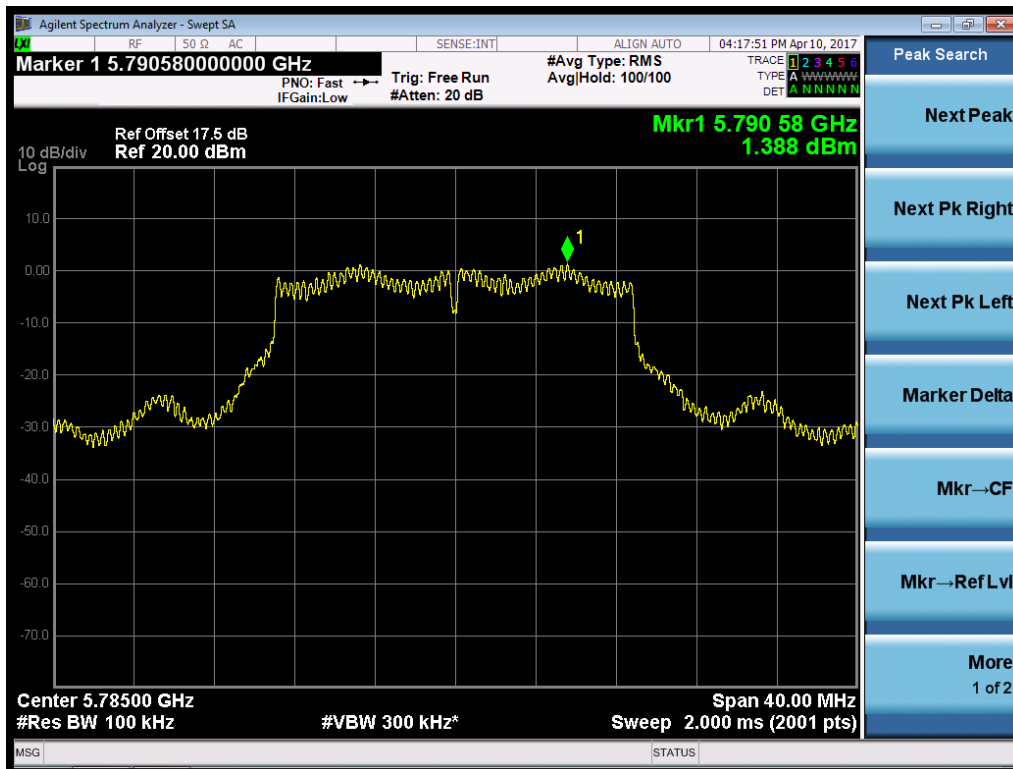

802.11n20-5825MHz



802.11n40-5755MHz

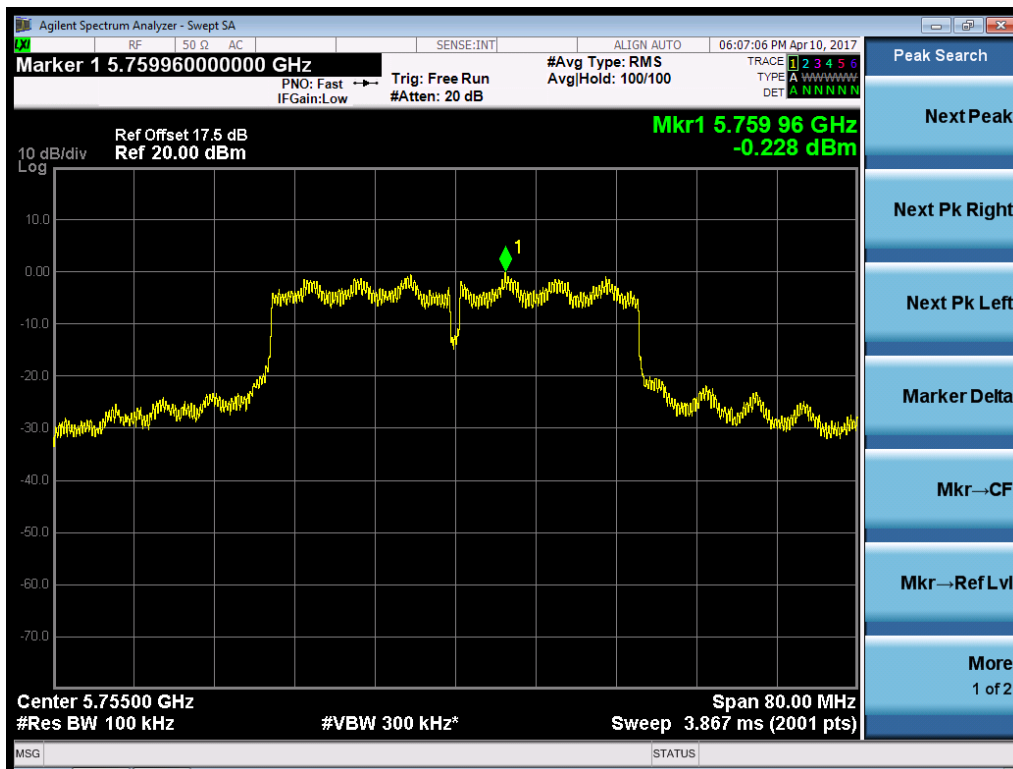

802.11n40-5795MHz

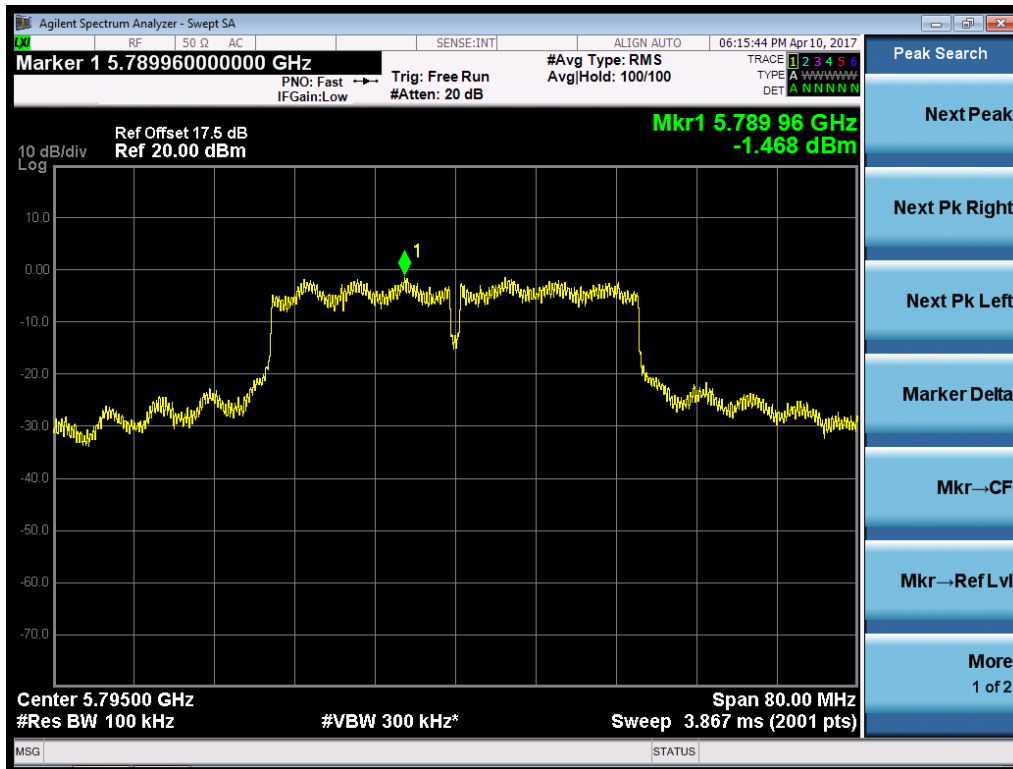

802.11ac80-5775MHz



Antenna port 2
802.11n20-5745MHz

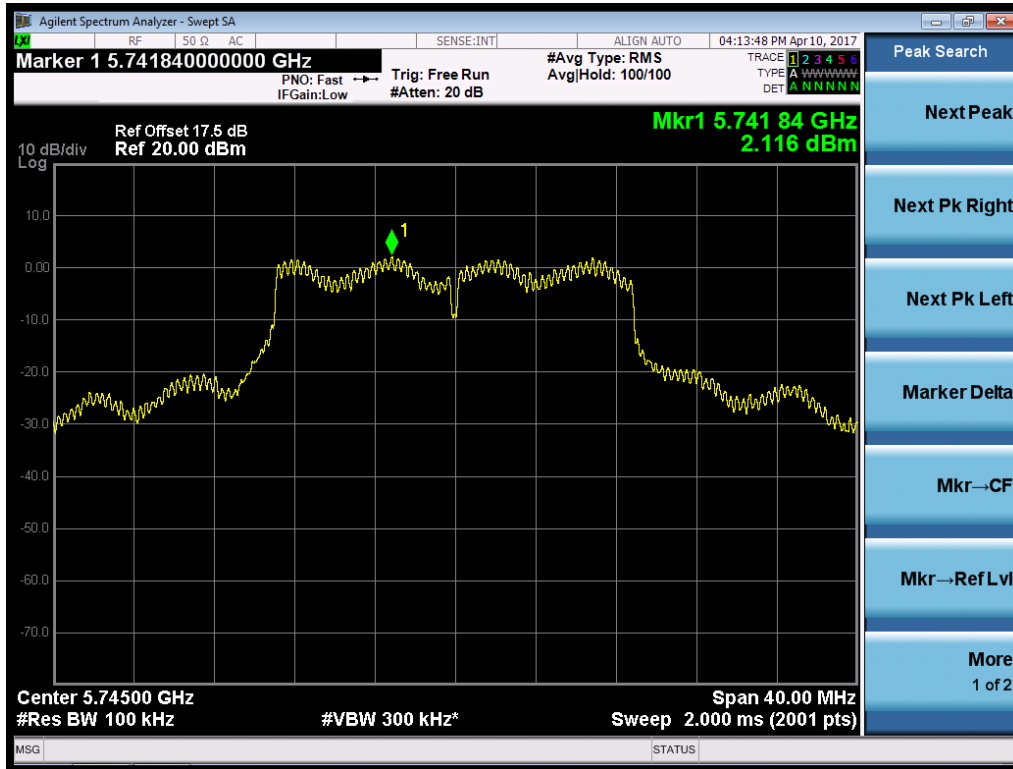

802.11n20-5785MHz

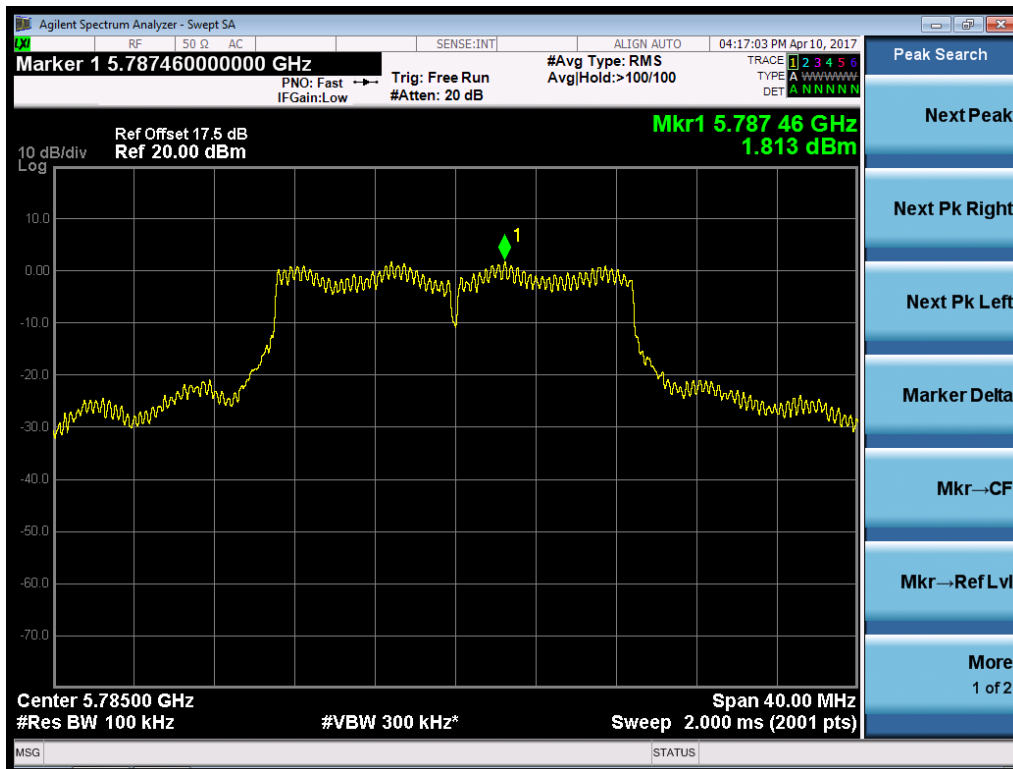

802.11n20-5825MHz

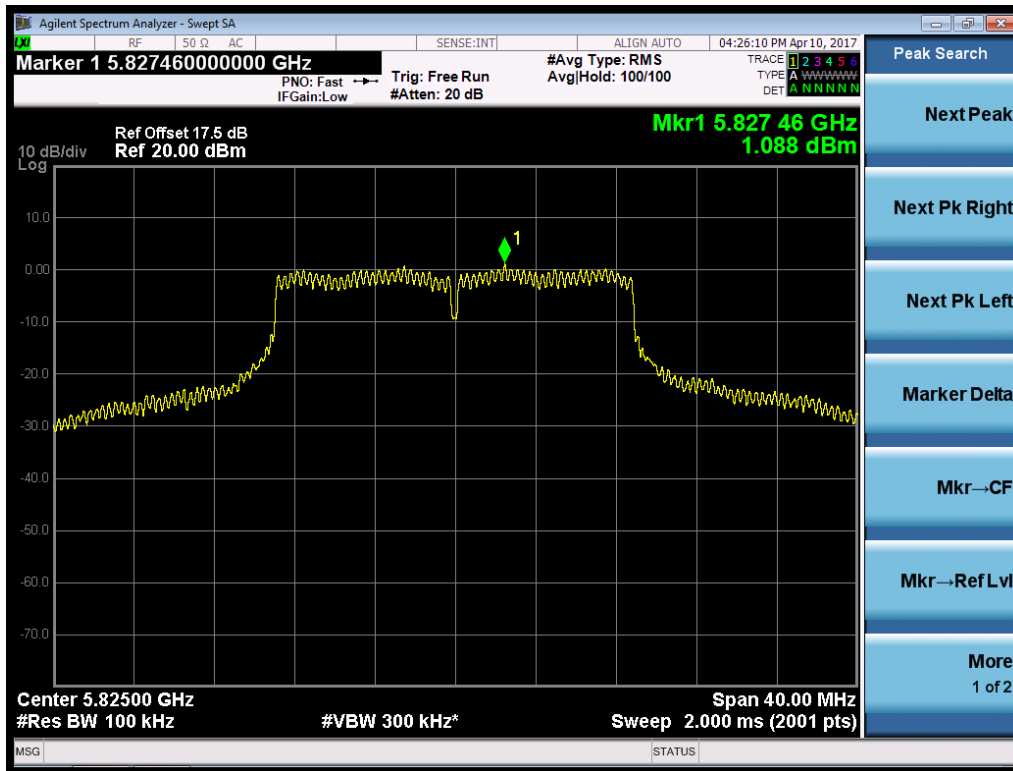

802.11n40-5755MHz

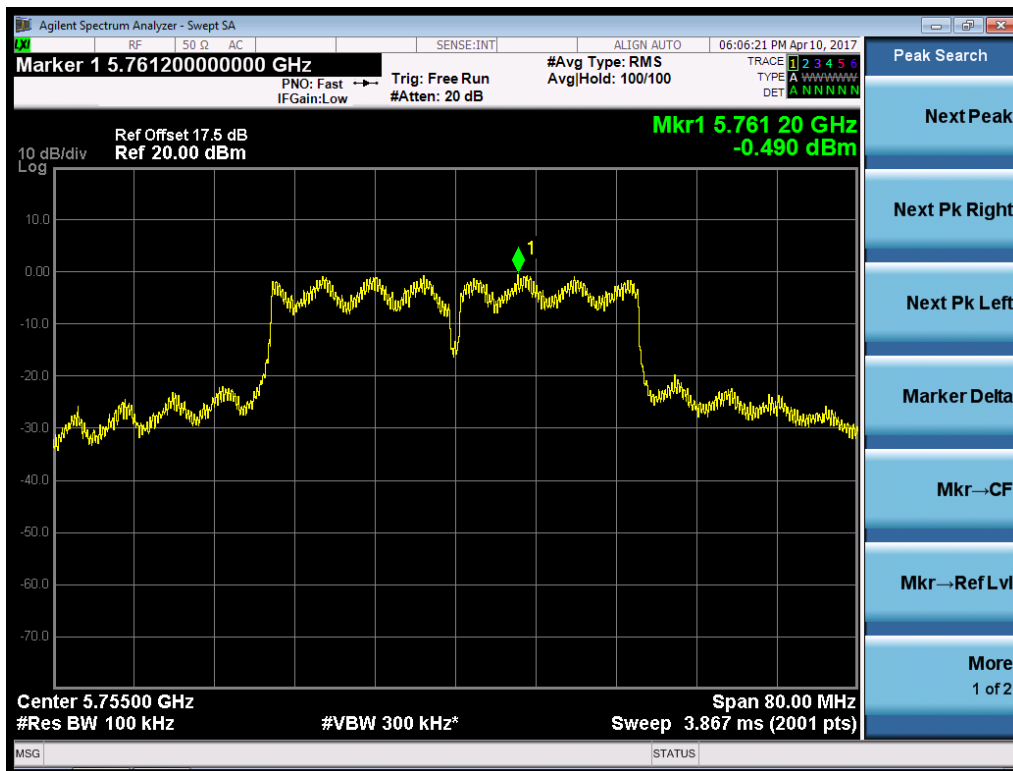

802.11n40-5795MHz

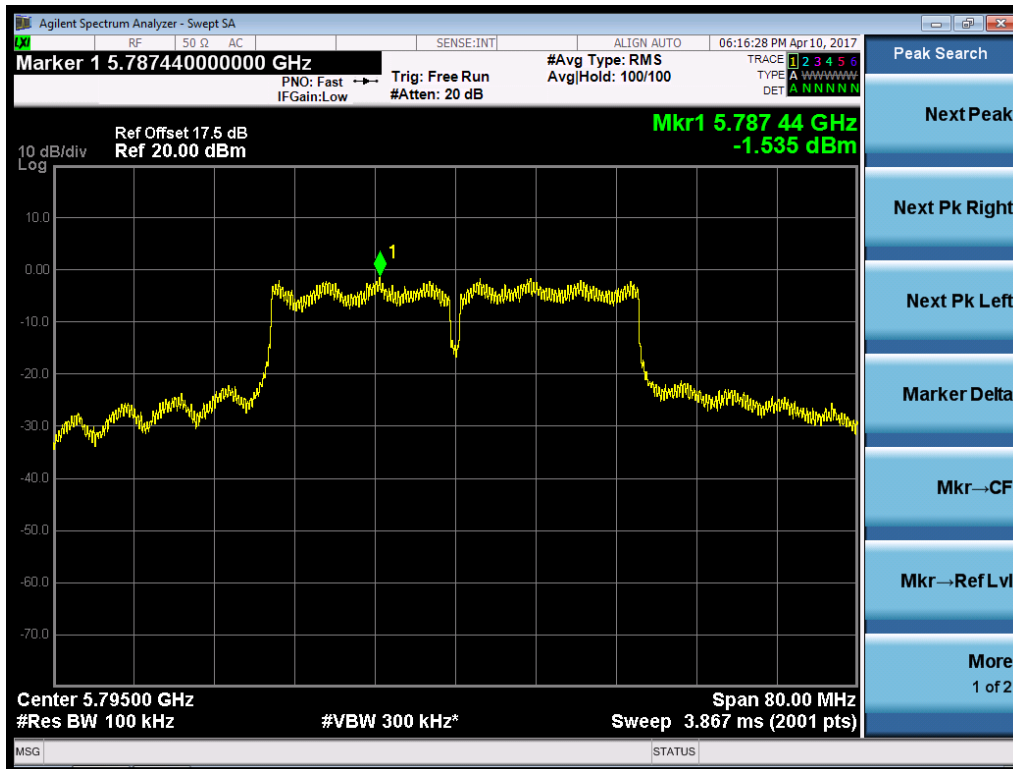

802.11ac80-5775MHz



Antenna port 3
802.11n20-5745MHz



802.11n20-5785MHz

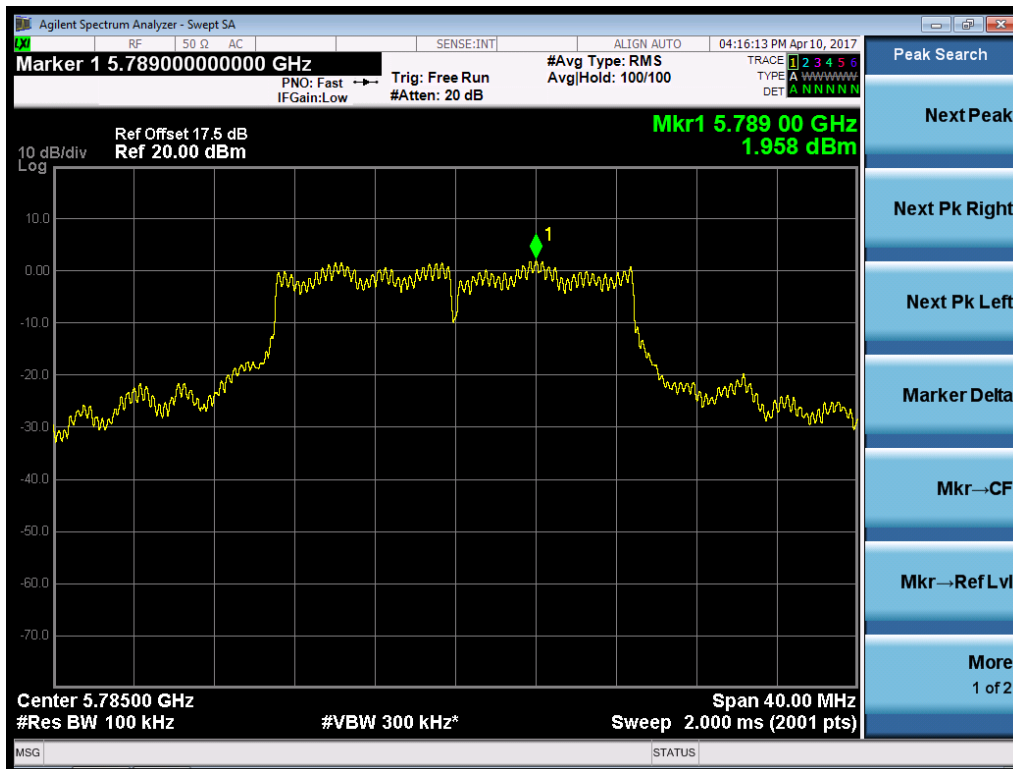

802.11n20-5825MHz

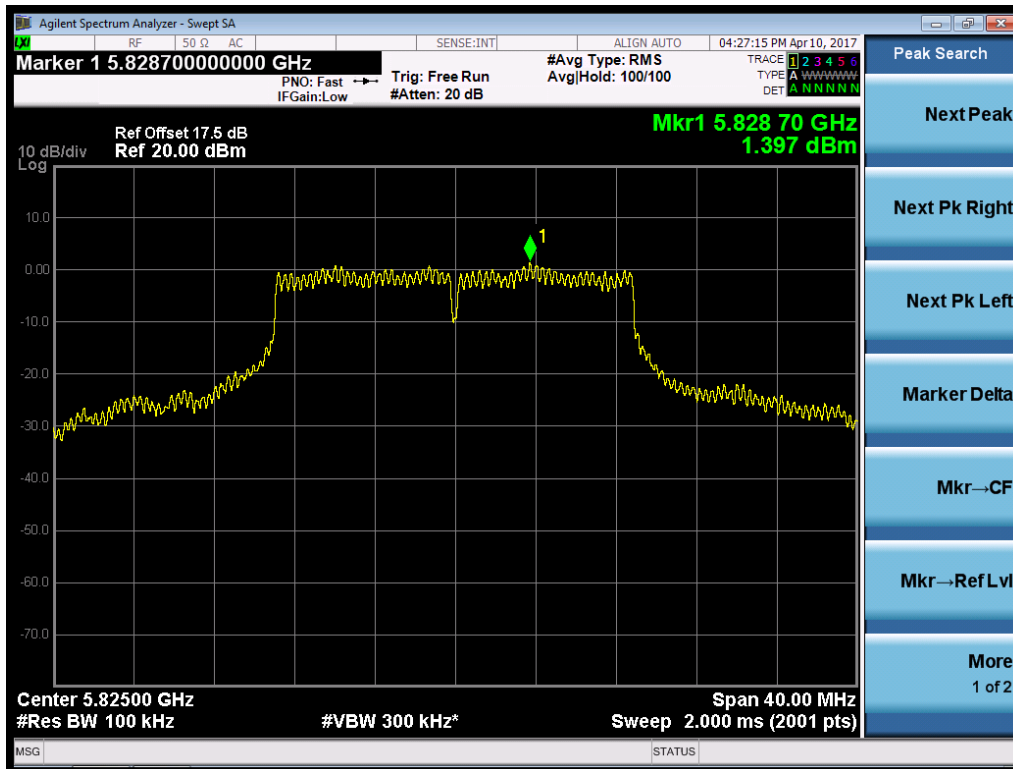

802.11n40-5755MHz

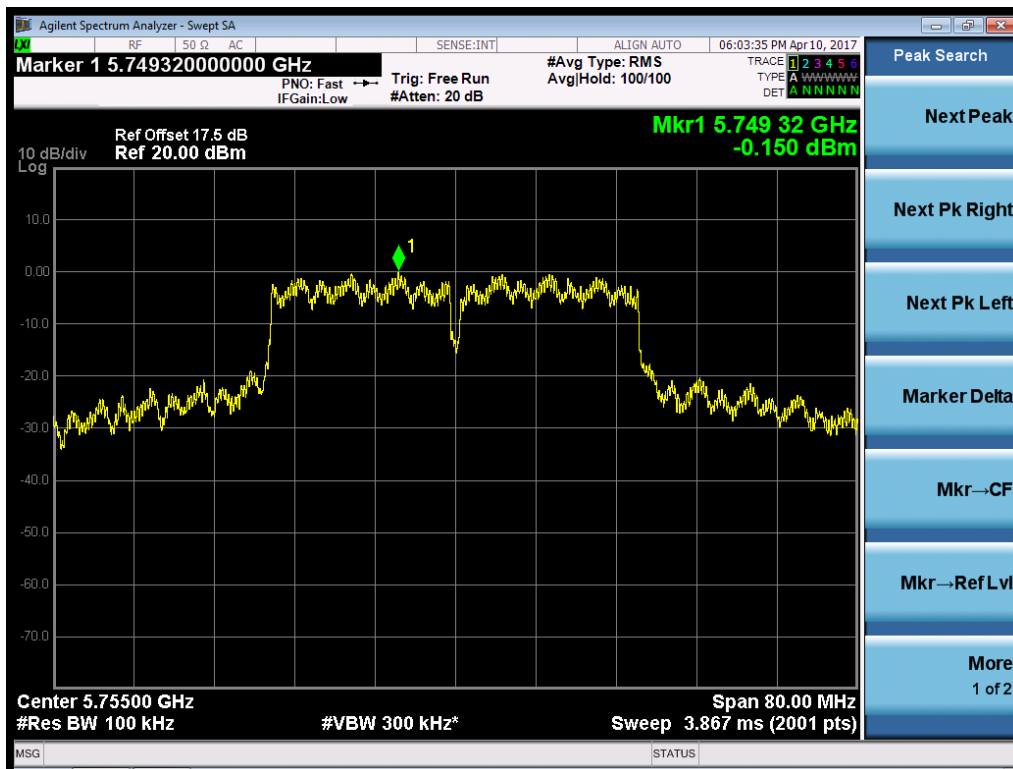

802.11n40-5795MHz

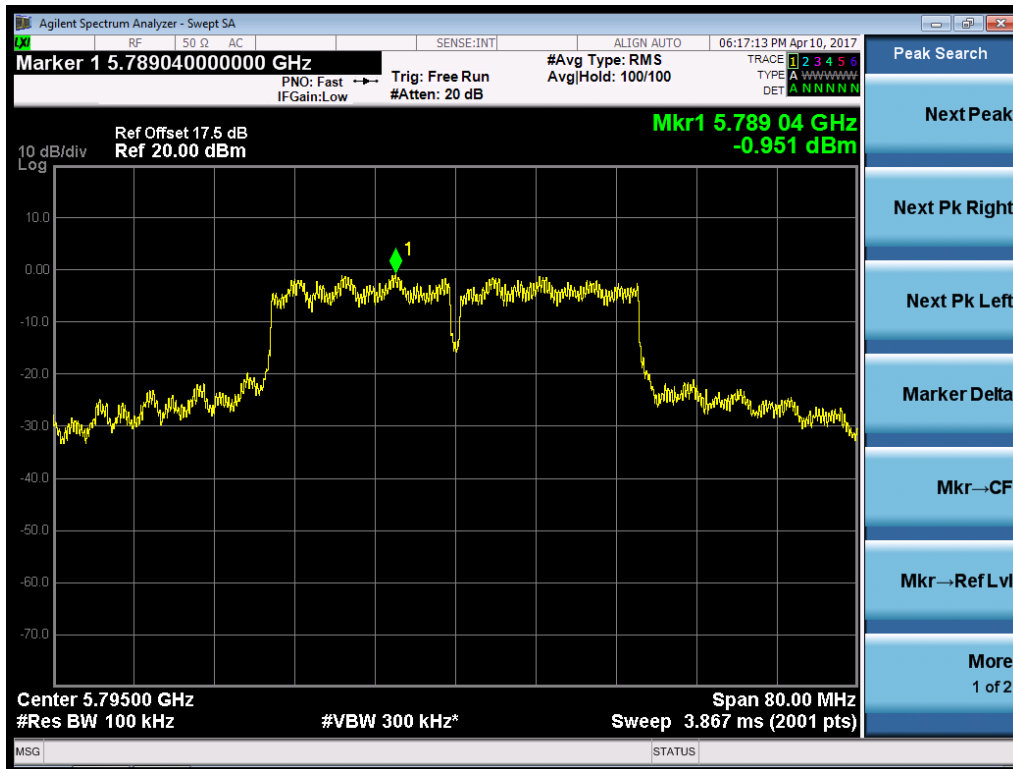

802.11ac80-5775MHz



6 Minimum 6dB Bandwidth

Test result: Pass

6.1 Limit

For systems using digital modulation techniques that may operate in the 5725 - 5850 MHz band, the minimum 6 dB bandwidth shall be at least 500 kHz.

6.2 Test Configuration

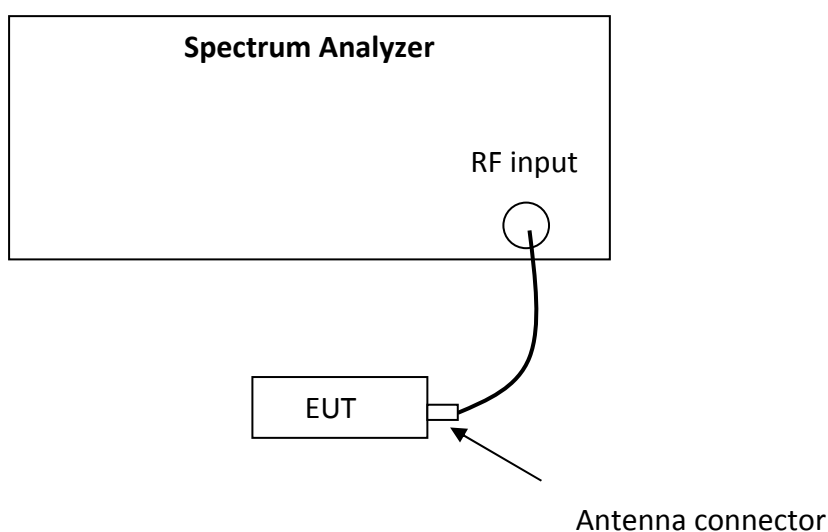

6.3 Test Procedure and test setup

The minimum 6dB Bandwidth was measured from the antenna port of the EUT according to the measurement method refers to KDB 789033 D02: Section C.

- a) Set RBW = 100 kHz.
- b) Set the video bandwidth (VBW) $\geq 3 \times$ RBW.
- c) Detector = Peak.
- d) Trace mode = max hold.
- e) Sweep = auto couple.
- f) Allow the trace to stabilize.
- g) Measure the maximum width of the emission that is constrained by the frequencies associated with the two outermost amplitude points (upper and lower frequencies) that are attenuated by 6 dB relative to the maximum level measured in the fundamental emission.

Note: The automatic bandwidth measurement capability of a spectrum analyzer or EMI receiver may be employed if it implements the functionality described above.

6.4 Test Protocol

Temperature : 25 °C
Relative Humidity : 55 %

Mode	Freq. (MHz)	Minimum 6dB Bandwidth (MHz)	Limits (MHz)
802.11a	5745	16.36	> 0.5
	5785	16.36	> 0.5
	5825	16.34	> 0.5
802.11n20	5745	16.72	> 0.5
	5785	16.94	> 0.5
	5825	17.66	> 0.5
802.11n40	5755	36.37	> 0.5
	5795	36.40	> 0.5
802.11ac80	5775	75.32	> 0.5

Test Plots:

802.11a-5745MHz

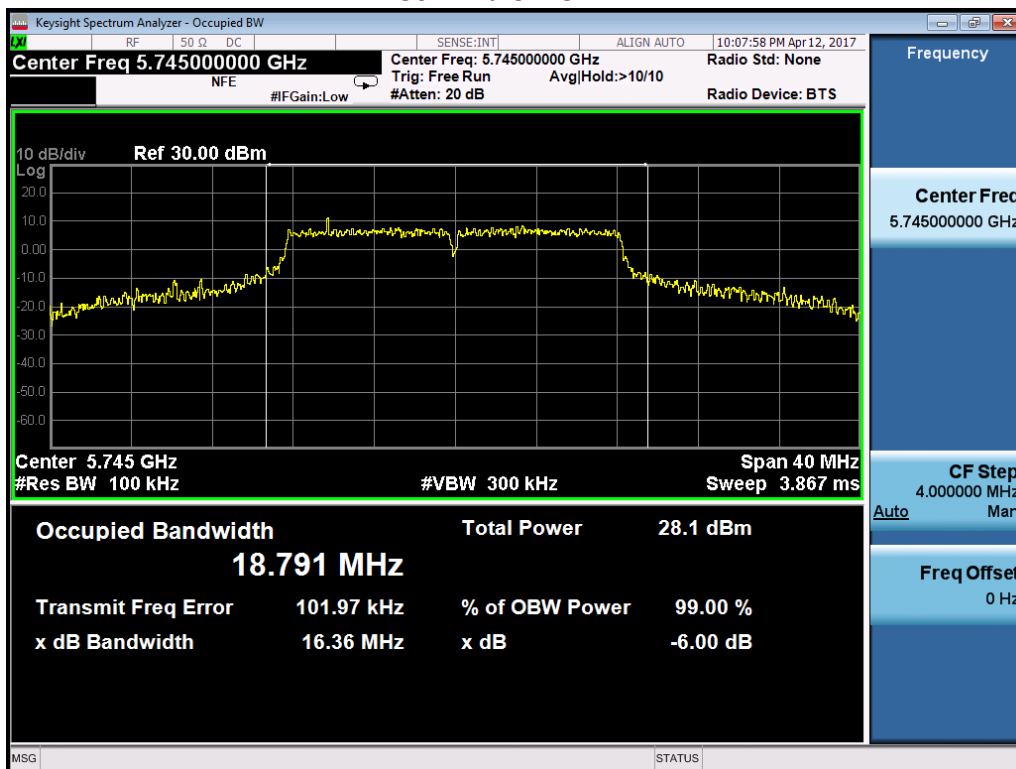

802.11a-5785MHz

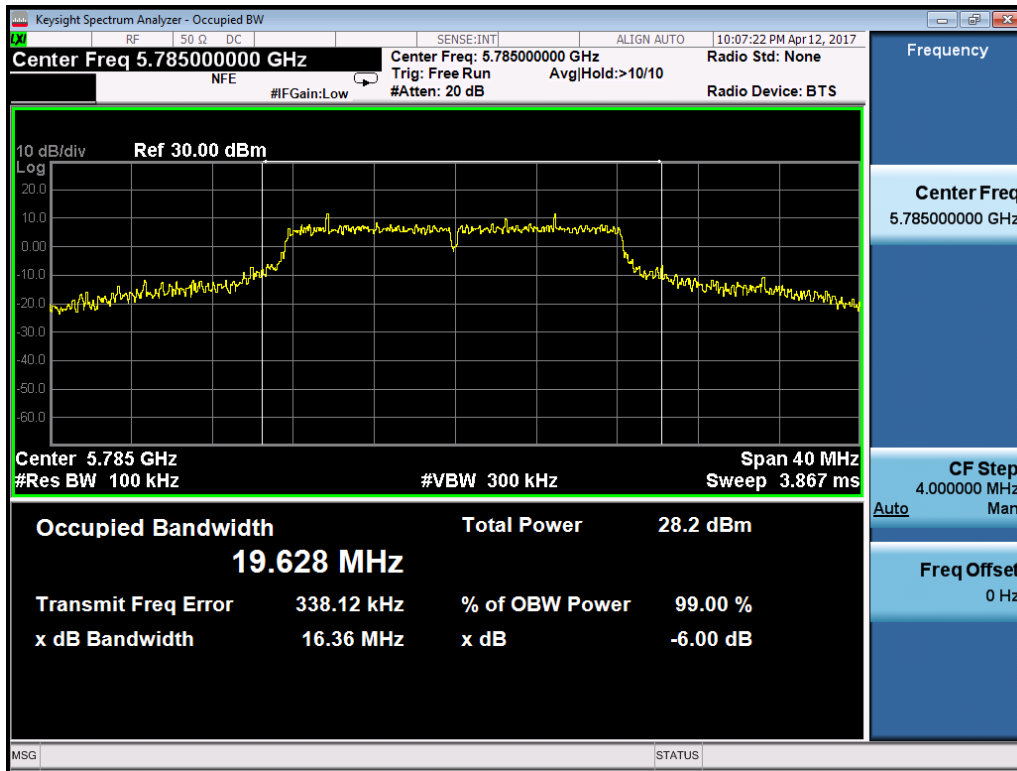

802.11a-5825MHz

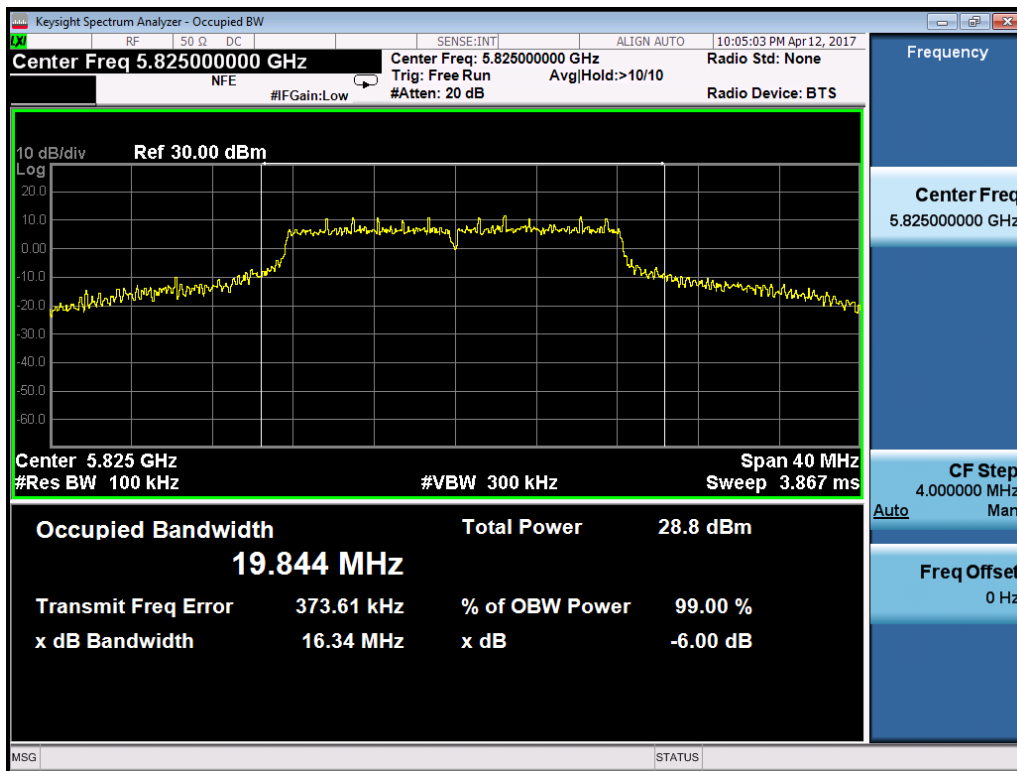

802.11n20-5745MHz

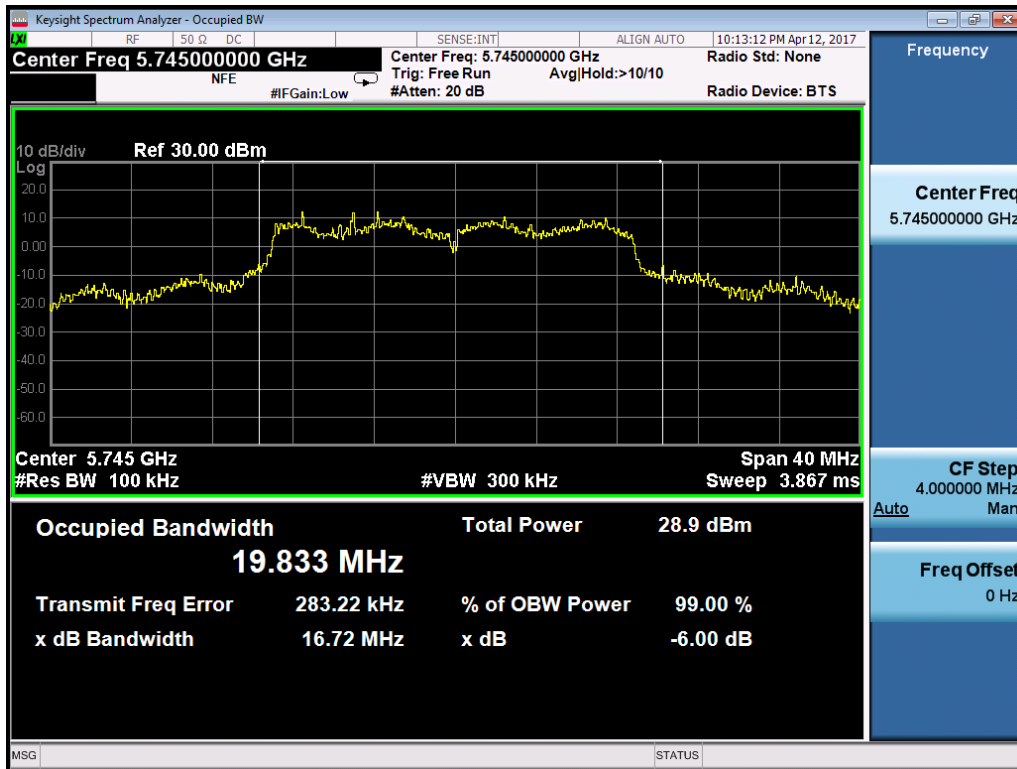

802.11n20-5785MHz

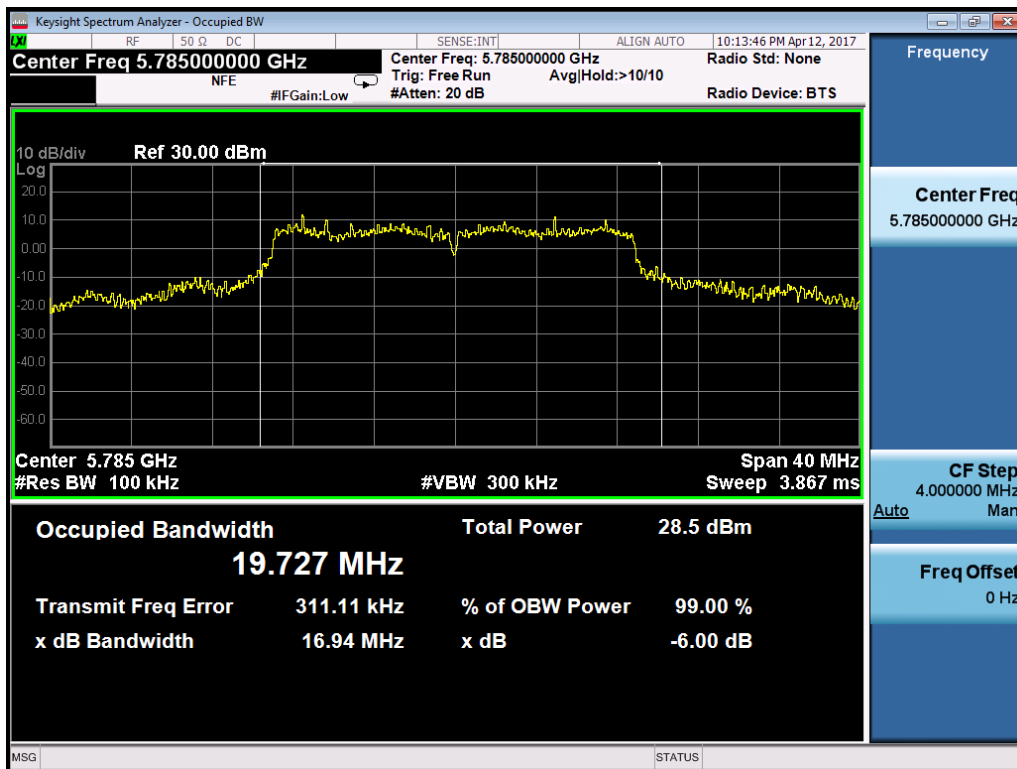

802.11n20-5825MHz

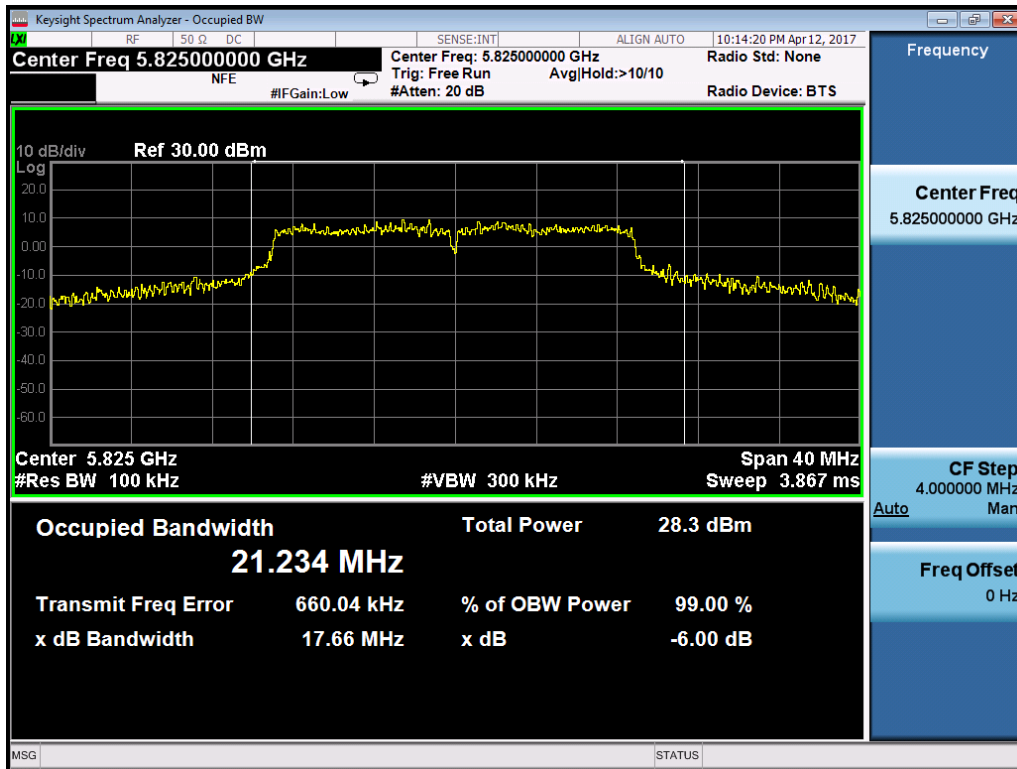

802.11n40-5755MHz

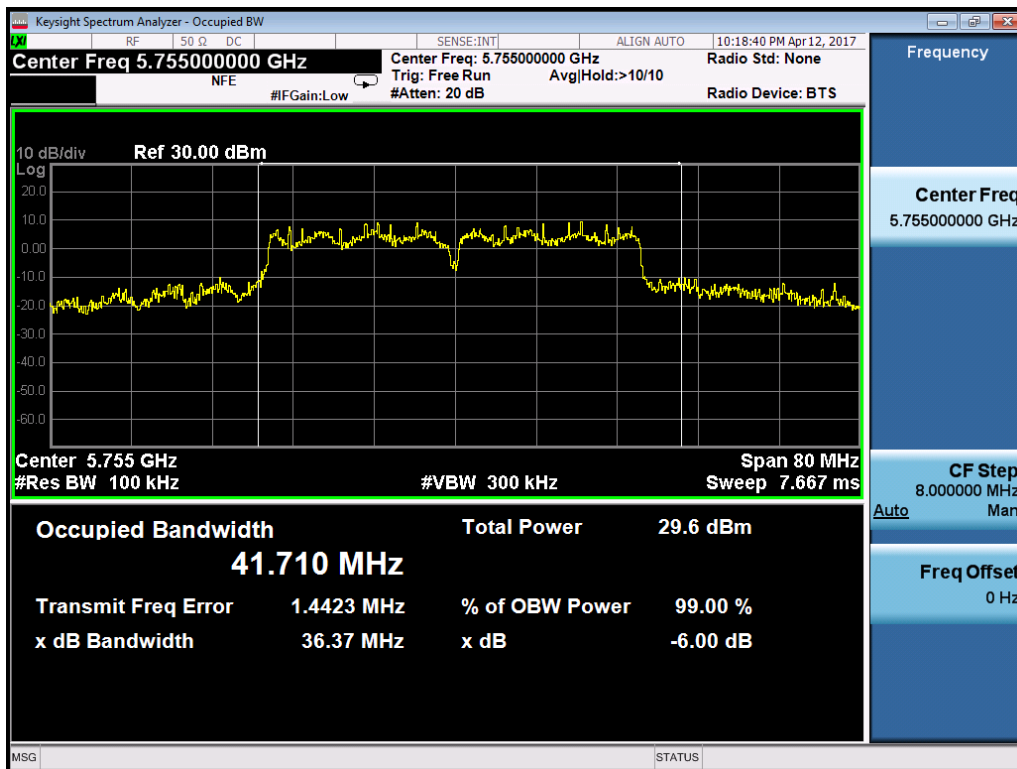

802.11n40-5795MHz

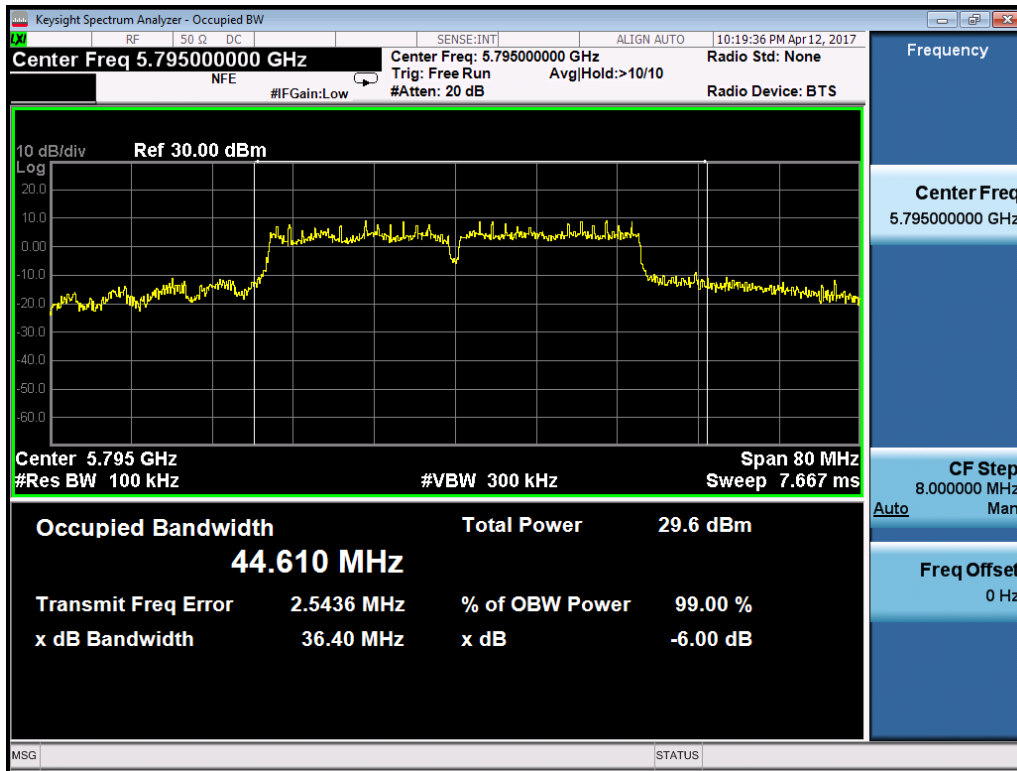

802.11ac80-5775MHz

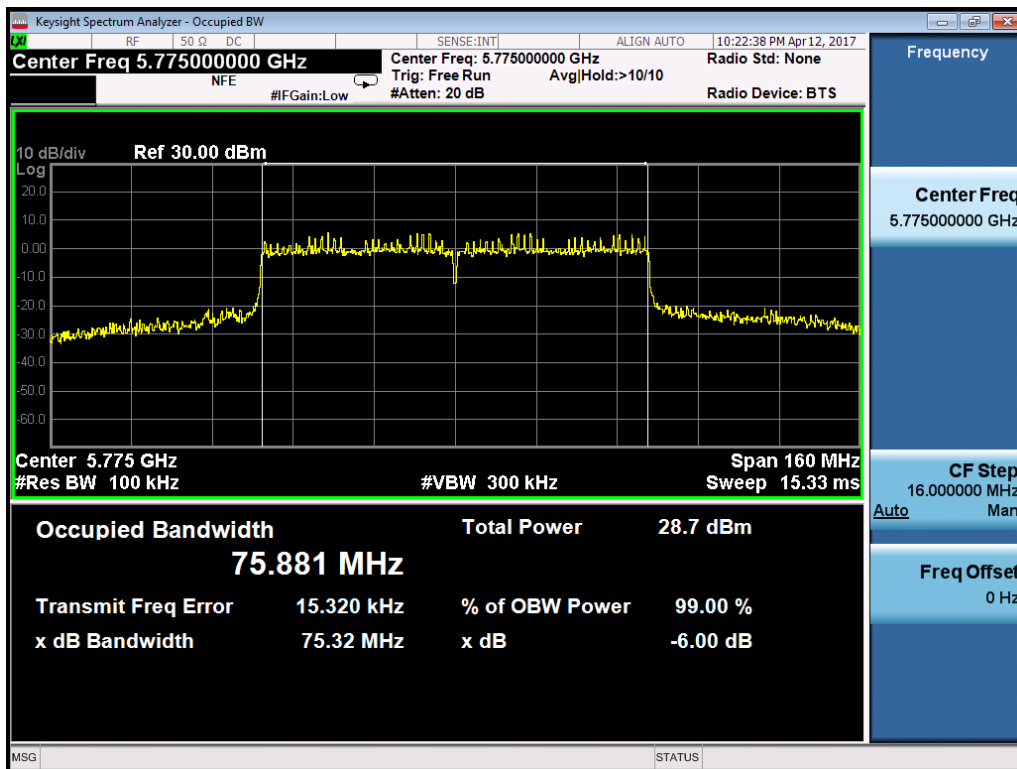

7 Radiated Emissions

Test result: Pass

7.1 Test limit

7.1.1 The radiated emissions which are lower than 1GHz or fall in the restricted bands, as defined in §15.205(a), must also comply with the radiated emission limits specified in §15.209(a) showed as below:

Frequency (MHz)	Field Strength (dBuV/m)	Measurement Distance (m)
30 - 88	40.0	3
88 - 216	43.5	3
216 - 960	46.0	3
Above 960	54.0	3

7.1.2 The emission which is outside the restrict bands, should comply with the EIRP limit as below:

For transmitters operating in the 5.15–5.25 / 5.25 – 5.35 / 5.47 – 5.725 GHz band:

Frequency (MHz)	EIRP Limit (dBm)	Equivalent Field Strength (3m) (dBμV/m)
<5150	-27	68.20
>5350		
<5470		
>5725		

For transmitters operating in the 5.15–5.25 / 5.25 – 5.35 / 5.47 – 5.725 GHz band Assessed with 15.209(a):

Frequency (MHz)	Field Strength (dBuV/m)	Measurement Distance (m)
30 - 88	40.0	3
88 - 216	43.5	3
216 - 960	46.0	3
Above 960	54.0	3

For transmitters operating in the 5.725 – 5.85GHz band:

Frequency (MHz)	EIRP Limit (dBm/MHz)	Equivalent Field Strength (3m) (dBμV/m)
<5650	-27	68.20
5650 ~ 5700	-27 ~ 10	68.20 ~ 105.20
5700 ~ 5720	10 ~ 15.6	105.20 ~ 110.80
5720 ~ 5725	15.6 ~ 27	110.8 ~ 122.2
5850 ~ 5855	27 ~ 15.6	122.2 ~ 110.8
5855 ~ 5875	15.6 ~ 10	110.8 ~ 105.20
5875 ~ 5925	10 ~ -27	105.20 ~ 68.20
>5925	-27	68.20

7.1.3 As specified in 15.407(b), emissions above 1000 MHz that are outside of the restricted bands are subject to a peak emission limit of -27 dBm/MHz (or -17 dBm/MHz as specified in 15.407(b)(4)). However, an out-of-band emission that complies with both the average and peak limits of 15.209 is not required to satisfy the -27 dBm/MHz or -17 dBm/MHz peak emission limit.

7.2 Test Configuration

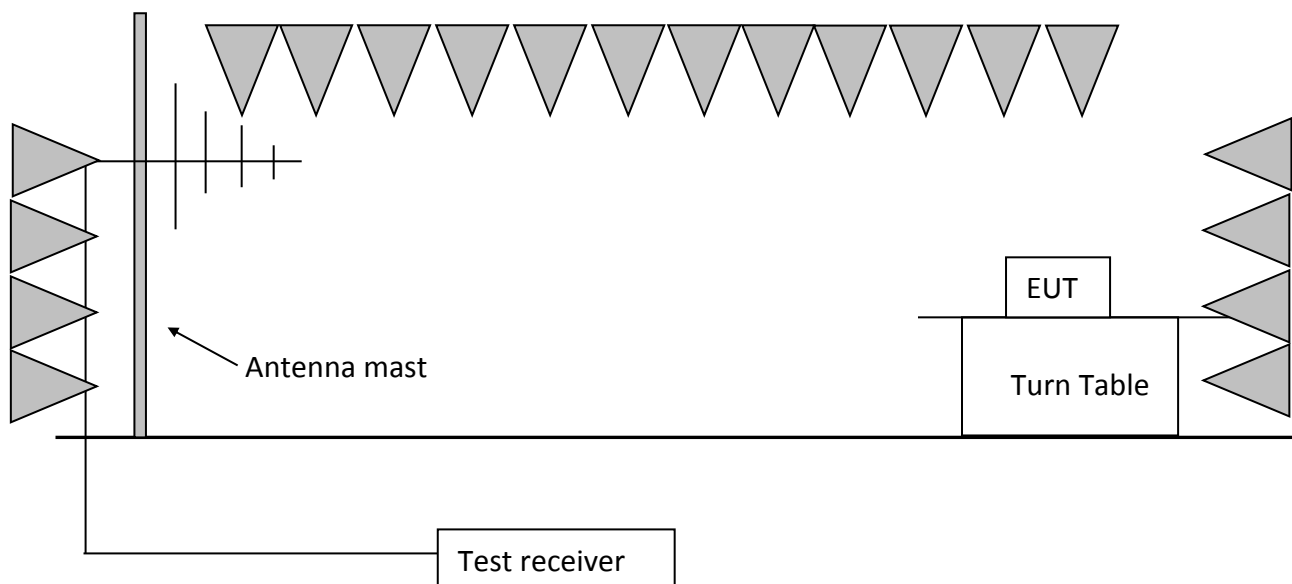

7.3 Test procedure and test setup

The measurement was applied in a semi-anechoic chamber. While testing for spurious emission higher than 1GHz, if applied, the pre-amplifier would be equipped just at the output terminal of the antenna.

Tabletop devices shall be placed on a nonconducting platform with nominal top surface dimensions 1 m by 1.5 m. For emissions testing at or below 1 GHz, the table height shall be 80 cm above the reference ground plane. For emission measurements above 1 GHz, the table height shall be 1.5 m.

The turntable rotated 360 degrees to determine the position of the maximum emission level. The EUT was set 3 meters away from the receiving antenna which was mounted on an antenna mast. The antenna moved up and down between from 1meter to 4 meters to find out the maximum emission level.

The EUT was tested according to KDB 789033 D02: Section G.

The radiated emission was measured using the Spectrum Analyzer with the resolutions bandwidth set as:

RBW = 300 Hz, VBW = 1 kHz (9 kHz~150 kHz);
RBW = 10 kHz, VBW = 30 kHz (150 kHz~30MHz);
RBW = 100 kHz, VBW = 300 kHz (30MHz~1GHz for PK)
RBW = 1MHz, VBW = 3MHz (>1GHz for PK);

Remark:

1. Factor= Antenna Factor + Cable Loss (-Amplifier, is employed)
2. Measured level= Original Receiver Reading + Factor
3. Margin = Limit – Measured level
4. If the PK measured level is lower than AV limit, the AV test can be elided.

Example:

Assuming Antenna Factor = 30.20dB/m, Cable Loss = 2.00dB,
Gain of Preamplifier = 32.00dB, Original Receiver Reading = 10dBuV.
Then Factor = 30.20 + 2.00 – 32.00 = 0.20dB/m;
Measured level = 10dBuV + 0.20dB/m = 10.20dBuV/m
Assuming limit = 54dBuV/m,
Measured level = 10.20dBuV/m, then Margin = 54 - 10.20 = 43.80dBuV/m.

7.4 Test Protocol

Temperature: 25 °C
Relative Humidity: 55 %

The low frequency, which started from 9 kHz to 30MHz, was pre-scanned and the result which was 20dB lower than the limit line per 15.31(o) was not reported.

The worst waveform from 30MHz to 1000MHz is listed as below:

Horizontal

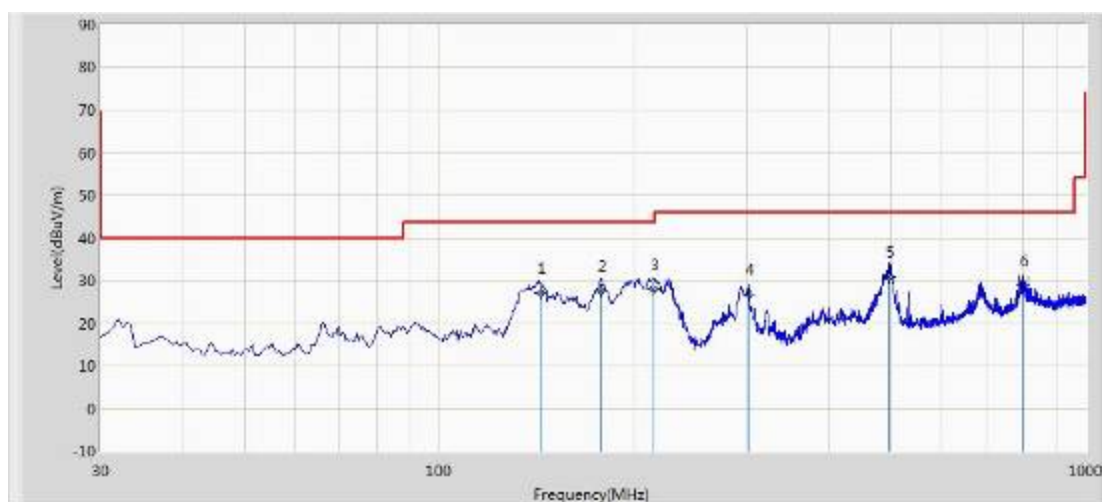

No	Flag	Mark	Frequency (MHz)	Measure Level (dBuV/m)	Reading Level (dBuV)	Over Limit (dB)	Limit (dBuV/m)	Factor (dB)	Type
1			143.526	27.181	12.450	-16.319	43.500	14.731	QP
2			177.925	27.632	14.526	-15.868	43.500	13.105	QP
3			214.526	28.084	16.520	-15.416	43.500	11.564	QP
4			301.115	26.856	12.520	-19.144	46.000	14.336	QP
5		*	496.520	30.848	12.425	-15.152	46.000	18.423	QP
6			800.150	28.826	5.630	-17.174	46.000	23.195	QP

Vertical

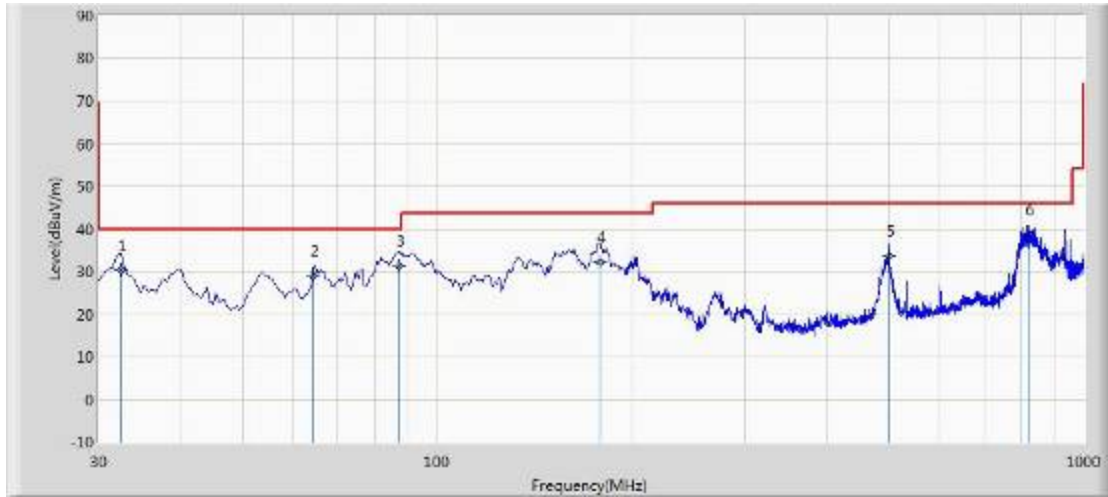

No	Flag	Mark	Frequency (MHz)	Measure Level (dBuV/m)	Reading Level (dBuV)	Over Limit (dB)	Limit (dBuV/m)	Factor (dB)	Type
1			32.425	30.231	16.523	-9.769	40.000	13.708	QP
2			64.256	29.104	16.523	-10.896	40.000	12.581	QP
3			87.250	31.579	21.420	-8.421	40.000	10.159	QP
4			178.410	32.393	19.360	-11.107	43.500	13.033	QP
5			499.630	33.675	15.200	-12.325	46.000	18.475	QP
6		*	819.526	38.809	15.410	-7.191	46.000	23.398	QP

Test result above 1GHz:

The emission was conducted from 1GHz to 40GHz.

U-NII-1 Band:
802.11a

Channel	Polarity	Frequency (MHz)	Measure Level (dBuV/m)	Reading Level (dBuV)	Over Limit (dB)	Limit (dBuV/m)	Factor (dB)	Type
L	H	5148.520	65.143	27.689	-8.857	74.000	37.454	PK
	H	5150.000	63.417	25.965	-10.583	74.000	37.452	PK
	H	5150.000	50.578	13.126	-3.422	54.000	37.452	AV
	V	5146.405	72.223	34.766	-1.777	74.000	37.457	PK
	V	5150.000	68.981	31.529	-5.019	74.000	37.452	PK
	V	5150.000	53.057	15.605	-0.943	54.000	37.452	AV
	H	15540.950	42.037	29.881	-11.963	54.000	12.156	AV
	V	15540.650	38.405	26.249	-15.595	54.000	12.156	AV
	V	15543.500	54.149	41.993	-19.851	74.000	12.155	PK
M	H	15662.500	57.680	45.723	-16.320	74.000	11.958	PK
	H	15664.750	45.271	33.316	-8.729	54.000	11.955	AV
	V	15540.650	38.405	26.249	-15.595	54.000	12.156	AV
	V	15543.500	54.149	41.993	-19.851	74.000	12.155	PK
H	H	15722.000	56.834	45.072	-17.166	74.000	11.762	PK
	H	15722.725	42.038	30.276	-11.962	54.000	11.762	AV
	V	12322.000	45.827	34.231	-28.173	74.000	11.596	PK
	V	15713.500	52.062	40.268	-21.938	74.000	11.794	PK

802.11n20

Channel	Polarity	Frequency (MHz)	Measure Level (dBuV/m)	Reading Level (dBuV)	Over Limit (dB)	Limit (dBuV/m)	Factor (dB)	Type
L	V	5148.835	73.587	36.134	-0.413	74.000	37.454	PK
	V	5150.000	69.763	32.311	-4.237	74.000	37.452	PK
	V	5150.000	52.021	14.569	-1.979	54.000	37.452	AV

	H	5148.655	73.476	36.022	-0.524	74.000	37.454	PK
	H	5150.000	67.460	30.008	-6.540	74.000	37.452	PK
	H	5150.000	52.534	15.082	-1.466	54.000	37.452	AV
	H	15536.250	42.006	29.850	-11.994	54.000	12.156	AV
	H	15543.500	57.288	45.132	-16.712	74.000	12.155	PK
	V	10358.500	47.960	35.781	-26.040	74.000	12.179	PK
	V	15535.000	50.508	38.352	-23.492	74.000	12.156	PK
M	H	15660.330	42.622	30.663	-11.378	54.000	11.959	AV
	H	15662.500	55.686	43.729	-18.314	74.000	11.958	PK
	V	10443.500	51.144	39.157	-22.856	74.000	11.986	PK
	V	15662.500	52.809	40.852	-21.191	74.000	11.958	PK
H	H	15720.240	40.966	29.197	-13.034	54.000	11.769	AV
	H	15722.000	55.023	43.261	-18.977	74.000	11.762	PK
	V	10486.000	51.505	39.218	-22.495	74.000	12.287	PK
	V	15730.500	50.769	39.008	-23.231	74.000	11.761	PK

802.11n40

Channel	Polarity	Frequency (MHz)	Measure Level (dBuV/m)	Reading Level (dBuV)	Over Limit (dB)	Limit (dBuV/m)	Factor (dB)	Type
L	V	5147.600	72.186	34.731	-1.814	74.000	37.455	PK
	V	5150.000	72.677	35.225	-1.323	74.000	37.452	PK
	V	5150.000	51.625	14.173	-2.375	54.000	37.452	AV
	H	5148.650	70.943	33.489	-3.057	74.000	37.454	PK
	H	5150.000	70.903	33.451	-3.097	74.000	37.452	PK
	H	5150.000	51.009	13.557	-2.991	54.000	37.452	AV
	H	15586.000	49.183	37.125	-24.817	74.000	12.058	PK
	V	15866.500	48.350	36.669	-25.650	74.000	11.680	PK
H	H	15688.000	53.614	41.703	-20.386	74.000	11.911	PK
	V	10452.000	51.007	38.975	-22.993	74.000	12.032	PK

802.11ac80

Channel	Polarity	Frequency (MHz)	Measure Level (dBuV/m)	Reading Level (dBuV)	Over Limit (dB)	Limit (dBuV/m)	Factor (dB)	Type
	V	5148.700	71.436	33.982	-2.564	74.000	37.454	PK
	V	5150.000	65.613	28.161	-8.387	74.000	37.452	PK
	V	5148.475	50.666	13.212	-3.334	54.000	37.454	AV
	V	5150.000	50.250	12.798	-3.750	54.000	37.452	AV
	H	5149.600	72.287	34.835	-1.713	74.000	37.452	PK
	H	5150.000	71.844	34.392	-2.156	74.000	37.452	PK
	H	5147.950	51.099	13.644	-2.901	54.000	37.455	AV
	H	5150.000	50.823	13.371	-3.177	54.000	37.452	AV
	H	11021.500	47.979	35.001	-26.021	74.000	12.978	PK
	H	15696.500	48.626	36.758	-25.374	74.000	11.868	PK
	V	11650.500	46.581	34.270	-27.419	74.000	12.311	PK
	V	15849.500	48.301	36.605	-25.699	74.000	11.695	PK

U-NII-3 Band:
802.11a

Channel	Polarity	Frequency (MHz)	Measure Level (dBuV/m)	Reading Level (dBuV)	Over Limit (dB)	Limit (dBuV/m)	Factor (dB)	Type
L	H	5650.000	63.971	26.184	-10.029	74.000	37.787	PK
	H	5700.000	64.985	27.093	-40.215	105.200	37.892	PK
	H	5720.000	75.440	37.471	-35.360	110.800	37.970	PK
	H	5725.000	80.124	42.134	-42.076	122.200	37.990	PK
	V	5650.000	63.988	26.201	-10.012	74.000	37.787	PK
	V	5700.000	67.311	29.419	-37.889	105.200	37.892	PK
	V	5720.000	81.783	43.814	-29.017	110.800	37.970	PK
	V	5725.000	87.763	49.773	-34.437	122.200	37.990	PK
	H	9840.000	46.142	34.524	-27.858	74.000	11.618	PK
	H	11489.000	49.534	36.780	-24.466	74.000	12.754	PK
	V	11489.000	51.069	38.315	-22.931	74.000	12.754	PK
	V	15730.500	48.601	36.840	-25.399	74.000	11.761	PK
M	V	11574.000	52.466	39.833	-21.534	74.000	12.633	PK
	V	17345.500	53.542	36.734	-20.458	74.000	16.808	PK
	H	11140.500	48.071	35.422	-25.929	74.000	12.648	PK
	H	11557.000	51.487	38.788	-22.513	74.000	12.699	PK
H	H	5850.000	73.548	35.095	-48.652	122.200	38.454	PK
	H	5855.000	72.608	34.143	-38.192	110.800	38.465	PK
	H	5875.000	64.561	26.064	-40.639	105.200	38.497	PK
	H	5925.000	64.719	26.186	-9.281	74.000	38.533	PK
	V	5850.000	83.210	44.757	-38.990	122.200	38.454	PK
	V	5855.000	81.689	43.224	-29.111	110.800	38.465	PK
	V	5875.000	68.240	29.743	-36.960	105.200	38.497	PK
	V	5925.000	65.030	26.497	-8.970	74.000	38.533	PK
	H	17481.500	54.157	36.855	-19.843	74.000	17.302	PK
	V	11650.500	52.164	39.853	-21.836	74.000	12.311	PK

802.11n20

Channel	Polarity	Frequency (MHz)	Measure Level (dBuV/m)	Reading Level (dBuV)	Over Limit (dB)	Limit (dBuV/m)	Factor (dB)	Type
L	H	5650.000	63.198	25.411	-10.802	74.000	37.787	PK
	H	5700.000	69.391	31.499	-35.809	105.200	37.892	PK
	H	5720.000	82.959	44.990	-27.841	110.800	37.970	PK
	H	5725.000	92.644	54.654	-29.556	122.200	37.990	PK
	V	5650.000	63.233	25.446	-10.767	74.000	37.787	PK
	V	5700.000	69.056	31.164	-36.144	105.200	37.892	PK
	V	5720.000	79.006	41.037	-31.794	110.800	37.970	PK
	V	5725.000	90.821	52.831	-31.379	122.200	37.990	PK
	V	11489.000	50.246	37.492	-23.754	74.000	12.754	PK
	H	11480.500	50.306	37.575	-23.694	74.000	12.731	PK
M	H	11582.500	49.830	37.219	-24.170	74.000	12.611	PK
	H	13384.500	45.464	31.778	-28.536	74.000	13.686	PK
	V	11582.500	51.976	39.365	-22.024	74.000	12.611	PK
	V	15594.500	48.326	36.210	-25.674	74.000	12.116	PK
H	H	5850.000	83.872	45.419	-38.328	122.200	38.454	PK
	H	5855.000	80.418	41.953	-30.382	110.800	38.465	PK
	H	5875.000	67.815	29.318	-37.385	105.200	38.497	PK
	H	5925.000	65.827	27.294	-8.173	74.000	38.533	PK
	V	5850.000	82.309	43.856	-39.891	122.200	38.454	PK
	V	5855.000	80.053	41.588	-30.747	110.800	38.465	PK
	V	5875.000	67.082	28.585	-38.118	105.200	38.497	PK
	V	5925.000	64.570	26.037	-9.430	74.000	38.533	PK
	H	11650.500	52.405	40.094	-21.595	74.000	12.311	PK
	H	13367.500	45.740	32.098	-28.260	74.000	13.643	PK
	V	11650.500	51.815	39.504	-22.185	74.000	12.311	PK
	V	15764.500	48.390	36.660	-25.610	74.000	11.730	PK

802.11n40

Channel	Polarity	Frequency (MHz)	Measure Level (dBuV/m)	Reading Level (dBuV)	Over Limit (dB)	Limit (dBuV/m)	Factor (dB)	Type
L	H	5641.913	66.713	28.928	-7.287	74.000	37.785	PK
	H	5650.000	65.047	27.260	-8.953	74.000	37.787	PK
	H	5700.000	76.471	38.579	-28.729	105.200	37.892	PK
	H	5720.000	90.530	52.561	-20.270	110.800	37.970	PK
	H	5725.000	95.281	57.291	-26.919	122.200	37.990	PK
	V	5636.837	66.310	28.536	-7.690	74.000	37.775	PK
	V	5650.000	64.873	27.086	-9.127	74.000	37.787	PK
	V	5700.000	73.941	36.049	-31.259	105.200	37.892	PK
	V	5720.000	88.534	50.565	-22.266	110.800	37.970	PK
	V	5725.000	91.041	53.051	-31.159	122.200	37.990	PK
	H	11506.000	49.614	36.860	-24.386	74.000	12.754	PK
	V	11506.000	49.421	36.667	-24.579	74.000	12.754	PK
H	H	5850.000	79.374	40.921	-42.826	122.200	38.454	PK
	H	5855.000	76.687	38.222	-34.113	110.800	38.465	PK
	H	5875.000	67.718	29.221	-37.482	105.200	38.497	PK
	H	5925.000	65.308	26.775	-8.692	74.000	38.533	PK
	H	5992.462	67.319	28.738	-6.681	74.000	38.581	PK
	V	5850.000	77.407	38.954	-44.793	122.200	38.454	PK
	V	5855.000	75.360	36.895	-35.440	110.800	38.465	PK
	V	5875.000	68.409	29.912	-36.791	105.200	38.497	PK
	V	5925.000	67.060	28.527	-6.940	74.000	38.533	PK
	V	5991.225	67.085	28.507	-6.915	74.000	38.578	PK
	H	11591.000	49.426	36.837	-24.574	74.000	12.589	PK
	V	14472.500	51.256	35.454	-22.744	74.000	15.802	PK

802.11ac80

Channel	Polarity	Frequency (MHz)	Measure Level (dBuV/m)	Reading Level (dBuV)	Over Limit (dB)	Limit (dBuV/m)	Factor (dB)	Type
	H	5649.600	66.944	29.157	-7.056	74.000	37.787	PK
	H	5650.000	65.569	27.782	-8.431	74.000	37.787	PK
	H	5700.000	79.220	41.328	-25.980	105.200	37.892	PK
	H	5720.000	81.132	43.163	-29.668	110.800	37.970	PK
	H	5725.000	83.831	45.841	-38.369	122.200	37.990	PK
	H	5850.000	81.677	43.224	-40.523	122.200	38.454	PK
	H	5855.000	80.539	42.074	-30.261	110.800	38.465	PK
	H	5875.000	73.819	35.322	-31.381	105.200	38.497	PK
	H	5925.000	65.884	27.351	-8.116	74.000	38.533	PK
	H	5932.200	68.739	30.209	-5.261	74.000	38.530	PK
	V	5646.600	66.596	28.810	-7.404	74.000	37.787	PK
	V	5650.000	65.484	27.697	-8.516	74.000	37.787	PK
	V	5700.000	79.857	41.965	-25.343	105.200	37.892	PK
	V	5720.000	80.500	42.531	-30.300	110.800	37.970	PK
	V	5725.000	83.036	45.046	-39.164	122.200	37.990	PK
	V	5850.000	78.922	40.469	-43.278	122.200	38.454	PK
	V	5855.000	77.572	39.107	-33.228	110.800	38.465	PK
	V	5875.000	72.533	34.036	-32.667	105.200	38.497	PK
	V	5925.000	66.065	27.532	-7.935	74.000	38.533	PK
	V	5933.800	68.129	29.602	-5.871	74.000	38.527	PK
	H	7698.000	46.034	38.057	-27.966	74.000	7.977	PK
	H	9126.000	45.552	35.892	-28.448	74.000	9.660	PK
	H	12849.000	46.097	34.182	-27.903	74.000	11.915	PK
	H	14812.500	51.081	35.857	-22.919	74.000	15.225	PK
	V	7698.000	46.054	38.077	-27.946	74.000	7.977	PK
	V	11548.500	47.848	35.130	-26.152	74.000	12.718	PK
	V	13070.000	46.318	33.953	-27.682	74.000	12.365	PK
	V	14753.000	51.682	36.108	-22.318	74.000	15.574	PK

FCC ID: 2ADZRA240ZA

8 Power line conducted emission

Test result: Pass

8.1 Limit

Frequency of Emission (MHz)	Conducted Limit (dBuV)	
	QP	AV
0.15-0.5	66 to 56*	56 to 46 *
0.5-5	56	46
5-30	60	50

* Decreases with the logarithm of the frequency.

8.2 Test configuration

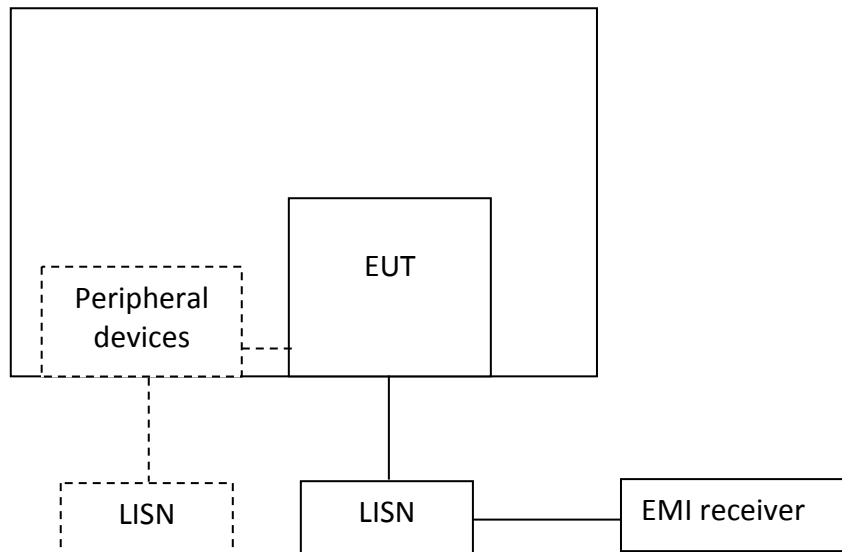

For table top equipment, wooden support is 0.8m height table

For floor standing equipment, wooden support is 0.1m height rack.

8.3 Test procedure and test set up

Measured levels of ac power-line conducted emission shall be the emission voltages from the voltage probe, where permitted, or across the 50 Ω LISN port (to which the EUT is connected), where permitted, terminated into a 50 Ω measuring instrument. All emission voltage and current measurements shall be made on each current-carrying conductor at the plug end of the EUT power cord by the use of mating plugs and receptacles on the LISN, if used. Equipment shall be tested with power cords that are normally supplied or recommended by the manufacturer and that have electrical and shielding characteristics that are the same as those cords normally supplied or recommended by the manufacturer. For those measurements using a LISN, the 50 Ω measuring port is terminated by a measuring instrument having 50 Ω input impedance. All other ports are terminated in 50 Ω loads.

Tabletop devices shall be placed on a platform of nominal size 1 m by 1.5 m, raised 80 cm above the reference ground plane. The vertical conducting plane or wall of an RF-shielded (screened) room shall be located 40 cm to the rear of the EUT. Floor-standing devices shall be placed either directly on the reference ground-plane or on insulating material as described in ANSI C63.4. All other surfaces of tabletop or floor-standing EUTs shall be at least 80 cm from any other grounded conducting surface, including the case or cases of one or more LISNs.

The bandwidth of the test receiver is set at 9 kHz.

8.4 Test protocol

Temperature: 25 °C
Relative Humidity: 55 %

L line:

Test Curve:

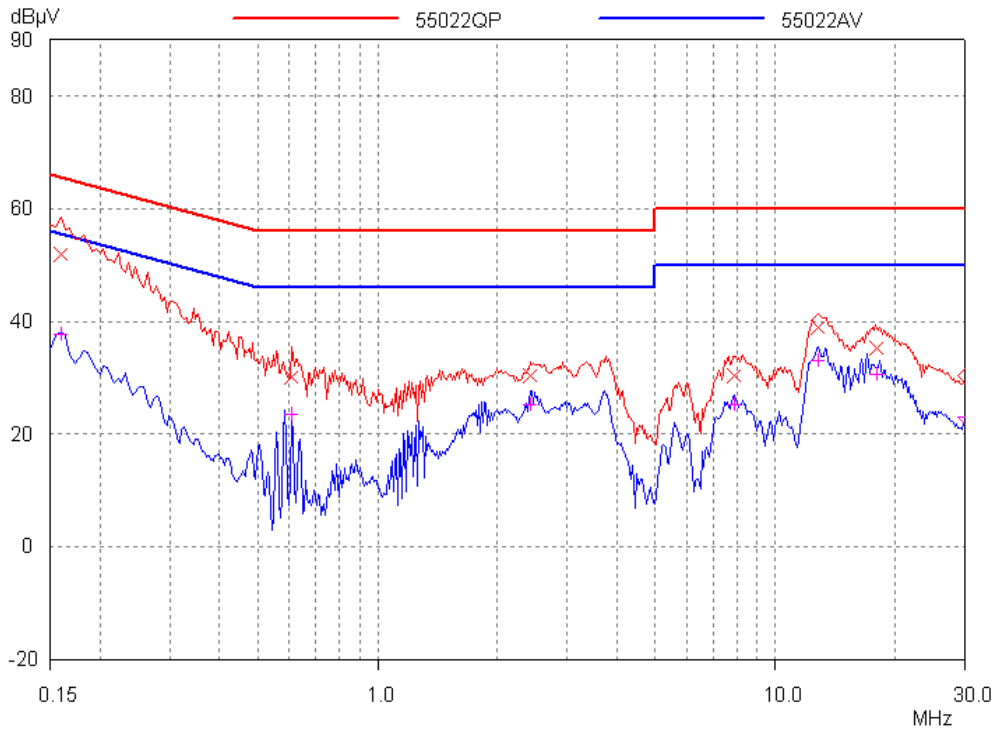

Test Data:

Frequency (MHz)	Quasi-peak			Frequency (MHz)	Average		
	Level dB(µV)	Limit dB(µV)	Margin dB		Level dB(µV)	Limit dB(µV)	Margin dB
0.159	52.00	65.52	13.52	0.159	37.66	55.52	17.86
0.6045	30.03	56.00	25.97	0.6045	23.60	46.00	22.40
2.4045	30.43	56.00	25.57	2.4045	25.16	46.00	20.84
7.8225	30.41	60.00	29.59	7.8225	25.28	50.00	24.72
12.714	38.89	60.00	21.11	12.714	32.96	50.00	17.04
17.889	35.15	60.00	24.85	17.889	30.52	50.00	19.48

N line:

Test Curve:

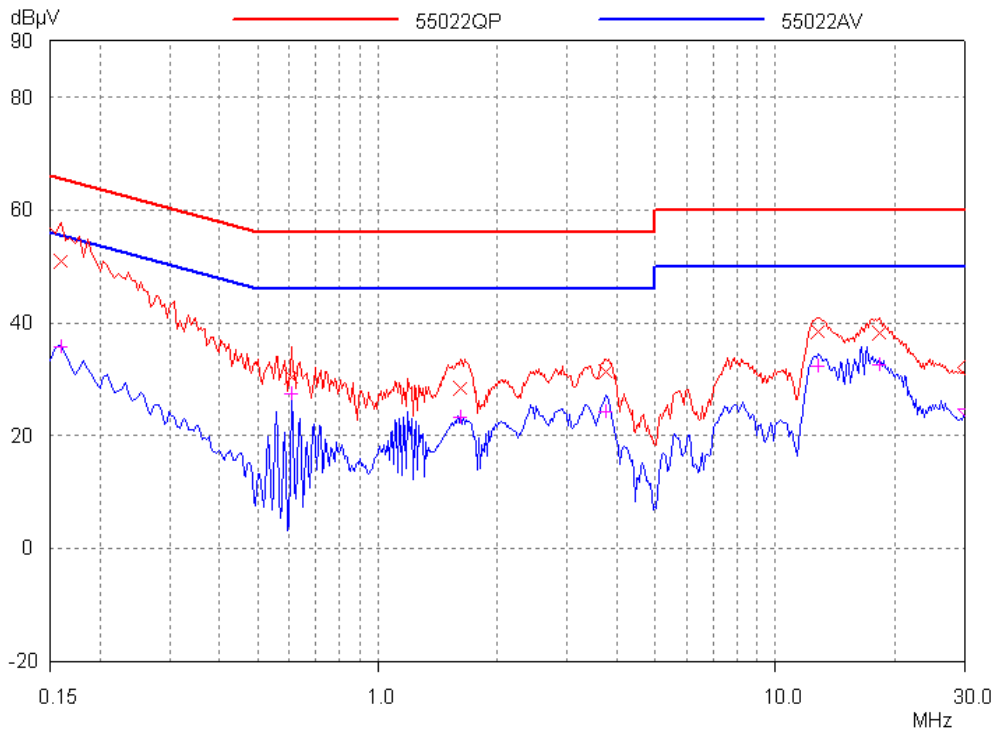

Test Data:

Frequency (MHz)	Quasi-peak			Frequency (MHz)	Average		
	Level dB(µV)	Limit dB(µV)	Margin dB		Level dB(µV)	Limit dB(µV)	Margin dB
0.159	51.01	65.52	14.51	0.159	35.72	0.159	35.72
0.609	30.45	56.00	25.55	0.609	27.35	0.609	27.35
1.6125	28.50	56.00	27.50	1.6125	23.23	1.6125	23.23
3.723	31.45	56.00	24.55	3.723	24.31	3.723	24.31
12.777	38.36	60.00	21.64	12.777	32.27	12.777	32.27
18.276	38.14	60.00	21.86	18.276	32.44	18.276	32.44

9 Frequency Stability

Test result: Pass

9.1 Limit

Manufacturers of U-NII devices are responsible for ensuring frequency stability such that an emission is maintained within the band of operation under all conditions of normal operation as specified in the user's manual.

9.2 Block Diagram of Test Setup

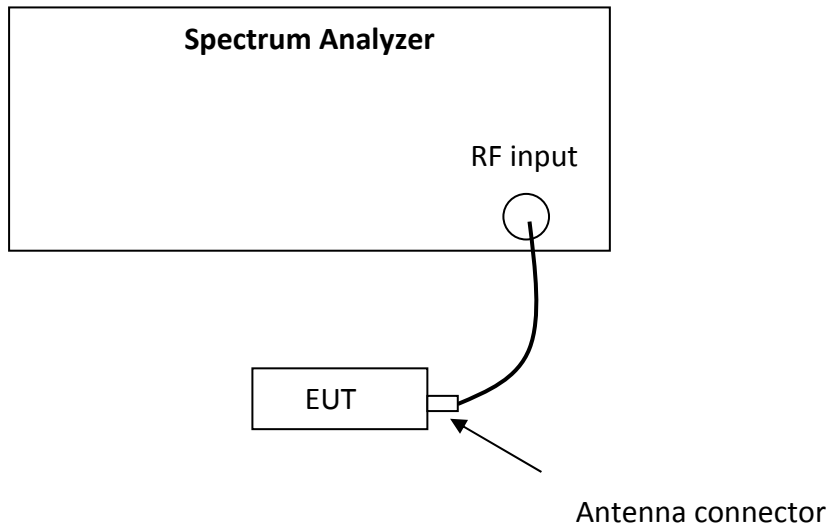

9.3 Test Procedure and Test Setup

- a) To ensure emission at the band edge is maintained within the authorized band, those values shall be measured by radiation emissions at upper and lower frequency points, and finally compensated by frequency deviation as procedures below.
- b) The EUT was operated at the maximum output power, and connected to the spectrum analyzer, which is set to maximum hold function and peak detector. The peak value of the power envelope was measured and noted. The upper and lower frequency points were respectively measured relatively 10dB lower than the measured peak value.
- c) The frequency deviation was calculated by adding the upper frequency point and the lower frequency point divided by two. Those detailed values of frequency deviation are provided in table below.

9.4 Test Protocol

Temperature: 25 °C
Relative Humidity: 55 %

Mode	Frequency (MHz)	Low Frequency (MHz)	High Frequency (MHz)	Mid Frequency (MHz)	Frequency Stability (ppm)
802.11a	5180	5171.65	5188.25	5179.95	-9.653
	5220	5211.70	5228.30	5220.00	0
	5240	5231.70	5248.30	5240.00	0
802.11n HT20	5180	5171.10	5188.90	5180.00	0
	5220	5211.10	5228.90	5220.00	0
	5240	5231.10	5248.90	5240.00	0
802.11n HT40	5190	5171.73	5208.27	5190.00	0
	5230	5211.64	5248.18	5229.91	-17.208
802.11 ac80	5210	5172.18	5247.86	5210.02	3.839

Note: Mid Frequency = (Low Frequency + High Frequency) / 2.

9.5 Measurement uncertainty

Measurement uncertainty: $\pm 0.84 \times 10^{-7}$