

## VenusLiv V2

User Manual

V1.0.0

## Packing List

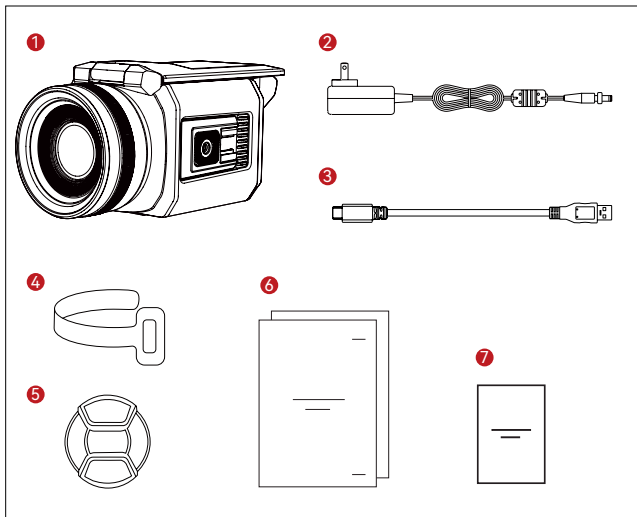

① VenusLiv V2	1
② 12V/2A Power Adapter	1
③ USB Cable	1
④ Cable Tie	1
⑤ Lens Cap	1
⑥ User Manual & Packing List card	1
⑦ Warranty Card	1

## Product Overview

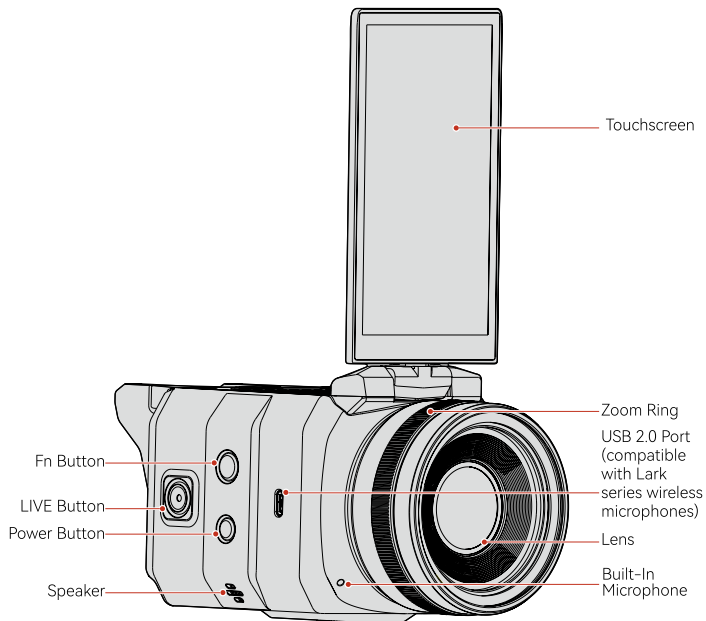

## Product Overview

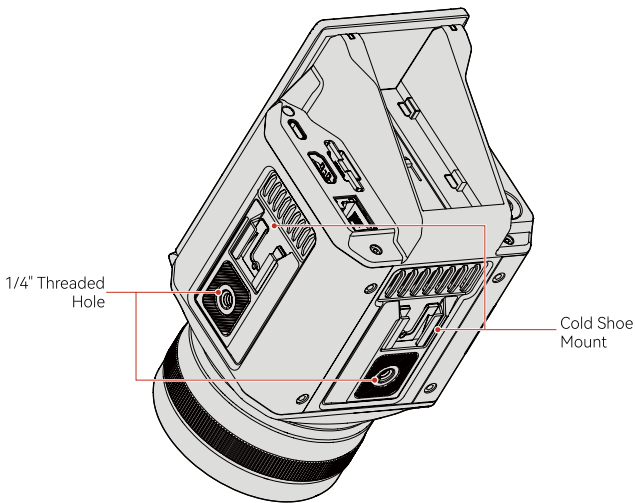
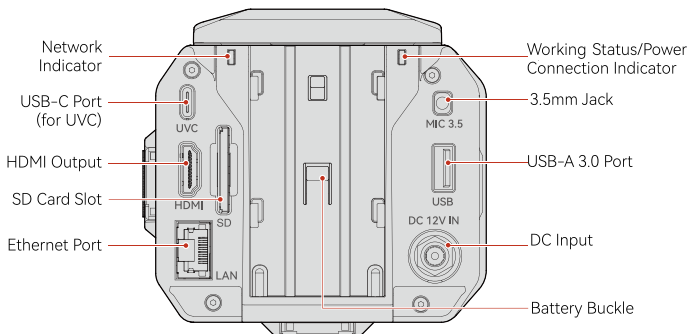

# Streaming Introduction

## UVC Streaming

1. Connect the camera to a computer using a USB cable; ensure that both the computer's USB port and the cable support the 3.0 standard.
2. Open the streaming software on the computer.
3. Select **Hollyland PRO CAM** as the video source and **Hollyland** as the audio source, then start streaming.

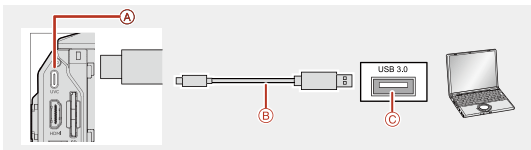

## Streaming via Switcher

1. Connect the camera to a switcher using an HDMI 1.4 or higher cable.
2. Tap , choose **More Settings**, and select **Extend**. It is not recommended to use **Mirroring** for streaming.
3. After the switcher displays video and audio readings, make sure the switcher is connected to the network, enter the streaming URL, and then start streaming.

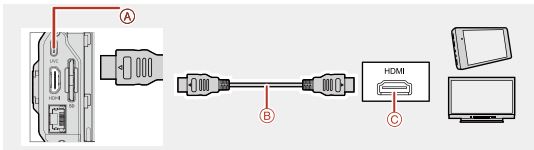

## RTMP Streaming

1. Make sure the camera is connected to the network.
2. Open the RTMP app, and tap **Add** to enter the streaming URL to start streaming.

# Product Introduction

## Button Introduction

### 1. Power Button

- Long press for 3s to power on/off the camera.



### 2. Fn Button

- Press once to show/hide the volume bar.

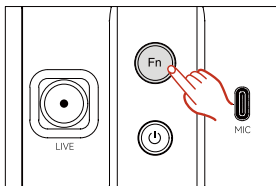

### 3. LIVE Button

- Press once to open the most recently used app.
- Press once on the built-in camera app's interface to take photos or record videos. Make sure an SD card or USB flash drive is inserted.

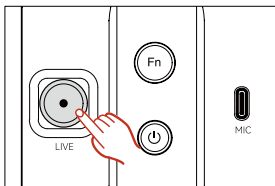

## Indicator Introduction

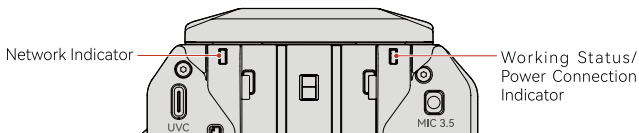

# Product Introduction

1. Network Indicator
  - Solid green: normal status
  - Solid red: abnormal status
  - Light off: camera in initialization
2. Working Status/Power Connection Indicator
  - Solid green: normal status
  - Slowly flashing green: camera in initialization
  - Solid red: abnormal status, for example, storage error and low battery.
  - Slowly flashing red: firmware upgrading
  - Solid yellow: powered by DC power while powered off

## Port Introduction

1. USB 2.0 Port
  - For connection to Lark series wireless microphones.

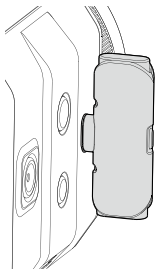

2. USB-C Port
  - For UVC. Connect the camera to a computer using a USB cable. Using a cable lower than USB 3.0 may result in video display issues.

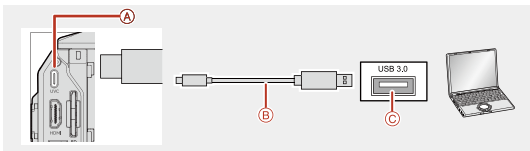

## Product Introduction

### 3. HDMI Port

- For connection to TV, capture card, switcher, etc.
- Mirroring mode: outputs the display from the camera's touchscreen
- Extend mode: outputs only the audio and video streams (without UI interface).

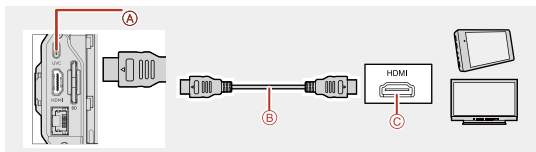

### 4. Ethernet Port

- For network connection.

### 5. 3.5mm Jack

- For connection to TRS microphones or line-in devices.

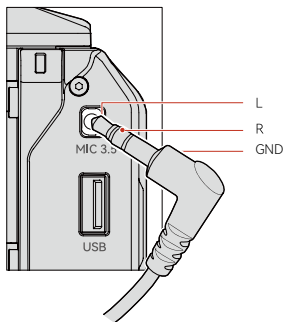

### 6. USB-A 3.0 Port

- For connection to a USB flash drive to store photos or videos or to a mouse or keyboard to control the camera.
- For connection to another camera to add a video source.

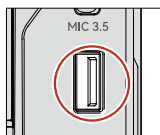

### Note:

- Do not remove the USB flash drive while the camera is transferring or accessing information. Doing so may result in data loss or damage, even damage to the USB flash drive or camera. Turn off the camera before replacing or removing the USB flash drive. Hollyland is not responsible for any loss caused by misuse of a damaged USB flash drive.
- When shooting regular videos, use a Class 10 or higher USB flash drive. The maximum file size for each video is 4GB.
- If storage errors occur, please check or replace your USB flash drive.



# Product Introduction

## 7. DC Input

- For power supply. Use the provided power adapter to avoid damage to the camera.

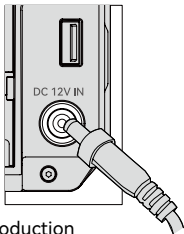

## Slot Introduction

### 1. SD Slot

- For inserting an SD card. Insert the SD card into the slot until it clicks into place; press the SD card until you hear a click sound to eject the SD card.

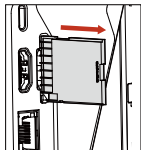
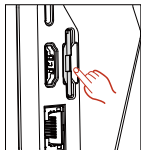
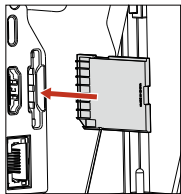

- **Note:** Do not remove the SD card while the camera is transferring or accessing information. Doing so may result in data loss or damage, even damage to the SD card or camera. Turn off the camera before replacing or removing the SD card. Hollyland is not responsible for any loss caused by misuse of a damaged SD card.
  - When shooting regular videos, use a Class 10 or higher SD card. The maximum file size for each video is 4GB.
  - If storage errors incur, please check or replace your SD card.
- ### 2. Battery Slot
- For battery power supply. Align the charging contacts and insert the battery into the slot to install the battery; press the release button and slide the battery upward to remove the battery.

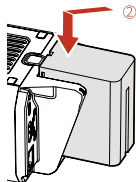
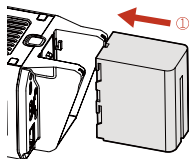

## Product Introduction

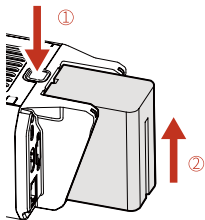

### Hole and Mount Introduction

#### 1. 1/4" Threaded Hole

- For securing the camera. Use a tripod to secure the camera via the 1/4" threaded hole with two mounting methods: vertical and horizontal.

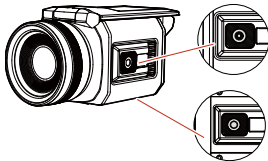

#### 2. Cold Shoe Mount

- For mounting external devices.

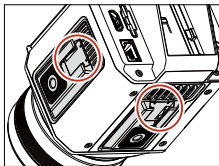

### Moveable Parts Introduction

#### 1. Zoom Ring

- Rotating the zoom ring to the left decreases the focal length.
- Rotating the zoom ring to the right increases the focal length.

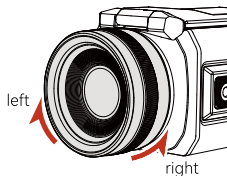

#### 2. Touchscreen



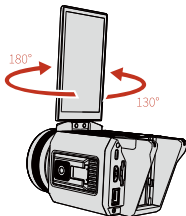
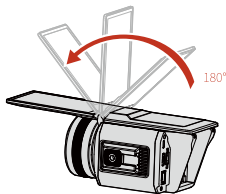







- Upward: The screen can flip up 180°, do not overflip.
- Leftward: The screen can rotate left 180°, do not overrotate.
- Rightward: The screen can rotate right 130°, do not overrotate.



## Navigation Gesture

- Swipe down from the top of the screen to access the Quick Settings interface.
- Swipe up from the bottom of the screen to enter the home page.
- Swipe left or right to return to the previous interface.

## Status Bar

-  : The camera is connected to a Wi-Fi network.
-  : The camera is connected to an Ethernet network.
-  : The camera is connected to a wireless network card.
-  : The camera has no network connection.
-  : The USB-C Port is in use.
-  : The camera is connected to a wireless microphone.
-  : The 3.5mm jack is in use.
-  : The Bluetooth function is enabled.
-  : A USB flash drive is inserted.
-  : The camera is powered by DC power.
-  : The camera is powered by a battery.
- 20:30** : Current Time

## Quick Settings

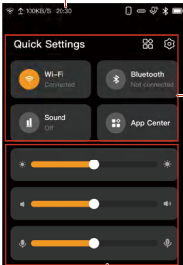
- Time and Date
- 
- Settings
  - Wi-Fi
  - Bluetooth
  - Sound
  - App Center
- Screen Brightness Bar
  - Speaker Volume Bar
  - Microphone Gain Bar
1. Settings  
Tap to enter the Settings interface.
  2. Wi-Fi  
Tap to turn on/off the Wi-Fi connection. Tap and hold to enter the Wi-Fi interface.
  3. Bluetooth  
Tap to turn on/off Bluetooth. Tap and hold to enter the Bluetooth interface.
  4. Sound  
Tap to show/hide the volume bar.
  5. App Center  
Tap to view the built-in apps.
  6. Screen Brightness Bar  
Adjusts the screen brightness.

7. Speaker Volume Bar  
Adjusts the speaker volume.
8. Microphone Gain Bar  
Adjusts the microphone gain.

## Built-In Apps

### RTMP

1. Connect the camera to the network.
2. Open the RTMP app .
3. Tap **Add** to enter the streaming URL.
4. There are two ways to enter the streaming URL.
  - Use any app with a QR code scanning feature such as the Camera app in the streaming name and URL and tap **Submit**. The camera will receive the streaming information, and tap **Finish** to complete.
  - Manually fill in the streaming name and URL on the interface and tap **Finish** to complete.
5. Set resolution, frame rate, and bitrate according to your needs and the network upstream bandwidth on the interface.
6. Start Streaming.

### Photo/Record

1. Open the Photo/Record app to take photos or record videos.
2. Tap the settings icon on the Record interface to set resolution, frame rate,

and bitrate according to your needs and the SD card storage capacity.

**Note:** Photos and videos can only be stored on external devices. Make sure an SD card or USB flash drive is inserted. You can view the corresponding file through the Gallery app or File Manager on the Settings interface.

## App Store

A built-in app store is provided so you can download apps as necessary. When connected to the network, VenusLiv V2 alone achieves a smooth livestreaming with the following powerful functions.

- Zoom in or out.
- Add overlays.
- Remove the background and add a background.
- Color Correction Magic, perfecting the visuals by adjusting saturation and brightness, etc.

## Toolbox

Tap  to enter the Toolbox interface to configure scenes, adjust the color, remove the background, add overlays, and enter the More Settings interface to explore more.

## Settings Interface Introduction

Click the settings icon on the Quick Settings interface to enter the Settings interface.

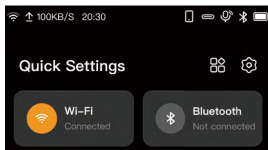

### 1. Wi-Fi

- Tap to enter the Wi-Fi interface.

### 2. Wired Network

Tap to enter the Wired Network interface.

- Turned on by default. When a network cable is connected, the camera automatically connects to the network.
- Depending on your needs, you can manually input the IP address. Turn off Get IP Automatically, input the IP address, subnet mask, and default gateway, and then click **Save**. Turn on Get IP Automatically, the camera automatically acquires IP information.
- Depending on your needs, you can manually input the DNS addresses. Turn off Get DNS Automatically, input the primary and secondary DNS addresses, and then click **Save**. Turn on Get DNS Automatically, the camera automatically acquires the DNS addresses.

### 3. Bluetooth

Tap to enter the Bluetooth interface.

- Turn on/off Bluetooth based on your needs.
- Tap **Device Name** to change the name.
- When turned on, the camera will automatically search for nearby Bluetooth devices. Tap the device to be paired in the list and follow the on-screen prompts to complete the pairing. Long press the device, and tap **Delete** to unpair.

### 4. File Manager

Tap to view photos and videos stored on external devices.

## Specifications

CPU	Qualcomm Snapdragon 8 Series	
CMOS	Sony 1/2"	
Pixel	12 megapixel	
Focal Length	24 - 70mm	
Aperture	F6.3 - F10	
Minimum Shooting Distance	50cm	
FOV	80° (Horizontal), 46° (Vertical)	
Zoom	1 - 6x (3x optical and 2x digital)	
Focus	Fast hybrid focus	
OS	HollyOS 2.0	
Weight	≈ 1,000g (35.3oz)	
Dimensions(L × W × H)	178 × 99.7 × 94.8mm (7 × 3.9 × 3.7")	
Power Consumption	≤ 15W	
DC Voltage	DC 12V	
Wireless Technology	Wi-Fi: 2.4 GHz and 5 GHz	Bluetooth 5.1
Working Temperature	-10°C - 40°C	
Touchscreen	5" LCD	1080 × 1920px
Battery	NP-F batteries	
Port	DC Input	Power Port
	3.5mm Jack	Standard
	HDMI Output	HDMI 2.0
	SD Card Slot	Standard
	UVC	USB-C 3.1
	Wireless Microphone	USB-C 2.0
	USB-A	USB 3.0
LAN	Ethernet port (1 Gbps)	

## Warning

### Warning :

If you fail to take the following precautions, you may be seriously injured or killed by the electric shock or fire disaster caused, or your VenusLiv V2 may be damaged. Please check whether the camera and accessories are intact before using them. For security reasons, only Hollyland accessories that are provided with the camera or genuine ones purchased can be used. The use of any other parts, accessories, or chargers not recommended by Hollyland may cause fire disaster, electric shock, or personal injury. Damage caused by the use of unauthorized accessories is not covered by the warranty. For approved accessories, please visit the Hollyland official website at <https://www.hollyland.com>.







1. Do not touch the plug or adapter with wet hands when connecting the camera to the adapter. Failure to follow this precaution may cause electric shock.
  2. Do not place or fix the camera on an unstable surface. Failure to follow this precaution may cause the camera to loosen or fall off, causing an accident or damage to the camera.
  3. When using an external power supply connection, please follow all the security rules of the third-party power supply device.
  4. The lens of the VenusLiv V2 is made of glass. If the lens is damaged, please handle it carefully to avoid being scratched by the broken lens/glass, and keep it away from children.
  5. The temperature of the camera may rise during operation. If this occurs, turn off the camera and leave it to cool before using it again.
  6. This product is not a toy and you are solely responsible for complying with all local laws, regulations, and restrictions.
  7. Do not use the VenusLiv V2 for unauthorized monitoring, candid shooting, or in any way that violates personal privacy regulations. Normally, it is strictly forbidden to use the camera for such purposes. If you fail to follow this precaution, you may bear huge responsibilities and face criminal proceedings.
  8. Do not put the camera in extremely cold or hot environments. Extremely cold or hot environments may cause the camera to temporarily stop working properly.
- \* Note: There is no protection for the lens of the VenusLiv V2. If you do not pay attention to it, it is easy to cause scratches. Please store the VenusLiv V2 in the provided box and avoid placing the lens on any surface. Lens scratches are not covered by the warranty.

## Disclaimer

1. Read and follow all the instructions carefully.
2. Note all the warnings.
3. Do not use the product near heat sources such as radiators, electric heaters, stoves, or other heat-producing equipment.
4. Use only parts and accessories specified or provided by Hollyland.
5. Hand over all maintenance work to qualified personnel. No matter what kind of damage the product suffers, such as damage to the power cable or plug, liquid penetration, objects falling into the product, rain, dampness, failure to work normally, or fall, maintenance is required.



If you encounter any problems in using the product or need any help, please contact Hollyland Support Team via the following ways:

-  Hollyland User Group
-  HollylandTech
-  HollylandTech
-  HollylandTech
-  support@hollyland.com
-  www.hollyland.com

**Statement:**

All copyrights belong to Shenzhen Hollyland Technology Co., Ltd. Without the written approval of Shenzhen Hollyland Technology Co., Ltd., no organization or individual may copy or reproduce part or all of any written or illustrative content and disseminate it in any form.

**Trademark Statement:**

All the trademarks are owned by Shenzhen Hollyland Technology Co., Ltd.

Note: Due to product version upgrades or other reasons, this User Manual will be updated from time to time. Unless otherwise agreed, this document is provided as a guide for use only. All representations, information, and recommendations in this document do not constitute warranties of any kind, express, or implied.

## FCC Requirement

The device complies with the FCC rules, Part 15. Operation is subject to the following two conditions:

1. This device may not cause harmful interference, and
2. This device must accept any interference received, including interference that may cause undesired operation.

Changes or modifications not expressly approved by the party responsible for compliance could void the user's authority to operate the equipment.

This equipment has been tested and found to comply with the limits for a Class B digital device, pursuant to part 15 of the FCC Rules. These limits are designed to provide reasonable protection against harmful interference in a residential installation. This equipment generates, uses and can radiate radio frequency energy and, if not installed and used in accordance with the instruction manual, may cause harmful interference to radio communications. However, there is no guarantee that interference will not occur in a particular installation. If this equipment does cause harmful interference to radio or television reception, which can be determined by turning the equipment off and on, the user is encouraged to try to correct the interference by one or more of the following measures:

1. Reorient or relocate the receiving antenna.
2. Increase the separation between equipment and receiver.
3. Connect the equipment into an outlet on a circuit different from that to which the receiver is connected.
4. Consult the dealer or an experienced radio/TV technician for help.

### **FCC Radiation Exposure Statement:**

This equipment complies with FCC radiation exposure limits set forth for an uncontrolled environment.

This transmitter must not be co-located or operating in conjunction with any other antenna or transmitter.

# **HOLLYVIEW**

Powered by Hollyland

**Shenzhen Hollyland Technology Co., Ltd.**

---

8F,5D Building, Skyworth Innovation Valley,  
Tangtou Road, Shiyan Street, Baoan District, Shenzhen, 518108,

**Made in China**