

# TEST REPORT

Applicant Name: Shenzhen Hollyland Technology Co.,Ltd  
Address: 8F, Building 5D, Skyworth Innovation Valley, Tangtou Road, Shiyuan Street, Baoan District, Shenzhen, 518055 China  
Report Number: 2401U43539E-RF-00  
FCC ID: 2ADZC-9622T

**Test Standard (s)**  
FCC PART 15.407

## Sample Description

Product Type: WIRELESS VIDEO TRANSMISSION SYSTEM  
Model No.: Cosmo C2  
Multiple Model(s) No.: N/A  
Trade Mark:  **HOLLYLAND**  
Date Received: 2024/07/01  
Issue Date: 2024/11/19

|              |       |
|--------------|-------|
| Test Result: | Pass▲ |
|--------------|-------|

▲ In the configuration tested, the EUT complied with the standards above.

**Prepared and Checked By:**

*Ekko Wu*

Ekko Wu  
RF Engineer

**Approved By:**

*Nancy Wang*

Nancy Wang  
RF Supervisor

Note: The information marked # is provided by the applicant, the laboratory is not responsible for its authenticity and this information can affect the validity of the result in the test report. Customer model name, addresses, names, trademarks etc. are included.

This report cannot be reproduced except in full, without prior written approval of the Company. Unless otherwise stated the results shown in this test report refer only to the sample(s) tested. This report is valid only with a valid digital signature. The digital signature may be available only under the Adobe software above version 7.0.

This report must not be used by the customer to claim product certification, approval, or endorsement by NVLAP or any agency of the U.S. Government.

This report may contain data that are not covered by the NVLAP accreditation and are marked with an asterisk "▼".

**Bay Area Compliance Laboratories Corp. (Shenzhen)**

5F(B-West) , 6F, 7F, the 3rd Phase of Wan Li Industrial Building D, Shihua Rd, FuTian Free Trade Zone, Shenzhen, China  
Tel: +86-755-33320018 Fax: +86-755-33320008 www.baclcorp.com.cn

**TABLE OF CONTENTS**

**DOCUMENT REVISION HISTORY .....4**

**GENERAL INFORMATION.....5**

    PRODUCT DESCRIPTION FOR EQUIPMENT UNDER TEST (EUT) .....5

    OBJECTIVE .....5

    TEST METHODOLOGY .....5

    MEASUREMENT UNCERTAINTY .....6

    TEST FACILITY .....6

**SYSTEM TEST CONFIGURATION .....7**

    DESCRIPTION OF TEST CONFIGURATION .....7

    EUT EXERCISE SOFTWARE .....7

    DUTY CYCLE .....8

    EQUIPMENT MODIFICATIONS .....9

    SUPPORT EQUIPMENT LIST AND DETAILS .....9

    EXTERNAL I/O CABLE .....10

    BLOCK DIAGRAM OF TEST SETUP .....10

**SUMMARY OF TEST RESULTS .....14**

**TEST EQUIPMENT LIST .....15**

**FCC 1.1307 (B) & §2.1091- MPE-BASED EXEMPTION .....17**

    APPLICABLE STANDARD .....17

    RESULT .....17

**FCC §15.203 - ANTENNA REQUIREMENT.....18**

    APPLICABLE STANDARD .....18

    ANTENNA CONNECTOR CONSTRUCTION .....18

**FCC §15.407 (B) (6) §15.207 (A) - CONDUCTED EMISSIONS.....19**

    APPLICABLE STANDARD .....19

    EUT SETUP .....19

    EMI TEST RECEIVER SETUP.....19

    TEST PROCEDURE .....19

    FACTOR & OVER LIMIT CALCULATION.....20

    TEST DATA .....20

**§15.205 & §15.209 & §15.407(B) - UNDESIRABLE EMISSION.....25**

    APPLICABLE STANDARD .....25

    EUT SETUP .....25

    EMI TEST RECEIVER & SPECTRUM ANALYZER SETUP .....27

    TEST PROCEDURE .....27

    FACTOR & OVER LIMIT/MARGIN CALCULATION .....28

    TEST DATA .....28

**FCC §15.407(A), (E) - 26 DB & 6DB EMISSION BANDWIDTH .....74**

    APPLICABLE STANDARD .....74

    TEST PROCEDURE .....74

    TEST DATA .....75

**FCC §15.407(A) - CONDUCTED TRANSMITTER OUTPUT POWER .....81**  
    APPLICABLE STANDARD ..... 81  
    TEST PROCEDURE ..... 81  
    TEST DATA ..... 82

**FCC §15.407(A) - POWER SPECTRAL DENSITY .....83**  
    TEST PROCEDURE ..... 83  
    TEST DATA ..... 84

**EUT PHOTOGRAPHS.....89**

**TEST SETUP PHOTOGRAPHS .....90**

**DOCUMENT REVISION HISTORY**

| Revision Number | Report Number     | Description of Revision | Date of Revision |
|-----------------|-------------------|-------------------------|------------------|
| 0               | 2401U43539E-RF-00 | Original Report         | 2024/11/19       |

## GENERAL INFORMATION

### Product Description for Equipment under Test (EUT)

|  |   |
|--|---|
| Product  | WIRELESS VIDEO TRANSMISSION SYSTEM  |
| Tested Model   | Cosmo C2  |
| Multiple Model(s)  | N/A   |
| Frequency Range  | 5G: 5185-5225MHz; 5760-5820MHz  |
| Maximum Conducted Average Output Power                                       | 5185-5225MHz: 11.77dBm<br>5760-5820MHz: 21.28dBm  |
| Modulation Technique   | OFDM  |
| Antenna Specification <sup>#</sup>   | 5185-5225MHz: 5.45dBi (Blade Antenna), 3.31dBi (Mushroom Antenna)<br>5760-5820MHz: 4.34dBi (Blade Antenna), 3.14dBi (Mushroom Antenna)<br>(provided by the applicant) |
| Voltage Range  | DC 6-16V from DC Port or DC6.8-8.4V from Battery  |
| Sample serial number   | 2NRQ-2 for Conducted and Radiated Emissions Test<br>2NRQ-3 for RF Conducted Test (Assigned by BAACL, Shenzhen)  |
| Sample/EUT Status  | Good condition  |
| Adapter Information  | Model: GQ24-120200-AX<br>Input: AC 100-240V, 50/60Hz, 1.0A Max<br>Output: DC 12.0V, 2.0A, 24.0W   |
| Note: Test Voltage: Battery: 7.4V <sub>DC</sub> , DC Port: 12V <sub>DC</sub> |   |

### Objective

This test report is in accordance with Part 2-Subpart J, Part 15-Subparts A and E of the Federal Communication Commissions rules.

The tests were performed in order to determine compliance with FCC Part 15, Subpart E, section 15.203, 15.205, 15.207, 15.209 and 15.407 rules.

### Test Methodology

All measurements contained in this report were conducted with ANSI C63.10-2013, American National Standard of Procedures for Compliance Testing of Unlicensed Wireless Devices. And KDB789033 D02 General U-NII Test Procedures New Rules v02r01.

All emissions measurement was performed at Bay Area Compliance Laboratories Corp. (Shenzhen). The radiated testing was performed at an antenna-to-EUT distance of 3 meters.

Each test item follows test standards and with no deviation.

**Measurement Uncertainty**

| Parameter                          |                                      | Uncertainty                             |
|------------------------------------|--------------------------------------|---|
| Occupied Channel Bandwidth         |                                      | ±5%                                     |
| RF Frequency                       |                                      | 213.55 Hz(k=2, 95% level of confidence) |
| RF output power, conducted         |                                      | 0.72 dB(k=2, 95% level of confidence)   |
| Unwanted Emission, conducted       |                                      | 1.75 dB(k=2, 95% level of confidence)   |
| AC Power Lines Conducted Emissions | 9kHz-150kHz                          | 3.94dB(k=2, 95% level of confidence)    |
|                                    | 150kHz-30MHz                         | 3.84dB(k=2, 95% level of confidence)    |
| Radiated Emissions                 | 9kHz - 30MHz                         | 3.30dB(k=2, 95% level of confidence)    |
|                                    | 30MHz~200MHz (Horizontal)            | 4.48dB(k=2, 95% level of confidence)    |
|                                    | 30MHz~200MHz (Vertical)              | 4.55dB(k=2, 95% level of confidence)    |
|                                    | 200MHz~1000MHz (Horizontal)          | 4.85dB(k=2, 95% level of confidence)    |
|                                    | 200MHz~1000MHz (Vertical)            | 5.05dB(k=2, 95% level of confidence)    |
|                                    | 1GHz - 6GHz                          | 5.35dB(k=2, 95% level of confidence)    |
|                                    | 6GHz - 18GHz                         | 5.44dB(k=2, 95% level of confidence)    |
| 18GHz - 40GHz                      | 5.16dB(k=2, 95% level of confidence) |   |
| Temperature                        |                                      | ±1°C                                    |
| Humidity                           |                                      | ±1%                                     |
| Supply voltages                    |                                      | ±0.4%                                   |

*Note: The extended uncertainty given in this report is obtained by combining the standard uncertainty times the coverage factor K with the 95% confidence interval. Otherwise required by the applicant or Product Regulations, Decision Rule in this report did not consider the uncertainty.*

**Test Facility**

The Test site used by Bay Area Compliance Laboratories Corp. (Shenzhen) to collect test data is located on the 5F(B-West) , 6F, 7F, the 3rd Phase of Wan Li Industrial Building D, Shihua Rd, FuTian Free Trade Zone, Shenzhen, China.

The lab has been recognized as the FCC accredited lab under the KDB 974614 D01 and is listed in the FCC Public Access Link (PAL) database, FCC Registration No. : 715558, the FCC Designation No. : CN5045.

**SYSTEM TEST CONFIGURATION**

**Description of Test Configuration**

The system was configured for testing in an engineering mode, which was provided by manufacturer.

**Frequency List<sup>#</sup>**

For 5150-5250MHz Band, 3 channels are provided to testing:

| Channel | Frequency (MHz) | Channel | Frequency (MHz) |
|---------|-----------------|---------|-----------------|
| 1       | 5185            | 2       | 5205            |
| 3       | 5225            | /       | /               |

EUT was tested with channel 1, 2 and 3.

For 5725-5850MHz Band, 4 channels are provided to testing:

| Channel | Frequency (MHz) | Channel | Frequency (MHz) |
|---------|-----------------|---------|-----------------|
| 1       | 5760            | 2       | 5780            |
| 3       | 5800            | 4       | 5820            |

EUT was tested with channel 1, 2 and 4.

CE/RE Test Modes:

- Test Mode1: Transmitting + HDMI Input
- Test Mode2: Transmitting + SDI Input +SDI Loopout
- Test Mode3: Transmitting

**EUT Exercise Software**

“Artosyn8030PCTool”<sup>#</sup> software was used and power level as below. The software and power level was provided by the applicant. The device was tested with the worst case was performed as below:

| Band         | Mode | Data rate | Power Level <sup>#</sup> |                |              |
|--------------|------|-----------|--------------------------|----------------|--------------|
|              |      |           | Low Channel              | Middle Channel | High Channel |
| 5185-5225MHz | OFDM | MCS0      | 0B                       | 0B             | 0B           |
| 5760-5820MHz | OFDM | MCS0      | 0B                       | 0B             | 0B           |

Note:

1. The worst-case data rates are determined to be as above for each mode based upon investigation by measuring the average power and PSD across all data rates bandwidths, and modulations.
2. The device supports SISO and MIMO 2T2R modes, per pretest, 2T2R mode was the worst mode and reported.
3. All the antenna ports have the same power level.

**Duty cycle**

| Test Information     |              |              | Environmental Conditions |                        |          |                  |
|----------------------|--------------|--------------|--------------------------|------------------------|----------|------------------|
| Test Date:           | 2024/08/31   |              | Temperature:             | 23°C                   |          |                  |
| Test Mode:           | Transmitting |              | Relative Humidity:       | 47%                    |          |                  |
| Tester:              | Rainbow Zhu  |              | ATM Pressure:            | 101.0 kPa              |          |                  |
| Test Data            |              |              |                          |                        |          |                  |
| Test Frequency (MHz) | Ton (ms)     | Ton+off (ms) | Duty cycle (%)           | Duty Cycle Factor (dB) | 1/T (Hz) | VBW Setting (Hz) |
| 5205                 | 4.81         | 6.25         | 76.96                    | 1.14                   | 208      | 500              |
| 5780                 | 5.03         | 6.31         | 79.71                    | 0.98                   | 199      | 500              |

**5205MHz**

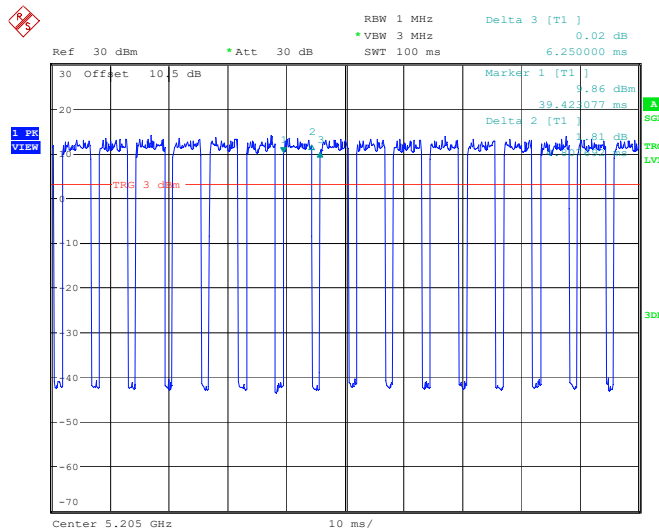

ProjectNo.:2401U43539E-RF Tester:Rainbow Zhu  
 Date: 31.AUG.2024 18:54:33



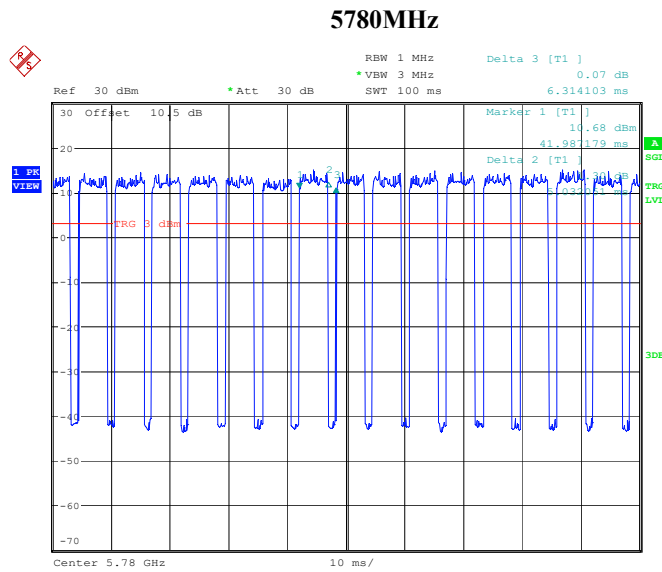

ProjectNo.:2401U43539E-RF Tester:Rainbow Zhu  
 Date: 31.AUG.2024 18:58:25

### Equipment Modifications

No modification was made to the EUT tested.

### Support Equipment List and Details

| Manufacturer | Description     | Model          | Serial Number      |
|--------------|-----------------|----------------|--------------------|
| Redmi        | Monitor         | A22FAB-RA      | 47366/206100029128 |
| Redmi        | Monitor Adapter | Unknown        | Unknown            |
| UGREEN       | Converter*2     | CM131          | Unknown            |
| Hollyland    | Battery         | Unknown        | Unknown            |
| DELL         | PC              | Latitude E6520 | DL0ZCS1            |

**External I/O Cable**

| Cable Description                   | Length (m) | From Port       | To             |
|-------------------------------------|------------|-----------------|----------------|
| Shielded Un-detachable DC cable     | 1.5        | Adapter         | EUT            |
| Un-shielded detachable HDMI cable   | 1.0        | EUT             | PC             |
| Shielded detachable HDMI cable      | 3.0        | EUT             | PC             |
| Un-shielded detachable SDI cable*2  | 3.0        | EUT             | Converter      |
| Un-shielded detachable HDMI cable*2 | 3.0        | Converter       | PC/Monitor     |
| Un-shielded un-detachable DC cable  | 1.5        | Monitor Adapter | Monitor        |
| Un-shielded un-detachable AC cable  | 1.5        | Receptacle      | AC Mains/LISN1 |

**Block Diagram of Test Setup**

For Conducted Emissions:

Test Model

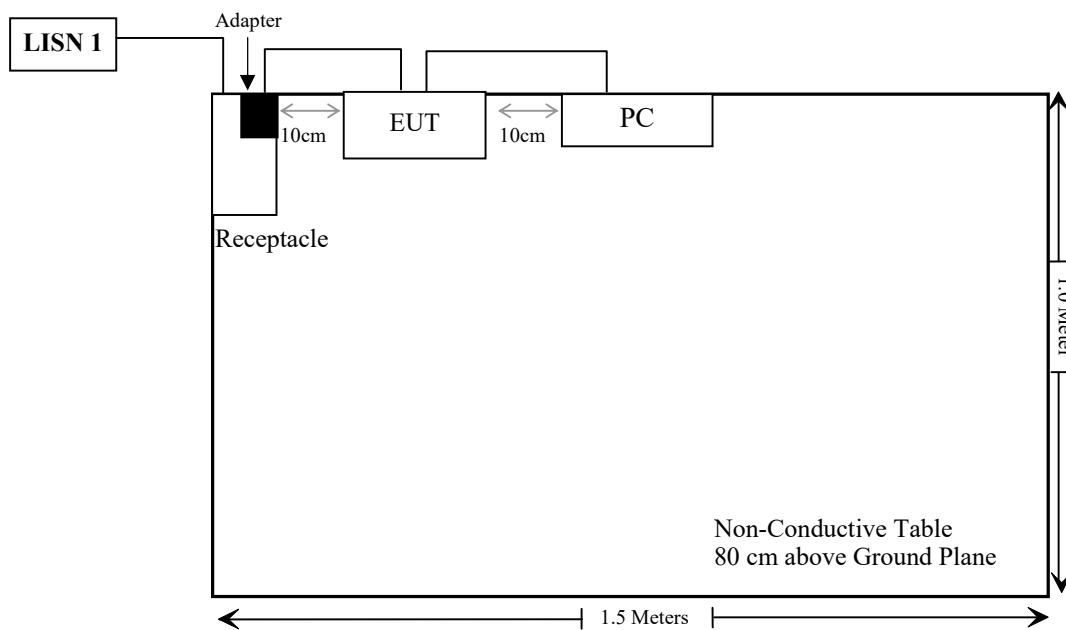

Test Mode2

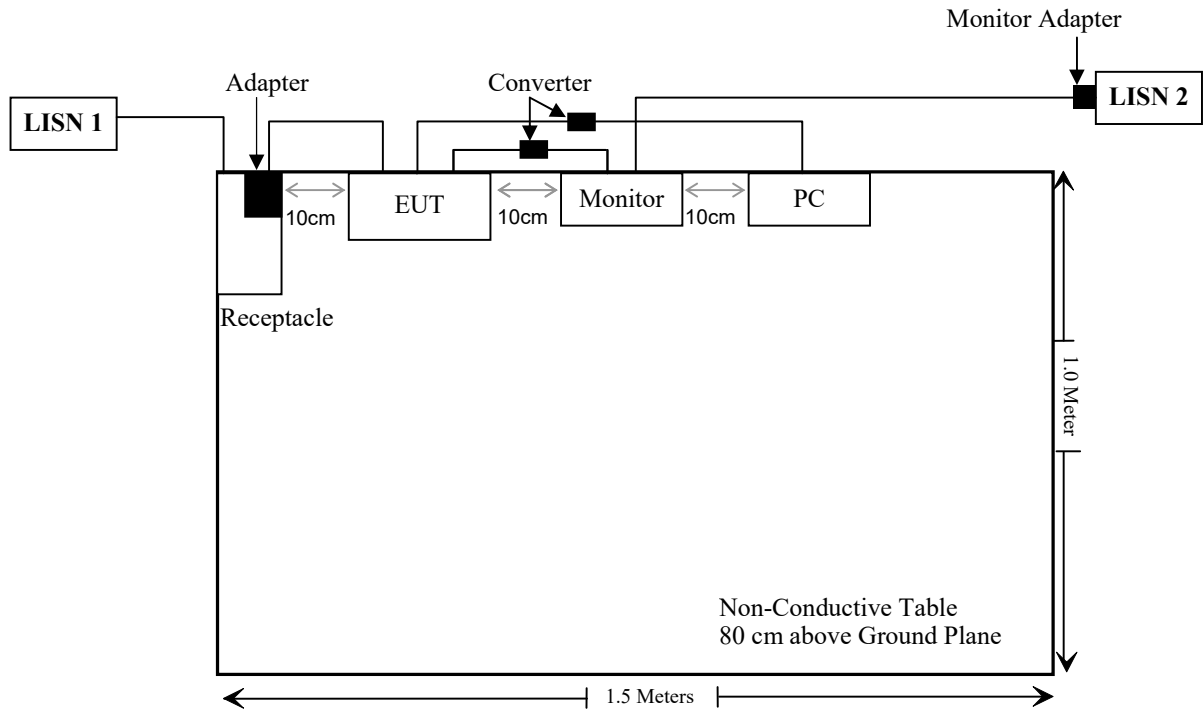

For Radiated Emissions (Below 1GHz):

Test Mode1\_ Powered by Adapter

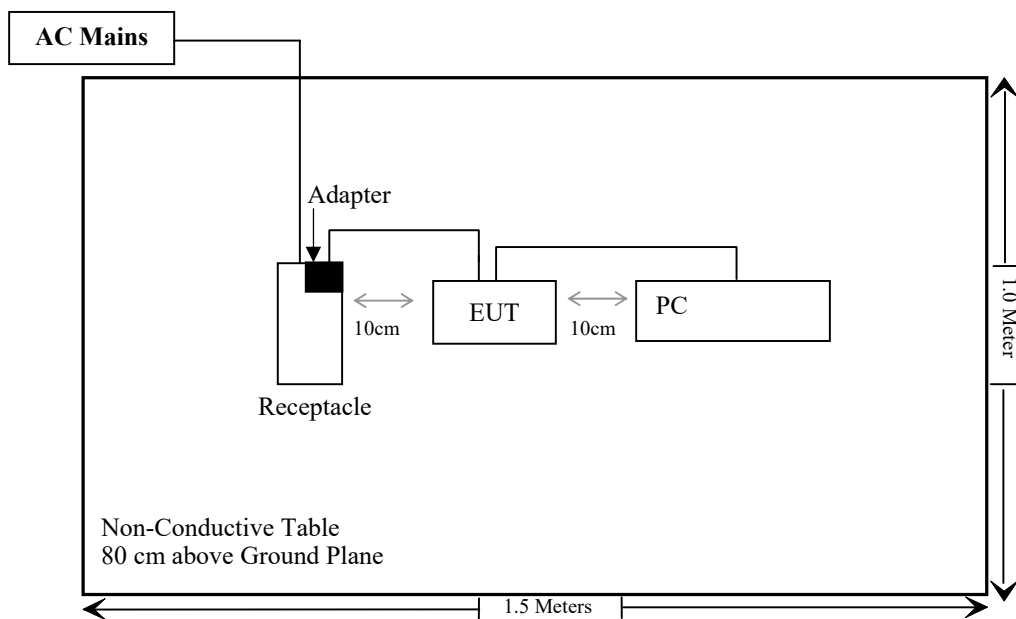

Test Mode1\_ Powered by Battery

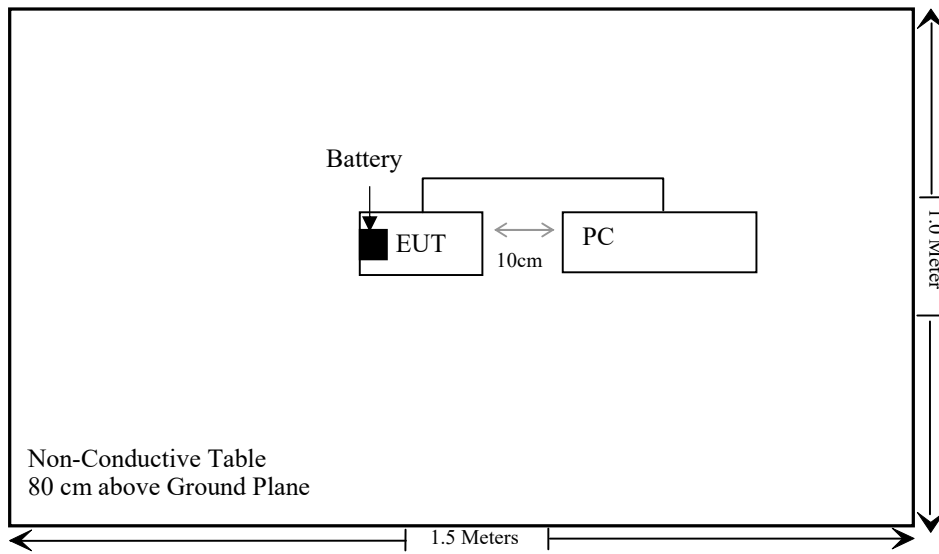

Test Mode2

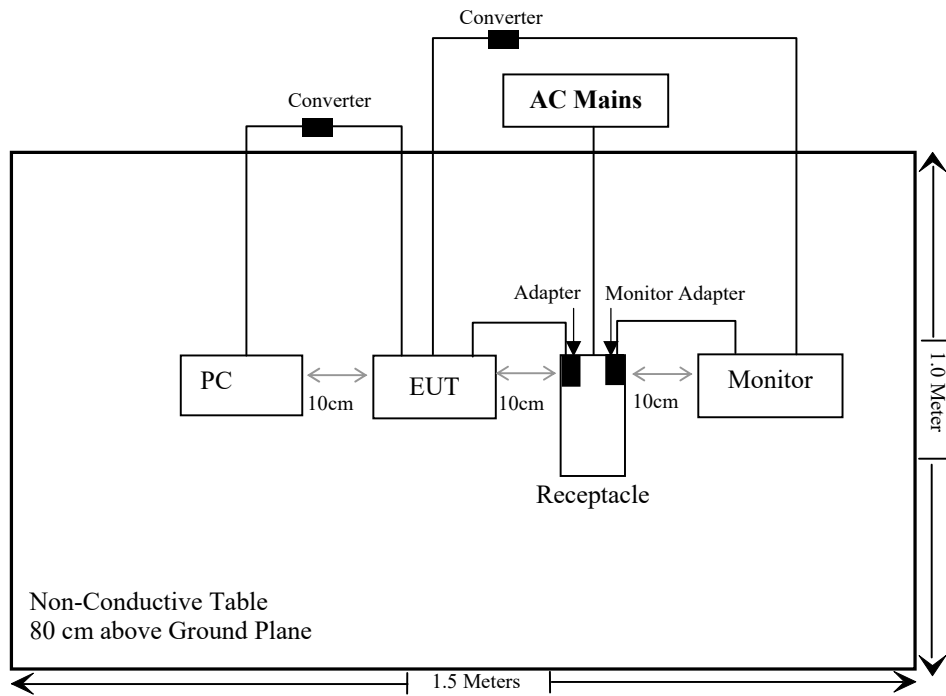

For Radiated Emissions (Above 1GHz):

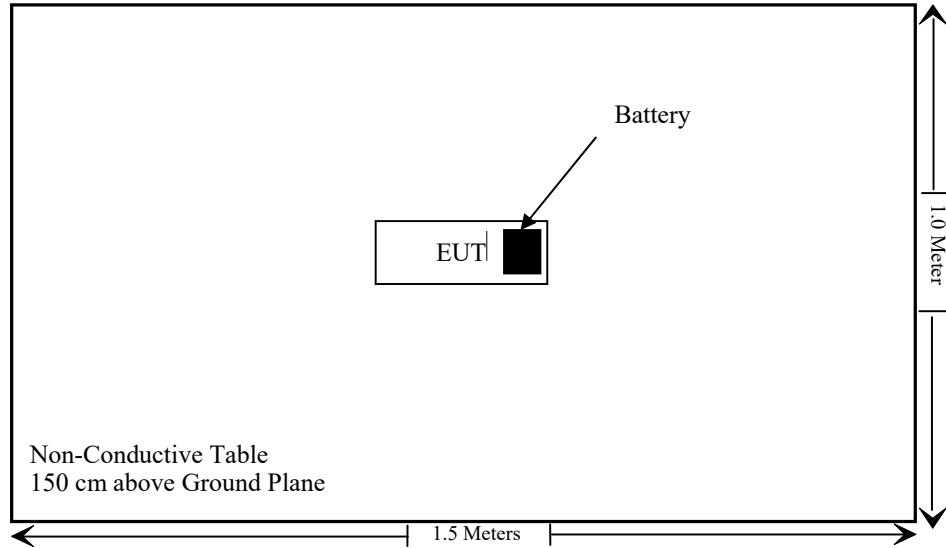

**SUMMARY OF TEST RESULTS**

| FCC Rules                       | Description of Test                      | Result         |
|---------------------------------|--|----------------|
| §1.1307 (b) & §2.1091           | MPE-Based Exemption                      | Compliant      |
| §15.203                         | Antenna Requirement                      | Compliant      |
| §15.407(b)(9)& §15.207(a)       | Conducted Emissions                      | Compliant      |
| §15.205& §15.209<br>&§15.407(b) | Undesirable Emission& Restricted Bands   | Compliant      |
| §15.407(a) (e)                  | 26 dB Emission Bandwidth & 6dB Bandwidth | Compliant      |
| §15.407(a)                      | Conducted Transmitter Output Power       | Compliant      |
| §15.407 (a)                     | Power Spectral Density                   | Compliant      |
| §15.407 (h)                     | Transmit Power Control (TPC)             | Not Applicable |
| §15.407 (h)                     | Dynamic Frequency Selection (DFS)        | Not Applicable |

Not Applicable: The device cannot operate at 5250-5350MHz/5470-5725MHz.

**TEST EQUIPMENT LIST**

| Manufacturer                    | Description                       | Model             | Serial Number          | Calibration Date | Calibration Due Date |
|---------------------------------|-----------------------------------|-------------------|------------------------|------------------|----------------------|
| <b>Conducted Emissions Test</b> |                                   |                   |                        |                  |                      |
| Rohde & Schwarz                 | EMI Test Receiver                 | ESCI              | 101120                 | 2024/01/16       | 2025/01/15           |
| Rohde & Schwarz                 | LISN                              | ENV216            | 101613                 | 2024/01/16       | 2025/01/15           |
| Rohde & Schwarz                 | Transient Limiter                 | ESH3Z2            | DE25985                | 2024/05/21       | 2025/05/20           |
| Unknown                         | CE Cable                          | Unknown           | UF A210B-1-0720-504504 | 2024/05/21       | 2025/05/20           |
| Audix                           | EMI Test software                 | E3                | 191218(V9)             | NCR              | NCR                  |
| <b>Radiated Emissions Test</b>  |                                   |                   |                        |                  |                      |
| Rohde & Schwarz                 | EMI Test Receiver                 | ESR3              | 102455                 | 2024/01/16       | 2025/01/15           |
| Sonoma instrument               | Pre-amplifier                     | 310 N             | 186238                 | 2024/05/21       | 2025/05/20           |
| Sunol Sciences                  | Broadband Antenna                 | JB1               | A040904-1              | 2023/07/20       | 2026/07/19           |
| Unknown                         | Cable                             | Chamber A Cable 1 | N/A                    | 2024/06/18       | 2025/06/17           |
| Unknown                         | Cable                             | XH500C            | J-10M-A                | 2024/06/18       | 2025/06/17           |
| BACL                            | Active Loop Antenna               | 1313-1A           | 4031911                | 2024/05/14       | 2027/05/13           |
| Unknown                         | Cable                             | 2Y194             | 0735                   | 2024/05/21       | 2025/05/20           |
| Unknown                         | Cable                             | PNG214            | 1354                   | 2024/05/21       | 2025/05/20           |
| Audix                           | EMI Test software                 | E3                | 19821b(V9)             | NCR              | NCR                  |
| Rohde & Schwarz                 | Spectrum Analyzer                 | FSV40             | 101605                 | 2024/03/27       | 2025/03/26           |
| COM-POWER                       | Pre-amplifier                     | PA-122            | 181919                 | 2024/06/18       | 2025/06/17           |
| Schwarzbeck                     | Horn Antenna                      | BBHA9120D(1201)   | 1143                   | 2023/07/26       | 2026/07/25           |
| Unknown                         | RF Cable                          | KMSE              | 735                    | 2024/06/18       | 2025/06/17           |
| Unknown                         | RF Cable                          | UFA147            | 219661                 | 2024/06/18       | 2025/06/17           |
| Unknown                         | RF Cable                          | XH750A-N          | J-10M                  | 2024/06/18       | 2025/06/17           |
| JD                              | Multiplex Switch Test Control Set | DT7220FSU         | DQ77926                | 2024/06/18       | 2025/06/17           |
| A.H.System                      | Pre-amplifier                     | PAM-1840VH        | 190                    | 2024/06/18       | 2025/06/17           |
| Electro-Mechanics Co            | Horn Antenna                      | 3116              | 9510-2270              | 2023/09/18       | 2026/09/17           |
| UTIFLEX                         | RF Cable                          | NO. 13            | 232308-001             | 2024/06/18       | 2025/06/17           |
| Audix                           | EMI Test software                 | E3                | 191218(V9)             | NCR              | NCR                  |

| Manufacturer             | Description                 | Model    | Serial Number | Calibration Date | Calibration Due Date |
|--------------------------|-----------------------------|----------|---------------|------------------|----------------------|
| <b>RF Conducted Test</b> |                             |          |               |                  |                      |
| Rohde & Schwarz          | SPECTRUM ANALYZER           | FSU26    | 200982        | 2023/12/18       | 2024/12/17           |
| ANRITSU                  | Microwave peak power sensor | MA24418A | 12622         | 2024/05/21       | 2025/05/20           |
| Unknown                  | 10dB Attenuator             | Unknown  | F-03-EM190    | 2024/06/27       | 2025/06/26           |

\* **Statement of Traceability:** Bay Area Compliance Laboratories Corp. (Shenzhen) attests that all calibrations have been performed in accordance to requirements that traceable to National Primary Standards and International System of Units (SI).



**FCC 1.1307 (B) & §2.1091- MPE-BASED EXEMPTION**

**Applicable Standard**

According to subpart 2.1091 systems operating under the provisions of this section shall be operated in a manner that ensures the public is not exposed to RF energy level in excess of the communication guidelines.

According to KDB 447498 D04 Interim General RF Exposure Guidance

MPE-Based Exemption:

General frequency and separation-distance dependent MPE-based effective radiated power (ERP) thresholds are in Table B.1 [Table 1 of § 1.1307(b)(1)(i)(C)] to support an exemption from further evaluation from 300 kHz through 100 GHz.

Table 1 to § 1.1307(b)(3)(i)(C) - Single RF Sources Subject to Routine Environmental Evaluation

| RF Source frequency (MHz) | Threshold ERP (watts) |
|---------------------------|-----------------------|
| 0.3-1.34                  | $1,920 R^2$ .         |
| 1.34-30                   | $3,450 R^2/f^2$ .     |
| 30-300                    | $3.83 R^2$ .          |
| 300-1,500                 | $0.0128 R^2 f$ .      |
| 1,500-100,000             | $19.2R^2$ .           |

R is the minimum separation distance in meters  
 f = frequency in MHz

**Result**

For Worst Case:

| Frequency (MHz) | Tune up conducted power <sup>#</sup> | Antenna Gain <sup>#</sup> |       | ERP   |        | Evaluation Distance (m) | ERP Limit (mW) |
|-----------------|--------------------------------------|---------------------------|-------|-------|--------|-------------------------|----------------|
|                 | (dBm)                                | (dBi)                     | (dBd) | (dBm) | (mW)   |                         |                |
| 5185-5225       | 12.0                                 | 5.45                      | 3.30  | 15.30 | 33.88  | 0.2                     | 768            |
| 5760-5820       | 21.5                                 | 4.34                      | 2.19  | 23.69 | 233.88 | 0.2                     | 768            |

Note: The tune up conducted power and antenna gain was declared by the applicant.

To maintain compliance with the FCC’s RF exposure guidelines, place the equipment at least 20cm from nearby persons.

**Result: Compliant**

## **FCC §15.203 - ANTENNA REQUIREMENT**

### **Applicable Standard**

According to FCC § 15.203, an intentional radiator shall be designed to ensure that no antenna other than that furnished by the responsible party shall be used with the device. The use of a permanently attached antenna or of an antenna that uses a unique coupling to the intentional radiator shall be considered sufficient to comply with the provisions of this Section. The manufacturer may design the unit so that a broken antenna can be replaced by the user, but the use of a standard antenna jack or electrical connector is prohibited.

Further, this requirement does not apply to intentional radiators that must be professionally installed, such as perimeter protection systems and some field disturbance sensors, or to other intentional radiators which, in accordance with § 15.31(d), must be measured at the installation site. However, the installer shall be responsible for ensuring that the proper antenna is employed so that the limits in this part are not exceeded.

### **Antenna Connector Construction**

The EUT has two external antennas with a unique antenna connector, and the maximum antenna gain<sup>#</sup> is below, fulfill the requirement of this section. Please refer to the EUT photos.

| <b>Type</b>      | <b>Antenna Gain<sup>#</sup></b> | <b>Impedance</b> | <b>Frequency Range</b> |
|------------------|---------------------------------|------------------|------------------------|
| Blade Antenna    | 5.45dBi                         | 50Ω              | 5150-5250MHz           |
|                  | 4.34dBi                         | 50Ω              | 5725-5850MHz           |
| Mushroom Antenna | 3.31dBi                         | 50Ω              | 5150-5250MHz           |
|                  | 3.14dBi                         | 50Ω              | 5725-5850MHz           |

**Result: Compliant**

**FCC §15.407 (b) (6) §15.207 (a) - CONDUCTED EMISSIONS**

**Applicable Standard**

FCC §15.207, §15.407(b) (6)

**EUT Setup**

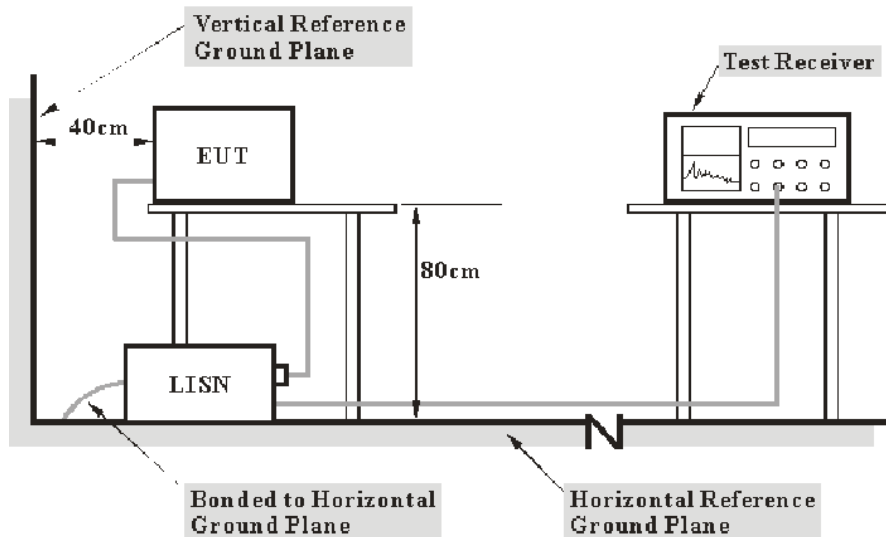

- Note: 1. Support units were connected to second LISN.  
 2. Both of LISNs (AMN) 80 cm from EUT and at the least 80 cm from other units and other metal planes support units.

The setup of EUT is according with per ANSI C63.10-2013 measurement procedure. The specification used was with the FCC Part 15.207 limits.

The spacing between the peripherals was 10 cm.

**EMI Test Receiver Setup**

The EMI test receiver was set to investigate the spectrum from 150 kHz to 30 MHz.

During the conducted emission test, the EMI test receiver was set with the following configurations:

| Frequency Range  | IF B/W |
|------------------|--------|
| 150 kHz – 30 MHz | 9 kHz  |

**Test Procedure**

During the conducted emission test, the adapter was connected to the LISN.

Maximizing procedure was performed on the six (6) highest emissions of the EUT.

All data was recorded in the Quasi-peak and Average detection mode.

## Factor & Over Limit Calculation

The factor is calculated by adding LISN VDF (Voltage Division Factor) and Cable Loss. The basic equation is as follows:

$$\text{Factor} = \text{LISN VDF} + \text{Cable Loss}$$

The “**Over limit**” column of the following data tables indicates the degree of compliance with the applicable limit. For example, an Over limit of -7 dB means the emission is 7 dB below the limit. The equation for calculation is as follows:

$$\begin{aligned}\text{Over Limit} &= \text{Level} - \text{Limit} \\ \text{Level} &= \text{Read Level} + \text{Factor}\end{aligned}$$

Note: The term "cable loss" refers to the combination of a cable and a 10dB transient limiter (attenuator).

## Test Data

### Environmental Conditions

|                           |         |
|---------------------------|---------|
| <b>Temperature:</b>       | 26 °C   |
| <b>Relative Humidity:</b> | 70 %    |
| <b>ATM Pressure:</b>      | 101 kPa |

*The testing was performed by Macy Shi from 2024-09-30 to 2024-10-09.*

*EUT operation mode: Transmitting (Maximum output power mode, 5780MHz)*

Test Model  
AC 120V/60 Hz, Line

Date: 2024-09-30

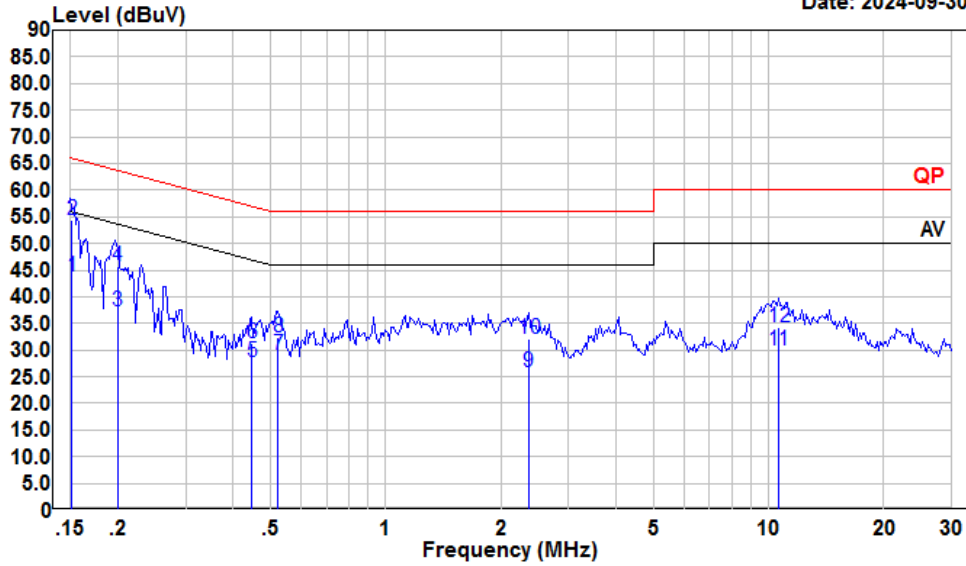

Condition: Line  
Project : 2401U43539E-RF  
tester : Macy.shi  
Note : TX

|    | Read Freq | Read Level | LISN Level | LISN Factor | Cable Loss | Limit Line | Over Limit | Remark  |
|----|-----------|------------|------------|-------------|------------|------------|------------|---------|
|    | MHz       | dBuV       | dBuV       | dB          | dB         | dBuV       | dB         |         |
| 1  | 0.152     | 22.88      | 43.91      | 10.90       | 10.13      | 55.91      | -12.00     | Average |
| 2  | 0.152     | 33.44      | 54.47      | 10.90       | 10.13      | 65.91      | -11.44     | QP      |
| 3  | 0.200     | 16.25      | 37.14      | 10.80       | 10.09      | 53.62      | -16.48     | Average |
| 4  | 0.200     | 24.80      | 45.69      | 10.80       | 10.09      | 63.62      | -17.93     | QP      |
| 5  | 0.447     | 7.08       | 27.74      | 10.54       | 10.12      | 46.93      | -19.19     | Average |
| 6  | 0.447     | 10.58      | 31.24      | 10.54       | 10.12      | 56.93      | -25.69     | QP      |
| 7  | 0.524     | 8.35       | 28.99      | 10.50       | 10.14      | 46.00      | -17.01     | Average |
| 8  | 0.524     | 11.71      | 32.35      | 10.50       | 10.14      | 56.00      | -23.65     | QP      |
| 9  | 2.358     | 5.25       | 25.96      | 10.53       | 10.18      | 46.00      | -20.04     | Average |
| 10 | 2.358     | 11.34      | 32.05      | 10.53       | 10.18      | 56.00      | -23.95     | QP      |
| 11 | 10.620    | 9.03       | 29.84      | 10.60       | 10.21      | 50.00      | -20.16     | Average |
| 12 | 10.620    | 13.54      | 34.35      | 10.60       | 10.21      | 60.00      | -25.65     | QP      |

AC 120V/60 Hz, Neutral

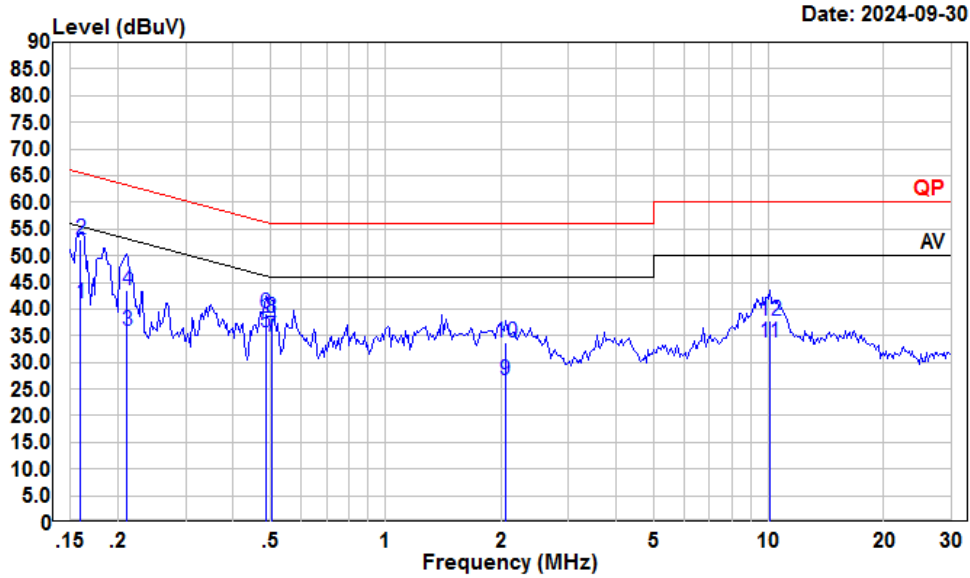

Condition: Neutral  
 Project : 2401U43539E-RF  
 tester : Macy.shi  
 Note : TX

|    | Read Freq | Read Level | LISN Level | LISN Factor | Cable Loss | Limit Line | Over Limit | Remark  |
|----|-----------|------------|------------|-------------|------------|------------|------------|---------|
|    | MHz       | dBuV       | dBuV       | dB          | dB         | dBuV       | dB         |         |
| 1  | 0.160     | 20.36      | 41.04      | 10.56       | 10.12      | 55.47      | -14.43     | Average |
| 2  | 0.160     | 32.31      | 52.99      | 10.56       | 10.12      | 65.47      | -12.48     | QP      |
| 3  | 0.211     | 15.51      | 36.02      | 10.42       | 10.09      | 53.18      | -17.16     | Average |
| 4  | 0.211     | 23.12      | 43.63      | 10.42       | 10.09      | 63.18      | -19.55     | QP      |
| 5  | 0.486     | 14.69      | 35.51      | 10.69       | 10.13      | 46.23      | -10.72     | Average |
| 6  | 0.486     | 18.27      | 39.09      | 10.69       | 10.13      | 56.23      | -17.14     | QP      |
| 7  | 0.502     | 13.90      | 34.74      | 10.70       | 10.14      | 46.00      | -11.26     | Average |
| 8  | 0.502     | 17.61      | 38.45      | 10.70       | 10.14      | 56.00      | -17.55     | QP      |
| 9  | 2.055     | 6.01       | 26.60      | 10.40       | 10.19      | 46.00      | -19.40     | Average |
| 10 | 2.055     | 13.24      | 33.83      | 10.40       | 10.19      | 56.00      | -22.17     | QP      |
| 11 | 10.072    | 12.68      | 33.69      | 10.80       | 10.21      | 50.00      | -16.31     | Average |
| 12 | 10.072    | 16.89      | 37.90      | 10.80       | 10.21      | 60.00      | -22.10     | QP      |

Test Mode2  
AC 120V/60 Hz, Line

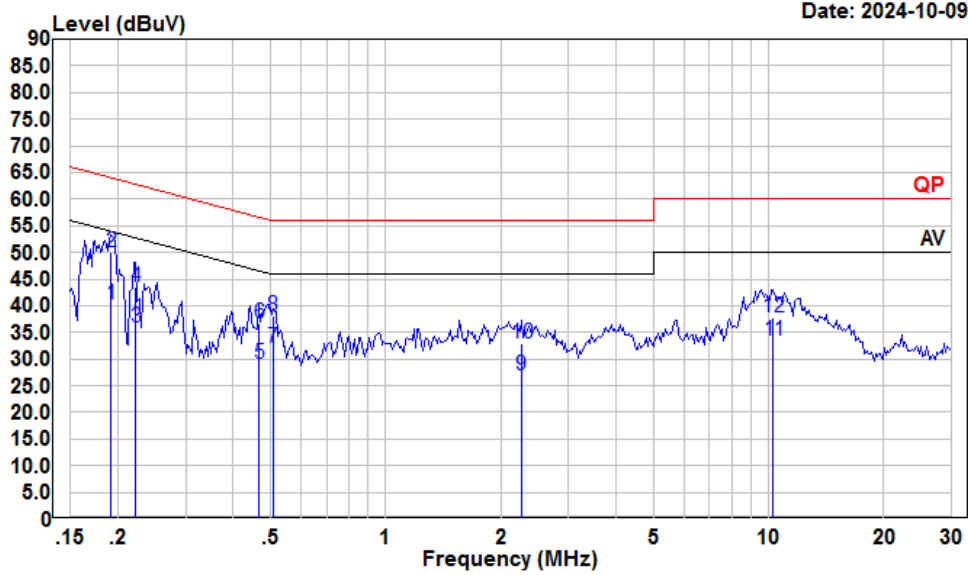

Date: 2024-10-09

Condition: Line  
Project : 2401U43539E-RF  
tester : Macy.shi  
Note : TX

|    | Freq   | Read Level | LISN Level | LISN Factor | Cable Loss | Limit Line | Over Limit | Remark  |
|----|--------|------------|------------|-------------|------------|------------|------------|---------|
|    | MHz    | dBuV       | dBuV       | dB          | dB         | dBuV       | dB         |         |
| 1  | 0.191  | 19.28      | 40.19      | 10.82       | 10.09      | 53.98      | -13.79     | Average |
| 2  | 0.191  | 29.02      | 49.93      | 10.82       | 10.09      | 63.98      | -14.05     | QP      |
| 3  | 0.222  | 14.95      | 35.81      | 10.77       | 10.09      | 52.74      | -16.93     | Average |
| 4  | 0.222  | 22.75      | 43.61      | 10.77       | 10.09      | 62.74      | -19.13     | QP      |
| 5  | 0.466  | 8.41       | 29.06      | 10.52       | 10.13      | 46.58      | -17.52     | Average |
| 6  | 0.466  | 16.18      | 36.83      | 10.52       | 10.13      | 56.58      | -19.75     | QP      |
| 7  | 0.507  | 11.41      | 32.05      | 10.50       | 10.14      | 46.00      | -13.95     | Average |
| 8  | 0.507  | 17.38      | 38.02      | 10.50       | 10.14      | 56.00      | -17.98     | QP      |
| 9  | 2.261  | 6.17       | 26.90      | 10.55       | 10.18      | 46.00      | -19.10     | Average |
| 10 | 2.261  | 12.08      | 32.81      | 10.55       | 10.18      | 56.00      | -23.19     | QP      |
| 11 | 10.288 | 12.78      | 33.59      | 10.60       | 10.21      | 50.00      | -16.41     | Average |
| 12 | 10.288 | 17.10      | 37.91      | 10.60       | 10.21      | 60.00      | -22.09     | QP      |

AC 120V/60 Hz, Neutral

Date: 2024-10-09

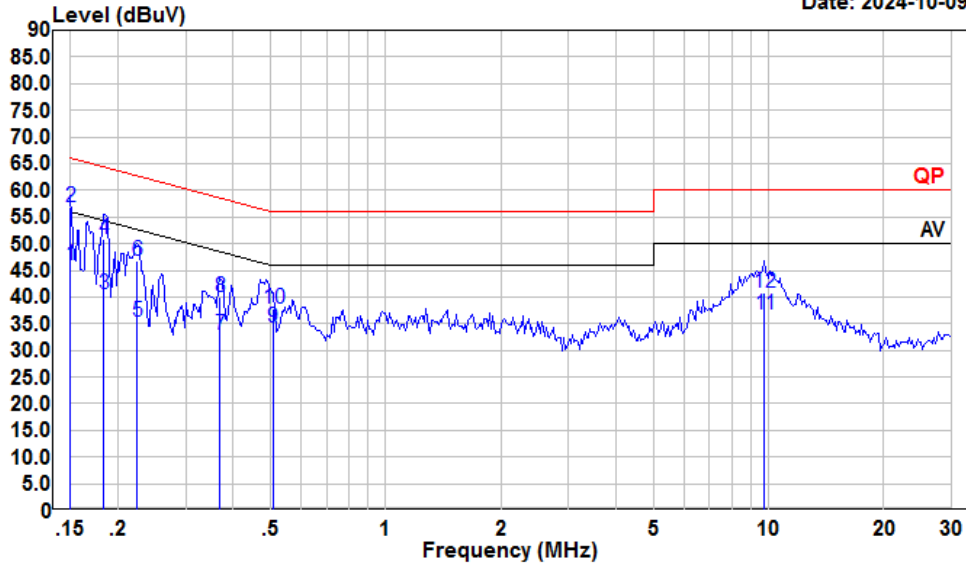

Condition: Neutral  
 Project : 2401U43539E-RF  
 tester : Macy.shi  
 Note : TX

|    | Read Freq | Read Level | LISN Level | LISN Factor | Cable Loss | Limit Line | Over Limit | Remark  |
|----|-----------|------------|------------|-------------|------------|------------|------------|---------|
|    | MHz       | dBuV       | dBuV       | dB          | dB         | dBuV       | dB         |         |
| 1  | 0.150     | 25.20      | 45.93      | 10.60       | 10.13      | 56.00      | -10.07     | Average |
| 2  | 0.150     | 36.10      | 56.83      | 10.60       | 10.13      | 66.00      | -9.17      | QP      |
| 3  | 0.183     | 19.92      | 40.48      | 10.46       | 10.10      | 54.33      | -13.85     | Average |
| 4  | 0.183     | 30.27      | 50.83      | 10.46       | 10.10      | 64.33      | -13.50     | QP      |
| 5  | 0.224     | 14.89      | 35.42      | 10.44       | 10.09      | 52.66      | -17.24     | Average |
| 6  | 0.224     | 26.26      | 46.79      | 10.44       | 10.09      | 62.66      | -15.87     | QP      |
| 7  | 0.369     | 12.31      | 33.02      | 10.60       | 10.11      | 48.52      | -15.50     | Average |
| 8  | 0.369     | 19.38      | 40.09      | 10.60       | 10.11      | 58.52      | -18.43     | QP      |
| 9  | 0.507     | 13.44      | 34.28      | 10.70       | 10.14      | 46.00      | -11.72     | Average |
| 10 | 0.507     | 16.91      | 37.75      | 10.70       | 10.14      | 56.00      | -18.25     | QP      |
| 11 | 9.757     | 15.60      | 36.60      | 10.79       | 10.21      | 50.00      | -13.40     | Average |
| 12 | 9.757     | 19.70      | 40.70      | 10.79       | 10.21      | 60.00      | -19.30     | QP      |



## §15.205 & §15.209 & §15.407(B) - UNDESIRABLE EMISSION

### Applicable Standard

FCC §15.407 (b); §15.209; §15.205;

(b) Undesirable emission limits. Except as shown in paragraph (b)(7) of this section, the maximum emissions outside of the frequency bands of operation shall be attenuated in accordance with the following limits:

- (1) For transmitters operating in the 5.15-5.25 GHz band: All emissions outside of the 5.15-5.35 GHz band shall not exceed an e.i.r.p. of  $-27$  dBm/MHz.
- (2) For transmitters operating in the 5.25-5.35 GHz band: All emissions outside of the 5.15-5.35 GHz band shall not exceed an e.i.r.p. of  $-27$  dBm/MHz.
- (3) For transmitters operating in the 5.47-5.725 GHz band: All emissions outside of the 5.47-5.725 GHz band shall not exceed an e.i.r.p. of  $-27$  dBm/MHz.
- (4) For transmitters operating in the 5.725-5.85 GHz band:
  - (i) All emissions shall be limited to a level of  $-27$  dBm/MHz at 75 MHz or more above or below the band edge increasing linearly to 10 dBm/MHz at 25 MHz above or below the band edge, and from 25 MHz above or below the band edge increasing linearly to a level of 15.6 dBm/MHz at 5 MHz above or below the band edge, and from 5 MHz above or below the band edge increasing linearly to a level of 27 dBm/MHz at the band edge.

Unwanted emissions below 1 GHz must comply with the general field strength limits set forth in §15.209.

### EUT Setup

9 kHz-30MHz:

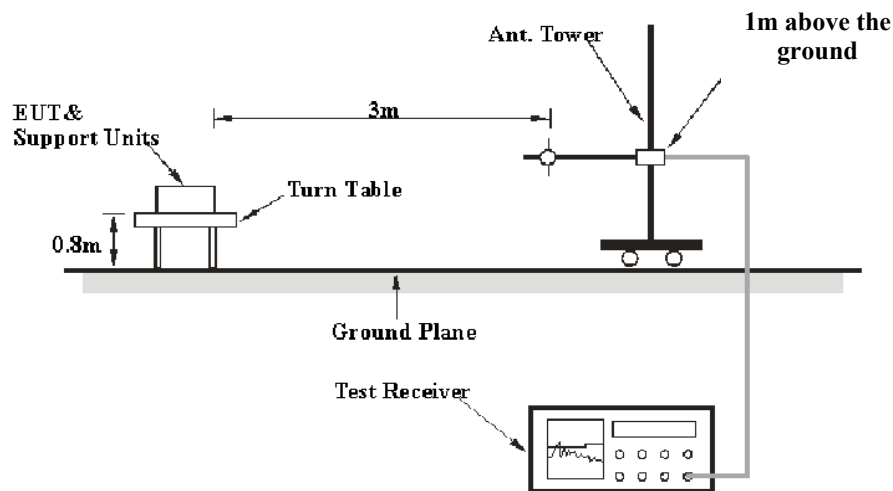

**30MHz-1GHz:**

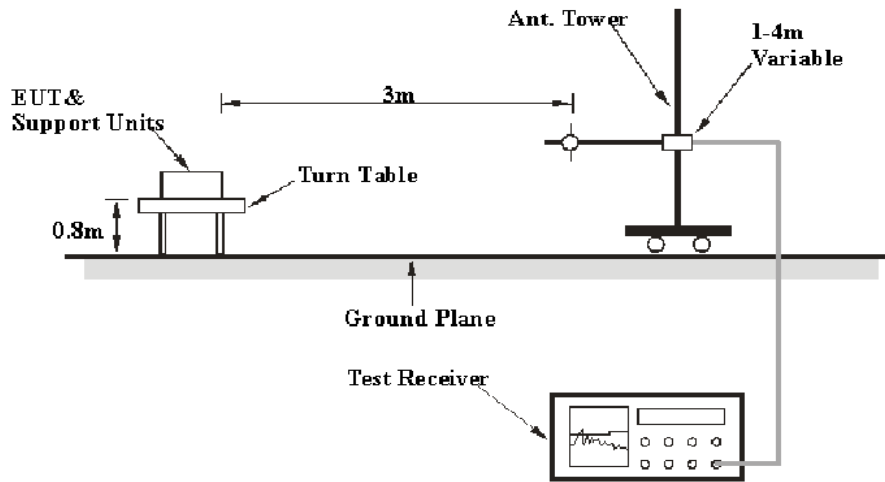

**Above 1 GHz:**

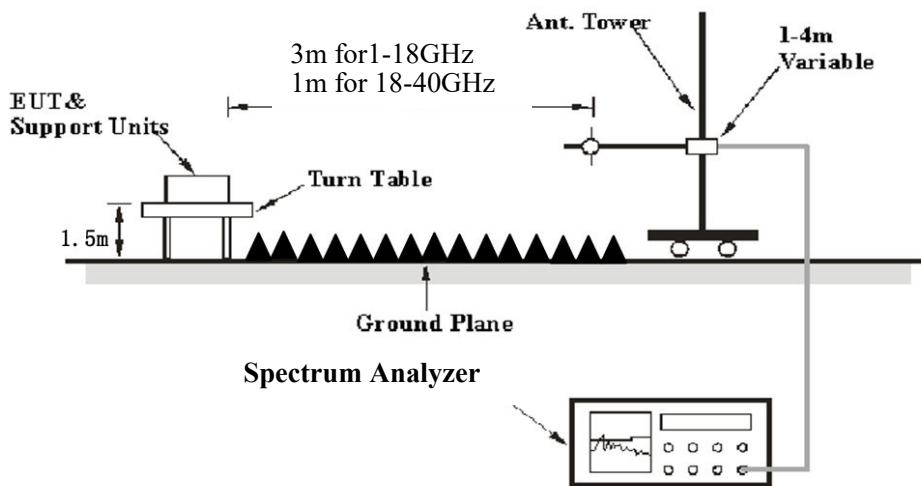

The setup of EUT is according with per ANSI C63.10-2013 measurement procedure. The specification used was with the FCC 15.209 and FCC 15.407 limits.

The external I/O cables were draped along the test table and formed a bundle 30 to 40 cm long in the middle.

## EMI Test Receiver & Spectrum Analyzer Setup

The system was investigated from 9 kHz to 40 GHz.

During the radiated emission test, the EMI test receiver & Spectrum Analyzer Setup were set with the following configurations:

9 kHz-1GHz:

| Frequency Range   | RBW     | Video B/W | IF B/W  | Measurement |
|-------------------|---------|-----------|---------|-------------|
| 9 kHz – 150 kHz   | /       | /         | 200 Hz  | QP          |
|                   | 300 Hz  | 1 kHz     | /       | PK          |
| 150 kHz – 30 MHz  | /       | /         | 9 kHz   | QP          |
|                   | 10 kHz  | 30 kHz    | /       | PK          |
| 30 MHz – 1000 MHz | /       | /         | 120 kHz | QP          |
|                   | 100 kHz | 300 kHz   | /       | PK          |

1-40GHz:

| Measurement | Duty cycle | RBW  | Video B/W                |
|-------------|------------|------|--------------------------|
| PK          | Any        | 1MHz | 3 MHz                    |
| Average     | >98%       | 1MHz | ≥10 Hz <sup>Note 1</sup> |
|             | <98%       | 1MHz | ≥1/Ton <sup>Note 2</sup> |

Note 1: The detail test parameters please refer to duty cycle section.  
 Note 2: Ton is minimum transmission duration.

If the maximized peak measured value complies with under the QP/Average limit more than 6dB, then it is unnecessary to perform an QP/Average measurement.

## Test Procedure

### Radiated Spurious Emission

During the radiated emission test, the adapter was connected to the AC floor outlet.

Maximizing procedure was performed on the highest emissions to ensure that the EUT complied with all the installation combinations.

All final data was recorded in Quasi-peak detection mode except for the frequency bands 9–90 kHz, 110–490 kHz and above 1000 MHz, average detection modes for frequency bands 9–90 kHz and 110–490 kHz, peak and average detection modes for frequencies above 1 GHz.

For 9 kHz-30MHz, the report shall list the six emissions with the smallest margin relative to the limit, for each of the three antenna orientations (parallel, perpendicular, and ground-parallel) unless the margin is greater than 20 dB.

All emissions under the average limit and under the noise floor have not recorded in the report.

According to ANSI C63.10-2013,9.4: For field strength measurements made at other than the distance at which the applicable limit is specified, extrapolate the measured field strength to the field strength at the distance specified by the limit using an inverse distance correction factor (20 dB/decade of distance). In some cases, a different distance correction factor may be required;

$$E_{\text{SpecLimit}} = E_{\text{Meas}} + 20 \log \left( \frac{d_{\text{Meas}}}{d_{\text{SpecLimit}}} \right)$$

where

- $E_{\text{SpecLimit}}$  is the field strength of the emission at the distance specified by the limit, in dB $\mu$ V/m
- $E_{\text{Meas}}$  is the field strength of the emission at the measurement distance, in dB $\mu$ V/m
- $d_{\text{Meas}}$  is the measurement distance, in m
- $d_{\text{SpecLimit}}$  is the distance specified by the limit, in m

So the extrapolation factor of 1m is  $20 \cdot \log(1/3) = -9.5$  dB, for 18-40GHz range, the limit of 1m distance was added by 9.5dB from limit of 3m to compared with the result measurement at 1m distance.

### Factor & Over Limit/Margin Calculation

The Factor is calculated by adding the Antenna Factor and Cable Loss, and subtracting the Amplifier Gain. The basic equation is as follows:

$$\text{Factor} = \text{Antenna Factor} + \text{Cable Loss} - \text{Amplifier Gain}$$

The “**Over Limit/Margin**” column of the following data tables indicates the degree of compliance with the applicable limit. For example, an Over Limit/margin of -7dB means the emission is 7dB below the limit. The equation for calculation is as follows:

$$\begin{aligned} \text{Over Limit} &= \text{Level} - \text{Limit}; \text{Margin} = \text{Limit} - \text{Corrected Amplitude} \\ \text{Level} / \text{Corrected Amplitude} &= \text{Read Level} + \text{Factor} \end{aligned}$$

### Test Data

#### Environmental Conditions

|                           |             |
|---------------------------|-------------|
| <b>Temperature:</b>       | 22 ~25.3 °C |
| <b>Relative Humidity:</b> | 53~60 %     |
| <b>ATM Pressure:</b>      | 101 kPa     |

The testing was performed by Anson Su from 2024-10-11 to 2024-10-31 for below 1GHz, Dylan Yang from 2024-09-12 to 2024-10-31 for above 1GHz.

EUT operation mode: Transmitting

Note: Pre-scan in the X, Y and Z axes of orientation, the worst case Z-axis of orientation was recorded.

**9 kHz-30MHz:** (Maximum output power mode, 5780MHz; Worst case, parallel)

**Powered by Adapter:**

Mushroom Antenna

Test Model

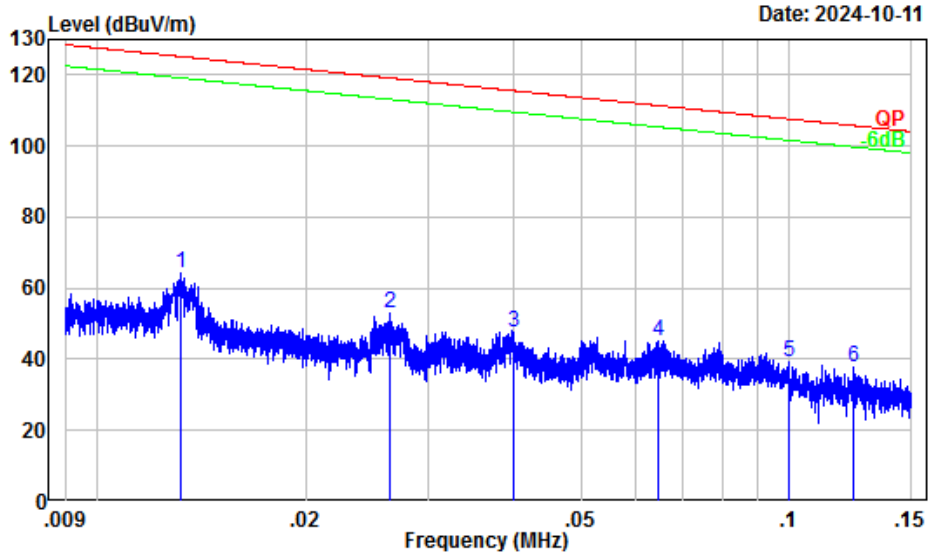

Site : Chamber A  
 Condition : 3m  
 Project Number: 2401U43539E-RF  
 Test Mode : Transmitting  
 Tester : Anson Su

|   | Freq | Factor | Read Level | Level  | Limit  | Over   | Remark |
|---|------|--------|------------|--------|--------|--------|--------|
|   | MHz  | dB/m   | dBuV       | dBuV/m | dBuV/m | dB     |        |
| 1 | 0.01 | 36.04  | 28.45      | 64.49  | 125.17 | -60.68 | Peak   |
| 2 | 0.03 | 29.27  | 23.92      | 53.19  | 119.14 | -65.95 | Peak   |
| 3 | 0.04 | 25.30  | 22.15      | 47.45  | 115.59 | -68.14 | Peak   |
| 4 | 0.06 | 21.08  | 23.83      | 44.91  | 111.38 | -66.47 | Peak   |
| 5 | 0.10 | 17.05  | 22.35      | 39.40  | 107.61 | -68.21 | Peak   |
| 6 | 0.12 | 15.94  | 21.74      | 37.68  | 105.75 | -68.07 | Peak   |

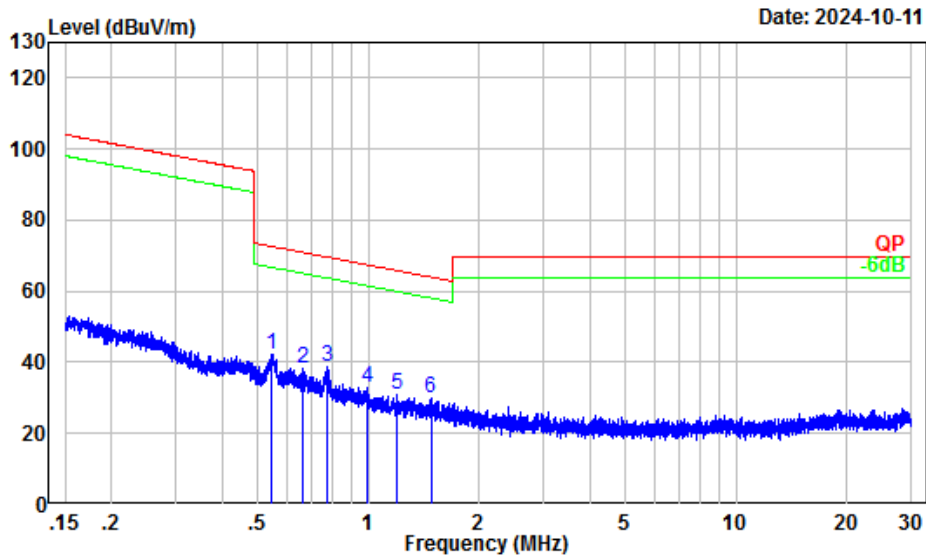

Site : Chamber A  
 Condition : 3m  
 Project Number: 2401U43539E-RF  
 Test Mode : Transmitting  
 Tester : Anson Su

|   | Freq | Factor | Read Level | Level  | Limit Line | Over Limit | Remark |
|---|------|--------|------------|--------|------------|------------|--------|
|   | MHz  | dB/m   | dBuV       | dBuV/m | dBuV/m     | dB         |        |
| 1 | 0.55 | 2.91   | 39.20      | 42.11  | 72.82      | -30.71     | Peak   |
| 2 | 0.67 | 1.49   | 36.73      | 38.22  | 71.07      | -32.85     | Peak   |
| 3 | 0.78 | 0.17   | 38.80      | 38.97  | 69.72      | -30.75     | Peak   |
| 4 | 1.00 | -1.56  | 34.39      | 32.83  | 67.50      | -34.67     | Peak   |
| 5 | 1.20 | -2.29  | 33.15      | 30.86  | 65.84      | -34.98     | Peak   |
| 6 | 1.48 | -3.26  | 33.28      | 30.02  | 63.99      | -33.97     | Peak   |

Test Mode2

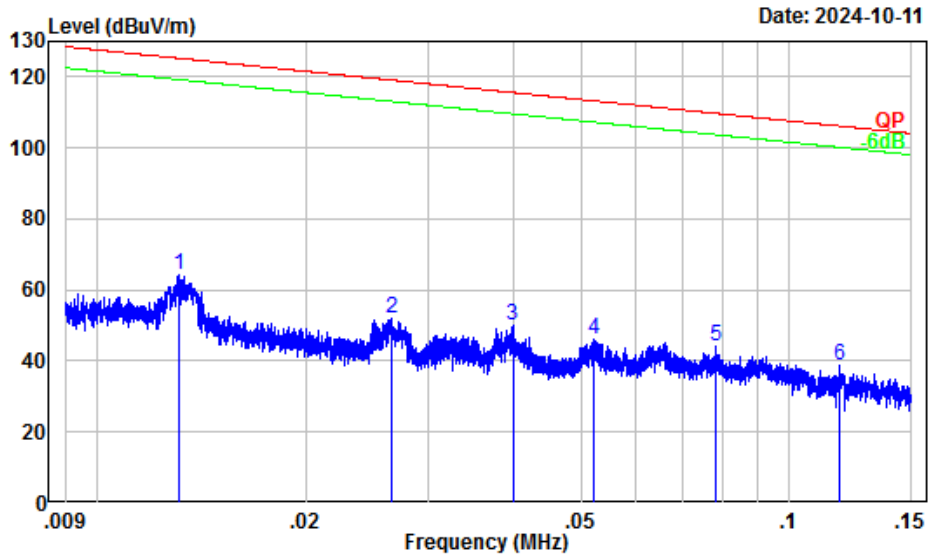

Site : Chamber A  
 Condition : 3m  
 Project Number: 2401U43539E-RF  
 Test Mode : Transmitting  
 Tester : Anson Su

|   | Freq | Factor | Read Level | Read Level | Limit Line | Over Limit | Remark |
|---|------|--------|------------|------------|------------|------------|--------|
|   | MHz  | dB/m   | dBuV       | dBuV/m     | dBuV/m     | dB         |        |
| 1 | 0.01 | 36.10  | 28.09      | 64.19      | 125.25     | -61.06     | Peak   |
| 2 | 0.03 | 29.22  | 22.55      | 51.77      | 119.11     | -67.34     | Peak   |
| 3 | 0.04 | 25.31  | 24.64      | 49.95      | 115.60     | -65.65     | Peak   |
| 4 | 0.05 | 22.77  | 23.36      | 46.13      | 113.24     | -67.11     | Peak   |
| 5 | 0.08 | 19.28  | 24.77      | 44.05      | 109.75     | -65.70     | Peak   |
| 6 | 0.12 | 16.21  | 22.50      | 38.71      | 106.16     | -67.45     | Peak   |

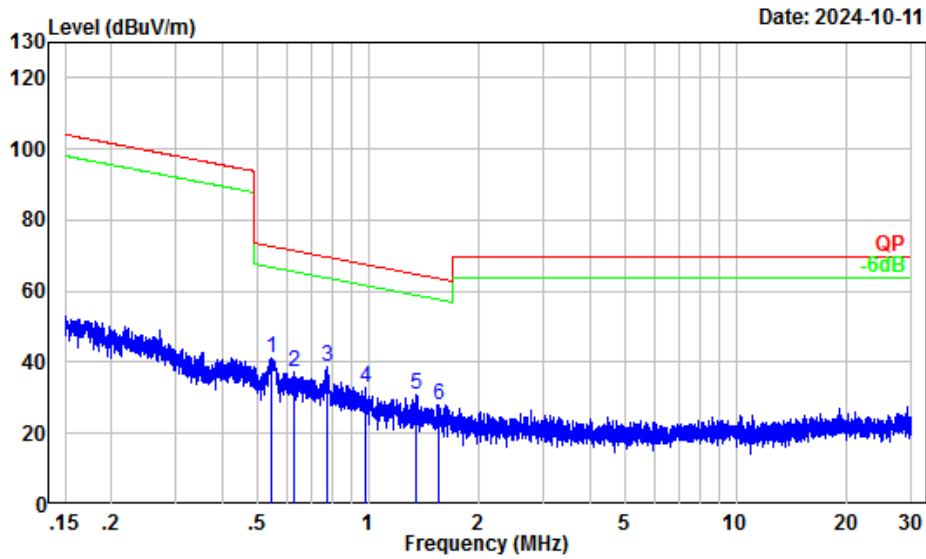

Site : Chamber A  
 Condition : 3m  
 Project Number: 2401U43539E-RF  
 Test Mode : Transmitting  
 Tester : Anson Su

|   | Freq | Factor | Read  |        | Limit  | Over   | Remark |
|---|------|--------|-------|--------|--------|--------|--------|
|   |      |        | Level | Level  |        |        |        |
|   | MHz  | dB/m   | dBuV  | dBuV/m | dBuV/m | dB     |        |
| 1 | 0.55 | 2.90   | 38.10 | 41.00  | 72.80  | -31.80 | Peak   |
| 2 | 0.63 | 1.95   | 35.35 | 37.30  | 71.60  | -34.30 | Peak   |
| 3 | 0.77 | 0.24   | 38.49 | 38.73  | 69.78  | -31.05 | Peak   |
| 4 | 0.98 | -1.45  | 34.24 | 32.79  | 67.64  | -34.85 | Peak   |
| 5 | 1.36 | -2.83  | 33.78 | 30.95  | 64.77  | -33.82 | Peak   |
| 6 | 1.56 | -3.54  | 31.61 | 28.07  | 63.53  | -35.46 | Peak   |



Blade Antenna

Test Model

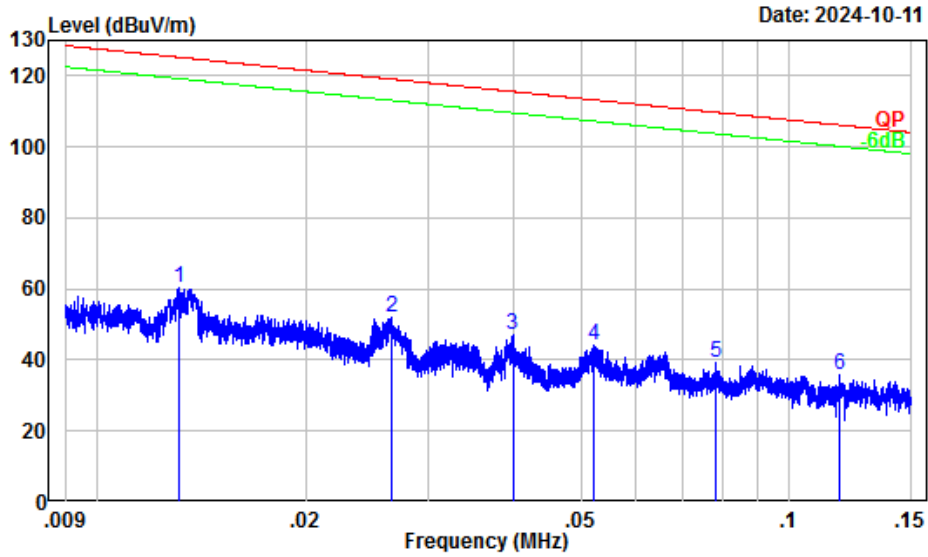

Site : Chamber A  
 Condition : 3m  
 Project Number: 2401U43539E-RF  
 Test Mode : Transmitting  
 Tester : Anson Su

|   | Freq | Factor | Read Level | Level  | Limit Line | Over Limit | Remark |
|---|------|--------|------------|--------|------------|------------|--------|
|   | MHz  | dB/m   | dBuV       | dBuV/m | dBuV/m     | dB         |        |
| 1 | 0.01 | 36.10  | 24.09      | 60.19  | 125.25     | -65.06     | Peak   |
| 2 | 0.03 | 29.22  | 22.55      | 51.77  | 119.11     | -67.34     | Peak   |
| 3 | 0.04 | 25.31  | 21.64      | 46.95  | 115.60     | -68.65     | Peak   |
| 4 | 0.05 | 22.77  | 21.36      | 44.13  | 113.24     | -69.11     | Peak   |
| 5 | 0.08 | 19.28  | 19.77      | 39.05  | 109.75     | -70.70     | Peak   |
| 6 | 0.12 | 16.21  | 19.50      | 35.71  | 106.16     | -70.45     | Peak   |

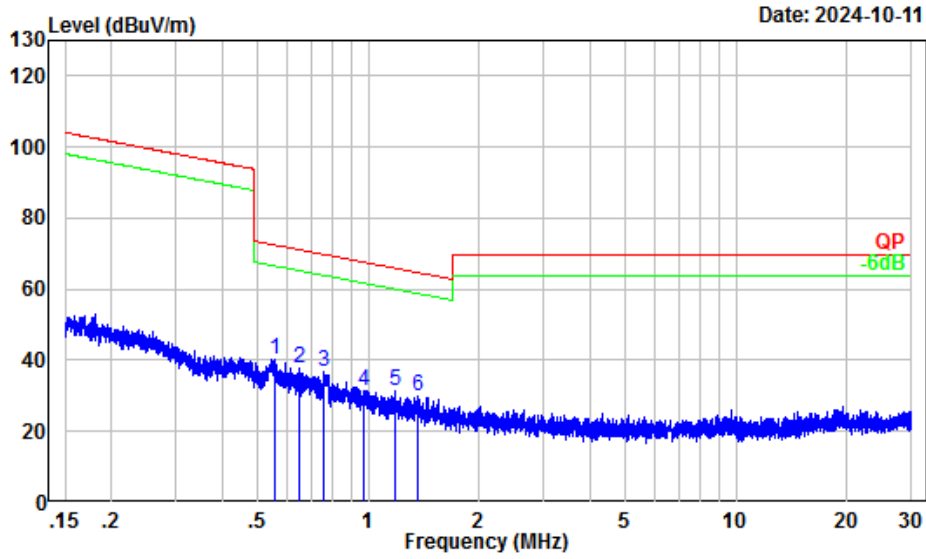

Site : Chamber A  
 Condition : 3m  
 Project Number: 2401U43539E-RF  
 Test Mode : Transmitting  
 Tester : Anson Su

|   | Freq | Factor | Read  |        | Limit  | Over   | Remark |
|---|------|--------|-------|--------|--------|--------|--------|
|   |      |        | Level | Level  |        |        |        |
|   | MHz  | dB/m   | dBuV  | dBuV/m | dBuV/m | dB     |        |
| 1 | 0.56 | 2.78   | 37.44 | 40.22  | 72.65  | -32.43 | Peak   |
| 2 | 0.65 | 1.69   | 36.07 | 37.76  | 71.29  | -33.53 | Peak   |
| 3 | 0.76 | 0.38   | 36.45 | 36.83  | 69.91  | -33.08 | Peak   |
| 4 | 0.97 | -1.37  | 32.92 | 31.55  | 67.75  | -36.20 | Peak   |
| 5 | 1.19 | -2.24  | 33.60 | 31.36  | 65.95  | -34.59 | Peak   |
| 6 | 1.36 | -2.86  | 32.76 | 29.90  | 64.71  | -34.81 | Peak   |

Test Mode2

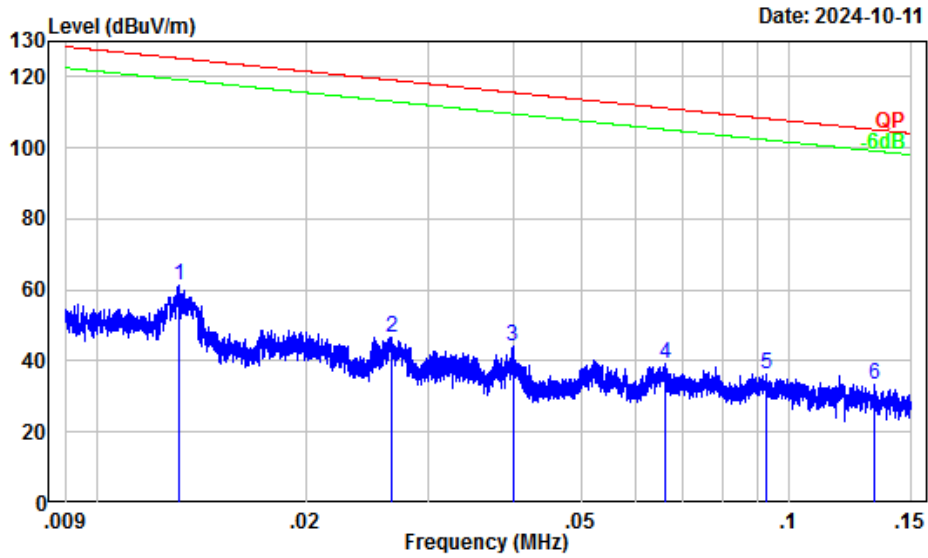

Site : Chamber A  
 Condition : 3m  
 Project Number: 2401U43539E-RF  
 Test Mode : Transmitting  
 Tester : Anson Su

|   | Freq | Factor | Read  |        | Limit  | Over   | Remark |
|---|------|--------|-------|--------|--------|--------|--------|
|   |      |        | Level | Level  |        |        |        |
|   | MHz  | dB/m   | dBuV  | dBuV/m | dBuV/m | dB     |        |
| 1 | 0.01 | 36.10  | 25.09 | 61.19  | 125.25 | -64.06 | Peak   |
| 2 | 0.03 | 29.22  | 17.55 | 46.77  | 119.11 | -72.34 | Peak   |
| 3 | 0.04 | 25.31  | 18.64 | 43.95  | 115.60 | -71.65 | Peak   |
| 4 | 0.07 | 20.91  | 18.15 | 39.06  | 111.21 | -72.15 | Peak   |
| 5 | 0.09 | 17.80  | 18.64 | 36.44  | 108.29 | -71.85 | Peak   |
| 6 | 0.13 | 15.52  | 17.84 | 33.36  | 105.15 | -71.79 | Peak   |

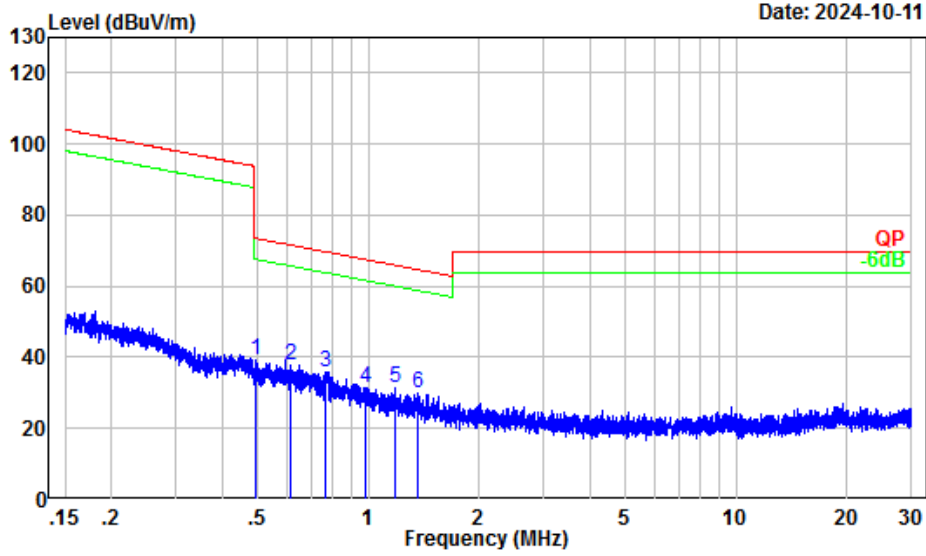

Date: 2024-10-11

Site : Chamber A  
 Condition : 3m  
 Project Number: 2401U43539E-RF  
 Test Mode : Transmitting  
 Tester : Anson Su

|   | Freq | Factor | Read  |        | Limit  | Over   | Remark |
|---|------|--------|-------|--------|--------|--------|--------|
|   |      |        | Level | Level  |        |        |        |
|   | MHz  | dB/m   | dBuV  | dBuV/m | dBuV/m | dB     |        |
| 1 | 0.49 | 3.62   | 35.50 | 39.12  | 73.74  | -34.62 | Peak   |
| 2 | 0.62 | 2.10   | 35.90 | 38.00  | 71.78  | -33.78 | Peak   |
| 3 | 0.77 | 0.29   | 35.64 | 35.93  | 69.83  | -33.90 | Peak   |
| 4 | 0.98 | -1.44  | 32.81 | 31.37  | 67.65  | -36.28 | Peak   |
| 5 | 1.19 | -2.24  | 33.60 | 31.36  | 65.95  | -34.59 | Peak   |
| 6 | 1.36 | -2.86  | 32.76 | 29.90  | 64.71  | -34.81 | Peak   |

Powered by Battery:

Mushroom Antenna, Test Model (Worst Case)

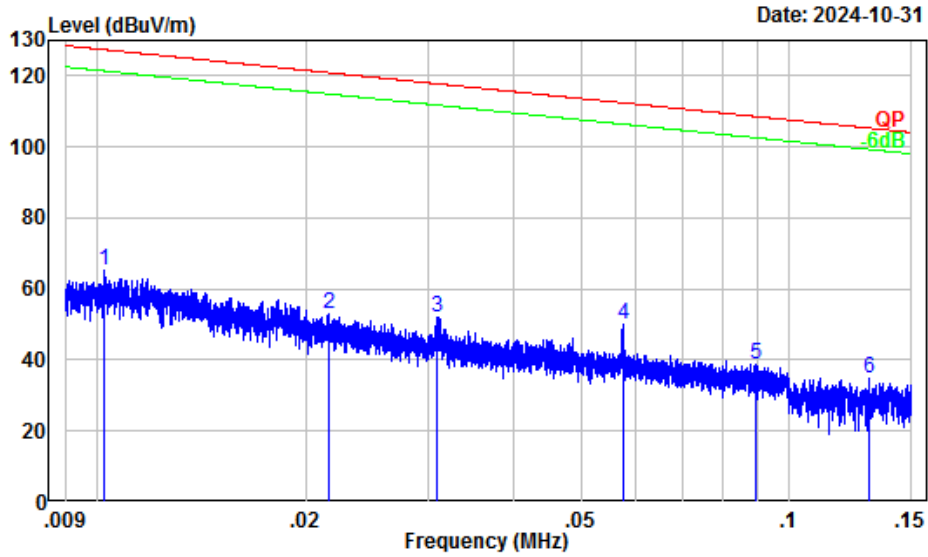

Site : Chamber A  
 Condition : 3m  
 Project Number: 2401U43539E-RF  
 Test Mode : Transmitting  
 Tester : Anson Su

|   | Freq | Factor | Read Level | Level  | Limit Line | Over Limit | Remark |
|---|------|--------|------------|--------|------------|------------|--------|
|   | MHz  | dB/m   | dBuV       | dBuV/m | dBuV/m     | dB         |        |
| 1 | 0.01 | 37.57  | 27.50      | 65.07  | 127.41     | -62.34     | Peak   |
| 2 | 0.02 | 31.79  | 21.31      | 53.10  | 120.93     | -67.83     | Peak   |
| 3 | 0.03 | 27.25  | 24.93      | 52.18  | 117.76     | -65.58     | Peak   |
| 4 | 0.06 | 22.06  | 27.95      | 50.01  | 112.42     | -62.41     | Peak   |
| 5 | 0.09 | 18.08  | 20.61      | 38.69  | 108.56     | -69.87     | Peak   |
| 6 | 0.13 | 15.64  | 19.36      | 35.00  | 105.31     | -70.31     | Peak   |

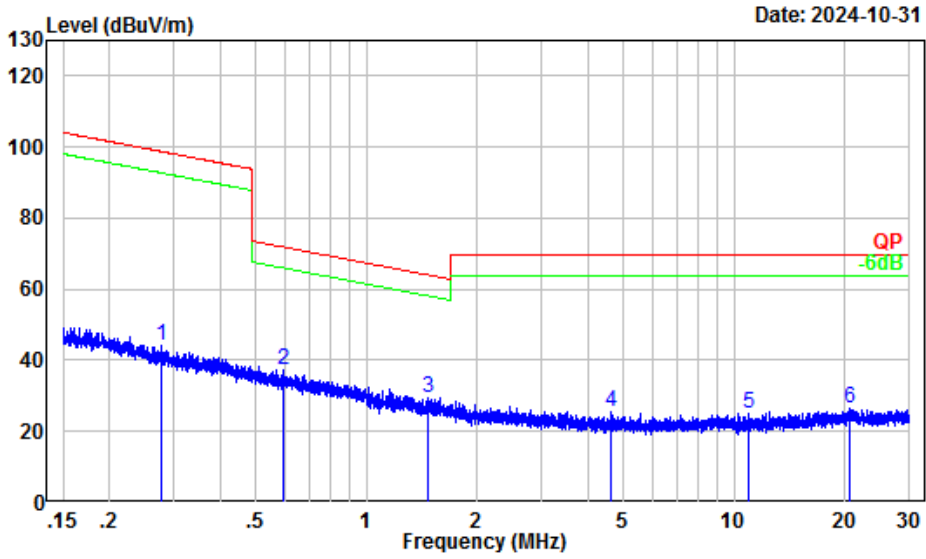

Date: 2024-10-31

Site : Chamber A  
 Condition : 3m  
 Project Number: 2401U43539E-RF  
 Test Mode : Transmitting  
 Tester : Anson Su

|   | Freq  | Factor | Read  |        | Limit  | Over   | Remark |
|---|-------|--------|-------|--------|--------|--------|--------|
|   |       |        | Level | Level  |        |        |        |
|   | MHz   | dB/m   | dBuV  | dBuV/m | dBuV/m | dB     |        |
| 1 | 0.28  | 8.84   | 35.26 | 44.10  | 98.78  | -54.68 | Peak   |
| 2 | 0.59  | 2.37   | 35.14 | 37.51  | 72.12  | -34.61 | Peak   |
| 3 | 1.47  | -3.23  | 32.64 | 29.41  | 64.05  | -34.64 | Peak   |
| 4 | 4.61  | -6.83  | 32.22 | 25.39  | 69.54  | -44.15 | Peak   |
| 5 | 10.96 | -6.26  | 31.18 | 24.92  | 69.54  | -44.62 | Peak   |
| 6 | 20.62 | -4.78  | 31.37 | 26.59  | 69.54  | -42.95 | Peak   |

**30 MHz–1 GHz: (Maximum output power mode, 5780MHz)**

**Powered by Adapter:**

Mushroom Antenna

Test Model

**Horizontal**

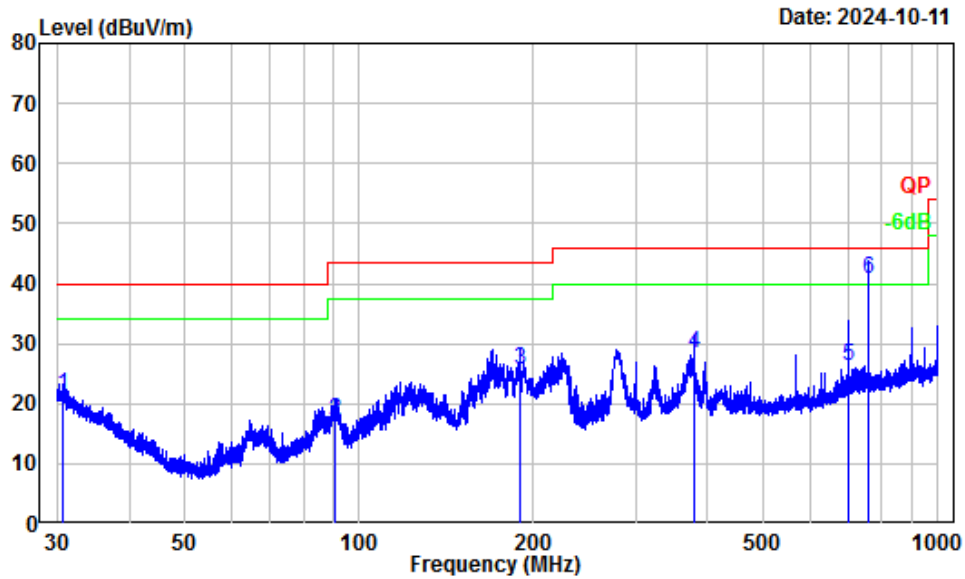

Site : Chamber A  
 Condition : 3m Horizontal  
 Project Number: 2401U43539E-RF  
 Test Mode : Transmitting  
 Tester : Anson Su

|   | Freq   | Factor | Read Level | Limit Level | Over Limit | Remark    |
|---|--------|--------|------------|-------------|------------|-----------|
|   | MHz    | dB/m   | dBuV       | dBuV/m      | dBuV/m     | dB        |
| 1 | 30.73  | -6.85  | 28.22      | 21.37       | 40.00      | -18.63 QP |
| 2 | 90.66  | -18.66 | 35.99      | 17.33       | 43.50      | -26.17 QP |
| 3 | 189.24 | -13.07 | 38.84      | 25.77       | 43.50      | -17.73 QP |
| 4 | 378.42 | -11.48 | 39.80      | 28.32       | 46.00      | -17.68 QP |
| 5 | 699.92 | -6.61  | 32.82      | 26.21       | 46.00      | -19.79 QP |
| 6 | 757.04 | -5.52  | 46.20      | 40.68       | 46.00      | -5.32 QP  |

Vertical

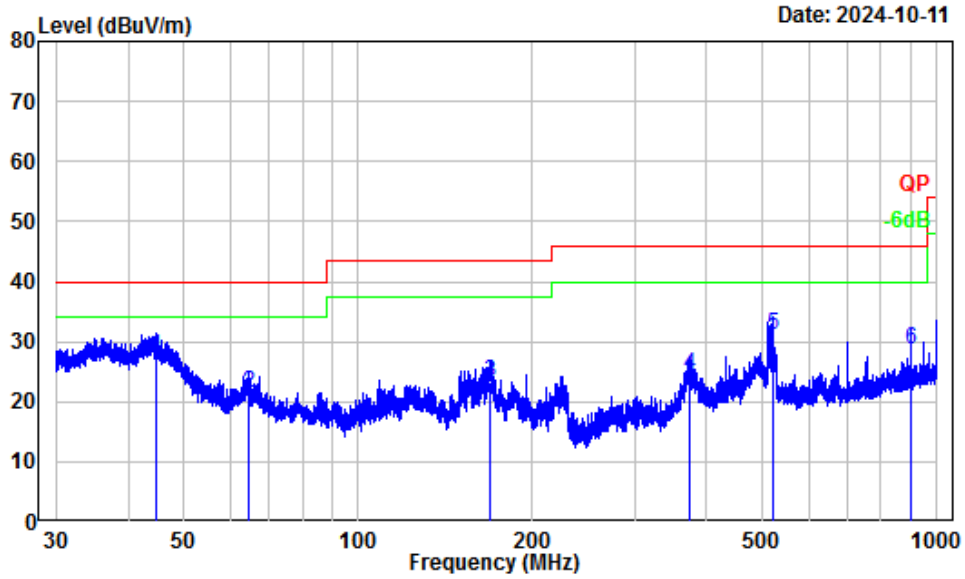

Date: 2024-10-11

Site : Chamber A  
 Condition : 3m Vertical  
 Project Number: 2401U43539E-RF  
 Test Mode : Transmitting  
 Tester : Anson Su

|   | Freq   | Factor | Read Level | Level  | Limit Line | Over Limit | Remark |
|---|--------|--------|------------|--------|------------|------------|--------|
|   | MHz    | dB/m   | dBuV       | dBuV/m | dBuV/m     | dB         |        |
| 1 | 44.67  | -16.50 | 43.99      | 27.49  | 40.00      | -12.51     | QP     |
| 2 | 64.49  | -18.72 | 40.19      | 21.47  | 40.00      | -18.53     | QP     |
| 3 | 169.15 | -14.40 | 37.79      | 23.39  | 43.50      | -20.11     | QP     |
| 4 | 372.66 | -11.62 | 36.04      | 24.42  | 46.00      | -21.58     | QP     |
| 5 | 521.57 | -9.02  | 40.21      | 31.19  | 46.00      | -14.81     | QP     |
| 6 | 900.15 | -3.66  | 32.46      | 28.80  | 46.00      | -17.20     | QP     |



Test Mode2

**Horizontal**

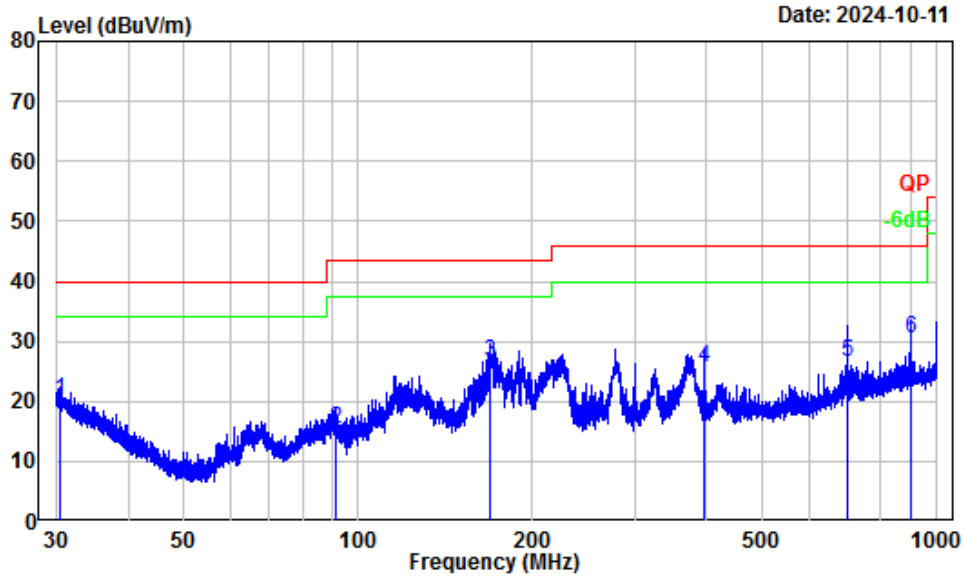

Date: 2024-10-11

Site : Chamber A  
 Condition : 3m Horizontal  
 Project Number: 2401U43539E-RF  
 Test Mode : Transmitting  
 Tester : Anson Su

|   | Freq   | Factor | Read Level | Level  | Limit  | Over Limit | Remark |
|---|--------|--------|------------|--------|--------|------------|--------|
|   | MHz    | dB/m   | dBuV       | dBuV/m | dBuV/m | dB         |        |
| 1 | 30.48  | -6.70  | 27.04      | 20.34  | 40.00  | -19.66     | QP     |
| 2 | 91.58  | -18.60 | 34.05      | 15.45  | 43.50  | -28.05     | QP     |
| 3 | 169.01 | -14.40 | 40.85      | 26.45  | 43.50  | -17.05     | QP     |
| 4 | 396.07 | -11.08 | 36.73      | 25.65  | 46.00  | -20.35     | QP     |
| 5 | 699.92 | -6.61  | 33.24      | 26.63  | 46.00  | -19.37     | QP     |
| 6 | 900.15 | -3.66  | 34.20      | 30.54  | 46.00  | -15.46     | QP     |

**Vertical**

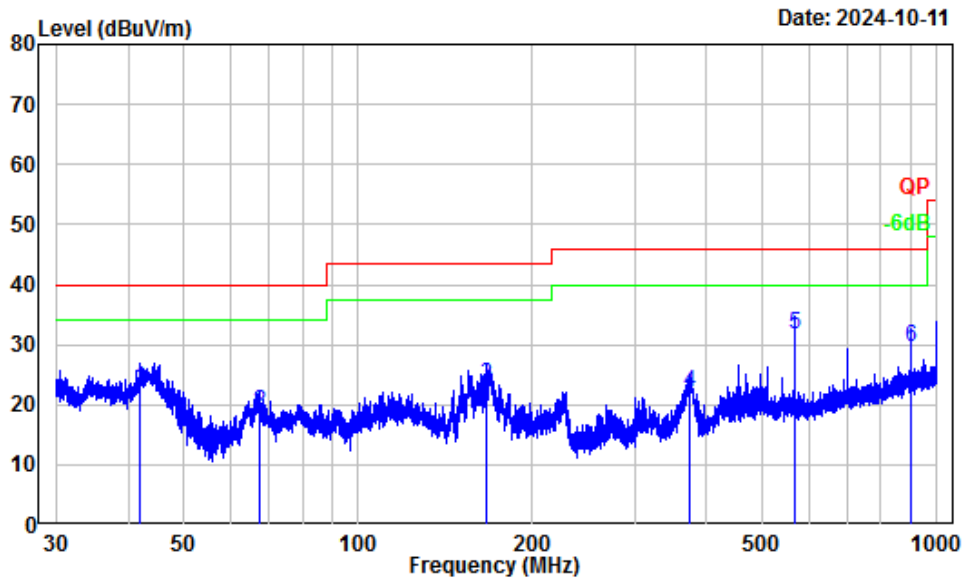

Date: 2024-10-11

Site : Chamber A  
 Condition : 3m Vertical  
 Project Number: 2401U43539E-RF  
 Test Mode : Transmitting  
 Tester : Anson Su

|   | Freq   | Factor | Read Level | Level  | Limit Line | Over Limit | Remark |
|---|--------|--------|------------|--------|------------|------------|--------|
|   | MHz    | dB/m   | dBuV       | dBuV/m | dBuV/m     | dB         |        |
| 1 | 42.04  | -14.74 | 37.51      | 22.77  | 40.00      | -17.23     | QP     |
| 2 | 67.56  | -18.59 | 37.24      | 18.65  | 40.00      | -21.35     | QP     |
| 3 | 166.65 | -14.26 | 37.62      | 23.36  | 43.50      | -20.14     | QP     |
| 4 | 374.95 | -11.54 | 33.52      | 21.98  | 46.00      | -24.02     | QP     |
| 5 | 567.87 | -8.37  | 40.14      | 31.77  | 46.00      | -14.23     | QP     |
| 6 | 900.15 | -3.66  | 33.15      | 29.49  | 46.00      | -16.51     | QP     |

Blade Antenna

Test Model

**Horizontal**

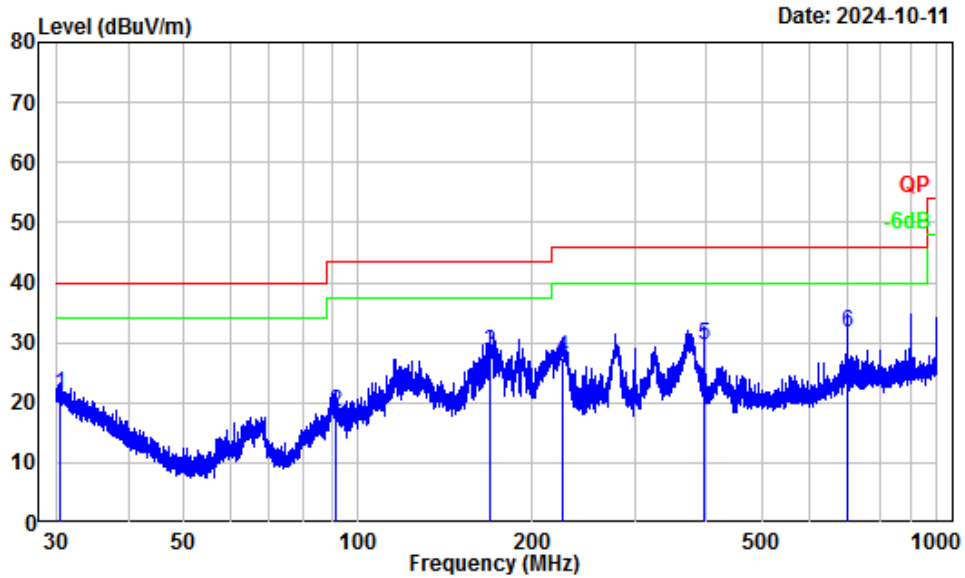

Site : Chamber A  
 Condition : 3m Horizontal  
 Project Number: 2401U43539E-RF  
 Test Mode : Transmitting  
 Tester : Anson Su

|   | Freq   | Factor | Read Level | Level  | Limit Line | Over Limit | Remark |
|---|--------|--------|------------|--------|------------|------------|--------|
|   | MHz    | dB/m   | dBuV       | dBuV/m | dBuV/m     | dB         |        |
| 1 | 30.48  | -6.70  | 28.04      | 21.34  | 40.00      | -18.66     | QP     |
| 2 | 91.58  | -18.60 | 37.05      | 18.45  | 43.50      | -25.05     | QP     |
| 3 | 169.01 | -14.40 | 42.85      | 28.45  | 43.50      | -15.05     | QP     |
| 4 | 225.70 | -14.61 | 42.19      | 27.58  | 46.00      | -18.42     | QP     |
| 5 | 396.07 | -11.08 | 40.73      | 29.65  | 46.00      | -16.35     | QP     |
| 6 | 700.22 | -6.61  | 38.30      | 31.69  | 46.00      | -14.31     | QP     |

**Vertical**

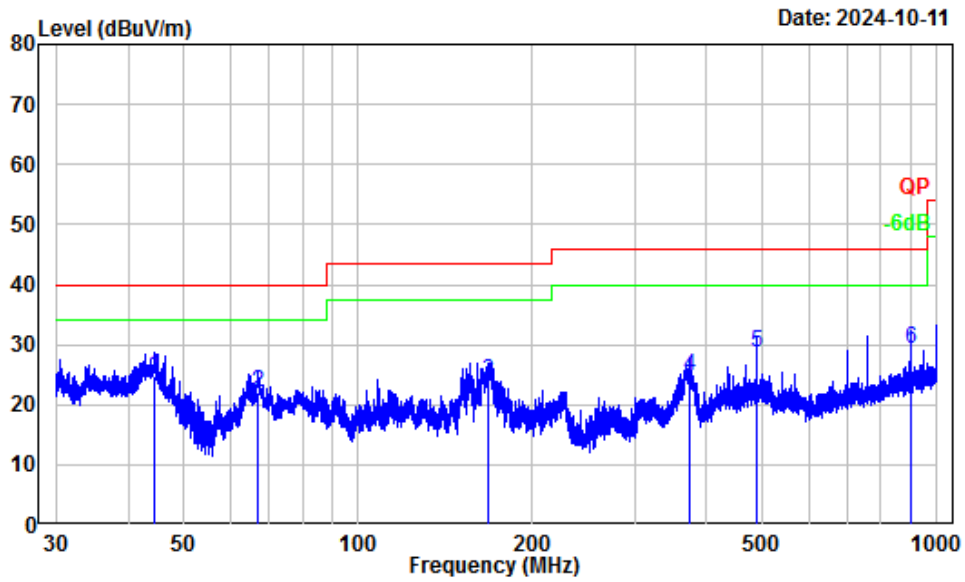

Date: 2024-10-11

Site : Chamber A  
 Condition : 3m Vertical  
 Project Number: 2401U43539E-RF  
 Test Mode : Transmitting  
 Tester : Anson Su

|   | Freq   | Factor | Read Level | Level  | Limit Line | Over Limit | Remark |
|---|--------|--------|------------|--------|------------|------------|--------|
|   | MHz    | dB/m   | dBuV       | dBuV/m | dBuV/m     | dB         |        |
| 1 | 44.41  | -16.32 | 40.95      | 24.63  | 40.00      | -15.37     | QP     |
| 2 | 67.14  | -18.60 | 40.59      | 21.99  | 40.00      | -18.01     | QP     |
| 3 | 167.97 | -14.29 | 38.13      | 23.84  | 43.50      | -19.66     | QP     |
| 4 | 372.66 | -11.62 | 36.42      | 24.80  | 46.00      | -21.20     | QP     |
| 5 | 489.24 | -9.04  | 37.66      | 28.62  | 46.00      | -17.38     | QP     |
| 6 | 900.15 | -3.66  | 32.97      | 29.31  | 46.00      | -16.69     | QP     |

Test Mode2

**Horizontal**

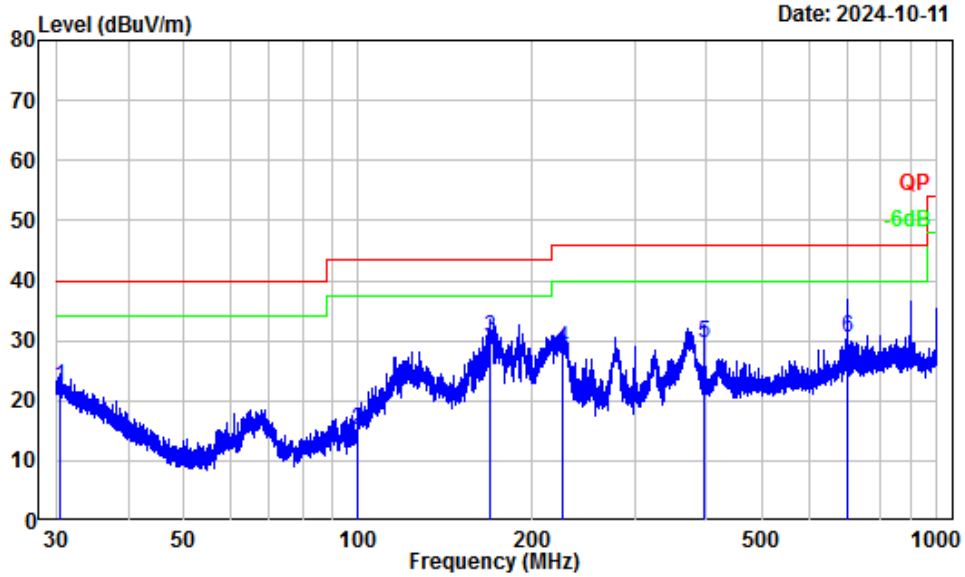

Date: 2024-10-11

Site : Chamber A  
 Condition : 3m Horizontal  
 Project Number: 2401U43539E-RF  
 Test Mode : Transmitting  
 Tester : Anson Su

|   | Freq   | Factor | Read Level | Level  | Limit Line | Over Limit | Remark |
|---|--------|--------|------------|--------|------------|------------|--------|
|   | MHz    | dB/m   | dBuV       | dBuV/m | dBuV/m     | dB         |        |
| 1 | 30.48  | -6.70  | 29.04      | 22.34  | 40.00      | -17.66     | QP     |
| 2 | 99.40  | -16.84 | 31.93      | 15.09  | 43.50      | -28.41     | QP     |
| 3 | 169.01 | -14.40 | 44.85      | 30.45  | 43.50      | -13.05     | QP     |
| 4 | 225.70 | -14.61 | 43.29      | 28.68  | 46.00      | -17.32     | QP     |
| 5 | 396.07 | -11.08 | 40.73      | 29.65  | 46.00      | -16.35     | QP     |
| 6 | 699.92 | -6.61  | 37.24      | 30.63  | 46.00      | -15.37     | QP     |

**Vertical**

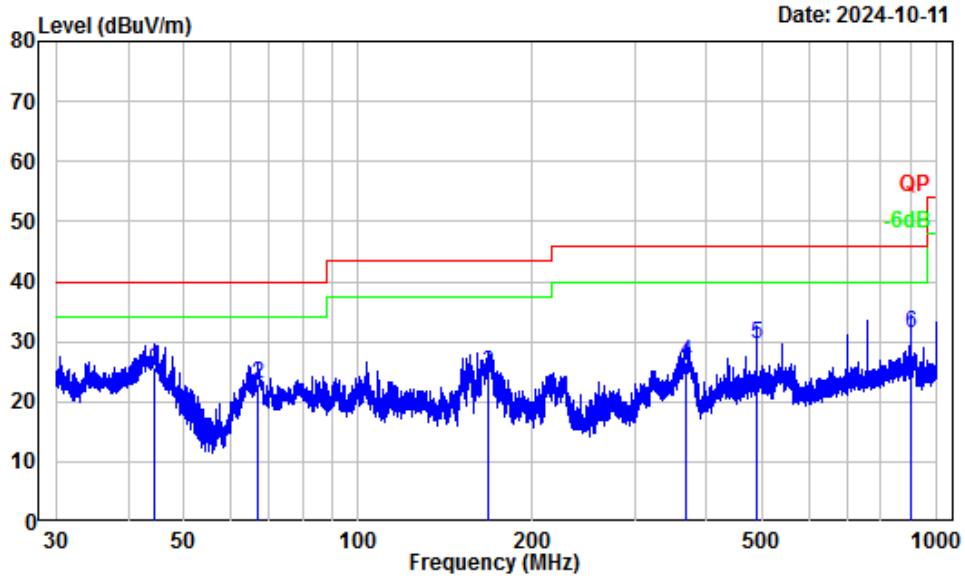

Date: 2024-10-11

Site : Chamber A  
 Condition : 3m Vertical  
 Project Number: 2401U43539E-RF  
 Test Mode : Transmitting  
 Tester : Anson Su

|   | Freq   | Factor | Read Level | Level  | Limit  | Over   | Remark |
|---|--------|--------|------------|--------|--------|--------|--------|
|   | MHz    | dB/m   | dBuV       | dBuV/m | dBuV/m | dB     |        |
| 1 | 44.41  | -16.32 | 41.95      | 25.63  | 40.00  | -14.37 | QP     |
| 2 | 67.14  | -18.60 | 41.59      | 22.99  | 40.00  | -17.01 | QP     |
| 3 | 167.97 | -14.29 | 39.13      | 24.84  | 43.50  | -18.66 | QP     |
| 4 | 369.57 | -11.73 | 38.37      | 26.64  | 46.00  | -19.36 | QP     |
| 5 | 489.24 | -9.04  | 38.66      | 29.62  | 46.00  | -16.38 | QP     |
| 6 | 900.15 | -3.66  | 34.97      | 31.31  | 46.00  | -14.69 | QP     |

**Powered by Battery:**

Mushroom Antenna, Test Model (Worst Case)

**Horizontal**

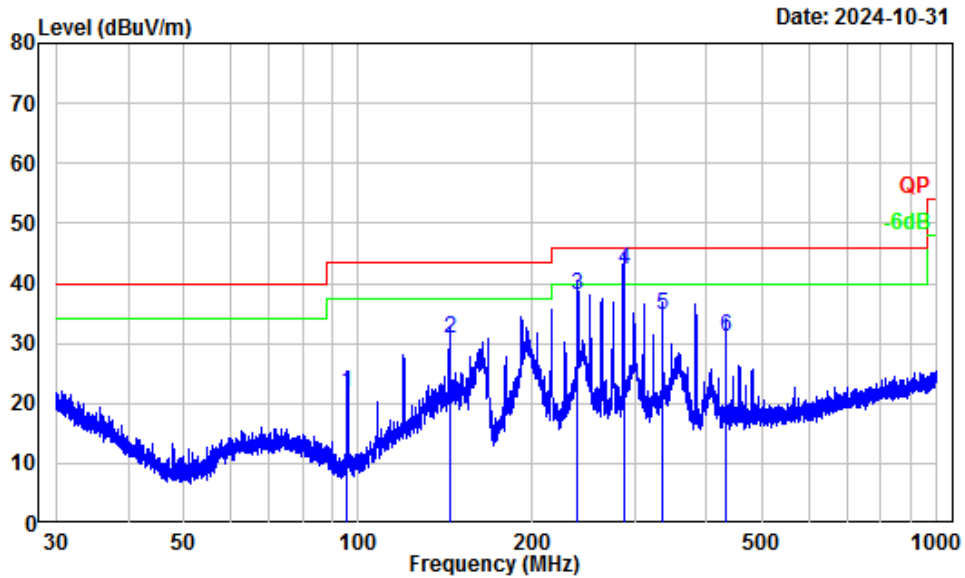

Site : Chamber A  
 Condition : 3m Horizontal  
 Project Number: 2401U43539E-RF  
 Test Mode : Transmitting  
 Tester : Anson Su

|   | Freq   | Factor | Read Level | Level  | Limit  | Over   | Remark |
|---|--------|--------|------------|--------|--------|--------|--------|
|   | MHz    | dB/m   | dBuV       | dBuV/m | dBuV/m | dB     |        |
| 1 | 95.80  | -17.82 | 39.66      | 21.84  | 43.50  | -21.66 | QP     |
| 2 | 143.77 | -13.31 | 44.06      | 30.75  | 43.50  | -12.75 | QP     |
| 3 | 239.36 | -14.53 | 52.70      | 38.17  | 46.00  | -7.83  | QP     |
| 4 | 287.23 | -12.93 | 55.20      | 42.27  | 46.00  | -3.73  | QP     |
| 5 | 335.30 | -12.43 | 47.18      | 34.75  | 46.00  | -11.25 | QP     |
| 6 | 431.98 | -10.16 | 41.37      | 31.21  | 46.00  | -14.79 | QP     |

Vertical

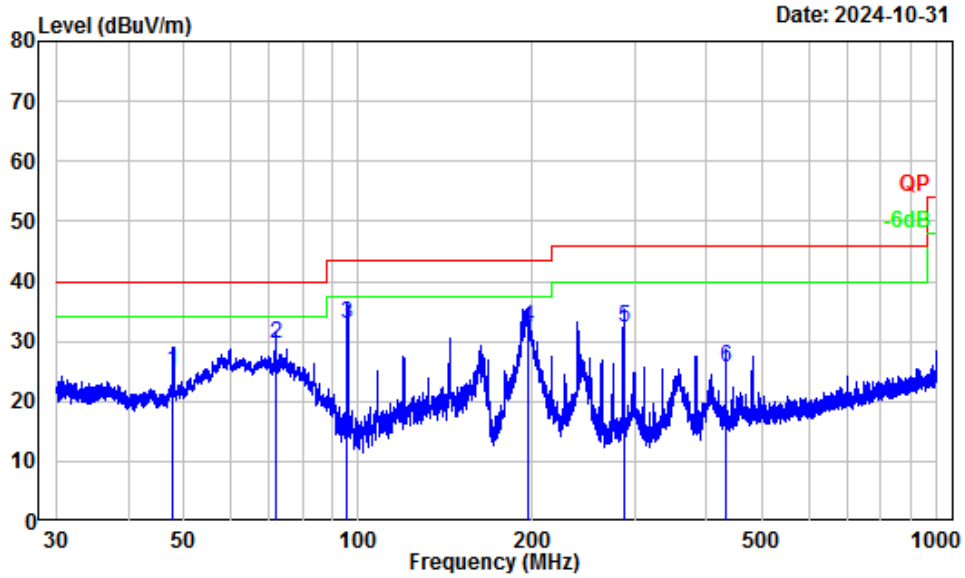

Site : Chamber A  
 Condition : 3m Vertical  
 Project Number: 2401U43539E-RF  
 Test Mode : Transmitting  
 Tester : Anson Su

|   | Freq Factor |        | Read Level |        | Limit  | Over   | Remark |
|---|-------------|--------|------------|--------|--------|--------|--------|
|   | MHz         | dB/m   | dBuV       | dBuV/m | dBuV/m | dB     |        |
| 1 | 47.89       | -18.14 | 43.09      | 24.95  | 40.00  | -15.05 | QP     |
| 2 | 71.86       | -18.55 | 48.03      | 29.48  | 40.00  | -10.52 | QP     |
| 3 | 95.80       | -17.82 | 50.71      | 32.89  | 43.50  | -10.61 | QP     |
| 4 | 195.99      | -12.69 | 45.11      | 32.42  | 43.50  | -11.08 | QP     |
| 5 | 287.61      | -12.93 | 45.26      | 32.33  | 46.00  | -13.67 | QP     |
| 6 | 431.98      | -10.16 | 35.87      | 25.71  | 46.00  | -20.29 | QP     |



**Above 1GHz: (Test Mode3)**

**5150-5250 MHz:**

| Frequency (MHz)         | Receiver       |       | Polar (H/V) | Factor (dB/m) | Corrected Amplitude (dBµV/m) | Limit (dBµV/m) | Margin (dB) |
|-------------------------|----------------|-------|-------------|---------------|------------------------------|----------------|-------------|
|                         | Reading (dBµV) | PK/AV |             |               |                              |                |             |
| <b>Mushroom Antenna</b> |                |       |             |               |                              |                |             |
| 5185MHz                 |                |       |             |               |                              |                |             |
| 5148.15                 | 58.02          | PK    | H           | 2.70          | 60.72                        | 74             | -13.28      |
| 5148.15                 | 47.32          | AV    | H           | 2.70          | 50.02                        | 54             | -3.98       |
| 5137.08                 | 55.65          | PK    | V           | 2.71          | 58.36                        | 74             | -15.64      |
| 5137.08                 | 44.42          | AV    | V           | 2.71          | 47.13                        | 54             | -6.87       |
| 10370.00                | 45.12          | PK    | H           | 12.88         | 58.00                        | 68.2           | -10.20      |
| 10370.00                | 45.19          | PK    | V           | 12.88         | 58.07                        | 68.2           | -10.13      |
| 5205MHz                 |                |       |             |               |                              |                |             |
| 10410.00                | 45.37          | PK    | H           | 12.98         | 58.35                        | 68.2           | -9.85       |
| 10410.00                | 45.63          | PK    | V           | 12.98         | 58.61                        | 68.2           | -9.59       |
| 5225MHz                 |                |       |             |               |                              |                |             |
| 5400.02                 | 54.23          | PK    | H           | 2.99          | 57.22                        | 74             | -16.78      |
| 5400.02                 | 44.04          | AV    | H           | 2.99          | 47.03                        | 54             | -6.97       |
| 5361.34                 | 54.42          | PK    | V           | 2.92          | 57.34                        | 74             | -16.66      |
| 5361.34                 | 44.36          | AV    | V           | 2.92          | 47.28                        | 54             | -6.72       |
| 10450.00                | 45.66          | PK    | H           | 13.26         | 58.92                        | 68.2           | -9.28       |
| 10450.00                | 45.87          | PK    | V           | 13.26         | 59.13                        | 68.2           | -9.07       |
| <b>Blade Antenna</b>    |                |       |             |               |                              |                |             |
| 5185MHz                 |                |       |             |               |                              |                |             |
| 5146.51                 | 61.80          | PK    | H           | 2.70          | 64.50                        | 74             | -9.50       |
| 5148.71                 | 47.39          | AV    | H           | 2.71          | 50.10                        | 54             | -3.90       |
| 4814.26                 | 54.52          | PK    | V           | 2.44          | 56.96                        | 74             | -17.04      |
| 5150.00                 | 42.62          | AV    | V           | 2.71          | 45.33                        | 54             | -8.67       |
| 10370.00                | 44.81          | PK    | H           | 12.88         | 57.69                        | 68.2           | -10.51      |
| 10370.00                | 44.69          | PK    | V           | 12.88         | 57.57                        | 68.2           | -10.63      |
| 5205MHz                 |                |       |             |               |                              |                |             |
| 10410.00                | 44.63          | PK    | H           | 12.98         | 57.61                        | 68.2           | -10.59      |
| 10410.00                | 44.76          | PK    | V           | 12.98         | 57.74                        | 68.2           | -10.46      |
| 5225MHz                 |                |       |             |               |                              |                |             |
| 5361.38                 | 55.26          | PK    | H           | 2.92          | 58.18                        | 74             | -15.82      |
| 5361.38                 | 43.53          | AV    | H           | 2.92          | 46.45                        | 54             | -7.55       |
| 5353.75                 | 54.02          | PK    | V           | 2.92          | 56.94                        | 74             | -17.06      |
| 5353.75                 | 42.12          | AV    | V           | 2.92          | 45.04                        | 54             | -8.96       |
| 10450.00                | 44.94          | PK    | H           | 13.26         | 58.20                        | 68.2           | -10.00      |
| 10450.00                | 44.88          | PK    | V           | 13.26         | 58.14                        | 68.2           | -10.06      |

**5725-5850 MHz:**

| Frequency (MHz)         | Receiver       |       | Polar (H/V) | Factor (dB/m) | Corrected Amplitude (dBµV/m) | Limit (dBµV/m) | Margin (dB) |
|-------------------------|----------------|-------|-------------|---------------|------------------------------|----------------|-------------|
|                         | Reading (dBµV) | PK/AV |             |               |                              |                |             |
| <b>Mushroom Antenna</b> |                |       |             |               |                              |                |             |
| 5760MHz                 |                |       |             |               |                              |                |             |
| 5650.00                 | 55.61          | PK    | H           | 3.59          | 59.20                        | 68.20          | -9.00       |
| 5700.00                 | 59.50          | PK    | H           | 4.09          | 63.59                        | 105.20         | -41.61      |
| 5720.00                 | 66.05          | PK    | H           | 4.09          | 70.14                        | 110.80         | -40.66      |
| 5725.00                 | 67.84          | PK    | H           | 4.09          | 71.93                        | 122.20         | -50.27      |
| 5650.00                 | 56.42          | PK    | V           | 3.59          | 60.01                        | 68.20          | -8.19       |
| 5700.00                 | 59.58          | PK    | V           | 4.09          | 63.67                        | 105.20         | -41.53      |
| 5720.00                 | 66.67          | PK    | V           | 4.09          | 70.76                        | 110.80         | -40.04      |
| 5725.00                 | 68.28          | PK    | V           | 4.09          | 72.37                        | 122.20         | -49.83      |
| 11520.00                | 44.17          | PK    | H           | 14.23         | 58.40                        | 74             | -15.60      |
| 11520.00                | 30.45          | AV    | H           | 14.23         | 44.68                        | 54             | -9.32       |
| 11520.00                | 44.79          | PK    | V           | 14.23         | 59.02                        | 74             | -14.98      |
| 11520.00                | 30.59          | AV    | V           | 14.23         | 44.82                        | 54             | -9.18       |
| 5780MHz                 |                |       |             |               |                              |                |             |
| 11560.00                | 44.33          | PK    | H           | 14.13         | 58.46                        | 74             | -15.54      |
| 11560.00                | 30.75          | AV    | H           | 14.13         | 44.88                        | 54             | -9.12       |
| 11560.00                | 45.10          | PK    | V           | 14.13         | 59.23                        | 74             | -14.77      |
| 11560.00                | 31.14          | AV    | V           | 14.13         | 45.27                        | 54             | -8.73       |
| 5820MHz                 |                |       |             |               |                              |                |             |
| 5850.00                 | 70.76          | PK    | H           | 4.09          | 74.85                        | 122.20         | -47.35      |
| 5855.00                 | 67.70          | PK    | H           | 4.09          | 71.79                        | 110.80         | -39.01      |
| 5875.00                 | 59.04          | PK    | H           | 4.19          | 63.23                        | 105.20         | -41.97      |
| 5925.00                 | 55.23          | PK    | H           | 4.69          | 59.92                        | 68.20          | -8.28       |
| 5850.00                 | 70.95          | PK    | V           | 4.09          | 75.04                        | 122.20         | -47.16      |
| 5855.00                 | 68.37          | PK    | V           | 4.09          | 72.46                        | 110.80         | -38.34      |
| 5875.00                 | 59.41          | PK    | V           | 4.19          | 63.60                        | 105.20         | -41.60      |
| 5925.00                 | 55.59          | PK    | V           | 4.69          | 60.28                        | 68.20          | -7.92       |
| 11640.00                | 45.52          | PK    | H           | 13.83         | 59.35                        | 74             | -14.65      |
| 11640.00                | 31.69          | AV    | H           | 13.83         | 45.52                        | 54             | -8.48       |
| 11640.00                | 45.15          | PK    | V           | 13.83         | 58.98                        | 74             | -15.02      |
| 11640.00                | 31.37          | AV    | V           | 13.83         | 45.20                        | 54             | -8.80       |

| Frequency (MHz)      | Receiver       |       | Polar (H/V) | Factor (dB/m) | Corrected Amplitude (dBµV/m) | Limit (dBµV/m) | Margin (dB) |
|----------------------|----------------|-------|-------------|---------------|------------------------------|----------------|-------------|
|                      | Reading (dBµV) | PK/AV |             |               |                              |                |             |
| <b>Blade Antenna</b> |                |       |             |               |                              |                |             |
| 5760MHz              |                |       |             |               |                              |                |             |
| 5650.00              | 57.82          | PK    | H           | 3.59          | 61.41                        | 68.20          | -6.79       |
| 5700.00              | 62.92          | PK    | H           | 4.09          | 67.01                        | 105.20         | -38.19      |
| 5720.00              | 72.45          | PK    | H           | 4.09          | 76.54                        | 110.80         | -34.26      |
| 5725.00              | 75.45          | PK    | H           | 4.09          | 79.54                        | 122.20         | -42.66      |
| 5650.00              | 56.93          | PK    | V           | 3.59          | 60.52                        | 68.20          | -7.68       |
| 5700.00              | 61.94          | PK    | V           | 4.09          | 66.03                        | 105.20         | -39.17      |
| 5720.00              | 72.38          | PK    | V           | 4.09          | 76.47                        | 110.80         | -34.33      |
| 5725.00              | 75.43          | PK    | V           | 4.09          | 79.52                        | 122.20         | -42.68      |
| 11520.00             | 44.23          | PK    | H           | 14.23         | 58.46                        | 74             | -15.54      |
| 11520.00             | 30.53          | AV    | H           | 14.23         | 44.76                        | 54             | -9.24       |
| 11520.00             | 44.09          | PK    | V           | 14.23         | 58.32                        | 74             | -15.68      |
| 11520.00             | 30.41          | AV    | V           | 14.23         | 44.64                        | 54             | -9.36       |
| 5780MHz              |                |       |             |               |                              |                |             |
| 11560.00             | 44.48          | PK    | H           | 14.13         | 58.61                        | 74             | -15.39      |
| 11560.00             | 31.10          | AV    | H           | 14.13         | 45.23                        | 54             | -8.77       |
| 11560.00             | 45.28          | PK    | V           | 14.13         | 59.41                        | 74             | -14.59      |
| 11560.00             | 30.46          | AV    | V           | 14.13         | 44.59                        | 54             | -9.41       |
| 5820MHz              |                |       |             |               |                              |                |             |
| 5850.28              | 59.44          | PK    | H           | 3.67          | 63.11                        | 121.56         | -58.45      |
| 5860.80              | 59.21          | PK    | H           | 3.71          | 62.92                        | 109.17         | -46.25      |
| 5876.76              | 56.24          | PK    | H           | 3.78          | 60.02                        | 103.89         | -43.87      |
| 5943.73              | 57.74          | PK    | H           | 3.74          | 61.48                        | 68.20          | -6.72       |
| 5854.79              | 55.24          | PK    | V           | 3.70          | 58.94                        | 111.27         | -52.33      |
| 5855.94              | 54.95          | PK    | V           | 3.70          | 58.65                        | 110.54         | -51.89      |
| 5885.99              | 54.97          | PK    | V           | 3.81          | 58.78                        | 97.04          | -38.26      |
| 5936.60              | 54.05          | PK    | V           | 3.77          | 57.82                        | 68.20          | -10.38      |
| 11640.00             | 44.82          | PK    | H           | 13.83         | 58.65                        | 74             | -15.35      |
| 11640.00             | 31.28          | AV    | V           | 13.83         | 45.11                        | 54             | -8.89       |
| 11640.00             | 45.51          | PK    | V           | 13.83         | 59.34                        | 74             | -14.66      |
| 11640.00             | 31.47          | AV    | V           | 13.83         | 45.30                        | 54             | -8.70       |

**Note:**

Factor = Antenna factor (RX) + Cable Loss – Amplifier Factor

Corrected Amplitude = Factor + Reading

Margin = Corrected. Amplitude - Limit

The other spurious emission which is in the noise floor level was not recorded.

**Test plots for Band Edge Measurements (Radiated) (worst case)**

**5150-5250MHz:**

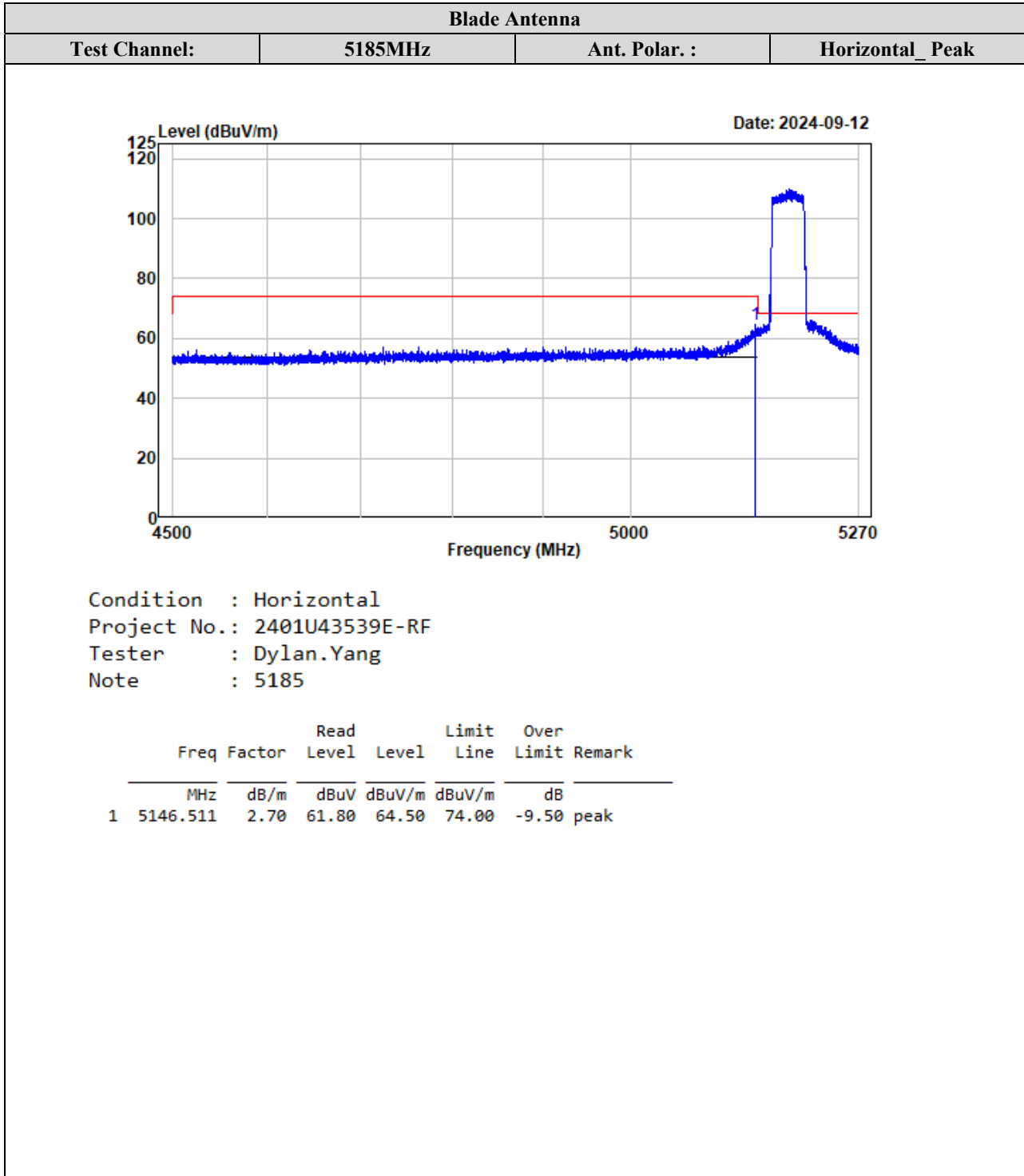

| Blade Antenna |         |               |                    |
|---------------|---------|---------------|--------------------|
| Test Channel: | 5185MHz | Ant. Polar. : | Horizontal_Average |

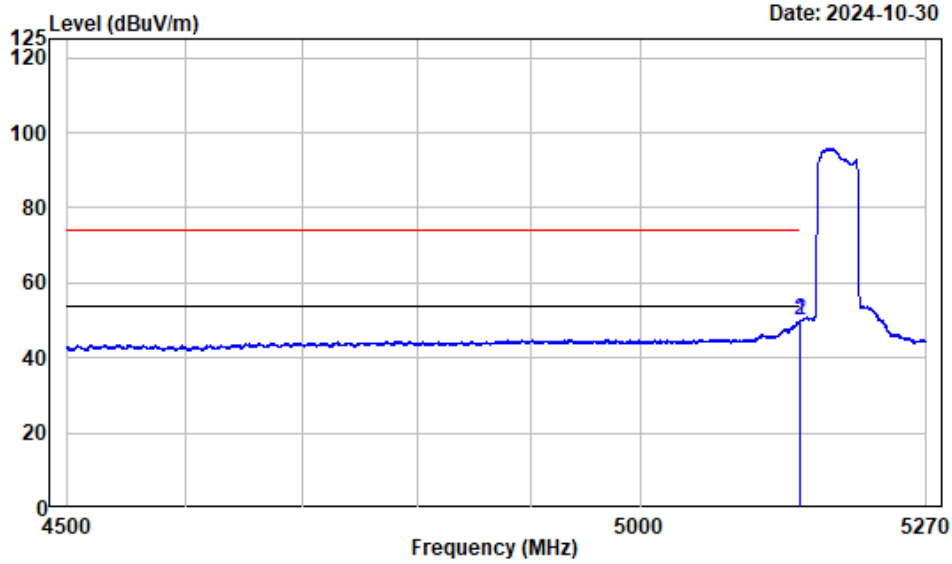

Condition : Horizontal  
 Project No.: 2401U43539E-RF  
 Tester : Dylan.Yang  
 Note : 5185

|   | Freq     | Factor | Read Level | Level  | Limit Line | Over Limit | Remark  |
|---|----------|--------|------------|--------|------------|------------|---------|
|   | MHz      | dB/m   | dBuV       | dBuV/m | dBuV/m     | dB         |         |
| 1 | 5148.710 | 2.71   | 47.39      | 50.10  | 54.00      | -3.90      | Average |
| 2 | 5150.000 | 2.71   | 47.36      | 50.07  | 54.00      | -3.93      | Average |

| Blade Antenna |         |               |               |
|---------------|---------|---------------|---------------|
| Test Channel: | 5185MHz | Ant. Polar. : | Vertical_Peak |

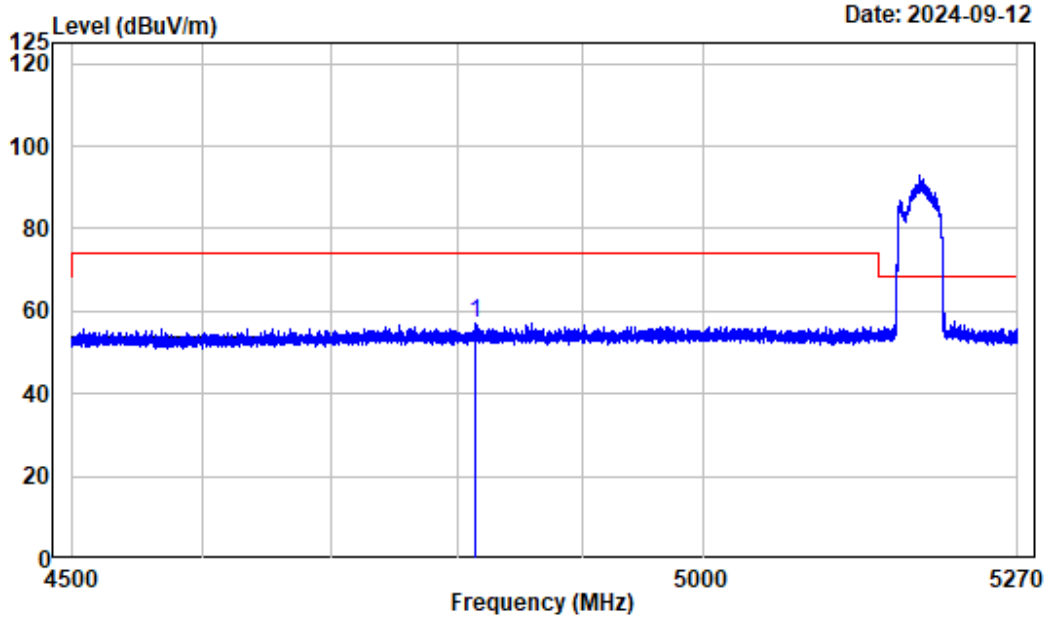

Condition : Vertical  
 Project No.: 2401U43539E-RF  
 Tester : Dylan.Yang  
 Note : 5185

| Freq       | Factor | Read  |        | Limit  | Over   | Remark |
|------------|--------|-------|--------|--------|--------|--------|
|            |        | Level | Level  | Line   | Limit  |        |
| MHz        | dB/m   | dBuV  | dBuV/m | dBuV/m | dB     |        |
| 1 4814.256 | 2.44   | 54.52 | 56.96  | 74.00  | -17.04 | peak   |

| Blade Antenna |         |               |                  |
|---------------|---------|---------------|------------------|
| Test Channel: | 5185MHz | Ant. Polar. : | Vertical_Average |

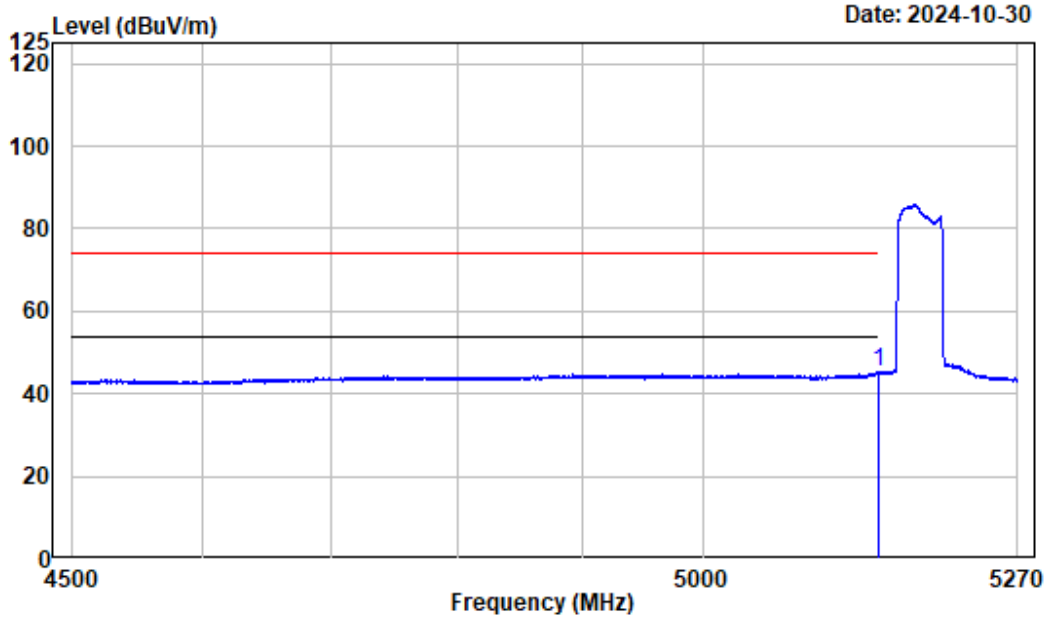

Condition : Vertical  
 Project No.: 2401U43539E-RF  
 Tester : Dylan.Yang  
 Note : 5185

| Freq       | Factor | Read  |        | Limit  | Over  | Remark  |
|------------|--------|-------|--------|--------|-------|---------|
|            |        | Level | Level  |        |       |         |
| MHz        | dB/m   | dBuV  | dBuV/m | dBuV/m | dB    |         |
| 1 5150.000 | 2.71   | 42.62 | 45.33  | 54.00  | -8.67 | Average |

5725-5850 MHz:

| Blade Antenna |         |               |            |
|---------------|---------|---------------|------------|
| Test Channel: | 5820MHz | Ant. Polar. : | Horizontal |

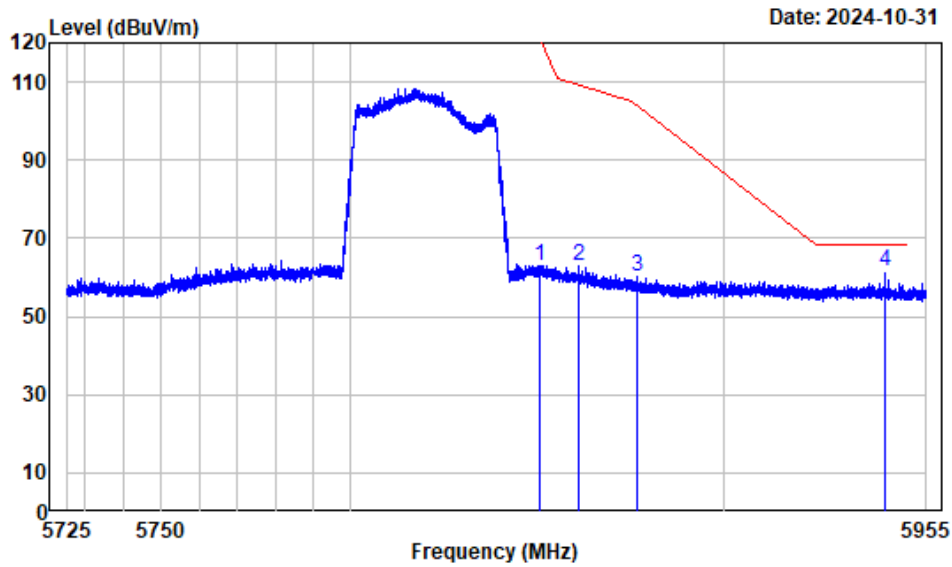

Condition : Horizontal  
 Project No.: 2401U43539E-RF  
 Tester : Dylan.Yang  
 Note : 5820

|   | Freq     | Factor | Read Level | Level  | Limit Line | Over Limit | Remark |
|---|----------|--------|------------|--------|------------|------------|--------|
|   | MHz      | dB/m   | dBuV       | dBUV/m | dBUV/m     | dB         |        |
| 1 | 5850.279 | 3.67   | 59.44      | 63.11  | 121.56     | -58.45     | peak   |
| 2 | 5860.803 | 3.71   | 59.21      | 62.92  | 109.17     | -46.25     | peak   |
| 3 | 5876.761 | 3.78   | 56.24      | 60.02  | 103.89     | -43.87     | peak   |
| 4 | 5943.729 | 3.74   | 57.74      | 61.48  | 68.20      | -6.72      | peak   |



| Blade Antenna |         |               |          |
|---------------|---------|---------------|----------|
| Test Channel: | 5820MHz | Ant. Polar. : | Vertical |

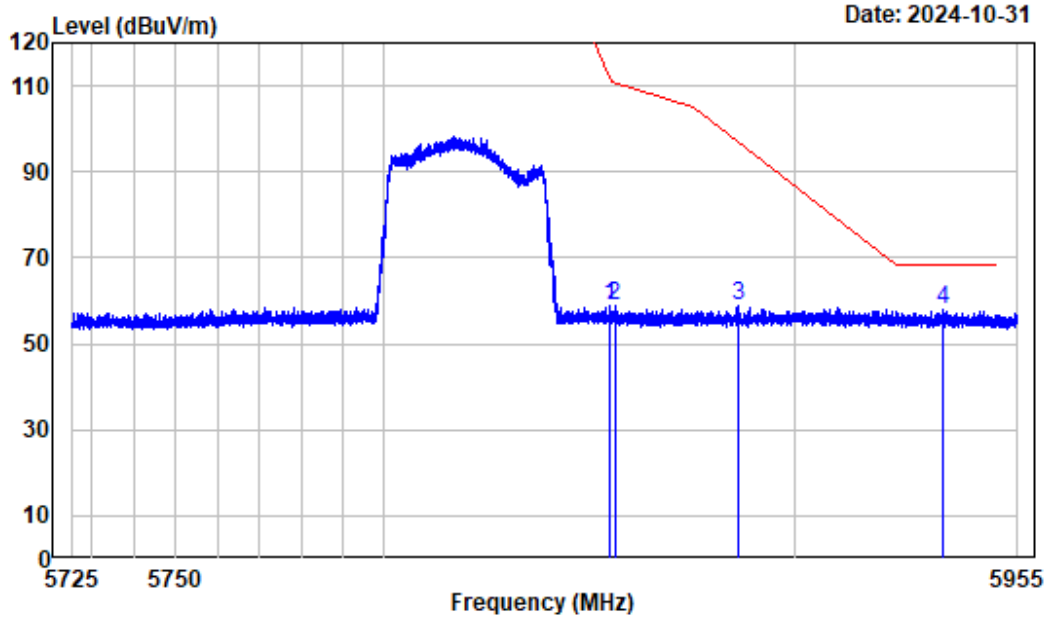

Condition : Vertical  
 Project No.: 2401U43539E-RF  
 Tester : Dylan.Yang  
 Note : 5820

|   | Freq     | Factor | Read Level | Level  | Limit Line | Over Limit | Remark |
|---|----------|--------|------------|--------|------------|------------|--------|
|   | MHz      | dB/m   | dBuV       | dBuV/m | dBuV/m     | dB         |        |
| 1 | 5854.794 | 3.70   | 55.24      | 58.94  | 111.27     | -52.33     | peak   |
| 2 | 5855.944 | 3.70   | 54.95      | 58.65  | 110.54     | -51.89     | peak   |
| 3 | 5885.991 | 3.81   | 54.97      | 58.78  | 97.04      | -38.26     | peak   |
| 4 | 5936.598 | 3.77   | 54.05      | 57.82  | 68.20      | -10.38     | peak   |

**Listed with the worst harmonic margin test plot:**

Mushroom Antenna, 5225MHz:

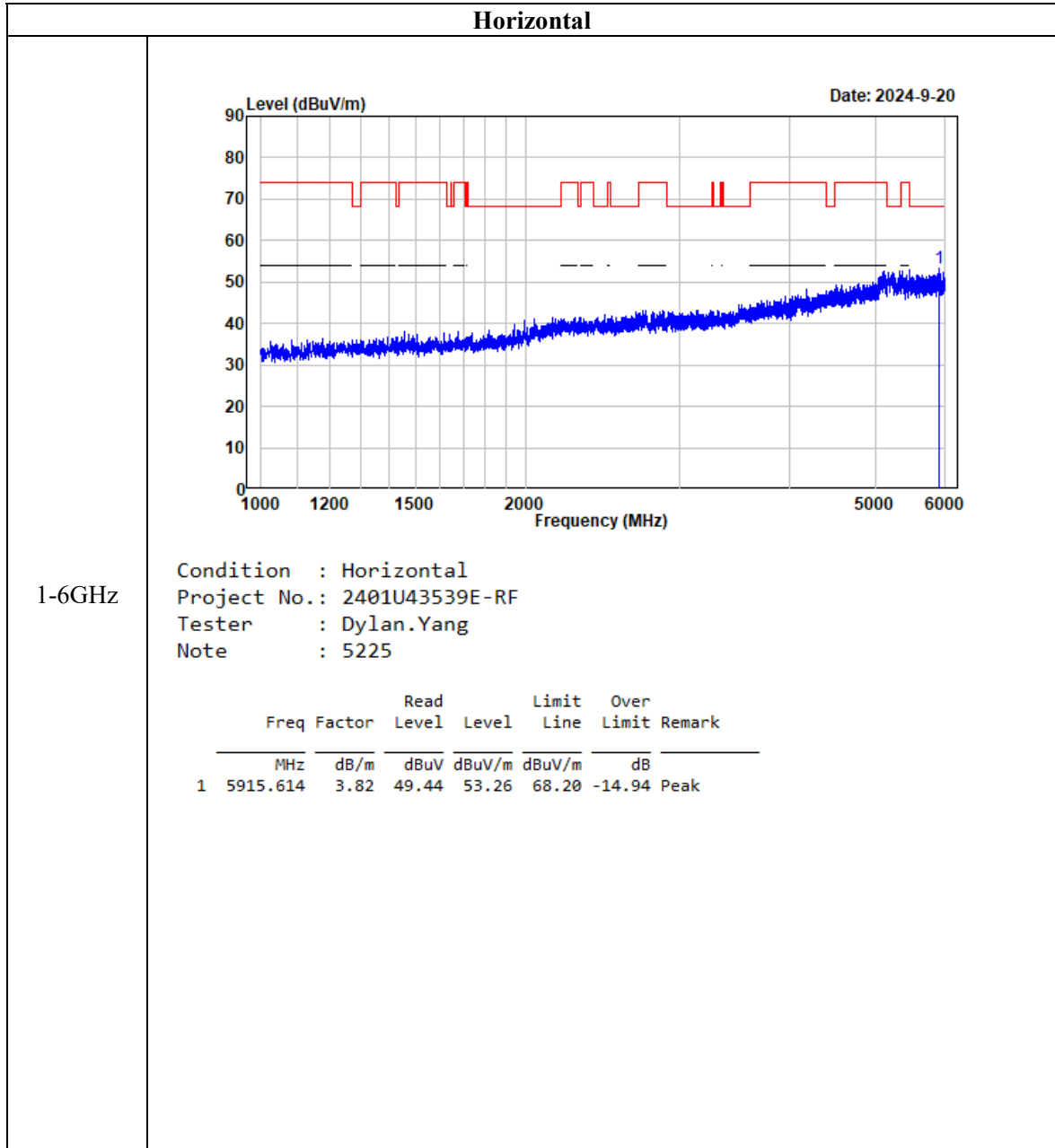

**Vertical**

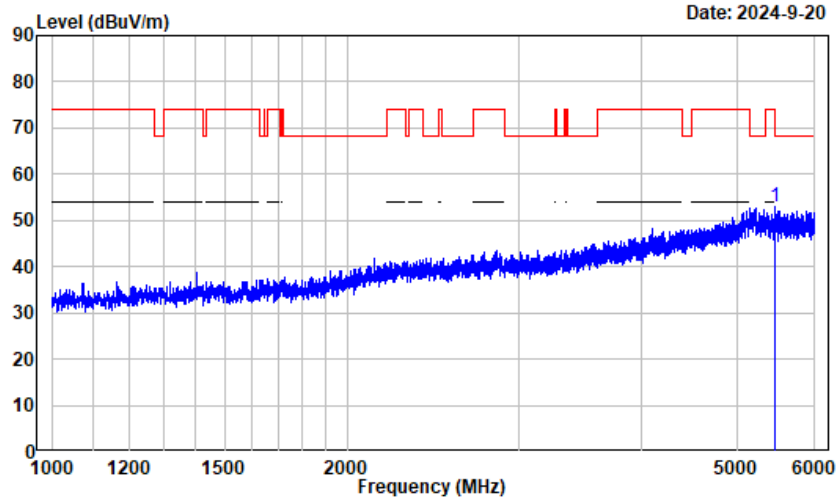

1-6GHz

Condition : Vertical  
 Project No.: 2401U43539E-RF  
 Tester : Dylan.Yang  
 Note : 5225

|   | Freq     | Factor | Read Level | Level  | Limit Line | Over Limit | Remark |
|---|----------|--------|------------|--------|------------|------------|--------|
|   | MHz      | dB/m   | dBuV       | dBuV/m | dBuV/m     | dB         |        |
| 1 | 5465.558 | 3.06   | 49.86      | 52.92  | 68.20      | -15.28     | Peak   |

**Horizontal Peak**

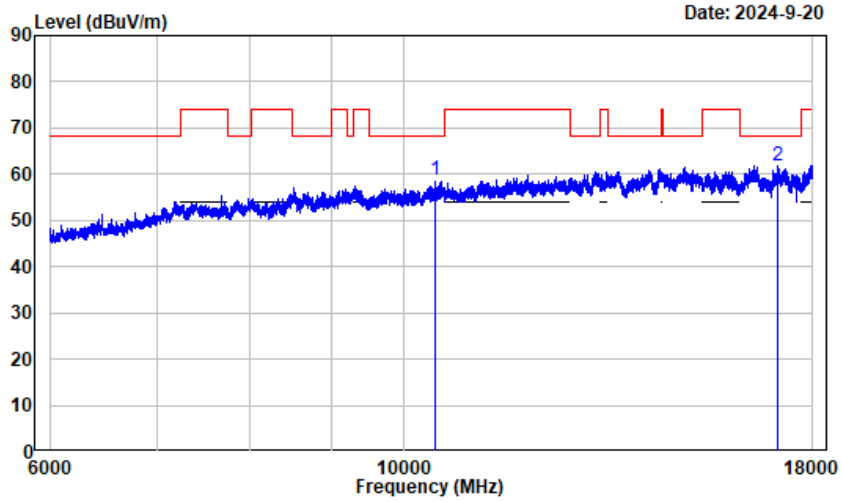

6-18GHz

Condition : Horizontal  
 Project No.: 2401U43539E-RF  
 Tester : Dylan.Yang  
 Note : 5225

|      | Read      | Limit | Over   |        |       |       |      |
|------|-----------|-------|--------|--------|-------|-------|------|
| Freq | Factor    | Level | Level  | Line   |       |       |      |
| MHz  | dB/m      | dBuV  | dBuV/m | dBuV/m |       |       |      |
| 1    | 10450.000 | 13.26 | 45.66  | 58.92  | 68.20 | -9.28 | Peak |
| 2    | 17105.890 | 18.05 | 43.75  | 61.80  | 68.20 | -6.40 | Peak |

**Horizontal Average**

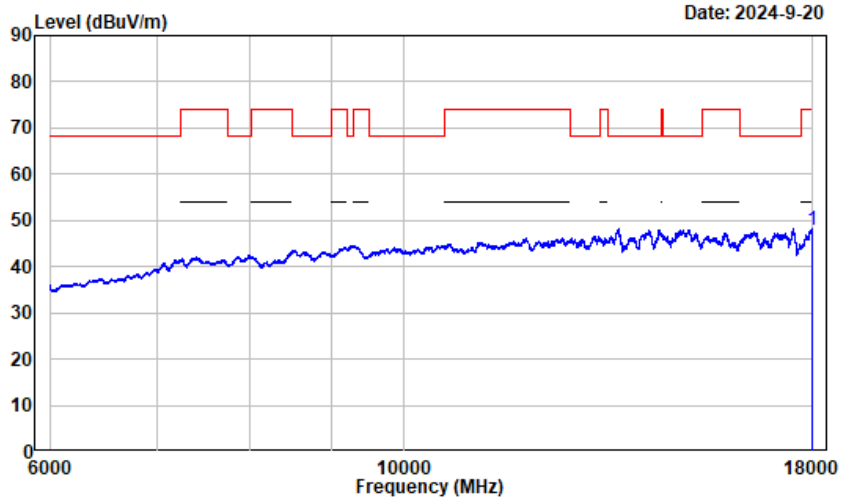

6-18GHz

Condition : Horizontal  
 Project No.: 2401U43539E-RF  
 Tester : Dylan.Yang  
 Note : 5225

|   | Freq      | Factor | Read Level | Level  | Limit Line | Over Limit | Remark  |
|---|-----------|--------|------------|--------|------------|------------|---------|
|   | MHz       | dB/m   | dBuV       | dBuV/m | dBuV/m     | dB         |         |
| 1 | 17994.000 | 24.58  | 23.36      | 47.94  | 54.00      | -6.06      | Average |

Note: Spectrum Analyzer Setting: RBW=1MHz, VBW=5kHz

Vertical\_Peak

6-18GHz

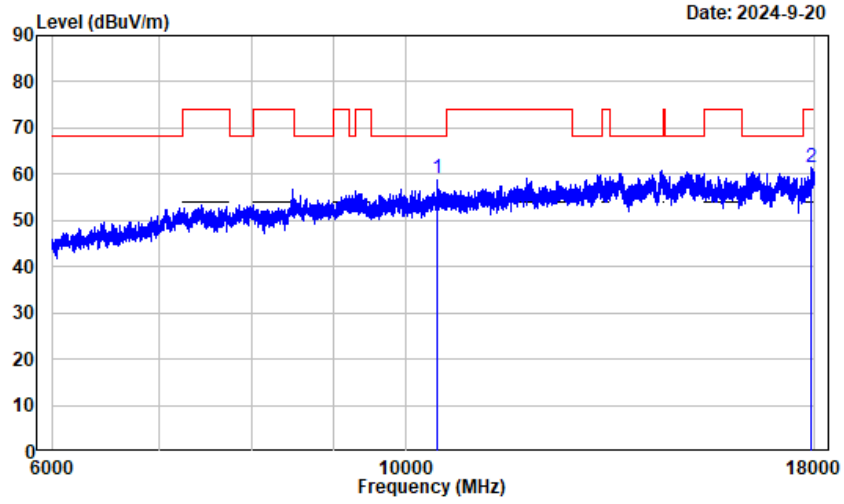

Condition : Vertical  
 Project No.: 2401U43539E-RF  
 Tester : Dylan.Yang  
 Note : 5225

|             | Read  | Limit | Over   |                   |
|-------------|-------|-------|--------|-------------------|
| Freq        | Level | Line  | Limit  | Remark            |
| MHz         | dB/m  | dBuV  | dBuV/m | dB                |
| 1 10450.000 | 13.26 | 45.87 | 59.13  | 68.20 -9.07 Peak  |
| 2 17918.990 | 24.05 | 37.56 | 61.61  | 74.00 -12.39 Peak |

Vertical\_Average

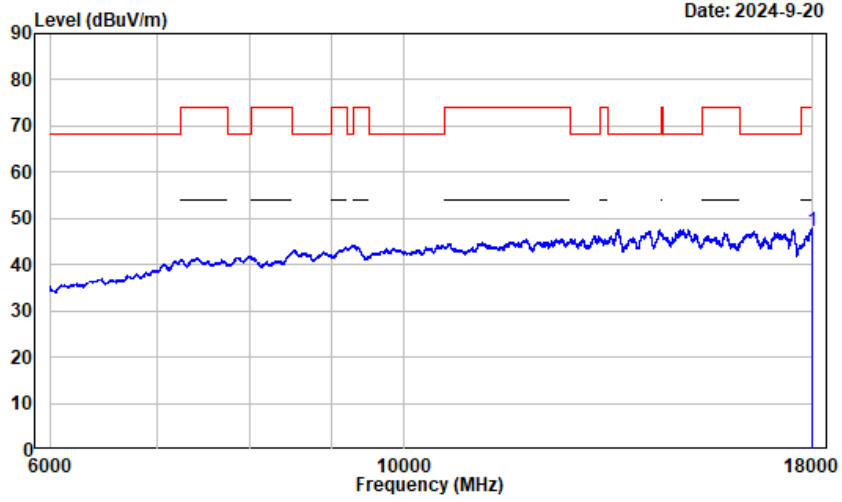

6-18GHz

Condition : Vertical  
 Project No.: 2401U43539E-RF  
 Tester : Dylan.Yang  
 Note : 5225

| Freq        | Factor | Read  |        | Limit  | Over  | Remark  |
|-------------|--------|-------|--------|--------|-------|---------|
|             |        | Level | Level  |        |       |         |
| MHz         | dB/m   | dBuV  | dBuV/m | dBuV/m | dB    |         |
| 1 17973.000 | 24.43  | 22.75 | 47.18  | 54.00  | -6.82 | Average |

Note: Spectrum Analyzer Setting: RBW=1MHz, VBW=5kHz

**Horizontal\_Peak**

18-40GHz

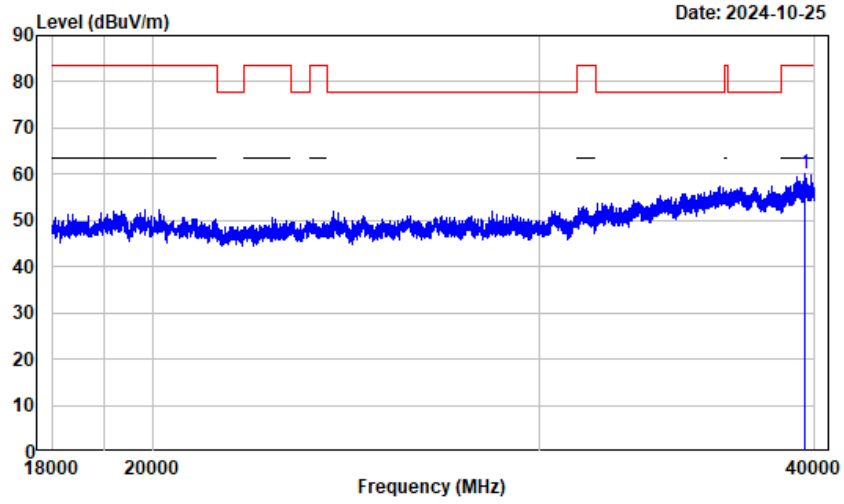

Condition : Horizontal  
 Project No.: 2401U43539E-RF  
 Tester : Dylan.Yang  
 Note : 5225

|   | Freq      | Factor | Read Level | Level  | Limit Line | Over Limit | Remark |
|---|-----------|--------|------------|--------|------------|------------|--------|
|   | MHz       | dB/m   | dBuV       | dBuV/m | dBuV/m     | dB         |        |
| 1 | 39587.450 | 22.77  | 37.31      | 60.08  | 83.50      | -23.42     | Peak   |



**Vertical\_Peak**

18-40GHz

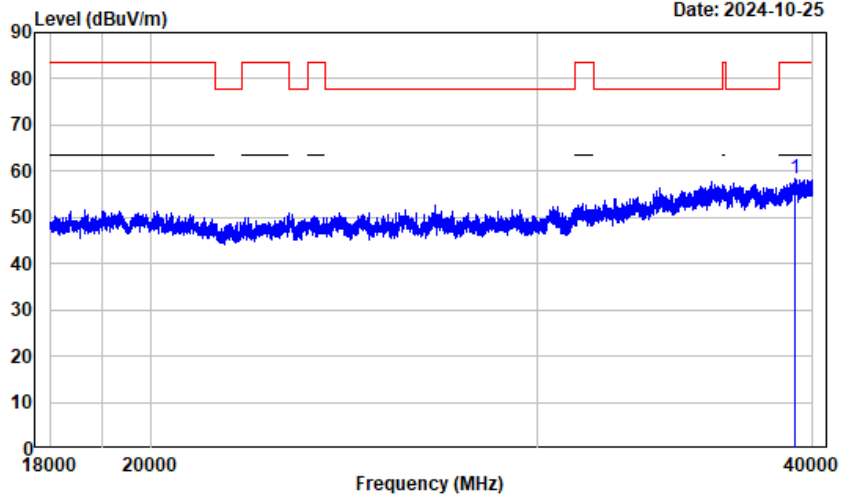

Condition : Vertical  
 Project No. : 2401U43539E-RF  
 Tester : Dylan.Yang  
 Note : 5225

| Freq        | Factor | Read  |        | Limit  | Over   | Remark |
|-------------|--------|-------|--------|--------|--------|--------|
|             |        | Level | Level  |        |        |        |
| MHz         | dB/m   | dBuV  | dBuV/m | dBuV/m | dB     |        |
| 1 39240.910 | 22.83  | 35.56 | 58.39  | 83.50  | -25.11 | Peak   |

Mushroom Antenna, 5820MHz:

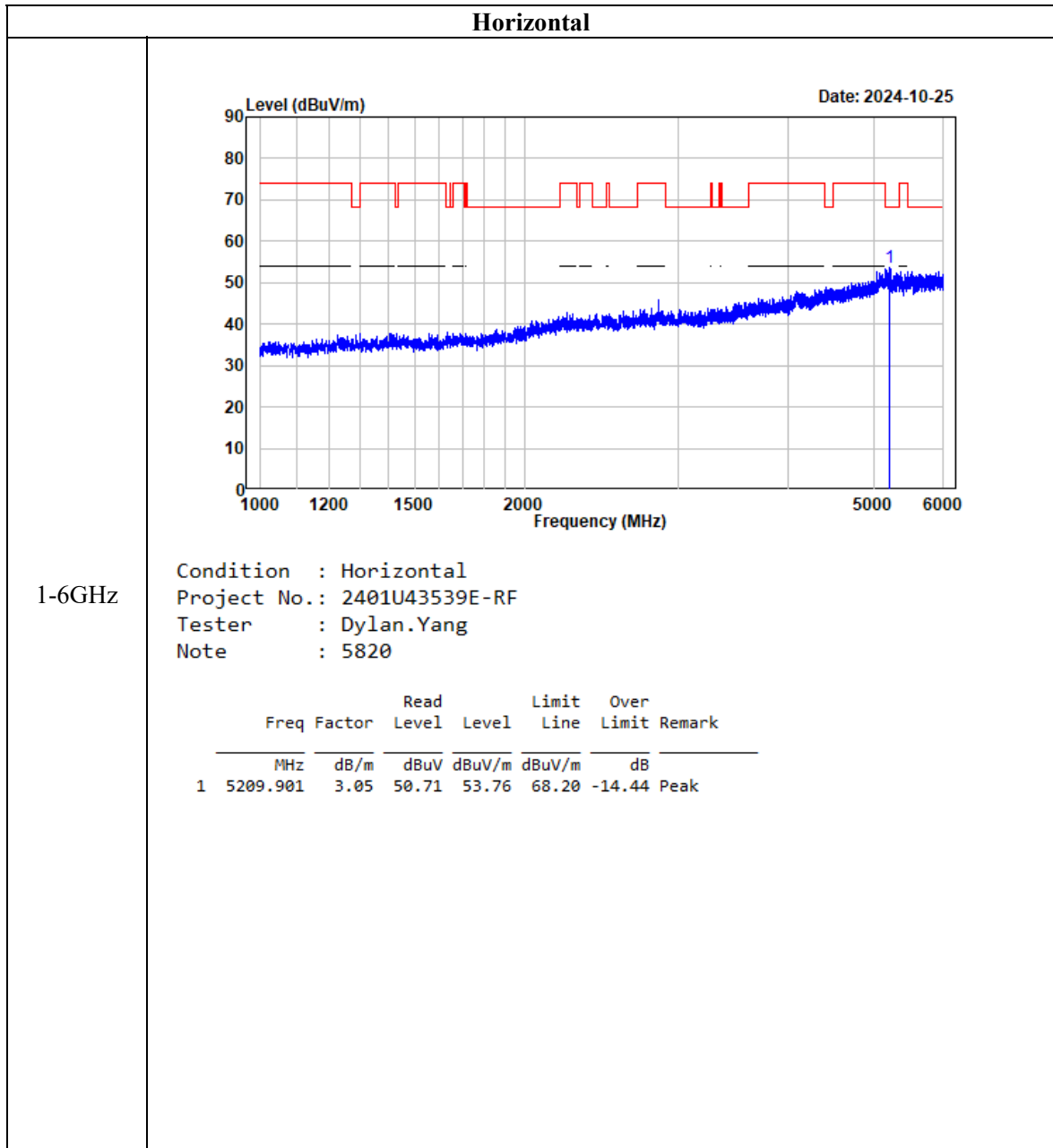

**Vertical**

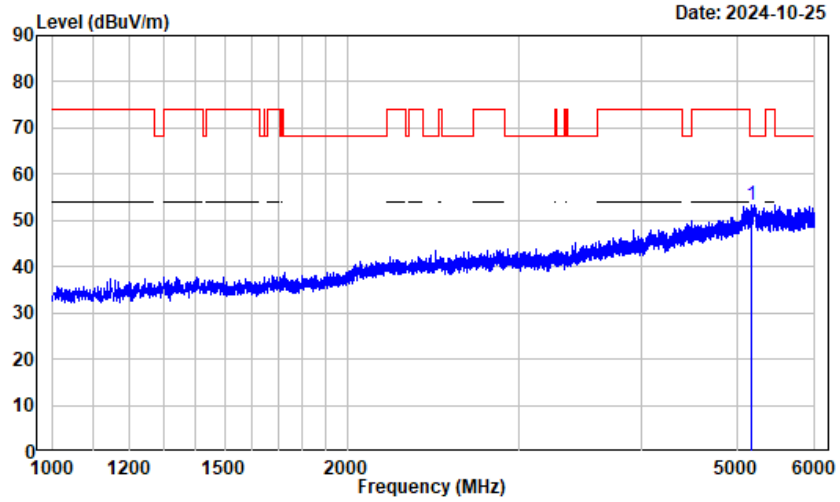

1-6GHz

Condition : Vertical  
 Project No.: 2401U43539E-RF  
 Tester : Dylan.Yang  
 Note : 5820

|   | Freq     | Factor | Read Level | Level  | Limit Line | Over Limit | Remark |
|---|----------|--------|------------|--------|------------|------------|--------|
|   | MHz      | dB/m   | dBuV       | dBuV/m | dBuV/m     | dB         |        |
| 1 | 5171.146 | 2.86   | 50.62      | 53.48  | 68.20      | -14.72     | Peak   |

**Horizontal\_Peak**

6-18GHz

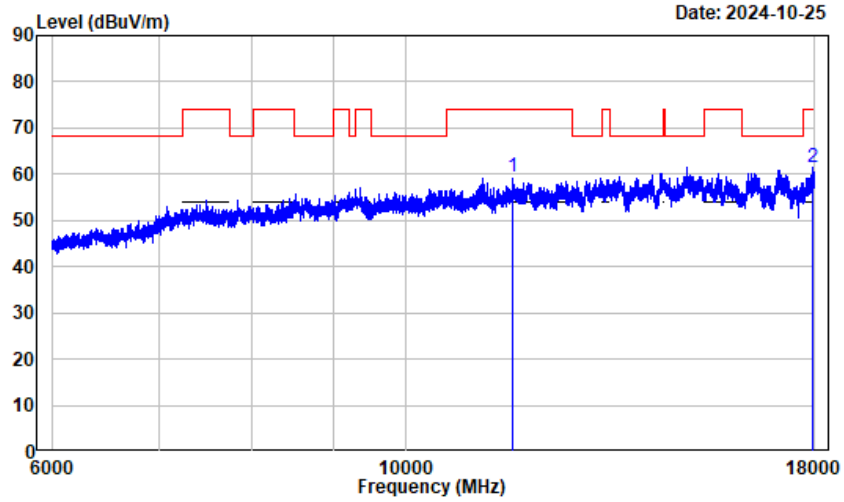

Condition : Horizontal  
 Project No.: 2401U43539E-RF  
 Tester : Dylan.Yang  
 Note : 5820

|   | Freq      | Factor | Read Level | Level  | Limit Line | Over Limit | Remark |
|---|-----------|--------|------------|--------|------------|------------|--------|
|   | MHz       | dB/m   | dBuV       | dBuV/m | dBuV/m     | dB         |        |
| 1 | 11640.000 | 13.83  | 45.52      | 59.35  | 74.00      | -14.65     | Peak   |
| 2 | 17957.990 | 24.33  | 37.21      | 61.54  | 74.00      | -12.46     | Peak   |

Horizontal\_Average

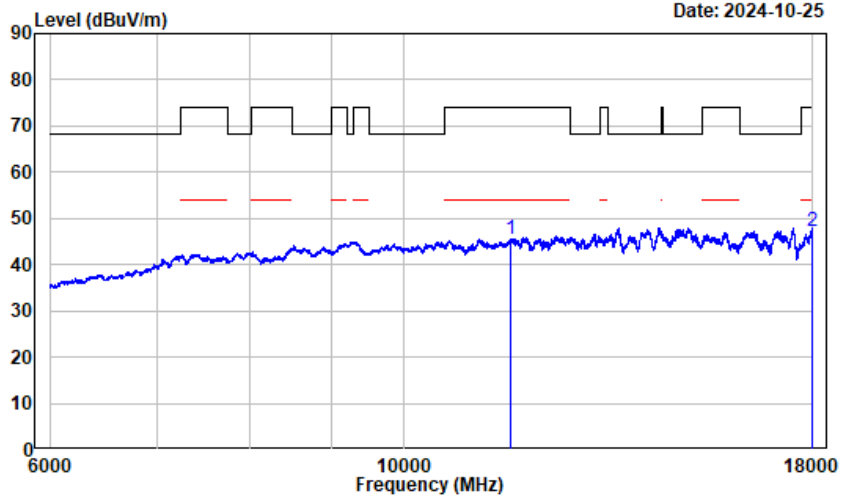

6-18GHz

Condition : Horizontal  
 Project No.: 2401U43539E-RF  
 Tester : Dylan.Yang  
 Note : 5820

|   | Freq      | Factor | Read Level | Level  | Limit Line | Over Limit | Remark  |
|---|-----------|--------|------------|--------|------------|------------|---------|
|   | MHz       | dB/m   | dBuV       | dBuV/m | dBuV/m     | dB         |         |
| 1 | 11640.000 | 13.83  | 31.69      | 45.52  | 54.00      | -8.48      | Average |
| 2 | 18000.000 | 24.62  | 22.68      | 47.30  | 54.00      | -6.70      | Average |

Note: Spectrum Analyzer Setting: RBW=1MHz, VBW=5kHz

Vertical\_Peak

6-18GHz

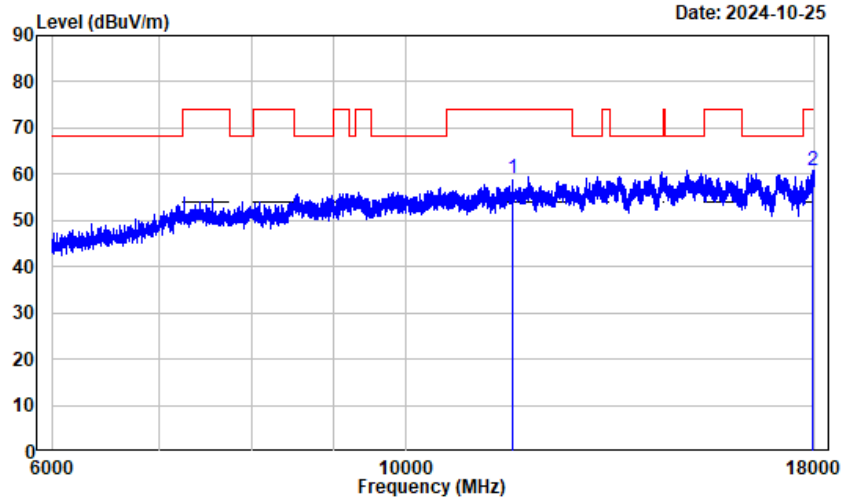

Condition : Vertical  
 Project No.: 2401U43539E-RF  
 Tester : Dylan.Yang  
 Note : 5820

|   | Freq      | Factor | Read  |        | Limit  | Over   | Remark |
|---|-----------|--------|-------|--------|--------|--------|--------|
|   |           |        | Level | Level  |        |        |        |
|   | MHz       | dB/m   | dBuV  | dBuV/m | dBuV/m | dB     |        |
| 1 | 11640.000 | 13.83  | 45.15 | 58.98  | 74.00  | -15.02 | Peak   |
| 2 | 17935.490 | 24.16  | 36.78 | 60.94  | 74.00  | -13.06 | Peak   |

Vertical\_Average

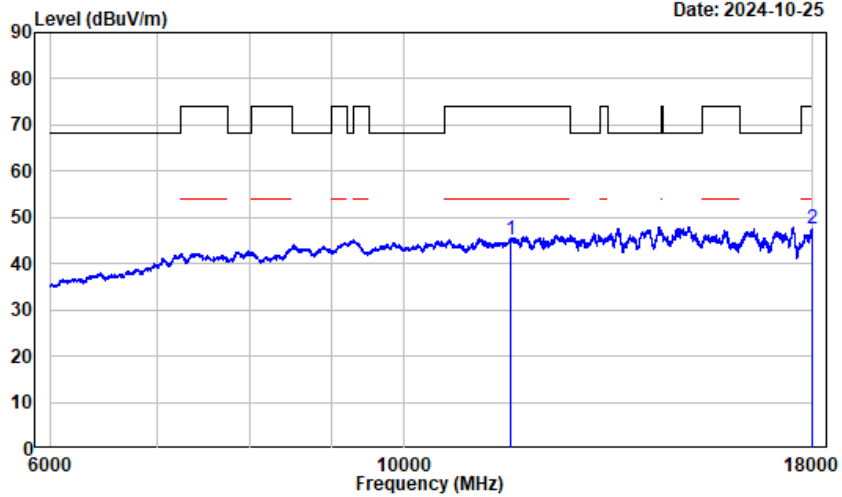

6-18GHz

Condition : Vertical  
 Project No. : 2401U43539E-RF  
 Tester : Dylan.Yang  
 Note : 5820

|   | Freq      | Factor | Read Level | Level  | Limit Line | Over Limit | Remark  |
|---|-----------|--------|------------|--------|------------|------------|---------|
|   | MHz       | dB/m   | dBuV       | dBuV/m | dBuV/m     | dB         |         |
| 1 | 11640.000 | 13.83  | 31.37      | 45.20  | 54.00      | -8.80      | Average |
| 2 | 18000.000 | 24.62  | 22.82      | 47.44  | 54.00      | -6.56      | Average |

Note: Spectrum Analyzer Setting: RBW=1MHz, VBW=5kHz

**Horizontal\_Peak**

18-40GHz

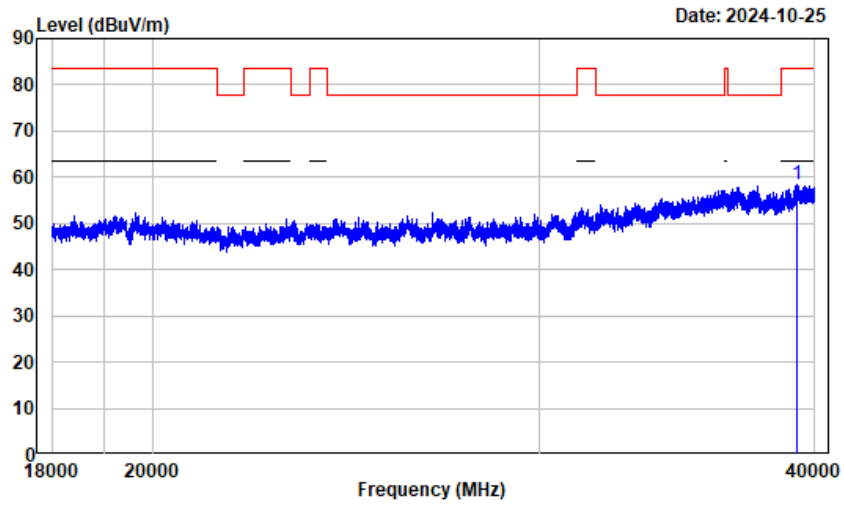

Condition : Horizontal  
 Project No.: 2401U43539E-RF  
 Tester : Dylan.Yang  
 Note : 5820

| Freq        | Factor | Read  |        | Limit  | Over   | Remark |
|-------------|--------|-------|--------|--------|--------|--------|
|             |        | Level | Level  |        |        |        |
| MHz         | dB/m   | dBuV  | dBuV/m | dBuV/m | dB     |        |
| 1 39293.160 | 22.71  | 35.85 | 58.56  | 83.50  | -24.94 | Peak   |



Vertical\_Peak

18-40GHz

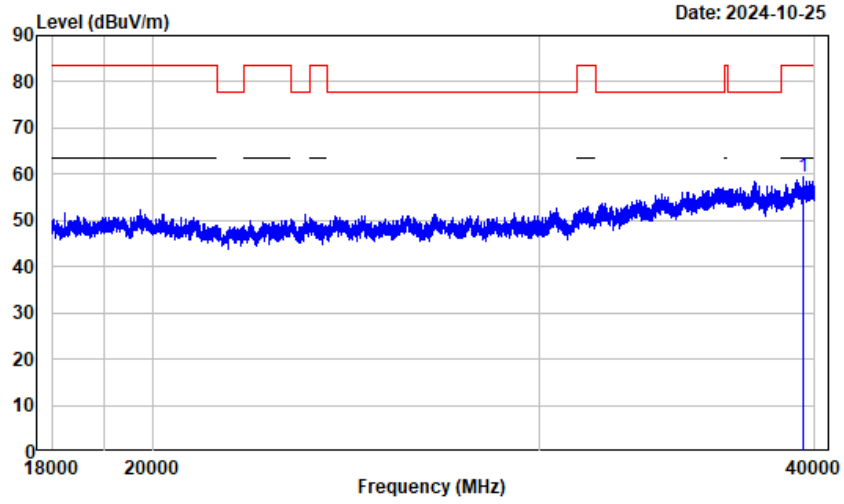

Condition : Vertical  
 Project No.: 2401U43539E-RF  
 Tester : Dylan.Yang  
 Note : 5820

|   | Freq      | Factor | Read Level | Level  | Limit Line | Over Limit | Remark |
|---|-----------|--------|------------|--------|------------|------------|--------|
|   | MHz       | dB/m   | dBuV       | dBuV/m | dBuV/m     | dB         |        |
| 1 | 39532.440 | 22.68  | 36.81      | 59.49  | 83.50      | -24.01     | Peak   |

## **FCC §15.407(a), (e) - 26 dB & 6dB EMISSION BANDWIDTH**

### **Applicable Standard**

The maximum power spectral density is measured as a conducted emission by direct connection of a calibrated test instrument to the equipment under test. If the device cannot be connected directly, alternative techniques acceptable to the Commission may be used. Measurements in the 5.725-5.85 GHz band are made over a reference bandwidth of 500 kHz or the 26 dB emission bandwidth of the device, whichever is less. Measurements in the 5.15-5.25 GHz, 5.25-5.35 GHz, and the 5.47-5.725 GHz bands are made over a bandwidth of 1 MHz or the 26 dB emission bandwidth of the device, whichever is less. A narrower resolution bandwidth can be used, provided that the measured power is integrated over the full reference bandwidth.

Within the 5.725-5.85 GHz band, the minimum 6 dB bandwidth of U-NII devices shall be at least 500 kHz.

### **Test Procedure**

According to KDB789033 D02 section II.C and section II.D

#### **1. Emission Bandwidth (EBW)**

- a) Set RBW = approximately 1% of the emission bandwidth.
- b) Set the VBW > RBW.
- c) Detector = Peak.
- d) Trace mode = max hold.
- e) Measure the maximum width of the emission that is 26 dB down from the maximum of the emission. Compare this with the RBW setting of the analyzer. Readjust RBW and repeat measurement as needed until the RBW/EBW ratio is approximately 1%.

#### **2. Minimum Emission Bandwidth for the band 5.725-5.85 GHz**

Section 15.407(e) specifies the minimum 6 dB emission bandwidth of at least 500 KHz for the band 5.725-5.85 GHz. The following procedure shall be used for measuring this bandwidth:

- a) Set RBW = 100 kHz.
- b) Set the video bandwidth (VBW)  $\geq 3 \times$  RBW.
- c) Detector = Peak.
- d) Trace mode = max hold.
- e) Sweep = auto couple.
- f) Allow the trace to stabilize.
- g) Measure the maximum width of the emission that is constrained by the frequencies associated with the two outermost amplitude points (upper and lower frequencies) that are attenuated by 6 dB relative to the maximum level measured in the fundamental emission.

#### **3. 99% Occupied Bandwidth:**

According to ANSI C63.10-2013 Section 12.4.2&6.9.3

The occupied bandwidth is the frequency bandwidth such that, below its lower and above its upper frequency limits, the mean powers are each equal to 0.5% of the total mean power of the given emission. The following procedure shall be used for measuring 99% power bandwidth:

- a) The instrument center frequency is set to the nominal EUT channel center frequency. The frequency span for the spectrum analyzer shall be between 1.5 times and 5.0 times the OBW.
- b) The nominal IF filter bandwidth (3 dB RBW) shall be in the range of 1% to 5% of the OBW, and VBW shall be approximately three times the RBW, unless otherwise specified by the applicable requirement.

- c) Set the reference level of the instrument as required, keeping the signal from exceeding the maximum input mixer level for linear operation. In general, the peak of the spectral envelope shall be more than  $[10 \log (OBW/RBW)]$  below the reference level. Specific guidance is given in 4.1.5.2.
- d) Step a) through step c) might require iteration to adjust within the specified range.
- e) Video averaging is not permitted. Where practical, a sample detection and single sweep mode shall be used. Otherwise, peak detection and max hold mode (until the trace stabilizes) shall be used.
- f) Use the 99% power bandwidth function of the instrument (if available) and report the measured bandwidth.
- g) If the instrument does not have a 99% power bandwidth function, then the trace data points are recovered and directly summed in linear power terms. The recovered amplitude data points, beginning at the lowest frequency, are placed in a running sum until 0.5% of the total is reached; that frequency is recorded as the lower frequency. The process is repeated until 99.5% of the total is reached; that frequency is recorded as the upper frequency. The 99% power bandwidth is the difference between these two frequencies.
- h) The occupied bandwidth shall be reported by providing plot(s) of the measuring instrument display; the plot axes and the scale units per division shall be clearly labeled. Tabular data may be reported in addition to the plot(s).

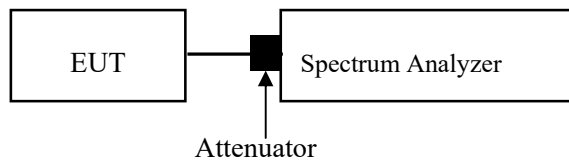

**Test Data**

**Environmental Conditions**

|                           |         |
|---------------------------|---------|
| <b>Temperature:</b>       | 23~28°C |
| <b>Relative Humidity:</b> | 47~58 % |
| <b>ATM Pressure:</b>      | 101 kPa |

*The testing was performed by Rainbow Zhu from 2024-08-31 to 2024-11-08*

*EUT operation mode: Transmitting*

***Test Result: Compliant.***

**5150-5250MHz:**

| Test Modes | Test Frequency (MHz) | 26 dB Bandwidth (MHz) | 99% Occupied Bandwidth (MHz) |
|------------|----------------------|-----------------------|------------------------------|
| OFDM       | 5185                 | 41.410                | 37.564                       |
|            | 5205                 | 41.282                | 37.564                       |
|            | 5225                 | 41.539                | 37.564                       |

Note: Test only was performed at Chain 0.  
 Note: The 99% Occupied Bandwidth have not fall into the band 5250-5350MHz, please refer to the test plots of 99% Occupied Bandwidth.

**5725-5850MHz:**

| Test Modes | Test Frequency (MHz) | 6 dB Bandwidth (MHz) | 99% Occupied Bandwidth (MHz) |
|------------|----------------------|----------------------|------------------------------|
| OFDM       | 5760                 | 38.000               | 37.564                       |
|            | 5780                 | 38.154               | 37.564                       |
|            | 5820                 | 38.154               | 37.564                       |

Note:  
 6dB Emission Bandwidth Limit:  $\geq 0.5$ MHz.  
 The 99% Occupied Bandwidth have not fall into the band 5470-5725MHz, please refer to the test plots of 99% Occupied Bandwidth.  
 Test only was performed at Chain 0.

5150-5250MHz:

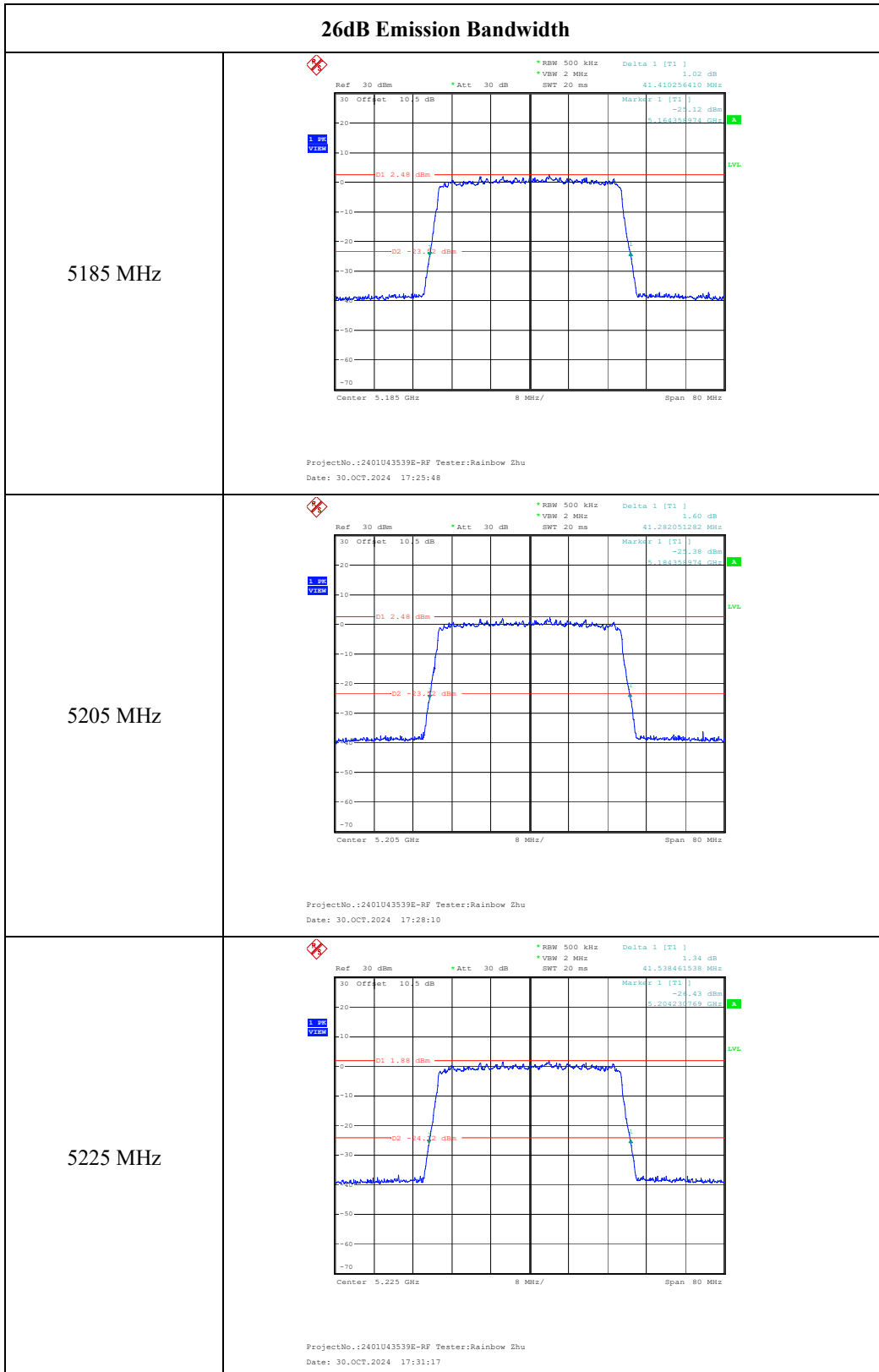

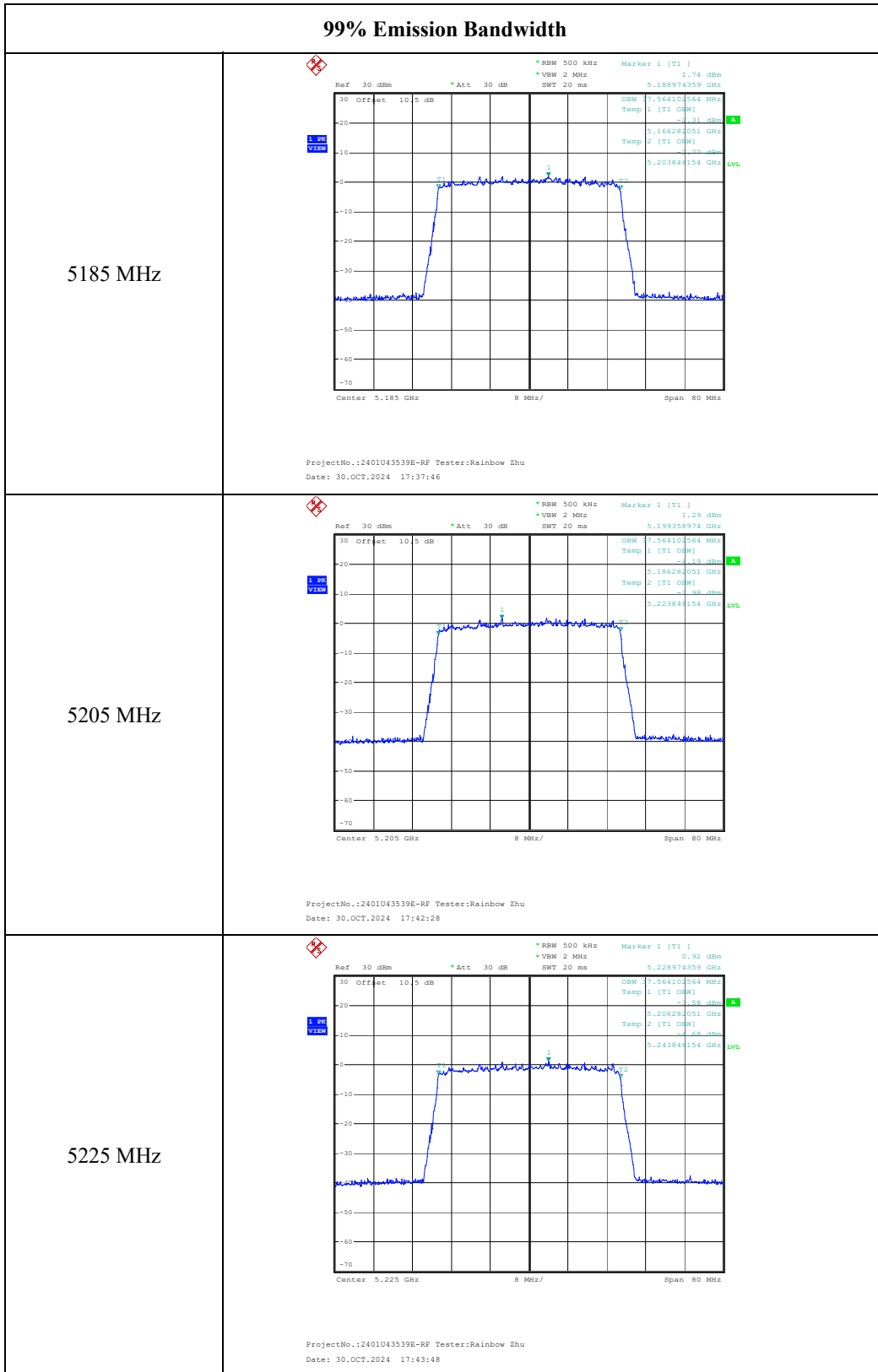

5725-5850MHz:

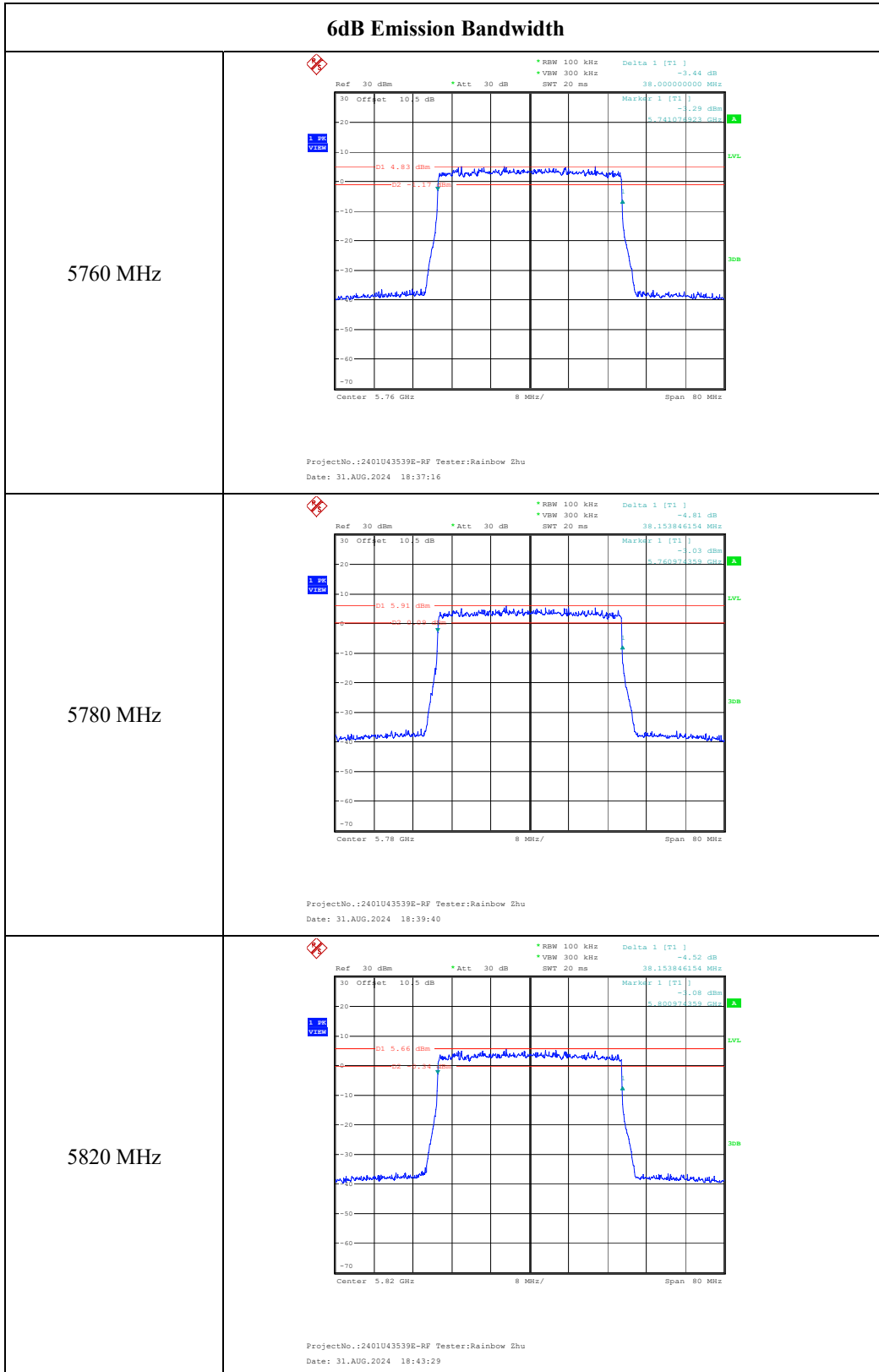

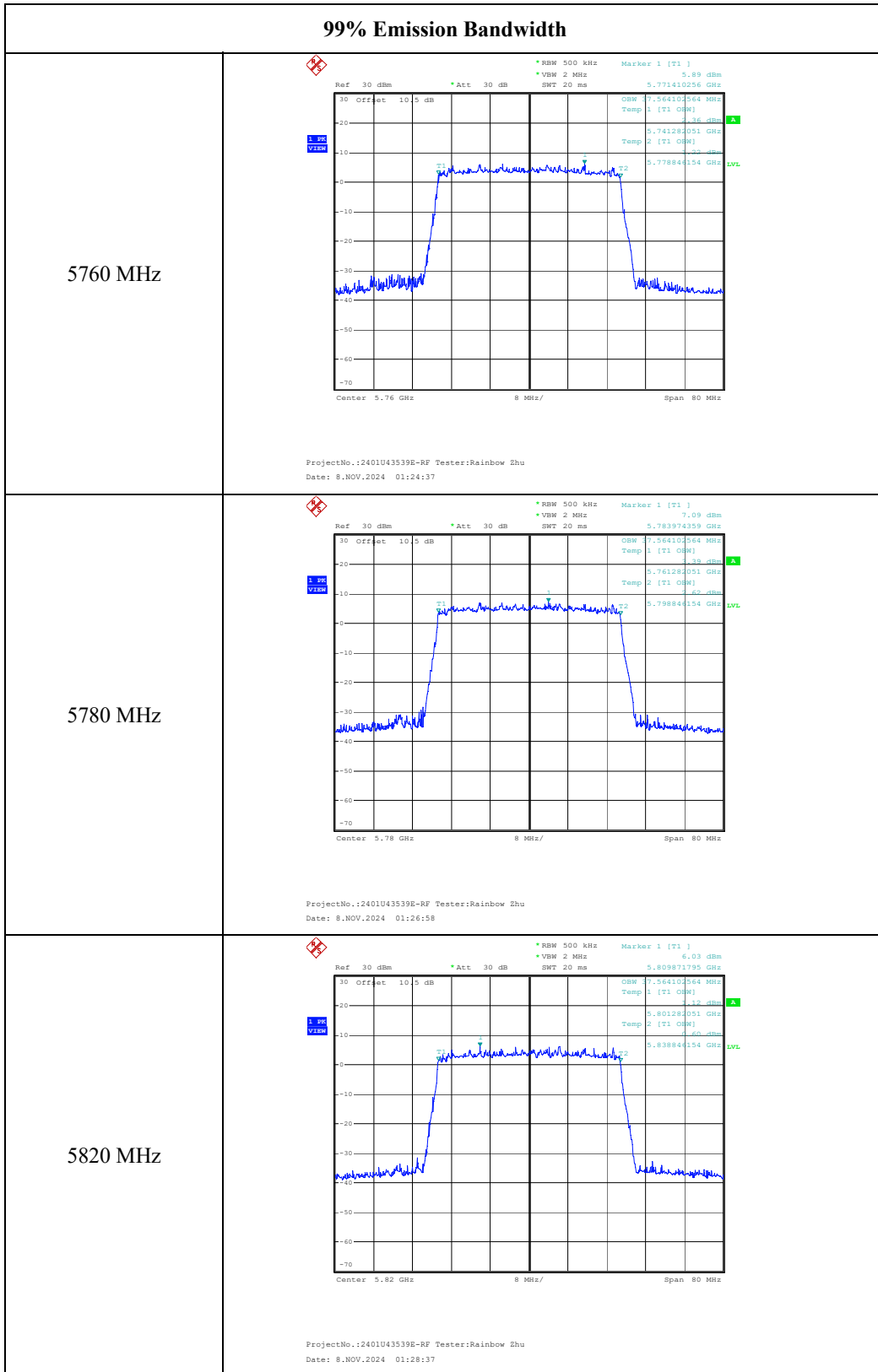



## FCC §15.407(a) - CONDUCTED TRANSMITTER OUTPUT POWER

### Applicable Standard

For an indoor access point operating in the band 5.15-5.25 GHz, the maximum conducted output power over the frequency band of operation shall not exceed 1 W provided the maximum antenna gain does not exceed 6 dBi. In addition, the maximum power spectral density shall not exceed 17 dBm in any 1 megahertz band. If transmitting antennas of directional gain greater than 6 dBi are used, both the maximum conducted output power and the maximum power spectral density shall be reduced by the amount in dB that the directional gain of the antenna exceeds 6 dBi.

For client devices in the 5.15-5.25 GHz band, the maximum conducted output power over the frequency band of operation shall not exceed 250 mW provided the maximum antenna gain does not exceed 6 dBi. In addition, the maximum power spectral density shall not exceed 11 dBm in any 1 megahertz band. If transmitting antennas of directional gain greater than 6 dBi are used, both the maximum conducted output power and the maximum power spectral density shall be reduced by the amount in dB that the directional gain of the antenna exceeds 6 dBi.

For the 5.25-5.35 GHz and 5.47-5.725 GHz bands, the maximum conducted output power over the frequency bands of operation shall not exceed the lesser of 250 mW or  $11 \text{ dBm} + 10 \log B$ , where B is the 26 dB emission bandwidth in megahertz. In addition, the maximum power spectral density shall not exceed 11 dBm in any 1 megahertz band. If transmitting antennas of directional gain greater than 6 dBi are used, both the maximum conducted output power and the maximum power spectral density shall be reduced by the amount in dB that the directional gain of the antenna exceeds 6 dBi.

For the band 5.725-5.85 GHz, the maximum conducted output power over the frequency band of operation shall not exceed 1 W. In addition, the maximum power spectral density shall not exceed 30 dBm in any 500-kHz band. If transmitting antennas of directional gain greater than 6 dBi are used, both the maximum conducted output power and the maximum power spectral density shall be reduced by the amount in dB that the directional gain of the antenna exceeds 6 dBi. However, fixed point-to-point U-NII devices operating in this band may employ transmitting antennas with directional gain greater than 6 dBi without any corresponding reduction in transmitter conducted power. Fixed, point-to-point operations exclude the use of point-to-multipoint systems, omnidirectional applications, and multiple collocated transmitters transmitting the same information. The operator of the U-NII device, or if the equipment is professionally installed, the installer, is responsible for ensuring that systems employing high gain directional antennas are used exclusively for fixed, point-to-point operations.

### Test Procedure

According to KDB 789033 D02 General UNII Test Procedures New Rules v02r01 Method PM-G should be applied

- a. Place the EUT on a bench and set it in transmitting mode.
- b. Remove the antenna from the EUT and then connect a low loss RF cable from the antenna port to one test equipment.

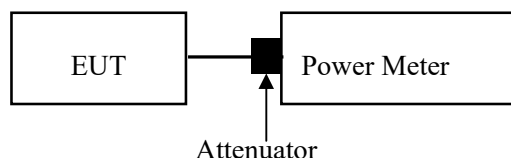

**Test Data**

**Environmental Conditions**

|                           |          |
|---------------------------|----------|
| <b>Temperature:</b>       | 23~28°C  |
| <b>Relative Humidity:</b> | 47 ~58 % |
| <b>ATM Pressure:</b>      | 101 kPa  |

The testing was performed by Rainbow Zhu from 2024-08-31 to 2024-09-09.

EUT operation mode: Transmitting

**Test Result: Compliant.**

**5150-5250 MHz:**

| Test Modes  | Test Frequency (MHz) | Max. Conducted Average Output Power (dBm) |                   |       |       |
|---|----------------------|---|-------------------|-------|-------|
|   |                      | Chain 0                                   | Chain 1           | Total | Limit |
| OFDM  | 5185                 | 8.66                                      | 8.16              | 11.43 | 21.53 |
|   | 5205                 | 8.72                                      | 8.08              | 11.42 | 21.53 |
|   | 5225                 | 9.02                                      | 8.49              | 11.77 | 21.53 |
| Note:   |                      |   |                   |       |       |
| 1. The device is a client unit.   |                      |   |                   |       |       |
| 2. The device employed Cyclic Delay Diversity (CDD) for MIMO transmitting, per KDB 662911 D01 Multiple Transmitter Output v02r01, for power measurements on the devices: Array Gain = 10 log(N <sub>ANT</sub> /N <sub>SS</sub> ) dB |                      |   |                   |       |       |
| Antenna Gain:   | 5.45                 | dBi                                       | Directional gain: | 8.45  | dBi   |

**5725-5850 MHz:**

| Test Modes   | Test Frequency (MHz) | Max. Conducted Average Output Power (dBm) |                   |       |       |
|--|----------------------|---|-------------------|-------|-------|
|  |                      | Chain 0                                   | Chain 1           | Total | Limit |
| OFDM   | 5760                 | 17.73                                     | 18.44             | 21.11 | 28.66 |
|  | 5780                 | 17.97                                     | 18.55             | 21.28 | 28.66 |
|  | 5820                 | 17.61                                     | 18.48             | 21.08 | 28.66 |
| Note: The device employed Cyclic Delay Diversity (CDD) for MIMO transmitting, per KDB 662911 D01 Multiple Transmitter Output v02r01, for power measurements on the devices: Array Gain = 10 log(N <sub>ANT</sub> /N <sub>SS</sub> ) dB |                      |   |                   |       |       |
| Antenna Gain:  | 4.34                 | dBi                                       | Directional gain: | 7.34  | dBi   |

## **FCC §15.407(a) - POWER SPECTRAL DENSITY**

For client devices in the 5.15-5.25 GHz band, the maximum conducted output power over the frequency band of operation shall not exceed 250 mW provided the maximum antenna gain does not exceed 6 dBi. In addition, the maximum power spectral density shall not exceed 11 dBm in any 1 megahertz band. If transmitting antennas of directional gain greater than 6 dBi are used, both the maximum conducted output power and the maximum power spectral density shall be reduced by the amount in dB that the directional gain of the antenna exceeds 6 dBi.

For the 5.25-5.35 GHz and 5.47-5.725 GHz bands, the maximum conducted output power over the frequency bands of operation shall not exceed the lesser of 250 mW or  $11 \text{ dBm} + 10 \log B$ , where B is the 26 dB emission bandwidth in megahertz. In addition, the maximum power spectral density shall not exceed 11 dBm in any 1 megahertz band. If transmitting antennas of directional gain greater than 6 dBi are used, both the maximum conducted output power and the maximum power spectral density shall be reduced by the amount in dB that the directional gain of the antenna exceeds 6 dBi.

For the band 5.725-5.85 GHz, the maximum conducted output power over the frequency band of operation shall not exceed 1 W. In addition, the maximum power spectral density shall not exceed 30 dBm in any 500-kHz band. If transmitting antennas of directional gain greater than 6 dBi are used, both the maximum conducted output power and the maximum power spectral density shall be reduced by the amount in dB that the directional gain of the antenna exceeds 6 dBi. However, fixed point-to-point U-NII devices operating in this band may employ transmitting antennas with directional gain greater than 6 dBi without any corresponding reduction in transmitter conducted power. Fixed, point-to-point operations exclude the use of point-to-multipoint systems, omnidirectional applications, and multiple collocated transmitters transmitting the same information. The operator of the U-NII device, or if the equipment is professionally installed, the installer, is responsible for ensuring that systems employing high gain directional antennas are used exclusively for fixed, point-to-point operations.

### **Test Procedure**

According to KDB 789033 D02 General UNII Test Procedures New Rules v02r01

Duty cycle  $\geq 98\%$

KDB 789033 D02 General UNII Test Procedures New Rules v02r01 Method SA-1 should be applied.

Duty cycle  $< 98\%$ , duty cycle variations are less than  $\pm 2\%$

KDB 789033 D02 General UNII Test Procedures New Rules v02r01 Method SA-2 should be applied.

Duty cycle  $< 98\%$ , duty cycle variations exceed  $\pm 2\%$

KDB 789033 D02 General UNII Test Procedures New Rules v02r01 Method SA-3 should be applied.

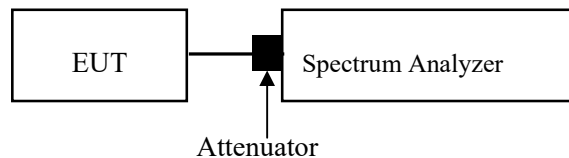

**Test Data**

**Environmental Conditions**

|                           |          |
|---------------------------|----------|
| <b>Temperature:</b>       | 23~28°C  |
| <b>Relative Humidity:</b> | 47 ~58 % |
| <b>ATM Pressure:</b>      | 101 kPa  |

The testing was performed by Rainbow Zhu from 2024-08-31 to 2024-10-28.

EUT operation mode: Transmitting

**Test Result: Compliant.**

**5150-5250 MHz:**

| Test Modes  | Test Frequency (MHz) | Reading (dBm/MHz) |         |                   | Duty Cycle Factor (dB) | Maximum Power Spectral Density (dBm/MHz) |       |
|---|----------------------|-------------------|---------|-------------------|------------------------|--|-------|
|   |                      | Chain 0           | Chain 1 | Total             |                        | Result                                   | Limit |
| OFDM  | 5185                 | -6.19             | -6.19   | -3.18             | 1.14                   | -2.04                                    | 8.55  |
|   | 5205                 | -6.67             | -6.33   | -3.49             | 1.14                   | -2.35                                    | 8.55  |
|   | 5225                 | -6.22             | -5.46   | -2.81             | 1.14                   | -1.67                                    | 8.55  |
| Note:<br>1. The device is a client unit.<br>2. The device employed Cyclic Delay Diversity (CDD) for MIMO transmitting, per KDB 662911 D01 Multiple Transmitter Output v02r01, for power spectral density (PSD) measurements on the devices:<br>Array Gain = $10 \log(N_{ANT}/N_{SS})$ dB<br>3. Method SA-2 in KDB 789033 D02 General UNII Test Procedures New Rules v02r01 was used for PSD test.<br>4. PSD = Total + Duty Cycle Factor |                      |                   |         |                   |                        |  |       |
| Antenna Gain:   | 5.45                 |                   | dBi     | Directional Gain: | 8.45                   |  | dBi   |

**5725-5850 MHz:**

| Test Modes   | Test Frequency (MHz) | Reading (dBm/500kHz) |         |                   | Duty Cycle Factor (dB) | Maximum Power Spectral Density (dBm/500kHz) |       |
|--|----------------------|----------------------|---------|-------------------|------------------------|---|-------|
|  |                      | Chain 0              | Chain 1 | Total             |                        | Result                                      | Limit |
| OFDM   | 5760                 | 0.27                 | -0.11   | 3.09              | 0.98                   | 4.07  | 28.66 |
|  | 5780                 | 0.48                 | 0.06    | 3.29              | 0.98                   | 4.27  | 28.66 |
|  | 5820                 | 0.17                 | 0.07    | 3.13              | 0.98                   | 4.11  | 28.66 |
| Note:<br>1. The device employed Cyclic Delay Diversity (CDD) for MIMO transmitting, per KDB 662911 D01 Multiple Transmitter Output v02r01, for power spectral density (PSD) measurements on the devices:<br>Array Gain = $10 \log(N_{ANT}/N_{SS})$ dB<br>2. Method SA-2 in KDB 789033 D02 General UNII Test Procedures New Rules v02r01 was used for PSD test.<br>3. PSD = Total + Duty Cycle Factor |                      |                      |         |                   |                        |   |       |
| Antenna Gain:  | 4.34                 |                      | dBi     | Directional gain: | 7.34                   |   | dBi   |

5150-5250 MHz:  
Chain 0

| Maximum Power Spectral Density |   |
|--------------------------------|---|
| 5185 MHz                       | <p>ProjectNo.: 2401U43539E-RF Tester:Rainbow Zhu<br/>Date: 28.OCT.2024 18:06:00</p> |
| 5205 MHz                       | <p>ProjectNo.: 2401U43539E-RF Tester:Rainbow Zhu<br/>Date: 28.OCT.2024 18:06:35</p> |
| 5225 MHz                       | <p>ProjectNo.: 2401U43539E-RF Tester:Rainbow Zhu<br/>Date: 28.OCT.2024 18:07:05</p> |

Chain 1

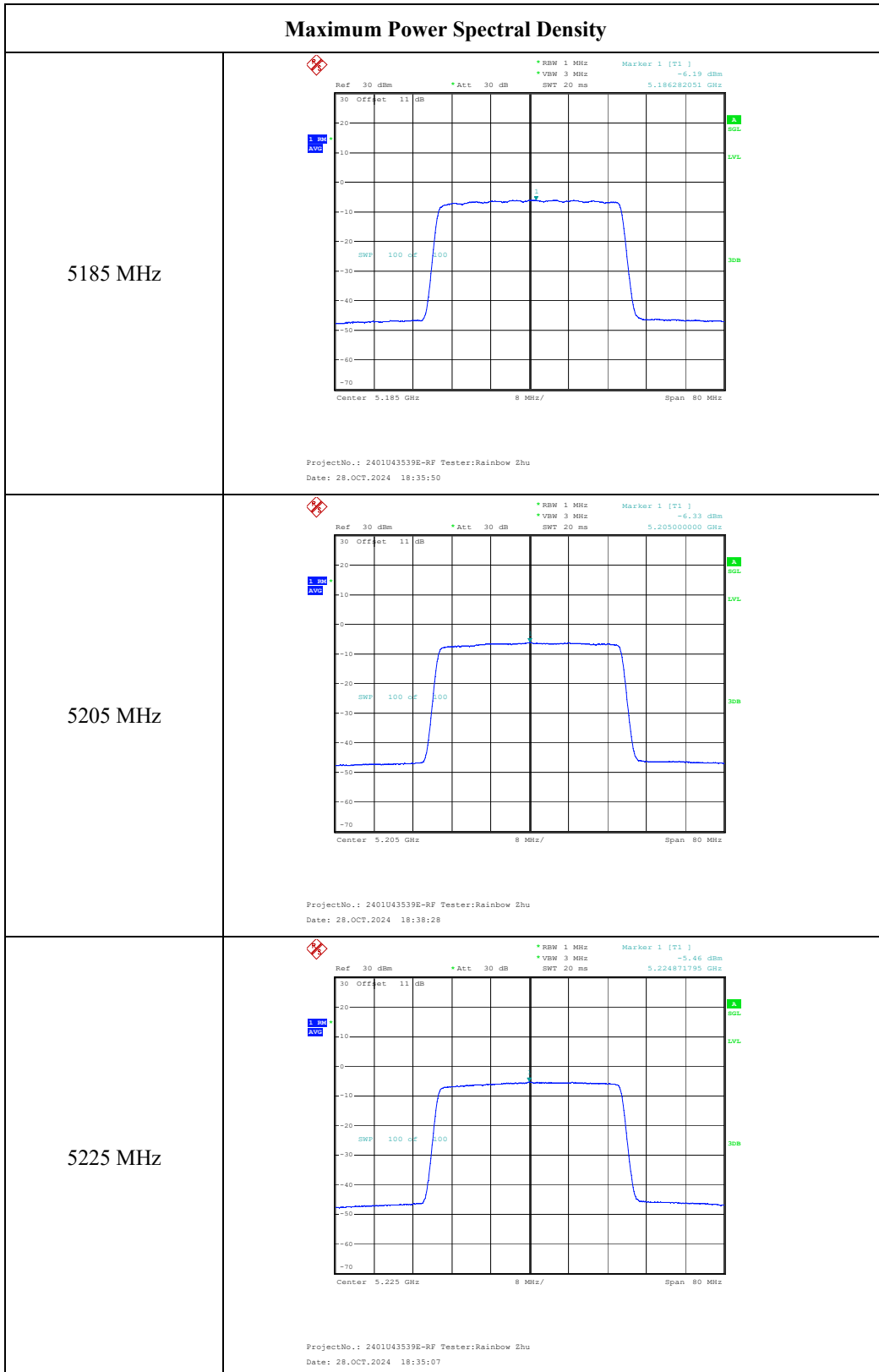

5725-5850 MHz:  
Chain 0

| Maximum Power Spectral Density |  |
|--------------------------------|--|
| 5760 MHz                       | <p>ProjectNo.:2401U43539E-RF Tester:Rainbow Zhu<br/>Date: 31.AUG.2024 19:13:29</p> |
| 5780 MHz                       | <p>ProjectNo.:2401U43539E-RF Tester:Rainbow Zhu<br/>Date: 31.AUG.2024 19:14:06</p> |
| 5820 MHz                       | <p>ProjectNo.:2401U43539E-RF Tester:Rainbow Zhu<br/>Date: 31.AUG.2024 19:14:38</p> |

Chain 1

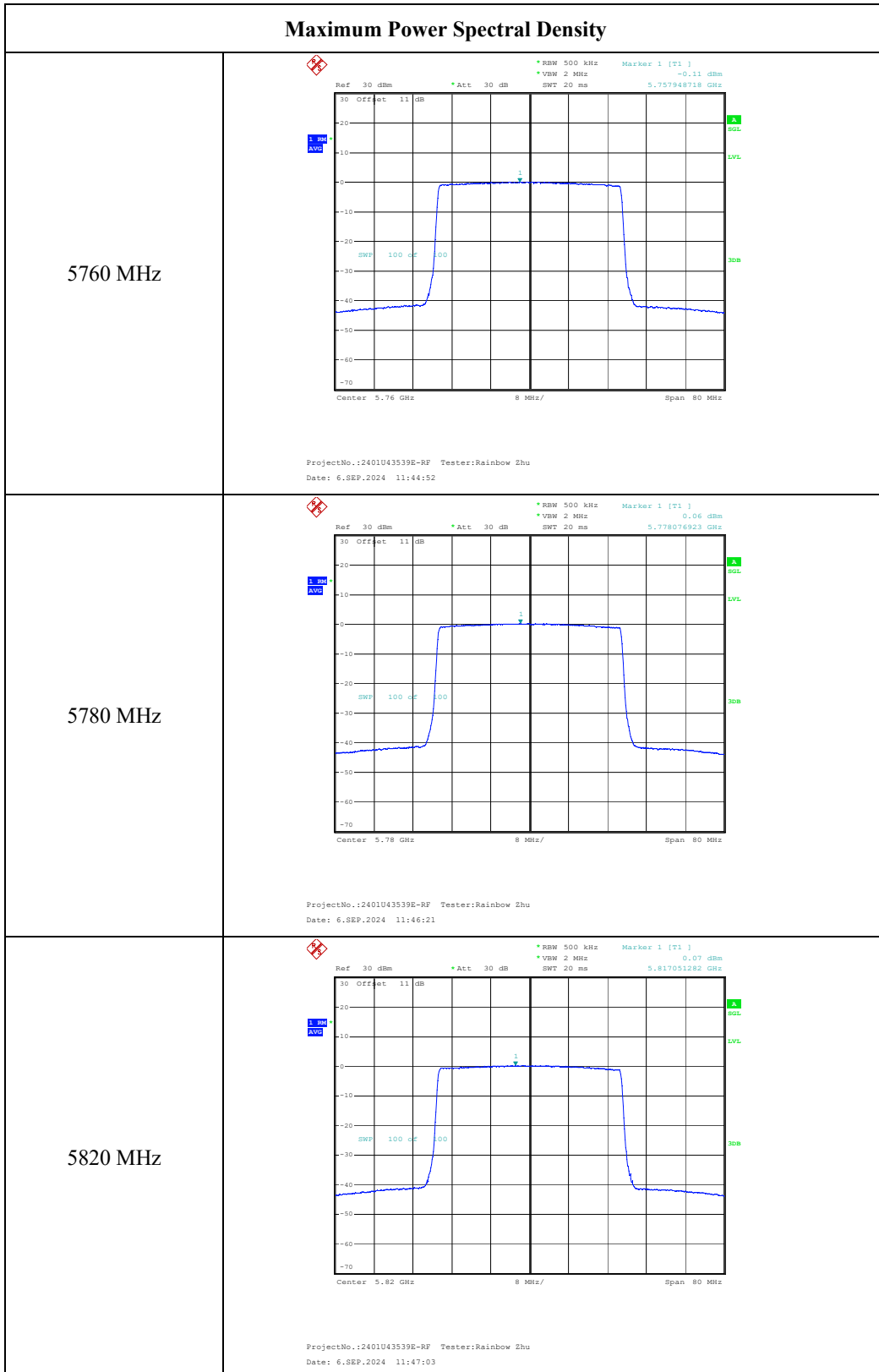



---

## **EUT PHOTOGRAPHS**

---

Please refer to the attachment 2401U43539E-RF External photo and 2401U43539E-RF Internal photo.

---

## **TEST SETUP PHOTOGRAPHS**

---

Please refer to the attachment 2401U43539E-RF Test Setup photo.

**\*\*\*\*\* END OF REPORT \*\*\*\*\***