

# TEST REPORT

Applicant Name : Shenzhen Hollyland Technology Co.,Ltd  
 Address : 8F,Building 5D,Skyworth Innovation Valley, Tangtou Road,Shiyan Street, Baoan District Shenzhen, China  
 Report Number : RA221110-53094E-SAB  
 FCC ID: 2ADZC-5803P

**Test Standard (s)**

FCC 47 CFR part 2.1093

**Sample Description**

Product Type: FULL-DUPLEX WIRELESS INTERCOM SYSTEM  
 Model No.: Solidcom C1 Pro  
 Multiple Model(s) No.: N/A  
 Trade Mark: HOLLYLAND  
 Date Received: 2022/11/14  
 Report Date: 2022/12/05

Test Result:	Pass*
--------------	-------

\* In the configuration tested, the EUT complied with the standards above.

**Prepared and Checked By:**

*Lance Li*

\_\_\_\_\_  
 Lance Li  
 EMC Engineer

**Approved By:**

*Candy Li*

\_\_\_\_\_  
 Candy Li  
 EMC Engineer

Note: This report may contain data that are not covered by the A2LA accreditation and are marked with an asterisk “\* ”.  
 Shenzhen Accurate Technology Co., Ltd. is not responsible for the authenticity of any test data provided by the applicant. Data included from the applicant that may affect test results are marked with an asterisk “\*”. Customer model name, addresses, names, trademarks etc. are not considered data.  
 This report cannot be reproduced except in full, without prior written approval of the Company. Unless otherwise stated the results shown in this test report refer only to the sample(s) tested. This report is valid only with a valid digital signature. The digital signature may be available only under the Adobe software above version 7.0.

<b>Attestation of Test Results</b>			
<b>MODE</b>		<b>Max. SAR Level(s) Reported(W/kg)</b>	<b>Limit (W/kg)</b>
<b>DECT</b>	1g Head SAR	0.04	<b>1.6</b>
<b>Applicable Standards</b>	<b>FCC 47 CFR part 2.1093</b> Radiofrequency radiation exposure evaluation: portable devices		
	<b>RF Exposure Procedures: TCB Workshop April 2019</b>		
	<b>IEEE 1528:2013</b> IEEE Recommended Practice for Determining the Peak Spatial-Average Specific Absorption Rate (SAR) in the Human Head from Wireless Communications Devices: Measurement Techniques		
	<b>IEC 62209-1:2016</b> Measurement procedure for the assessment of specific absorption rate of human exposure to radio frequency fields from hand-held and body-mounted wireless communication devices – Part 1: Devices used next to the ear (Frequency range of 300 MHz to 6 GHz)		
	<b>KDB procedures</b> KDB 447498 D04 Interim General RF Exposure Guidance v01 KDB 648474 D04 Handset SAR v01r03. KDB 865664 D01 SAR measurement 100 MHz to 6 GHz v01r04 KDB 865664 D02 RF Exposure Reporting v01r02		
<b>Note:</b> This wireless device has been shown to be capable of compliance for localized specific absorption rate (SAR) for General Population/Uncontrolled Exposure limits specified in <b>FCC 47 CFR part 2.1093</b> and has been tested in accordance with the measurement procedures specified in IEEE 1528-2013 and RF exposure KDB procedures. <b>The results and statements contained in this report pertain only to the device(s) evaluated.</b>			

## TABLE OF CONTENTS

<b>DOCUMENT REVISION HISTORY</b> .....	<b>4</b>
<b>EUT DESCRIPTION</b> .....	<b>5</b>
TECHNICAL SPECIFICATION .....	5
<b>REFERENCE, STANDARDS, AND GUIDELINES</b> .....	<b>6</b>
SAR LIMITS.....	7
<b>FACILITIES</b> .....	<b>8</b>
<b>DESCRIPTION OF TEST SYSTEM</b> .....	<b>9</b>
<b>EQUIPMENT LIST AND CALIBRATION</b> .....	<b>15</b>
EQUIPMENTS LIST & CALIBRATION INFORMATION.....	15
<b>SAR MEASUREMENT SYSTEM VERIFICATION</b> .....	<b>16</b>
LIQUID VERIFICATION .....	16
SYSTEM ACCURACY VERIFICATION.....	17
SAR SYSTEM VALIDATION DATA.....	18
<b>EUT TEST STRATEGY AND METHODOLOGY</b> .....	<b>19</b>
TEST POSITIONS FOR DEVICE OPERATING NEXT TO A PERSON’S EAR .....	19
CHEEK/TOUCH POSITION .....	20
EAR/TILT POSITION .....	20
SAR EVALUATION PROCEDURE .....	22
<b>CONDUCTED OUTPUT POWER MEASUREMENT</b> .....	<b>23</b>
MAXIMUM TARGET OUTPUT POWER .....	23
TEST RESULTS:.....	23
ANTENNA DISTANCE TO EDGE.....	24
STANDALONE SAR TEST EXCLUSION CONSIDERATIONS(KDB) .....	25
SAR TEST FOR THE EUT EDGE CONSIDERATIONS RESULT.....	26
<b>SAR MEASUREMENT RESULTS</b> .....	<b>27</b>
SAR TEST DATA .....	27
<b>SAR PLOTS</b> .....	<b>28</b>
<b>APPENDIX A MEASUREMENT UNCERTAINTY</b> .....	<b>32</b>
<b>APPENDIX B EUT TEST POSITION PHOTOS</b> .....	<b>34</b>
LIQUID DEPTH $\geq$ 15CM .....	34
HEAD-TOUCH (LEFT) SETUP PHOTO .....	35
HEAD-TOUCH (RIGHT) SETUP PHOTO .....	35
<b>APPENDIX C PROBE CALIBRATION CERTIFICATES</b> .....	<b>36</b>
<b>APPENDIX D DIPOLE CALIBRATION CERTIFICATES</b> .....	<b>45</b>

## DOCUMENT REVISION HISTORY

---

Revision Number	Report Number	Description of Revision	Date of Revision
0	RA221110-53094E-SAB	Original Report	2022-12-05

## EUT DESCRIPTION

---

This report has been prepared on behalf of **Shenzhen Hollyland Technology Co.,Ltd** and their product **FULL-DUPLEX WIRELESS INTERCOM SYSTEM**, Model: **Solidcom C1 Pro**, FCC ID: **2ADZC-5803P** or the EUT (Equipment under Test) as referred to in the rest of this report.

*\*All measurement and test data in this report was gathered from production sample serial number: 1PZR-8 (Assigned by ATC, Shenzhen). The EUT supplied by the applicant was received on 2022-11-14.*

### Technical Specification

<b>Sample serial number:</b>	1PZR-8 (Assigned by ATC, Shenzhen)
<b>Product Type:</b>	Portable
<b>Exposure Category:</b>	Population / Uncontrolled
<b>Antenna Type(s):</b>	Internal Antenna
<b>Body-Worn Accessories:</b>	None
<b>Modulation:</b>	DECT: GFSK
<b>Frequency Band:</b>	DECT: 1921.536-1928.448 MHz;
<b>Power Source:</b>	Rechargeable Battery
<b>Normal Operation:</b>	Head

## REFERENCE, STANDARDS, AND GUIDELINES

---

### FCC:

The Report and Order requires routine SAR evaluation prior to equipment authorization of portable transmitter devices, including portable telephones. For consumer products, the applicable limit is 1.6 mW/g as recommended by the ANSI/IEEE standard C95.1-1992 [6] for an uncontrolled environment (Paragraph 65). According to the Supplement C of OET Bulletin 65 "Evaluating Compliance with FCC Guide-lines for Human Exposure to Radio frequency Electromagnetic Fields", released on Jun 29, 2001 by the FCC, the device should be evaluated at maximum output power (radiated from the antenna) under "worst-case" conditions for normal or intended use, incorporating normal antenna operating positions, device peak performance frequencies and positions for maximum RF energy coupling.

This report describes the methodology and results of experiments performed on wireless data terminal. The objective was to determine if there is RF radiation and if radiation is found, what is the extent of radiation with respect to safety limits. SAR (Specific Absorption Rate) is the measure of RF exposure determined by the amount of RF energy absorbed by human body (or its parts) – to determine how the RF energy couples to the body or head which is a primary health concern for body worn devices. The limit below which the exposure to RF is considered safe by regulatory bodies in North America is 1.6 mW/g average over 1 gram of tissue mass.

**SAR Limits****FCC Limit(1g Tissue)**

EXPOSURE LIMITS	SAR (W/kg)	
	(General Population / Uncontrolled Exposure Environment)	(Occupational / Controlled Exposure Environment)
Spatial Average (averaged over the whole body)	0.08	0.4
Spatial Peak (averaged over any 1 g of tissue)	<b>1.60</b>	8.0
Spatial Peak (hands/wrists/feet/ankles averaged over 10 g)	4.0	20.0

Population/Uncontrolled Environments are defined as locations where there is the exposure of individual who have no knowledge or control of their exposure.

Occupational/Controlled Environments are defined as locations where there is exposure that may be incurred by people who are aware of the potential for exposure (i.e. as a result of employment or occupation).

General Population/Uncontrolled environments Spatial Peak limit 1.6W/kg (FCC) applied to the EUT.

## **FACILITIES**

---

The test site used by Shenzhen Accurate Technology Co., Ltd. to collect test data is located on the 1/F., Building A, Changyuan New Material Port, Science & Industry Park, Nanshan District, Shenzhen, Guangdong, P.R. China.

The test site has been approved by the FCC under the KDB 974614 D01 and is listed in the FCC Public Access Link (PAL) database, FCC Registration No.: 708358, the FCC Designation No.: CN1189. Accredited by American Association for Laboratory Accreditation (A2LA) The Certificate Number is 4297.01

Listed by Innovation, Science and Economic Development Canada (ISED), the Registration Number is 5077A.

The test site has been registered with ISED Canada under ISED Canada Registration Number CN0016.



## DESCRIPTION OF TEST SYSTEM

These measurements were performed with the automated near-field scanning system DASY5 from Schmid & Partner Engineering AG (SPEAG) which is the Fifth generation of the system shown in the figure hereinafter:



### DASY5 System Description

The DASY5 system for performing compliance tests consists of the following items:

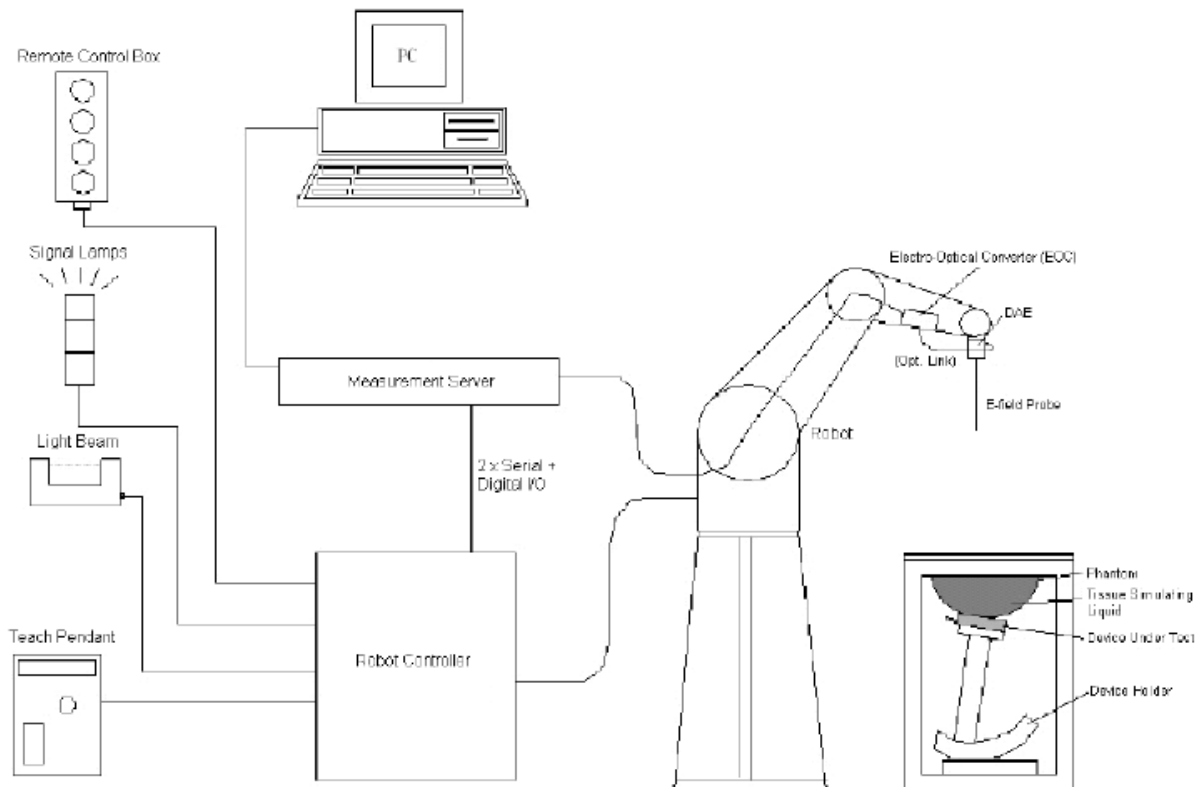

- A standard high precision 6-axis robot (Staubli TX=RX family) with controller, teach pendant and software. An arm extension for accommodating the data acquisition electronics (DAE).
- An isotropic field probe optimized and calibrated for the targeted measurement.
- A data acquisition electronics (DAE) which performs the signal application, signal multiplexing, AD-conversion, offset measurements, mechanical surface detection, collision detection, etc. The unit is battery powered with standard or rechargeable batteries. The signal is optically transmitted to the EOC.
- The Electro-optical converter (EOC) performs the conversion from optical to electrical signals for the digital communication to the DAE. To use optical surface detection, a special version of the EOC is required. The EOC signal is transmitted to the measurement server.
- The function of the measurement server is to perform the time critical tasks such as signal filtering, control of the robot operation and fast movement interrupts.
- The Light Beam used is for probe alignment. This improves the (absolute) accuracy of the probe positioning.
- A computer running Win7 professional operating system and the DASY52 software.
- Remote control and teach pendant as well as additional circuitry for robot safety such as warning lamps, etc.
- The phantom, the device holder and other accessories according to the targeted measurement.

### **DASY5 Measurement Server**

The DASY5 measurement server is based on a PC/104 CPU board with a 400 MHz Intel ULV Celeron, 128 MB chip-disk and 128 MB RAM. The necessary circuits for communication with the DAE4 (or DAE3) electronics box, as well as the 16-bit AD converter system for optical detection and digital I/O interface are contained on the DASY6 I/O board, which is directly connected to the PC/104 bus of the CPU board.

The measurement server performs all real-time data evaluations of field measurements and surface detection, controls robot movements, and handles safety operations. The PC operating system cannot interfere with these time-critical processes. All connections are supervised by a watchdog, and disconnection of any of the cables to the measurement server will automatically disarm the robot and disable all program- controlled robot movements. Furthermore, the measurement server is equipped with an expansion port, which is reserved for future applications. Please note that this expansion port does not have a standardized pinout, and therefore only devices provided by SPEAG can be connected. Connection of devices from any other supplier could seriously damage the measurement server.

### **Data Acquisition Electronics**

The data acquisition electronics (DAE4) consist of a highly sensitive electrometer-grade preamplifier with auto-zeroing, a channel and gain-switching multiplexer, a fast 16 bit AD-converter and a command decoder with a control logic unit. Transmission to the measurement server is accomplished through an optical downlink for data and status information, as well as an optical uplink for commands and the clock.

The mechanical probe mounting device includes two different sensor systems for frontal and sideways probe contacts. They are used for mechanical surface detection and probe collision detection.

The input impedance of both the DAE4 as well as of the DAE3 box is 200M $\Omega$ ; the inputs are symmetrical and floating. Common mode rejection is above 80 dB.

**EX3DV4 E-Field Probes**

<b>Frequency</b>	10 MHz to > 6 GHz Linearity: $\pm 0.2$ dB (30 MHz to 6 GHz)
<b>Directivity</b>	$\pm 0.3$ dB in TSL (rotation around probe axis) $\pm 0.5$ dB in TSL (rotation normal to probe axis)
<b>Dynamic Range</b>	10 $\mu$ W/g to > 100 mW/g Linearity: $\pm 0.2$ dB (noise: typically < 1 $\mu$ W/g)
<b>Dimensions</b>	Overall length: 337 mm (Tip: 20 mm) Tip diameter: 2.5 mm (Body: 12 mm) Typical distance from probe tip to dipole centers: 1 mm
<b>Application</b>	High precision dosimetric measurements in any exposure scenario (e.g., very strong gradient fields); the only probe that enables compliance testing for frequencies up to 6 GHz with precision of better 30%.
<b>Compatibility</b>	DASY3, DASY4, DASY52 SAR and higher, EASY4/MRI

**SAM Twin Phantom**

The SAM Twin Phantom (shown in front of DASY5) is a fiberglass shell phantom with shell thickness 2 mm, except in the ear region where the thickness is increased to 6 mm..

When the phantom is mounted inside allocated slot of the DASY5 platform, phantom reference points can be taught directly in the DASY5 V5.2 software. When the DASY5 platform is used to mount the

Phantom, some of the phantom teaching points cannot be reached by the robot in DASY5 V5.2. A special tool called P1a-P2aX-Former is provided to transform two of the three points, P1 and P2, to reachable locations. To use these new teaching points, a revised phantom configuration file is required.

In addition to our standard broadband liquids, the phantom can be used with the following tissue simulating liquids:

Sugar-water-based liquids can be left permanently in the phantom.

Always cover the liquid when the system is not in use to prevent changes in liquid parameters due to water evaporation.

DGBE-based liquids should be used with care. As DGBE is a softener for most plastics, the liquid should be taken out of the phantom, and the phantom should be dried when the system is not in use (desirable at least once a week).

Do not use other organic solvents without previously testing the solvent resistivity of the phantom. Approximately 25 liters of liquid is required to fill the SAM Twin phantom.



**Calibration Frequency Points for EX3DV4 E-Field Probes SN: 7441 Calibrated: 2022/05/16**

Calibration Frequency Point(MHz)	Frequency Range(MHz)		Conversion Factor		
	From	To	X	Y	Z
750 Head	650	850	10.04	10.04	10.04
900 Head	850	1000	9.61	9.61	9.61
1450 Head	1350	1550	8.52	8.52	8.52
1750 Head	1650	1850	8.32	8.32	8.32
1900 Head	1850	1950	7.94	7.94	7.94
2000 Head	1950	2100	7.99	7.99	7.99
2300 Head	2200	2400	7.78	7.78	7.78
2450 Head	2400	2550	7.54	7.54	7.54
2600 Head	2550	2700	7.30	7.30	7.30
5250 Head	5140	5360	5.35	5.35	5.35
5600 Head	5490	5700	4.85	4.85	4.85
5750 Head	5700	5860	4.83	4.83	4.83

## Area Scans

	$\leq 3$ GHz	$> 3$ GHz
Maximum distance from closest measurement point (geometric center of probe sensors) to phantom surface	5 mm $\pm$ 1 mm	$\frac{1}{2} \cdot \delta \cdot \ln(2)$ mm $\pm$ 0.5 mm
Maximum probe angle from probe axis to phantom surface normal at the measurement location	$30^\circ \pm 1^\circ$	$20^\circ \pm 1^\circ$
Maximum area scan spatial resolution: $\Delta x_{Area}$ , $\Delta y_{Area}$	$\leq 2$ GHz: $\leq 15$ mm 2 – 3 GHz: $\leq 12$ mm	3 – 4 GHz: $\leq 12$ mm 4 – 6 GHz: $\leq 10$ mm
	When the x or y dimension of the test device, in the measurement plane orientation, is smaller than the above, the measurement resolution must be $\leq$ the corresponding x or y dimension of the test device with at least one measurement point on the test device.	

## Zoom Scan (Cube Scan Averaging)

Maximum zoom scan spatial resolution: $\Delta x_{Zoom}$ , $\Delta y_{Zoom}$		$\leq 2$ GHz: $\leq 8$ mm 2 – 3 GHz: $\leq 5$ mm*	3 – 4 GHz: $\leq 5$ mm* 4 – 6 GHz: $\leq 4$ mm*	
Maximum zoom scan spatial resolution, normal to phantom surface	uniform grid: $\Delta z_{Zoom}(n)$	$\leq 5$ mm	3 – 4 GHz: $\leq 4$ mm 4 – 5 GHz: $\leq 3$ mm 5 – 6 GHz: $\leq 2$ mm	
	graded grid	$\Delta z_{Zoom}(1)$ : between 1 <sup>st</sup> two points closest to phantom surface	$\leq 4$ mm	3 – 4 GHz: $\leq 3$ mm 4 – 5 GHz: $\leq 2.5$ mm 5 – 6 GHz: $\leq 2$ mm
		$\Delta z_{Zoom}(n>1)$ : between subsequent points	$\leq 1.5 \cdot \Delta z_{Zoom}(n-1)$ mm	
Minimum zoom scan volume	x, y, z	$\geq 30$ mm	3 – 4 GHz: $\geq 28$ mm 4 – 5 GHz: $\geq 25$ mm 5 – 6 GHz: $\geq 22$ mm	
<p>Note: <math>\delta</math> is the penetration depth of a plane-wave at normal incidence to the tissue medium; see IEEE Std 1528-2013 for details.</p> <p>* When zoom scan is required and the <i>reported</i> SAR from the <i>area scan based 1-g SAR estimation</i> procedures of KDB Publication 447498 is <math>\leq 1.4</math> W/kg, <math>\leq 8</math> mm, <math>\leq 7</math> mm and <math>\leq 5</math> mm zoom scan resolution may be applied, respectively, for 2 GHz to 3 GHz, 3 GHz to 4 GHz and 4 GHz to 6 GHz.</p>				

## Tissue Dielectric Parameters for Head and Body Phantoms

The head tissue dielectric parameters recommended by the IEC 62209-1:2016

### Recommended Tissue Dielectric Parameters for Head

**Table A.3 – Dielectric properties of the head tissue-equivalent liquid**

Frequency MHz	Relative permittivity $\epsilon_r$	Conductivity ( $\sigma$ ) S/m
300	45,3	0,87
450	43,5	0,87
<i>750</i>	<i>41,9</i>	<i>0,89</i>
835	41,5	0,90
900	41,5	0,97
1 450	40,5	1,20
<i>1 500</i>	<i>40,4</i>	<i>1,23</i>
<i>1 640</i>	<i>40,2</i>	<i>1,31</i>
<i>1 750</i>	<i>40,1</i>	<i>1,37</i>
1 800	40,0	1,40
1 900	40,0	1,40
2 000	40,0	1,40
<i>2 100</i>	<i>39,8</i>	<i>1,49</i>
<i>2 300</i>	<i>39,5</i>	<i>1,67</i>
2 450	39,2	1,80
<i>2 600</i>	<i>39,0</i>	<i>1,96</i>
3 000	38,5	2,40
<i>3 500</i>	<i>37,9</i>	<i>2,91</i>
<i>4 000</i>	<i>37,4</i>	<i>3,43</i>
<i>4 500</i>	<i>36,8</i>	<i>3,94</i>
<i>5 000</i>	<i>36,2</i>	<i>4,45</i>
<i>5 200</i>	<i>36,0</i>	<i>4,66</i>
<i>5 400</i>	<i>35,8</i>	<i>4,86</i>
<i>5 600</i>	<i>35,5</i>	<i>5,07</i>
<i>5 800</i>	<i>35,3</i>	<i>5,27</i>
6 000	35,1	5,48

NOTE For convenience, permittivity and conductivity values at those frequencies which are not part of the original data provided by Drossos et al. [33] or the extension to 5 800 MHz are provided (i.e. the values shown *in italics*). These values were linearly interpolated between the values in this table that are immediately above and below these values, except the values at 6 000 MHz that were linearly extrapolated from the values at 3 000 MHz and 5 800 MHz.

## EQUIPMENT LIST AND CALIBRATION

### Equipments List & Calibration Information

Equipment	Model	S/N	Calibration Date	Calibration Due Date
DASY5 Test Software	DASY52 52.10.4	N/A	NCR	NCR
DASY5 Measurement Server	DASY5 6.0.31	N/A	NCR	NCR
Data Acquisition Electronics	DAE4	1211	2022/03/01	2023/02/28
E-Field Probe	EX3DV4	7441	2022/05/16	2023/05/15
Mounting Device	MD4HHTV5	SD 000 H01 KA	NCR	NCR
SAM Twin Phantom	SAM-Twin V5.0	1744	NCR	NCR
Dipole, 1900MHz	D1900V2	5d231	2020/1/14	2023/1/13
Simulated Tissue Liquid Head(500-9500MHz)	HBBL600-10000V6	180622-2	Each Time	/
Network Analyzer	8753D	3410A08288	2022/07/05	2023/07/04
Dielectric Assessment Kit	DAK-3.5	1248	NCR	NCR
Signal Generator	SMB100A	108362	2021/12/23	2022/12/22
USB wideband power sensor	U2021XA	MY52350001	2021/12/23	2022/12/22
Power Amplifier	CBA 1G-070	T44328	2021/12/23	2022/12/22
Linear Power Amplifier	AS0860-40/45	1060913	2021/12/23	2022/12/22
Directional Coupler	4223-20	3.113.277	2021/12/23	2022/12/22
6dB Attenuator	8493B 6dB Attenuator	2708A 04769	2021/12/23	2022/12/22
Digital Radio Communication Tester	CMD60	830861/029	2021/12/23	2022/12/22

# SAR MEASUREMENT SYSTEM VERIFICATION

## Liquid Verification

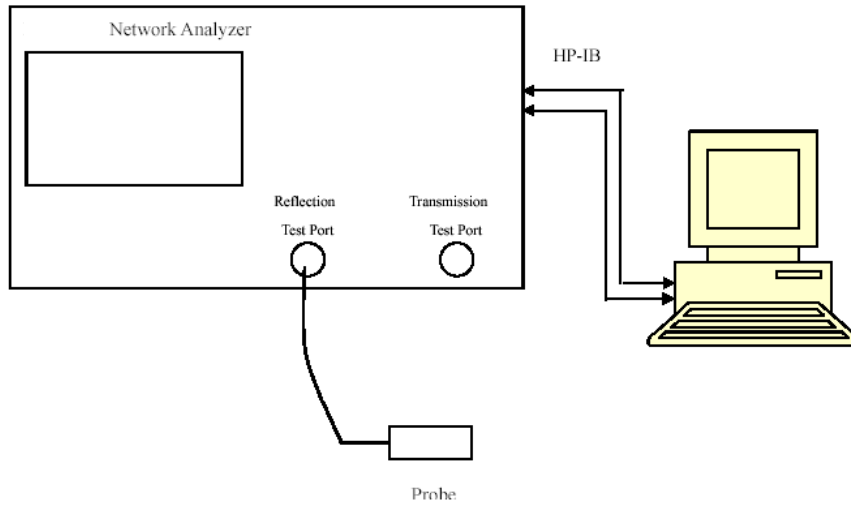

Liquid Verification Setup Block Diagram

## Liquid Verification Results

Frequency (MHz)	Liquid Type	Liquid Parameter		Target Value		Delta (%)		Tolerance (%)
		$\epsilon_r$	$\sigma$ (S/m)	$\epsilon_r$	$\sigma$ (S/m)	$\Delta\epsilon_r$	$\Delta\sigma$ (S/m)	
1900	Simulated Tissue Liquid Head	40.944	1.378	40.0	1.40	2.36	-1.57	$\pm 5$
1921.54	Simulated Tissue Liquid Head	40.078	1.406	40.0	1.40	0.2	0.43	$\pm 5$
1924.99	Simulated Tissue Liquid Head	40.297	1.391	40.0	1.40	0.74	-0.64	$\pm 5$
1928.45	Simulated Tissue Liquid Head	40.453	1.379	40.0	1.40	1.13	-1.5	$\pm 5$

\*Liquid Verification above was performed on 2022/11/21.



### System Accuracy Verification

Prior to the assessment, the system validation kit was used to test whether the system was operating within its specifications of  $\pm 10\%$ . The validation results are tabulated below. And also the corresponding SAR plot is attached as well in the SAR plots files.

The spacing distances in the **System Verification Setup Block Diagram** is given by the following:

- a)  $s = 15 \text{ mm} \pm 0,2 \text{ mm}$  for  $300 \text{ MHz} \leq f \leq 1 \text{ 000 MHz}$ ;
- b)  $s = 10 \text{ mm} \pm 0,2 \text{ mm}$  for  $1 \text{ 000 MHz} < f \leq 3 \text{ 000 MHz}$ ;
- c)  $s = 10 \text{ mm} \pm 0,2 \text{ mm}$  for  $3 \text{ 000 MHz} < f \leq 6 \text{ 000 MHz}$ .

### System Verification Setup Block Diagram

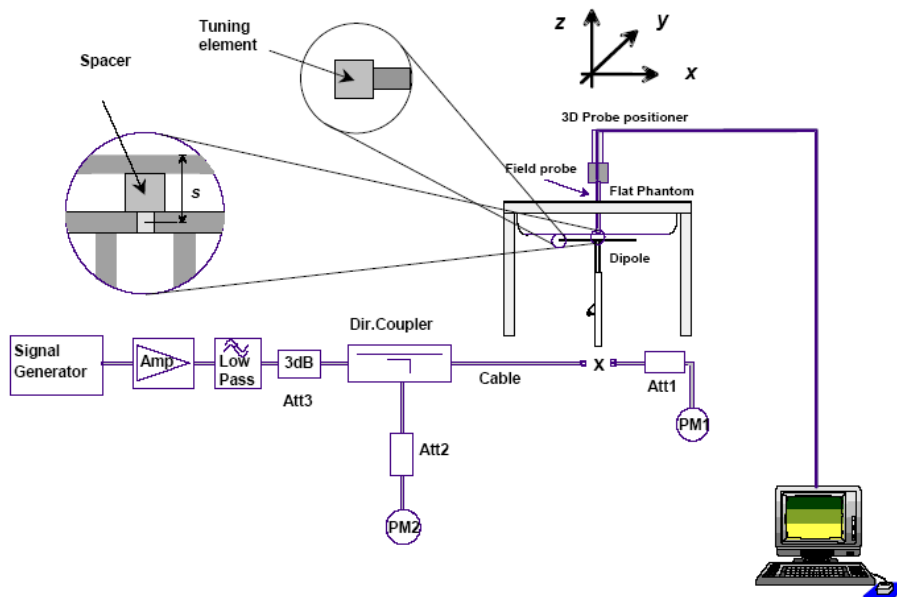

### System Accuracy Check Results

Date	Frequency Band (MHz)	Liquid Type	Input Power (mW)	Measured SAR (W/kg)	Normalized to 1W (W/kg)	Target Value (W/Kg)	Delta (%)	Tolerance (%)
2022/11/21	1900	Head	100	1g 4.21	42.1	40.3	4.467	$\pm 10$

\*The SAR values above are normalized to 1 Watt forward power.

## SAR SYSTEM VALIDATION DATA

### System Performance 1900MHz

**DUT: D1900V2; Type: 1900 MHz; Serial: 5d231**

Communication System: UID 0, CW (0); Frequency: 1900 MHz; Duty Cycle: 1:1

Medium parameters used:  $f = 1900$  MHz;  $\sigma = 1.378$  S/m;  $\epsilon_r = 40.944$ ;  $\rho = 1000$  kg/m<sup>3</sup>

Phantom section: Flat Section

DASY5 Configuration:

- Probe: EX3DV4 - SN7441; ConvF(7.94, 7.94, 7.94); Calibrated: 2022/05/16
- Sensor-Surface: 4mm (Mechanical Surface Detection)
- Electronics: DAE4 Sn1211; Calibrated: 2022/03/01
- Phantom: Twin SAM; Type: QD000P40CD; Serial: TP:1744
- Measurement SW: DASY52, Version 52.10 (4); SEMCAD X Version 14.6.14 (7501)

**System Performance Check at 1900MHz/d=10mm, Pin=100mw/Area Scan (71x111x1):** Measurement grid:

$dx=15$ mm,  $dy=15$ mm

Maximum value of SAR (interpolated) = 4.72 W/kg

**System Performance Check at 1900MHz/d=10mm, Pin=100mw/Zoom Scan (7x7x7)/Cube 0:** Measurement grid:

$dx=5$ mm,  $dy=5$ mm,  $dz=5$ mm

Reference Value = 51.46 V/m; Power Drift = 0.12 dB

Peak SAR (extrapolated) = 7.31 W/kg

**SAR(1 g) = 4.21 W/kg; SAR(10 g) = 2.14 W/kg**

Maximum value of SAR (measured) = 4.68 W/kg

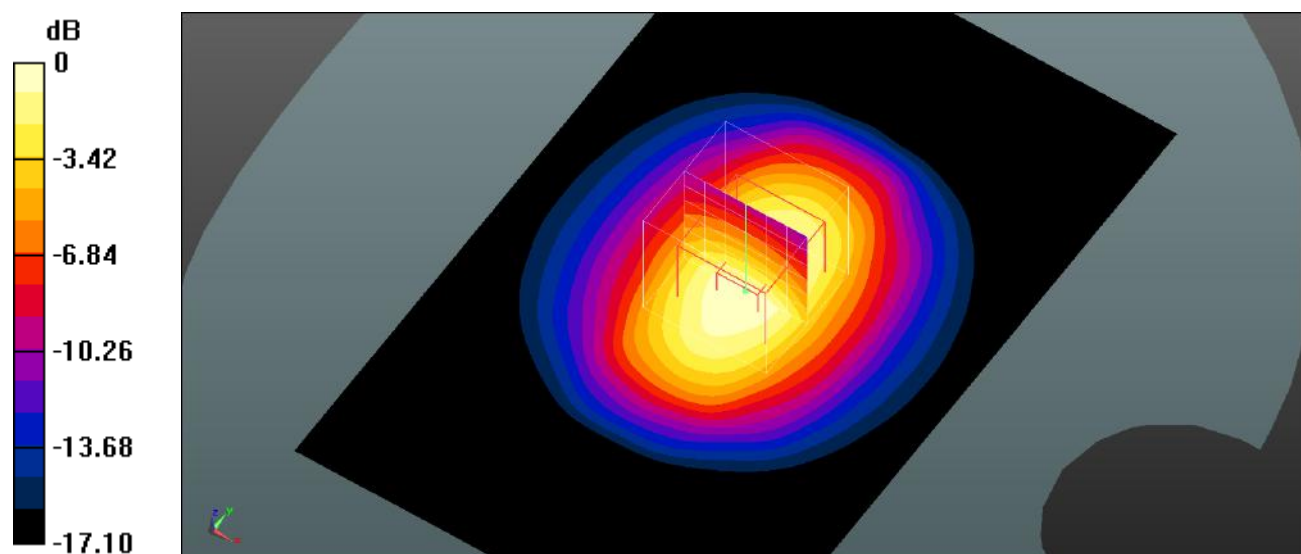

0 dB = 4.68 W/kg = 6.70 dBW/kg

## EUT TEST STRATEGY AND METHODOLOGY

### Test Positions for Device Operating Next to a Person’s Ear

This category includes most wireless handsets with fixed, retractable or internal antennas located toward the top half of the device, with or without a foldout, sliding or similar keypad cover. The handset should have its earpiece located within the upper ¼ of the device, either along the centerline or off-centered, as perceived by its users. This type of handset should be positioned in a normal operating position with the “test device reference point” located along the “vertical centerline” on the front of the device aligned to the “ear reference point”. The “test device reference point” should be located at the same level as the center of the earpiece region. The “vertical centerline” should bisect the front surface of the handset at its top and bottom edges. A “ear reference point” is located on the outer surface of the head phantom on each ear spacer. It is located 1.5 cm above the center of the ear canal entrance in the “phantom reference plane” defined by the three lines joining the center of each “ear reference point” (left and right) and the tip of the mouth.

A handset should be initially positioned with the earpiece region pressed against the ear spacer of a head phantom. For the SCC-34/SC-2 head phantom, the device should be positioned parallel to the “N-F” line defined along the base of the ear spacer that contains the “ear reference point”. For interim head phantoms, the device should be positioned parallel to the cheek for maximum RF energy coupling. The “test device reference point” is aligned to the “ear reference point” on the head phantom and the “vertical centerline” is aligned to the “phantom reference plane”. This is called the “initial ear position”. While maintaining these three alignments, the body of the handset is gradually adjusted to each of the following positions for evaluating SAR:

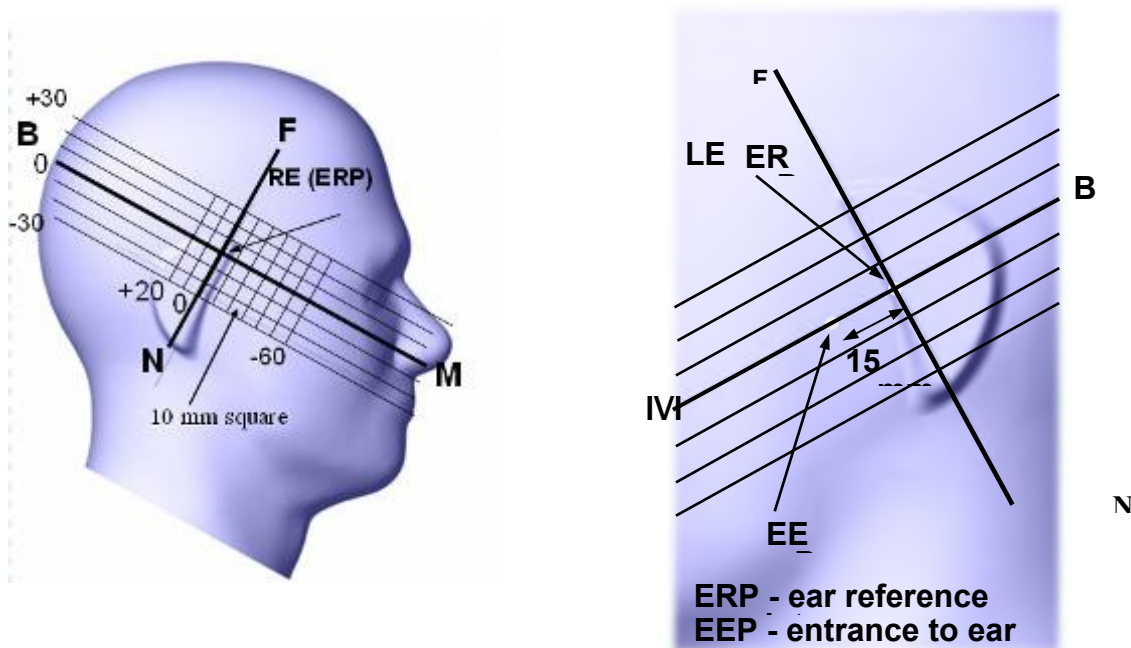

## Cheek/Touch Position

The device is brought toward the mouth of the head phantom by pivoting against the “ear reference point” or along the “N-F” line for the SCC-34/SC-2 head phantom.

This test position is established:

When any point on the display, keypad or mouthpiece portions of the handset is in contact with the phantom.

(or) When any portion of a foldout, sliding or similar keypad cover opened to its intended self-adjusting normal use position is in contact with the cheek or mouth of the phantom.

For existing head phantoms – when the handset loses contact with the phantom at the pivoting point, rotation should continue until the device touches the cheek of the phantom or breaks its last contact from the ear spacer.

### Cheek /Touch Position

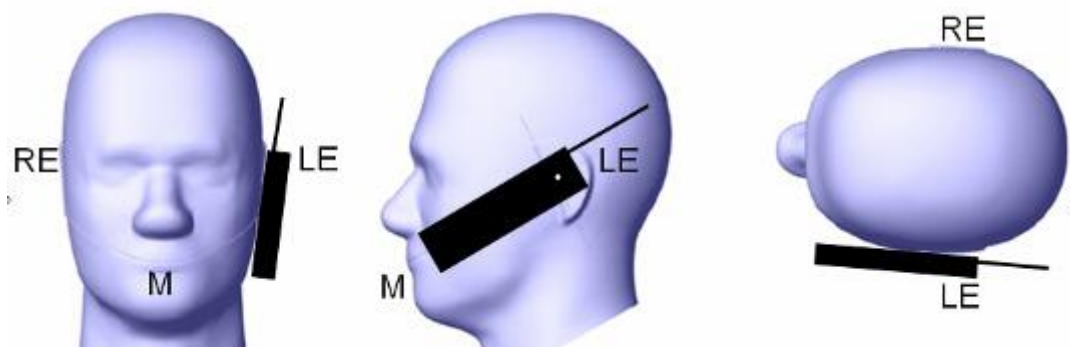

## Ear/Tilt Position

With the handset aligned in the “Cheek/Touch Position”:

1) If the earpiece of the handset is not in full contact with the phantom’s ear spacer (in the “Cheek/Touch position”) and the peak SAR location for the “Cheek/Touch” position is located at the ear spacer region or corresponds to the earpiece region of the handset, the device should be returned to the “initial ear position” by rotating it away from the mouth until the earpiece is in full contact with the ear spacer.

2) (otherwise) The handset should be moved (translated) away from the cheek perpendicular to the line passes through both “ear reference points” (note: one of these ear reference points may not physically exist on a split head model) for approximate 2-3 cm. While it is in this position, the device handset is tilted away from the mouth with respect to the “test device reference point” until the inside angle between the vertical centerline on the front surface of the phone and the horizontal line passing through the ear reference point is by 15 80°. After the tilt, it is then moved (translated) back toward the head perpendicular to the line passes through both “ear reference points” until the device touches the phantom or the ear spacer. If the antenna touches the head first, the positioning process should be repeated with a tilt angle less than 15° so that the device and its antenna would touch the phantom simultaneously. This test position may require a device holder or positioner to achieve the translation and tilting with acceptable positioning repeatability.

If a device is also designed to transmit with its keypad cover closed for operating in the head position, such positions should also be considered in the SAR evaluation. The device should be tested on the left and right side of the head phantom in the “Cheek/Touch” and “Ear/Tilt” positions. When applicable, each configuration should be tested with the antenna in its fully extended and fully retracted positions. These test configurations should be tested at the high, middle and low frequency channels of each operating mode; for example, AMPS, CDMA, and TDMA. If the SAR measured at the middle channel for each test configuration (left, right, Cheek/Touch, Tilt/Ear, extended and retracted) is at least 2.0 dB lower than the

SAR limit, testing at the high and low channels is optional for such test configuration(s). If the transmission band of the test device is less than 10 MHz, testing at the high and low frequency channels is optional.

**Ear /Tilt 15° Position**

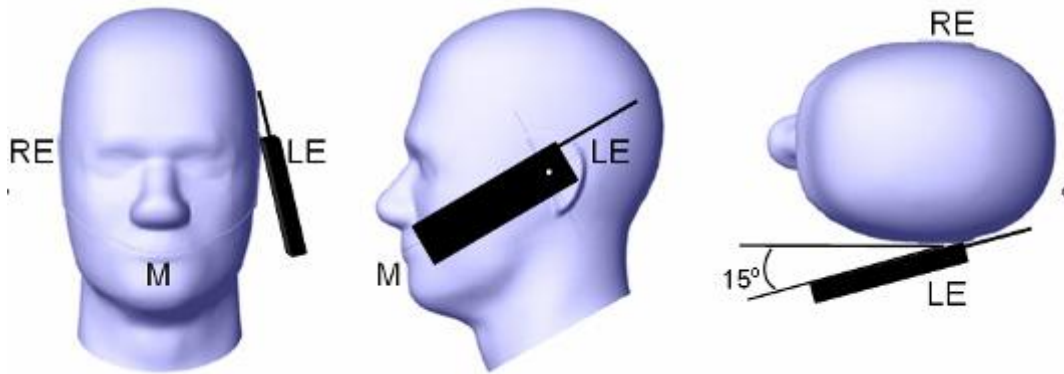

## SAR Evaluation Procedure

The evaluation was performed with the following procedure:

- Step 1: Measurement of the SAR value at a fixed location above the ear point or central position was used as a reference value for assessing the power drop. The SAR at this point is measured at the start of the test and then again at the end of the testing.
- Step 2: The SAR distribution at the exposed side of the head was measured at a distance of 4 mm from the inner surface of the shell. The area covered the entire dimension of the head or radiating structures of the EUT, the horizontal grid spacing was 15 mm x 15 mm, and the SAR distribution was determined by integrated grid of 1.5mm x 1.5mm. Based on these data, the area of the maximum absorption was determined by spline interpolation. The first Area Scan covers the entire dimension of the EUT to ensure that the hotspot was correctly identified.
- Step 3: Around this point, a volume of 30 mm x 30 mm x 30 mm was assessed by measuring 7x 7 x 7 points. On the basis of this data set, the spatial peak SAR value was evaluated under the following procedure:
- 1) The data at the surface were extrapolated, since the center of the dipoles is 1.2 mm away from the tip of the probe and the distance between the surface and the lowest measuring point is 1.3 mm. The extrapolation was based on a least square algorithm. A polynomial of the fourth order was calculated through the points in z-axes. This polynomial was then used to evaluate the points between the surface and the probe tip.
  - 2) The maximum interpolated value was searched with a straightforward algorithm. Around this maximum the SAR values averaged over the spatial volumes (1 g or 10 g) were computed by the 3D-Spline interpolation algorithm. The 3D-Spline is composed of three one dimensional splines with the "Not a knot"-condition (in x, y and z-directions). The volume was integrated with the trapezoidal-algorithm. One thousand points (10 x 10 x 10) were interpolated to calculate the averages.
- All neighboring volumes were evaluated until no neighboring volume with a higher average value was found.
- Step 4: Re-measurement of the SAR value at the same location as in Step 1. If the value changed by more than 5%, the evaluation was repeated.

## CONDUCTED OUTPUT POWER MEASUREMENT

### Maximum Target Output Power

Max Target Power(dBm)			
Mode/Band	Channel		
	Low	Middle	High
DECT Ant 1	18.5	18.5	18.5
DECT Ant 2	18.5	18.5	18.5

### Test Results:

#### DECT :

Mode	Antenna	Frequency (MHz)	RF Output Peak Power (dBm)
DECT	Ant 1	1921.536	17.99
		1924.992	17.90
		1928.448	17.86
	Ant 2	1921.536	17.90
		1924.992	17.74
		1928.448	17.85

#### Note:

- Rohde & Schwarz Radio Communication Tester (CMD60) was used for the measurement of DECT peak output power.
- Duty Cycle=1:24
- The EUT belongs to a low duty cycle device.
- Per IEEE1528:2013, **1 Channel** shall be tested; the middle channel was selected to test:

$$N_c = \text{Round} \left\{ \left[ 100(f_{\text{high}} - f_{\text{low}}) / f_c \right]^{0.5} \times (f_c / 100)^{0.2} \right\},$$

where  $f_{\text{high}}$  is the highest frequency in the band and  $f_{\text{low}}$  is the lowest  $f_c$  is the center frequency in the band.

**Antennas Location:**



**Antenna Distance To Edge**

Antenna Distance To Edge(mm)	
Antenna	Touch the ear
DECT Ant 1	22
DECT Ant 2	22



**Standalone SAR test exclusion considerations(KDB)**

General Sequence for Determination of Procedure (exemption or evaluation) to Establish Compliance with Exposure Limits for a Single RF Source:

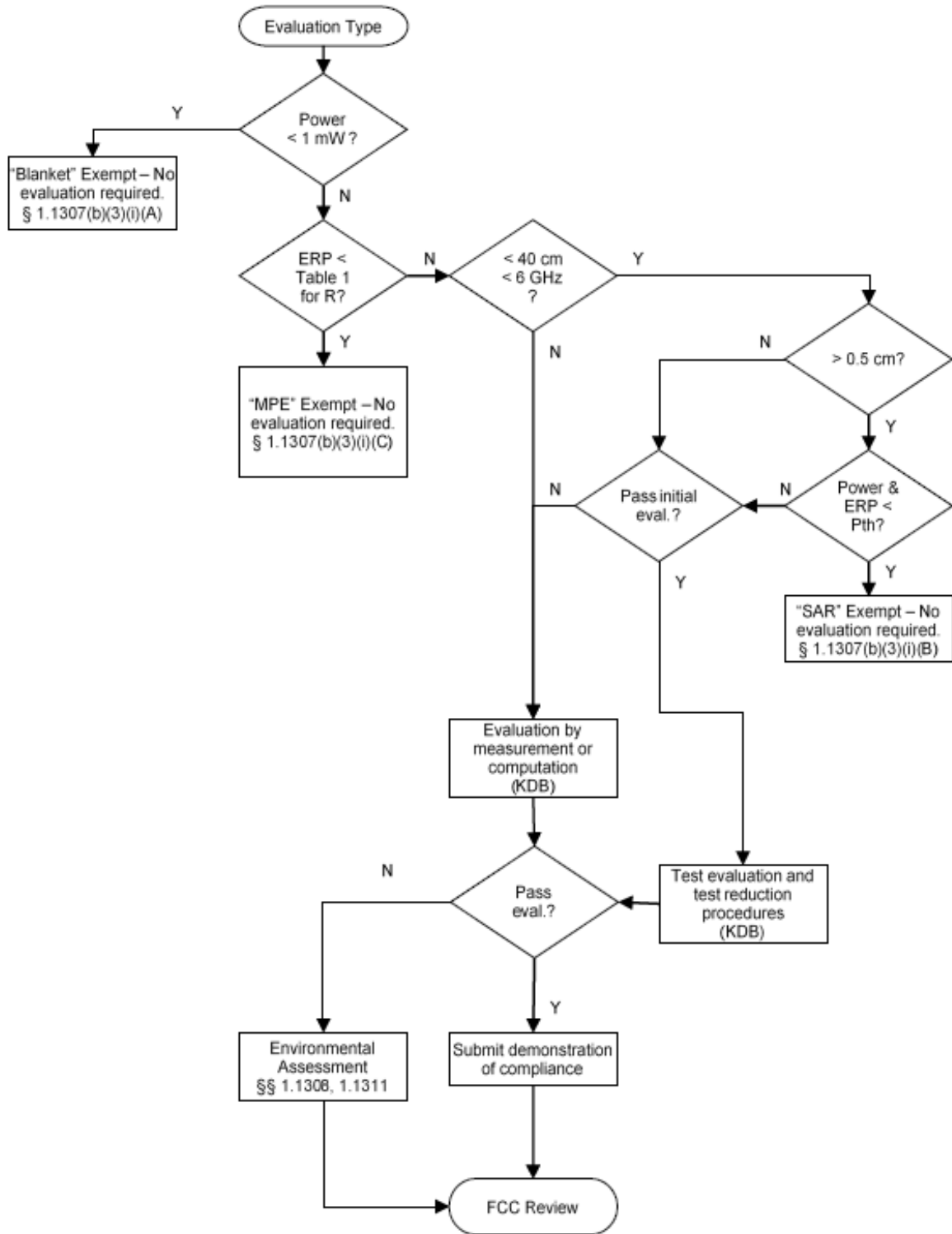

Mode	Frequency (GHz)	Max Target Power (dBm)	Antenna gain (dBi)	P <sub>Max</sub> (dBm)	P <sub>Max</sub> (mW)	Separation Distance (cm)	P <sub>th</sub> (Body) (mW)	SAR Test Exclusion
DECT Ant 1	1.928	18.5	2.0	18.5	70.795	< 2.2	51.54	NO
DECT Ant 2	1.928	18.5	2.0	18.5	70.795	< 2.2	51.54	NO

**Note:**

1. ERP= Max Target Power+ Antenna gain-2.15
2. P<sub>Max</sub> refers to the greater value in the conducted average power and ERP.
3. The formula for calculating P<sub>th</sub> is given below, with distances ranging from 20cm to 40cm.

$$P_{th} \text{ (mW)} = ERP_{20 \text{ cm}} \text{ (mW)} = \begin{cases} 2040f & 0.3 \text{ GHz} \leq f < 1.5 \text{ GHz} \\ 3060 & 1.5 \text{ GHz} \leq f \leq 6 \text{ GHz} \end{cases}$$

4. The formula for calculating P<sub>th</sub> is given below, with distances ranging from 0.5cm to 40cm.

$$P_{th} \text{ (mW)} = \begin{cases} ERP_{20 \text{ cm}} (d/20 \text{ cm})^x & d \leq 20 \text{ cm} \\ ERP_{20 \text{ cm}} & 20 \text{ cm} < d \leq 40 \text{ cm} \end{cases}$$

where

$$x = -\log_{10} \left( \frac{60}{ERP_{20 \text{ cm}} \sqrt{f}} \right)$$

and  $f$  is in GHz,  $d$  is the separation distance (cm), and ERP<sub>20cm</sub> is per Formula (Note 3).

5. When the separation distance is less than 0.5cm, 0.5cm is used as the calculation distance

**SAR test for the EUT edge considerations Result**

Antenna Distance To Edge(mm)	
Mode	Touch
Left	Required
Right	Required

## SAR MEASUREMENT RESULTS

This page summarizes the results of the performed dosimetric evaluation.

### SAR Test Data

#### Environmental Conditions

Temperature:	22.1-23.3 °C
Relative Humidity:	42-54 %
ATM Pressure:	101.3 kPa
Test Date:	2022/11/21

Testing was performed by Seven Liang.

### DECT Mode:

#### Ant 1

EUT Position	Frequency (MHz)	Test Mode	Max. Meas. Power (dBm)	Max. Rated Power (dBm)	1g SAR (W/Kg), Limited=1.6W/kg			
					Scaled Factor	Meas. SAR	Scaled SAR	Plot
Head-touch (Left)	1921.536	GFSK	/	/	/	/	/	/
	1924.992	GFSK	17.90	18.5	1.148	0.020	0.03	1#
	1928.448	GFSK	/	/	/	/	/	/
Head-touch (Right)	1921.536	GFSK	/	/	/	/	/	/
	1924.992	GFSK	17.90	18.5	1.148	0.010	0.02	2#
	1928.448	GFSK	/	/	/	/	/	/

#### Ant 2

EUT Position	Frequency (MHz)	Test Mode	Max. Meas. Power (dBm)	Max. Rated Power (dBm)	1g SAR (W/Kg), Limited=1.6W/kg			
					Scaled Factor	Meas. SAR	Scaled SAR	Plot
Head-touch (Left)	1921.536	GFSK	/	/	/	/	/	/
	1924.992	GFSK	17.74	18.5	1.191	0.009	0.02	3#
	1928.448	GFSK	/	/	/	/	/	/
Head-touch (Right)	1921.536	GFSK	/	/	/	/	/	/
	1924.992	GFSK	17.74	18.5	1.191	0.027	0.04	4#
	1928.448	GFSK	/	/	/	/	/	/

#### Note:

1. When the 1-g SAR is  $\leq 0.8W/Kg$ , testing for other channels are optional.
2. When SAR or MPE is not measured at the maximum power level allowed for production to the individual channels tested to determine compliance.

## SAR Plots

### Plot 1#

**DUT: Solidcom C1 Pro; Type: FULL-DUPLEX WIRELESS INTERCOM SYSTEM; Serial: 1PZR-8**

Communication System: UID 0, DECT (0); Frequency: 1924.99 MHz; Duty Cycle: 1:24

Medium parameters used (interpolated):  $f = 1924.99$  MHz;  $\sigma = 1.391$  S/m;  $\epsilon_r = 40.297$ ;  $\rho = 1000$  kg/m<sup>3</sup>

Phantom section: Left Section

DASY5 Configuration:

- Probe: EX3DV4- SN7441; ConvF(7.94, 7.94, 7.94); Calibrated: 2022/05/16
- Sensor-Surface: 4mm (Mechanical Surface Detection)
- Electronics: DAE4 Sn1211; Calibrated: 3/1/2022
- Phantom: Twin SAM; Type: QD000P40CD; Serial: 1744
- Measurement SW: DASY52, Version 52.10 (4); SEMCAD X Version 14.6.14 (7501)

**Head Left Cheek/DECT Mid/Area Scan (8x10x1):** Measurement grid: dx=15mm, dy=15mm

Maximum value of SAR (measured) = 0.0178 W/kg

**Head Left Cheek/DECT Mid/Zoom Scan (5x5x7)/Cube 0:** Measurement grid: dx=8mm, dy=8mm, dz=5mm

Reference Value = 2.104 V/m; Power Drift = 0.01 dB

Peak SAR (extrapolated) = 0.0250 W/kg

**SAR(1 g) = 0.020 W/kg; SAR(10 g) = 0.013 W/kg**

Maximum value of SAR (measured) = 0.0178 W/kg

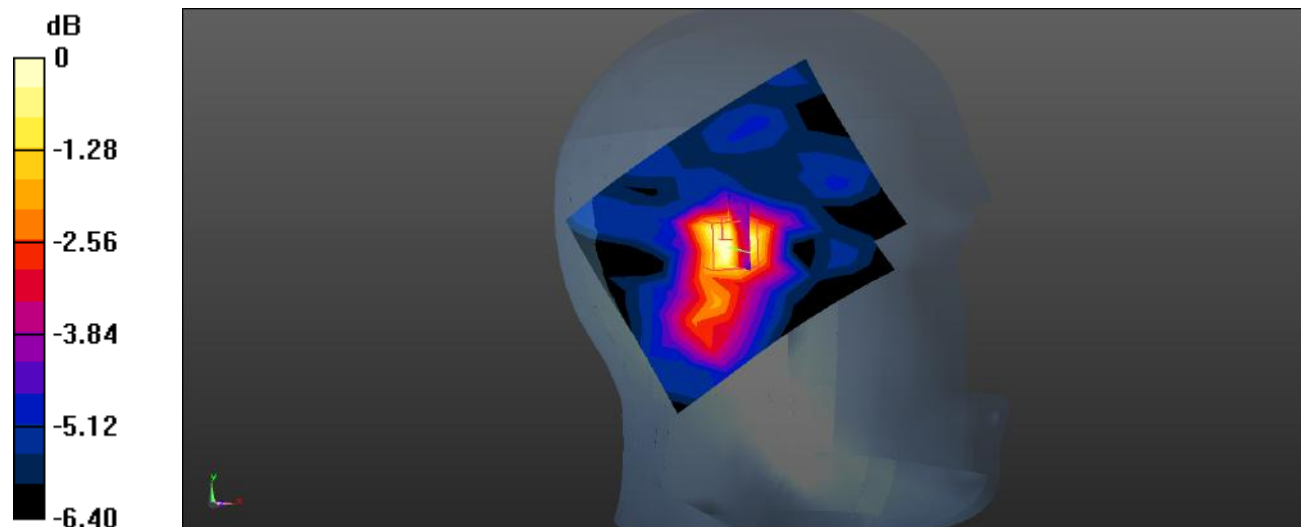

0 dB = 0.0178 W/kg = -17.50 dBW/kg

**Plot 2#****DUT: Solidcom C1 Pro; Type: FULL-DUPLEX WIRELESS INTERCOM SYSTEM; Serial: 1PZR-8**

Communication System: UID 0, DECT (0); Frequency: 1924.99 MHz; Duty Cycle: 1:24

Medium parameters used (interpolated):  $f = 1924.99$  MHz;  $\sigma = 1.391$  S/m;  $\epsilon_r = 40.297$ ;  $\rho = 1000$  kg/m<sup>3</sup>

Phantom section: Right Section

DASY5 Configuration:

- Probe: EX3DV4- SN7441; ConvF(7.94, 7.94, 7.94); Calibrated: 2022/05/16
- Sensor-Surface: 4mm (Mechanical Surface Detection)
- Electronics: DAE4 Sn1211; Calibrated: 3/1/2022
- Phantom: Twin SAM; Type: QD000P40CD; Serial: 1744
- Measurement SW: DASY52, Version 52.10 (4); SEMCAD X Version 14.6.14 (7501)

**Head Right Cheek/DECT Mid/Area Scan (8x10x1):** Measurement grid: dx=15mm, dy=15mm

Maximum value of SAR (measured) = 0.00874 W/kg

**Head Right Cheek/DECT Mid/Zoom Scan (5x5x7)/Cube 0:** Measurement grid: dx=8mm, dy=8mm, dz=5mm

Reference Value = 2.028 V/m; Power Drift = 0.06 dB

Peak SAR (extrapolated) = 0.0430 W/kg

**SAR(1 g) = 0.010 W/kg; SAR(10 g) = 0.00543 W/kg**

Maximum value of SAR (measured) = 0.0104 W/kg

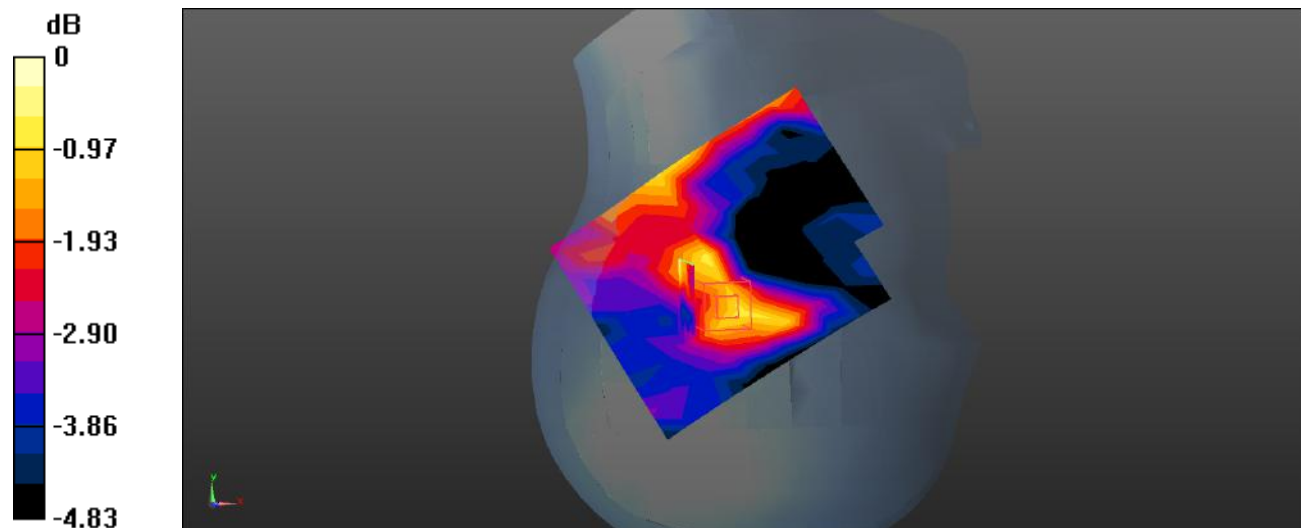

0 dB = 0.0104 W/kg = -19.83 dBW/kg

**Plot 3#****DUT: Solidcom C1 Pro; Type: FULL-DUPLEX WIRELESS INTERCOM SYSTEM; Serial: 1PZR-8**

Communication System: UID 0, DECT (0); Frequency: 1924.99 MHz; Duty Cycle: 1:24

Medium parameters used (interpolated):  $f = 1924.99$  MHz;  $\sigma = 1.391$  S/m;  $\epsilon_r = 40.297$ ;  $\rho = 1000$  kg/m<sup>3</sup>

Phantom section: Left Section

DASY5 Configuration:

- Probe: EX3DV4- SN7441; ConvF(7.94, 7.94, 7.94); Calibrated: 2022/05/16
- Sensor-Surface: 4mm (Mechanical Surface Detection)
- Electronics: DAE4 Sn1211; Calibrated: 3/1/2022
- Phantom: Twin SAM; Type: QD000P40CD; Serial: 1744
- Measurement SW: DASY52, Version 52.10 (4); SEMCAD X Version 14.6.14 (7501)

**Head Left Cheek/DECT Mid/Area Scan (8x10x1):** Measurement grid: dx=15mm, dy=15mm

Maximum value of SAR (measured) = 0.0116 W/kg

**Head Left Cheek/DECT Mid/Zoom Scan (5x5x7)/Cube 0:** Measurement grid: dx=8mm, dy=8mm, dz=5mm

Reference Value = 2.029 V/m; Power Drift = 0.05 dB

Peak SAR (extrapolated) = 0.0400 W/kg

**SAR(1 g) = 0.00868 W/kg; SAR(10 g) = 0.00267 W/kg**

Maximum value of SAR (measured) = 0.0127 W/kg

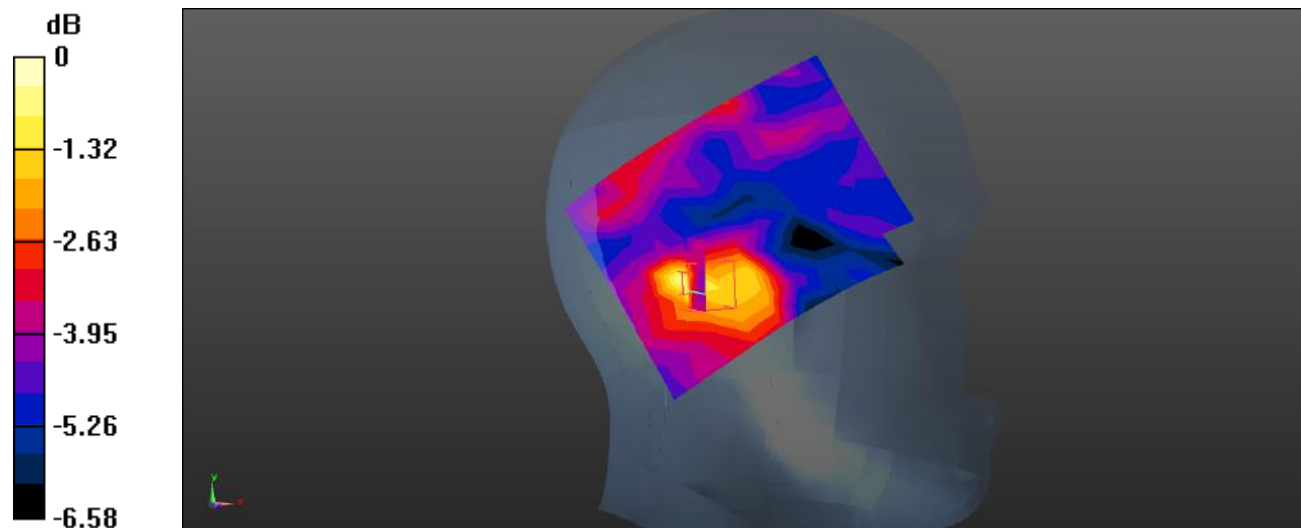

0 dB = 0.0127 W/kg = -18.96 dBW/kg

**Plot 4#****DUT: Solidcom C1 Pro; Type: FULL-DUPLEX WIRELESS INTERCOM SYSTEM; Serial: 1PZR-8**

Communication System: UID 0, DECT (0); Frequency: 1924.99 MHz; Duty Cycle: 1:24

Medium parameters used (interpolated):  $f = 1924.99$  MHz;  $\sigma = 1.391$  S/m;  $\epsilon_r = 40.297$ ;  $\rho = 1000$  kg/m<sup>3</sup>

Phantom section: Right Section

DASY5 Configuration:

- Probe: EX3DV4- SN7441; ConvF(7.94, 7.94, 7.94); Calibrated: 2022/05/16
- Sensor-Surface: 4mm (Mechanical Surface Detection)
- Electronics: DAE4 Sn1211; Calibrated: 3/1/2022
- Phantom: Twin SAM; Type: QD000P40CD; Serial: 1744
- Measurement SW: DASY52, Version 52.10 (4); SEMCAD X Version 14.6.14 (7501)

**Head Right Cheek/DECT Mid/Area Scan (8x10x1):** Measurement grid: dx=15mm, dy=15mm

Maximum value of SAR (measured) = 0.0387 W/kg

**Head Right Cheek/DECT Mid/Zoom Scan (5x5x7)/Cube 0:** Measurement grid: dx=8mm, dy=8mm, dz=5mm

Reference Value = 1.977 V/m; Power Drift = 0.05 dB

Peak SAR (extrapolated) = 0.0670 W/kg

**SAR(1 g) = 0.027 W/kg; SAR(10 g) = 0.012 W/kg**

Maximum value of SAR (measured) = 0.0331 W/kg

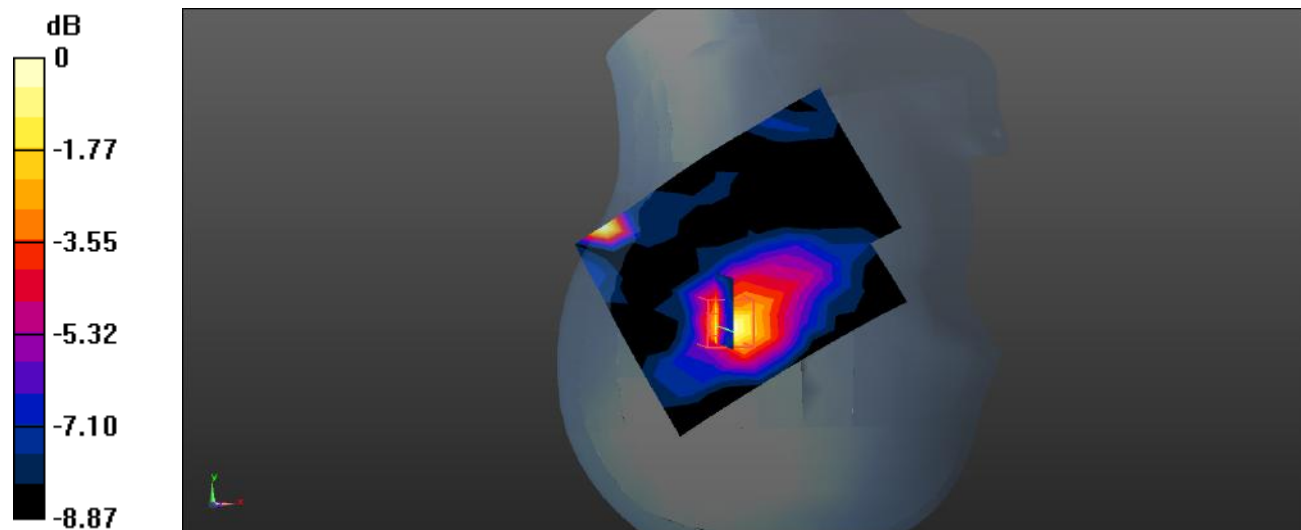

0 dB = 0.0331 W/kg = -14.80 dBW/kg

## APPENDIX A MEASUREMENT UNCERTAINTY

The uncertainty budget has been determined for the measurement system and is given in the following Table.  
**Measurement uncertainty evaluation for IEEE1528-2013 SAR test**

Source of uncertainty	Tolerance/uncertainty y ± %	Probability distribution	Divisor	ci (1 g)	ci (10 g)	Standard uncertainty ± %, (1 g)	Standard uncertainty ± %, (10 g)
<b>Measurement system</b>							
Probe calibration	6.55	N	1	1	1	6.6	6.6
Axial Isotropy	4.7	R	$\sqrt{3}$	1	1	2.7	2.7
Hemispherical Isotropy	9.6	R	$\sqrt{3}$	0	0	0.0	0.0
Boundary effect	1.0	R	$\sqrt{3}$	1	1	0.6	0.6
Linearity	4.7	R	$\sqrt{3}$	1	1	2.7	2.7
Detection limits	1.0	R	$\sqrt{3}$	1	1	0.6	0.6
Readout electronics	0.3	N	1	1	1	0.3	0.3
Response time	0.0	R	$\sqrt{3}$	1	1	0.0	0.0
Integration time	0.0	R	$\sqrt{3}$	1	1	0.0	0.0
RF ambient conditions – noise	1.0	R	$\sqrt{3}$	1	1	0.6	0.6
RF ambient conditions–reflections	1.0	R	$\sqrt{3}$	1	1	0.6	0.6
Probe positioner mech. Restrictions	0.8	R	$\sqrt{3}$	1	1	0.5	0.5
Probe positioning with respect to phantom shell	6.7	R	$\sqrt{3}$	1	1	3.9	3.9
Post-processing	2.0	R	$\sqrt{3}$	1	1	1.2	1.2
<b>Test sample related</b>							
Test sample positioning	2.8	N	1	1	1	2.8	2.8
Device holder uncertainty	6.3	N	1	1	1	6.3	6.3
Drift of output power	5.0	R	$\sqrt{3}$	1	1	2.9	2.9
<b>Phantom and set-up</b>							
Phantom uncertainty (shape and thickness tolerances)	4.0	R	$\sqrt{3}$	1	1	2.3	2.3
Liquid conductivity target)	5.0	R	$\sqrt{3}$	0.64	0.43	1.8	1.2
Liquid conductivity meas.)	2.5	N	1	0.64	0.43	1.6	1.1
Liquid permittivity target)	5.0	R	$\sqrt{3}$	0.6	0.49	1.7	1.4
Liquid permittivity meas.)	2.5	N	1	0.6	0.49	1.5	1.2
Combined standard uncertainty		RSS				12.2	12.0
Expanded uncertainty 95 % confidence interval)						24.3	23.9



## Measurement uncertainty evaluation for IEC 62209-2 SAR test

Source of uncertainty	Tolerance/uncertainty ± %	Probability distribution	Divisor	ci (1 g)	ci (10 g)	Standard uncertainty ± %, (1 g)	Standard uncertainty ± %, (10 g)
<b>Measurement system</b>							
Probe calibration	6.55	N	1	1	1	6.6	6.6
Axial Isotropy	4.7	R	$\sqrt{3}$	1	1	2.7	2.7
Hemispherical Isotropy	9.6	R	$\sqrt{3}$	0	0	0.0	0.0
Linearity	4.7	R	$\sqrt{3}$	1	1	2.7	2.7
Modulation Response	0.0	R	$\sqrt{3}$	1	1	0.0	0.0
Detection limits	1.0	R	$\sqrt{3}$	1	1	0.6	0.6
Boundary effect	1.0	R	$\sqrt{3}$	1	1	0.6	0.6
Readout electronics	0.3	N	1	1	1	0.3	0.3
Response time	0.0	R	$\sqrt{3}$	1	1	0.0	0.0
Integration time	0.0	R	$\sqrt{3}$	1	1	0.0	0.0
RF ambient conditions – noise	1.0	R	$\sqrt{3}$	1	1	0.6	0.6
RF ambient conditions–reflections	1.0	R	$\sqrt{3}$	1	1	0.6	0.6
Probe positioner mech. Restrictions	0.8	R	$\sqrt{3}$	1	1	0.5	0.5
Probe positioning with respect to phantom shell	6.7	R	$\sqrt{3}$	1	1	3.9	3.9
Post-processing	2.0	R	$\sqrt{3}$	1	1	1.2	1.2
<b>Test sample related</b>							
Device holder Uncertainty	6.3	N	1	1	1	6.3	6.3
Test sample positioning	2.8	N	1	1	1	2.8	2.8
Power scaling	4.5	R	$\sqrt{3}$	1	1	2.6	2.6
Drift of output power	5.0	R	$\sqrt{3}$	1	1	2.9	2.9
<b>Phantom and set-up</b>							
Phantom uncertainty (shape and thickness tolerances)	4.0	R	$\sqrt{3}$	1	1	2.3	2.3
Algorithm for correcting SAR for deviations in permittivity and conductivity	1.9	N	1	1	0.84	1.1	0.9
Liquid conductivity (meas.)	2.5	N	1	0.64	0.43	1.6	1.1
Liquid permittivity (meas.)	2.5	N	1	0.6	0.49	1.5	1.2
Temp. unc. - Conductivity	1.7	R	$\sqrt{3}$	0.78	0.71	0.8	0.7
Temp. unc. - Permittivity	0.3	R	$\sqrt{3}$	0.23	0.26	0.0	0.0
Combined standard uncertainty		RSS				12.2	12.1
Expanded uncertainty 95 % confidence interval)						24.5	24.2

## APPENDIX B EUT TEST POSITION PHOTOS

---

Liquid depth  $\geq 15\text{cm}$

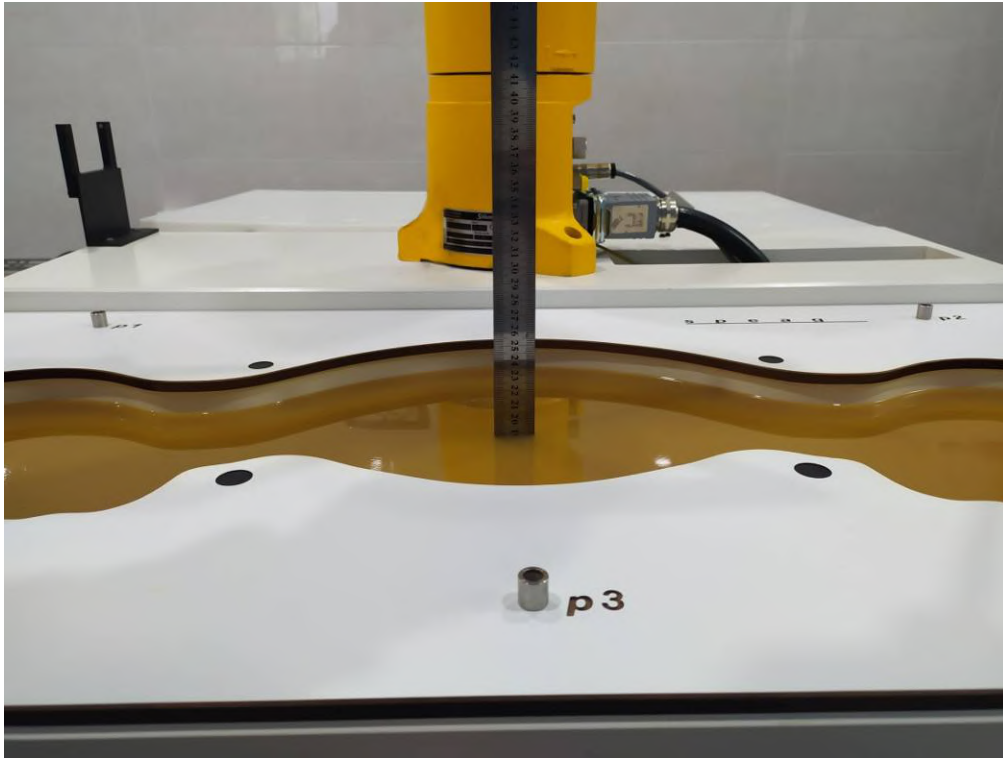

**Head-touch (Left) Setup Photo**

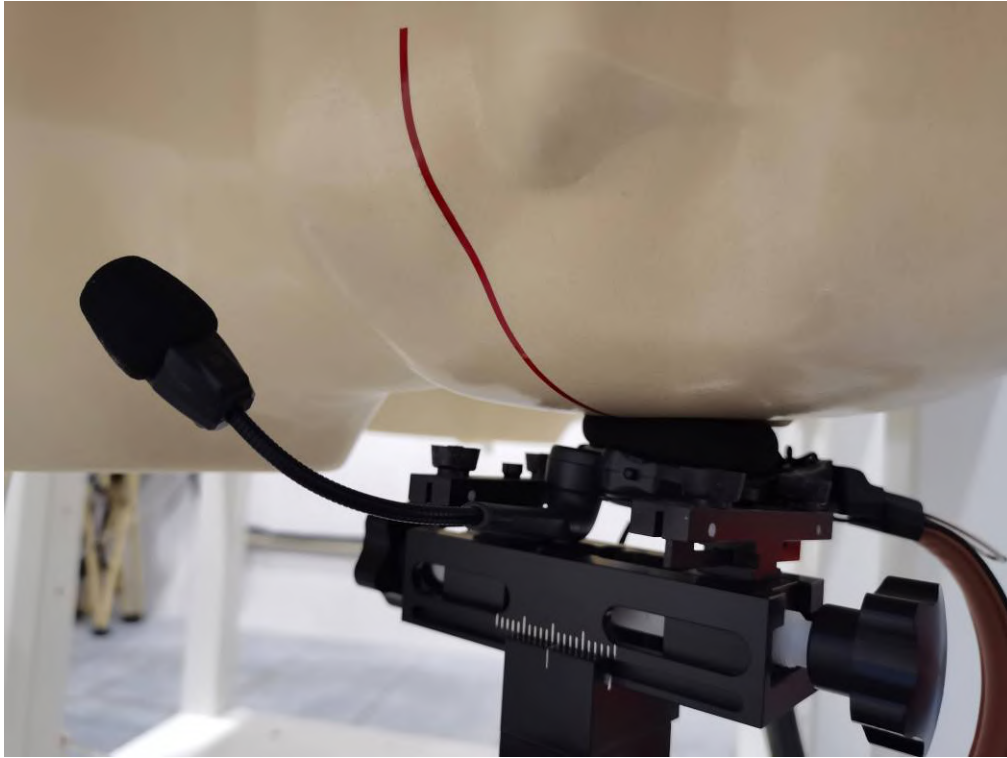

**Head-touch (Right) Setup Photo**

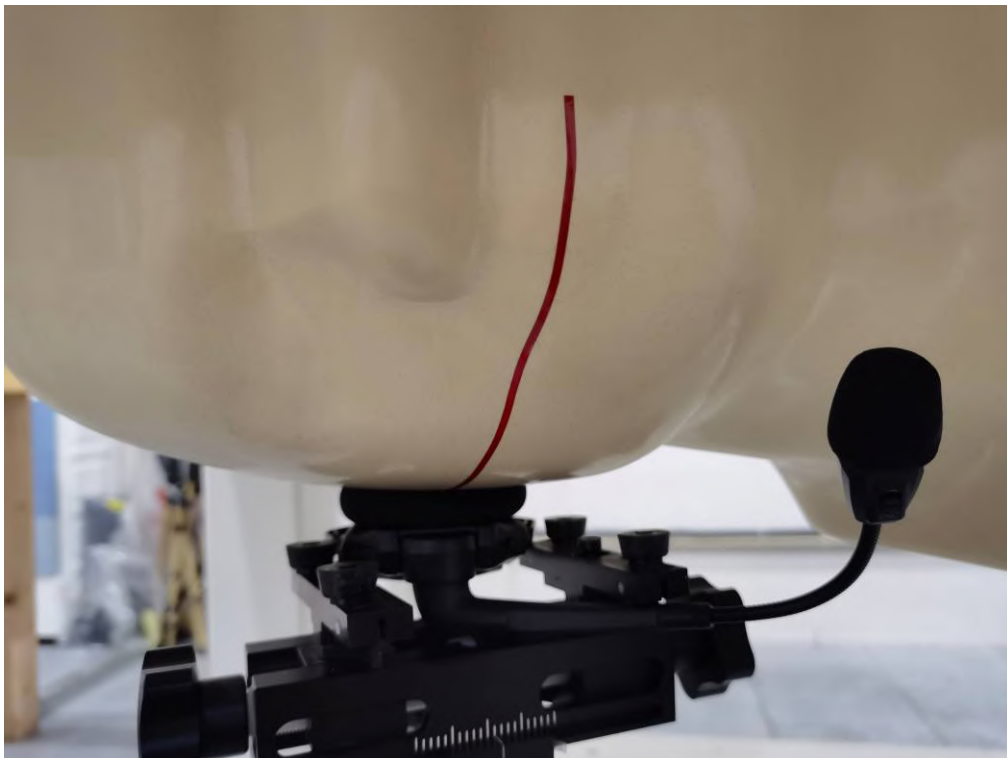

### APPENDIX C PROBE CALIBRATION CERTIFICATES

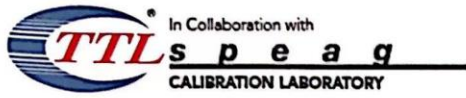

In Collaboration with  
 Add: No.52 HuaYuanBei Road, Haidian District, Beijing, 100191, China  
 Tel: +86-10-62304633-2117  
 E-mail: cttl@chinattl.com http://www.caict.ac.cn



中国认可  
 国际互认  
 校准  
 CALIBRATION  
 CNAS L0570

Client **BACL**

Certificate No: **Z22-60101**

CALIBRATION CERTIFICATE			
Object	EX3DV4 - SN : 7441		
Calibration Procedure(s)	FF-Z11-004-02 Calibration Procedures for Dosimetric E-field Probes		
Calibration date:	May 16, 2022		
<p>This calibration Certificate documents the traceability to national standards, which realize the physical units of measurements(SI). The measurements and the uncertainties with confidence probability are given on the following pages and are part of the certificate.</p> <p>All calibrations have been conducted in the closed laboratory facility: environment temperature(22±3)°C and humidity&lt;70%.</p> <p>Calibration Equipment used (M&amp;TE critical for calibration)</p>			
Primary Standards	ID #	Cal Date(Calibrated by, Certificate No.)	Scheduled Calibration
Power Meter NRP2	101919	15-Jun-21(CTTL, No.J21X04466)	Jun-22
Power sensor NRP-Z91	101547	15-Jun-21(CTTL, No.J21X04466)	Jun-22
Power sensor NRP-Z91	101548	15-Jun-21(CTTL, No.J21X04466)	Jun-22
Reference 10dBAttenuator	18N50W-10dB	20-Jan-21(CTTL, No.J21X00486)	Jan-23
Reference 20dBAttenuator	18N50W-20dB	20-Jan-21(CTTL, No.J21X00485)	Jan-23
Reference Probe EX3DV4	SN 7464	26-Jan-22(SPEAG, No.EX3-7464_Jan22)	Jan-23
DAE4	SN 1555	20-Aug-21(SPEAG, No.DAE4-1555_Aug21/2)	Aug-22
Secondary Standards	ID #	Cal Date(Calibrated by, Certificate No.)	Scheduled Calibration
SignalGenerator MG3700A	6201052605	16-Jun-21(CTTL, No.J21X04467)	Jun-22
Network Analyzer E5071C	MY46110673	14-Jan-22(CTTL, No.J22X00406)	Jan-23
Calibrated by:	Name	Function	Signature
	Yu Zongying	SAR Test Engineer	
Reviewed by:	Lin Hao	SAR Test Engineer	
Approved by:	Qi Dianyuan	SAR Project Leader	
Issued: May 23, 2022			
This calibration certificate shall not be reproduced except in full without written approval of the laboratory.			

Certificate No: Z22-60101

Page 1 of 9



In Collaboration with  
**s p e a q**  
 CALIBRATION LABORATORY



Add: No.52 HuaYuanBei Road, Haidian District, Beijing, 100191, China  
 Tel: +86-10-62304633-2117  
 E-mail: cttl@chinattl.com http://www.caict.ac.cn

#### Glossary:

TSL	tissue simulating liquid
NORM <sub>x,y,z</sub>	sensitivity in free space
ConvF	sensitivity in TSL / NORM <sub>x,y,z</sub>
DCP	diode compression point
CF	crest factor (1/duty_cycle) of the RF signal
A,B,C,D	modulation dependent linearization parameters
Polarization $\Phi$	$\Phi$ rotation around probe axis
Polarization $\theta$	$\theta$ rotation around an axis that is in the plane normal to probe axis (at measurement center), i $\theta=0$ is normal to probe axis

Connector Angle information used in DASY system to align probe sensor X to the robot coordinate system

#### Calibration is Performed According to the Following Standards:

- IEEE Std 1528-2013, "IEEE Recommended Practice for Determining the Peak Spatial-Averaged Specific Absorption Rate (SAR) in the Human Head from Wireless Communications Devices: Measurement Techniques", June 2013
- IEC 62209-1, "Measurement procedure for the assessment of Specific Absorption Rate (SAR) from hand-held and body-mounted devices used next to the ear (frequency range of 300 MHz to 6 GHz)", July 2016
- IEC 62209-2, "Procedure to determine the Specific Absorption Rate (SAR) for wireless communication devices used in close proximity to the human body (frequency range of 30 MHz to 6 GHz)", March 2010
- KDB 865664, "SAR Measurement Requirements for 100 MHz to 6 GHz"

#### Methods Applied and Interpretation of Parameters:

- NORM<sub>x,y,z</sub>**: Assessed for E-field polarization  $\theta=0$  ( $f \leq 900$  MHz in TEM-cell;  $f > 1800$  MHz: waveguide). NORM<sub>x,y,z</sub> are only intermediate values, i.e., the uncertainties of NORM<sub>x,y,z</sub> does not effect the  $E^2$ -field uncertainty inside TSL (see below ConvF).
- NORM(f)<sub>x,y,z</sub> = NORM<sub>x,y,z</sub> \* frequency\_response** (see Frequency Response Chart). This linearization is implemented in DASY4 software versions later than 4.2. The uncertainty of the frequency response is included in the stated uncertainty of ConvF.
- DCP<sub>x,y,z</sub>**: DCP are numerical linearization parameters assessed based on the data of power sweep (no uncertainty required). DCP does not depend on frequency nor media.
- PAR**: PAR is the Peak to Average Ratio that is not calibrated but determined based on the signal characteristics.
- A<sub>x,y,z</sub>; B<sub>x,y,z</sub>; C<sub>x,y,z</sub>; VR<sub>x,y,z</sub>; A,B,C** are numerical linearization parameters assessed based on the data of power sweep for specific modulation signal. The parameters do not depend on frequency nor media. VR is the maximum calibration range expressed in RMS voltage across the diode.
- ConvF and Boundary Effect Parameters**: Assessed in flat phantom using E-field (or Temperature Transfer Standard for  $f \leq 800$  MHz) and inside waveguide using analytical field distributions based on power measurements for  $f > 800$  MHz. The same setups are used for assessment of the parameters applied for boundary compensation (alpha, depth) of which typical uncertainty valued are given. These parameters are used in DASY4 software to improve probe accuracy close to the boundary. The sensitivity in TSL corresponds to NORM<sub>x,y,z</sub> \* ConvF whereby the uncertainty corresponds to that given for ConvF. A frequency dependent ConvF is used in DASY version 4.4 and higher which allows extending the validity from  $\pm 50$  MHz to  $\pm 100$  MHz.
- Spherical isotropy (3D deviation from isotropy)**: in a field of low gradients realized using a flat phantom exposed by a patch antenna.
- Sensor Offset**: The sensor offset corresponds to the offset of virtual measurement center from the probe tip (on probe axis). No tolerance required.
- Connector Angle**: The angle is assessed using the information gained by determining the NORM<sub>x</sub> (no uncertainty required).

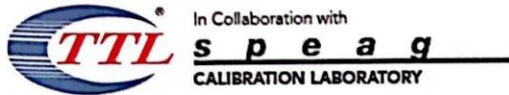

Add: No.52 HuaYuanBei Road, Haidian District, Beijing, 100191, China  
 Tel: +86-10-62304633-2117  
 E-mail: cttl@chinattl.com http://www.caict.ac.cn

**DASY/EASY – Parameters of Probe: EX3DV4 – SN:7441**

**Basic Calibration Parameters**

	Sensor X	Sensor Y	Sensor Z	Unc (k=2)
Norm( $\mu\text{V}/(\text{V}/\text{m})^2$ ) <sup>A</sup>	0.40	0.47	0.39	±10.0%
DCP(mV) <sup>B</sup>	90.9	102.2	105.6	

**Modulation Calibration Parameters**

UID	Communication System Name		A dB	B dB $\sqrt{\mu\text{V}}$	C	D dB	VR mV	Unc <sup>E</sup> (k=2)
0	CW	X	0.0	0.0	1.0	0.00	147.5	±2.7%
		Y	0.0	0.0	1.0		169.7	
		Z	0.0	0.0	1.0		155.0	

The reported uncertainty of measurement is stated as the standard uncertainty of Measurement multiplied by the coverage factor  $k=2$ , which for a normal distribution Corresponds to a coverage probability of approximately 95%.

<sup>A</sup> The uncertainties of Norm X, Y, Z do not affect the E<sup>2</sup>-field uncertainty inside TSL (see Page 4).

<sup>B</sup> Numerical linearization parameter: uncertainty not required.

<sup>E</sup> Uncertainty is determined using the max. deviation from linear response applying rectangular distribution and is expressed for the square of the field value.

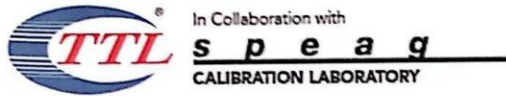

Add: No.52 HuaYuanBei Road, Haidian District, Beijing, 100191, China  
 Tel: +86-10-62304633-2117  
 E-mail: cttl@chinattl.com http://www.caict.ac.cn

**DASY/EASY – Parameters of Probe: EX3DV4 – SN:7441**

**Calibration Parameter Determined in Head Tissue Simulating Media**

f [MHz] <sup>C</sup>	Relative Permittivity <sup>F</sup>	Conductivity (S/m) <sup>F</sup>	ConvF X	ConvF Y	ConvF Z	Alpha <sup>G</sup>	Depth <sup>G</sup> (mm)	Unct. (k=2)
750	41.9	0.89	10.04	10.04	10.04	0.12	1.39	±12.1%
900	41.5	0.97	9.61	9.61	9.61	0.16	1.41	±12.1%
1450	40.5	1.20	8.52	8.52	8.52	0.28	0.95	±12.1%
1750	40.1	1.37	8.32	8.32	8.32	0.29	0.88	±12.1%
1900	40.0	1.40	7.94	7.94	7.94	0.27	1.03	±12.1%
2000	40.0	1.40	7.99	7.99	7.99	0.25	1.15	±12.1%
2300	39.5	1.67	7.78	7.78	7.78	0.65	0.65	±12.1%
2450	39.2	1.80	7.54	7.54	7.54	0.65	0.67	±12.1%
2600	39.0	1.96	7.30	7.30	7.30	0.64	0.67	±12.1%
3300	38.2	2.71	7.09	7.09	7.09	0.47	0.89	±13.3%
3500	37.9	2.91	6.89	6.89	6.89	0.42	0.95	±13.3%
3700	37.7	3.12	6.55	6.55	6.55	0.42	1.01	±13.3%
3900	37.5	3.32	6.60	6.60	6.60	0.35	1.35	±13.3%
4400	36.9	3.84	6.34	6.34	6.34	0.35	1.35	±13.3%
4600	36.7	4.04	6.26	6.26	6.26	0.45	1.20	±13.3%
4800	36.4	4.25	6.16	6.16	6.16	0.45	1.25	±13.3%
4950	36.3	4.40	5.85	5.85	5.85	0.50	1.15	±13.3%
5250	35.9	4.71	5.35	5.35	5.35	0.55	1.15	±13.3%
5600	35.5	5.07	4.85	4.85	4.85	0.55	1.20	±13.3%
5750	35.4	5.22	4.83	4.83	4.83	0.55	1.20	±13.3%

<sup>C</sup> Frequency validity above 300 MHz of ±100MHz only applies for DASY v4.4 and higher (Page 2), else it is restricted to ±50MHz. The uncertainty is the RSS of ConvF uncertainty at calibration frequency and the uncertainty for the indicated frequency band. Frequency validity below 300 MHz is ± 10, 25, 40, 50 and 70 MHz for ConvF assessments at 30, 64, 128, 150 and 220 MHz respectively. Above 5 GHz frequency validity can be extended to ± 110 MHz.

<sup>F</sup> At frequency below 3 GHz, the validity of tissue parameters (ε and σ) can be relaxed to ±10% if liquid compensation formula is applied to measured SAR values. At frequencies above 3 GHz, the validity of tissue parameters (ε and σ) is restricted to ±5%. The uncertainty is the RSS of the ConvF uncertainty for indicated target tissue parameters.

<sup>G</sup> Alpha/Depth are determined during calibration. SPEAG warrants that the remaining deviation due to the boundary effect after compensation is always less than ± 1% for frequencies below 3 GHz and below ± 2% for the frequencies between 3-6 GHz at any distance larger than half the probe tip diameter from the boundary.

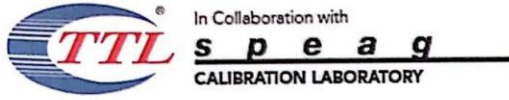

Add: No.52 HuaYuanBei Road, Haidian District, Beijing, 100191, China  
Tel: +86-10-62304633-2117  
E-mail: cttl@chinattl.com <http://www.caiet.ac.cn>

### Frequency Response of E-Field (TEM-Cell: ifi110 EXX, Waveguide: R22)

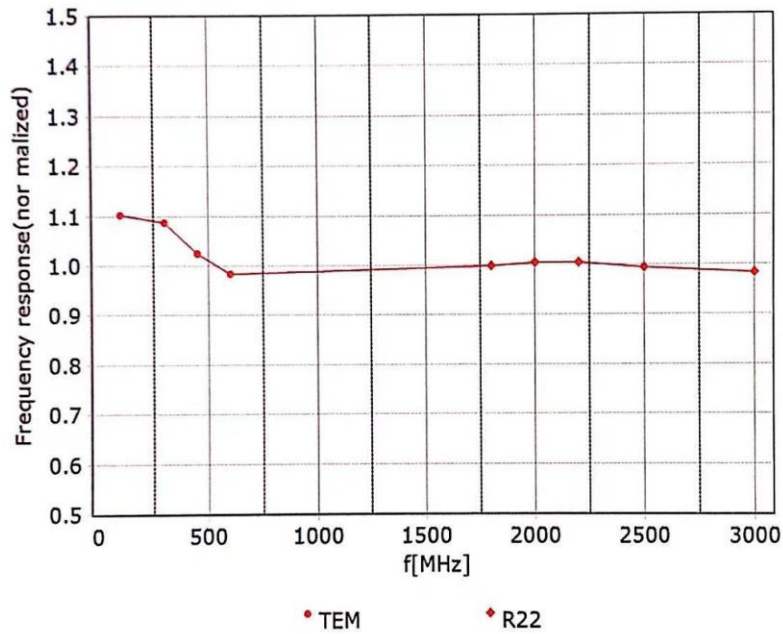

Uncertainty of Frequency Response of E-field:  $\pm 7.4\%$  ( $k=2$ )



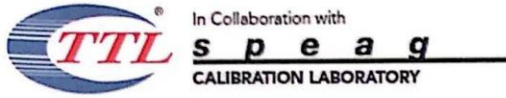

Add: No.52 HuaYuanBei Road, Haidian District, Beijing, 100191, China  
Tel: +86-10-62304633-2117  
E-mail: cttl@chinattl.com      http://www.caict.ac.cn

### Receiving Pattern ( $\Phi$ ), $\theta=0^\circ$

**f=600 MHz, TEM**

**f=1800 MHz, R22**

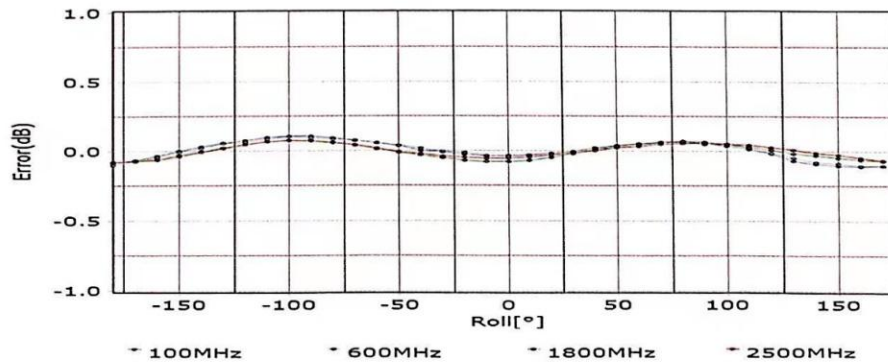
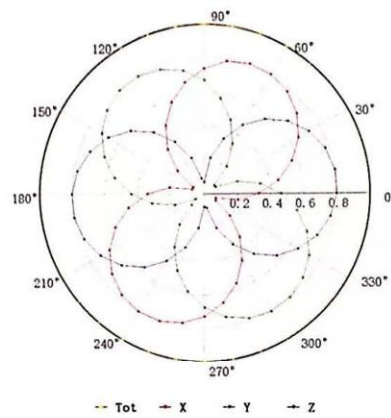
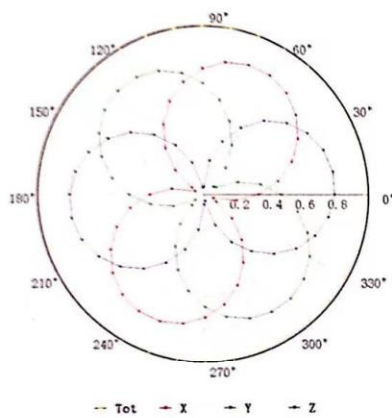

Uncertainty of Axial Isotropy Assessment:  $\pm 1.2\%$  ( $k=2$ )

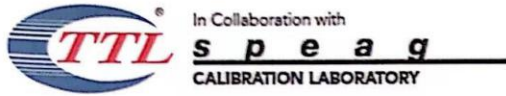

Add: No.52 HuaYuanBei Road, Haidian District, Beijing, 100191, China  
Tel: +86-10-62304633-2117  
E-mail: cttl@chinattl.com http://www.caict.ac.cn

### Dynamic Range f(SAR<sub>head</sub>) (TEM cell, f = 900 MHz)

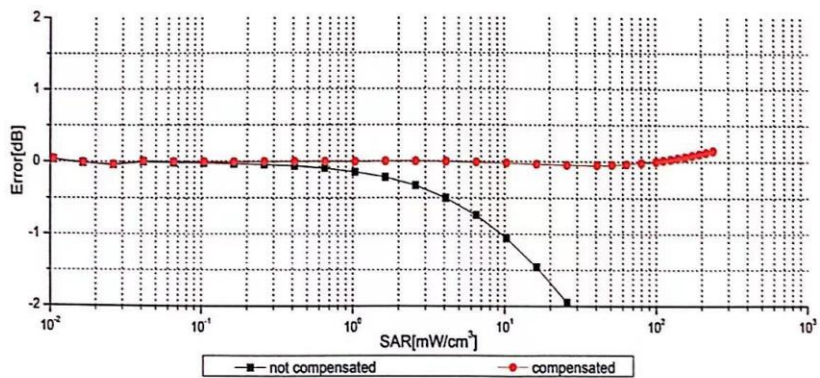
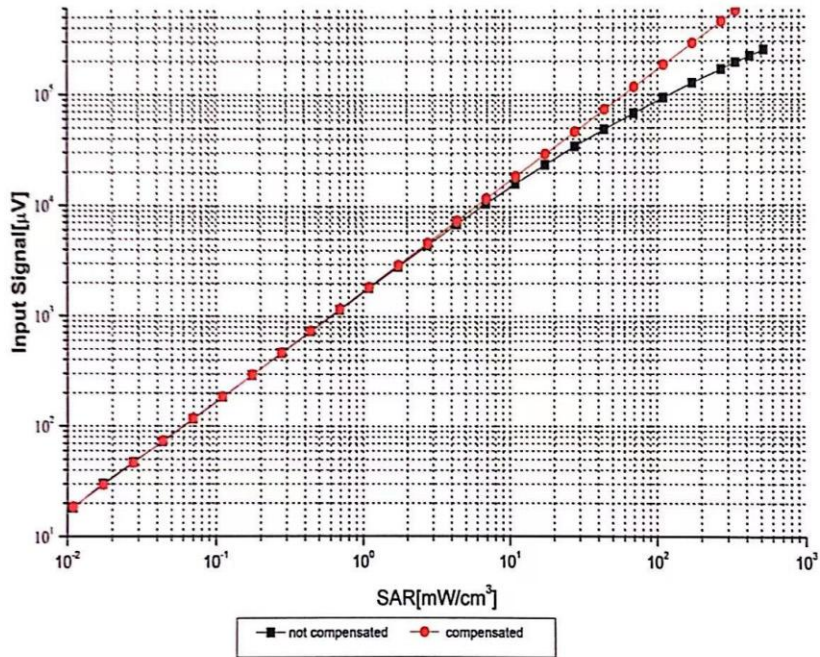

Uncertainty of Linearity Assessment: ±0.9% (k=2)

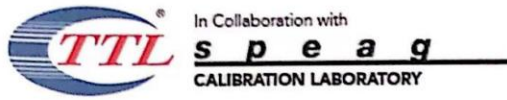

Add: No.52 HuaYuanBei Road, Haidian District, Beijing, 100191, China  
Tel: +86-10-62304633-2117  
E-mail: [cttl@chinattl.com](mailto:cttl@chinattl.com) <http://www.caict.ac.cn>

### Conversion Factor Assessment

f=750 MHz,WGLS R9(H\_convF)

f=1750 MHz,WGLS R22(H\_convF)

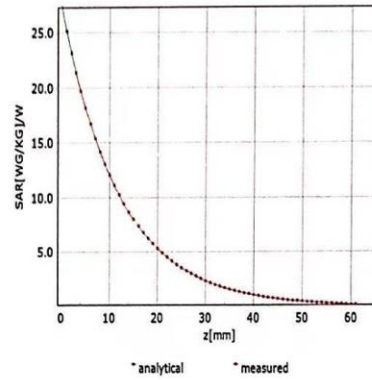
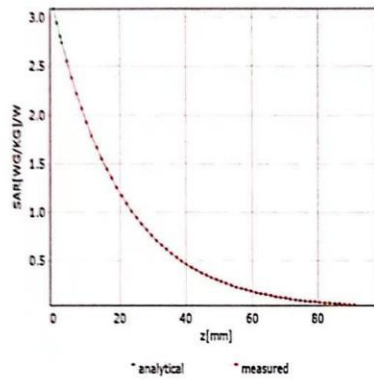

### Deviation from Isotropy in Liquid

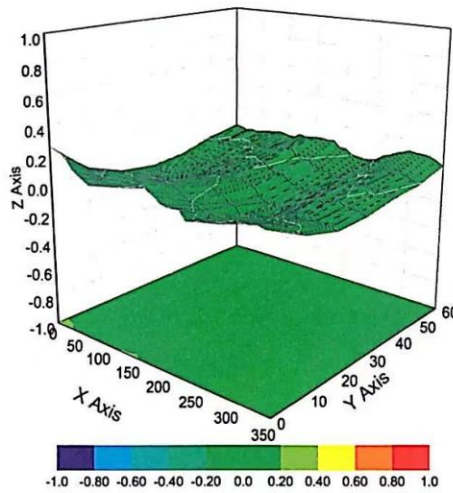

Uncertainty of Spherical Isotropy Assessment:  $\pm 3.2\%$  ( $k=2$ )

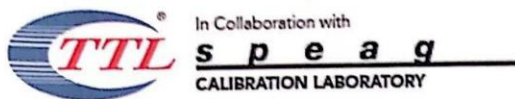

Add: No.52 HuaYuanBei Road, Haidian District, Beijing, 100191, China  
 Tel: +86-10-62304633-2117  
 E-mail: cttl@chinattl.com <http://www.caict.ac.cn>

## DASY/EASY – Parameters of Probe: EX3DV4 – SN:7441

### Other Probe Parameters

Sensor Arrangement	Triangular
Connector Angle (°)	100.7
Mechanical Surface Detection Mode	enabled
Optical Surface Detection Mode	disable
Probe Overall Length	337mm
Probe Body Diameter	10mm
Tip Length	9mm
Tip Diameter	2.5mm
Probe Tip to Sensor X Calibration Point	1mm
Probe Tip to Sensor Y Calibration Point	1mm
Probe Tip to Sensor Z Calibration Point	1mm
Recommended Measurement Distance from Surface	1.4mm

# APPENDIX D DIPOLE CALIBRATION CERTIFICATES

**Calibration Laboratory of  
Schmid & Partner  
Engineering AG**  
Zeughausstrasse 43, 8004 Zurich, Switzerland



**S** Schweizerischer Kalibrierdienst  
**C** Service suisse d'étalonnage  
**S** Servizio svizzero di taratura  
**S** Swiss Calibration Service

Accredited by the Swiss Accreditation Service (SAS)  
The Swiss Accreditation Service is one of the signatories to the EA  
Multilateral Agreement for the recognition of calibration certificates

Accreditation No.: **SCS 0108**

Client **BACL USA**

Certificate No: **D1900V2-5d231\_Jan20**

## CALIBRATION CERTIFICATE

Object **D1900V2 - SN:5d231**

Calibration procedure(s) **QA CAL-05.v11  
Calibration Procedure for SAR Validation Sources between 0.7-3 GHz**

Calibration date: **January 14, 2020**

This calibration certificate documents the traceability to national standards, which realize the physical units of measurements (SI).  
The measurements and the uncertainties with confidence probability are given on the following pages and are part of the certificate.

All calibrations have been conducted in the closed laboratory facility: environment temperature (22 ± 3)°C and humidity < 70%.

Calibration Equipment used (M&TE critical for calibration)

Primary Standards	ID #	Cal Date (Certificate No.)	Scheduled Calibration
Power meter NRP	SN: 104778	03-Apr-19 (No. 217-02892/02893)	Apr-20
Power sensor NRP-Z91	SN: 103244	03-Apr-19 (No. 217-02892)	Apr-20
Power sensor NRP-Z91	SN: 103245	03-Apr-19 (No. 217-02893)	Apr-20
Reference 20 dB Attenuator	SN: 5058 (20k)	04-Apr-19 (No. 217-02894)	Apr-20
Type-N mismatch combination	SN: 5047.2 / 06327	04-Apr-19 (No. 217-02895)	Apr-20
Reference Probe EX3DV4	SN: 7349	31-Dec-19 (No. EX3-7349_Dec19)	Dec-20
DAE4	SN: 601	27-Dec-19 (No. DAE4-601_Dec19)	Dec-20

Secondary Standards	ID #	Check Date (in house)	Scheduled Check
Power meter E4419B	SN: GB39512475	30-Oct-15 (in house check Feb-19)	In house check: Oct-20
Power sensor HP 8481A	SN: US37292783	07-Oct-15 (in house check Oct-18)	In house check: Oct-20
Power sensor HP 8481A	SN: MY41092317	07-Oct-15 (in house check Oct-18)	In house check: Oct-20
RF generator R&S SMT-06	SN: 100972	15-Jun-15 (in house check Oct-18)	In house check: Oct-20
Network Analyzer Agilent E8358A	SN: US41080477	31-Mar-14 (in house check Oct-19)	In house check: Oct-20

Calibrated by: **Claudio Leubler** (Name) / **Laboratory Technician** (Function) / *[Signature]* (Signature)

Approved by: **Katja Pokovic** (Name) / **Technical Manager** (Function) / *[Signature]* (Signature)

Issued: January 15, 2020

This calibration certificate shall not be reproduced except in full without written approval of the laboratory.

**Calibration Laboratory of  
Schmid & Partner  
Engineering AG**  
Zeughausstrasse 43, 8004 Zurich, Switzerland



**S** Schweizerischer Kalibrierdienst  
**C** Service suisse d'étalonnage  
**S** Servizio svizzero di taratura  
**S** Swiss Calibration Service

Accredited by the Swiss Accreditation Service (SAS)  
The Swiss Accreditation Service is one of the signatories to the EA  
Multilateral Agreement for the recognition of calibration certificates

Accreditation No.: **SCS 0108**

**Glossary:**

TSL tissue simulating liquid  
ConvF sensitivity in TSL / NORM x,y,z  
N/A not applicable or not measured

**Calibration is Performed According to the Following Standards:**

- a) IEEE Std 1528-2013, "IEEE Recommended Practice for Determining the Peak Spatial-Averaged Specific Absorption Rate (SAR) in the Human Head from Wireless Communications Devices: Measurement Techniques", June 2013
- b) IEC 62209-1, "Measurement procedure for the assessment of Specific Absorption Rate (SAR) from hand-held and body-mounted devices used next to the ear (frequency range of 300 MHz to 6 GHz)", July 2016
- c) IEC 62209-2, "Procedure to determine the Specific Absorption Rate (SAR) for wireless communication devices used in close proximity to the human body (frequency range of 30 MHz to 6 GHz)", March 2010
- d) KDB 865664, "SAR Measurement Requirements for 100 MHz to 6 GHz"

**Additional Documentation:**

- e) DASY4/5 System Handbook

**Methods Applied and Interpretation of Parameters:**

- *Measurement Conditions:* Further details are available from the Validation Report at the end of the certificate. All figures stated in the certificate are valid at the frequency indicated.
- *Antenna Parameters with TSL:* The dipole is mounted with the spacer to position its feed point exactly below the center marking of the flat phantom section, with the arms oriented parallel to the body axis.
- *Feed Point Impedance and Return Loss:* These parameters are measured with the dipole positioned under the liquid filled phantom. The impedance stated is transformed from the measurement at the SMA connector to the feed point. The Return Loss ensures low reflected power. No uncertainty required.
- *Electrical Delay:* One-way delay between the SMA connector and the antenna feed point. No uncertainty required.
- *SAR measured:* SAR measured at the stated antenna input power.
- *SAR normalized:* SAR as measured, normalized to an input power of 1 W at the antenna connector.
- *SAR for nominal TSL parameters:* The measured TSL parameters are used to calculate the nominal SAR result.

The reported uncertainty of measurement is stated as the standard uncertainty of measurement multiplied by the coverage factor  $k=2$ , which for a normal distribution corresponds to a coverage probability of approximately 95%.

**Measurement Conditions**

DASY system configuration, as far as not given on page 1.

<b>DASY Version</b>	DASY5	V52.10.3
<b>Extrapolation</b>	Advanced Extrapolation	
<b>Phantom</b>	Modular Flat Phantom	
<b>Distance Dipole Center - TSL</b>	10 mm	with Spacer
<b>Zoom Scan Resolution</b>	dx, dy, dz = 5 mm	
<b>Frequency</b>	1900 MHz $\pm$ 1 MHz	

**Head TSL parameters**

The following parameters and calculations were applied.

	Temperature	Permittivity	Conductivity
<b>Nominal Head TSL parameters</b>	22.0 °C	40.0	1.40 mho/m
<b>Measured Head TSL parameters</b>	(22.0 $\pm$ 0.2) °C	41.4 $\pm$ 6 %	1.39 mho/m $\pm$ 6 %
<b>Head TSL temperature change during test</b>	< 0.5 °C	----	----

**SAR result with Head TSL**

<b>SAR averaged over 1 cm<sup>3</sup> (1 g) of Head TSL</b>	Condition	
SAR measured	250 mW input power	9.96 W/kg
SAR for nominal Head TSL parameters	normalized to 1W	<b>40.3 W/kg <math>\pm</math> 17.0 % (k=2)</b>

<b>SAR averaged over 10 cm<sup>3</sup> (10 g) of Head TSL</b>	condition	
SAR measured	250 mW input power	5.19 W/kg
SAR for nominal Head TSL parameters	normalized to 1W	<b>20.9 W/kg <math>\pm</math> 16.5 % (k=2)</b>

**Appendix (Additional assessments outside the scope of SCS 0108)****Antenna Parameters with Head TSL**

Impedance, transformed to feed point	51.5 $\Omega$ + 4.3 j $\Omega$
Return Loss	- 26.9 dB

**General Antenna Parameters and Design**

Electrical Delay (one direction)	1.200 ns
----------------------------------	----------

After long term use with 100W radiated power, only a slight warming of the dipole near the feedpoint can be measured.

The dipole is made of standard semirigid coaxial cable. The center conductor of the feeding line is directly connected to the second arm of the dipole. The antenna is therefore short-circuited for DC-signals. On some of the dipoles, small end caps are added to the dipole arms in order to improve matching when loaded according to the position as explained in the "Measurement Conditions" paragraph. The SAR data are not affected by this change. The overall dipole length is still according to the Standard.

No excessive force must be applied to the dipole arms, because they might bend or the soldered connections near the feedpoint may be damaged.

**Additional EUT Data**

Manufactured by	SPEAG
-----------------	-------



**DASY5 Validation Report for Head TSL**

Date: 14.01.2020

Test Laboratory: SPEAG, Zurich, Switzerland

**DUT: Dipole 1900 MHz; Type: D1900V2; Serial: D1900V2 - SN:5d231**

Communication System: UID 0 - CW; Frequency: 1900 MHz

Medium parameters used:  $f = 1900$  MHz;  $\sigma = 1.39$  S/m;  $\epsilon_r = 41.4$ ;  $\rho = 1000$  kg/m<sup>3</sup>

Phantom section: Flat Section

Measurement Standard: DASY5 (IEEE/IEC/ANSI C63.19-2011)

DASY52 Configuration:

- Probe: EX3DV4 - SN7349; ConvF(8.6, 8.6, 8.6) @ 1900 MHz; Calibrated: 31.12.2019
- Sensor-Surface: 1.4mm (Mechanical Surface Detection)
- Electronics: DAE4 Sn601; Calibrated: 27.12.2019
- Phantom: Flat Phantom 5.0 (front); Type: QD 000 P50 AA; Serial: 1001
- DASY52 52.10.3(1513); SEMCAD X 14.6.13(7474)

**Dipole Calibration for Head Tissue/Pin=250 mW, d=10mm/Zoom Scan (7x7x7)/Cube 0:**

Measurement grid: dx=5mm, dy=5mm, dz=5mm

Reference Value = 110.0 V/m; Power Drift = -0.01 dB

Peak SAR (extrapolated) = 18.7 W/kg

**SAR(1 g) = 9.96 W/kg; SAR(10 g) = 5.19 W/kg**

Smallest distance from peaks to all points 3 dB below = 9.8 mm

Ratio of SAR at M2 to SAR at M1 = 53.9%

Maximum value of SAR (measured) = 15.6 W/kg

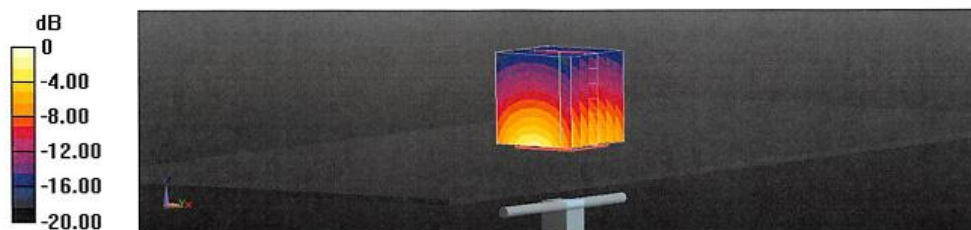

0 dB = 15.6 W/kg = 11.93 dBW/kg

### Impedance Measurement Plot for Head TSL

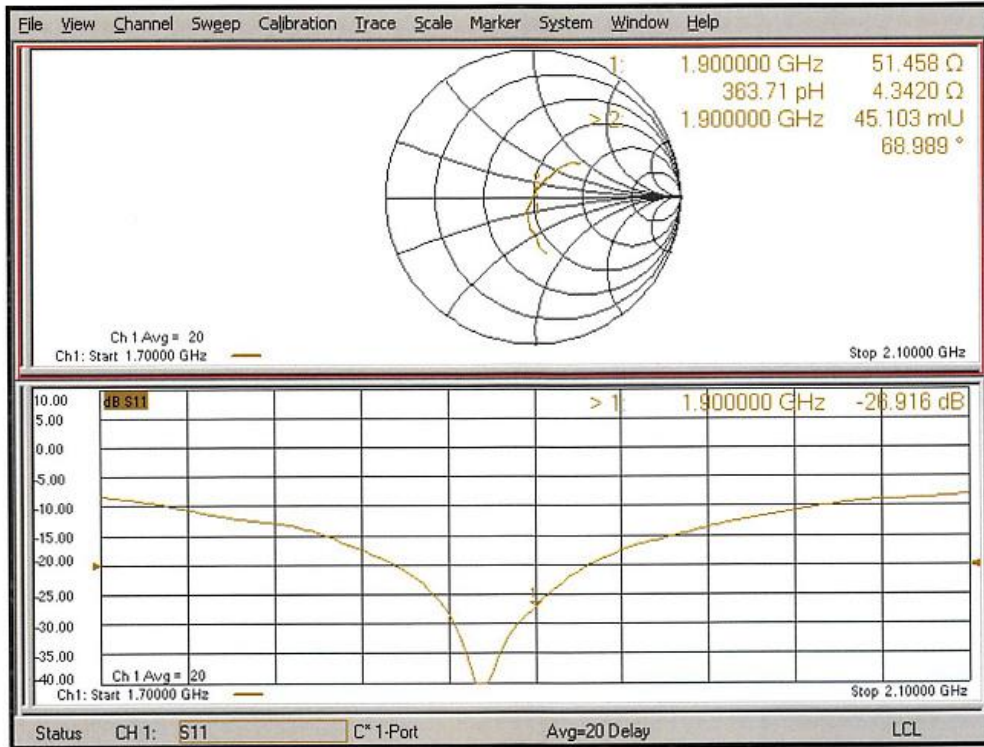

\*\*\*\*\* END OF REPORT \*\*\*\*\*