

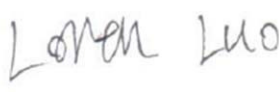

RF TEST REPORT

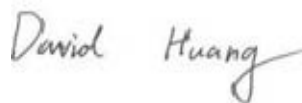

Report No.: 17070226-FCC-R4

Supersede Report No.: N/A

Applicant	TECNO MOBILE LIMITED	
Product Name	Mobile phone	
Model No.	WX4 Pro	
Serial No.	N/A	
Test Standard	FCC Part 15.247: 2016, ANSI C63.10: 2013	
Test Date	March 28 to April 17, 2017	
Issue Date	April 17, 2017	
Test Result	<input checked="" type="checkbox"/> Pass <input type="checkbox"/> Fail	
Equipment complied with the specification	<input checked="" type="checkbox"/>	
Equipment did not comply with the specification	<input type="checkbox"/>	
		
Loren Luo Test Engineer	David Huang Checked By	
This test report may be reproduced in full only Test result presented in this test report is applicable to the tested sample only		

Issued by:

SIEMIC (SHENZHEN-CHINA) LABORATORIES

Zone A, Floor 1, Building 2 Wan Ye Long Technology Park

South Side of Zhoushi Road, Bao' an District, Shenzhen, Guangdong China 518108

Phone: +86 0755 2601 4629801 Email: China@siemic.com.cn

Laboratories Introduction

SIEMIC, headquartered in the heart of Silicon Valley, with superior facilities in US and Asia, is one of the leading independent testing and certification facilities providing customers with one-stop shop services for Compliance Testing and Global Certifications.



In addition to testing and certification, SIEMIC provides initial design reviews and compliance management throughout a project. Our extensive experience with China, Asia Pacific, North America, European, and International compliance requirements, assures the fastest, most cost effective way to attain regulatory compliance for the global markets.

Accreditations for Conformity Assessment

Country/Region	Scope
USA	EMC, RF/Wireless, SAR, Telecom
Canada	EMC, RF/Wireless, SAR, Telecom
Taiwan	EMC, RF, Telecom, SAR, Safety
Hong Kong	RF/Wireless, SAR, Telecom
Australia	EMC, RF, Telecom, SAR, Safety
Korea	EMI, EMS, RF, SAR, Telecom, Safety
Japan	EMI, RF/Wireless, SAR, Telecom
Singapore	EMC, RF, SAR, Telecom
Europe	EMC, RF, SAR, Telecom, Safety

Test Report No.	17070226-FCC-R4
Page	3 of 50

This page has been left blank intentionally.

CONTENTS

1. REPORT REVISION HISTORY	5
2. CUSTOMER INFORMATION	5
3. TEST SITE INFORMATION.....	5
4. EQUIPMENT UNDER TEST (EUT) INFORMATION.....	6
5. TEST SUMMARY	9
6. MEASUREMENTS, EXAMINATION AND DERIVED RESULTS	10
6.1 ANTENNA REQUIREMENT.....	10
6.2 DTS (6 DB) CHANNEL BANDWIDTH	11
6.3 MAXIMUM OUTPUT POWER	13
6.4 POWER SPECTRAL DENSITY.....	15
6.5 BAND-EDGE & UNWANTED EMISSIONS INTO RESTRICTED FREQUENCY BANDS.....	17
6.6 AC POWER LINE CONDUCTED EMISSIONS.....	20
6.7 RADIATED EMISSIONS & RESTRICTED BAND	26
ANNEX A. TEST INSTRUMENT.....	32
ANNEX B. EUT AND TEST SETUP PHOTOGRAPHS.....	33
ANNEX C. TEST SETUP AND SUPPORTING EQUIPMENT.....	45
ANNEX D. USER MANUAL / BLOCK DIAGRAM / SCHEMATICS / PARTLIST	49
ANNEX E. DECLARATION OF SIMILARITY.....	50

1. Report Revision History

Report No.	Report Version	Description	Issue Date
17070226-FCC-R4	NONE	Original	April 17, 2017

2. Customer information

Applicant Name	TECNO MOBILE LIMITED
Applicant Add	ROOMS 05-15, 13A/F., SOUTH TOWER, WORLD FINANCE CENTRE, HARBOUR CITY, 17 CANTON ROAD, TSIM SHA TSUI, KOWLOON, HONG KONG
Manufacturer	SHENZHEN TECNO TECHNOLOGY CO.,LTD.
Manufacturer Add	1-4th Floor,3rd Building,Pacific Industrial Park,No.2088,Shenyan Road,Yantian District,Shenzhen,Guangdong,China

3. Test site information

Lab performing tests	SIEMIC (Shenzhen-China) LABORATORIES
Lab Address	Zone A, Floor 1, Building 2 Wan Ye Long Technology Park South Side of Zhoushi Road, Bao' an District, Shenzhen, Guangdong China 518108
FCC Test Site No.	718246
IC Test Site No.	4842E-1
Test Software of Radiated Emission	Radiated Emission Program-To Shenzhen v2.0
Test Software of Conducted Emission	EZ-EMC(ver.lcp-03A1)

4. Equipment under Test (EUT) Information

Description of EUT:	Mobile phone
Main Model:	WX4 Pro
Serial Model:	N/A
Date EUT received:	March 27, 2017
Test Date(s):	March 28 to April 17, 2017
Equipment Category :	DTS
Antenna Gain:	GSM850: -0.2dBi PCS1900:1.7dBi UMTS-FDD Band V: -0.2dBi UMTS-FDD Band II:1.7dBi LTE Band II:1.7dBi LTE Band IV:1.7dBi LTE Band VII:2.5dBi WIFI:2.0dBi Bluetooth/BLE:2.0dBi GPS: 1.7dBi
Antenna Type:	PIFA antenna
Type of Modulation:	GSM / GPRS: GMSK EGPRS: GMSK,8PSK UMTS-FDD: QPSK LTE Band: QPSK, 16QAM 802.11b/g/n: DSSS, OFDM Bluetooth: GFSK, π /4DQPSK, 8DPSK BLE: GFSK GPS:BPSK

RF Operating Frequency (ies):

GSM850 TX: 824.2 ~ 848.8 MHz; RX: 869.2 ~ 893.8 MHz
 PCS1900 TX: 1850.2 ~ 1909.8 MHz; RX: 1930.2 ~ 1989.8 MHz
 UMTS-FDD Band V TX: 826.4 ~ 846.6 MHz; RX: 871.4 ~ 891.6 MHz
 UMTS-FDD Band II TX: 1852.4 ~ 1907.6 MHz;
 RX: 1932.4 ~ 1987.6 MHz
 LTE Band II TX: 1850.7~ 1909.3 MHz; RX : 1930.7 ~ 1989.3 MHz
 LTE Band IV TX: 1710.7 ~ 1754.3 MHz; RX : 2110.7 ~ 2154.3 MHz
 LTE Band VII TX: 2502.5 ~ 2567.5 MHz; RX : 2622.5 ~ 2687.5 MHz
 WIFI: 802.11b/g/n(20M): 2412-2462 MHz
 WIFI: 802.11n(40M): 2422-2452 MHz
 Bluetooth& BLE: 2402-2480 MHz
 GPS: 1575.42 MHz

Max. Output Power: 2.214dBm

Number of Channels:

GSM 850: 124CH
 PCS1900: 299CH
 UMTS-FDD Band V : 102CH
 UMTS-FDD Band II : 277CH
 WIFI :802.11b/g/n(20M): 11CH
 WIFI :802.11n(40M): 7CH
 Bluetooth: 79CH
 BLE: 40CH
 GPS:1CH

Port: USB Port, Earphone Port

Adapter:
 Model:A8-501000
 Input: AC100-240V~50/60Hz,200mA
 Output: DC 5.0V,1.0A
 Battery:
 Model:BL-28BT
 Spec:3.85V,10.78Wh,2800mAh
 Limited charge voltage:4.4V

5. Test Summary

The product was tested in accordance with the following specifications.

All testing has been performed according to below product classification:

FCC Rules	Description of Test	Result
§15.203	Antenna Requirement	Compliance
§15.247 (a)(2)	DTS (6 dB) CHANNEL BANDWIDTH	Compliance
§15.247(b)(3)	Conducted Maximum Output Power	Compliance
§15.247(e)	Power Spectral Density	Compliance
§15.247(d)	Band-Edge & Unwanted Emissions into Restricted Frequency Bands	Compliance
§15.207 (a),	AC Power Line Conducted Emissions	Compliance
§15.205, §15.209, §15.247(d)	Radiated Emissions & Unwanted Emissions into Restricted Frequency Bands	Compliance

Measurement Uncertainty

Emissions		
Test Item	Description	Uncertainty
Band-Edge & Unwanted Emissions into Restricted Frequency Bands and Radiated Emissions & Unwanted Emissions into Restricted Frequency Bands	Confidence level of approximately 95% (in the case where distributions are normal), with a coverage factor of 2 (for EUTs < 0.5m X 0.5m X 0.5m)	+5.6dB/-4.5dB
-	-	-

6. Measurements, Examination And Derived Results

6.1 Antenna Requirement

Applicable Standard

According to § 15.203, an intentional radiator shall be designed to ensure that no antenna other than that furnished by the responsible party shall be used with the device. The use of a permanently attached antenna or of an antenna that uses a unique coupling to the intentional radiator shall be considered sufficient to comply with the provisions of this section. The manufacturer may design the unit so that a broken antenna can be replaced by the user, but the user of a standard antenna jack or electrical connector is prohibited. The structure and application of the EUT were analyzed to determine compliance with section §15.203 of the rules. §15.203 state that the subject device must meet the following criteria:

- a. Antenna must be permanently attached to the unit.
- b. Antenna must use a unique type of connector to attach to the EUT.

Unit must be professionally installed, and installer shall be responsible for verifying that the correct antenna is employed with the unit.

And according to FCC 47 CFR section 15.247 (b), if the transmitting antennas of directional gain greater than 6dBi are used, the power shall be reduced by the amount in dB that the directional gain of the antenna exceeds 6 dBi.

Antenna Connector Construction

The EUT has 3 antennas:

A permanently attached PIFA antenna for Bluetooth/BLE/WIFI/GPS, the gain is 2.0dBi for Bluetooth/BLE and WIFI, 1.7dBi for GPS.

A permanently attached PIFA antenna for GSM/PCS/UMTS, the gain is -0.2dBi for GSM850, 1.7dBi for PCS1900, -0.2dBi for UMTS-FDD Band V, 1.7dBi for UMTS-FDD Band II.

A permanently attached PIFA antenna for LTE Band II/IV/VII, the gain is 1.7dBi for LTE Band II, the gain is 1.7dBi for LTE Band IV, the gain is 2.5dBi for LTE Band VII.

The antenna meets up with the ANTENNA REQUIREMENT.

Result: Compliance.

6.2 DTS (6 dB) Channel Bandwidth

Temperature	24oC
Relative Humidity	52%
Atmospheric Pressure	1007mbar
Test date :	April 10, 2017
Tested By :	Loren Luo

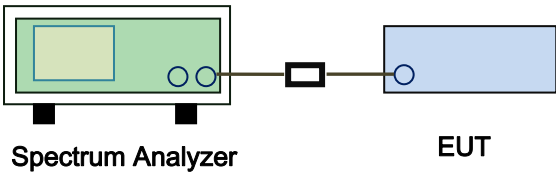
Spec	Item	Requirement	Applicable
§ 15.247(a)(2)	a)	6dB BW ≥ 500kHz;	<input checked="" type="checkbox"/>
RSS Gen(4.6.1)	b)	99% BW: For FCC reference only; required by IC.	<input checked="" type="checkbox"/>
Test Setup	 <p style="text-align: center;">Spectrum Analyzer EUT</p>		
Test Procedure	<p>558074 D01 DTS MEAS Guidance v03r03, 8.1 DTS bandwidth <u>6dB Emission bandwidth measurement procedure</u></p> <ul style="list-style-type: none"> - Set RBW = 100 kHz. - Set the video bandwidth (VBW) ≥ 3 RBW. - Detector = Peak. - Trace mode = max hold. - Sweep = auto couple. - Allow the trace to stabilize. <p>Measure the maximum width of the emission that is constrained by the frequencies associated with the two outermost amplitude points (upper and lower frequencies) that are attenuated by 6 dB relative to the maximum level measured in the fundamental emission.</p>		
Remark			
Result	<input checked="" type="checkbox"/> Pass <input type="checkbox"/> Fail		

Test Data Yes N/A

Test Plot Yes (See below) N/A

6dB Bandwidth measurement result

Test Data

CH	Frequency (MHz)	6dB Bandwidth (kHz)	99% Occupied Bandwidth (MHz)
Low	2402	729.114	1.0568
Mid	2440	717.366	1.0591
High	2480	716.267	1.0541

Test Plots

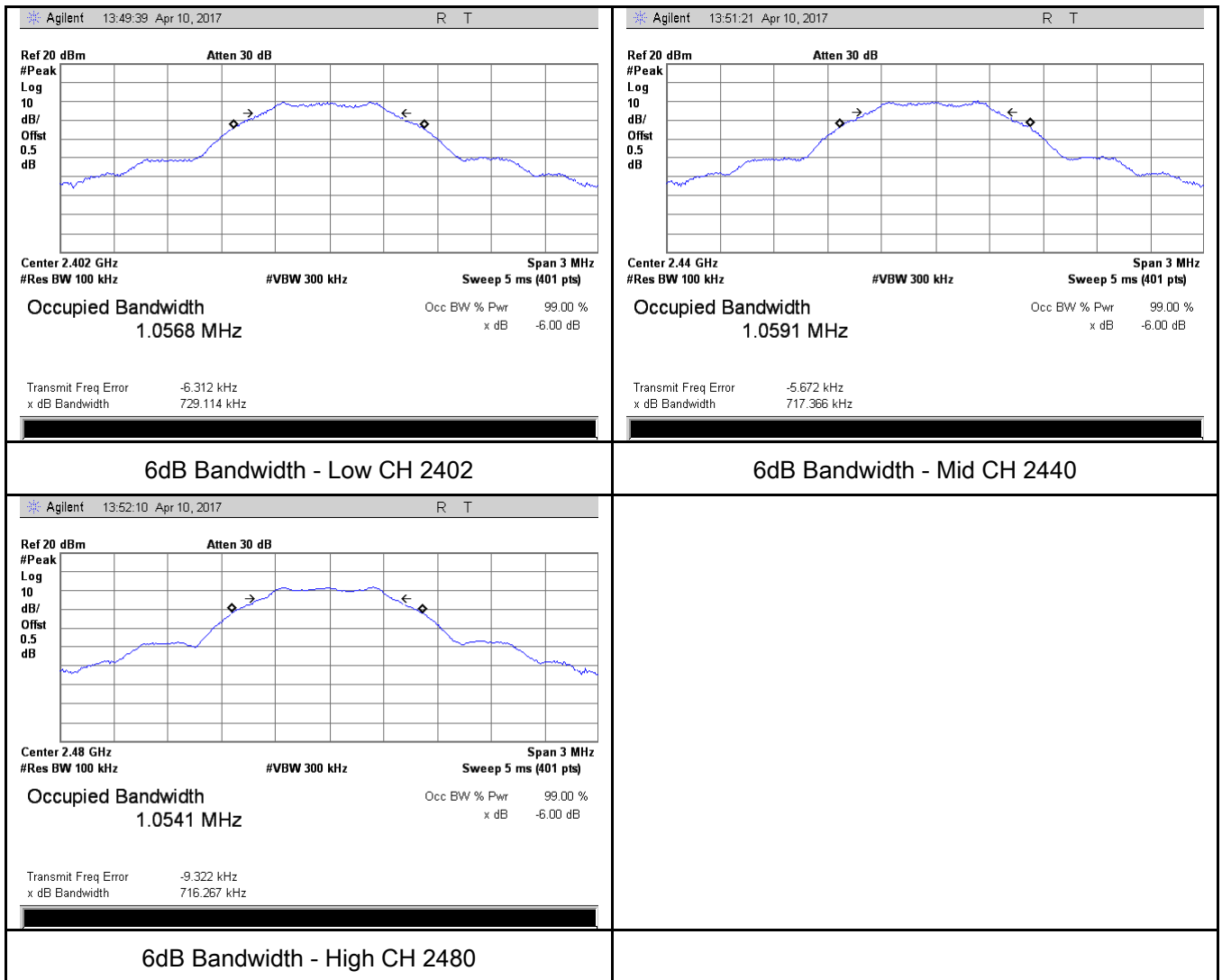

6.3 Maximum Output Power

Temperature	24oC
Relative Humidity	52%
Atmospheric Pressure	1007mbar
Test date :	April 10, 2017
Tested By :	Loren Luo

Requirement(s):

Spec	Item	Requirement	Applicable
§15.247(b) (3),RSS210 (A8.4)	a)	FHSS in 2400-2483.5MHz with ≥ 75 channels: ≤ 1 Watt	<input type="checkbox"/>
	b)	FHSS in 5725-5850MHz: ≤ 1 Watt	<input type="checkbox"/>
	c)	For all other FHSS in the 2400-2483.5MHz band: ≤ 0.125 Watt.	<input type="checkbox"/>
	d)	FHSS in 902-928MHz with ≥ 50 channels: ≤ 1 Watt	<input type="checkbox"/>
	e)	FHSS in 902-928MHz with ≥ 25 & <50 channels: ≤ 0.25 Watt	<input type="checkbox"/>
	f)	DTS in 902-928MHz, 2400-2483.5MHz: ≤ 1 Watt	<input checked="" type="checkbox"/>

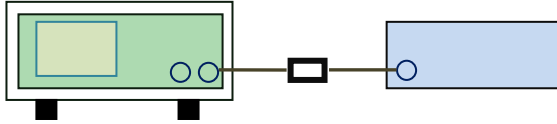
Test Setup	 <p style="text-align: center;">Spectrum Analyzer EUT</p>
------------	--

Test Procedure	<p>558074 D01 DTS MEAS Guidance v03r03, 9.1.2 Integrated band power method Maximum output power measurement procedure</p> <ol style="list-style-type: none"> Set the RBW \geq DTS bandwidth. Set VBW $\geq 3 \times$ RBW. Set span $\geq 3 \times$ RBW Sweep time = auto couple. Detector = peak. Trace mode = max hold. Allow trace to fully stabilize. Use peak marker function to determine the peak amplitude level.
----------------	---

Remark	
Result	<input checked="" type="checkbox"/> Pass <input type="checkbox"/> Fail

Test Data Yes N/A
 Test Plot Yes (See below) N/A

Output Power measurement result

Test Data

Type	CH	Frequency (MHz)	Conducted Power (dBm)	Limit (dBm)	Result
Output power	Low	2402	-0.540	30	Pass
	Mid	2440	-0.153	30	Pass
	High	2480	2.214	30	Pass

Test Plots

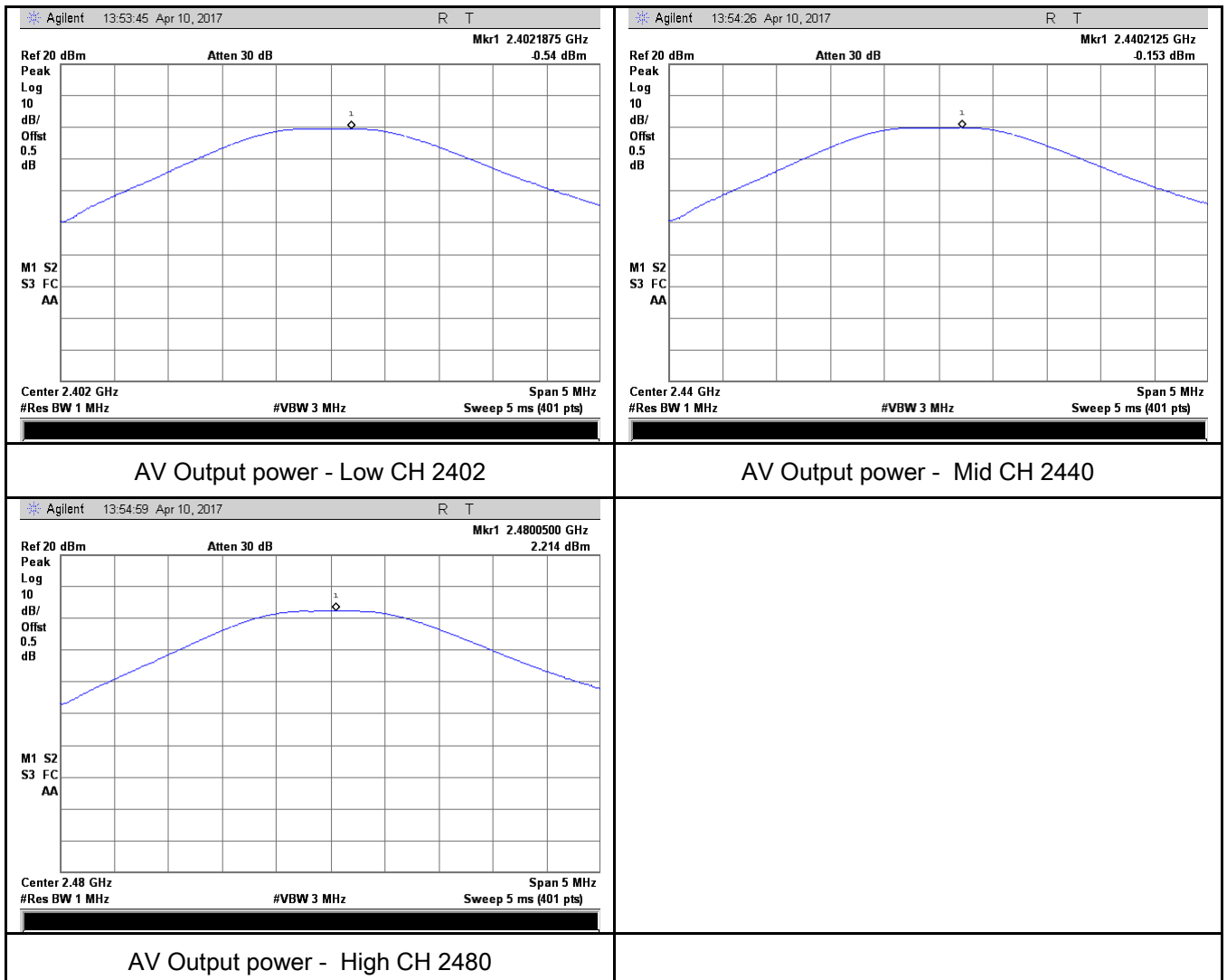

6.4 Power Spectral Density

Temperature	24oC
Relative Humidity	52%
Atmospheric Pressure	1007mbar
Test date :	April 10, 2017
Tested By :	Loren Luo

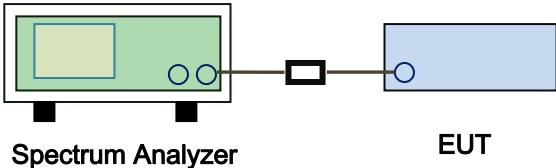
Spec	Item	Requirement	Applicable
§15.247(e)	a)	The power spectral density conducted from the intentional radiator to the antenna shall not be greater than 8 dBm in any 3 kHz band during any time interval of continuous transmission.	<input checked="" type="checkbox"/>
Test Setup	 <p style="text-align: center;">Spectrum Analyzer EUT</p>		
Test Procedure	<p>558074 D01 DTS MEAS Guidance v03r03, 10.2 power spectral density method power spectral density measurement procedure</p> <ul style="list-style-type: none"> - a) Set analyzer center frequency to DTS channel center frequency. - b) Set the span to 1.5 times the DTS bandwidth. - c) Set the RBW to: $3 \text{ kHz} \leq \text{RBW} \leq 100 \text{ kHz}$. - d) Set the VBW $\geq 3 \times \text{RBW}$. - e) Detector = peak. - f) Sweep time = auto couple. - g) Trace mode = max hold. - h) Allow trace to fully stabilize. - i) Use the peak marker function to determine the maximum amplitude level within the RBW. - j) If measured value exceeds limit, reduce RBW (no less than 3 kHz) and repeat. 		
Remark			
Result	<input checked="" type="checkbox"/> Pass <input type="checkbox"/> Fail		

Test Data Yes N/A
 Test Plot Yes (See below) N/A

Power Spectral Density measurement result

Test Data

Type	CH	Freq (MHz)	Reading (dBm)	Factor (dB)	Result (dBm)	Limit (dBm)	Result
PSD	Low	2402	-9.819	-5.23	-15.049	8	Pass
	Mid	2440	-9.484	-5.23	-14.714	8	Pass
	High	2480	-7.136	-5.23	-12.366	8	Pass

Note: factor=10log(3/10)=-5.23

Test Plots

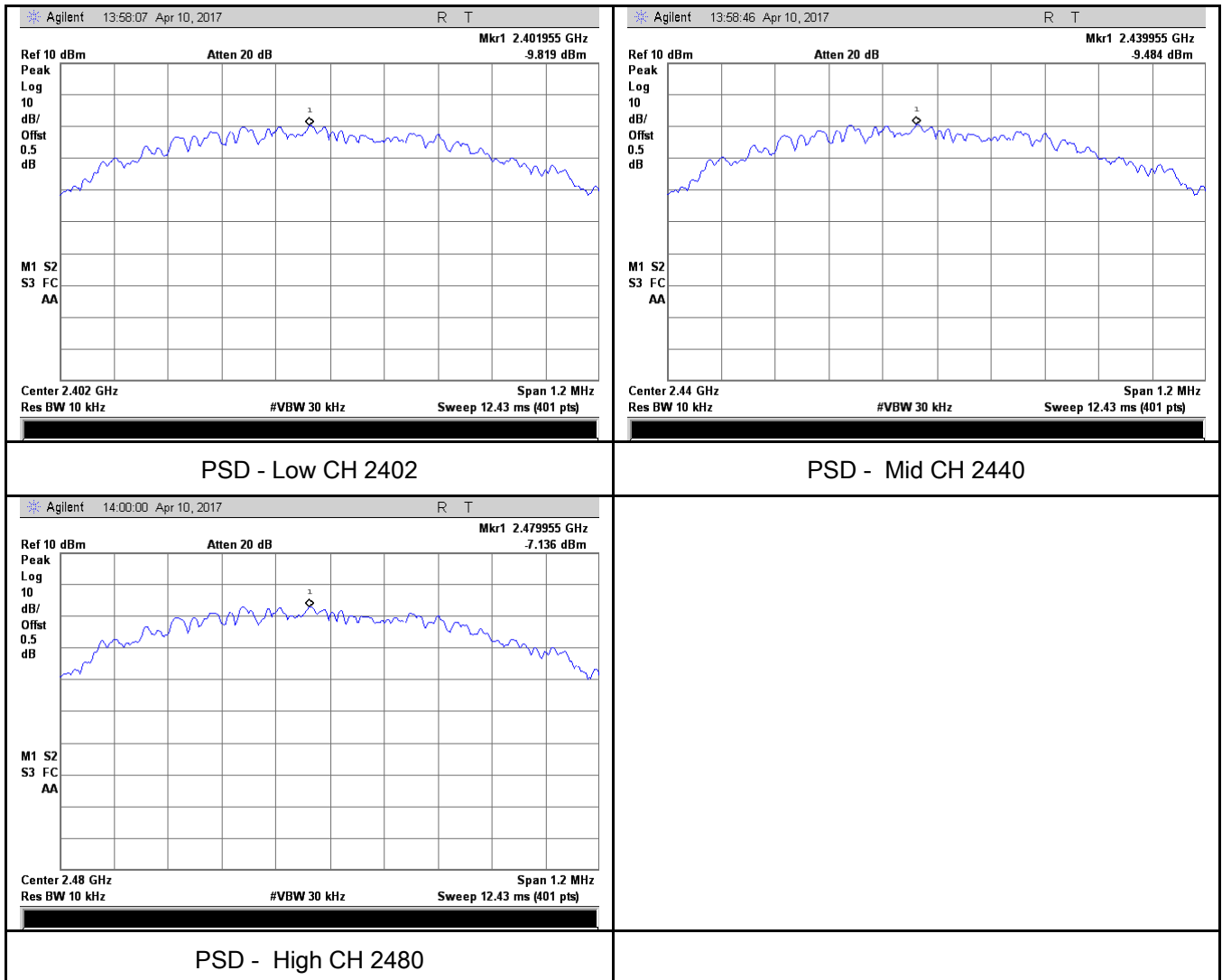

6.5 Band-Edge & Unwanted Emissions into Restricted Frequency Bands

Temperature	25°C
Relative Humidity	55%
Atmospheric Pressure	1023mbar
Test date :	March 29, 2017
Tested By :	Loren Luo

Requirement(s):

Spec	Item	Requirement	Applicable
§15.247(d)	a)	In any 100 kHz bandwidth outside the frequency band in which the spread spectrum or digitally modulated intentional radiator is operating, the radio frequency power that is produced by the intentional radiator shall be at least 20 dB below that in the 100 kHz bandwidth within the band that contains the highest level of the desired power, based on either an RF conducted or a radiated measurement, provided the transmitter demonstrates compliance with the peak conducted power limits.	<input checked="" type="checkbox"/>

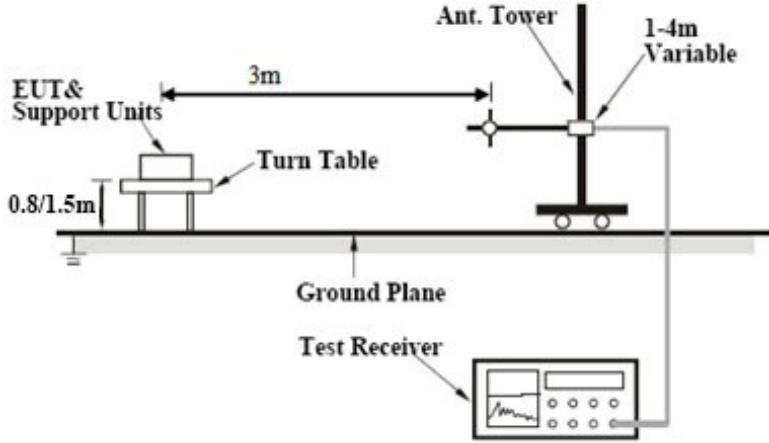
Test Setup	
------------	--

Test Procedure	<p>Radiated Method Only</p> <ul style="list-style-type: none"> - 1. Check the calibration of the measuring instrument using either an internal calibrator or a known signal from an external generator. - 2. Position the EUT without connection to measurement instrument. Put it on the Rotated table and turn on the EUT and make it operate in transmitting mode. Then set it to Low Channel and High Channel within its operating range, and make sure the instrument is operated in its linear range.
----------------	---

Test Report No.	17070226-FCC-R4
Page	18 of 50

	<ul style="list-style-type: none"> - 3. First, set both RBW and VBW of spectrum analyzer to 100 kHz with a convenient frequency span including 100kHz bandwidth from band edge, check the emission of EUT, if pass then set Spectrum Analyzer as below: <ul style="list-style-type: none"> a. The resolution bandwidth and video bandwidth of test receiver/spectrum analyzer is 120 kHz for Quasi Peak detection at frequency below 1GHz. b. The resolution bandwidth of test receiver/spectrum analyzer is 1MHz and video bandwidth is 3MHz with Peak detection for Peak measurement at frequency above 1GHz. c. The resolution bandwidth of test receiver/spectrum analyzer is 1MHz and the video bandwidth is 10Hz with Peak detection for Average Measurement as below at frequency above 1GHz. - 4. Measure the highest amplitude appearing on spectral display and set it as a reference level. Plot the graph with marking the highest point and edge frequency. - 5. Repeat above procedures until all measured frequencies were complete.
Remark	
Result	<input checked="" type="checkbox"/> Pass <input type="checkbox"/> Fail

Test Data Yes N/A
 Test Plot Yes (See below) N/A

Test Plots

Band Edge measurement result

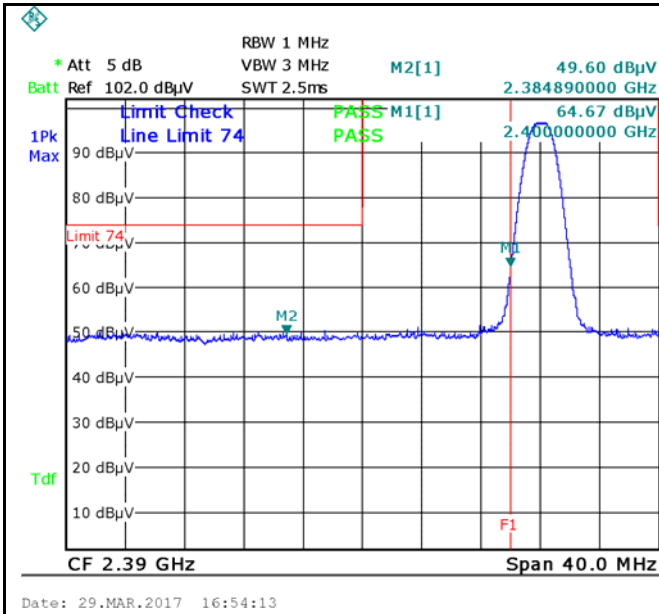

Band Edge, Left Side (Peak)

Note: F1 is frequency 2390MHz; F2 is frequency 2400MHz

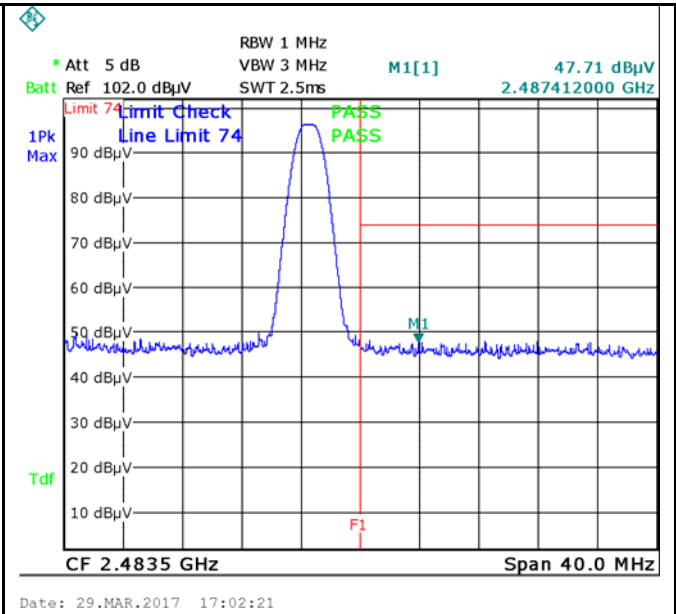

Band Edge, Right Side (Peak)

Note: F1 is frequency 2483.5MHz

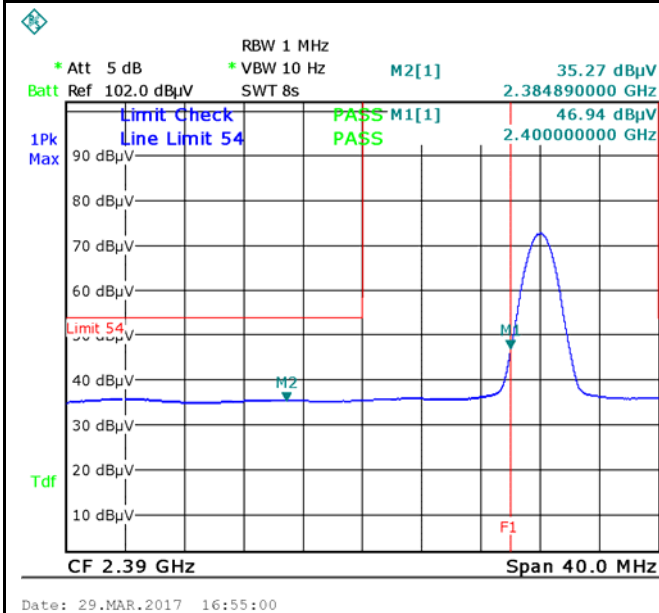

Band Edge, Left Side-AV

Note: (no need if PK value less than the AV limit)

Band Edge, Right Side-AV

6.6 AC Power Line Conducted Emissions

Temperature	25°C
Relative Humidity	55%
Atmospheric Pressure	1023mbar
Test date :	March 29, 2017
Tested By :	Loren Luo

Requirement(s):

Spec	Item	Requirement	Applicable														
47CFR§15.207, RSS210 (A8.1)	a)	For Low-power radio-frequency devices that is designed to be connected to the public utility (AC) power line, the radio frequency voltage that is conducted back onto the AC power line on any frequency or frequencies, within the band 150 kHz to 30 MHz, shall not exceed the limits in the following table, as measured using a 50 [μ] H/50 ohms line impedance stabilization network (LISN). The lower limit applies at the boundary between the frequencies ranges.	<input checked="" type="checkbox"/>														
		<table border="1"> <thead> <tr> <th rowspan="2">Frequency ranges (MHz)</th> <th colspan="2">Limit (dBμV)</th> </tr> <tr> <th>QP</th> <th>Average</th> </tr> </thead> <tbody> <tr> <td>0.15 ~ 0.5</td> <td>66 – 56</td> <td>56 – 46</td> </tr> <tr> <td>0.5 ~ 5</td> <td>56</td> <td>46</td> </tr> <tr> <td>5 ~ 30</td> <td>60</td> <td>50</td> </tr> </tbody> </table>		Frequency ranges (MHz)	Limit (dBμV)		QP	Average	0.15 ~ 0.5	66 – 56	56 – 46	0.5 ~ 5	56	46	5 ~ 30	60	50
		Frequency ranges (MHz)			Limit (dBμV)												
				QP	Average												
0.15 ~ 0.5	66 – 56	56 – 46															
0.5 ~ 5	56	46															
5 ~ 30	60	50															

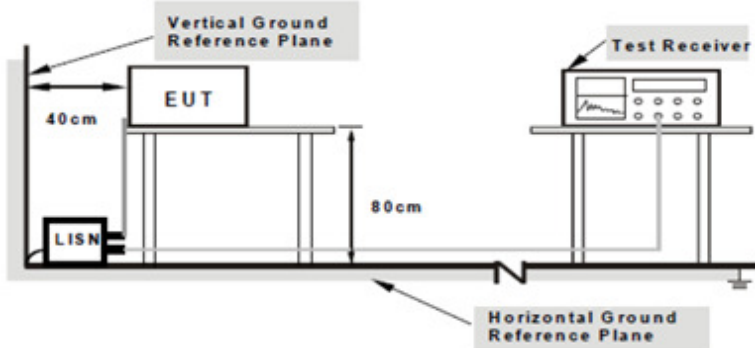
Test Setup	 <p style="text-align: center;"> Note: 1.Support units were connected to second LISN. 2.Both of LISNs (AMN) are 80cm from EUT and at least 80cm from other units and other metal planes support units. </p>
------------	---

Procedure	<ol style="list-style-type: none"> The EUT and supporting equipment were set up in accordance with the requirements of the standard on top of a 1.5m x 1m x 0.8m high, non-metallic table. The power supply for the EUT was fed through a 50W/50mH EUT LISN, connected to filtered mains. The RF OUT of the EUT LISN was connected to the EMI test receiver via a low-loss
-----------	---

Test Report No.	17070226-FCC-R4
Page	21 of 50

	<p>coaxial cable.</p> <ol style="list-style-type: none"> 4. All other supporting equipment were powered separately from another main supply. 5. The EUT was switched on and allowed to warm up to its normal operating condition. 6. A scan was made on the NEUTRAL line (for AC mains) or Earth line (for DC power) over the required frequency range using an EMI test receiver. 7. High peaks, relative to the limit line, The EMI test receiver was then tuned to the selected frequencies and the necessary measurements made with a receiver bandwidth setting of 10 kHz. 8. Step 7 was then repeated for the LIVE line (for AC mains) or DC line (for DC power).
Remark	
Result	<input checked="" type="checkbox"/> Pass <input type="checkbox"/> Fail

Test Data Yes N/A

Test Plot Yes (See below) N/A

Test Mode:	Transmitting Mode
-------------------	--------------------------

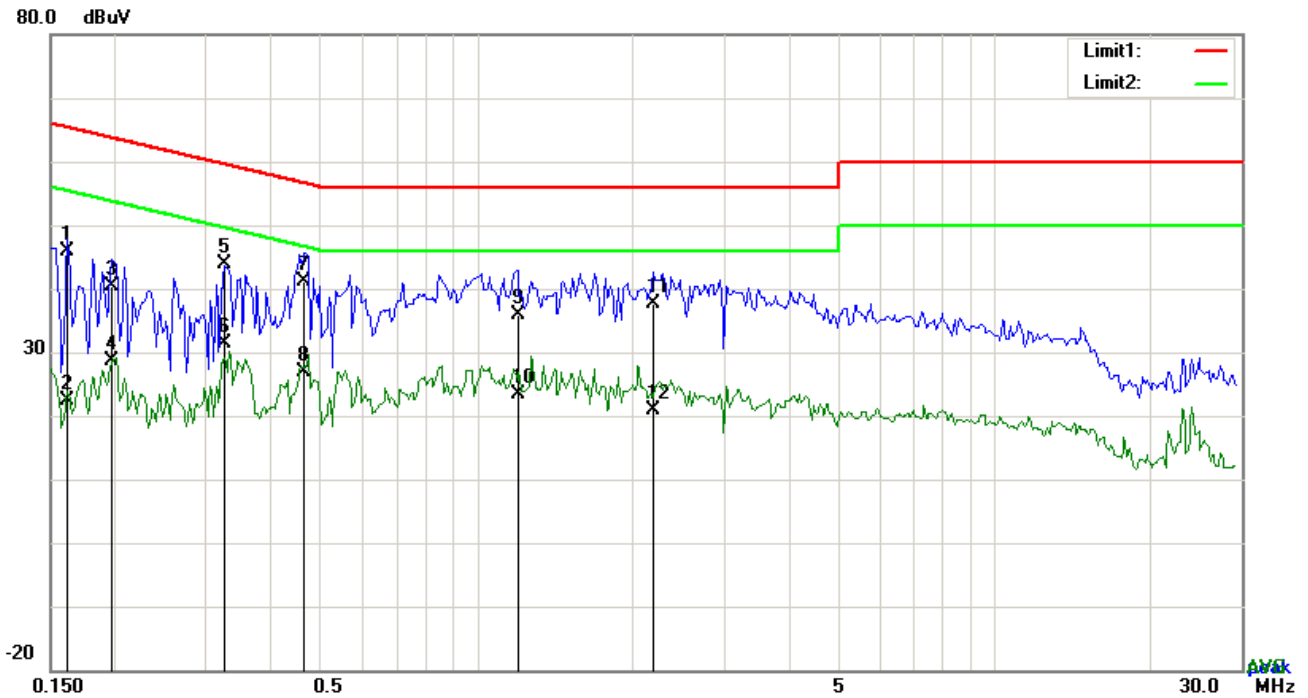

Test Data

Phase Line Plot at 120Vac, 60Hz

No.	P/L	Frequency (MHz)	Reading (dBµV)	Detector	Corrected (dB)	Result (dBµV)	Limit (dBµV)	Margin (dB)
1	L1	0.1617	35.80	QP	10.03	45.83	65.38	-19.55
2	L1	0.1617	12.44	AVG	10.03	22.47	55.38	-32.91
3	L1	0.1968	30.44	QP	10.03	40.47	63.74	-23.27
4	L1	0.1968	18.55	AVG	10.03	28.58	53.74	-25.16
5	L1	0.3255	33.74	QP	10.03	43.77	59.57	-15.80
6	L1	0.3255	21.45	AVG	10.03	31.48	49.57	-18.09
7	L1	0.4659	31.18	QP	10.03	41.21	56.59	-15.38
8	L1	0.4659	16.76	AVG	10.03	26.79	46.59	-19.80
9	L1	1.1991	25.82	QP	10.03	35.85	56.00	-20.15
10	L1	1.1991	13.34	AVG	10.03	23.37	46.00	-22.63
11	L1	2.2014	27.58	QP	10.05	37.63	56.00	-18.37
12	L1	2.2014	10.94	AVG	10.05	20.99	46.00	-25.01

Test Mode:	Transmitting Mode
-------------------	--------------------------

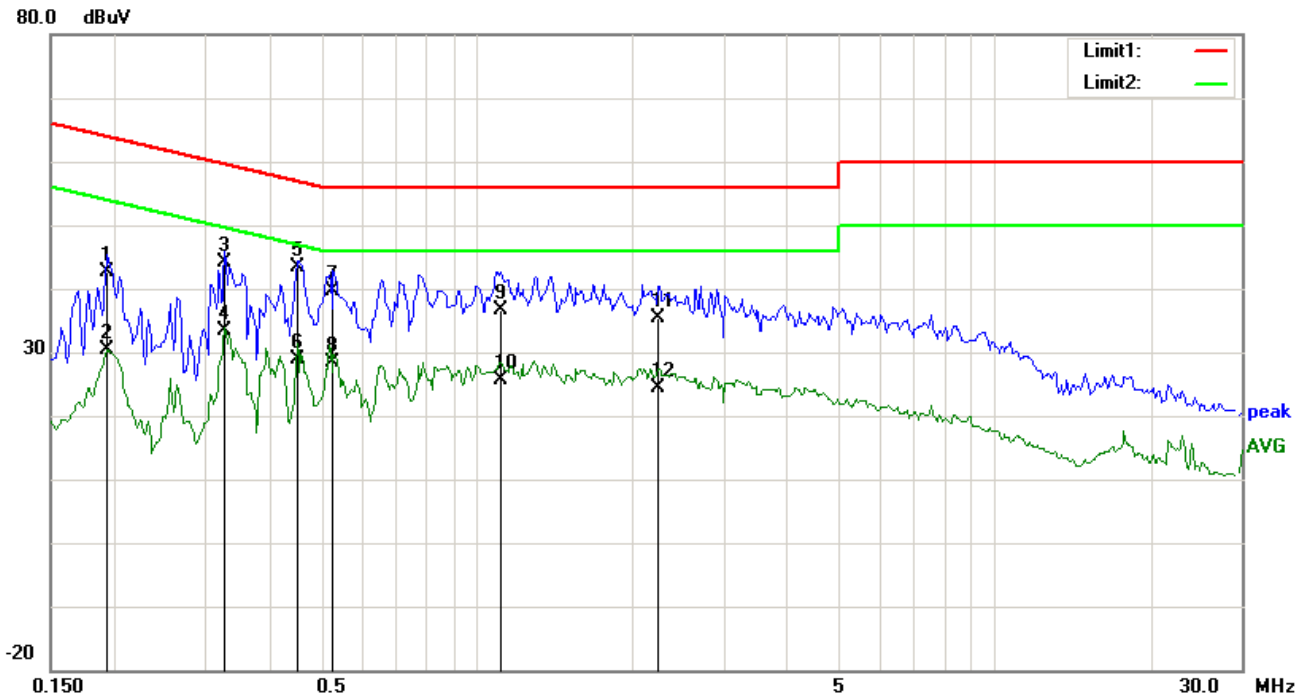

Test Data

Phase Neutral Plot at 120Vac, 60Hz

No.	P/L	Frequency (MHz)	Reading (dBuV)	Detector	Corrected (dB)	Result (dBuV)	Limit (dBuV)	Margin (dB)
1	N	0.1929	32.49	QP	10.02	42.51	63.91	-21.40
2	N	0.1929	20.43	AVG	10.02	30.45	53.91	-23.46
3	N	0.3255	34.05	QP	10.02	44.07	59.57	-15.50
4	N	0.3255	23.29	AVG	10.02	33.31	49.57	-16.26
5	N	0.4503	33.45	QP	10.02	43.47	56.87	-13.40
6	N	0.4503	18.84	AVG	10.02	28.86	46.87	-18.01
7	N	0.5283	29.61	QP	10.02	39.63	56.00	-16.37
8	N	0.5283	18.39	AVG	10.02	28.41	46.00	-17.59
9	N	1.1133	26.57	QP	10.03	36.60	56.00	-19.40
10	N	1.1133	15.65	AVG	10.03	25.68	46.00	-20.32
11	N	2.2482	25.31	QP	10.04	35.35	56.00	-20.65
12	N	2.2482	14.26	AVG	10.04	24.30	46.00	-21.70

Test Mode:	Transmitting Mode
-------------------	--------------------------

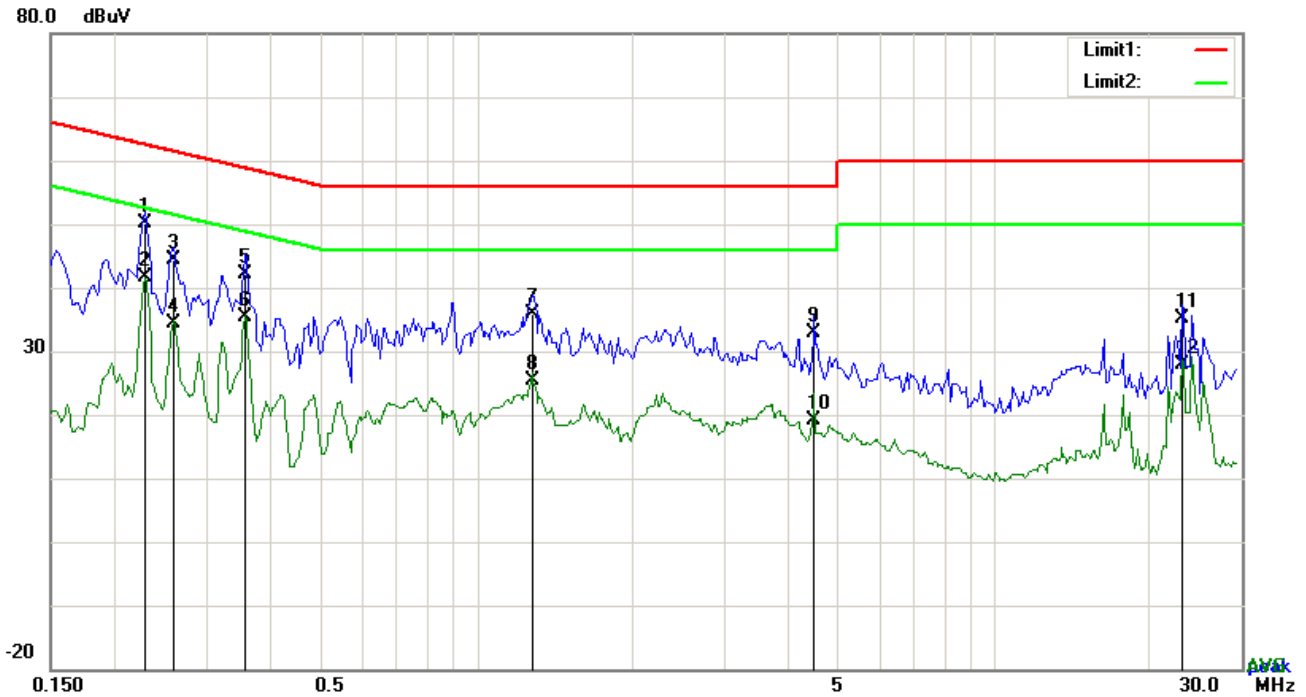

Test Data

Phase Line Plot at 240Vac, 60Hz

No.	P/L	Frequency (MHz)	Reading (dBμV)	Detector	Corrected (dB)	Result (dBμV)	Limit (dBμV)	Margin (dB)
1	L1	0.2280	40.18	QP	10.03	50.21	62.52	-12.31
2	L1	0.2280	31.67	AVG	10.03	41.70	52.52	-10.82
3	L1	0.2592	34.24	QP	10.03	44.27	61.46	-17.19
4	L1	0.2592	24.24	AVG	10.03	34.27	51.46	-17.19
5	L1	0.3567	32.21	QP	10.03	42.24	58.80	-16.56
6	L1	0.3567	25.24	AVG	10.03	35.27	48.80	-13.53
7	L1	1.2810	25.97	QP	10.03	36.00	56.00	-20.00
8	L1	1.2810	15.24	AVG	10.03	25.27	46.00	-20.73
9	L1	4.4859	22.71	QP	10.07	32.78	56.00	-23.22
10	L1	4.4859	9.12	AVG	10.07	19.19	46.00	-26.81
11	L1	23.1318	24.79	QP	10.36	35.15	60.00	-24.85
12	L1	23.1318	17.58	AVG	10.36	27.94	50.00	-22.06

Test Mode:	Transmitting Mode
-------------------	--------------------------

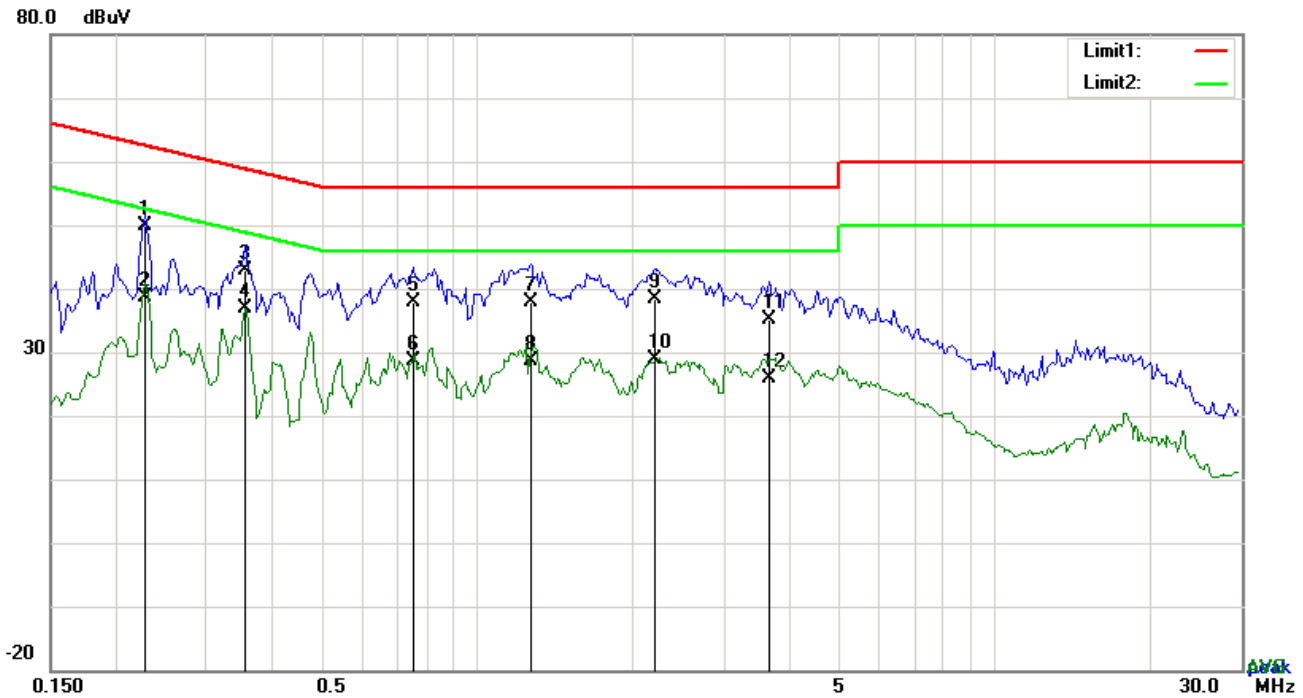

Test Data

Phase Neutral Plot at 240Vac, 60Hz

No.	P/L	Frequency (MHz)	Reading (dBuV)	Detector	Corrected (dB)	Result (dBuV)	Limit (dBuV)	Margin (dB)
1	N	0.2280	39.85	QP	10.02	49.87	62.52	-12.65
2	N	0.2280	28.50	AVG	10.02	38.52	52.52	-14.00
3	N	0.3567	32.83	QP	10.02	42.85	58.80	-15.95
4	N	0.3567	26.93	AVG	10.02	36.95	48.80	-11.85
5	N	0.7545	27.85	QP	10.03	37.88	56.00	-18.12
6	N	0.7545	18.51	AVG	10.03	28.54	46.00	-17.46
7	N	1.2732	27.86	QP	10.03	37.89	56.00	-18.11
8	N	1.2732	18.49	AVG	10.03	28.52	46.00	-17.48
9	N	2.2131	28.41	QP	10.04	38.45	56.00	-17.55
10	N	2.2131	18.75	AVG	10.04	28.79	46.00	-17.21
11	N	3.6708	24.96	QP	10.06	35.02	56.00	-20.98
12	N	3.6708	15.80	AVG	10.06	25.86	46.00	-20.14

6.7 Radiated Emissions & Restricted Band

Temperature	25°C
Relative Humidity	55%
Atmospheric Pressure	1023mbar
Test date :	March 29, 2017
Tested By :	Loren Luo

Requirement(s):

Spec	Item	Requirement	Applicable										
47CFR§15.247(d), RSS210 (A8.5)	a)	<p>Except higher limit as specified elsewhere in other section, the emissions from the low-power radio-frequency devices shall not exceed the field strength levels specified in the following table and the level of any unwanted emissions shall not exceed the level of the fundamental emission. The tighter limit applies at the band edges</p> <table border="1"> <thead> <tr> <th>Frequency range (MHz)</th> <th>Field Strength (µV/m)</th> </tr> </thead> <tbody> <tr> <td>30 – 88</td> <td>100</td> </tr> <tr> <td>88 – 216</td> <td>150</td> </tr> <tr> <td>216 - 960</td> <td>200</td> </tr> <tr> <td>Above 960</td> <td>500</td> </tr> </tbody> </table>	Frequency range (MHz)	Field Strength (µV/m)	30 – 88	100	88 – 216	150	216 - 960	200	Above 960	500	<input checked="" type="checkbox"/>
	Frequency range (MHz)	Field Strength (µV/m)											
	30 – 88	100											
88 – 216	150												
216 - 960	200												
Above 960	500												
b)	<p>For non-restricted band, In any 100 kHz bandwidth outside the frequency band in which the spread spectrum or digitally modulated intentional radiator is operating, the radio frequency power that is produced by the intentional radiator shall be at least 20 dB or 30dB below that in the 100 kHz bandwidth within the band that contains the highest level of the desired power, determined by the measurement method on output power to be used. Attenuation below the general limits specified in § 15.209(a) is not required</p> <p><input checked="" type="checkbox"/> 20 dB down <input type="checkbox"/> 30 dB down</p>	<input checked="" type="checkbox"/>											
c)	<p>or restricted band, emission must also comply with the radiated emission limits specified in 15.209</p>	<input checked="" type="checkbox"/>											

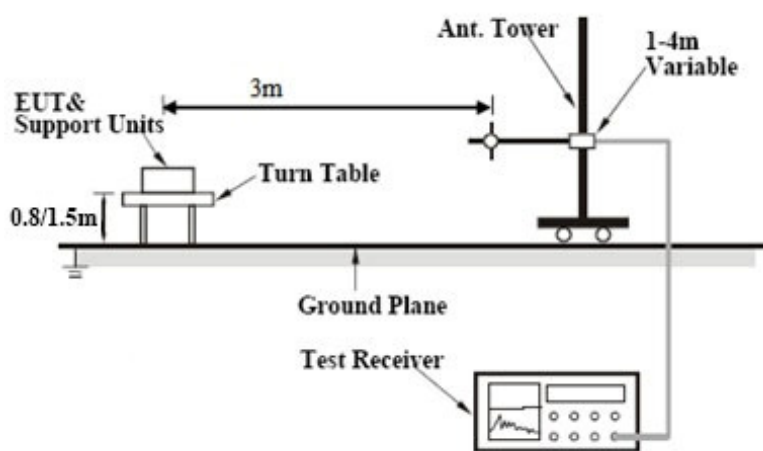
<p>Test Setup</p>	
<p>Procedure</p>	<ol style="list-style-type: none"> 1. The EUT was switched on and allowed to warm up to its normal operating condition. 2. The test was carried out at the selected frequency points obtained from the EUT characterization. Maximization of the emissions, was carried out by rotating the EUT, changing the antenna polarization, and adjusting the antenna height in the following manner: <ol style="list-style-type: none"> a. Vertical or horizontal polarization (whichever gave the higher emission level over a full rotation of the EUT) was chosen. b. The EUT was then rotated to the direction that gave the maximum emission. c. Finally, the antenna height was adjusted to the height that gave the maximum emission. 3. The resolution bandwidth and video bandwidth of test receiver/spectrum analyzer is 120 kHz for Quasiy Peak detection at frequency below 1GHz. 4. The resolution bandwidth of test receiver/spectrum analyzer is 1MHz and video bandwidth is 3MHz with Peak detection for Peak measurement at frequency above 1GHz. The resolution bandwidth of test receiver/spectrum analyzer is 1MHz and the video bandwidth is 10Hz with Peak detection for Average Measurement as below at frequency above 1GHz. 5. Steps 2 and 3 were repeated for the next frequency point, until all selected frequency points were measured.
<p>Remark</p>	<p>Different RF configuration has been evaluated but not much difference was found. The data presented here is the worst case data with EUT under 802.11n – HT20-2437MHz mode.</p>
<p>Result</p>	<p><input checked="" type="checkbox"/> Pass <input type="checkbox"/> Fail</p>

Test Data Yes N/A
 Test Plot Yes (See below) N/A

Test Mode:	Transmitting Mode
-------------------	--------------------------

Below 1GHz

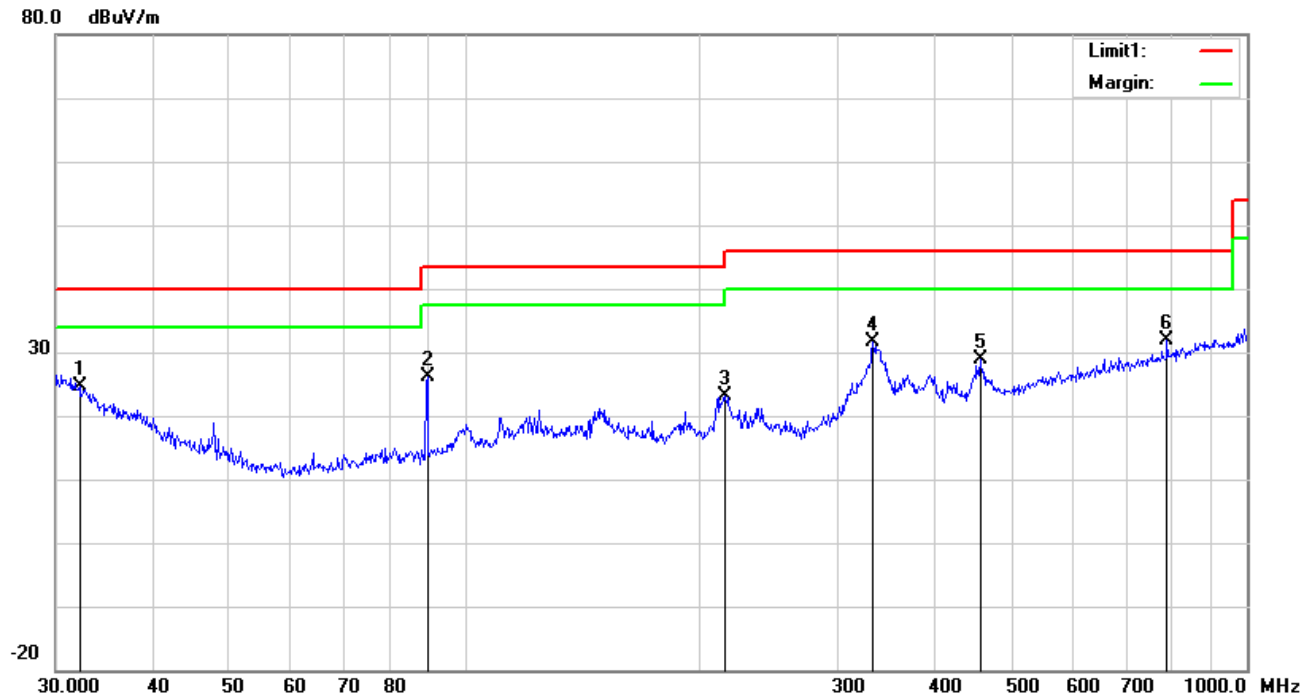

Test Data

Horizontal Polarity Plot @3m

No.	P/L	Frequency (MHz)	Reading (dBuV/m)	Detect or	Ant_F (dB/m)	PA_G (dB)	Cab_L (dB)	Result (dBuV/m)	Limit (dBuV/m)	Margin (dB)	Height (cm)	Degr ee (°)
1	H	32.1795	26.38	peak	19.72	22.27	0.68	24.51	40.00	-15.49	100	331
2	H	89.5900	39.42	peak	7.98	22.32	0.96	26.04	43.50	-17.46	100	326
3	H	215.2678	32.06	peak	11.89	22.35	1.59	23.19	43.50	-20.31	100	73
4	H	332.5187	37.59	peak	14.28	22.20	1.95	31.62	46.00	-14.38	100	100
5	H	455.9058	31.73	peak	16.82	21.90	2.16	28.81	46.00	-17.19	100	64
6	H	790.6188	28.84	peak	21.29	21.17	2.94	31.90	46.00	-14.10	100	143

Below 1GHz

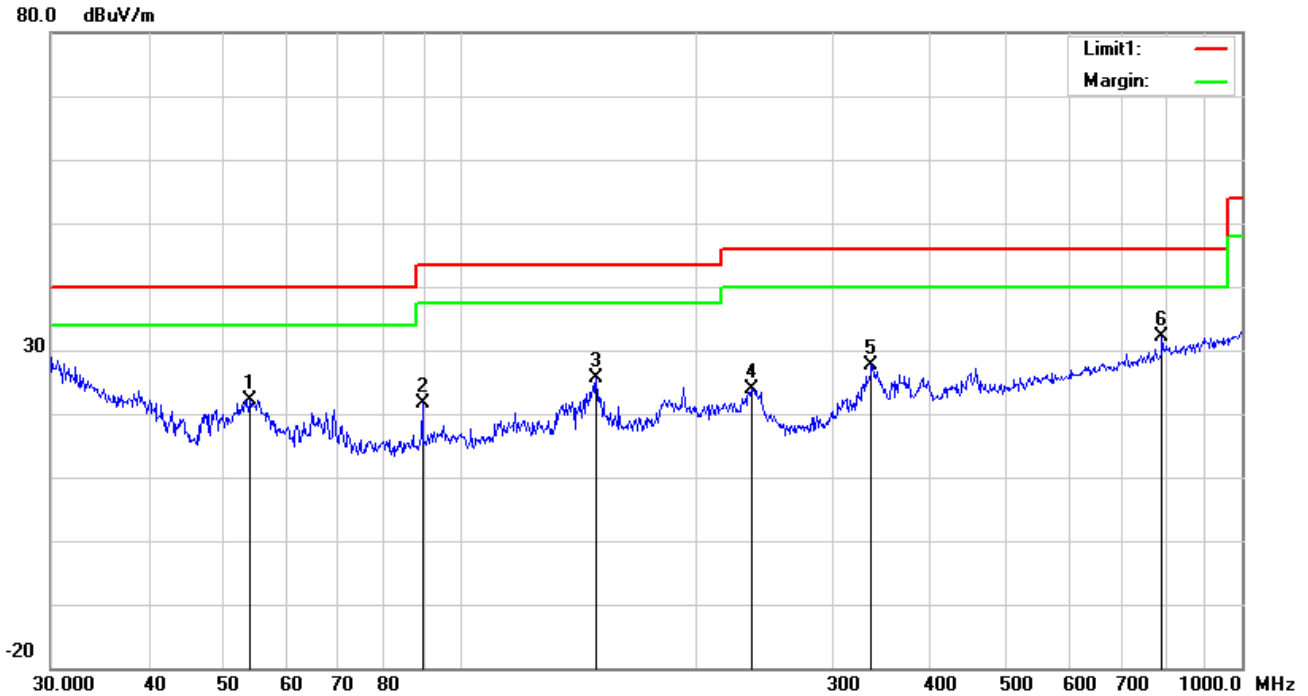

Test Data

Vertical Polarity Plot @3m

No.	P/L	Frequency (MHz)	Reading (dBuV/m)	Detect or	Ant_F (dB/m)	PA_G (dB)	Cab_L (dB)	Result (dBuV/m)	Limit (dBuV/m)	Margin (dB)	Height (cm)	Degr ee (°)
1	V	53.8818	35.85	peak	7.97	22.39	0.78	22.21	40.00	-17.79	100	28
2	V	89.5900	34.96	peak	7.98	22.32	0.96	21.58	43.50	-21.92	100	153
3	V	149.4857	33.98	peak	12.60	22.34	1.34	25.58	43.50	-17.92	100	312
4	V	235.8164	32.96	peak	11.60	22.32	1.65	23.89	46.00	-22.11	100	261
5	V	336.0352	33.47	peak	14.36	22.19	1.97	27.61	46.00	-18.39	100	261
6	V	790.6188	29.14	peak	21.29	21.17	2.94	32.20	46.00	-13.80	100	330

Above 1GHz

Test Mode:	Transmitting Mode
-------------------	--------------------------

Low Channel (2402 MHz)

Frequency (MHz)	S.A. Reading (dB μ V)	Detector (PK/AV)	Polarity (H/V)	Ant. Factor (dB/m)	Cable Loss (dB)	Pre-Amp. Gain (dB)	Cord. Amp. (dB μ V/m)	Limit (dB μ V/m)	Margin (dB)
4804	38.37	AV	V	33.83	6.86	31.72	47.34	54	-6.66
4804	38.27	AV	H	33.83	6.86	31.72	47.24	54	-6.76
4804	48.84	PK	V	33.83	6.86	31.72	57.81	74	-16.19
4804	47.7	PK	H	33.83	6.86	31.72	56.67	74	-17.33
17792	23.85	AV	V	45.03	11.21	32.38	47.71	54	-6.29
17792	24.61	AV	H	45.03	11.21	32.38	48.47	54	-5.53
17792	40.98	PK	V	45.03	11.21	32.38	64.84	74	-9.16
17792	40.43	PK	H	45.03	11.21	32.38	64.29	74	-9.71

Middle Channel (2440 MHz)

Frequency (MHz)	S.A. Reading (dB μ V)	Detector (PK/AV)	Polarity (H/V)	Ant. Factor (dB/m)	Cable Loss (dB)	Pre-Amp. Gain (dB)	Cord. Amp. (dB μ V/m)	Limit (dB μ V/m)	Margin (dB)
4880	38.26	AV	V	33.86	6.82	31.82	47.12	54	-6.88
4880	37.86	AV	H	33.86	6.82	31.82	46.72	54	-7.28
4880	47.8	PK	V	33.86	6.82	31.82	56.66	74	-17.34
4880	47.95	PK	H	33.86	6.82	31.82	56.81	74	-17.19
17809	24.16	AV	V	45.15	11.18	32.41	48.08	54	-5.92
17809	24.25	AV	H	45.15	11.18	32.41	48.17	54	-5.83
17809	41.91	PK	V	45.15	11.18	32.41	65.83	74	-8.17
17809	40.26	PK	H	45.15	11.18	32.41	64.18	74	-9.82

High Channel (2480 MHz)

Frequency (MHz)	S.A. Reading (dB μ V)	Detector (PK/AV)	Polarity (H/V)	Ant. Factor (dB/m)	Cable Loss (dB)	Pre-Amp. Gain (dB)	Cord. Amp. (dB μ V/m)	Limit (dB μ V/m)	Margin (dB)
4960	38.93	AV	V	33.9	6.76	31.92	47.67	54	-6.33
4960	38.23	AV	H	33.9	6.76	31.92	46.97	54	-7.03
4960	48.4	PK	V	33.9	6.76	31.92	57.14	74	-16.86
4960	47.32	PK	H	33.9	6.76	31.92	56.06	74	-17.94
17797	25.05	AV	V	45.22	11.35	32.38	49.24	54	-4.76
17797	24.64	AV	H	45.22	11.35	32.38	48.83	54	-5.17
17797	41.63	PK	V	45.22	11.35	32.38	65.82	74	-8.18
17797	40.64	PK	H	45.22	11.35	32.38	64.83	74	-9.17

Note:

- 1, The testing has been conformed to 10*2480MHz=24,800MHz
- 2, All other emissions more than 30 dB below the limit
- 3, X-Axis, Y-Axis and Z-Axis were investigated. The results above show only the worst case.

Annex A. TEST INSTRUMENT

Instrument	Model	Serial #	Cal Date	Cal Due	In use
AC Line Conducted					
EMI test receiver	ESCS30	8471241027	09/16/2016	09/15/2017	<input checked="" type="checkbox"/>
Line Impedance	LI-125A	191106	09/24/2016	09/23/2017	<input checked="" type="checkbox"/>
Line Impedance	LI-125A	191107	09/24/2016	09/23/2017	<input checked="" type="checkbox"/>
LISN	ISN T800	34373	09/24/2016	09/23/2017	<input checked="" type="checkbox"/>
Double Ridge Horn Antenna (1 ~18GHz)	AH-118	71283	09/23/2016	09/22/2017	<input checked="" type="checkbox"/>
Transient Limiter	LIT-153	531118	08/31/2016	08/30/2017	<input checked="" type="checkbox"/>
RF conducted test					
Agilent ESA-E SERIES	E4407B	MY45108319	09/16/2016	09/15/2017	<input checked="" type="checkbox"/>
Power Splitter	1#	1#	08/31/2016	08/30/2017	<input checked="" type="checkbox"/>
DC Power Supply	E3640A	MY40004013	09/16/2016	09/15/2017	<input checked="" type="checkbox"/>
Radiated Emissions					
EMI test receiver	ESL6	100262	09/16/2016	09/15/2017	<input checked="" type="checkbox"/>
Positioning Controller	UC3000	MF780208282	11/18/2016	11/17/2017	<input checked="" type="checkbox"/>
OPT 010 AMPLIFIER (0.1-1300MHz)	8447E	2727A02430	08/31/2016	08/30/2017	<input checked="" type="checkbox"/>
Microwave Preamplifier (1 ~ 26.5GHz)	8449B	3008A02402	03/23/2017	03/22/2018	<input checked="" type="checkbox"/>
Bilog Antenna (30MHz~6GHz)	JB6	A110712	09/20/2016	09/19/2017	<input checked="" type="checkbox"/>
Double Ridge Horn Antenna (1 ~18GHz)	AH-118	71283	09/23/2016	09/22/2017	<input checked="" type="checkbox"/>
Universal Radio Communication Tester	CMU200	121393	09/24/2016	09/23/2017	<input checked="" type="checkbox"/>

Annex B. EUT And Test Setup Photographs

Annex B.i. Photograph: EUT External Photo

Whole Package View



Adapter - Label View



EUT - Front View



EUT - Rear View



EUT - Top View



EUT - Bottom View

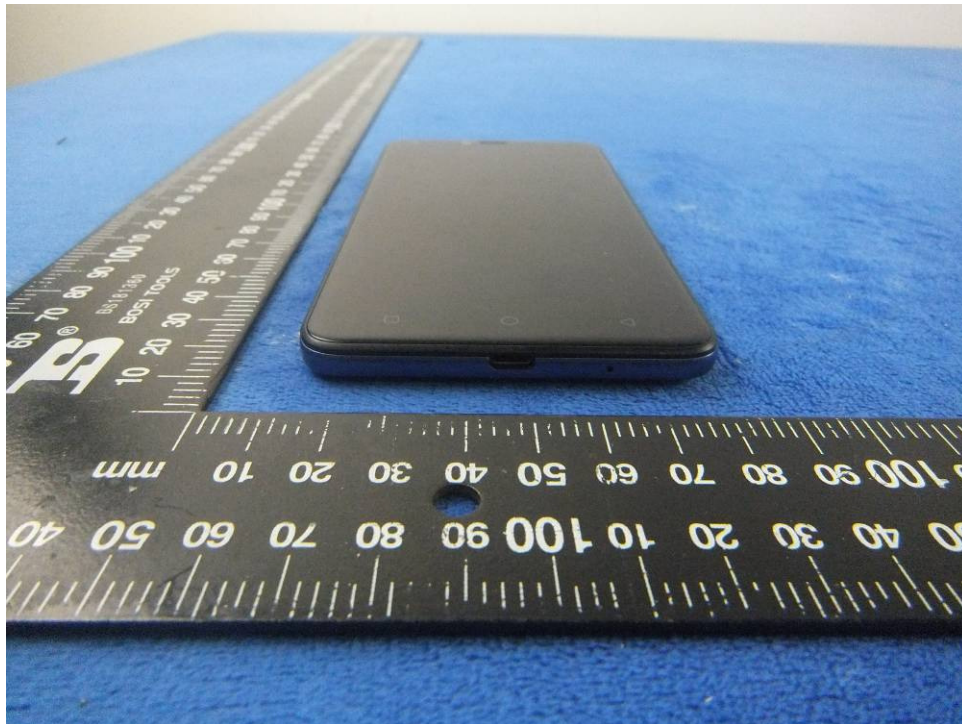

EUT - Left View



EUT - Right View

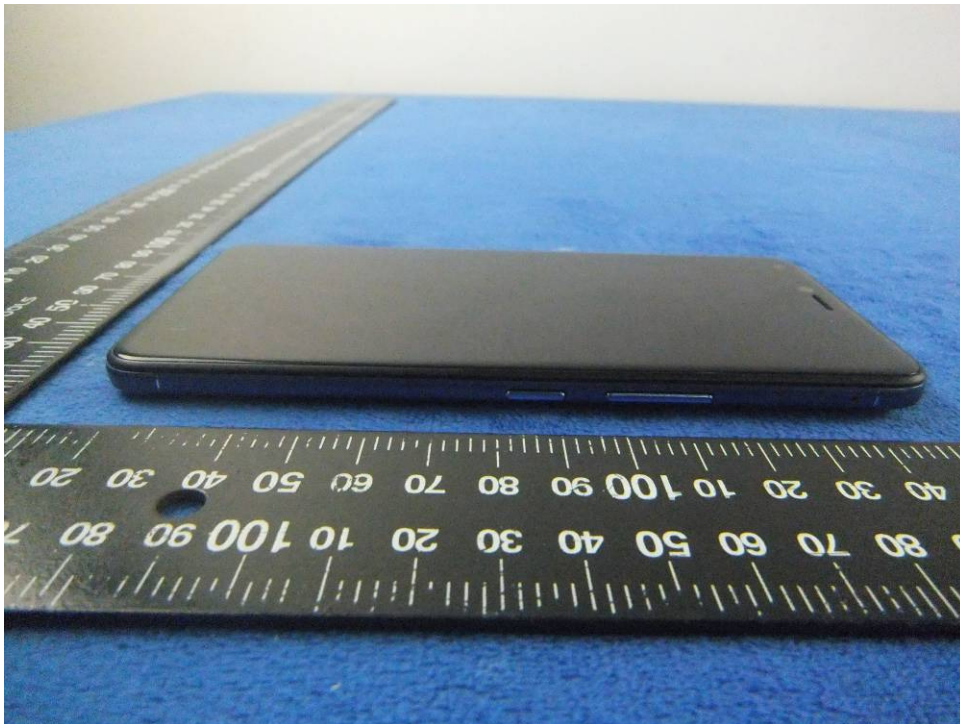

Annex B.ii. Photograph: EUT Internal Photo

Cover Off - Top View 1



Cover Off - Top View 2



Battery - Front View

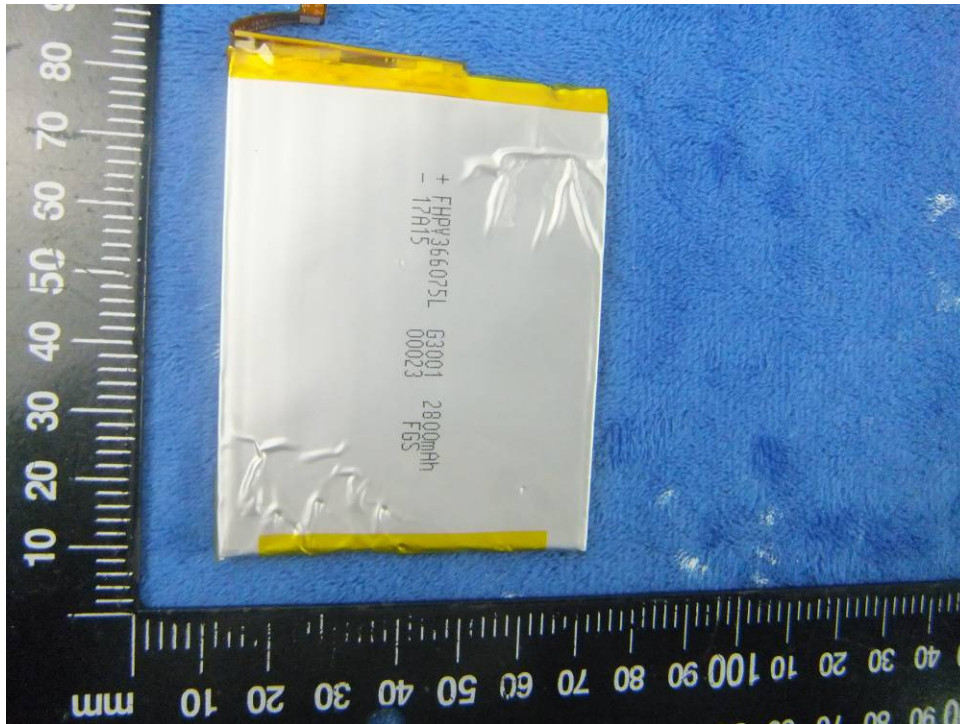

Battery - Rear View



Mainboard with Shielding - Front View

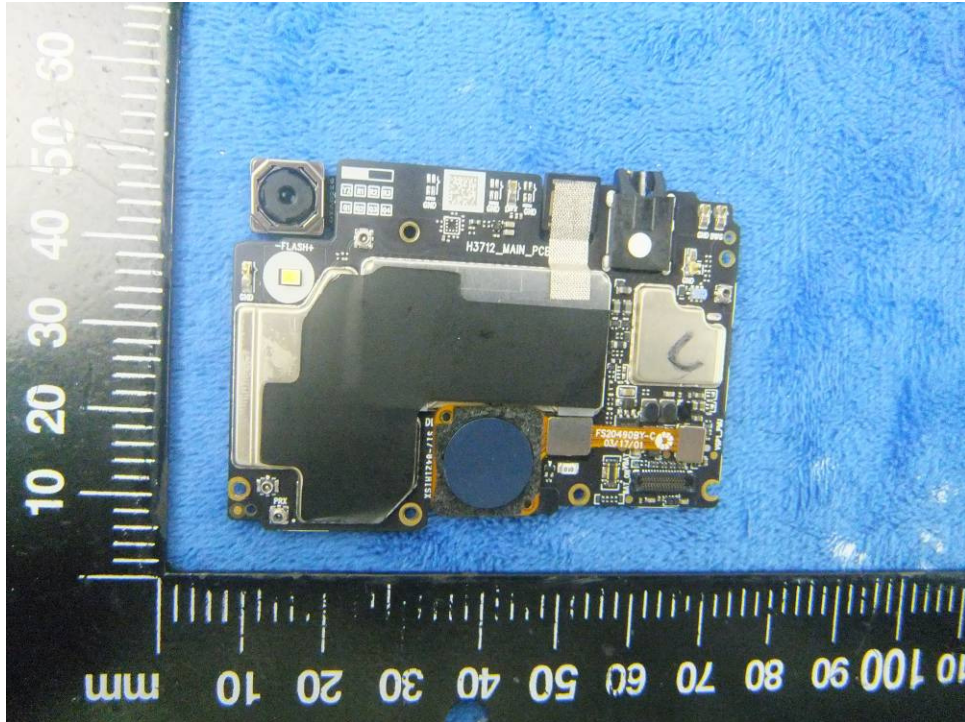

Mainboard without Shielding - Front View

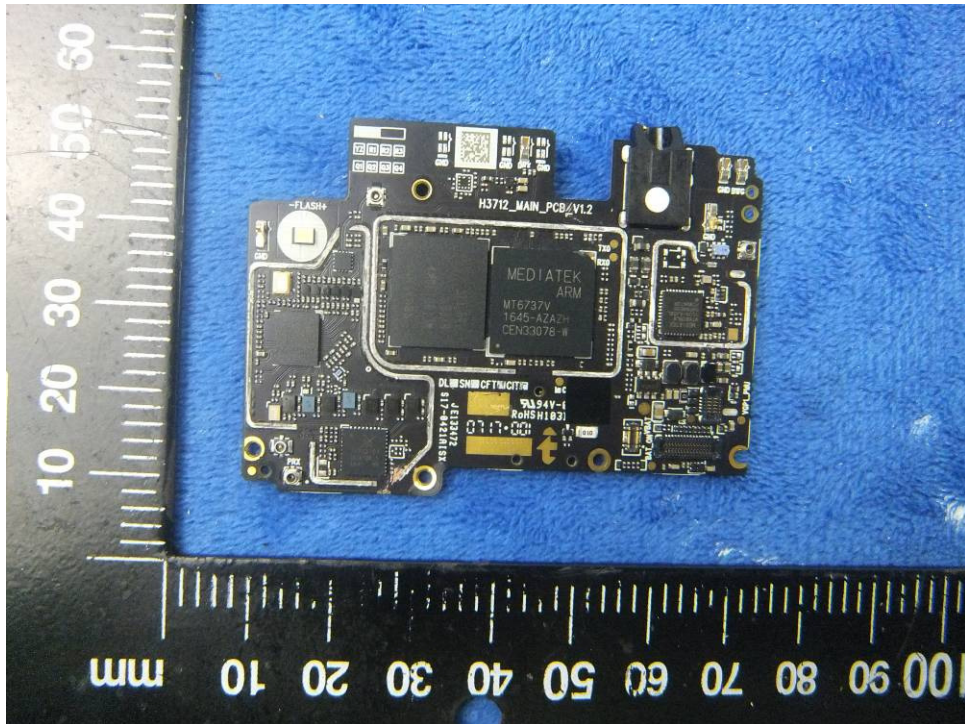

Mainboard with Shielding – Rear View

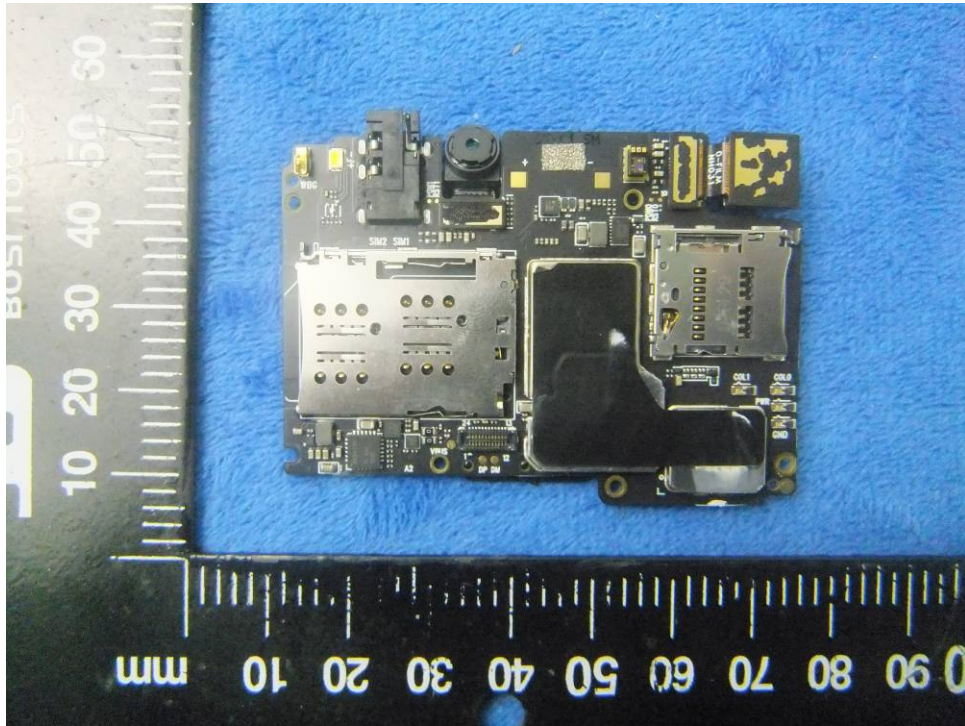

Mainboard without Shielding – Rear View

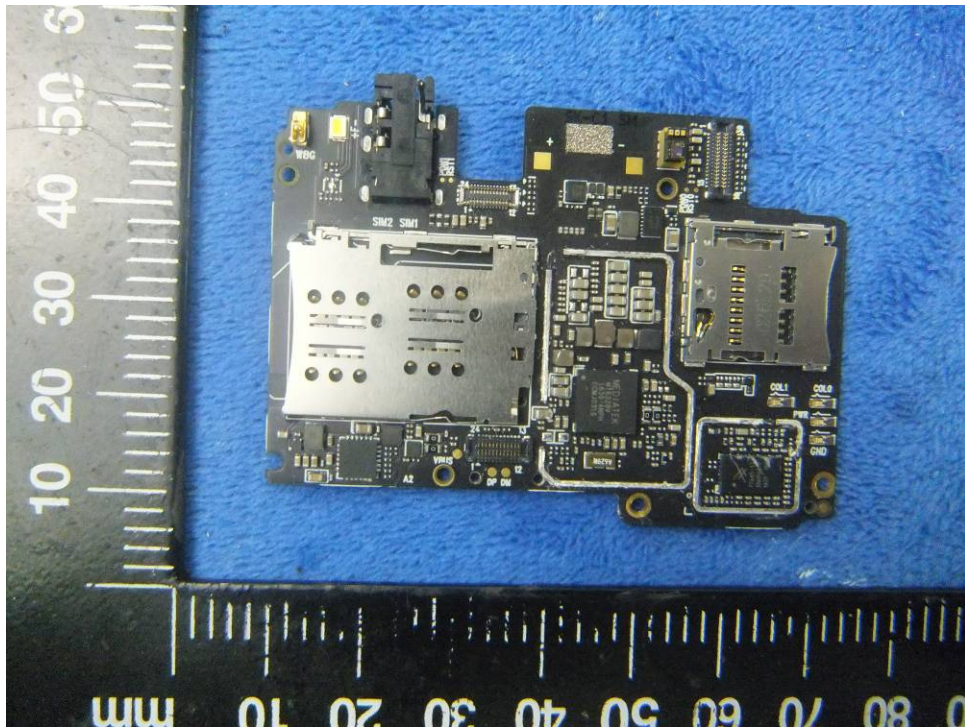

LCD – Front View



LCD – Rear View

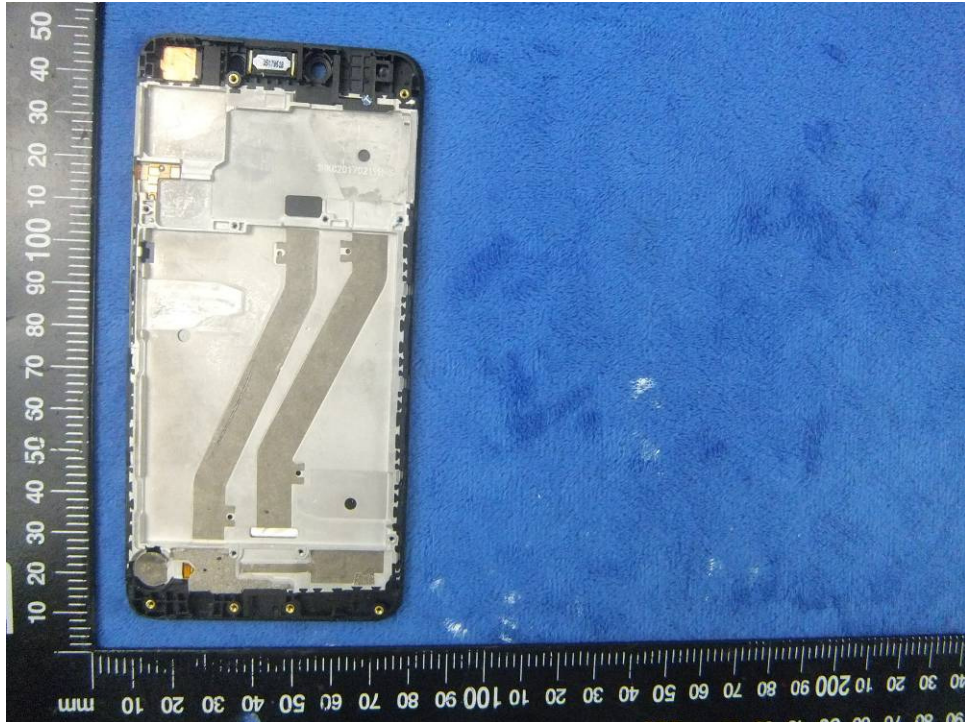

GSM/PCS/UMTS-FDD Antenna View



WIFI/BT/BLE/GPS - Antenna View

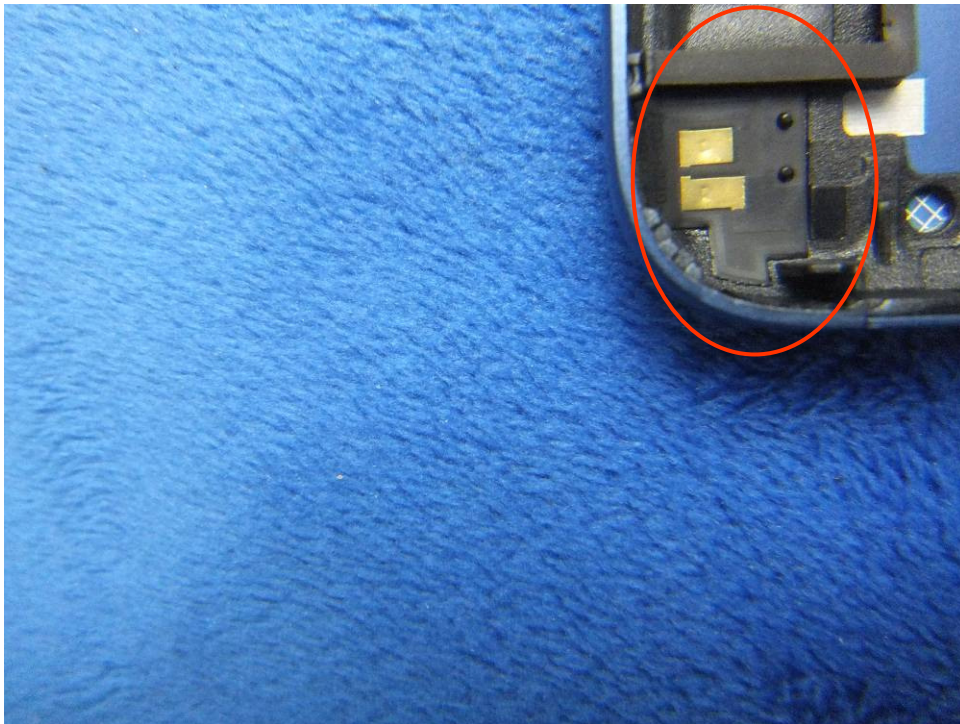

LTE - Antenna View



Annex B.iii. Photograph: Test Setup Photo



Conducted Emissions Test Setup Front View



Conducted Emissions Test Setup Side View



Radiated Spurious Emissions Test Setup Below 1GHz



Radiated Spurious Emissions Test Setup Above
1GHz

Annex C. TEST SETUP AND SUPPORTING EQUIPMENT

Annex C.ii. TEST SET UP BLOCK

Block Configuration Diagram for AC Line Conducted Emissions

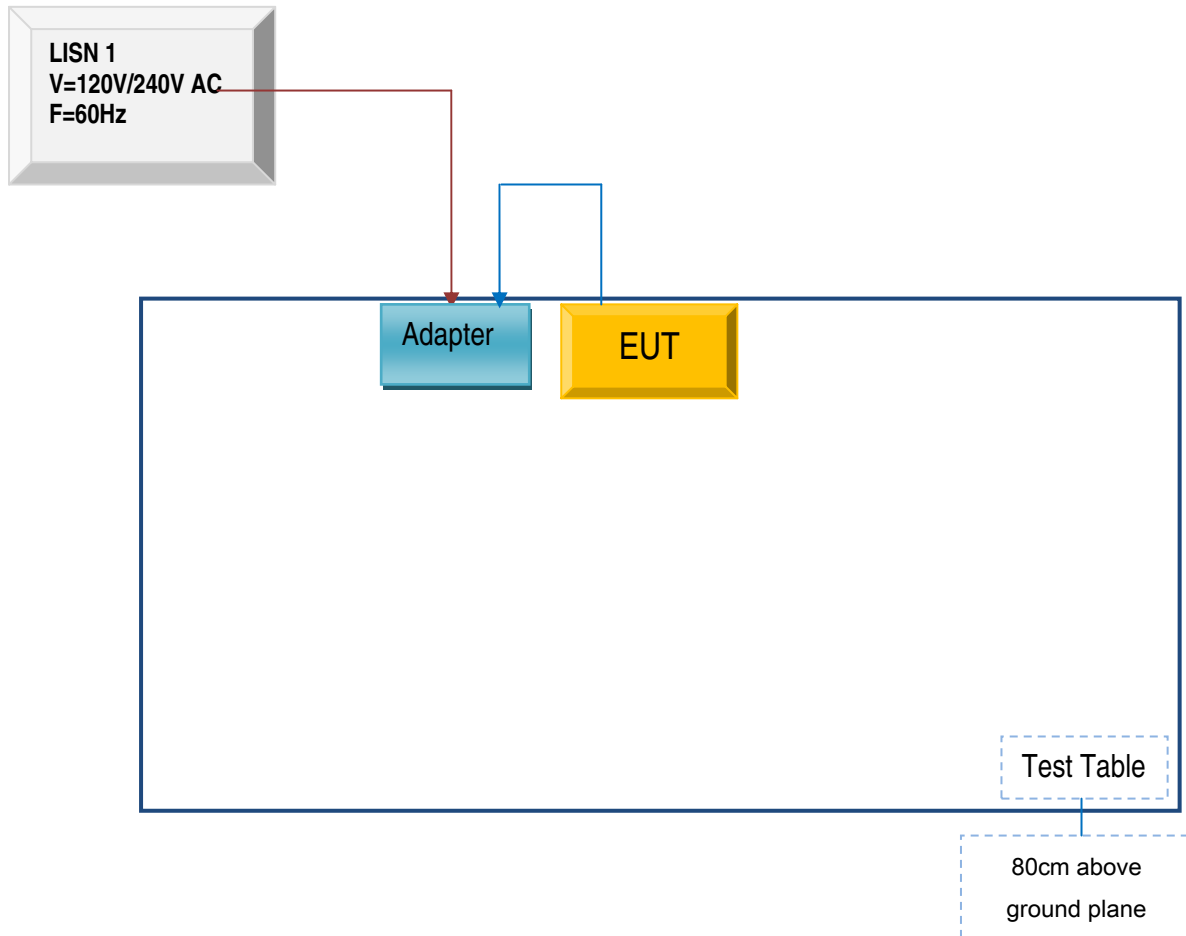

Block Configuration Diagram for Radiated Emissions (Below 1GHz) .

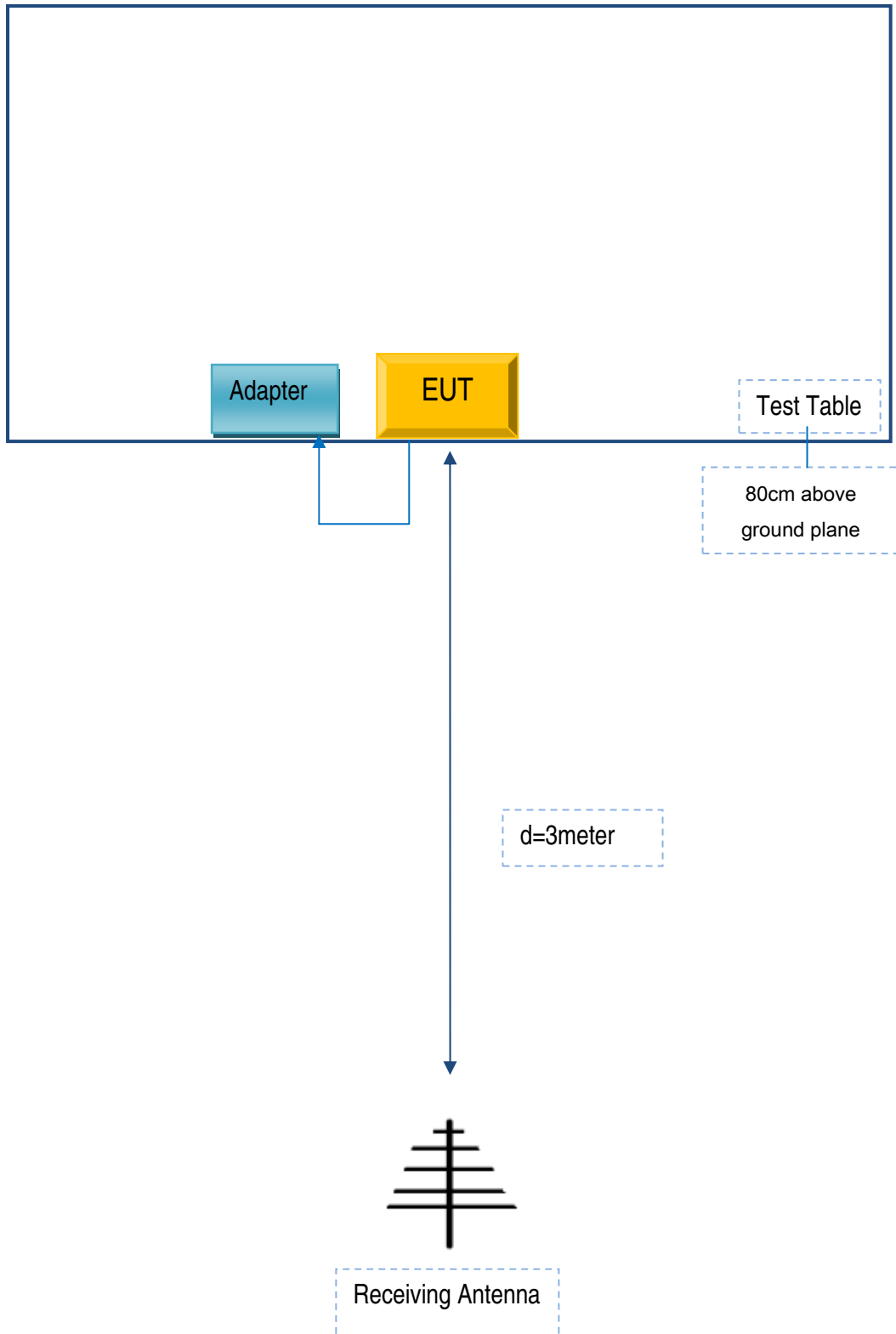

Block Configuration Diagram for Radiated Emissions (Above 1GHz) .

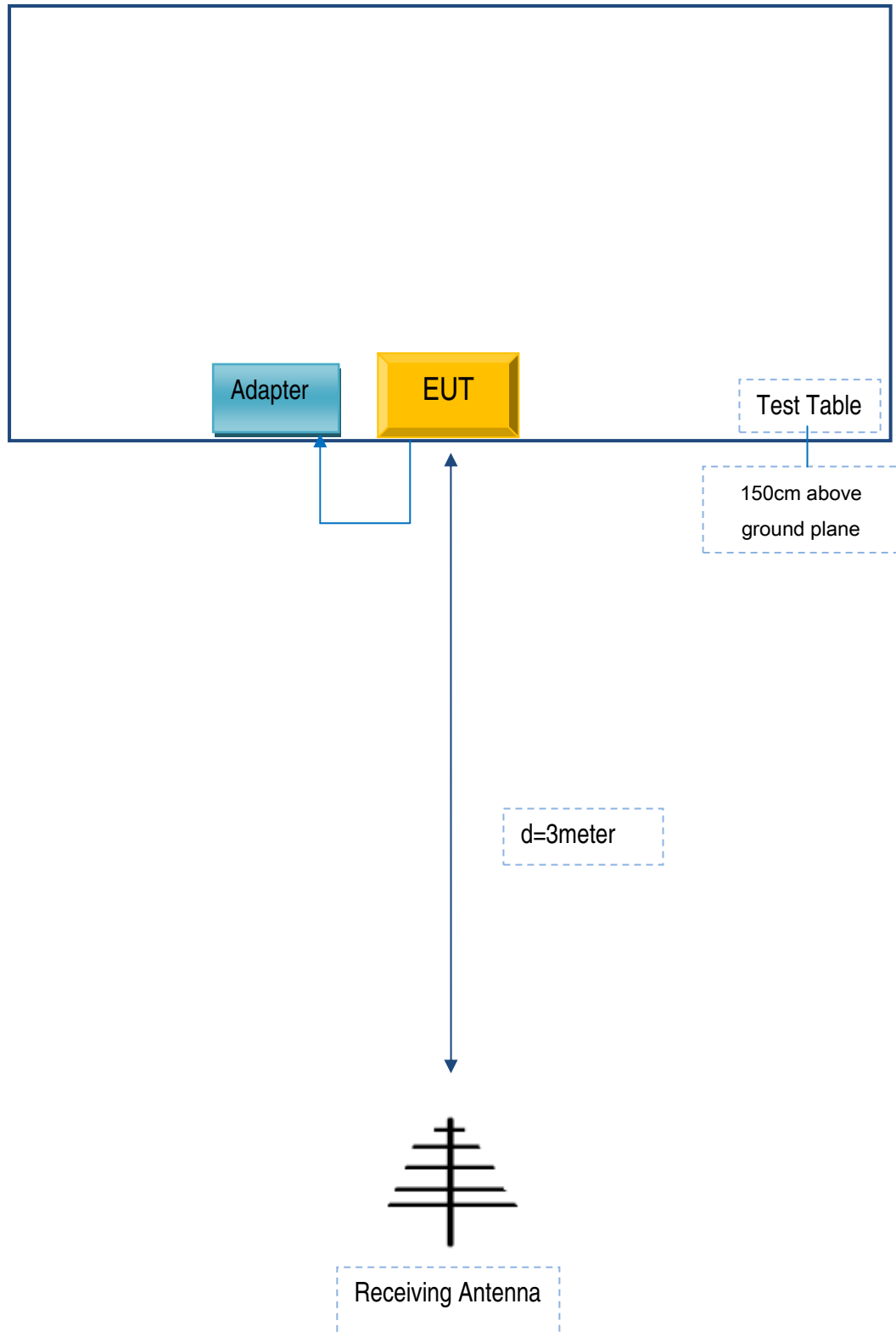

Annex C. ii. SUPPORTING EQUIPMENT DESCRIPTION

The following is a description of supporting equipment and details of cables used with the EUT.

Supporting Equipment:

Manufacturer	Equipment Description	Model	Serial No
TECNO MOBILE LIMITED	Adapter	A8-50100	F1012

Supporting Cable:

Cable type	Shield Type	Ferrite Core	Length	Serial No
USB Cable	Un-shielding	No	0.8m	F1012

Test Report No.	17070226-FCC-R4
Page	49 of 50

Annex D. User Manual / Block Diagram / Schematics / Partlist

Please see the attachment



Test Report No.	17070226-FCC-R4
Page	50 of 50

Annex E. DECLARATION OF SIMILARITY

N/A