



BT Test Report

Application Purpose : Original grant
Applicant Name: : TECNO MOBILE LIMITED
FCC ID : 2ADYY-W3
Equipment Type : Mobile phone
Model Name : W3
Report Number : FCC16093987A-2
Standard(S) : FCC Part 15 Subpart C
Date Of Receipt : September 18, 2016
Date Of Issue : October 15, 2016

Test By : 

(Daisy Qin)

Reviewed By : 

(Sol Qin)

Authorized by : 

(Michal Ling)

Prepared by :

QTC Certification & Testing Co., Ltd.

2nd Floor,B1 Buiding,Fengyeyuan Industrial Plant,,Liuxian
2st.Road,Xin'an Street,Bao'an District,,Shenzhen,
518000China. **Registration Number: 588523**

REPORT REVISE RECORD				
Report Version	Revise Time	Issued Date	Valid Version	Notes
V1.0	/	October 15, 2016	Valid	Original Report

GENERAL DESCRIPTION OF EUT.....	5
2. TEST DESCRIPTION.....	7
2.1 MEASUREMENT UNCERTAINTY	7
2.2 DESCRIPTION OF TEST MODES.....	8
2.3 TABLE OF PARAMETERS OF TEXT SOFTWARE SETTING.....	9
2.4 CONFIGURATION OF SYSTEM UNDER TEST	9
2.5 DESCRIPTION OF SUPPORT UNITS (CONDUCTED MODE).....	10
3. SUMMARY OF TEST RESULTS	11
4. MEASUREMENT INSTRUMENTS	12
§15.203 - ANTENNA REQUIREMENT	13
STANDARD APPLICABLE	13
ANTENNA CONNECTOR CONSTRUCTION	13
§15.207 - CONDUCTED EMISSIONS.....	14
APPLICABLE STANDARD	14
TEST PROCEDURE.....	14
ENVIRONMENTAL CONDITIONS	14
PLOT(S) OF TEST DATA.....	14
§15.209, §15.205, §15.247(D) - SPURIOUS EMISSIONS.....	17
TEST EQUIPMENT	17
TEST PROCEDURE.....	17
ENVIRONMENTAL CONDITIONS	17
RADIATED TEST SETUP.....	18
RADIATED EMISSION LIMIT	20
§15.247(A) (2) – 6DB BANDWIDTH TESTING	26
TEST EQUIPMENT	26
TEST PROCEDURE.....	26
ENVIRONMENTAL CONDITIONS	26
APPLICABLE STANDARD	26
TEST RESULT: PASS.	27
§15.247(B) (3) - MAXIMUM PEAK OUTPUT POWER	29
TEST EQUIPMENT	29
TEST PROCEDURE.....	29

ENVIRONMENTAL CONDITIONS	29
APPLICABLE STANDARD	29
TEST RESULT	30
§15.247(D) – 100 KHZ BANDWIDTH OF FREQUENCY BAND EDGE.....	32
TEST EQUIPMENT	32
TEST PROCEDURE.....	32
ENVIRONMENTAL CONDITIONS	32
APPLICABLE STANDARD	32
TEST RESULT	32
§15.247(E) -MAXIMUM CONDUCTED POWER SPECTRAL DENSITY	37
TEST EQUIPMENT	37
TEST PROCEDURE.....	37
ENVIRONMENTAL CONDITIONS	37
APPLICABLE STANDARD	37
TEST RESULT	38
PHOTOGRAPHS OF THE TEST CONFIGURATION	40
PHOTOGRAPHS OF EUT	42

1. GENERAL INFORMATION

GENERAL DESCRIPTION OF EUT

Test Model	W3
Applicant	TECNO MOBILE LIMITED
Address	ROOMS 05-15, 13A/F., SOUTH TOWER,WORLD FINANCE CENTRE, HARBOUR CITY, 17 CANTON ROAD, TSIM SHA TSUI, KOWLOON, HONG KONG
Manufacturer	SHENZHEN TECNO TECHNOLOGY CO.,LTD.
Address	1-4th Floor,3rd Building,Pacific Industrial Park,No.2088,Shenyang Road,Yantian District,Shenzhen,Guangdong,China
Equipment Type	Mobile phone
Brand Name	
Hardware version:	H806_Main_PCB_V1.2
Software version:	W3-H806D1-M-160824V1
Extreme Temp. Tolerance	-10°C to +65°C
Adapter Information:	Adapter: A8-501000 Input: AC 100-240VAC 50/60Hz 0.2A Output: DC 5V 1A Li-ion Battery : BL-25FT Voltage: 3.8V Capacity: 2500mAh Limited Charge Voltage: 4.35V
Operating Frequency	2402-2480MHz
Channels	40
Channel Spacing	2MHz
Modulation Type	GFSK
Version	4.0
Antenna Type:	Integral Antenna
Antenna gain:	-3.83dBi
Data of receipt	September 18, 2016
Date of test	October 18,2016 to October 15, 2016
Deviation	None
Condition of Test Sample	Normal

We hereby certify that:

All measurement facilities used to collect the measurement data are located at QTC Certification & Testing Co., Ltd.

Registration Number: 588523

The data evaluation, test procedures, and equipment configurations shown in this report were made in accordance with the procedures given in ANSI C 63.4:2014. The sample tested as described in this report is in compliance with the FCC Rules Part15 Subpart C.

ALL the testing were referenced KDB NO.558074

The test results of this report relate only to the tested sample identified in this report.

2. TEST DESCRIPTION

2.1 MEASUREMENT UNCERTAINTY

The reported uncertainty of measurement $y \pm U$, where expanded uncertainty U is based on a standard uncertainty multiplied by a coverage factor of $k=2$, providing a level of confidence of approximately **95 %**.

No.	Item	Uncertainty
1	Conducted Emission Test	$\pm 3.2\text{dB}$
2	RF power, conducted	$\pm 0.16\text{dB}$
3	Spurious emissions, conducted	$\pm 0.21\text{dB}$
4	All emissions, radiated(<1G)	$\pm 4.7\text{dB}$
5	All emissions, radiated(>1G)	$\pm 4.7\text{dB}$
6	Temperature	$\pm 0.5^\circ\text{C}$
7	Humidity	$\pm 2\%$

2.2 DESCRIPTION OF TEST MODES

To investigate the maximum EMI emission characteristics generated from EUT, the test system was pre-scanning tested based on the consideration of following EUT operation mode or test configuration mode which possibly have effect on EMI emission level. Each of these EUT operation mode(s) or test configuration mode(s) mentioned above was evaluated respectively.

Pretest Mode	Description
Mode 1	CH00
Mode 2	CH20
Mode 3	CH39
Mode 4	Normal

For Conducted Emission	
Final Test Mode	Description
Mode 4	Normal

For Radiated Emission	
Final Test Mode	Description
Mode 1	CH00
Mode 2	CH20
Mode 3	CH39

Note:

- (1) The measurements are performed at the highest, middle, lowest available channels.**
- (2) Record the worst case of each test item in this report.**

2.3 Table of Parameters of Text Software Setting

During testing channel & power controlling software provided by the customer was used to control the operating channel as well as the output power level. The RF output power selection is for the setting of RF output power expected by the customer and is going to be fixed on the firmware of the final end product power parameters.

Test software Version	N/A
-----------------------	-----

Frequency	2402 MHz	2440 MHz	2480 MHz
Parameters(1Mbps)	DEF	DEF	DEF

2.4 CONFIGURATION OF SYSTEM UNDER TEST

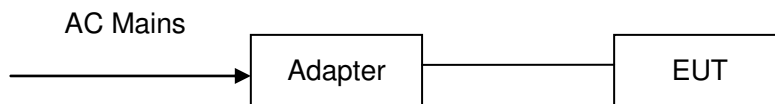

(EUT: Mobile phone)

2.5 DESCRIPTION OF SUPPORT UNITS (CONDUCTED MODE)

The EUT has been tested as an independent unit together with other necessary accessories or support units. The following support units or accessories were used to form a representative test configuration during the tests.

Item	Equipment	Mfr/Brand	Model/Type No.	Series No.	Note
1	Adapter	/	A8-501000	/	/
	Earphone	/	N/A	/	/

Note:

- (1) The support equipment was authorized by Declaration of Confirmation.
- (2) For detachable type I/O cable should be specified the length in cm in 『Length』 column.
- (3) “YES” is means “shielded” “with core”; “NO” is means “unshielded” “without core”.

3. SUMMARY OF TEST RESULTS

Test procedures according to the technical standards:

FCC Part15 (15.247) , Subpart C			
Standard Section	Test Item	Judgment	Remark
15.203	Antenna Requirement	PASS	
15.207	Conducted Emission	PASS	
15.209, 15.205, 15.247(d)	Spurious Emission	PASS	
15.247(a) (2)	6dB Bandwidth Testing	PASS	
15.247(b) (3)	Maximum Peak Output Power	PASS	
15.247(d)	100 KHz Bandwidth of Frequency Band Edge	PASS	
15.247(e)	Maximum Conducted Power Spectral Density	PASS	

NOTE:

(1) "N/A" denotes test is not applicable in this test report.

4. MEASUREMENT INSTRUMENTS

NAME OF EQUIPMENT	MANUFACTURER	MODEL	SERIAL NUMBER	Calibration Date	Calibration Due.
EMI Test Receiver	R&S	ESCI	100005	08/19/2016	08/18/2017
LISN	AFJ	LS16	16010222119	08/19/2016	08/18/2017
LISN(EUT)	Mestec	AN3016	04/10040	08/19/2016	08/18/2017
Universal Radio Communication Tester	R&S	CMU 200	1100.0008.02	08/19/2016	08/18/2017
Coaxial cable	Megalon	LMR400	N/A	08/12/2016	08/11/2017
GPIO cable	Megalon	GPIO	N/A	08/12/2016	08/11/2017
Spectrum Analyzer	R&S	FSU	100114	08/19/2016	08/18/2017
Pre Amplifier	H.P.	HP8447E	2945A02715	10/13/2016	10/12/2017
Pre-Amplifier	CDSI	PAP-1G18-38	--	10/13/2016	10/12/2017
Bi-log Antenna	SUNOL Sciences	JB3	A021907	09/13/2016	09/12/2017
9*6*6 Anechoic	--	--	--	08/21/2016	08/20/2017
Horn Antenna	COMPLIANCE ENGINEERING	CE18000	--	09/13/2016	09/12/2017
Horn Antenna	SCHWARZBECK	BBHA9120D	9120D-631	08/23/2016	08/22/2017
Cable	TIME MICROWAVE	LMR-400	N-TYPE04	04/25/2016	04/24/2017
System-Controller	CCS	N/A	N/A	N.C.R	N.C.R
Turn Table	CCS	N/A	N/A	N.C.R	N.C.R
Antenna Tower	CCS	N/A	N/A	N.C.R	N.C.R
RF cable	Murata	MXHQ87WA3000	-	08/21/2016	08/20/2017
Loop Antenna	EMCO	6502	00042960	08/22/2016	08/21/2017
Horn Antenna	SCHWARZBECK	BBHA 9170	1123	08/19/2016	08/18/2017
Power meter	Anritsu	ML2487A	6K00003613	08/23/2016	08/22/2017
Power sensor	Anritsu	MX248XD	--	08/19/2016	08/18/2017

§15.203 - ANTENNA REQUIREMENT

Standard Applicable

According to § 15.203, an intentional radiator shall be designed to ensure that no antenna other than that furnished by the responsible party shall be used with the device. The use of a permanently attached antenna or of an antenna that uses a unique coupling to the intentional radiator shall be considered sufficient to comply with the provisions of this section. The manufacturer may design the unit so that a broken antenna can be replaced by the user, but the user of a standard antenna jack or electrical connector is prohibited. The structure and application of the EUT were analyzed to determine compliance with section §15.203 of the rules. §15.203 state that the subject device must meet the following criteria:

- a. Antenna must be permanently attached to the unit.
- b. Antenna must use a unique type of connector to attach to the EUT.

Unit must be professionally installed, and installer shall be responsible for verifying that the correct antenna is employed with the unit.

And according to FCC 47 CFR section 15.247 (b), if the transmitting antennas of directional gain greater than 6dBi are used, the power shall be reduced by the amount in dB that the directional gain of the antenna exceeds 6 dBi.

Antenna Connector Construction

The EUT's antenna integrated on PCB, The antenna's gain is -3.83dBi and meets the requirement.

§15.207 - CONDUCTED EMISSIONS

Applicable Standard

The specification used was with the FCC Part 15.207 limits.

Test Procedure

During the conducted emission test, the EUT was connected to the outlet of the LISN.

Maximizing procedure was performed on the six (6) highest emissions of the EUT.

All data was recorded in the Quasi-peak and average detection mode.

Test Result

PASS

Test Conditions

Temperature:	26 °C
Relative Humidity:	60%
ATM Pressure:	100.0kPa
Voltage	120V/60Hz

Plot(s) of Test Data

Plot(s) of Test Data is presented hereinafter as reference.

Phase: L

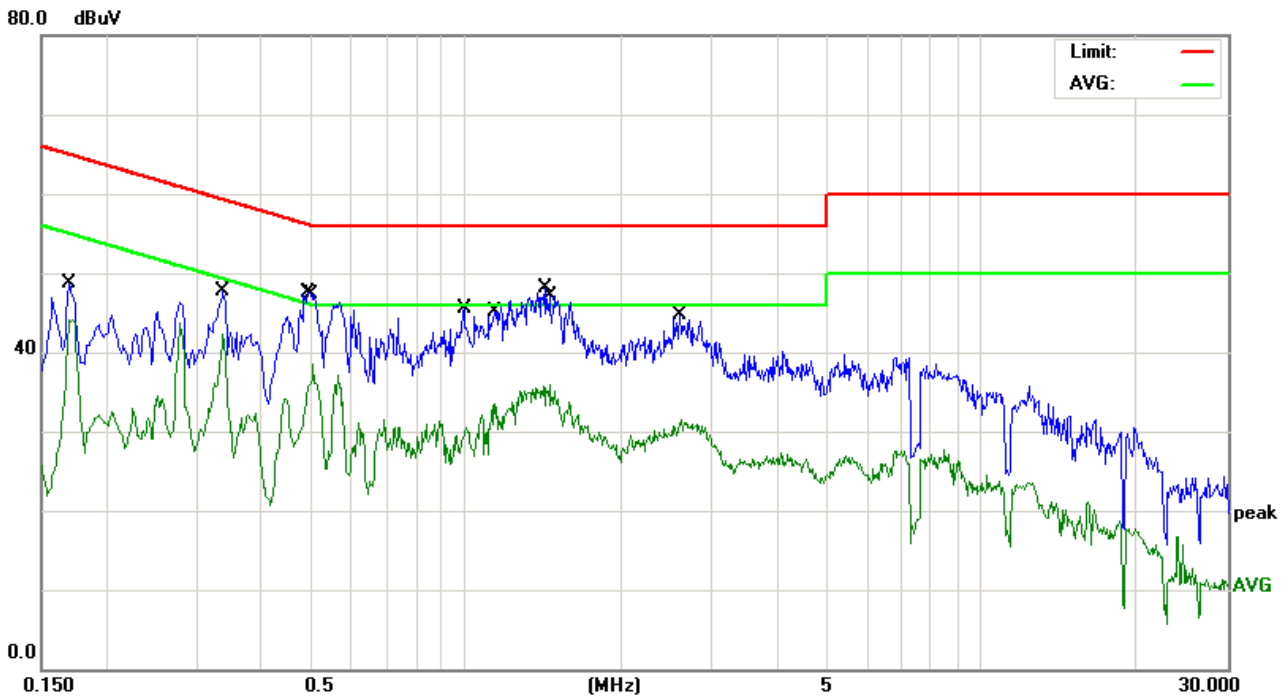

No.	Mk.	Freq. MHz	Reading Level dBuV	Correct Factor dB	Measure- ment dBuV	Limit dBuV	Over dB	Detector
1		0.1700	34.31	10.44	44.75	64.96	-20.21	QP
2		0.1720	33.66	10.44	44.10	54.86	-10.76	AVG
3		0.3379	33.14	10.42	43.56	59.25	-15.69	QP
4	*	0.3379	31.97	10.42	42.39	49.25	-6.86	AVG
5		0.4940	31.92	10.40	42.32	56.10	-13.78	QP
6		0.5060	28.17	10.40	38.57	46.00	-7.43	AVG
7		0.9940	30.89	10.34	41.23	56.00	-14.77	QP
8		1.1380	23.20	10.33	33.53	46.00	-12.47	AVG
9		1.4260	35.67	10.32	45.99	56.00	-10.01	QP
10		1.4500	25.56	10.32	35.88	46.00	-10.12	AVG
11		2.6020	31.40	10.28	41.68	56.00	-14.32	QP
12		2.6140	21.15	10.28	31.43	46.00	-14.57	AVG

Remark: All of the Tx modes have been investigated, and only worst mode is presented in this report.

Phase: N

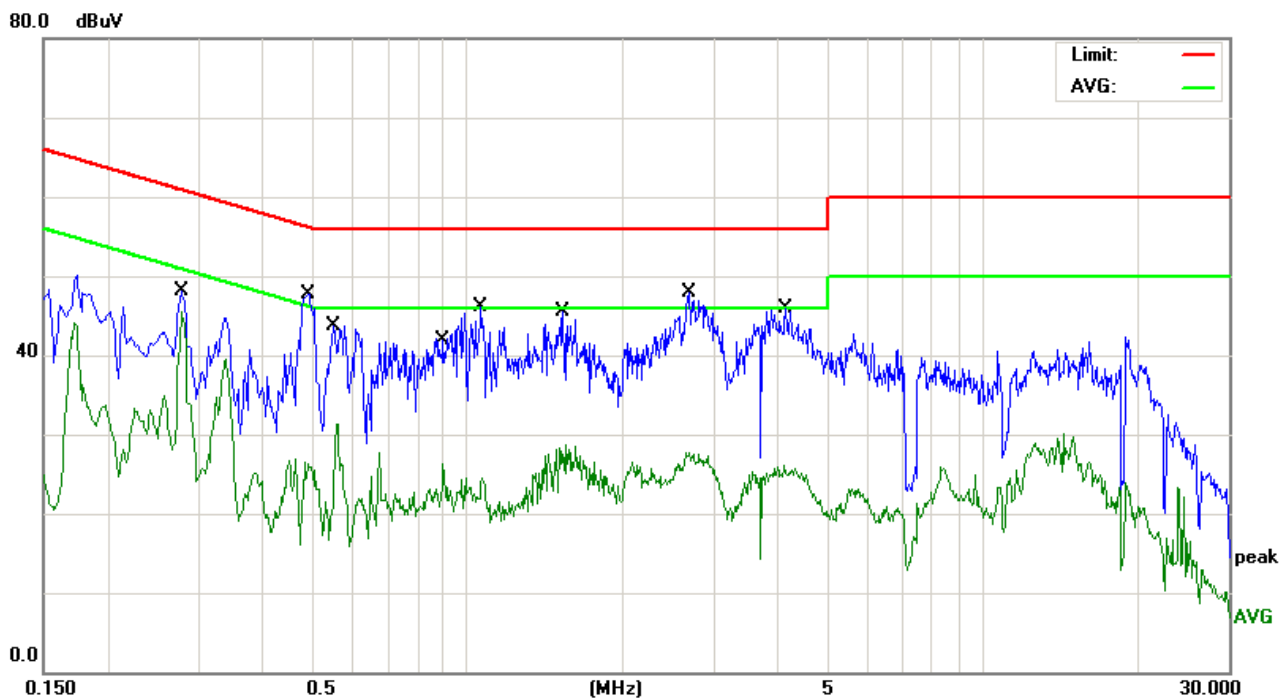

No.	Mk.	Freq. MHz	Reading Level dBuV	Correct Factor dB	Measure- ment dBuV	Limit dBuV	Over dB	Detector
1		0.2779	33.44	10.43	43.87	60.88	-17.01	QP
2	*	0.2779	35.13	10.43	45.56	50.88	-5.32	AVG
3		0.4900	32.28	10.40	42.68	56.17	-13.49	QP
4		0.5580	20.87	10.39	31.26	46.00	-14.74	AVG
5		0.8980	15.87	10.35	26.22	46.00	-19.78	AVG
6		1.0620	32.54	10.34	42.88	56.00	-13.12	QP
7		1.5300	31.22	10.31	41.53	56.00	-14.47	QP
8		1.5500	18.39	10.31	28.70	46.00	-17.30	AVG
9		2.6580	17.42	10.28	27.70	46.00	-18.30	AVG
10		2.7060	35.69	10.28	45.97	56.00	-10.03	QP
11		4.1179	15.75	10.25	26.00	46.00	-20.00	AVG
12		4.1539	31.00	10.25	41.25	56.00	-14.75	QP

Remark: All of the Tx modes have been investigated, and only worst mode is presented in this report.

§15.209, §15.205, §15.247(d) - SPURIOUS EMISSIONS

Test Equipment

Please refer to section 4 this report.

Test Procedure

The out of band emission tests were performed in the 3-meter chamber test site, using the setup accordance with the ANSI C63.4-2014. The specification used was the FCC Part Subpart C limits.

- a. The measuring distance of at 3 m shall be used for measurements at frequency up to 1GHz. For frequencies above 1GHz, any suitable measuring distance may be used.
- b. The EUT was placed on the top of a rotating table 0.8 meters above the ground at a 3 meter open area test site. The table was rotated 360 degrees to determine the position of the highest radiation.
- c. The height of the equipment or of the substitution antenna shall be 0.8 m; the height of the test antenna shall vary between 1 m to 4 m. Both horizontal and vertical polarizations of the antenna are set to make the measurement.
- d. The initial step in collecting conducted emission data is a spectrum analyzer peak detector mode pre-scanning the measurement frequency range. Significant peaks are then marked and then Quasi Peak detector mode re-measured.
- e. If the Peak Mode measured value compliance with and lower than Quasi Peak Mode Limit, the EUT shall be deemed to meet QP Limits and then no additional QP Mode measurement performed.
- f. For the actual test configuration, please refer to the related Item –EUT Test Photos.

Note:

Both horizontal and vertical antenna polarities were tested and performed pretest to three orthogonal axis. The worst case emissions were reported

Environmental Conditions

Temperature:	26 °C
Relative Humidity:	55%
ATM Pressure:	100.0kPa

Radiated Test Setup

The system was investigated from 9 KHz to 25 GHz.

During the radiated emission test, the EMI test receiver & Spectrum Analyzer Setup were set with the following configurations:

Frequency Range	RBW	Video B/W	Detector
9KHz-30MHz	9kHz	30 kHz	QP
30 MHz – 1000 MHz	100 kHz	300 kHz	QP
1000 MHz – 25 GHz	1 MHz	3 MHz	PK
1000 MHz – 25 GHz	1 MHz	10 Hz	Ave

(A) Radiated Emission Test-Up Frequency Below 30MHz

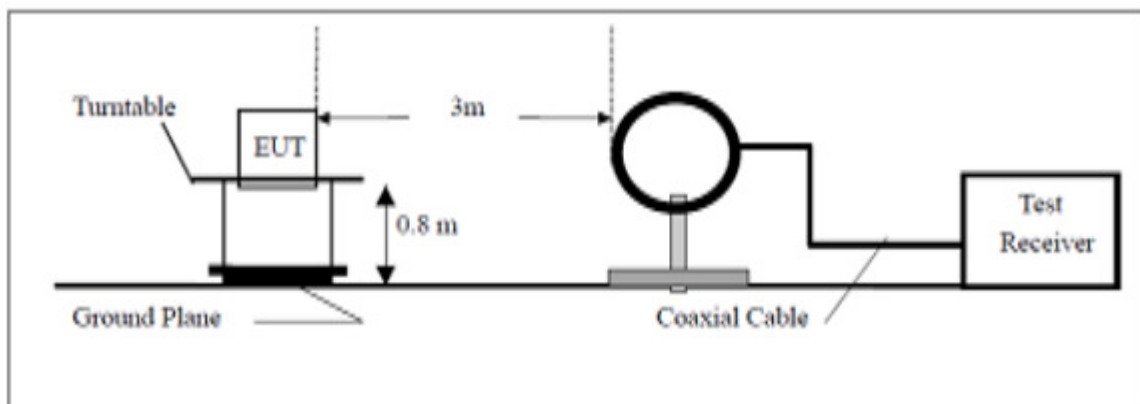

(B) Radiated Emission Test-Up Frequency 30MHz~1GHz

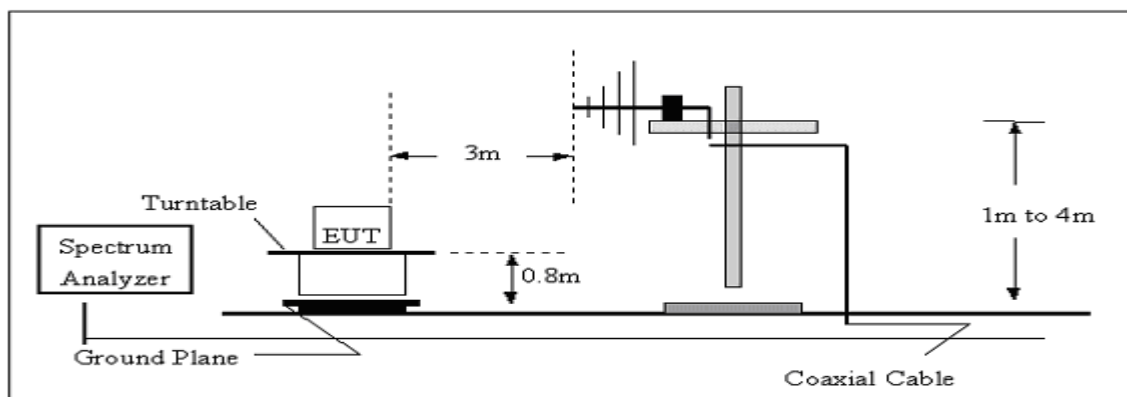

(C) Radiated Emission Test-Up Frequency Above 1GHz

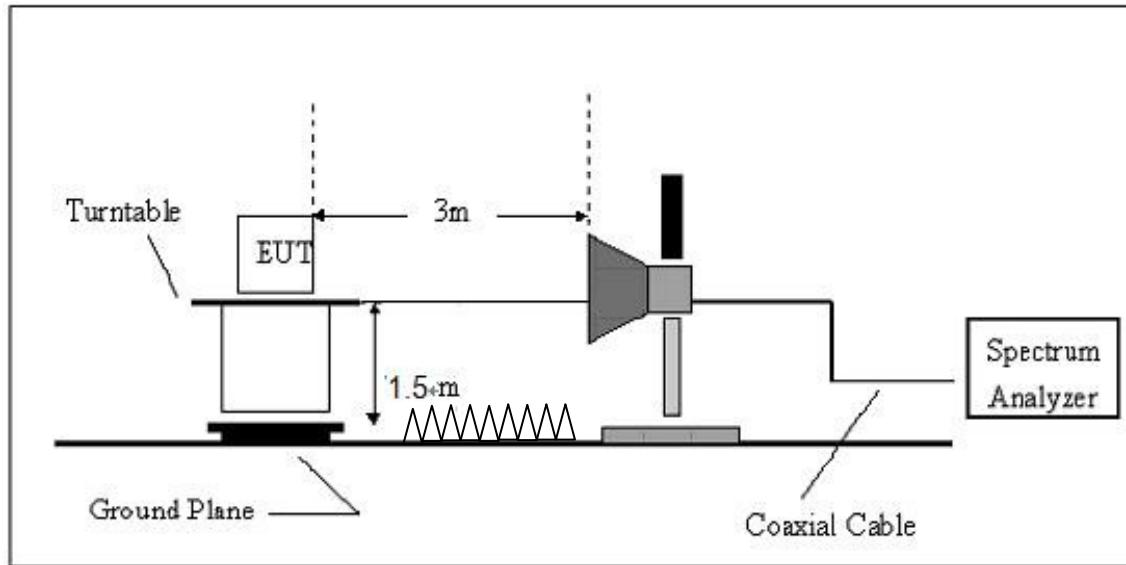

For the accrual test configuration, please refer to the related items-photos of Testing.

Radiated Emission Limit

Applicable Standard

FCC §15.247 (d); §15.209; §15.205;

Radiated Emission Test Result

Frequency (MHz)	Field strength (microvolts/meter)	Measurement distance (meters)
0.009–0.490	2400/F(kHz)	300
0.490–1.705	24000/F(kHz)	30
1.705–30.0	30	30
30–88	100**	3
88–216	150**	3
216–960	200**	3
Above 960	500	3

Test Mode: Transmitting

Note:

Both horizontal and vertical antenna polarities were tested and performed pretest to three orthogonal axis. The worst case emissions were reported

Test result:

From 9KHz to 30MHz

NOTE: 9KHz-30MHz the measurements were greater than 20dB below the limit.

Frequency from 30MHz to 1GHz

Horizontal:

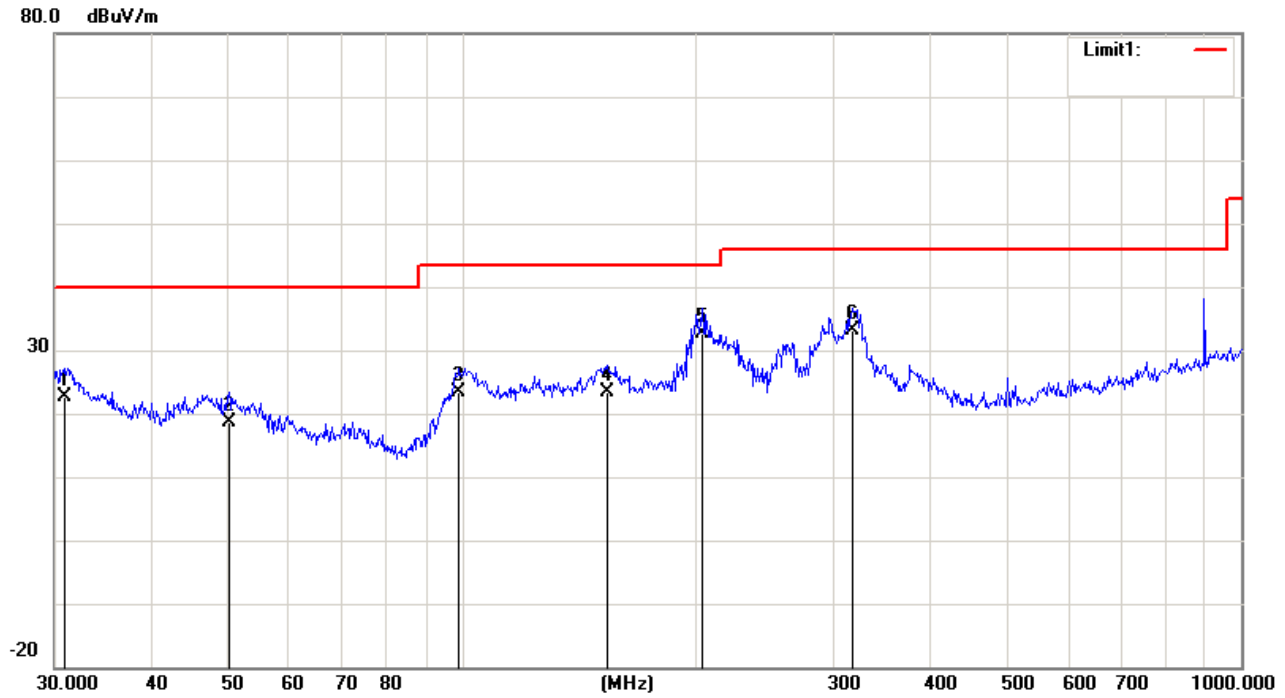

No.	Mk.	Freq.	Reading Level	Correct Factor	Measurement	Limit	Over	Detector
		MHz	dBuV	dB	dBuV/m	dBuV/m	dB	
1		30.8535	19.67	2.92	22.59	40.00	-17.41	QP
2		50.2324	27.72	-9.03	18.69	40.00	-21.31	QP
3		99.1797	29.91	-6.46	23.45	43.50	-20.05	QP
4		153.7385	27.53	-4.12	23.41	43.50	-20.09	QP
5	*	203.5228	37.60	-4.95	32.65	43.50	-10.85	QP
6		317.7011	37.59	-4.45	33.14	46.00	-12.86	QP

Remark: All of the TX modes have been investigated, and only worst mode is presented in this report.

Vertical:

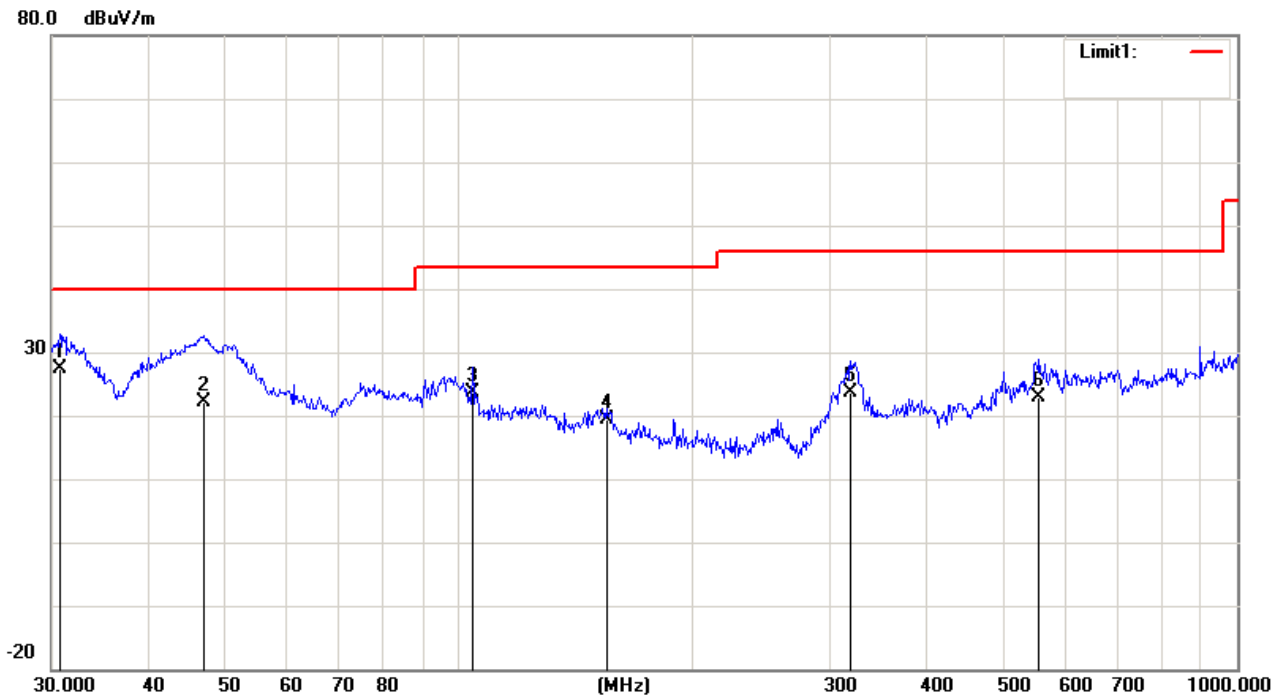

No.	Mk.	Freq. MHz	Reading Level dBuV	Correct Factor dB	Measure- ment dBuV/m	Limit dBuV/m	Over dB	Detector
1	*	30.7455	24.33	2.99	27.32	40.00	-12.68	QP
2		47.1599	29.85	-7.84	22.01	40.00	-17.99	QP
3		104.1701	28.92	-5.18	23.74	43.50	-19.76	QP
4		154.8204	23.65	-4.20	19.45	43.50	-24.05	QP
5		318.8170	28.13	-4.48	23.65	46.00	-22.35	QP
6		556.7744	22.61	0.37	22.98	46.00	-23.02	QP

Remark: All of the TX modes have been investigated, and only worst mode is presented in this report.

From 1GHz to 25GHz:

Operation Mode: Channel 0 Test Date : October 08,2016
 Frequency Range: Above 1GHz Temperature : 28°C
 Test Result: PASS Humidity : 65 %
 Measured Distance: 3m Test By:

Freq. (MHz)	Ant.Pol.	Emission Level(dBuV)		Limit 3m(dBuV/m)		Over(dB)	
	H/V	PK	AV	PK	AV	PK	AV
4804.68	V	60.67	39.82	74	54	-13.33	-14.18
7206.91	V	58.85	39.56	74	54	-15.15	-14.44
9608.51	V	59.61	40.19	74	54	-14.39	-13.81
4804.68	H	58.56	39.56	74	54	-15.44	-14.44
7206.95	H	60.67	39.82	74	54	-13.33	-14.18

All emissions not reported were more than 20dB below the specified limit or in the noise floor.

- Note:** (1) All Readings are Peak Value and AV.
 (2) Emission Level= Reading Level+ Probe Factor +Cable Loss.
 (3) Data of measurement within this frequency range shown "--" in the table above means the reading of emissions are attenuated more than 20dB below the permissible limits or the field strength is too small to be measured.

Operation Mode: Channel 20 Test Date : October 08,2016
 Frequency Range: Above 1GHz Temperature : 28°C
 Test Result: PASS Humidity : 65 %
 Measured Distance: 3m Test By:

Freq. (MHz)	Ant.Pol.	Emission Level(dBuV)		Limit 3m(dBuV/m)		Over(dB)	
	H/V	PK	AV	PK	AV	PK	AV
4884.61	V	60.85	39.92	74	54	-13.15	-14.08
7326.53	V	58.99	39.25	74	54	-15.01	-14.75
4884.87	H	58.01	40.85	74	54	-15.99	-13.15
7326.59	H	59.41	40.41	74	54	-14.59	-13.59
9768.27	H	60.85	39.92	74	54	-13.15	-14.08

All emissions not reported were more than 20dB below the specified limit or in the noise floor.

- Note:**
- (1) All Readings are Peak Value and AV.
 - (2) Emission Level= Reading Level+Probe Factor +Cable Loss.
 - (3) Data of measurement within this frequency range shown "--" in the table above means the reading of emissions are attenuated more than 20dB below the permissible limits or the field strength is too small to be measured.

Operation Mode: Channel 39 Test Date : October 08,2016
 Frequency Range: Above 1GHz Temperature : 28°C
 Test Result: PASS Humidity : 65 %
 Measured Distance: 3m Test By:

Freq. (MHz)	Ant.Pol. H/V	Emission Level(dBuV)		Limit 3m(dBuV/m)		Over(dB)	
		PK	AV	PK	AV	PK	AV
4960.74	V	60.51	40.67	74	54	-13.49	-13.33
7440.96	V	59.63	40.22	74	54	-14.37	-13.78
9920.67	V	59.91	39.53	74	54	-14.09	-14.47
4960.59	H	58.94	39.94	74	54	-15.06	-14.06
7440.63	H	60.51	40.67	74	54	-13.49	-13.33

All emissions not reported were more than 20dB below the specified limit or in the noise floor.

1.3.

- Note:**
- (1) All Readings are Peak Value and AV.
 - (2) Emission Level= Reading Level+Probe Factor +Cable Loss.
 - (3) Data of measurement within this frequency range shown "--" in the table above means the reading of emissions are attenuated more than 20dB below the permissible limits or the field strength is too small to be measured.

§15.247(a) (2) – 6dB BANDWIDTH TESTING

Test Equipment

Please refer to Section 4 this report.

Test Procedure

1. Set EUT in the transmitting mode.
2. Remove the antenna from the EUT and then connect a low loss RF cable from the antenna port to the spectrum analyzer.
3. Set the spectrum analyzer as RBW=100KHz, VBW \geq RBW, Span=3MHz, Sweep=auto.
4. Mark the peak frequency and -6dB(upper and lower)frequency.
5. Repeat until all the rest channels are investigated.

Note : The EUT was tested according to KDB 558074 for compliance to FCC 47CFR 15.247 requirements.

Environmental Conditions

Temperature:	26 °C
Relative Humidity:	55%
ATM Pressure:	100.0kPa

Applicable Standard

Systems using digital modulation techniques may operate in the 902–928 MHz, 2400–2483.5 MHz, and 5725–5850 MHz bands. The minimum 6 dB bandwidth shall be at least 500 kHz.

Test Result: Pass.

Please refer to the following tables

Channel Frequency (MHz)	Data Rate (Mbps)	6dB Bandwidth (kHz)	Limit (kHz)	Ref. Plot
2402	1	716.34	>500	PLOT 1
2440	1	725.96	>500	PLOT 2
2480	1	706.37	>500	PLOT 3

Low Channel

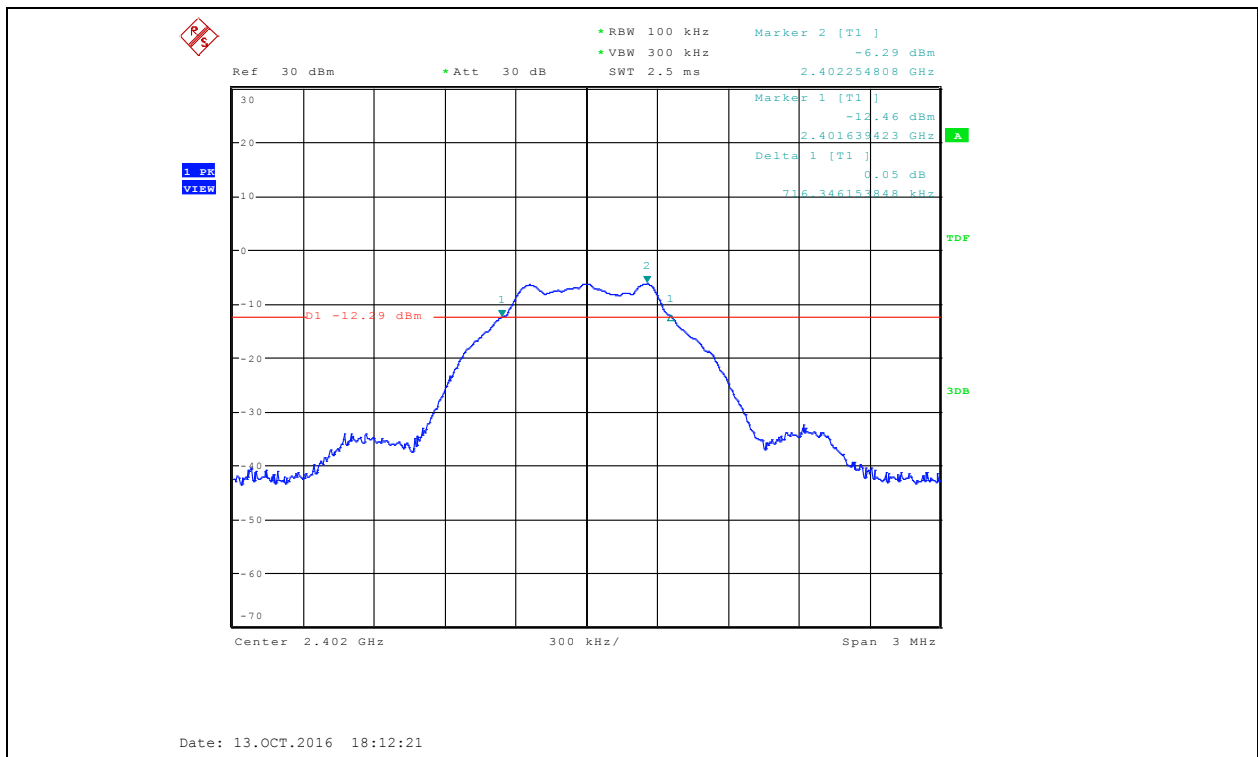

Middle channel

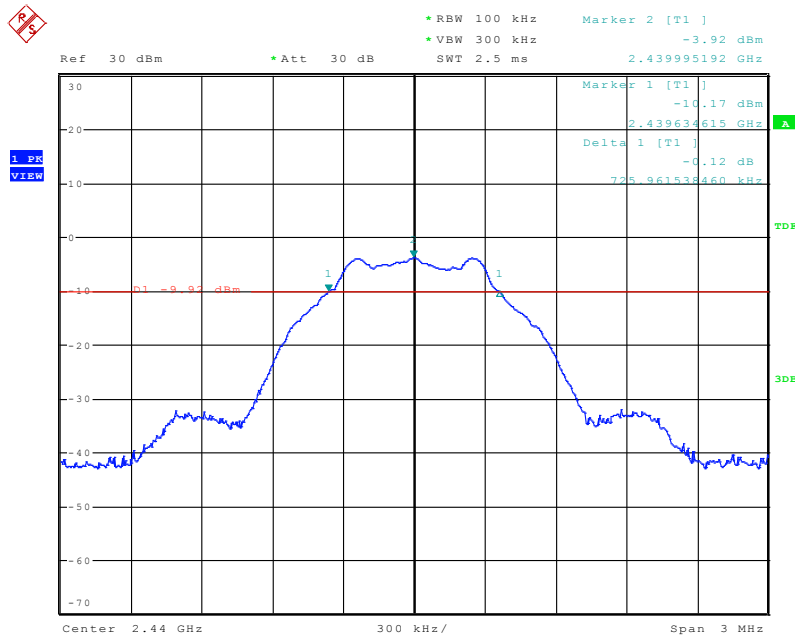

Date: 13.OCT.2016 18:13:57

High Channel

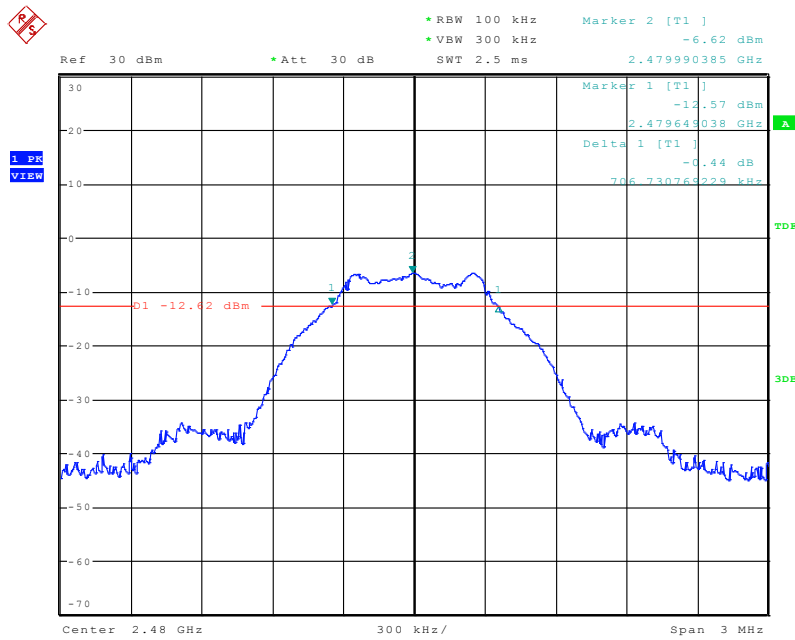

Date: 13.OCT.2016 18:14:57

§15.247(b) (3) - MAXIMUM PEAK OUTPUT POWER

Test Equipment

Please refer to Section 4 this report.

Test Procedure

1. The EUT was directly connected to the spectrum analyzer and antenna output port as show in the block diagram below,
2. Set the EUT Work on the top, the middle and the bottom operation frequency individually.
3. Set the RBW =1MHz, VBW \geq 3RBW, span \geq 1.5*6dbbandwidth.
Sweep time = auto couple, Detector = peak, Trace mode = max hold.
4. Record the maximum power from the spectrum analyzer.
5. The maximum peak power shall be less 1 Watt (30dBm).

Note : The EUT was tested according to KDB 558074 for compliance to FCC 47CFR 15.247 requirements.

Environmental Conditions

Temperature:	26 °C
Relative Humidity:	55%
ATM Pressure:	100.0kPa

Applicable Standard

According to §15.247(b) (3), for systems using digital modulation in the 902–928 MHz, 2400–2483.5 MHz, and 5725–5850 MHz bands: 1 Watt. As an alternative to a peak power measurement, compliance with the one Watt limit can be based on a measurement of the maximum conducted output power. Maximum Conducted Output Power is defined as the total transmit power delivered to all antennas and antenna elements averaged across all symbols in the signaling alphabet when the transmitter is operating at its maximum power control level. Power must be summed across all antennas and antenna elements. The average must not include any time intervals during which the transmitter is off or is transmitting at a reduced power level. If multiple modes of operation are possible (e.g., alternative modulation methods), the maximum conducted output power is the highest total transmit power occurring in any mode.

Test Result

Channel	Frequency (MHz)	Data Rate (Mbps)	Conducted Power (dBm)	Limit (dBm)
Low	2402	1	-5.21	30
Middle	2440	1	-4.48	30
High	2480	1	-5.77	30

Low channel

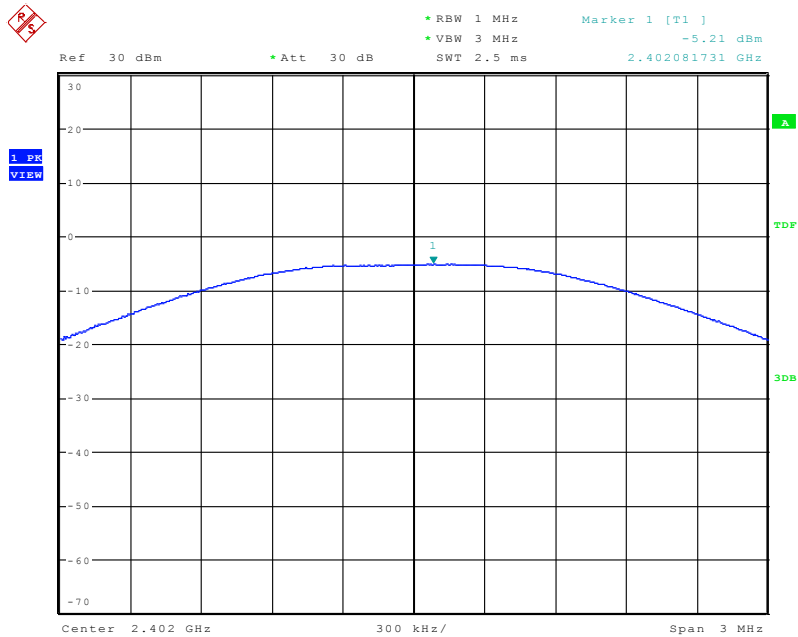

Date: 13.OCT.2016 18:15:58

Middle channel

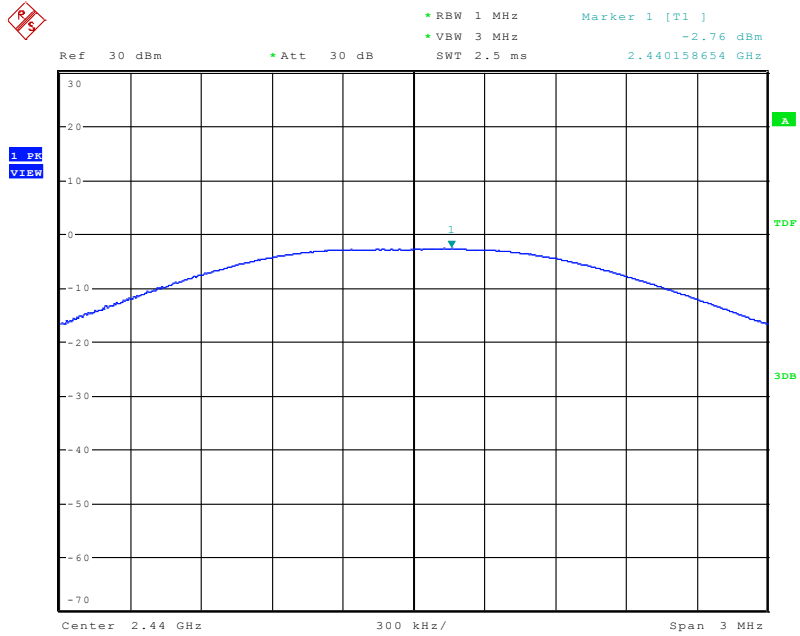

Date: 13.OCT.2016 18:16:31

High channel

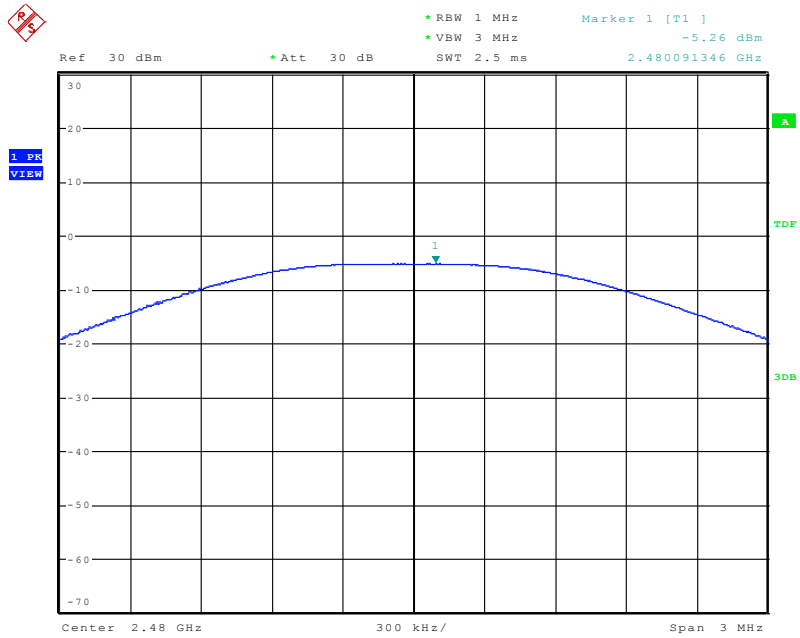

Date: 13.OCT.2016 18:16:56

§15.247(d) – 100 kHz BANDWIDTH OF FREQUENCY BAND EDGE

Test Equipment

Please refer to Section 4 this report.

Test Procedure

The out of band emission tests were performed in the 3-meter chamber test site, using the setup accordance with the ANSI C63.4-2014. The specification used was the FCC Part Subpart C limits.

Environmental Conditions

Temperature:	26 °C
Relative Humidity:	55%
ATM Pressure:	100.0kPa

Applicable Standard

In any 100 kHz bandwidth outside the frequency band in which the spread spectrum or digitally modulated intentional radiator is operating, the radio frequency power that is produced by the intentional radiator shall be at least 20 dB below that in the 100 kHz bandwidth within the band that contains the highest level of the desired power, based on either an RF conducted or a radiated measurement, provided the transmitter demonstrates compliance with the peak conducted power limits. If the transmitter complies with the conducted power limits based on the use of RMS averaging over a time interval, as permitted under paragraph (b)(3) of this section, the attenuation required under this paragraph shall be 30 dB instead of 20 dB. Attenuation below the general limits specified in §15.209(a) is not required. In addition, radiated emissions which fall in the restricted bands, as defined in §15.205(a), must also comply with the radiated emission limits specified in §15.209(a) (see §15.205(c)).

Test Result

PASS

Radiated measurement:

Indicated		result (PK/AV)	Table Angle Degree	Antenna		Correction Factor			FCC Part 15.247		
Frequency (MHz)	Receiver Reading (dB μ V/m)			Height (m)	Polar (H/V)	Ant. Factor (dB/m)	Cable Loss (dB)	Pre-Amp. Gain (dB)	Cord. Amp. (dB μ V/m)	Limit (dB μ V/m)	Margin (dB)
Low Channel (2402MHz)											
2390	39.12	AV	225	1.5	V	30.3	4.1	33.1	40.42	54	13.58
2390	40.84	AV	90	2	H	30.3	4.1	33.1	39.54	54	11.86
2390	62.17	PK	180	1.5	V	30.3	4.1	33.1	40.42	74	10.53
2390	63.87	PK	270	2	H	30.3	4.1	33.1	65.17	74	8.83
High Channel (2480MHz)											
2483.5	37.66	AV	360	1	V	31	4.4	32.7	40.02	54	12.98
2483.5	36.98	AV	90	2	H	31	4.4	32.7	39.68	54	13.32
2483.5	47.63	PK	180	1	V	31	4.4	32.7	47.93	74	25.07
2483.5	46.58	PK	225	2	H	31	4.4	32.7	49.56	74	25.44

Conducted Emission Measurement:

Low channel

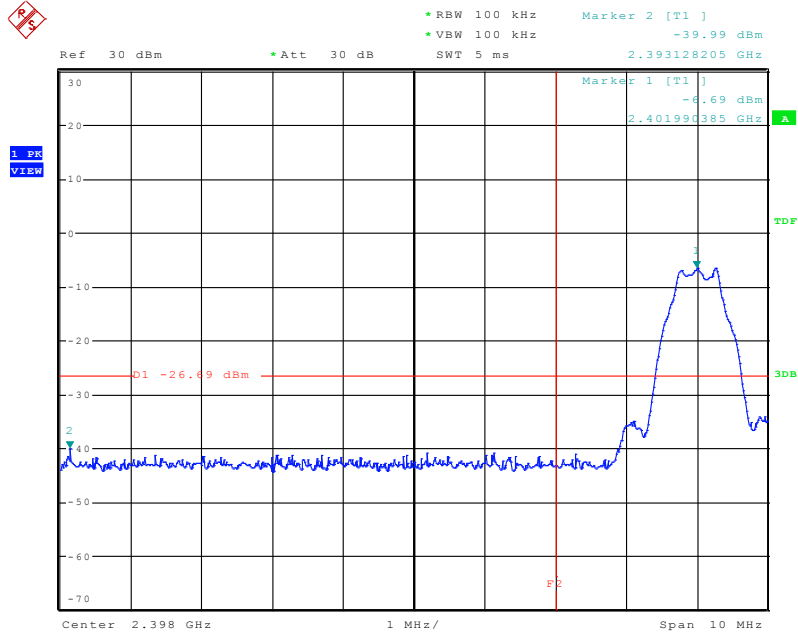

Date: 13.OCT.2016 18:18:53

High channel

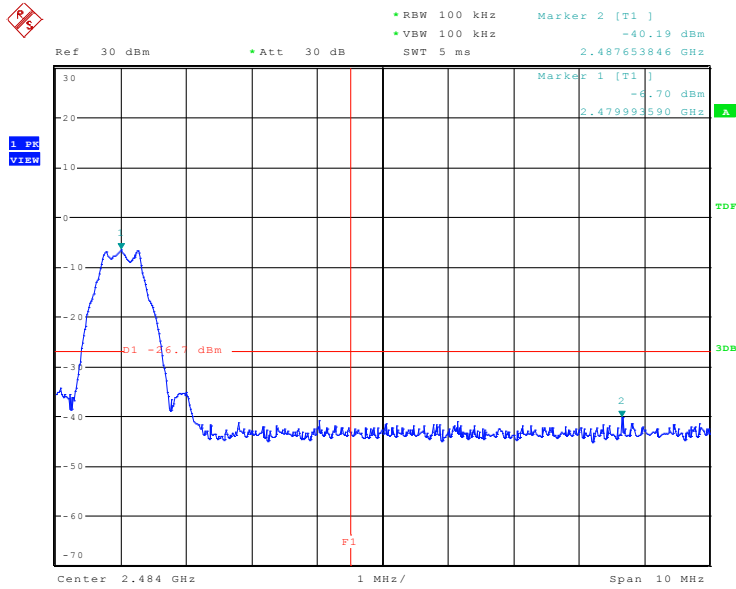

Conducted spurious emissions

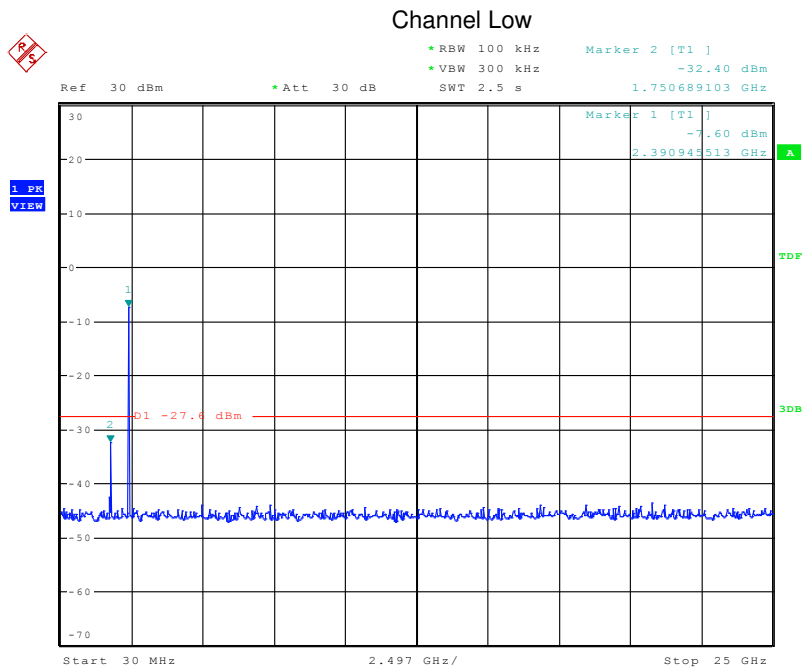

Date: 13.SEP.2016 16:17:58

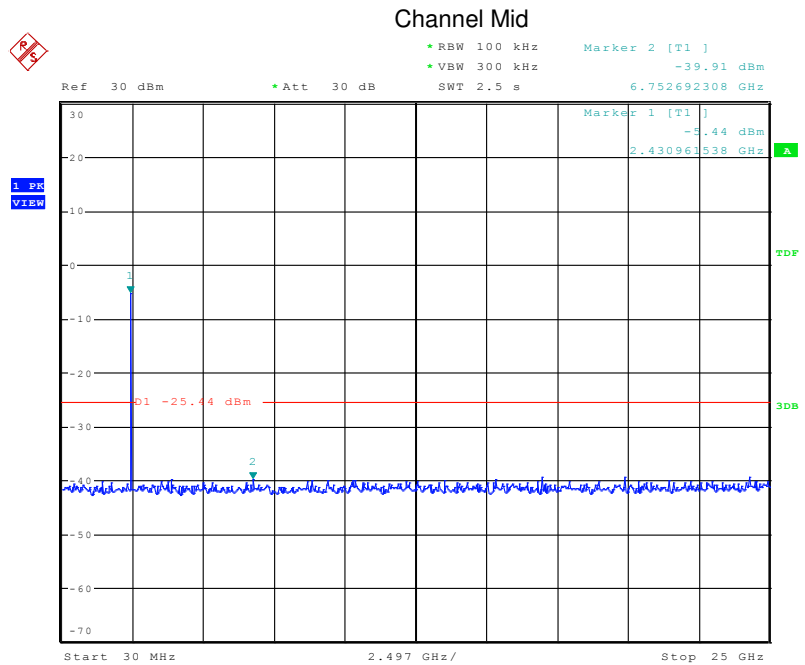

Date: 13.OCT.2016 18:26:13

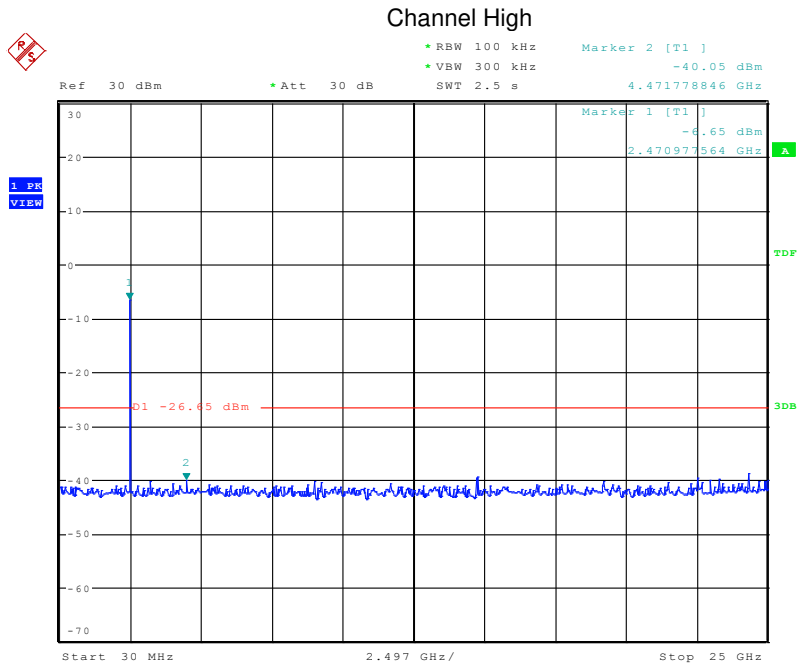

Date: 13.OCT.2016 18:27:06

§15.247(e) -MAXIMUM CONDUCTED POWER SPECTRAL DENSITY

Test Equipment

Please refer to Section 4 this report.

Test Procedure

- 1, This procedure shall be used if maximum peak conducted output power was used to demonstrate compliance, and is optional if the maximum conducted (average) output power was used to demonstrate compliance.
- 2, Set analyzer center frequency to DTS channel center frequency.
- 3, Set the RBW to:3 kHz \leq RBW \leq 100 kHz, Set the VBW \geq 3 RBW, Detector = peak. Sweep time = auto couple
- 4, Trace mode = max hold, Allow trace to fully stabilize.

Note : The EUT was tested according to KDB 558074 for compliance to FCC 47CFR 15.247 requirements.

Environmental Conditions

Temperature:	25 °C
Relative Humidity:	55%
ATM Pressure:	100.0kPa

Applicable Standard

For digitally modulated systems, the power spectral density conducted from the intentional radiator to the antenna shall not be greater than 8 dBm in any 3 kHz band during any time interval of continuous transmission. This power spectral density shall be determined in accordance with the provisions of paragraph (b) of this section. The same method of determining the conducted output power shall be used to determine the power spectral density.

Test Result

PASS

Channel Frequency (MHz)	Data Rate (Mbps)	PSD (dBm/3kHz)	Limit (dBm/3kHz)	RESULT
2402	1	-21.08	8	Compliant
2440	1	-18.61	8	Compliant
2480	1	-21.24	8	Compliant

Low Channel

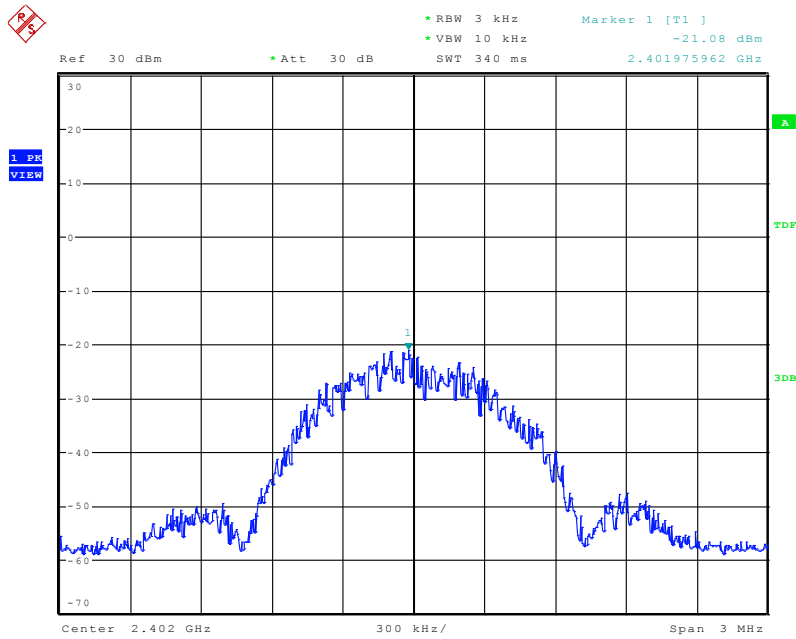

Date: 13.OCT.2016 18:28:39

Middle Channel

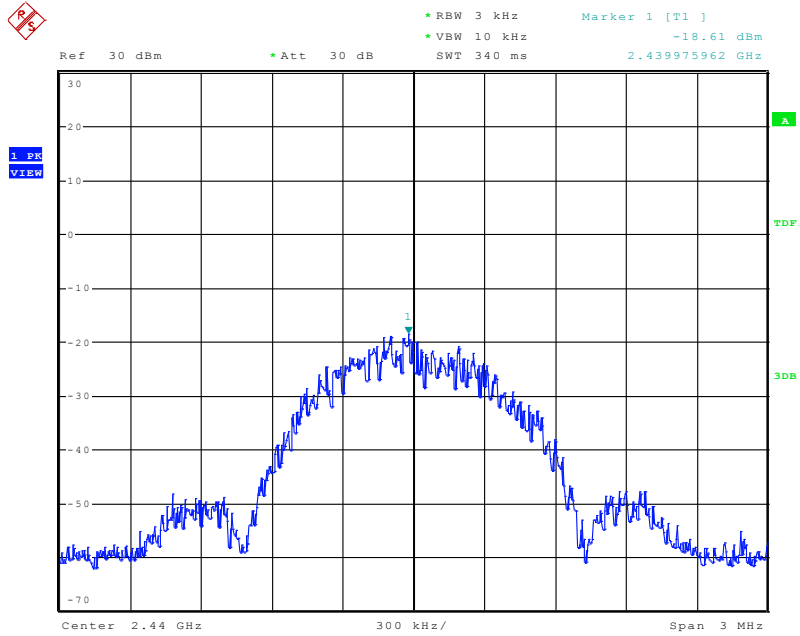

Date: 13.OCT.2016 18:29:16

High Channel

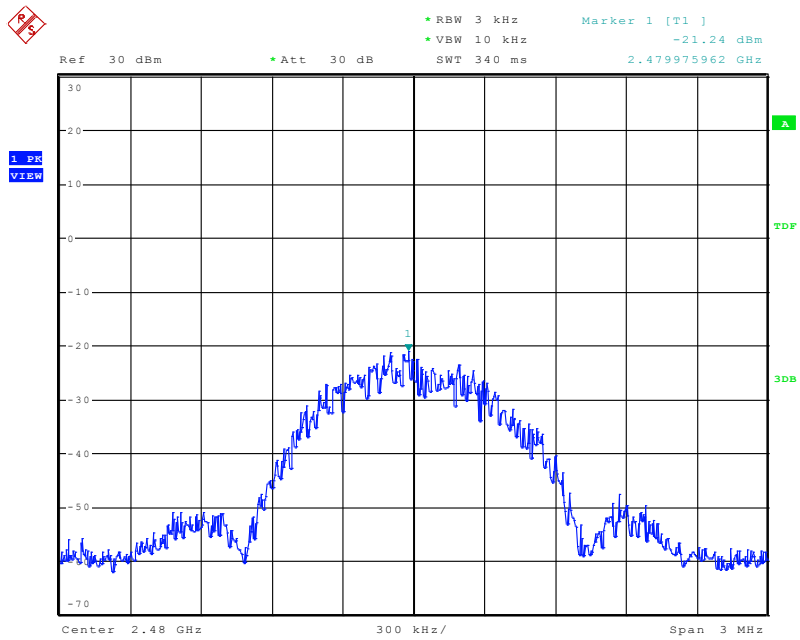

Date: 13.OCT.2016 18:29:49

PHOTOGRAPHS OF THE TEST CONFIGURATION

CONDUCTED EMISSION TEST



RADIATED EMISSION TEST

(Frequency from 30MHz to 1GHz)

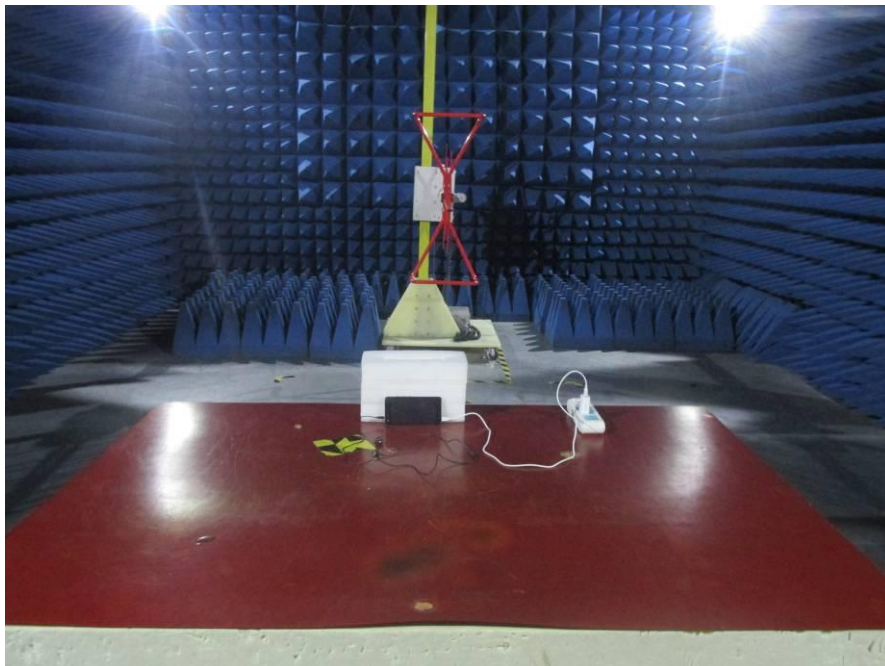

RADIATED EMISSION TEST

(Frequency above 1GHz)

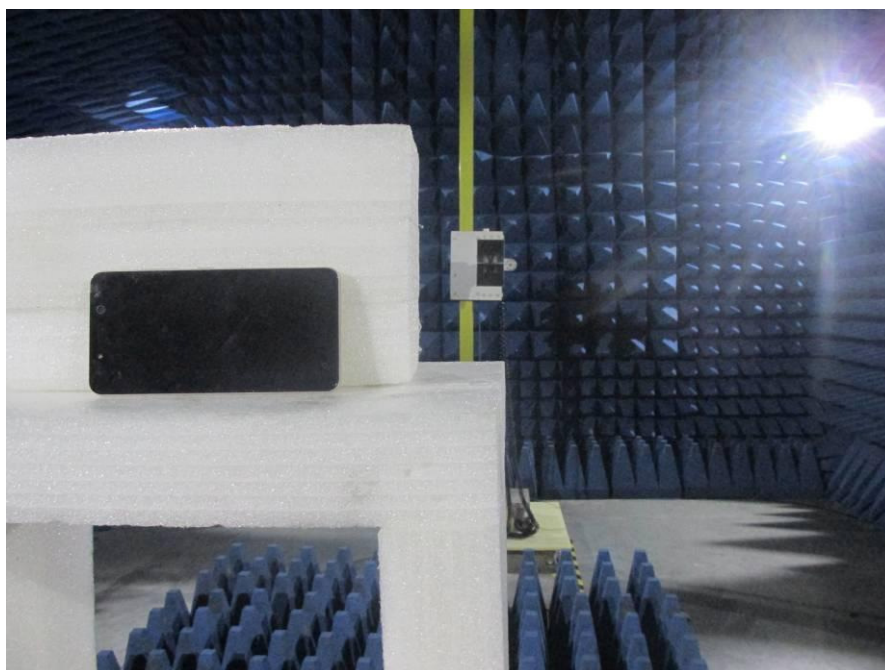

PHOTOGRAPHS OF EUT

Appearance photograph of EUT



Appearance photograph of EUT



Appearance photograph of EUT



Appearance photograph of EUT

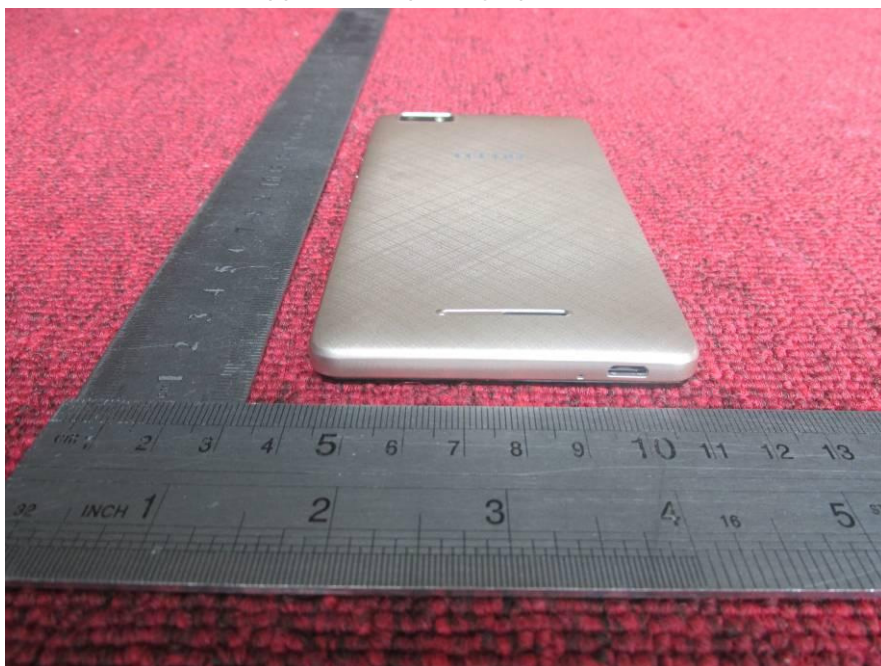

Appearance photograph of EUT



Appearance photograph of EUT

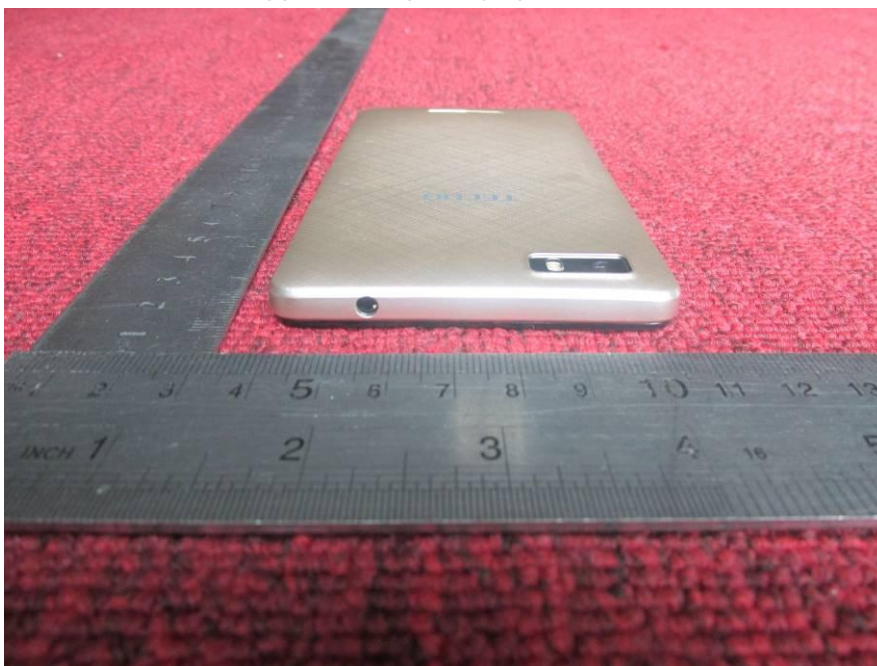

Appearance photograph of EUT



Appearance photograph of EUT



Internal photograph of EUT



Internal photograph of EUT



Internal photograph of EUT



BT/WiFi Antenna

Internal photograph of EUT



GSM/2/3G Antenna

Internal photograph of EUT



Internal photograph of EUT



Internal photograph of EUT

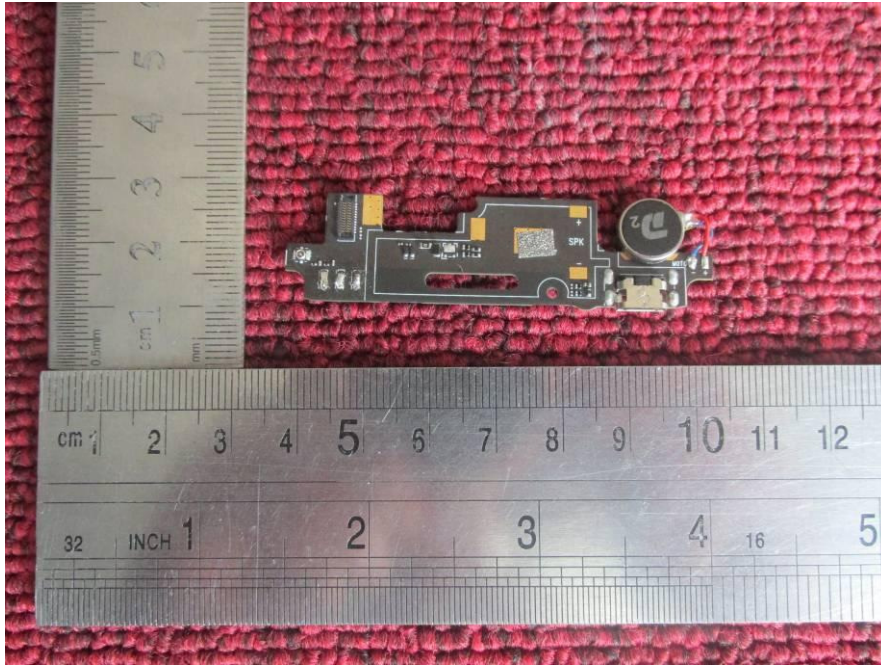

Internal photograph of EUT

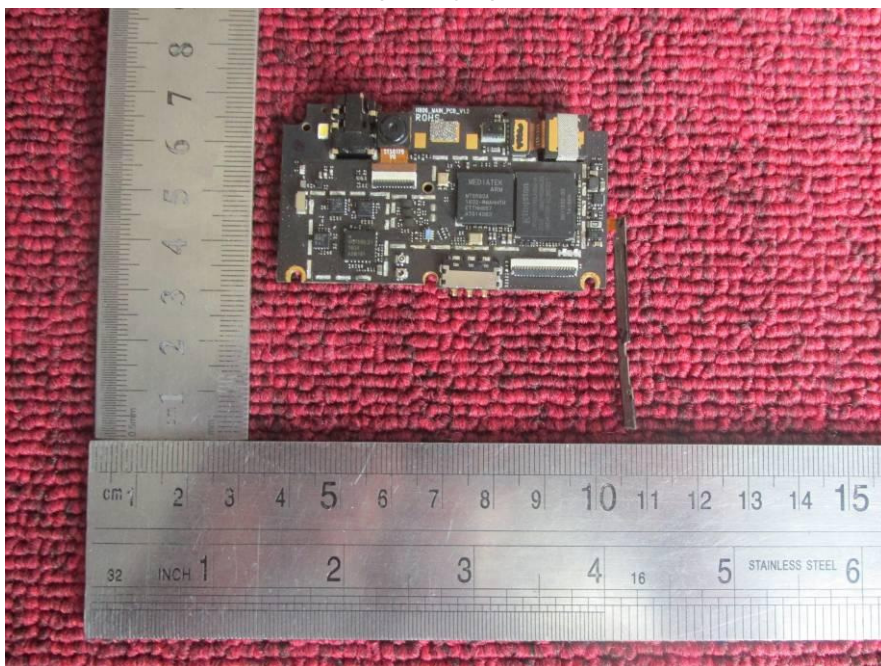

Internal photograph of EUT

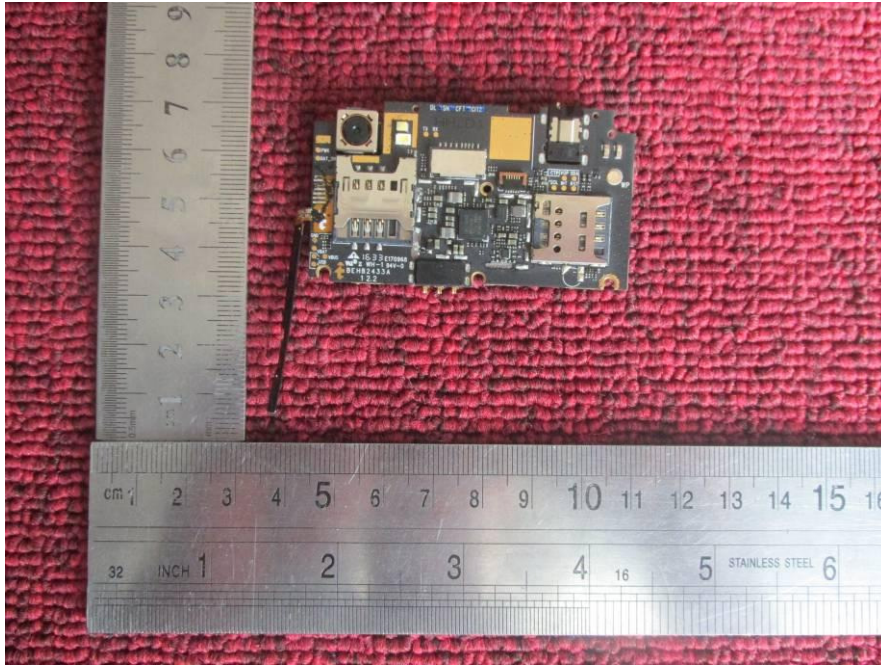

Internal photograph of EUT

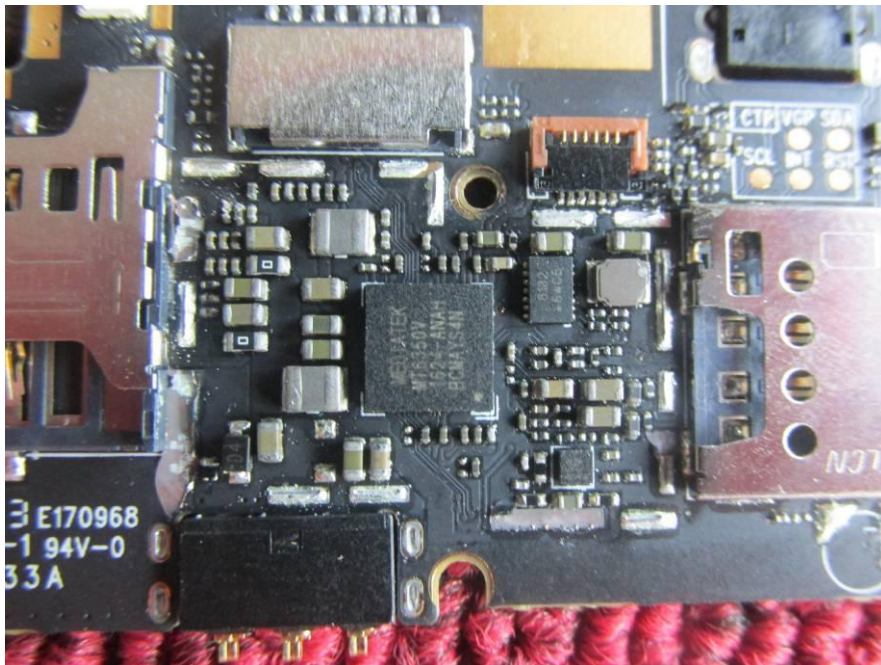

Internal photograph of EUT



Internal photograph of EUT

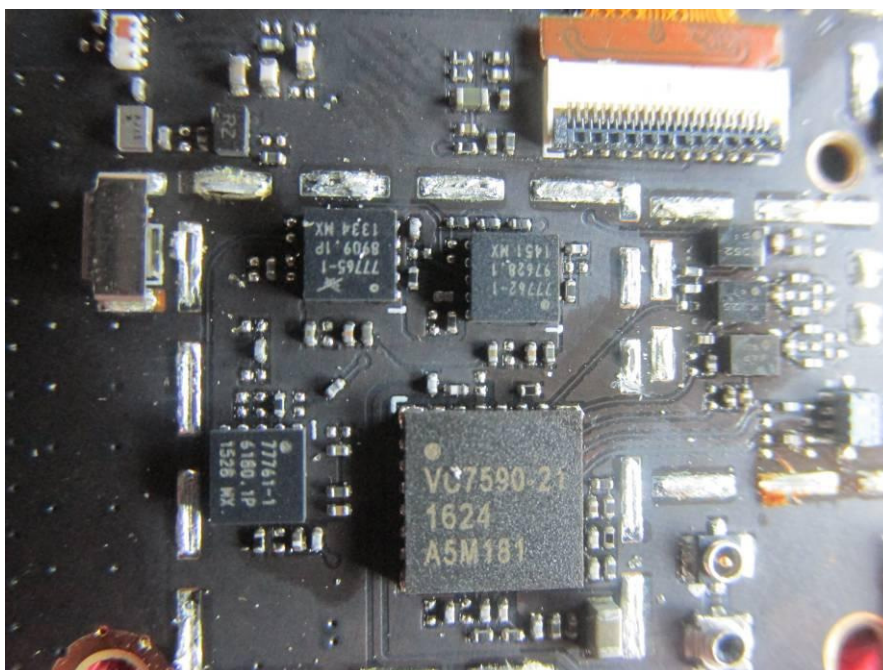

---END OF REPORT---