

FCC Report

Application Purpose : Original grant

Applicant Name: : TECNO MOBILE LIMITED

FCC ID : 2ADYY-W3

Equipment Type : Mobile phone

Model Name : W3

Report Number : FCC16093987A-4

Standard(S) : FCC Part 15 Subpart B

Date Of Receipt : September 18, 2016

Date Of Issue : October 15, 2016

Test By : 

(Daisy Qin)

Reviewed By : 

(Sol Qin)

Authorized by : 

(Michal Ling)

Prepared by : **QTC Certification & Testing Co., Ltd.**
2nd Floor,Bl Building,Fengyeyuan Industrial Plant,,
Liuxian 2st. Road, Xin'an Street, Bao'an
District,,Shenzhen,518000
Registration Number: 588523

REPORT REVISE RECORD

Report Version	Revise Time	Issued Date	Valid Version	Notes
V1.0	/	October 15, 2016	Valid	Original Report

Table of Contents	Page
1. GENERAL INFORMATION	4
2. TEST DESCRIPTION	6
2.1 MEASUREMENT UNCERTAINTY	6
2.2 DESCRIPTION OF TEST MODES	7
2.3 CONFIGURATION OF SYSTEM UNDER TEST	8
2.4 DESCRIPTION OF SUPPORT UNITS (CONDUCTED MODE)	9
3. SUMMARY OF TEST RESULTS	10
4. MEASUREMENT INSTRUMENTS	11
5. EMC EMISSION TEST	12
5.1 CONDUCTED EMISSION MEASUREMENT	12
5.1.1 POWER LINE CONDUCTED EMISSION LIMITS	12
5.1.2 TEST PROCEDURE	13
5.1.3 DEVIATION FROM TEST STANDARD	13
5.1.4 TEST SETUP	13
5.1.5 EUT OPERATING CONDITIONS	13
5.1.6 TEST RESULTS	14
5.2 RADIATED EMISSION MEASUREMENT	24
5.2.1 RADIATED EMISSION LIMITS	24
5.2.2 TEST PROCEDURE	25
5.2.3 DEVIATION FROM TEST STANDARD	25
5.2.4 TEST SETUP	26
5.2.5 EUT OPERATING CONDITIONS	26
5.2.5.1 TEST RESULTS (BETWEEN 30M – 1000 MHZ)	27
5.2.5.2 TEST RESULTS (1GHZ TO 6GHZ)	37
5.2.5.3 ADDITIONAL TEST RESULTS FOR INTENTIONAL EMISSIONS (1GHZ TO 24GHZ)	40
6. EUT TEST PHOTO	42
7. PHOTOGRAPHS OF EUT	44

1. GENERAL INFORMATION

Test Model	W3
Applicant	TECNO MOBILE LIMITED
Address	ROOMS 05-15, 13A/F., SOUTH TOWER,WORLD FINANCE CENTRE, HARBOUR CITY, 17 CANTON ROAD, TSIM SHA TSUI, KOWLOON, HONG KONG
Manufacturer	SHENZHEN TECNO TECHNOLOGY CO.,LTD.
Address	1-4th Floor,3rd Building,Pacific Industrial Park,No.2088,Shenyan Road,Yantian District,Shenzhen,Guangdong,China
Equipment Type	Mobile phone
Brand Name	TECNO
Hardware	H806_Main_PCB_V1.2
Software	W3-H806D1-M-160824V1
Battery information:	Li-ion Battery : BL-25FT Voltage: 3.8V Capacity: 2500mAh Limited Charge Voltage: 4.35V
Adapter Information:	Adapter: A8-501000 Input: AC 100-240VAC 50/60Hz 0.2A Output: DC 5V 1A
Data of receipt	September 18, 2016
Date of test	September 18, 2016 to October 15, 2016
Deviation	None
Condition of Test Sample	Normal

We hereby certify that:

The above equipment was tested by QTC Certification & Testing Co., Ltd.

2nd Floor, BI Building, Fengyeyuan Industrial Plant, Liuxian 2st. Road, Xin'an Street, Bao'an District, Shenzhen, 518000

Registration Number: 588523

The data evaluation, test procedures, and equipment configurations shown in this report were made in accordance with the procedures given in ANSI C 63.4:2014. The sample tested as described in this report is in compliance with the FCC Rules Part 15 Subpart B.

The test results of this report relate only to the tested sample identified in this report.

2. TEST DESCRIPTION

2.1 MEASUREMENT UNCERTAINTY

The reported uncertainty of measurement $y \pm U$, where expanded uncertainty U is based on a standard uncertainty multiplied by a coverage factor of $k=2$, providing a level of confidence of approximately **95** %.

No.	Item	Uncertainty
1	Conducted Emission Test	$\pm 3.2\text{dB}$
2	RF power, conducted	$\pm 0.16\text{dB}$
3	Spurious emissions, conducted	$\pm 0.21\text{dB}$
4	All emissions, radiated(<1G)	$\pm 4.7\text{dB}$
5	All emissions, radiated(>1G)	$\pm 4.7\text{dB}$
6	Temperature	$\pm 0.5^\circ\text{C}$
7	Humidity	$\pm 2\%$

2.2 DESCRIPTION OF TEST MODES

To investigate the maximum EMI emission characteristics generates from EUT, the test system was pre-scanning tested base on the consideration of following EUT operation mode or test configuration mode which possible have effect on EMI emission level. Each of these EUT operation mode(s) or test configuration mode(s) mentioned above was evaluated respectively.

Pretest Mode	Description
Mode 1	Video Recording
Model 2	Video Playing
Mode 3	Exchange data with computer
Mode 4	GPS
Mode 5	FM
Mode 6	Bluetooth 3.0 Transmit CH Mid
Mode 7	Bluetooth 4.0 Transmit CH Mid
Mode 8	WIFI Transmit 802.11b CH Mid
Mode 9	WCDMA Band 2 Transmit CH Mid

For Conducted Emission	
Final Test Mode	Test with Keyboard and Mouse
Mode 1	Video Recording
Model 2	Video Playing
Mode 3	Exchange data with computer
Mode 4	GPS
Mode 5	FM

For Radiated Emission	
Final Test Mode	Test with Keyboard and Mouse
Mode 1	Video Recording
Model 2	Video Playing
Mode 3	Exchange data with computer
Mode 4	GPS
Mode 5	FM
Mode 6	Bluetooth 3.0 Transmit CH Mid
Mode 7	Bluetooth 4.0 Transmit CH Mid
Mode 8	WIFI Transmit 802.11b CH Mid
Mode 9	WCDMA Band 2 Transmit CH Mid

2.3 CONFIGURATION OF SYSTEM UNDER TEST

Mode 1&2&4&5&6&7&8&9:

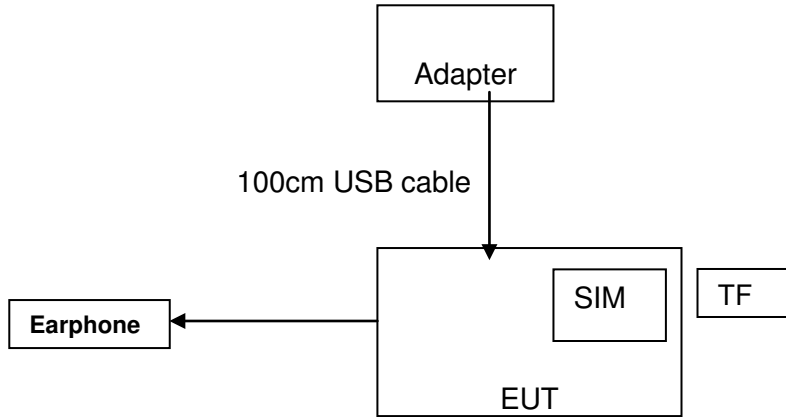

(EUT: Mobile phone)

Mode 3:

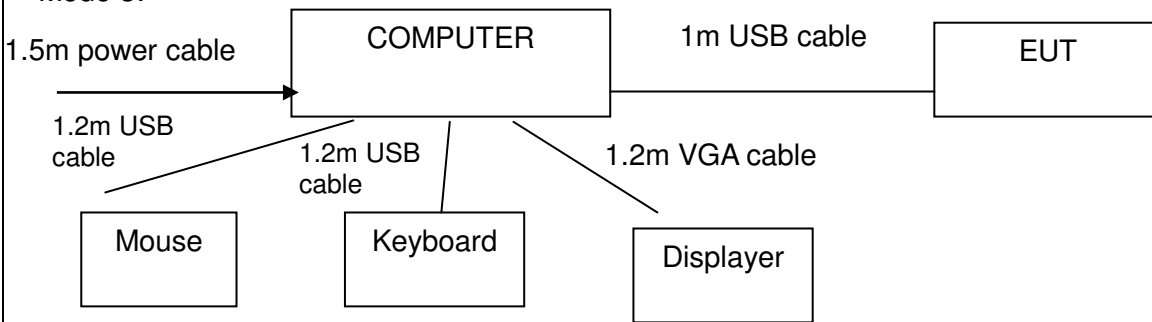

(EUT: Mobile phone)

I/O Port of EUT			
I/O Port Type	Q'TY	Cable	Tested with
Power	1	1m USB cable, unshielded	1
Earphone	1	1m cable, unshielded	1

2.4 DESCRIPTION OF SUPPORT UNITS (CONDUCTED MODE)

The EUT has been tested as an independent unit together with other necessary accessories or support units. The following support units or accessories were used to form a representative test configuration during the tests.

Item	Equipment	Mfr/Brand	Model/Type No.	Series No.	Note
1	Adapter	/	A8-501000	/	/
2	Keyboard	HP	SK-2880	435302-AA	/
3	Mouse	DELL	MS111-1	/	/

Note:

- (1) The support equipment was authorized by Declaration of Confirmation.
- (2) For detachable type I/O cable should be specified the length in cm in 『Length』 column.

3. SUMMARY OF TEST RESULTS

Test procedures according to the technical standards:

FCC Part15 , Subpart B			
Standard Section	Test Item	Judgment	Remark
15.107	CONDUCTED EMISSION	PASS	
15.109	RADIATED EMISSION	PASS	

NOTE:

(1) "N/A" denotes test is not applicable in this test report.

4. MEASUREMENT INSTRUMENTS

Kind of Equipment	Manufacturer	Type No.	Serial No.	Last Calibrated	Calibrated until
ESCI Test Receiver	R&S	ESCI	100005	08/19/2016	08/18/2017
LISN	AFJ	LS16	16010222119	08/19/2016	08/18/2017
LISN(EUT)	Mestec	AN3016	04/10040	08/19/2016	08/18/2017
pre-amplifier	CDSI	PAP-1G18-38	--	08/19/2016	08/18/2017
System Controller	CT	SC100	-	08/19/2016	08/18/2017
Bi-log Antenna	Chase	CBL6111C	2576	08/19/2016	08/18/2017
Spectrum analyzer	R&S	FSU26	200409	08/19/2016	08/18/2017
Horn Antenna	SCHWARZBECK	9120D	1141	08/19/2016	08/18/2017
Bi-log Antenna	SCHWAREBECK	VULB9163	9163/340	08/19/2016	08/18/2017
Pre Amplifier	H.P.	HP8447E	2945A02715	10/13/2016	10/12/2017
9*6*6 Anechoic	--	--	--	08/21/2016	08/20/2017

5. EMC EMISSION TEST

5.1 CONDUCTED EMISSION MEASUREMENT

5.1.1 POWER LINE CONDUCTED EMISSION Limits (Frequency Range 150KHz-30MHz)

FREQUENCY (MHz)	Class A (dBuV)		Class B (dBuV)		Standard
	Quasi-peak	Average	Quasi-peak	Average	
0.15 -0.5	79.00	66.00	66 - 56 *	56 - 46 *	FCC
0.50 -5.0	73.00	60.00	56.00	46.00	FCC
5.0 -30.0	73.00	60.00	60.00	50.00	FCC

Note:

- (1) The tighter limit applies at the band edges.
- (2) The limit of " * " marked band means the limitation decreases linearly with the logarithm of the frequency in the range.

The following table is the setting of the receiver

Receiver Parameters	Setting
Attenuation	10 dB
Start Frequency	0.15 MHz
Stop Frequency	30 MHz
IF Bandwidth	9 kHz

5.1.2 TEST PROCEDURE

- The EUT was placed 0.4 meters from the horizontal ground plane with EUT being connected to the power mains through a line impedance stabilization network (LISN). All other support equipments powered from additional LISN(s). The LISN provide 50 Ohm/ 50uH of coupling impedance for the measuring instrument.
- Interconnecting cables that hang closer than 40 cm to the ground plane shall be folded back and forth in the center forming a bundle 30 to 40 cm long.
- I/O cables that are not connected to a peripheral shall be bundled in the center. The end of the cable may be terminated, if required, using the correct terminating impedance. The overall length shall not exceed 1 m.
- LISN at least 80 cm from nearest part of EUT chassis.
- For the actual test configuration, please refer to the related Item –EUT Test Photos.

5.1.3 DEVIATION FROM TEST STANDARD

No deviation

5.1.4 TEST SETUP

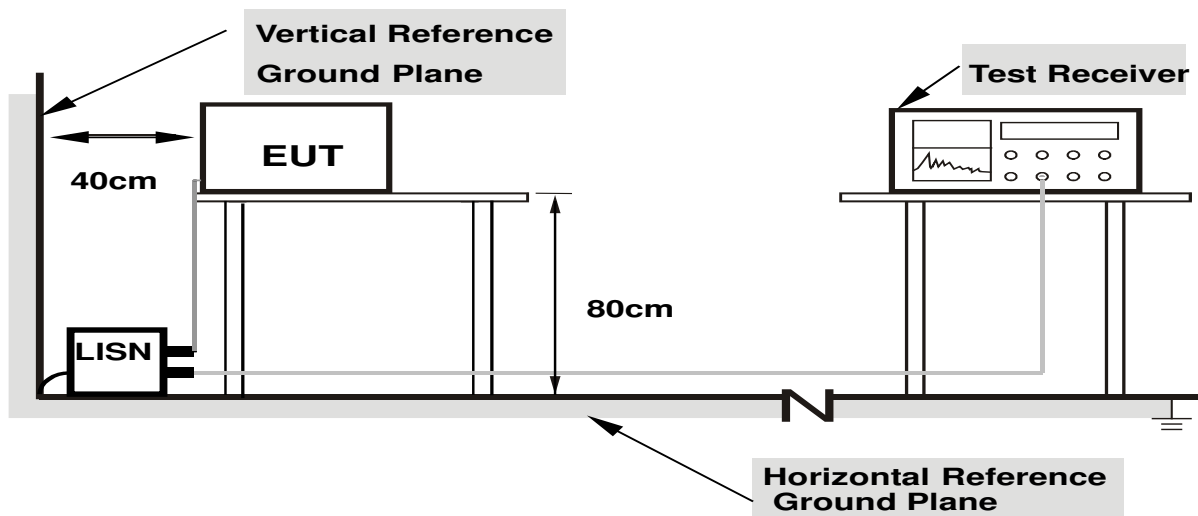

- Note: 1.Support units were connected to second LISN.
2.Both of LISNs (AMN) are 80 cm from EUT and at least 80 from other units and other metal planes**

5.1.5 EUT OPERATING CONDITIONS

The EUT was configured for testing in a typical fashion (as a customer would normally use it). The EUT has been programmed to continuously transmit during test. This operating condition was tested and used to collect the included data.

5.1.6 TEST RESULTS

EUT	Mobile phone	Model Name	W3
Temperature	26 °C	Relative Humidity	54%
Pressure	1010hPa	Phase	L
Test Date	October 08,2016	Test Mode	Mode 1

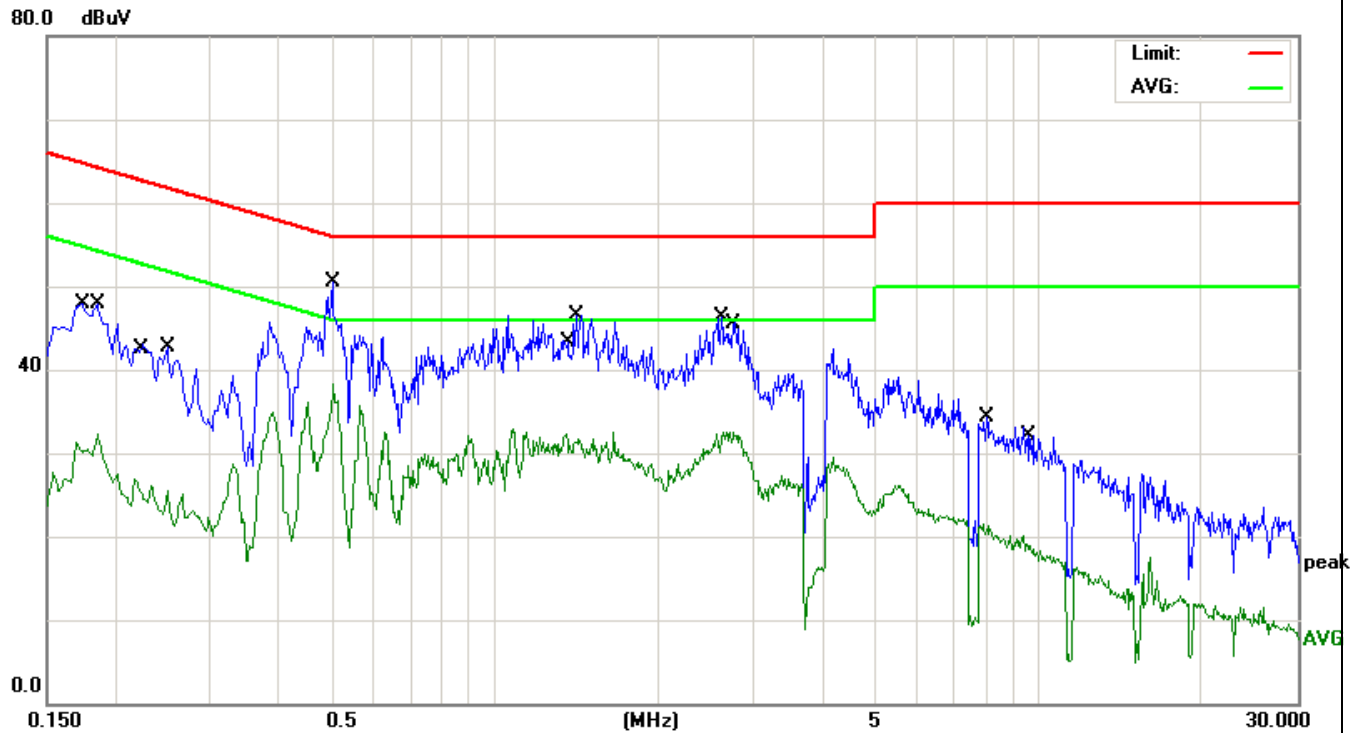

No.	Mk.	Freq. MHz	Reading Level dBuV	Correct Factor dB	Measure- ment dBuV	Limit dBuV	Over dB	Detector
1		0.1740	37.53	10.44	47.97	64.76	-16.79	QP
2		0.1860	21.91	10.44	32.35	54.21	-21.86	AVG
3		0.2208	15.67	10.43	26.10	52.79	-26.69	AVG
4		0.2508	31.14	10.43	41.57	61.73	-20.16	QP
5	*	0.5020	40.07	10.40	50.47	56.00	-5.53	QP
6		0.5060	27.82	10.40	38.22	46.00	-7.78	AVG
7		1.3540	21.95	10.32	32.27	46.00	-13.73	AVG
8		1.4140	36.21	10.32	46.53	56.00	-9.47	QP
9		2.6140	35.93	10.28	46.21	56.00	-9.79	QP
10		2.7180	22.29	10.28	32.57	46.00	-13.43	AVG
11		7.9100	11.29	10.21	21.50	50.00	-28.50	AVG
12		9.5980	21.99	10.19	32.18	60.00	-27.82	QP

EUT	Mobile phone	Model Name	W3
Temperature	26 °C	Relative Humidity	54%
Pressure	1010hPa	Phase	N
Test Date	October 08,2016	Test Mode	Mode 1

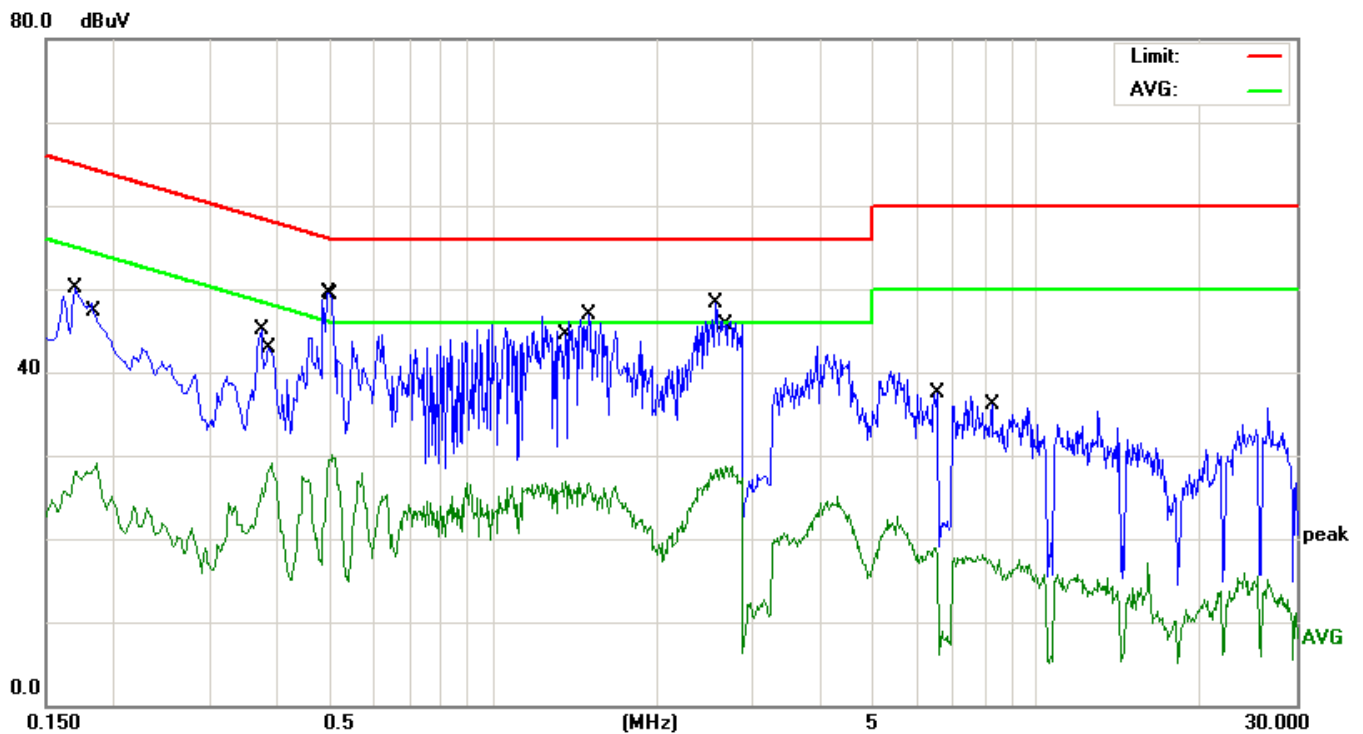

No.	Mk.	Freq. MHz	Reading Level dBuV	Correct Factor dB	Measure- ment dBuV	Limit dBuV	Over dB	Detector
1		0.1700	39.56	10.44	50.00	64.96	-14.96	QP
2		0.1860	18.58	10.44	29.02	54.21	-25.19	AVG
3		0.3740	34.66	10.41	45.07	58.41	-13.34	QP
4		0.3899	18.60	10.41	29.01	48.06	-19.05	AVG
5	*	0.4980	39.14	10.40	49.54	56.03	-6.49	QP
6		0.5060	19.77	10.40	30.17	46.00	-15.83	AVG
7		1.3540	16.65	10.32	26.97	46.00	-19.03	AVG
8		1.4980	36.55	10.32	46.87	56.00	-9.13	QP
9		2.5660	37.95	10.28	48.23	56.00	-7.77	QP
10		2.6700	18.49	10.28	28.77	46.00	-17.23	AVG
11		6.5660	8.07	10.22	18.29	50.00	-31.71	AVG
12		8.2660	25.82	10.20	36.02	60.00	-23.98	QP

EUT	Mobile phone	Model Name	W3
Temperature	26 °C	Relative Humidity	54%
Pressure	1010hPa	Phase	L
Test Date	October 08,2016	Test Mode	Mode 2

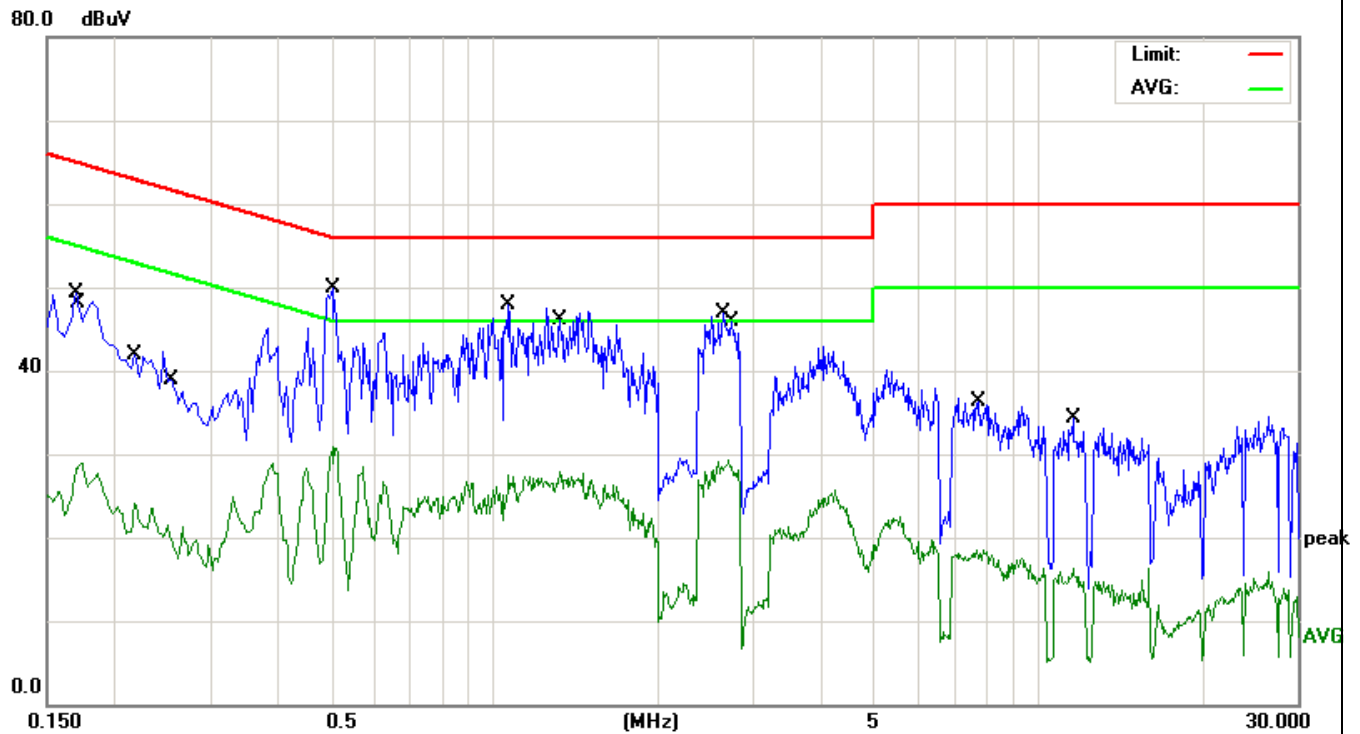

No.	Mk.	Freq. MHz	Reading Level dBuV	Correct Factor dB	Measure- ment dBuV	Limit dBuV	Over dB	Detector
1		0.1700	38.96	10.44	49.40	64.96	-15.56	QP
2		0.1740	18.56	10.44	29.00	54.76	-25.76	AVG
3		0.2180	13.76	10.43	24.19	52.89	-28.70	AVG
4		0.2540	28.57	10.43	39.00	61.62	-22.62	QP
5	*	0.5020	39.53	10.40	49.93	56.00	-6.07	QP
6		0.5020	20.50	10.40	30.90	46.00	-15.10	AVG
7		1.0620	37.62	10.34	47.96	56.00	-8.04	QP
8		1.3220	17.52	10.32	27.84	46.00	-18.16	AVG
9		2.6380	36.58	10.28	46.86	56.00	-9.14	QP
10		2.6940	19.06	10.28	29.34	46.00	-16.66	AVG
11		7.7100	8.35	10.21	18.56	50.00	-31.44	AVG
12		11.6100	24.20	10.18	34.38	60.00	-25.62	QP

EUT	Mobile phone	Model Name	W3
Temperature	26 °C	Relative Humidity	54%
Pressure	1010hPa	Phase	N
Test Date	October 08,2016	Test Mode	Mode 2

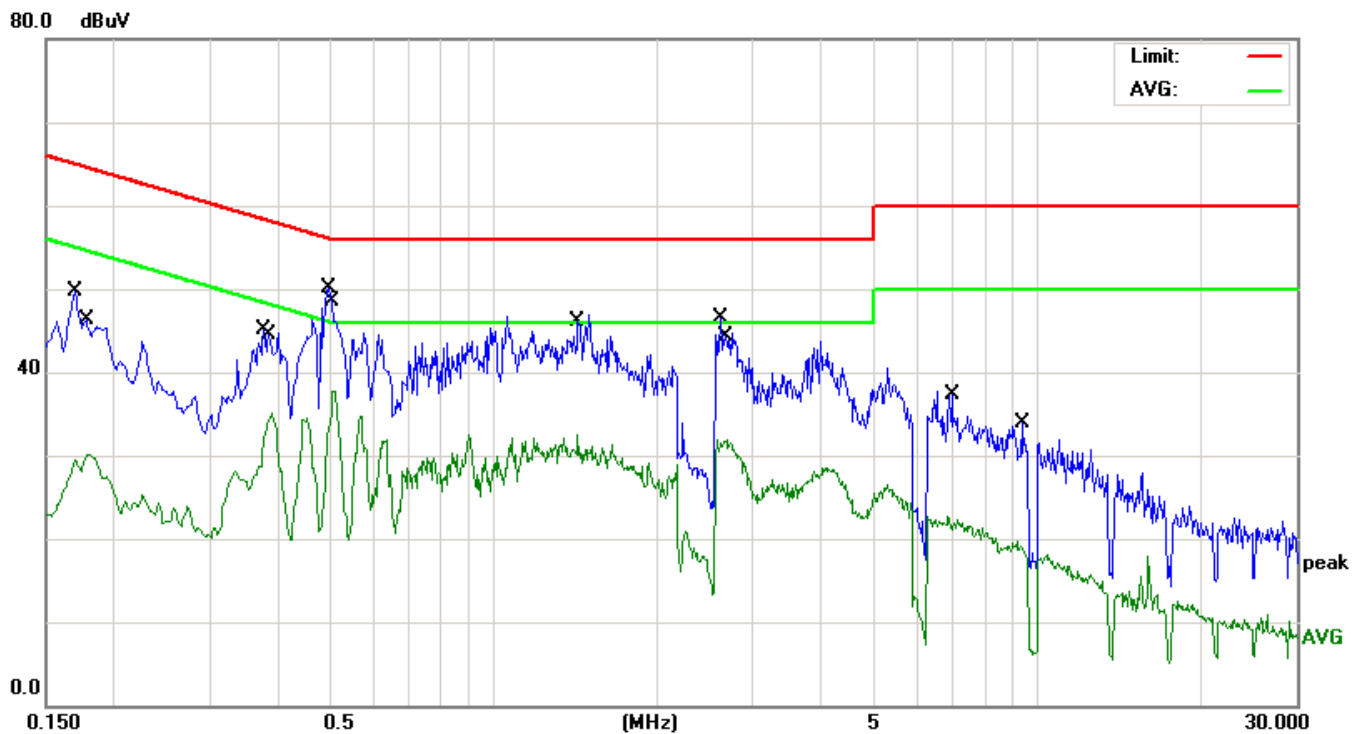

No.	Mk.	Freq. MHz	Reading Level dBuV	Correct Factor dB	Measure- ment dBuV	Limit dBuV	Over dB	Detector
1		0.1700	39.21	10.44	49.65	64.96	-15.31	QP
2		0.1780	19.69	10.44	30.13	54.57	-24.44	AVG
3		0.3780	34.66	10.41	45.07	58.32	-13.25	QP
4		0.3899	24.73	10.41	35.14	48.06	-12.92	AVG
5	*	0.4980	39.63	10.40	50.03	56.03	-6.00	QP
6		0.5100	27.38	10.40	37.78	46.00	-8.22	AVG
7		1.4299	35.85	10.32	46.17	56.00	-9.83	QP
8		1.4299	22.11	10.32	32.43	46.00	-13.57	AVG
9		2.6140	36.29	10.28	46.57	56.00	-9.43	QP
10		2.6860	21.68	10.28	31.96	46.00	-14.04	AVG
11		6.9140	12.32	10.21	22.53	50.00	-27.47	AVG
12		9.3540	23.74	10.20	33.94	60.00	-26.06	QP

EUT	Mobile phone	Model Name	W3
Temperature	26 °C	Relative Humidity	54%
Pressure	1010hPa	Phase	L
Test Date	October 08,2016	Test Mode	Mode 3

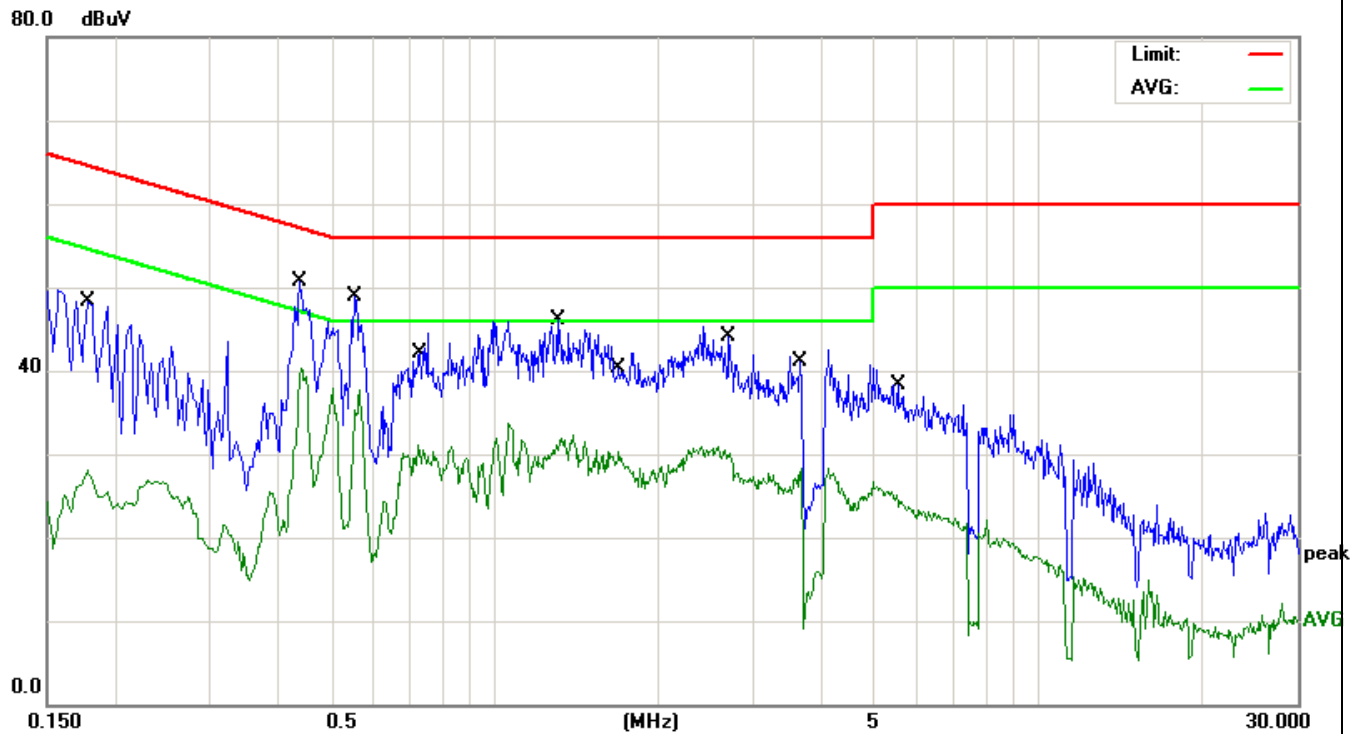

No.	Mk.	Freq.	Reading	Correct	Measure-	Limit	Over	
		MHz	Level	Factor	ment			Detector
			dBuV	dB	dBuV	dBuV	dB	
1		0.1780	37.80	10.44	48.24	64.57	-16.33	QP
2		0.1780	17.57	10.44	28.01	54.57	-26.56	AVG
3	*	0.4380	40.35	10.41	50.76	57.10	-6.34	QP
4	*	0.4380	40.35	10.41	50.76	57.10	-6.34	QP
5		0.4420	29.80	10.41	40.21	47.02	-6.81	AVG
6		0.5540	38.41	10.39	48.80	56.00	-7.20	QP
7		0.7260	20.71	10.37	31.08	46.00	-14.92	AVG
8		1.3060	35.70	10.32	46.02	56.00	-9.98	QP
9		1.6940	20.07	10.31	30.38	46.00	-15.62	AVG
10		2.7060	33.75	10.28	44.03	56.00	-11.97	QP
11		3.6660	18.08	10.26	28.34	46.00	-17.66	AVG
12		5.4780	14.81	10.23	25.04	50.00	-24.96	AVG

EUT	Mobile phone	Model Name	W3
Temperature	26 °C	Relative Humidity	54%
Pressure	1010hPa	Phase	N
Test Date	October 08,2016	Test Mode	Mode 3

80.0 dBuV

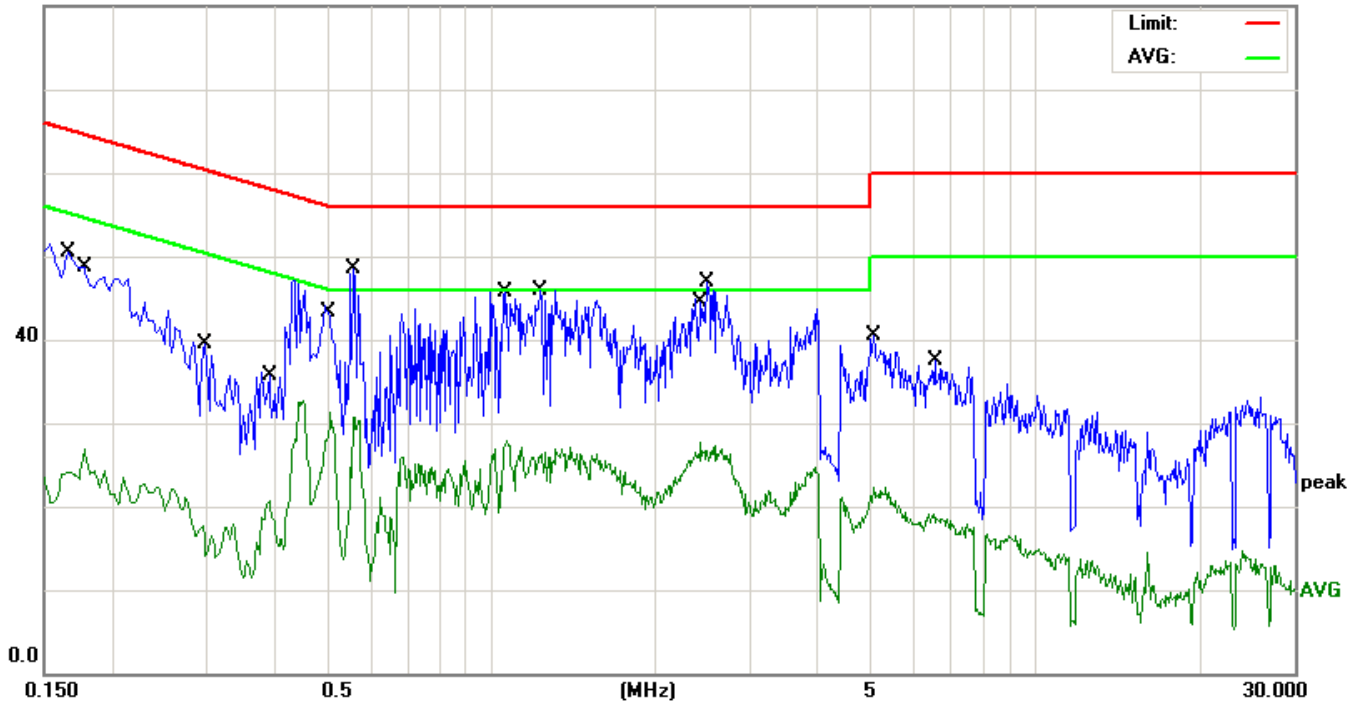

No.	Mk.	Freq. MHz	Reading Level dBuV	Correct Factor dB	Measure- ment dBuV	Limit dBuV	Over dB	Detector
1		0.1660	40.03	10.44	50.47	65.15	-14.68	QP
2		0.1780	16.38	10.44	26.82	54.57	-27.75	AVG
3		0.2980	29.00	10.42	39.42	60.30	-20.88	QP
4		0.3899	10.34	10.41	20.75	48.06	-27.31	AVG
5		0.5060	20.96	10.40	31.36	46.00	-14.64	AVG
6	*	0.5580	38.06	10.39	48.45	56.00	-7.55	QP
7		1.0700	17.52	10.34	27.86	46.00	-18.14	AVG
8		1.2260	35.60	10.33	45.93	56.00	-10.07	QP
9		2.4219	17.42	10.28	27.70	46.00	-18.30	AVG
10		2.4940	36.55	10.28	46.83	56.00	-9.17	QP
11		5.0500	12.12	10.23	22.35	50.00	-27.65	AVG
12		6.5260	27.26	10.22	37.48	60.00	-22.52	QP

EUT	Mobile phone	Model Name	W3
Temperature	26 °C	Relative Humidity	54%
Pressure	1010hPa	Phase	L
Test Date	October 08,2016	Test Mode	Mode 4

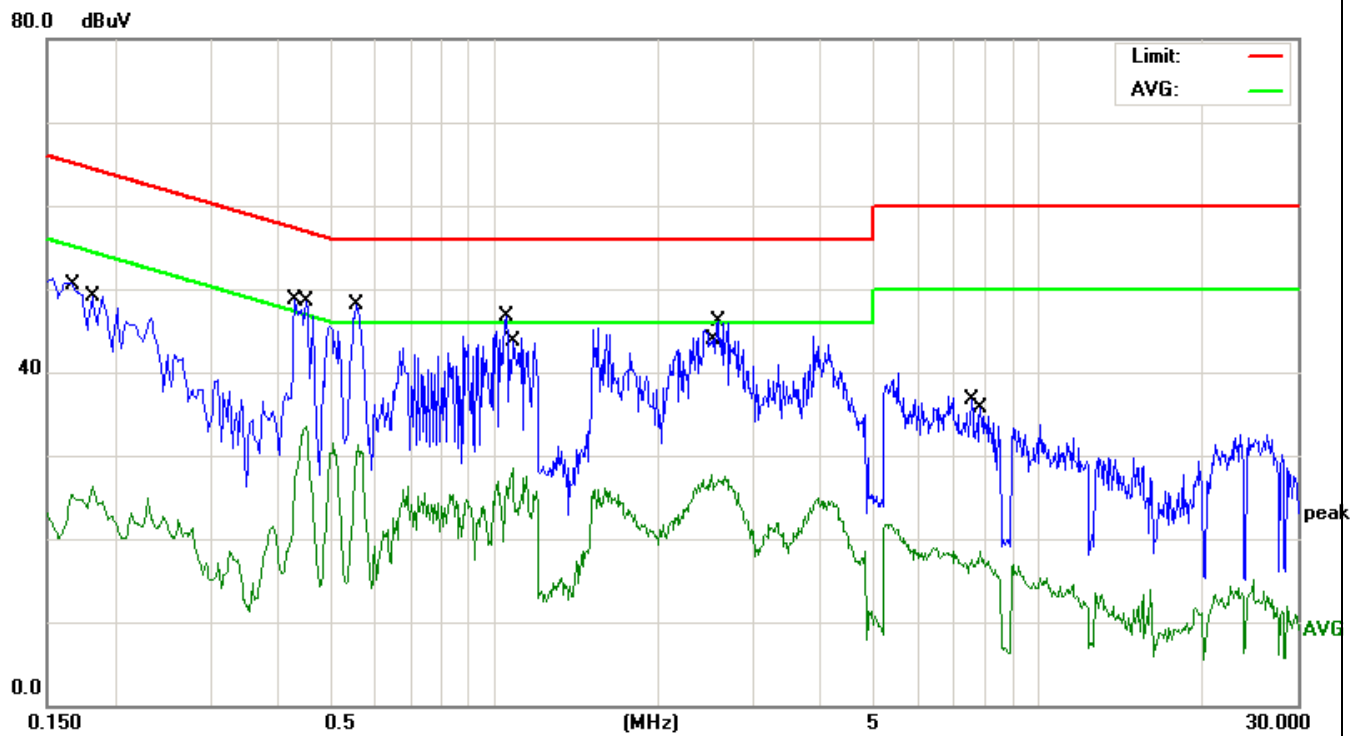

No.	Mk.	Freq. MHz	Reading Level dBuV	Correct Factor dB	Measure- ment dBuV	Limit dBuV	Over dB	Detector
1		0.1685	39.59	10.44	50.03	65.03	-15.00	QP
2		0.1819	15.96	10.44	26.40	54.39	-27.99	AVG
3		0.4300	38.27	10.41	48.68	57.25	-8.57	QP
4		0.4500	23.05	10.41	33.46	46.87	-13.41	AVG
5	*	0.5580	37.76	10.39	48.15	56.00	-7.85	QP
6		0.5620	20.90	10.39	31.29	46.00	-14.71	AVG
7		1.0540	36.37	10.34	46.71	56.00	-9.29	QP
8		1.0780	18.18	10.34	28.52	46.00	-17.48	AVG
9		2.5059	17.42	10.28	27.70	46.00	-18.30	AVG
10		2.5740	35.73	10.28	46.01	56.00	-9.99	QP
11		7.5620	26.53	10.21	36.74	60.00	-23.26	QP
12		7.8140	8.33	10.21	18.54	50.00	-31.46	AVG

EUT	Mobile phone	Model Name	W3
Temperature	26 °C	Relative Humidity	54%
Pressure	1010hPa	Phase	N
Test Date	October 08,2016	Test Mode	Mode 4

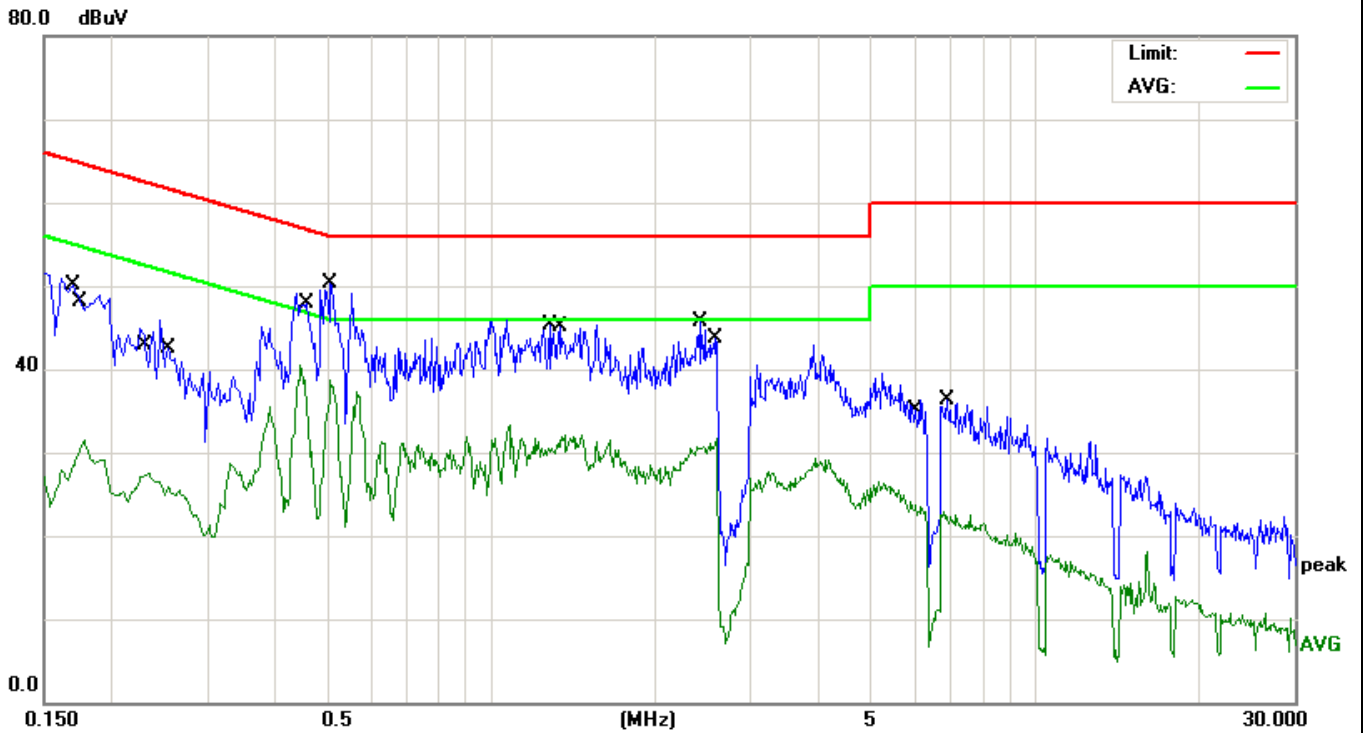

No.	Mk.	Freq. MHz	Reading Level dBuV	Correct Factor dB	Measure- ment dBuV	Limit dBuV	Over dB	Detector
1		0.1700	39.56	10.44	50.00	64.96	-14.96	QP
2		0.1780	21.12	10.44	31.56	54.57	-23.01	AVG
3		0.2340	17.11	10.43	27.54	52.30	-24.76	AVG
4		0.2540	32.12	10.43	42.55	61.62	-19.07	QP
5		0.4540	28.36	10.41	38.77	46.80	-8.03	AVG
6	*	0.5060	39.90	10.40	50.30	56.00	-5.70	QP
7		1.2780	35.06	10.33	45.39	56.00	-10.61	QP
8		1.3619	21.87	10.32	32.19	46.00	-13.81	AVG
9		2.4100	35.52	10.28	45.80	56.00	-10.20	QP
10		2.5980	21.36	10.28	31.64	46.00	-14.36	AVG
11		6.0500	13.40	10.22	23.62	50.00	-26.38	AVG
12		6.9060	26.13	10.21	36.34	60.00	-23.66	QP

EUT	Mobile phone	Model Name	W3
Temperature	26 °C	Relative Humidity	54%
Pressure	1010hPa	Phase	L
Test Date	October 08,2016	Test Mode	Mode 5

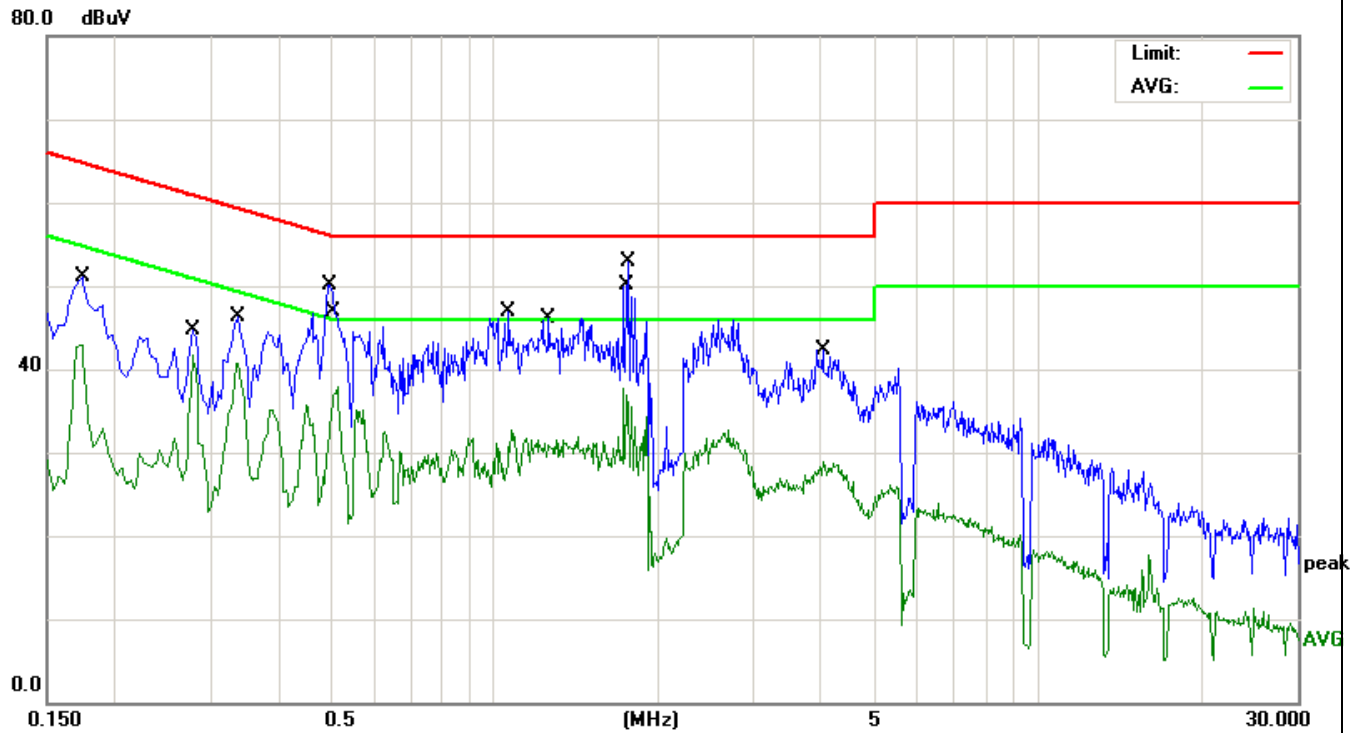

No.	Mk.	Freq. MHz	Reading Level dBuV	Correct Factor dB	Measure- ment dBuV	Limit dBuV	Over dB	Detector
1		0.1740	40.70	10.44	51.14	64.76	-13.62	QP
2		0.1740	32.54	10.44	42.98	54.76	-11.78	AVG
3		0.2779	31.18	10.43	41.61	50.88	-9.27	AVG
4		0.3339	35.50	10.42	45.92	59.35	-13.43	QP
5		0.4980	39.78	10.40	50.18	56.03	-5.85	QP
6		0.5140	27.43	10.40	37.83	46.00	-8.17	AVG
7		1.0740	22.35	10.34	32.69	46.00	-13.31	AVG
8		1.2620	35.83	10.33	46.16	56.00	-9.84	QP
9		1.7340	27.42	10.30	37.72	46.00	-8.28	AVG
10	*	1.7700	42.64	10.30	52.94	56.00	-3.06	QP
11		4.0260	32.09	10.25	42.34	56.00	-13.66	QP
12		4.0380	18.62	10.25	28.87	46.00	-17.13	AVG

EUT	Mobile phone	Model Name	W3
Temperature	26 °C	Relative Humidity	54%
Pressure	1010hPa	Phase	N
Test Date	October 08,2016	Test Mode	Mode 5

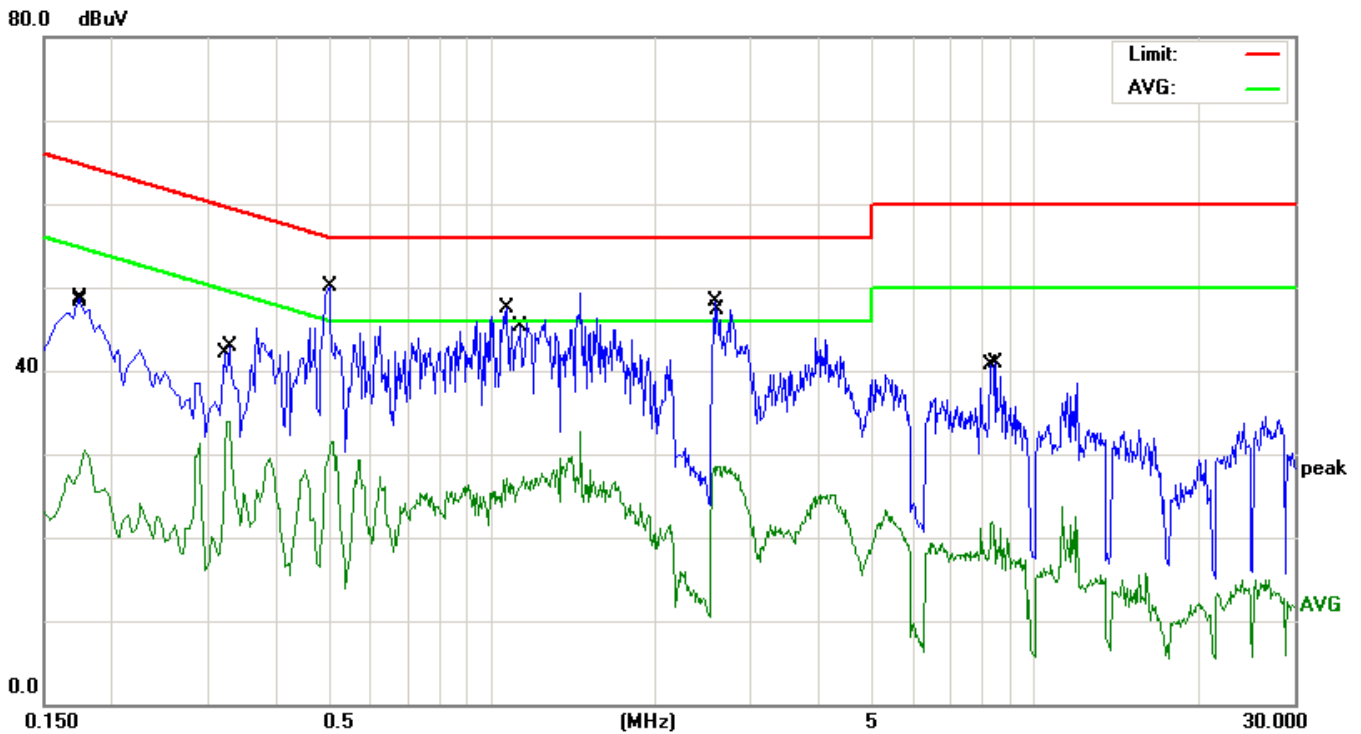

No.	Mk.	Freq. MHz	Reading Level dBuV	Correct Factor dB	Measure- ment dBuV	Limit dBuV	Over dB	Detector
1		0.1740	38.28	10.44	48.72	64.76	-16.04	QP
2		0.1780	19.99	10.44	30.43	54.57	-24.14	AVG
3		0.3220	31.61	10.42	42.03	59.65	-17.62	QP
4		0.3300	23.49	10.42	33.91	49.45	-15.54	AVG
5	*	0.5020	39.76	10.40	50.16	56.00	-5.84	QP
6		0.5100	21.19	10.40	31.59	46.00	-14.41	AVG
7		1.0660	37.14	10.34	47.48	56.00	-8.52	QP
8		1.1460	17.01	10.33	27.34	46.00	-18.66	AVG
9		2.5740	37.96	10.28	48.24	56.00	-7.76	QP
10		2.6300	18.24	10.28	28.52	46.00	-17.48	AVG
11		8.3660	11.75	10.20	21.95	50.00	-28.05	AVG
12		8.4940	30.79	10.20	40.99	60.00	-19.01	QP

5.2 RADIATED EMISSION MEASUREMENT

5.2.1 RADIATED EMISSION LIMITS (Frequency Range 9kHz-1000MHz)

20dBc in any 100 kHz bandwidth outside the operating frequency band. In case the emission fall within the restricted band specified on 15.205(a), then the 15.209(a) limit in the table below has to be followed.

Frequencies (MHz)	Field Strength (micorvolts/meter)	Measurement Distance (meters)
0.009~0.490	2400/F(KHz)	300
0.490~1.705	24000/F(KHz)	30
1.705~30.0	30	30
30~88	100	3
88~216	150	3
216~960	200	3
Above 960	500	3

LIMITS OF RADIATED EMISSION MEASUREMENT (Above 1000MHz)

FREQUENCY (MHz)	Limit (dBuV/m) (at 3M)	
	PEAK	AVERAGE
Above 1000	74	54

Notes:

- (1) The limit for radiated test was performed according to FCC PART 15C.
- (2) The tighter limit applies at the band edges.
- (3) Emission level (dBuV/m)=20log Emission level (uV/m).

Spectrum Parameter	Setting
Attenuation	Auto
Start Frequency	1000 MHz
Stop Frequency	10th carrier harmonic
RB / VB (emission in restricted band)	1 MHz / 1 MHz for Peak, 1 MHz / 1Hz for Average

Receiver Parameter	Setting
Attenuation	Auto
Start ~ Stop Frequency	9kHz~150kHz / RB 200Hz for QP
Start ~ Stop Frequency	150kHz~30MHz / RB 9kHz for QP
Start ~ Stop Frequency	30MHz~1000MHz / RB 120kHz for QP

5.2.2 TEST PROCEDURE

- a. The measuring distance of at 3 m shall be used for measurements at frequency up to 1GHz. For frequencies above 1GHz, any suitable measuring distance may be used.
- b. The EUT was placed on the top of a rotating table 0.8 meters above the ground at a 3 meter open area test site. The table was rotated 360 degrees to determine the position of the highest radiation.
- c. The height of the equipment or of the substitution antenna shall be 0.8 m; the height of the test antenna shall vary between 1 m to 4 m. Both horizontal and vertical polarizations of the antenna are set to make the measurement.
- d. The initial step in collecting conducted emission data is a spectrum analyzer peak detector mode pre-scanning the measurement frequency range. Significant peaks are then marked and then Quasi Peak detector mode re-measured.
- e. If the Peak Mode measured value compliance with and lower than Quasi Peak Mode Limit, the EUT shall be deemed to meet QP Limits and then no additional QP Mode measurement performed.
- f. For the actual test configuration, please refer to the related Item –EUT Test Photos.

Note:

Both horizontal and vertical antenna polarities were tested and performed pretest to three orthogonal axis. The worst case emissions were reported

5.2.3 DEVIATION FROM TEST STANDARD

No deviation

5.2.4 TEST SETUP

(A) Radiated Emission Test-Up Frequency 30MHz~1GHz

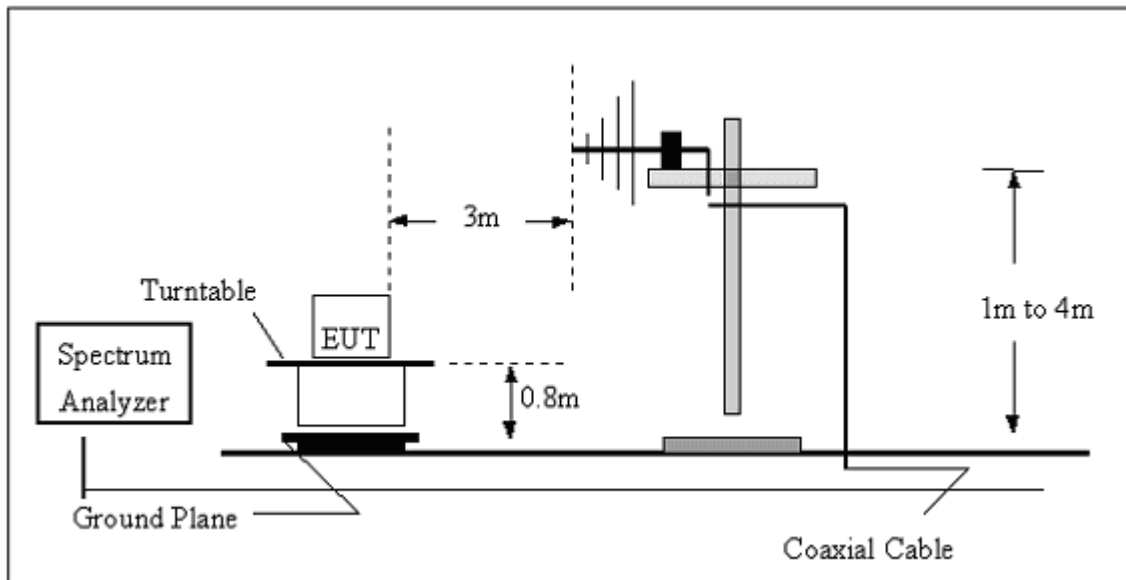

(B) Radiated Emission Test-Up Frequency Above 1GHz

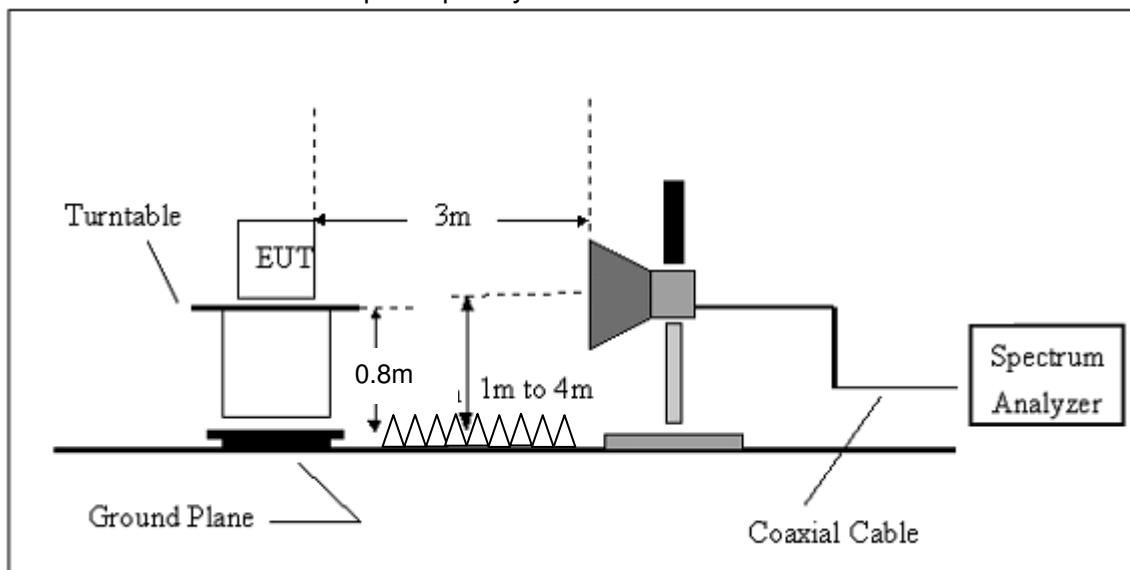

5.2.5 EUT OPERATING CONDITIONS

The EUT tested system was configured as the statements of 2.4 Unless otherwise a special operating condition is specified in the follows during the testing.

5.2.5.1 TEST RESULTS (BETWEEN 30M – 1000 MHZ)

EUT	Mobile phone	Model Name	W3
Temperature	20 °C	Relative Humidity	48%
Pressure	1010 hPa	Polarization :	Horizontal
Test Mode	Mode 1	Test Date	October 08,2016

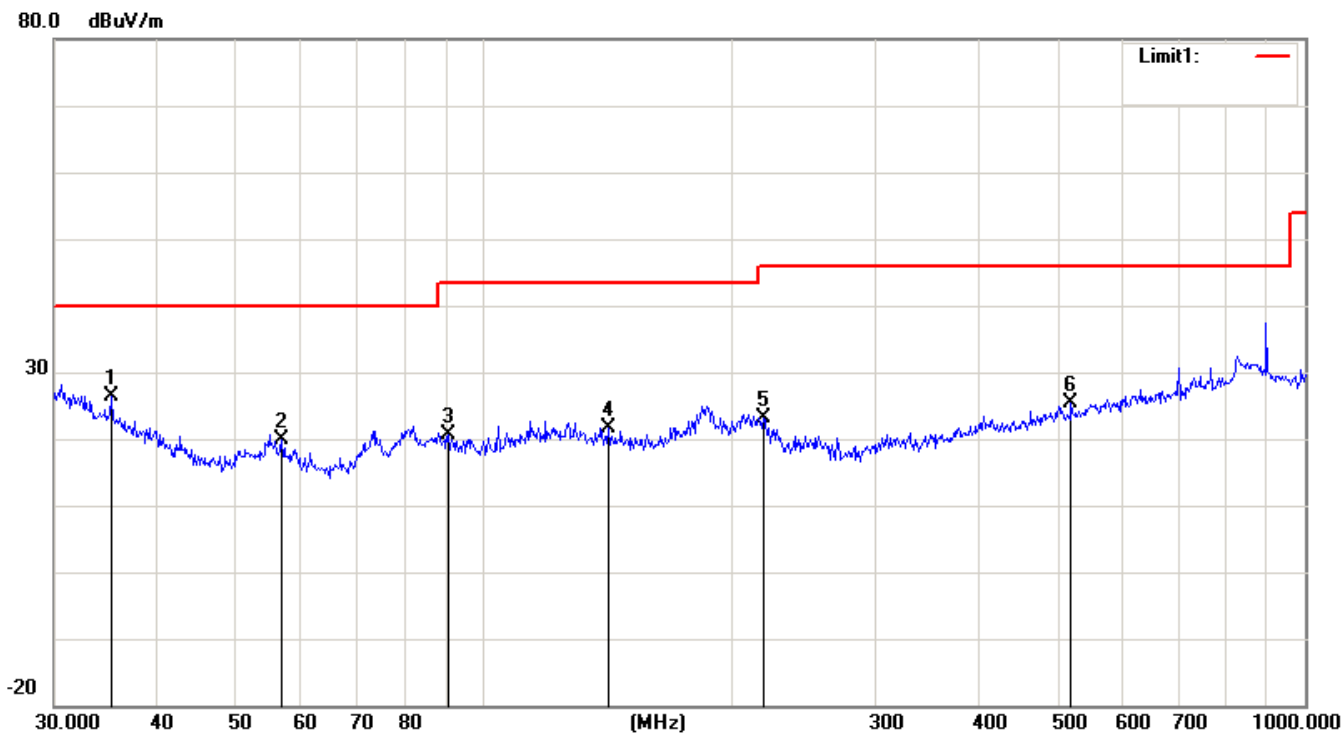

No.	Mk.	Freq. MHz	Reading Level dBuV	Correct Factor dB	Measure- ment dBuV/m	Limit dBuV/m	Over dB	Detector
1	*	35.2512	26.40	-0.06	26.34	40.00	-13.66	QP
2		56.7917	29.32	-9.46	19.86	40.00	-20.14	QP
3		90.5374	28.48	-7.92	20.56	43.50	-22.94	QP
4		141.8262	24.94	-3.19	21.75	43.50	-21.75	QP
5		219.0753	28.63	-5.50	23.13	46.00	-22.87	QP
6		519.0649	26.06	-0.66	25.40	46.00	-20.60	QP

EUT	Mobile phone	Model Name	W3
Temperature	20 °C	Relative Humidity	48%
Pressure	1010 hPa	Polarization :	Vertical
Test Mode	Mode 1	Test Date	October 08,2016

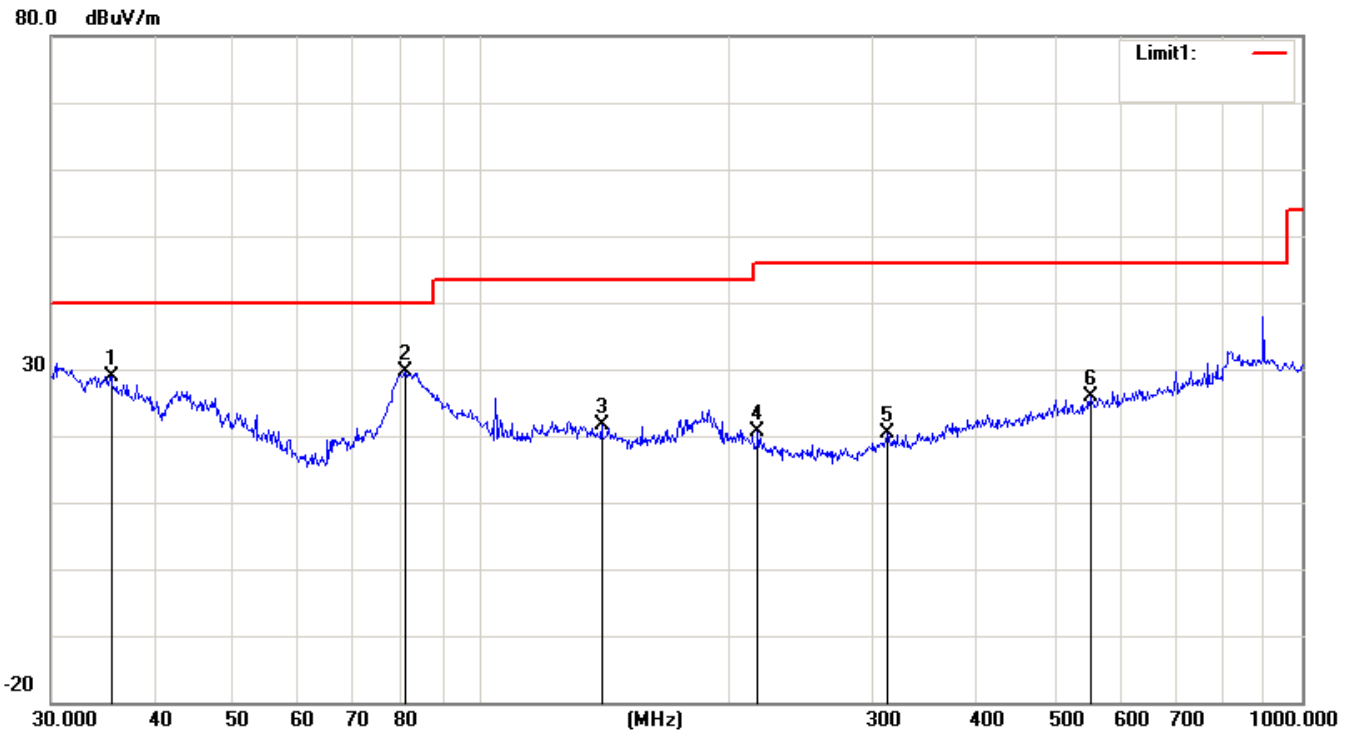

No.	Mk.	Freq. MHz	Reading Level dBuV	Correct Factor dB	Measure- ment dBuV/m	Limit dBuV/m	Over dB	Detector
1		35.4993	29.20	-0.23	28.97	40.00	-11.03	QP
2	*	80.9275	37.45	-7.79	29.66	40.00	-10.34	QP
3		140.3421	24.84	-3.10	21.74	43.50	-21.76	QP
4		217.5443	26.03	-5.44	20.59	46.00	-25.41	QP
5		313.2760	24.72	-4.38	20.34	46.00	-25.66	QP
6		552.8832	25.41	0.43	25.84	46.00	-20.16	QP

EUT	Mobile phone	Model Name	W3
Temperature	20 °C	Relative Humidity	48%
Pressure	1010 hPa	Polarization :	Horizontal
Test Mode	Mode 2	Test Date	October 08,2016

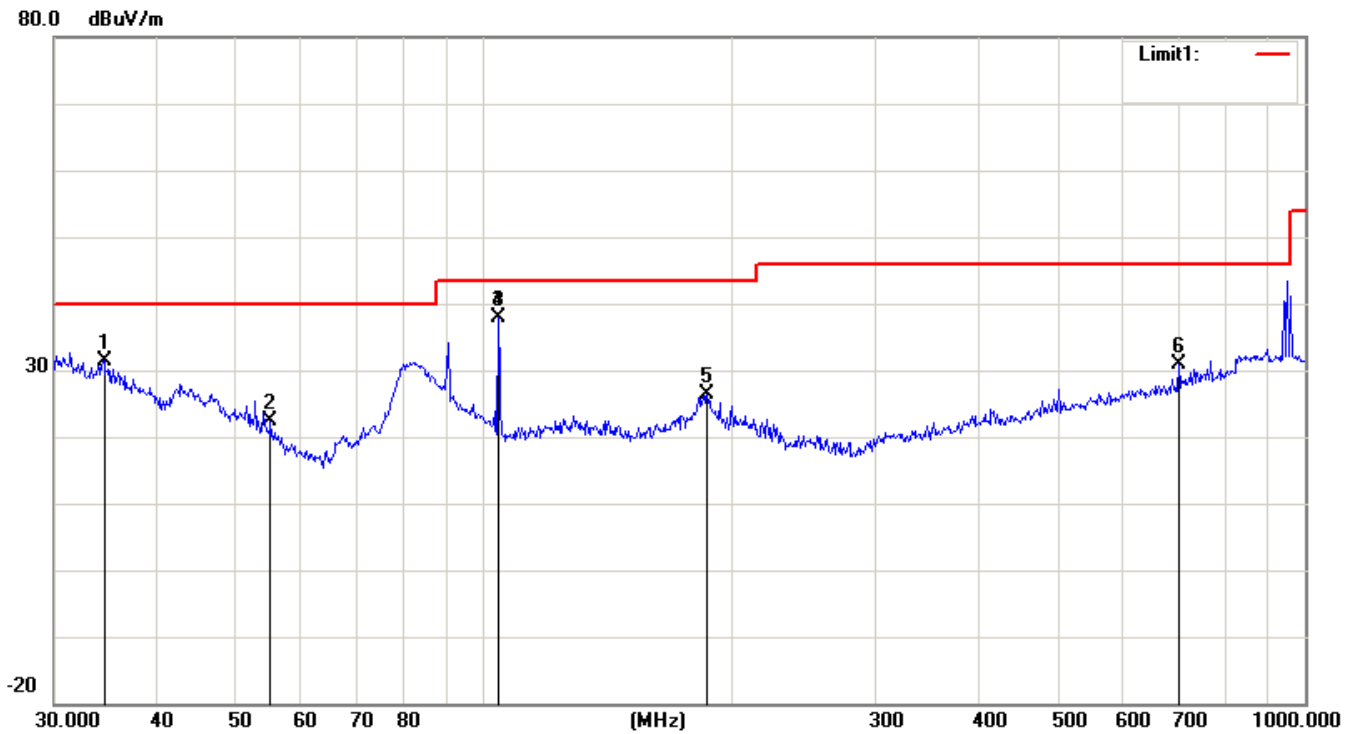

No.	Mk.	Freq. MHz	Reading Level dBuV	Correct Factor dB	Measure- ment dBuV/m	Limit dBuV/m	Over dB	Detector
1		34.5173	31.02	0.46	31.48	40.00	-8.52	QP
2		55.0274	31.77	-9.50	22.27	40.00	-17.73	QP
3	*	104.1701	42.98	-5.18	37.80	43.50	-5.70	QP
4	*	104.1701	42.98	-5.18	37.80	43.50	-5.70	QP
5		187.0958	31.76	-5.27	26.49	43.50	-17.01	QP
6		701.7610	28.56	2.42	30.98	46.00	-15.02	QP

EUT	Mobile phone	Model Name	W3
Temperature	20 °C	Relative Humidity	48%
Pressure	1010 hPa	Polarization :	Vertical
Test Mode	Mode 2	Test Date	October 08,2016

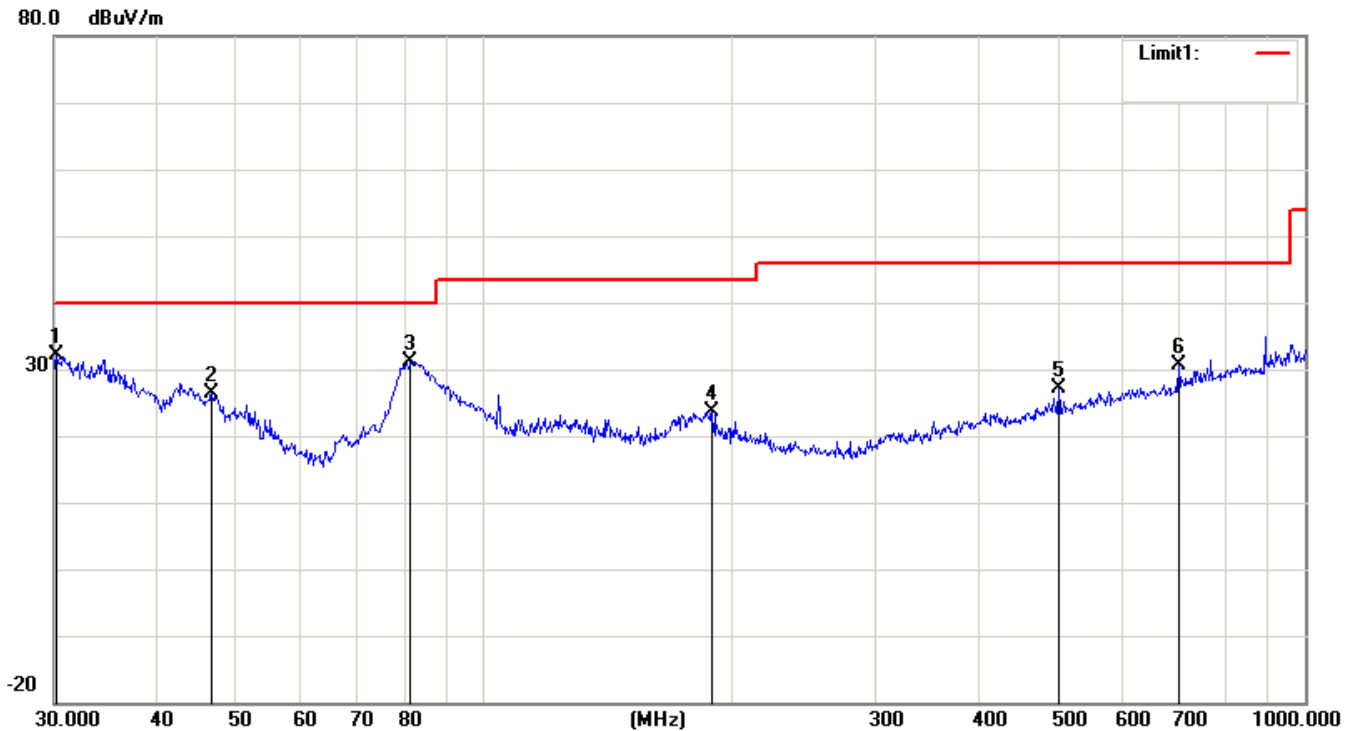

No.	Mk.	Freq. MHz	Reading Level dBuV	Correct Factor dB	Measure- ment dBuV/m	Limit dBuV/m	Over dB	Detector
1	*	30.2111	28.68	3.35	32.03	40.00	-7.97	QP
2		46.6664	33.95	-7.48	26.47	40.00	-13.53	QP
3		81.4970	39.03	-7.81	31.22	40.00	-8.78	QP
4		189.7385	28.88	-5.28	23.60	43.50	-19.90	QP
5		501.1790	28.23	-1.00	27.23	46.00	-18.77	QP
6		701.7610	28.23	2.42	30.65	46.00	-15.35	QP

EUT	Mobile phone	Model Name	W3
Temperature	20 °C	Relative Humidity	48%
Pressure	1010 hPa	Polarization :	Horizontal
Test Mode	Mode 3	Test Date	October 08,2016

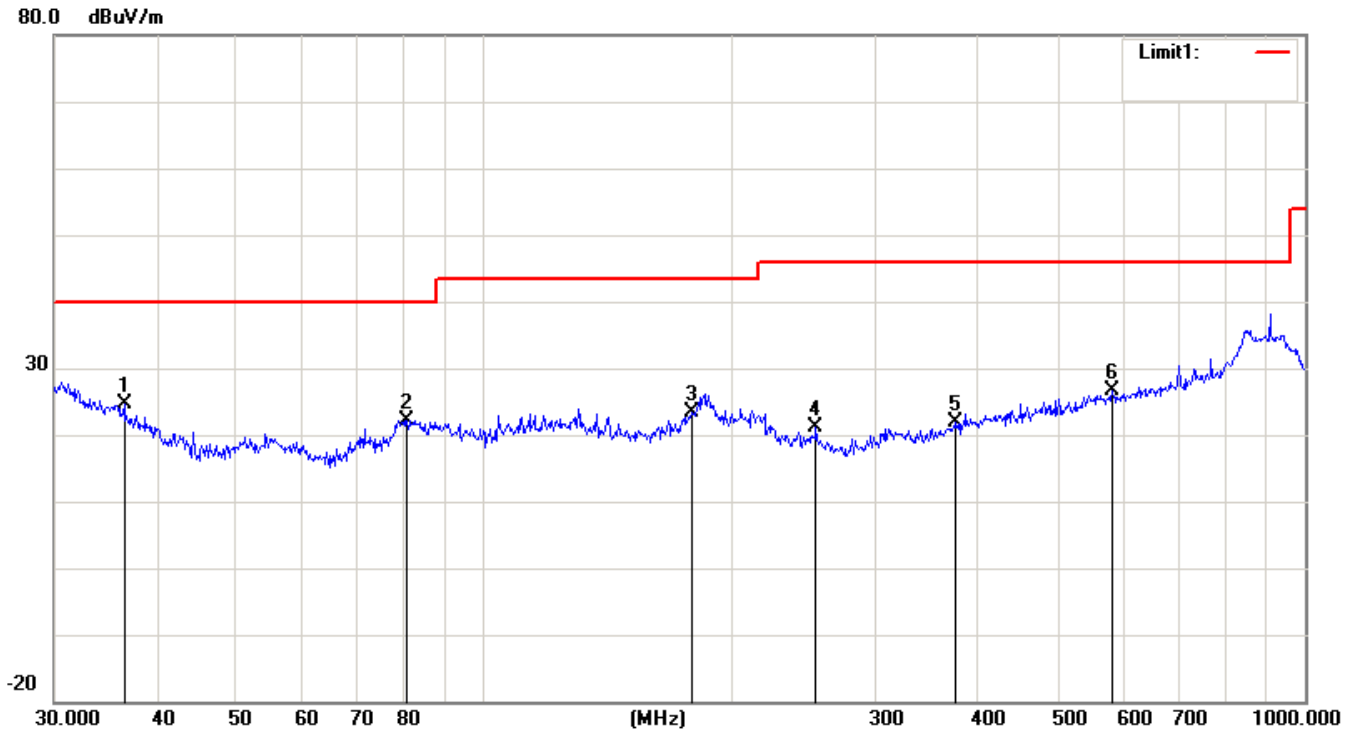

No.	Mk.	Freq. MHz	Reading Level dBuV	Correct Factor dB	Measure- ment dBuV/m	Limit dBuV/m	Over dB	Detector
1	*	36.5092	25.67	-0.97	24.70	40.00	-15.30	QP
2		80.6442	30.03	-7.78	22.25	40.00	-17.75	QP
3		179.3863	28.61	-5.15	23.46	43.50	-20.04	QP
4		253.8367	27.61	-6.53	21.08	46.00	-24.92	QP
5		374.6225	25.28	-3.47	21.81	46.00	-24.19	QP
6		582.7425	25.80	0.76	26.56	46.00	-19.44	QP

EUT	Mobile phone	Model Name	W3
Temperature	20 °C	Relative Humidity	48%
Pressure	1010 hPa	Polarization :	Vertical
Test Mode	Mode 3	Test Date	October 08,2016

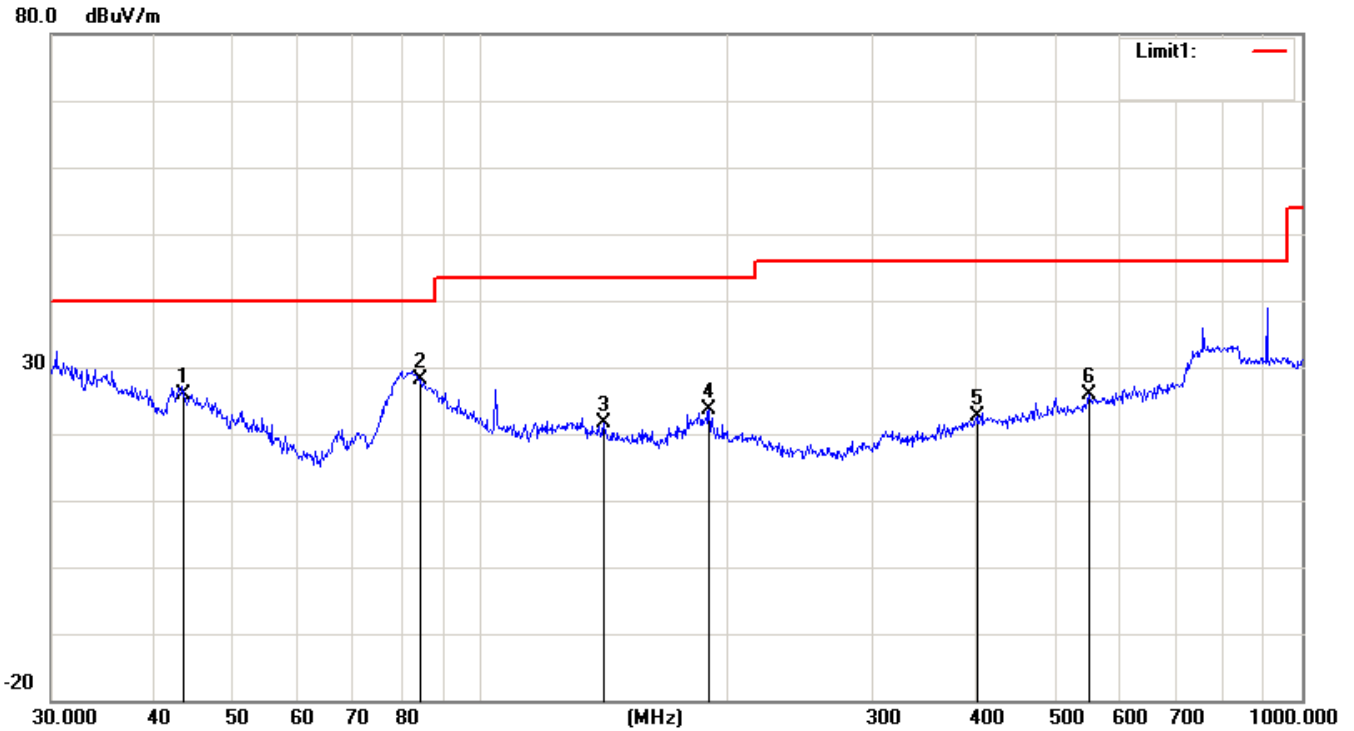

No.	Mk.	Freq. MHz	Reading Level dBuV	Correct Factor dB	Measure- ment dBuV/m	Limit dBuV/m	Over dB	Detector
1		43.5057	31.73	-5.75	25.98	40.00	-14.02	QP
2	*	84.4054	36.14	-7.94	28.20	40.00	-11.80	QP
3		141.3298	24.89	-3.16	21.73	43.50	-21.77	QP
4		189.7385	28.87	-5.28	23.59	43.50	-19.91	QP
5		403.2500	24.88	-2.24	22.64	46.00	-23.36	QP
6		550.9480	25.31	0.46	25.77	46.00	-20.23	QP

EUT	Mobile phone	Model Name	W3
Temperature	20 °C	Relative Humidity	48%
Pressure	1010 hPa	Polarization :	Horizontal
Test Mode	Mode 4	Test Date	October 08,2016

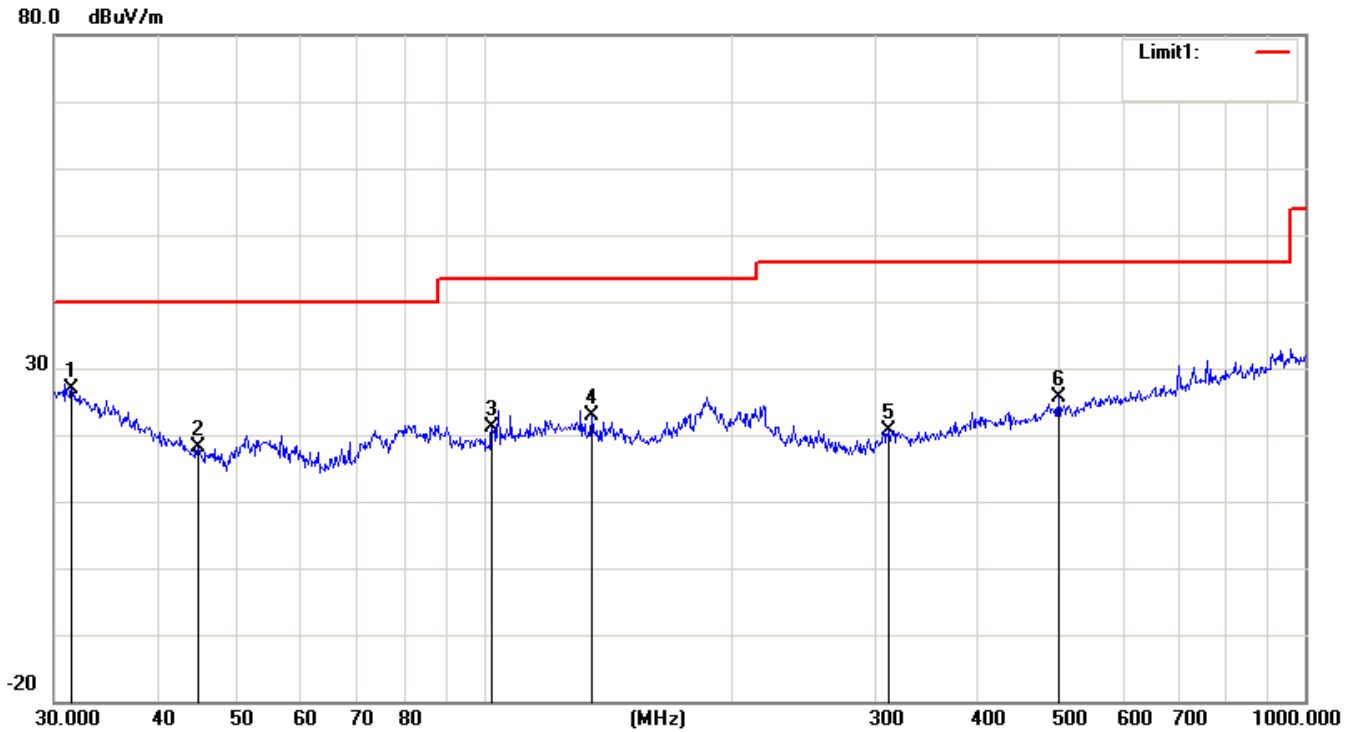

No.	Mk.	Freq. MHz	Reading Level dBuV	Correct Factor dB	Measure- ment dBuV/m	Limit dBuV/m	Over dB	Detector
1	*	31.5095	24.51	2.47	26.98	40.00	-13.02	QP
2		44.9006	24.76	-6.65	18.11	40.00	-21.89	QP
3		102.3597	26.84	-5.66	21.18	43.50	-22.32	QP
4		135.5062	25.86	-3.03	22.83	43.50	-20.67	QP
5		311.0867	25.00	-4.34	20.66	46.00	-25.34	QP
6		501.1790	26.66	-1.00	25.66	46.00	-20.34	QP

EUT	Mobile phone	Model Name	W3
Temperature	20 °C	Relative Humidity	48%
Pressure	1010 hPa	Polarization :	Vertical
Test Mode	Mode 4	Test Date	October 08,2016

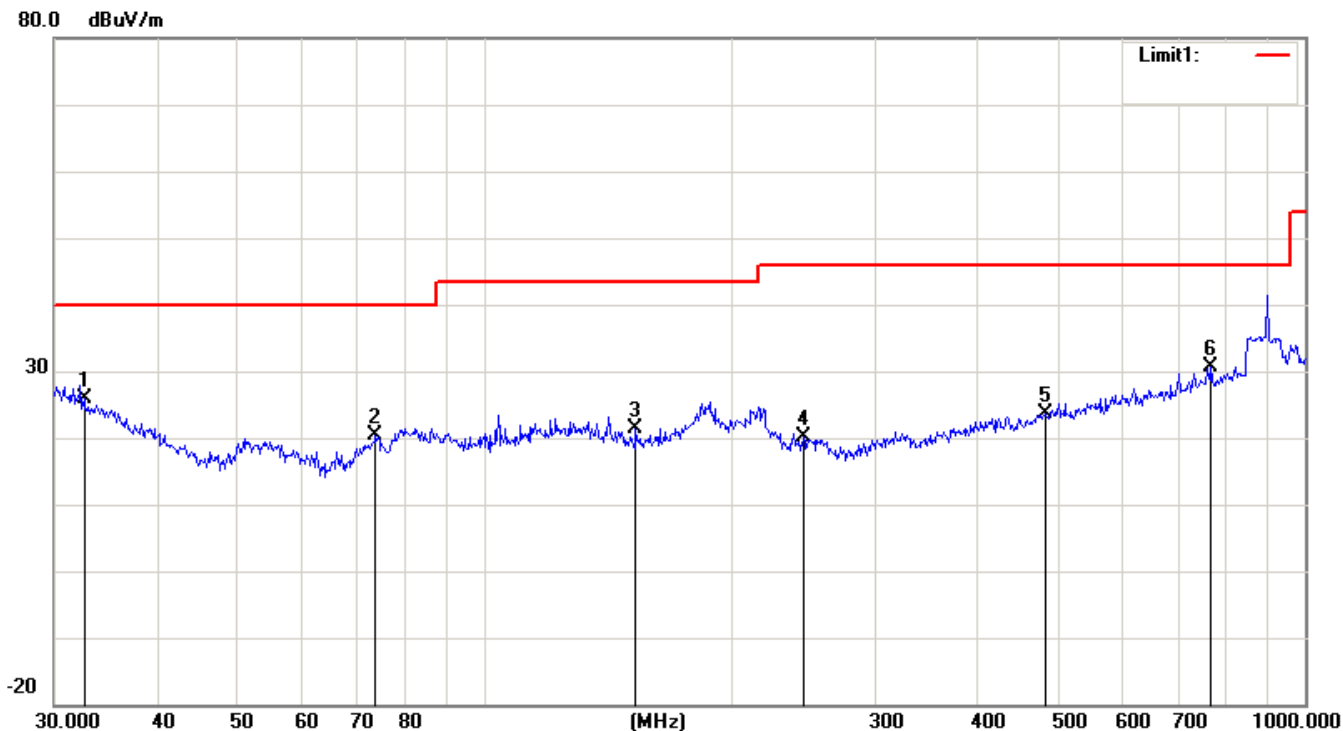

No.	Mk.	Freq. MHz	Reading Level dBuV	Correct Factor dB	Measure- ment dBuV/m	Limit dBuV/m	Over dB	Detector
1	*	32.6340	24.06	1.72	25.78	40.00	-14.22	QP
2		73.8756	27.99	-7.60	20.39	40.00	-19.61	QP
3		153.2004	25.47	-4.08	21.39	43.50	-22.11	QP
4		245.0900	26.54	-6.42	20.12	46.00	-25.88	QP
5		482.2156	24.65	-1.03	23.62	46.00	-22.38	QP
6		768.7481	26.99	3.67	30.66	46.00	-15.34	QP

EUT	Mobile phone	Model Name	W3
Temperature	20 °C	Relative Humidity	48%
Pressure	1010 hPa	Polarization :	Horizontal
Test Mode	Mode 5	Test Date	October 08,2016

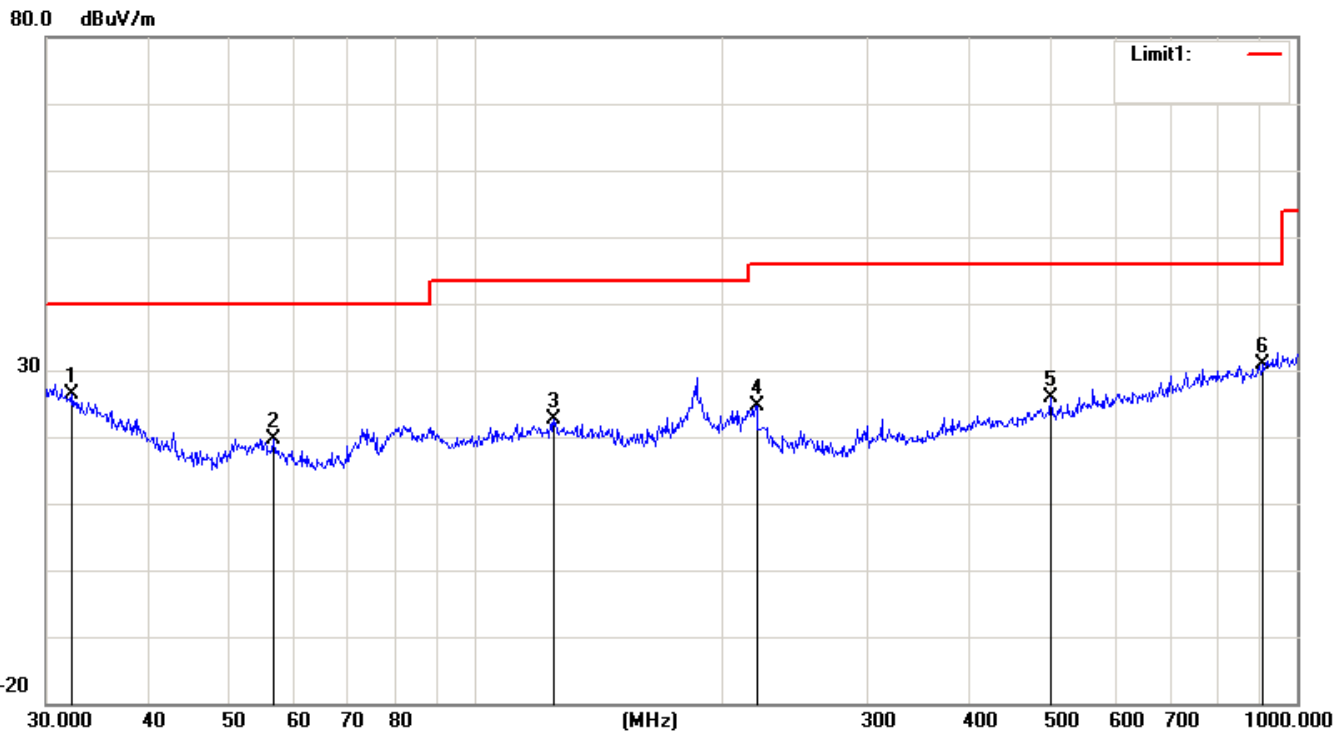

No.	Mk.	Freq. MHz	Reading Level dBuV	Correct Factor dB	Measure- ment dBuV/m	Limit dBuV/m	Over dB	Detector
1	*	32.2925	24.41	1.95	26.36	40.00	-13.64	QP
2		56.7917	29.19	-9.46	19.73	40.00	-20.27	QP
3		124.5690	24.72	-2.15	22.57	43.50	-20.93	QP
4		219.8449	30.21	-5.53	24.68	46.00	-21.32	QP
5		501.1790	26.97	-1.00	25.97	46.00	-20.03	QP
6		909.6667	24.54	6.26	30.80	46.00	-15.20	QP

EUT	Mobile phone	Model Name	W3
Temperature	20 °C	Relative Humidity	48%
Pressure	1010 hPa	Polarization :	Vertical
Test Mode	Mode 5	Test Date	October 08,2016

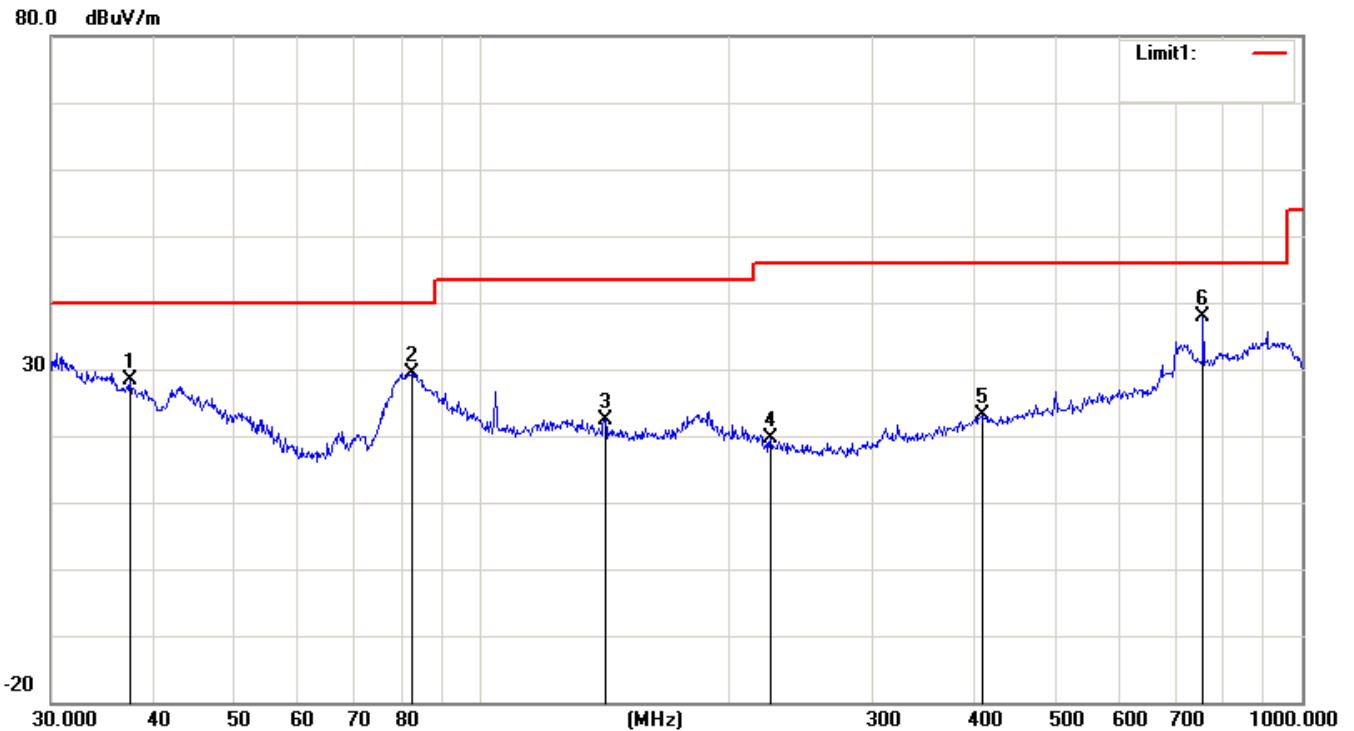

No.	Mk.	Freq. MHz	Reading Level dBuV	Correct Factor dB	Measure- ment dBuV/m	Limit dBuV/m	Over dB	Detector
1		37.4165	30.08	-1.63	28.45	40.00	-11.55	QP
2		82.3588	37.32	-7.84	29.48	40.00	-10.52	QP
3		141.8262	25.53	-3.19	22.34	43.50	-21.16	QP
4		225.3080	25.33	-5.72	19.61	46.00	-26.39	QP
5		407.5145	25.22	-2.05	23.17	46.00	-22.83	QP
6	*	758.0408	34.26	3.58	37.84	46.00	-8.16	QP

5.2.5.2 TEST RESULTS (1GHZ TO 6GHZ)

EUT	Mobile phone	Model Name	W3
Temperature	20 °C	Relative Humidity	48%
Pressure	1010 hPa	Test Mode	Mode 1
Test Date	October 08,2016		

Freq. (MHz)	Ant. Pol.	Emission Level(dBuV)		Limit 3m(dBuV/m)		Over(dB)	
		PK	AV	PK	AV	PK	AV
1632.45	V	58.54	41.84	74	54	-15.46	-12.16
2829.27	V	58.27	40.14	74	54	-15.73	-13.86
1684.52	H	59.26	40.49	74	54	-14.74	-13.51
2831.6	H	58.62	39.62	74	54	-15.38	-14.38

Remark:

All emissions not reported were more than 20dB below the specified limit or in the noise floor.

Factor = Antenna Factor + Cable Loss – Pre-amplifier.

All the x/y/z orientation has been investigated, and only worst case is presented in this report.

EUT	Mobile phone	Model Name	W3
Temperature	20 °C	Relative Humidity	48%
Pressure	1010 hPa	Test Mode	Mode 2
Test Date	October 08,2016		

Freq. (MHz)	Ant. Pol.	Emission Level(dBuV)		Limit 3m(dBuV/m)		Over(dB)	
		PK	AV	PK	AV	PK	AV
1583.35	V	60.70	41.11	74	54	-13.30	-12.89
2641.52	V	59.88	39.98	74	54	-14.12	-14.02
1628.42	H	58.22	39.05	74	54	-15.78	-14.95
2810.39	H	58.04	39.04	74	54	-15.96	-14.96

Remark:

All emissions not reported were more than 20dB below the specified limit or in the noise floor.

Factor = Antenna Factor + Cable Loss – Pre-amplifier.

All the x/y/z orientation has been investigated, and only worst case is presented in this report.

EUT	Mobile phone	Model Name	W3
Temperature	20 °C	Relative Humidity	48%
Pressure	1010 hPa	Test Mode	Mode 3
Test Date	October 08,2016		

Freq. (MHz)	Ant. Pol.	Emission Level(dBuV)		Limit 3m(dBuV/m)		Over(dB)	
		PK	AV	PK	AV	PK	AV
1577.35	V	58.65	41.77	74	54	-15.35	-12.23
2652.38	V	59.77	39.35	74	54	-14.23	-14.65
1699.33	H	59.55	39.99	74	54	-14.45	-14.01
2739.42	H	59.07	40.07	74	54	-14.93	-13.93

Remark:

All emissions not reported were more than 20dB below the specified limit or in the noise floor.

Factor = Antenna Factor + Cable Loss – Pre-amplifier.

All the x/y/z orientation has been investigated, and only worst case is presented in this report.

EUT	Mobile phone	Model Name	W3
Temperature	20 °C	Relative Humidity	48%
Pressure	1010 hPa	Test Mode	Mode 4
Test Date	October 08,2016		

Freq. (MHz)	Ant. Pol.	Emission Level(dBuV)		Limit 3m(dBuV/m)		Over(dB)	
		PK	AV	PK	AV	PK	AV
1577.35	V	59.17	39.46	74	54	-14.83	-14.54
2652.38	V	58.43	40.27	74	54	-15.57	-13.73
1699.33	H	58.04	40.86	74	54	-15.96	-13.14
2739.42	H	58.25	39.25	74	54	-15.75	-14.75

Remark:

All emissions not reported were more than 20dB below the specified limit or in the noise floor.

Factor = Antenna Factor + Cable Loss – Pre-amplifier.

All the x/y/z orientation has been investigated, and only worst case is presented in this report.

EUT	Mobile phone	Model Name	W3
Temperature	20 °C	Relative Humidity	48%
Pressure	1010 hPa	Test Mode	Mode 5
Test Date	October 08,2016		

Freq. (MHz)	Ant. Pol.	Emission Level(dBuV)		Limit 3m(dBuV/m)		Over(dB)	
		PK	AV	PK	AV	PK	AV
1577.35	V	59.65	41.70	74	54	-14.35	-12.30
2652.38	V	59.26	40.28	74	54	-14.74	-13.72
1699.33	H	58.18	40.32	74	54	-15.82	-13.68
2739.42	H	59.36	40.36	74	54	-14.64	-13.64

Remark:

All emissions not reported were more than 20dB below the specified limit or in the noise floor.

Factor = Antenna Factor + Cable Loss – Pre-amplifier.

All the x/y/z orientation has been investigated, and only worst case is presented in this report.

5.2.5.3 ADDITIONAL TEST RESULTS FOR INTENTIONAL EMISSIONS (1GHZ TO 24GHZ)

EUT	Mobile phone	Model Name	W3
Temperature	20 °C	Relative Humidity	48%
Pressure	1010 hPa	Test Mode	Mode 6

Freq. (MHz)	Ant. Pol.	Emission Level(dBuV)		Limit 3m(dBuV/m)		Over(dB)	
		PK	AV	PK	AV	PK	AV
4882	V	59.62	40.65	74	54	-14.38	-13.35
7323	V	58.77	40.29	74	54	-15.23	-13.71
4882	H	59.77	40.92	74	54	-14.23	-13.08
7323	H	58.98	39.98	74	54	-15.02	-14.02

Remark:

All emissions not reported were more than 20dB below the specified limit or in the noise floor.
All the x/y/z orientation has been investigated, and only worst case is presented in this report.

EUT	Mobile phone	Model Name	W3
Temperature	20 °C	Relative Humidity	48%
Pressure	1010 hPa	Test Mode	Mode 7

Freq. (MHz)	Ant. Pol.	Emission Level(dBuV)		Limit 3m(dBuV/m)		Over(dB)	
		PK	AV	PK	AV	PK	AV
4880	V	58.96	39.13	74	54	-15.04	-14.87
7320	V	59.30	40.89	74	54	-14.70	-13.11
4880	H	58.28	40.55	74	54	-15.72	-13.45
7320	H	59.18	40.18	74	54	-14.82	-13.82

Remark:

All emissions not reported were more than 20dB below the specified limit or in the noise floor.
All the x/y/z orientation has been investigated, and only worst case is presented in this report.

EUT	Mobile phone	Model Name	W3
Temperature	20 °C	Relative Humidity	48%
Pressure	1010 hPa	Test Mode	Mode 8

Freq. (MHz)	Ant. Pol.	Emission Level(dBuV)		Limit 3m(dBuV/m)		Over(dB)	
		PK	AV	PK	AV	PK	AV
4874	V	59.02	40.35	74	54	-14.98	-13.65
7311	V	59.78	40.71	74	54	-14.22	-13.29
4874	H	59.77	40.37	74	54	-14.23	-13.63
7311	H	58.95	39.95	74	54	-15.05	-14.05

Remark:

All emissions not reported were more than 20dB below the specified limit or in the noise floor.
All the x/y/z orientation has been investigated, and only worst case is presented in this report.

EUT	Mobile phone	Model Name	W3
Temperature	20 °C	Relative Humidity	48%
Pressure	1010 hPa	Test Mode	Mode 9

Freq. (MHz)	Ant. Pol.	Emission Level(dBuV)		Limit 3m(dBuV/m)		Over(dB)	
		PK	AV	PK	AV	PK	AV
3760	V	60.40	39.48	74	54	-13.60	-14.52
5640	V	59.61	40.04	74	54	-14.39	-13.96
3760	H	59.17	40.06	74	54	-14.83	-13.94
5640	H	59.82	40.82	74	54	-14.18	-13.18

Remark:

All emissions not reported were more than 20dB below the specified limit or in the noise floor.
All the x/y/z orientation has been investigated, and only worst case is presented in this report.

6. EUT TEST PHOTO

CONDUCTED EMISSION TEST



RADIATED EMISSION TEST

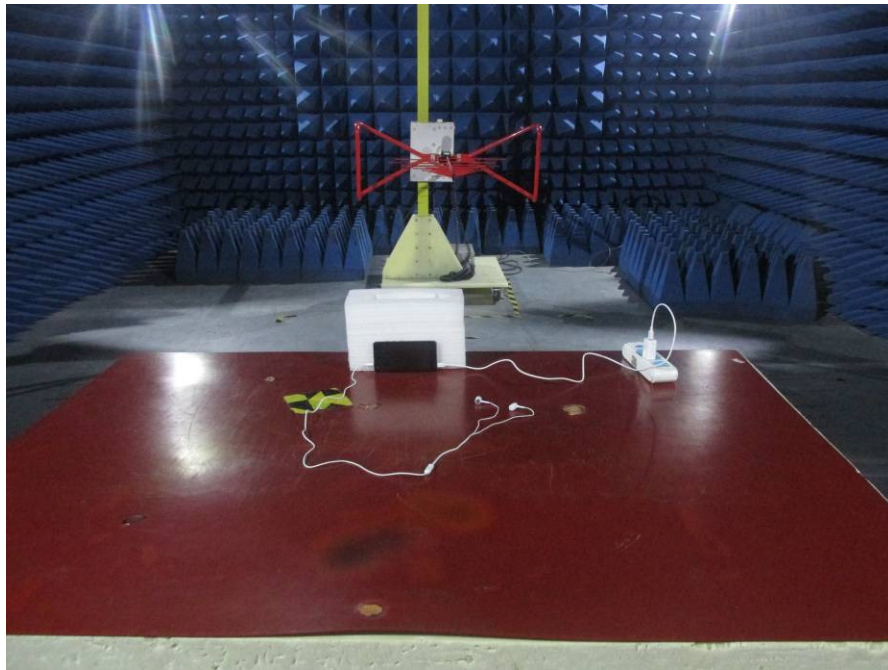

RADIATED EMISSION TEST

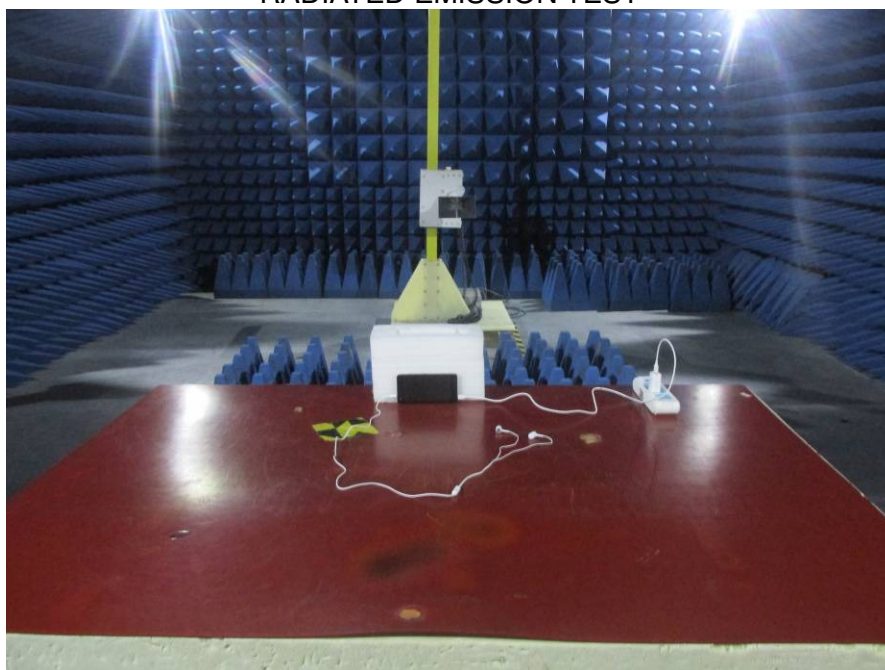

RADIATED EMISSION TEST

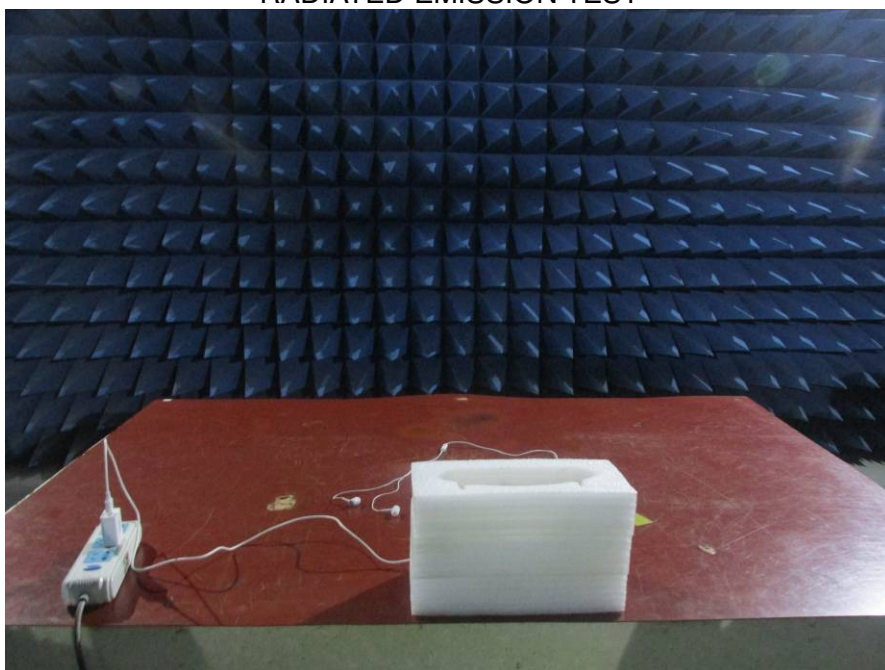

7. PHOTOGRAPHS OF EUT

Appearance photograph of EUT



Appearance photograph of EUT



Appearance photograph of EUT



Appearance photograph of EUT

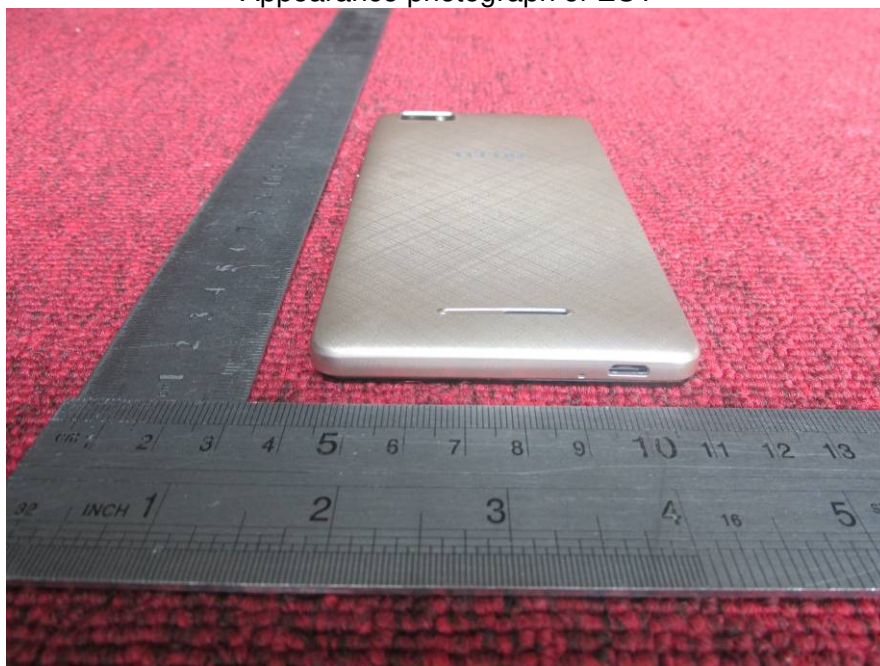

Appearance photograph of EUT



Appearance photograph of EUT



Appearance photograph of EUT



Appearance photograph of EUT



Internal photograph of EUT



Internal photograph of EUT



Internal photograph of EUT



BT/WiFi Antenna

Internal photograph of EUT



GSM/2/3G Antenna

Internal photograph of EUT

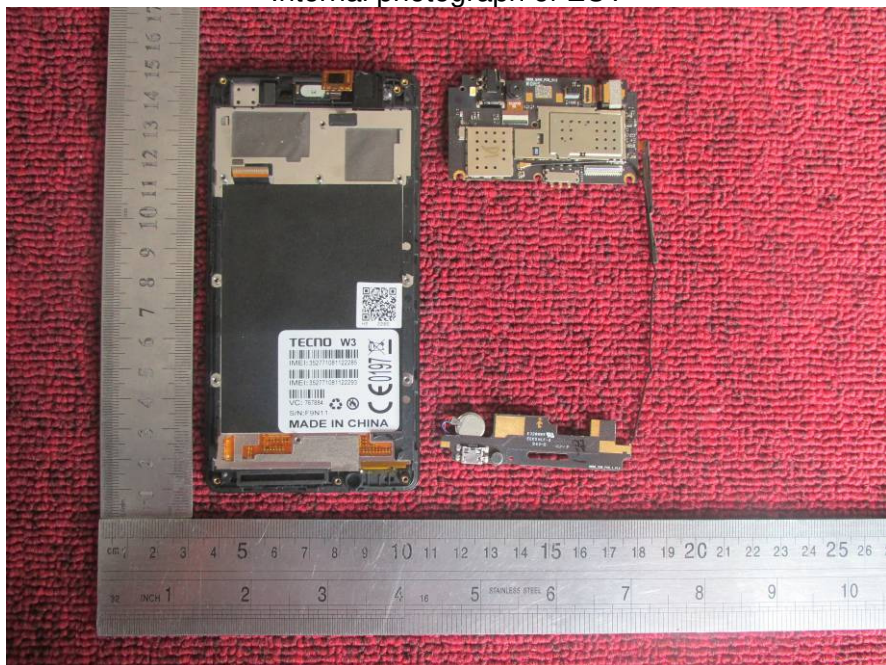

Internal photograph of EUT

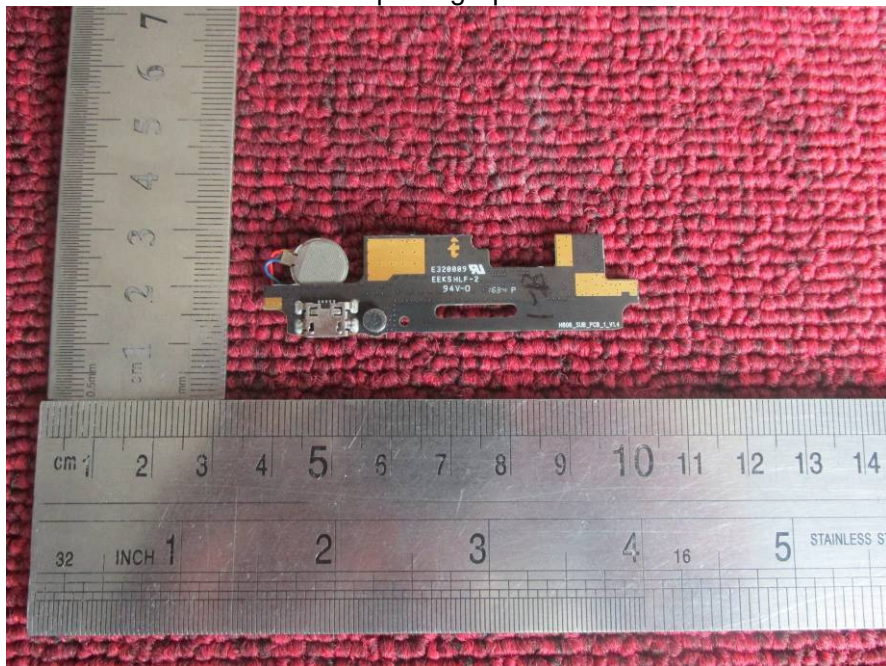

Internal photograph of EUT

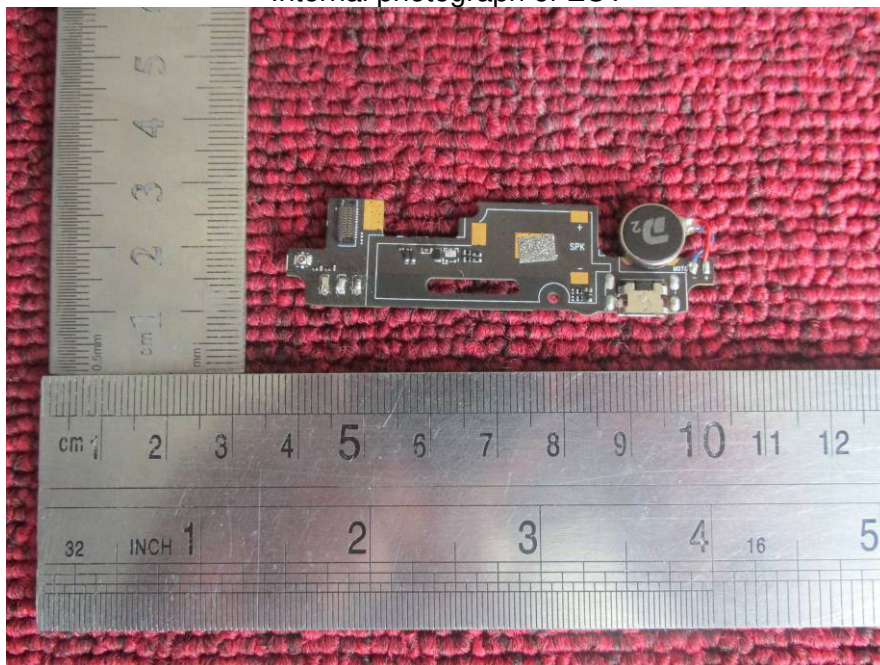

Internal photograph of EUT

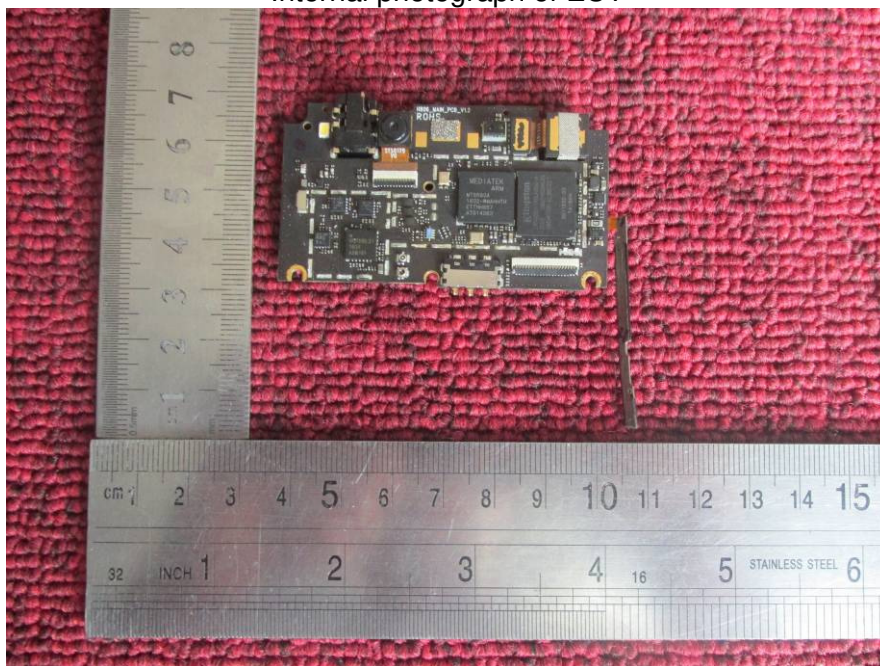

Internal photograph of EUT

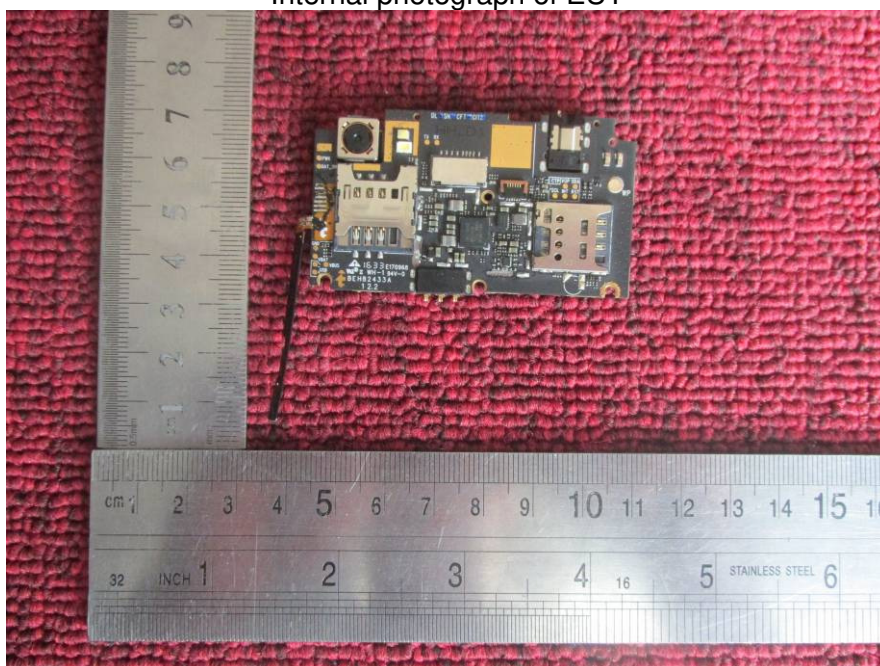

Internal photograph of EUT

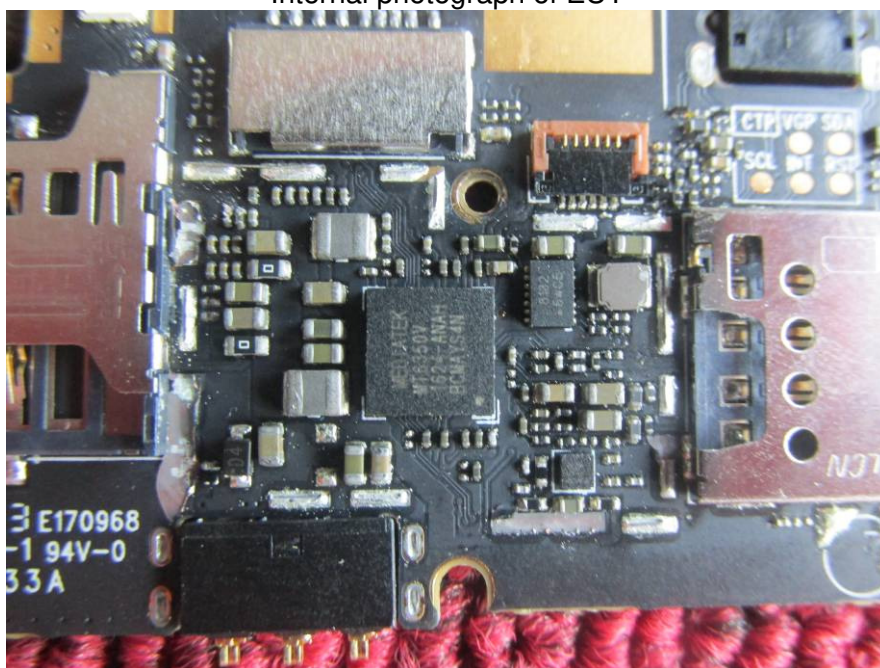

Internal photograph of EUT



Internal photograph of EUT

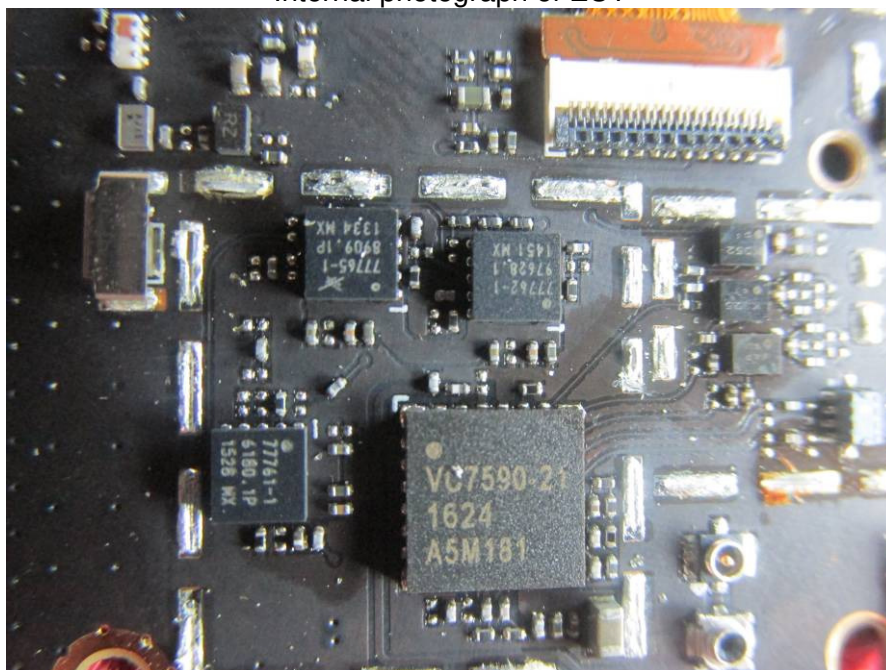

---END OF REPORT---