

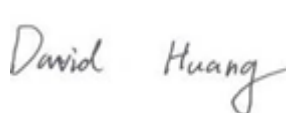

RF TEST REPORT



Report No.: 18070041-FCC-R1

Supersede Report No.: N/A

Applicant	TECNO MOBILE LIMITED	
Product Name	Mobile phone	
Model No.	T632S	
Serial No.	N/A	
Test Standard	FCC Part 22(H):2016 ;FCC Part 24(E):2016; ANSI/TIA-603-D: 2010	
Test Date	January 12 to January 29, 2018	
Issue Date	January 30, 2018	
Test Result	<input checked="" type="checkbox"/> Pass <input type="checkbox"/> Fail	
Equipment complied with the specification	<input checked="" type="checkbox"/>	
Equipment did not comply with the specification	<input type="checkbox"/>	
		
Aaron Liang Test Engineer	David Huang Checked By	
<p>This test report may be reproduced in full only Test result presented in this test report is applicable to the tested sample only</p>		

Issued by:

SIEMIC (SHENZHEN-CHINA) LABORATORIES

Zone A, Floor 1, Building 2 Wan Ye Long Technology Park

South Side of Zhoushi Road, Bao' an District, Shenzhen, Guangdong China 518108

Phone: +86 0755 2601 4629801 Email: China@siemic.com.cn

Laboratories Introduction

SIEMIC, headquartered in the heart of Silicon Valley, with superior facilities in US and Asia, is one of the leading independent testing and certification facilities providing customers with one-stop shop services for Compliance Testing and Global Certifications.



In addition to testing and certification, SIEMIC provides initial design reviews and compliance management throughout a project. Our extensive experience with China, Asia Pacific, North America, European, and International compliance requirements, assures the fastest, most cost effective way to attain regulatory compliance for the global markets.

Accreditations for Conformity Assessment

Country/Region	Scope
USA	EMC, RF/Wireless, SAR, Telecom
Canada	EMC, RF/Wireless, SAR, Telecom
Taiwan	EMC, RF, Telecom, SAR, Safety
Hong Kong	RF/Wireless, SAR, Telecom
Australia	EMC, RF, Telecom, SAR, Safety
Korea	EMI, EMS, RF, SAR, Telecom, Safety
Japan	EMI, RF/Wireless, SAR, Telecom
Singapore	EMC, RF, SAR, Telecom
Europe	EMC, RF, SAR, Telecom, Safety

Test Report	18070041-FCC-R1
Page	3 of 78

This page has been left blank intentionally.

CONTENTS

1. REPORT REVISION HISTORY	5
2. CUSTOMER INFORMATION.....	5
3. TEST SITE INFORMATION	5
4. EQUIPMENT UNDER TEST (EUT) INFORMATION	7
5. TEST SUMMARY	10
6. MEASUREMENTS, EXAMINATION AND DERIVED RESULTS.....	11
6.1 RF EXPOSURE (SAR)	11
6.2 RF OUTPUT POWER.....	12
6.3 PEAK-AVERAGE RATIO.....	24
6.4 OCCUPIED BANDWIDTH	28
6.5 SPURIOUS EMISSIONS AT ANTENNA TERMINALS	39
6.6 SPURIOUS RADIATED EMISSIONS.....	52
6.7 BAND EDGE	58
6.8 FREQUENCY STABILITY.....	68
ANNEX A. TEST INSTRUMENT	72
ANNEX C. TEST SETUP AND SUPPORTING EQUIPMENT.....	74
ANNEX C.II. EUT OPERATING CONKITIONS	76
ANNEX D. USER MANUAL / BLOCK DIAGRAM / SCHEMATICS / PARTLIST	77
ANNEX E. DECLARATION OF SIMILARITY	78

1. Report Revision History

Report No.	Report Version	Description	Issue Date
18070041-FCC-R1	NONE	Original	January 30, 2018

2. Customer information

Applicant Name	TECNO MOBILE LIMITED
Applicant Add	ROOMS 05-15, 13A/F., SOUTH TOWER, WORLD FINANCE CENTRE, HARBOUR CITY, 17 CANTON ROAD, TSIM SHA TSUI, KOWLOON, HONG KONG
Manufacturer	SHENZHEN TECNO TECHNOLOGY CO.,LTD.
Manufacturer Add	1-4th Floor,3rd Building,Pacific Industrial Park,No.2088,Shenyang Road,Yantian District,Shenzhen,Guangdong,China

3. Test site information

Test Lab A:

Lab performing tests	SIEMIC (Shenzhen-China) LABORATORIES
Lab Address	Zone A, Floor 1, Building 2 Wan Ye Long Technology Park South Side of Zhoushi Road, Bao' an District, Shenzhen, Guangdong China 518108
FCC Test Site No.	535293
IC Test Site No.	4842E-1
Test Software	Radiated Emission Program-To Shenzhen v2.0

Test Lab B:

Lab performing tests	SIEMIC (Nanjing-China) Laboratories
Lab Address	2-1 Longcang Avenue Yuhua Economic and Technology Development Park, Nanjing, China
FCC Test Site No.	694825
IC Test Site No.	4842B-1



Test Report	18070041-FCC-R1
Page	6 of 78

Test Software	EZ_EMV(ver.lcp-03A1)
---------------	----------------------

Note: We just perform Radiated Spurious Emission above 18GHz in the test Lab. B.

4. Equipment under Test (EUT) Information

Description of EUT:	Mobile phone
Main Model:	T632S
Serial Model:	N/A
Date EUT received:	January 11, 2018
Test Date(s):	January 12 to January 29, 2018
Equipment Category :	PCE
Antenna Gain:	GSM850: -0.2dBi PCS1900: 1.7dBi UMTS-FDD Band V: -0.2dBi UMTS-FDD Band II: 1.7dBi Bluetooth: -2.7dBi
Antenna Type:	GSM: PIFA antenna BT: PCB antenna
Type of Modulation:	GSM / GPRS: GMSK EGPRS: GMSK UMTS-FDD: QPSK Bluetooth: GFSK, π /4DQPSK, 8DPSK
RF Operating Frequency (ies):	GSM850 TX: 824.2 ~ 848.8 MHz; RX: 869.2 ~ 893.8 MHz PCS1900 TX: 1850.2 ~ 1909.8 MHz; RX: 1930.2 ~ 1989.8 MHz UMTS-FDD Band V TX: 826.4 ~ 846.6 MHz; RX: 871.4 ~ 891.6 MHz UMTS-FDD Band II TX: 1852.4 ~ 1907.6 MHz; RX: 1932.4 ~ 1987.6 MHz Bluetooth: 2402-2480 MHz
Maximum Conducted	GSM Voice: GSM850: 31.81dBm PCS1900: 29.36dBm
AV Power to Antenna:	GPRS: GSM850: 31.85dBm PCS1900: 29.44dBm

EGPRS:GSM850: 31.85dBm
 PCS1900: 29.40dBm
 EGPRS(MSC5):GSM850: 26.80dBm
 PCS1900: 26.12dBm
 RMC:UMTS-FDD Band V: 23.21dBm
 UMTS-FDD Band II: 23.09dBm
 HSUPA:UMTS-FDD Band V: 22.61dBm
 UMTS-FDD Band II: 22.48dBm
 HSDPA:UMTS-FDD Band V: 22.58dBm
 UMTS-FDD Band II: 22.46dBm
 GSM Voice:GSM850: 29.46dBm / ERP
 PCS1900: 27.06dBm / EIRP
 GPRS:GSM850: 29.50dBm / ERP
 PCS1900: 26.14dBm / EIRP
 EGPRS:GSM850: 24.45dBm / ERP
 PCS1900: 22.82dBm / EIRP
 RMC:UMTS-FDD Band V: 20.86dBm / ERP
 UMTS-FDD Band II: 24.79dBm / EIRP
 HSDPA:UMTS-FDD Band V: 20.02dBm / ERP
 UMTS-FDD Band II: 24.16dBm / EIRP
 HSUPA:UMTS-FDD Band V: 20.21dBm / ERP
 UMTS-FDD Band II: 24.08dBm / EIRP
 GSM 850: 124CH
 PCS1900: 299CH
 UMTS-FDD Band V: 102CH
 UMTS-FDD Band II: 277CH
 Bluetooth: 79CH
 USB Port, Earphone Port
 Adapter:
 Model: A31-500500
 Input: AC100-240V~50/60Hz,0.2A
 Output: DC 5.0V, 500mA
 Battery:
 Model: BL-5CAT
 Spec: 3.7V, 1150mAh, 4.255Wh

ERP/EIRP:

Number of Channels:

Port:

Input Power:

Test Report	18070041-FCC-R1
Page	9 of 78

Voltage: 4.2V

Trade Name : TECNO

GPRS/ EGPRS Multi-slot class 8/10/11/12

FCC ID: 2ADYY-T632S

5. Test Summary

The product was tested in accordance with the following specifications.

All testing has been performed according to below product classification:

FCC Rules	Description of Test	Result
§ 1.1307; § 2.1093	RF Exposure (SAR)	Compliance
§2.1046; § 22.913(a); § 24.232(c); § 27.50(c.10) ;	RF Output Power	Compliance
§ 24.232 (d) ;	Peak-Average Ratio	Compliance
§ 2.1049; § 22.905; § 22.917; § 24.238;	99% & -26 dB Occupied Bandwidth	Compliance
§ 2.1051; § 22.917(a); § 24.238(a);	Spurious Emissions at Antenna Terminal	Compliance
§ 2.1053; § 22.917(a); § 24.238(a);	Field Strength of Spurious Radiation	Compliance
§ 22.917(a); § 24.238(a);	Out of band emission, Band Edge	Compliance
§ 2.1055; § 22.355; § 24.235;	Frequency stability vs. temperature Frequency stability vs. voltage	Compliance

Note: Testing was performed by configuring EUT to maximum output power status, the declared output power class for different

Measurement Uncertainty

Emissions		
Test Item	Description	Uncertainty
Band Edge and Radiated Spurious Emissions	Confidence level of approximately 95% (in the case where distributions are normal), with a coverage factor of 2 (for EUTs < 0.5m X 0.5m X 0.5m)	+5.6dB/-4.5dB
-	-	-

6. MEASUREMENTS, EXAMINATION AND DERIVED RESULTS

6.1 RF Exposure (SAR)

Test Result: Pass

The EUT is a portable device, thus requires SAR evaluation;

Please refer to RF Exposure Evaluation Report: 18070041-FCC-H.

6.2 RF Output Power

Temperature	23 °C
Relative Humidity	54%
Atmospheric Pressure	1020mbar
Test date :	January 28, 2018
Tested By :	Aaron Liang

Requirement(s):

Spec	Item	Requirement	Applicable
§22.913 (a)	a)	ERP:38.45dBm	<input checked="" type="checkbox"/>
§24.232 (c)	b)	EIRP:33dBm	<input checked="" type="checkbox"/>

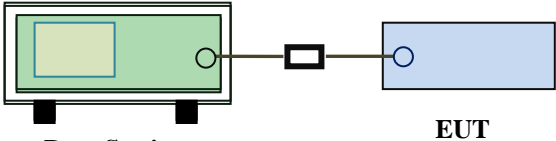
Test Setup	 <p style="text-align: center;">Base Station EUT</p>
------------	--

Test Procedure	<p>For Conducted Power:</p> <ul style="list-style-type: none"> - The transmitter output port was connected to base station. - Set EUT at maximum power through base station. - Select lowest, middle, and highest channels for each band and different test mode. <p>For ERP/EIRP:</p> <p>According with KDB 971168 v02r02</p> <ul style="list-style-type: none"> - The transmitter was placed on a wooden turntable, and it was transmitting into a non-radiating load which was also placed on the turntable. - The measurement antenna was placed at a distance of 3 meters from the EUT. During the tests, the antenna height and polarization as well as EUT azimuth were varied in order to identify the maximum level of emissions from the EUT. The test was performed by placing the EUT on 3-orthogonal axis. - The frequency range up to tenth harmonic of the fundamental frequency was investigated.
----------------	---

	<ul style="list-style-type: none"> - Remove the EUT and replace it with substitution antenna. A signal generator was connected to the substitution antenna by a non-radiating cable. The absolute levels of the spurious emissions were measured by the substitution. - Spurious emissions in dB = 10 log (TX power in Watts/0.001) – the absolute level - Spurious attenuation limit in dB = 43 + 10 Log10 (power out in Watts).
Remark	
Result	<input checked="" type="checkbox"/> Pass <input type="checkbox"/> Fail

Test Data Yes N/A
 Test Plot Yes (See below) N/A

Conducted Power

GSM Mode:

Burst Average Power (dBm);								
Band	GSM850				PCS1900			
Channel	128	190	251	Tune up Power tolerant	512	661	810	Tune up Power tolerant
Frequency (MHz)	824.2	836.6	848.8	/	1850.2	1880	1909.8	/
GSM Voice (1 uplink),GMSK	31.6	31.81	31.65	32±1	29.36	29.31	29.27	29±1
GPRS Multi-Slot Class 8 (1 uplink),GMSK	31.7	31.85	31.68	32±1	29.43	29.44	29.22	29±1
GPRS Multi-Slot Class 10 (2 uplink) GMSK	31.14	31.39	31.11	31±1	28.33	28.66	28.71	29±1
GPRS Multi-Slot Class 11 (3 uplink) GMSK	29.64	29.85	29.57	30±1	27.41	27.38	27.32	27±1
GPRS Multi-Slot Class 12 (4 uplink) GMSK	28.57	28.49	28.41	29±1	26.31	26.26	26.27	26±1
EGPRS Multi-Slot Class 8 (1 uplink) GMSK MCS1	31.77	31.85	31.4	32±1	29.4	29.35	29.24	29±1
EGPRS Multi-Slot Class 10 (2 uplink) GMSK MCS1	31.21	31.37	31.19	31±1	28.9	28.79	28.7	29±1
EGPRS Multi-Slot Class 11 (3 uplink) GMSK MCS1	29.63	29.85	29.1	30±1	27.4	27.32	27.37	27±1
EGPRS Multi-Slot Class 12 (4 uplink) GMSK MCS1	28.57	28.83	28.51	29±1	26.3	26.29	26.25	26±1
EGPRS Multi-Slot Class 8 (1 uplink),8PSK MCS5	26.8	26.77	26.76	27±1	26.12	25.93	25.96	26±1

EGPRS Multi-Slot Class 10 (2 uplink),8PSK MCS5	25.44	25.51	25.51	25±1	25.03	24.96	24.98	25±1
EGPRS Multi-Slot Class 11 (3 uplink),8PSK MCS5	23.44	23.68	23.7	24±1	22.57	22.64	22.71	23±1
EGPRS Multi-Slot Class 12 (4 uplink),8PSK MCS5	22.6	22.69	22.72	23±1	21.58	21.32	21.6	22±1

Remark :

GPRS, CS1 coding scheme.

EGPRS, MCS1 coding scheme.

EGPRS, MCS5 coding scheme.

Multi-Slot Class 8 , Support Max 4 downlink, 1 uplink , 5 working link

Multi-Slot Class 10 , Support Max 4 downlink, 2 uplink , 5 working link

Multi-Slot Class 11 , Support Max 4 downlink, 2 uplink , 5 working link

Multi-Slot Class 12 , Support Max 4 downlink, 4 uplink , 5 working link

UMTS Mode:

UMTS-FDD Band V

Band/ Time Slot configuration	Channel	Frequency	Average power (dBm)	Tune up Power tolerant
RMC 12.2kbps	4132	826.4	23.11	23±1
	4175	835	23.21	23±1
	4233	846.6	23.12	23±1
HSDPA Subtest1	4132	826.4	22.37	22±1
	4175	835	22.53	22±1
	4233	846.6	22.4	22±1
HSDPA Subtest2	4132	826.4	22.5	22±1
	4175	835	22.54	22±1
	4233	846.6	22.43	22±1
HSDPA Subtest3	4132	826.4	22.38	22±1
	4175	835	22.58	22±1
	4233	846.6	22.5	22±1
HSDPA Subtest4	4132	826.4	22.52	22±1
	4175	835	22.57	22±1
	4233	846.6	22.55	22±1
HSUPA Subtest1	4132	826.4	22.49	22±1
	4175	835	22.56	22±1
	4233	846.6	22.47	22±1
HSUPA Subtest2	4132	826.4	22.27	22±1
	4175	835	22.36	22±1
	4233	846.6	22.2	22±1
HSUPA Subtest3	4132	826.4	22.34	22±1
	4175	835	22.58	22±1
	4233	846.6	22.47	22±1
HSUPA Subtest4	4132	826.4	22.16	22±1
	4175	835	22.36	22±1
	4233	846.6	22.2	22±1
HSUPA Subtest5	4132	826.4	22.61	22±1
	4175	835	22.52	22±1
	4233	846.6	22.43	22±1

UMTS-FDD Band II

Band/ Time Slot configuration	Channel	Frequency	Average power (dBm)	Tune up Power tolerant
RMC 12.2kbps	9262	1852.4	23.05	23±1
	9400	1880	23.08	23±1
	9538	1907.6	23.09	23±1
HSDPA Subtest1	9262	1852.4	22.45	22±1
	9400	1880	22.28	22±1
	9538	1907.6	22.36	22±1
HSDPA Subtest2	9262	1852.4	22.46	22±1
	9400	1880	22.45	22±1
	9538	1907.6	22.39	22±1
HSDPA Subtest3	9262	1852.4	22.3	22±1
	9400	1880	22.32	22±1
	9538	1907.6	22.33	22±1
HSDPA Subtest4	9262	1852.4	22.45	22±1
	9400	1880	22.45	22±1
	9538	1907.6	22.41	22±1
HSUPA Subtest1	9262	1852.4	22.45	22±1
	9400	1880	22.3	22±1
	9538	1907.6	22.48	22±1
HSUPA Subtest2	9262	1852.4	22.33	22±1
	9400	1880	22.26	22±1
	9538	1907.6	22.38	22±1
HSUPA Subtest3	9262	1852.4	22.39	22±1
	9400	1880	22.39	22±1
	9538	1907.6	22.42	22±1
HSUPA Subtest4	9262	1852.4	22.29	22±1
	9400	1880	22.13	22±1
	9538	1907.6	22.39	22±1
HSUPA Subtest5	9262	1852.4	22.41	22±1
	9400	1880	22.36	22±1
	9538	1907.6	22.33	22±1

ERP & EIRP

GSM Voice

ERP for Cellular Band (Part 22H)

Frequency (MHz)	Antenna Polarization (H/V)	Absolute Level (dBm)	Limit (dBm)	Margin (dB)
824.2	V	29.25	38.45	-9.2
824.2	H	27.79	38.45	-10.66
836.6	V	29.46	38.45	-8.99
836.6	H	27.62	38.45	-10.83
848.8	V	29.3	38.45	-9.15
848.8	H	27.63	38.45	-10.82

EIRP for PCS Band (Part 24E)

Frequency (MHz)	Antenna Polarization (H/V)	Absolute Level (dBm)	Limit (dBm)	Margin (dB)
1850.2	V	27.06	33	-5.94
1850.2	H	26.1	33	-6.9
1880	V	27.01	33	-5.99
1880	H	25.36	33	-7.64
1909.8	V	26.97	33	-6.03
1909.8	H	25.52	33	-7.48

GPRS:

ERP for Cellular Band (Part 22H)

Frequency (MHz)	Antenna Polarization (H/V)	Absolute Level (dBm)	Limit (dBm)	Margin (dB)
824.2	V	29.35	38.45	-9.1
824.2	H	27.95	38.45	-10.5
836.6	V	29.5	38.45	-8.95
836.6	H	27.87	38.45	-10.58
848.8	V	29.33	38.45	-9.12
848.8	H	27.53	38.45	-10.92

EIRP for PCS Band (Part 24E)

Frequency (MHz)	Antenna Polarization (H/V)	Absolute Level (dBm)	Limit (dBm)	Margin (dB)
1850.2	V	26.13	33	-6.87
1850.2	H	24.53	33	-8.47
1880	V	26.14	33	-6.86
1880	H	25.39	33	-7.61
1909.8	V	25.92	33	-7.08
1909.8	H	24.14	33	-8.86

EGPRS (MCS5):

ERP for Cellular Band (Part 22H)

Frequency (MHz)	Antenna Polarization (H/V)	Absolute Level (dBm)	Limit (dBm)	Margin (dB)
824.2	V	24.45	38.45	-14
824.2	H	23.71	38.45	-14.74
836.6	V	24.42	38.45	-14.03
836.6	H	22.85	38.45	-15.6
848.8	V	24.41	38.45	-14.04
848.8	H	23.14	38.45	-15.31

EIRP for PCS Band (Part 24E)

Frequency (MHz)	Antenna Polarization (H/V)	Absolute Level (dBm)	Limit (dBm)	Margin (dB)
1850.2	V	22.82	33	-10.18
1850.2	H	21.87	33	-11.13
1880	V	22.63	33	-10.37
1880	H	21.03	33	-11.97
1909.8	V	22.66	33	-10.34
1909.8	H	21.1	33	-11.9

RMC

ERP for UMTS-FDD Band V (Part 22H)

Frequency (MHz)	Antenna Polarization (H/V)	Absolute Level (dBm)	Limit (dBm)	Margin (dB)
826.4	V	20.76	38.45	-17.69
826.4	H	19.18	38.45	-19.27
835	V	20.86	38.45	-17.59
835	H	19.94	38.45	-18.51
846.6	V	20.77	38.45	-17.68
846.6	H	19.59	38.45	-18.86

EIRP for UMTS-FDD Band II (Part 24E)

Frequency (MHz)	Antenna Polarization (H/V)	Absolute Level (dBm)	Limit (dBm)	Margin (dB)
1852.4	V	24.75	33	-8.25
1852.4	H	23.12	33	-9.88
1880	V	24.78	33	-8.22
1880	H	23.2	33	-9.8
1907.6	V	24.79	33	-8.21
1907.6	H	23.6	33	-9.4

HSDPA

ERP for UMTS-FDD Band V (Part 22H)

Frequency (MHz)	Antenna Polarization (H/V)	Absolute Level (dBm)	Limit (dBm)	Margin (dB)
826.4	V	20.02	38.45	-18.43
826.4	H	19.07	38.45	-19.38
835	V	20.18	38.45	-18.27
835	H	18.33	38.45	-20.12
846.6	V	20.2	38.45	-18.25
846.6	H	19.03	38.45	-19.42

EIRP for UMTS-FDD Band II (Part 24E)

Frequency (MHz)	Antenna Polarization (H/V)	Absolute Level (dBm)	Limit (dBm)	Margin (dB)
1852.4	V	23.98	33	-9.02
1852.4	H	22.54	33	-10.46
1880	V	24.16	33	-8.84
1880	H	23.45	33	-9.55
1907.6	V	24.09	33	-8.91
1907.6	H	23.21	33	-9.79

HSUPA

ERP for UMTS-FDD Band V (Part 22H)

Frequency (MHz)	Antenna Polarization (H/V)	Absolute Level (dBm)	Limit (dBm)	Margin (dB)
826.4	V	20.2	38.45	-18.25
826.4	H	18.78	38.45	-19.67
835	V	20.21	38.45	-18.24
835	H	18.89	38.45	-19.56
846.6	V	19.92	38.45	-18.53
846.6	H	18.69	38.45	-19.76

EIRP for UMTS-FDD Band II (Part 24E)

Frequency (MHz)	Antenna Polarization (H/V)	Absolute Level (dBm)	Limit (dBm)	Margin (dB)
1852.4	V	24	33	-9
1852.4	H	22.14	33	-10.86
1880	V	24.03	33	-8.97
1880	H	22.34	33	-10.66
1907.6	V	24.08	33	-8.92
1907.6	H	22.34	33	-10.66

6.3 Peak-Average Ratio

Temperature	23 °C
Relative Humidity	54%
Atmospheric Pressure	1020mbar
Test date :	January 28, 2018
Tested By :	Aaron Liang

Requirement(s):

Spec	Item	Requirement	Applicable
§24.232(d)	a)	The peak-to-average ratio (PAR) of the transmission may not exceed 13dB.	<input checked="" type="checkbox"/>

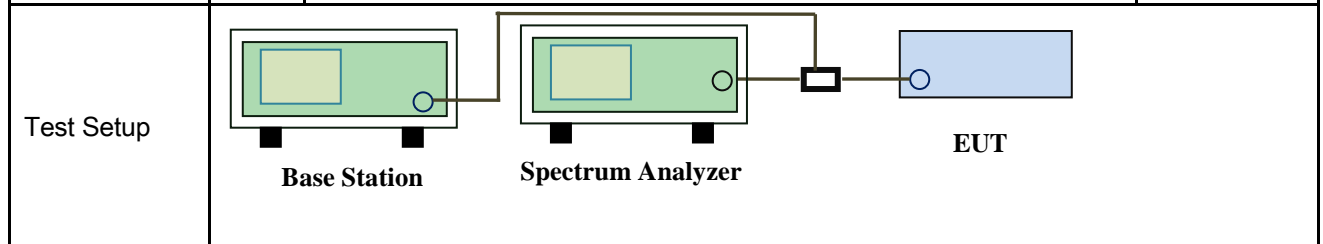

Test Procedure	<p>According with KDB 971168 v02r02</p> <p>5.7.2 Alternate procedure for PAPR</p> <p>5.1.2 Peak power measurements with a peak power meter</p> <p>The total peak output power may be measured using a broadband peak RF power meter. The power meter must have a video bandwidth that is greater than or equal to the emission bandwidth and utilize a fast-responding diode detector.</p> <p>5.2.3 Average power measurement with average power meter</p> <p>As an alternative to the use of a spectrum/signal analyzer or EMI receiver to perform a measurement of the total in-band average output power, a wideband RF average power meter with a thermocouple detector or equivalent can be used under certain conditions</p> <p>If the EUT can be configured to transmit continuously (i.e., the burst duty cycle $\geq 98\%$) and at all times the EUT is transmitting at its maximum output</p>
----------------	--

Test Report	18070041-FCC-R1
Page	25 of 78

	<p>power level, then a conventional wide-band RF power meter can be used.</p> <p>If the EUT cannot be configured to transmit continuously (i.e., the burst duty cycle < 98%), then there are two options for the use of an average power meter. First, a gated average power meter can be used to perform the measurement if the gating parameters can be adjusted such that the power is measured only over active transmission bursts at maximum output power levels. A conventional average power meter can also be used if the measured burst duty cycle is constant (i.e., duty cycle variations are less than ± 2 percent) by performing the measurement over the on/off burst cycles and then correcting (increasing) the measured level by a factor equal to $10\log(1/\text{duty cycle})$</p>
Remark	
Result	<input checked="" type="checkbox"/> Pass <input type="checkbox"/> Fail

Test Data Yes N/A
Test Plot Yes (See below) N/A

GSM : GSM 1900 PK-AV POWER (PART 24E)

Frequency (MHz)	Conducted power(dBm)		Peak-Average Ratio(PAR)
	Peak	Average	
1850.2	30.42	29.36	1.06
1880	30.46	29.3	1.16
1909.8	30.48	29.17	1.31

GPRS 1900 PK-AV POWER (PART 24E)

Frequency (MHz)	Conducted power(dBm)		Peak-Average Ratio(PAR)
	Peak	Average	
1850.2	30.52	29.43	1.09
1880	30.44	29.4	1.04
1909.8	30.33	29.26	1.07

EGPRS (MSC5) 1900 PK-AV POWER (PART 24E)

Frequency (MHz)	Conducted power(dBm)		Peak-Average Ratio(PAR)
	Peak	Average	
1850.2	26.89	26.12	0.77
1880	26.76	25.93	0.83
1909.8	26.66	25.96	0.7

RMC : UMTS-FDD Band 2 PK-AV POWER (PART 24E)

Frequency (MHz)	Conducted power(dBm)		Peak-Average Ratio(PAR)
	Peak	Average	
1852.4	23.99	23.05	0.94
1880	23.95	23.08	0.87
1907.6	23.94	23.09	0.85

UMTS-FDD Band 5 PK-AV POWER (PART 24E)

Frequency (MHz)	Conducted power(dBm)		Peak-Average Ratio(PAR)
	Peak	Average	
1852.4	23.99	23.11	0.88
1880	23.89	23.21	0.68
1907.6	23.97	23.12	0.85

HSDPA : UMTS-FDD Band 2 PK-AV POWER (PART 24E)

Frequency (MHz)	Conducted power(dBm)		Peak-Average Ratio(PAR)
	Peak	Average	
1852.4	23.22	22.45	0.77
1880	23.15	22.3	0.85
1907.6	23.18	22.48	0.7

UMTS-FDD Band 5 PK-AV POWER (PART 24E)

Frequency (MHz)	Conducted power(dBm)		Peak-Average Ratio(PAR)
	Peak	Average	
1852.4	23.26	22.49	0.77
1880	23.42	22.56	0.86
1907.6	23.19	22.47	0.72

HSUPA : UMTS-FDD Band 2 PK-AV POWER (PART 24E)

Frequency (MHz)	Conducted power(dBm)		Peak-Average Ratio(PAR)
	Peak	Average	
1852.4	23.26	22.45	0.81
1880	23.42	22.3	1.12
1907.6	23.19	22.48	0.71

UMTS-FDD Band 5 PK-AV POWER (PART 24E)

Frequency (MHz)	Conducted power(dBm)		Peak-Average Ratio(PAR)
	Peak	Average	
1852.4	23.22	22.37	0.85
1880	23.15	22.53	0.62
1907.6	23.18	22.4	0.78

6.4 Occupied Bandwidth

Temperature	23 °C
Relative Humidity	54%
Atmospheric Pressure	1020mbar
Test date :	January 28, 2018
Tested By :	Aaron Liang

Requirement(s):

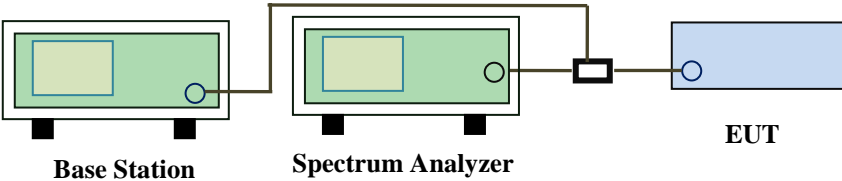
Spec	Item	Requirement	Applicable
§2.1049, §22.917, §22.905 §24.238	a)	99% Occupied Bandwidth(kHz)	<input checked="" type="checkbox"/>
	b)	26 dB Bandwidth(kHz)	<input checked="" type="checkbox"/>
Test Setup	 <p style="text-align: center;">Base Station Spectrum Analyzer EUT</p>		
Test Procedure	<ul style="list-style-type: none"> - The EUT was connected to Spectrum Analyzer and Base Station via power divider. - The 99% and 26 dB occupied bandwidth (BW) of the middle channel for the highest RF powers. 		
Remark			
Result	<input checked="" type="checkbox"/> Pass <input type="checkbox"/> Fail		

Test Data Yes N/A

Test Plot Yes (See below) N/A

GSM Voice:

Cellular Band (Part 22H) result

Channel	Frequency (MHz)	99% Occupied Bandwidth (kHz)	26 dB Bandwidth (kHz)
128	824.2	249.6768	323.544
190	836.6	248.1335	320.783
251	848.8	249.1959	326.679

PCS Band (Part 24E) result

Channel	Frequency (MHz)	99% Occupied Bandwidth (kHz)	26 dB Bandwidth (kHz)
512	1850	250.3513	324.776
661	1880	251.5177	320.450
810	1910	248.9721	322.833

GPRS:

Cellular Band (Part 22H) result

Channel	Frequency (MHz)	99% Occupied Bandwidth (kHz)	26 dB Bandwidth (kHz)
128	824.2	248.6517	317.783
190	836.6	247.8028	320.783
251	848.8	244.5367	326.628

PCS Band (Part 24E) result

Channel	Frequency (MHz)	99% Occupied Bandwidth (kHz)	26 dB Bandwidth (kHz)
512	1850	250.5113	330.951
661	1880	252.1634	318.588
810	1910	247.1068	319.545

EGPRS (MSC 5):

Cellular Band (Part 22H) result

Channel	Frequency (MHz)	99% Occupied Bandwidth (kHz)	26 dB Bandwidth (kHz)
128	824.2	250.8720	318.027
190	836.6	248.7956	321.226
251	848.8	249.7759	320.387

PCS Band (Part 24E) result

Channel	Frequency (MHz)	99% Occupied Bandwidth (kHz)	26 dB Bandwidth (kHz)
512	1850	249.7109	329.802
661	1880	259.5657	319.797
810	1910	244.8689	320.590

RMC:

UMTS-FDD Band V (Part 22H)

Channel	Frequency (MHz)	99% Occupied Bandwidth (MHz)	26 dB Bandwidth (MHz)
4132	826.6	4.1757	4.720
4175	835.0	4.1922	4.704
4233	846.4	4.1834	4.707

UMTS-FDD Band II (Part 24E)

Channel	Frequency (MHz)	99% Occupied Bandwidth (MHz)	26 dB Bandwidth (MHz)
9262	1853	4.1703	4.741
9400	1880	4.1711	4.743
9538	1907	4.1913	4.720

HSDPA:

UMTS-FDD Band V (Part 22H)

Channel	Frequency (MHz)	99% Occupied Bandwidth (MHz)	26 dB Bandwidth (MHz)
4132	826.6	4.1445	4.740
4175	835.0	4.1977	4.707
4233	846.4	4.1957	4.694

UMTS-FDD Band II (Part 24E)

Channel	Frequency (MHz)	99% Occupied Bandwidth (MHz)	26 dB Bandwidth (MHz)
9262	1853	4.1776	4.732
9400	1880	4.1870	4.712
9538	1907	4.1851	4.727

HSUPA:

UMTS-FDD Band V (Part 22H)

Channel	Frequency (MHz)	99% Occupied Bandwidth (MHz)	26 dB Bandwidth (MHz)
4132	826.6	4.1673	4.738
4175	835.0	4.1996	4.707
4233	846.4	4.1839	4.691

UMTS-FDD Band II (Part 24E)

Channel	Frequency (MHz)	99% Occupied Bandwidth (MHz)	26 dB Bandwidth (MHz)
9262	1853	4.1778	4.741
9400	1880	4.1750	4.743
9538	1907	4.1877	4.735

Test Plots

GSM Voice:

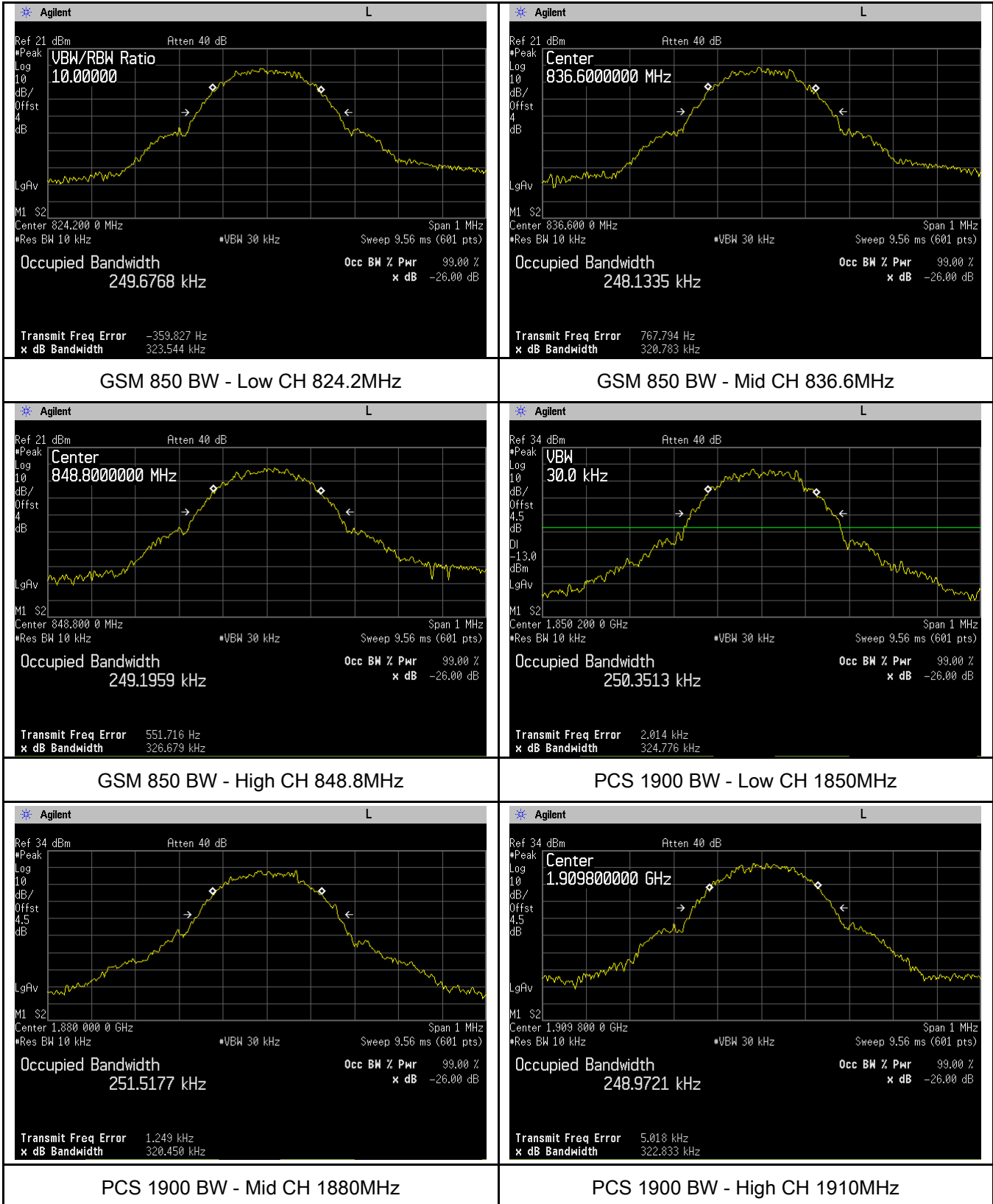

GPRS:

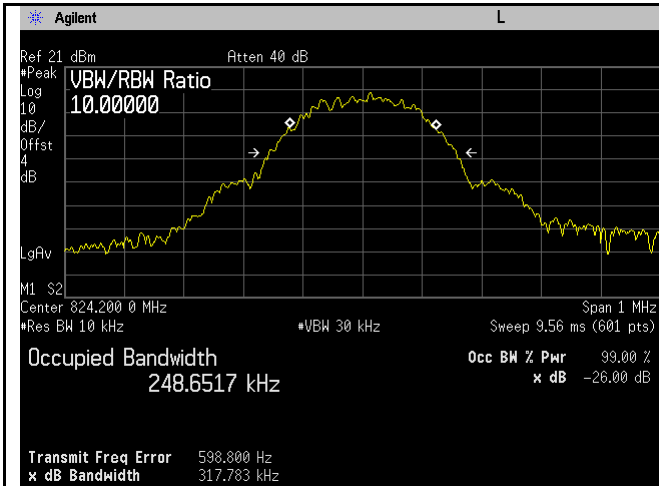

GSM 850 BW - Low CH 824.2MHz

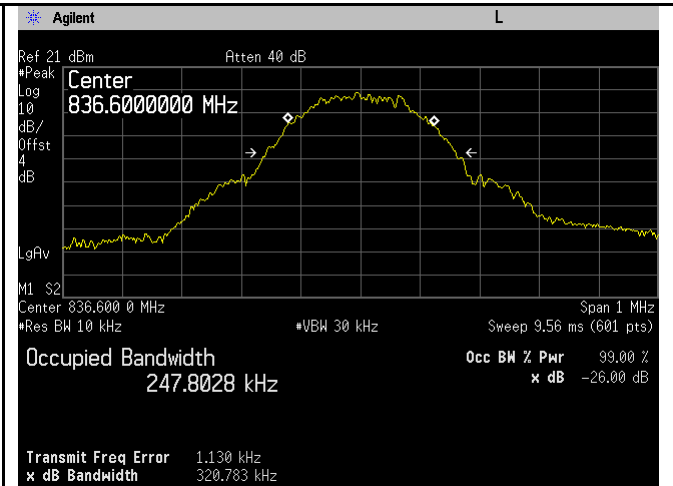

GSM 850 BW - Mid CH 836.6MHz

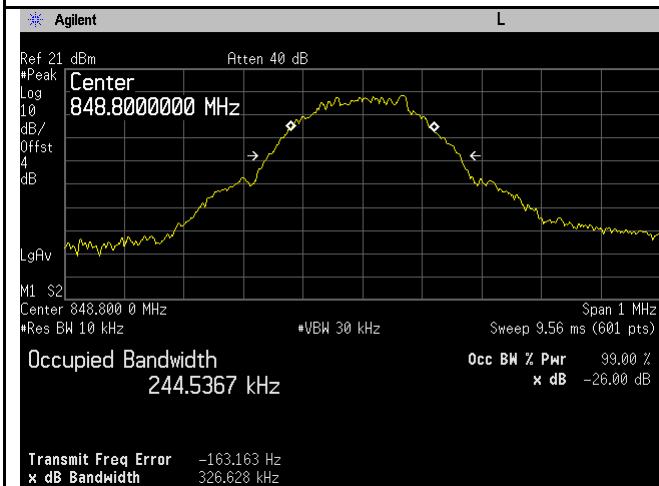

GSM 850 BW - High CH 848.8MHz

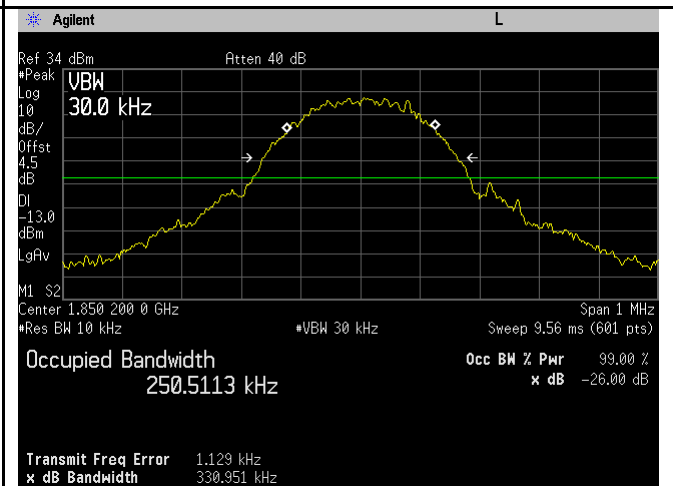

PCS 1900 BW - Low CH 1850MHz

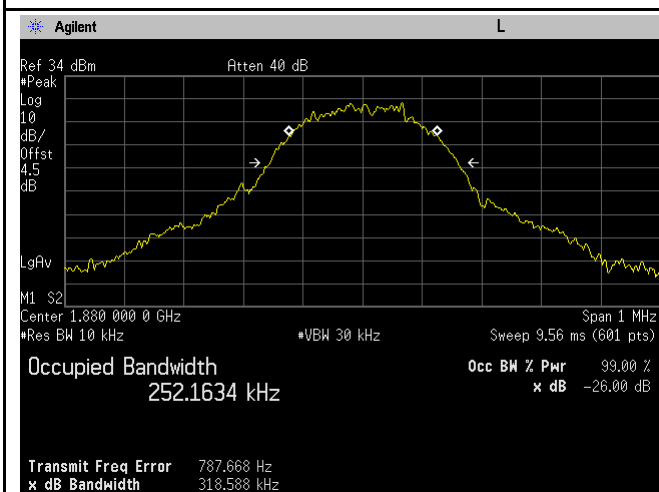

PCS 1900 BW - Mid CH 1880MHz

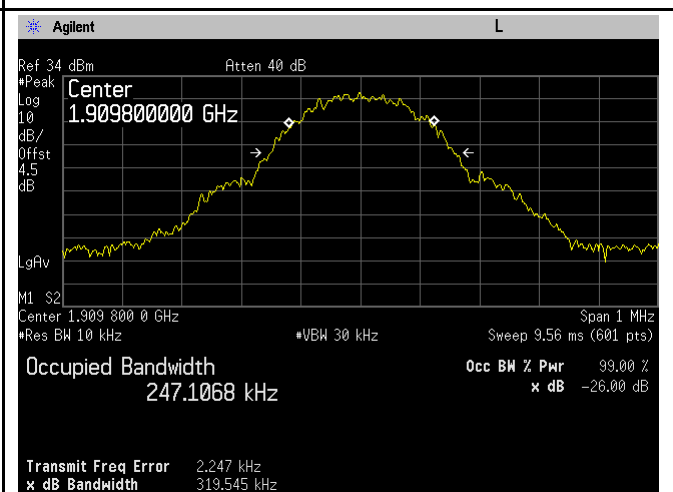

PCS 1900 BW - High CH 1910MHz

EGPRS (MCS1):

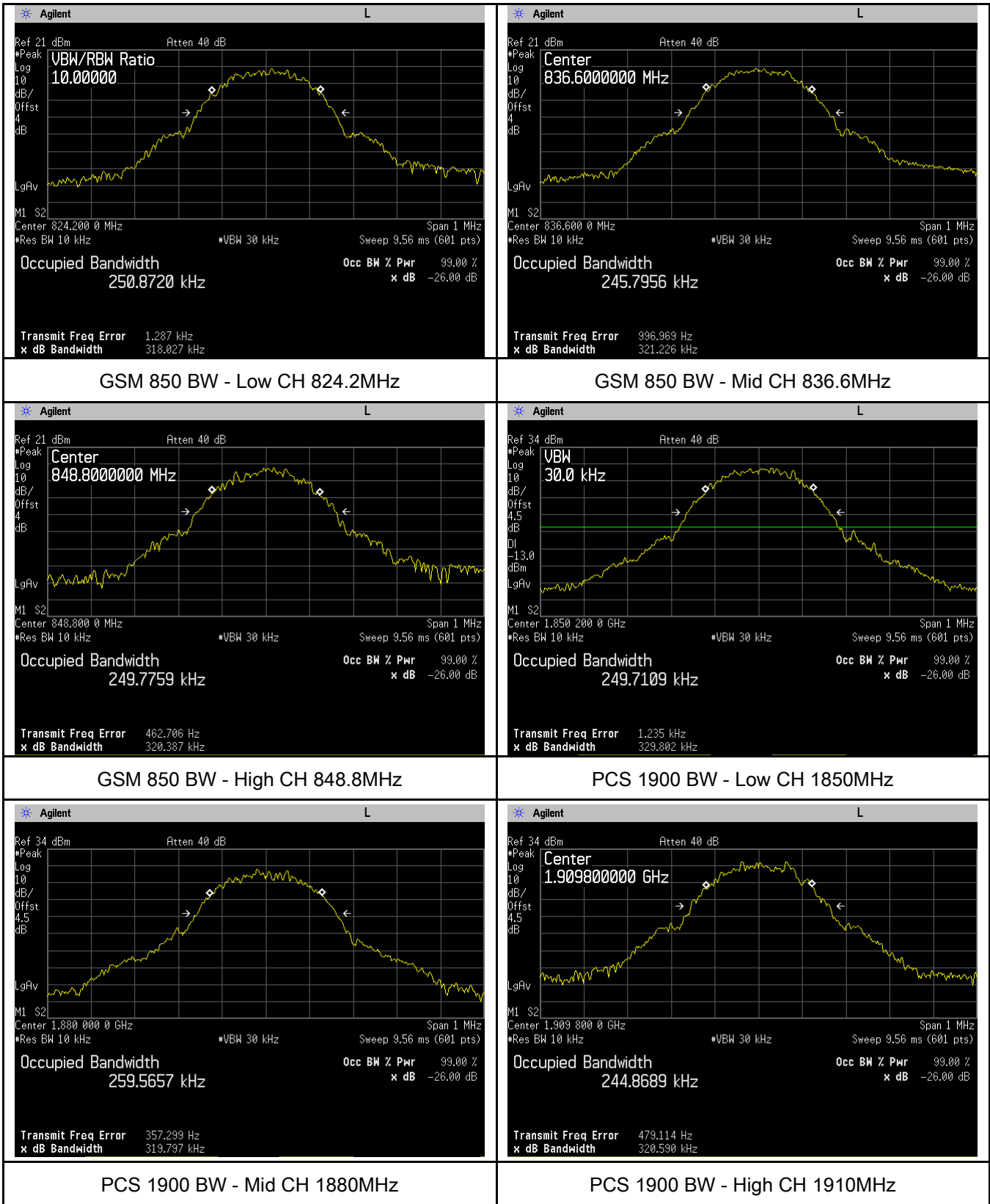

RMC:

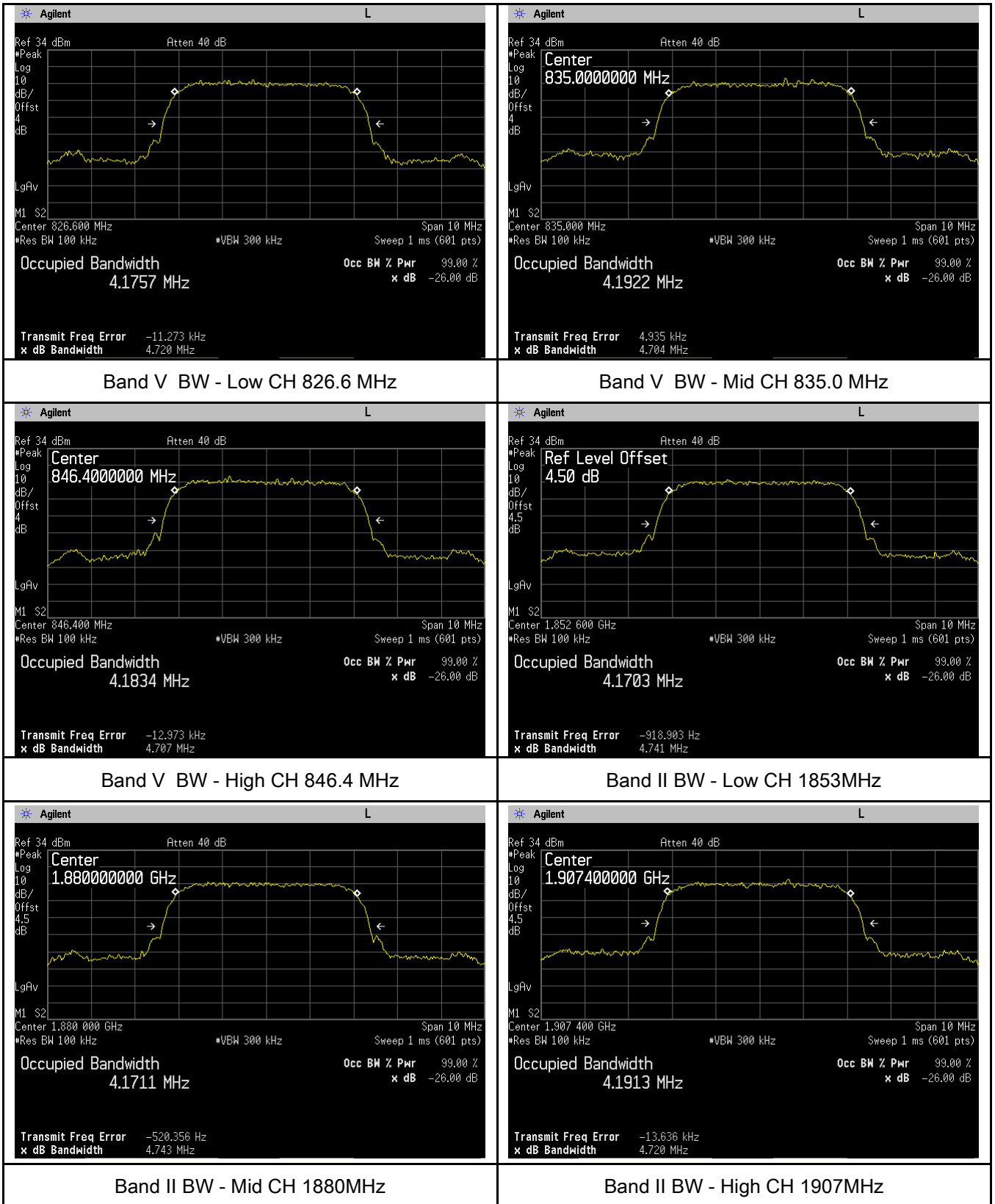

HSDPA:

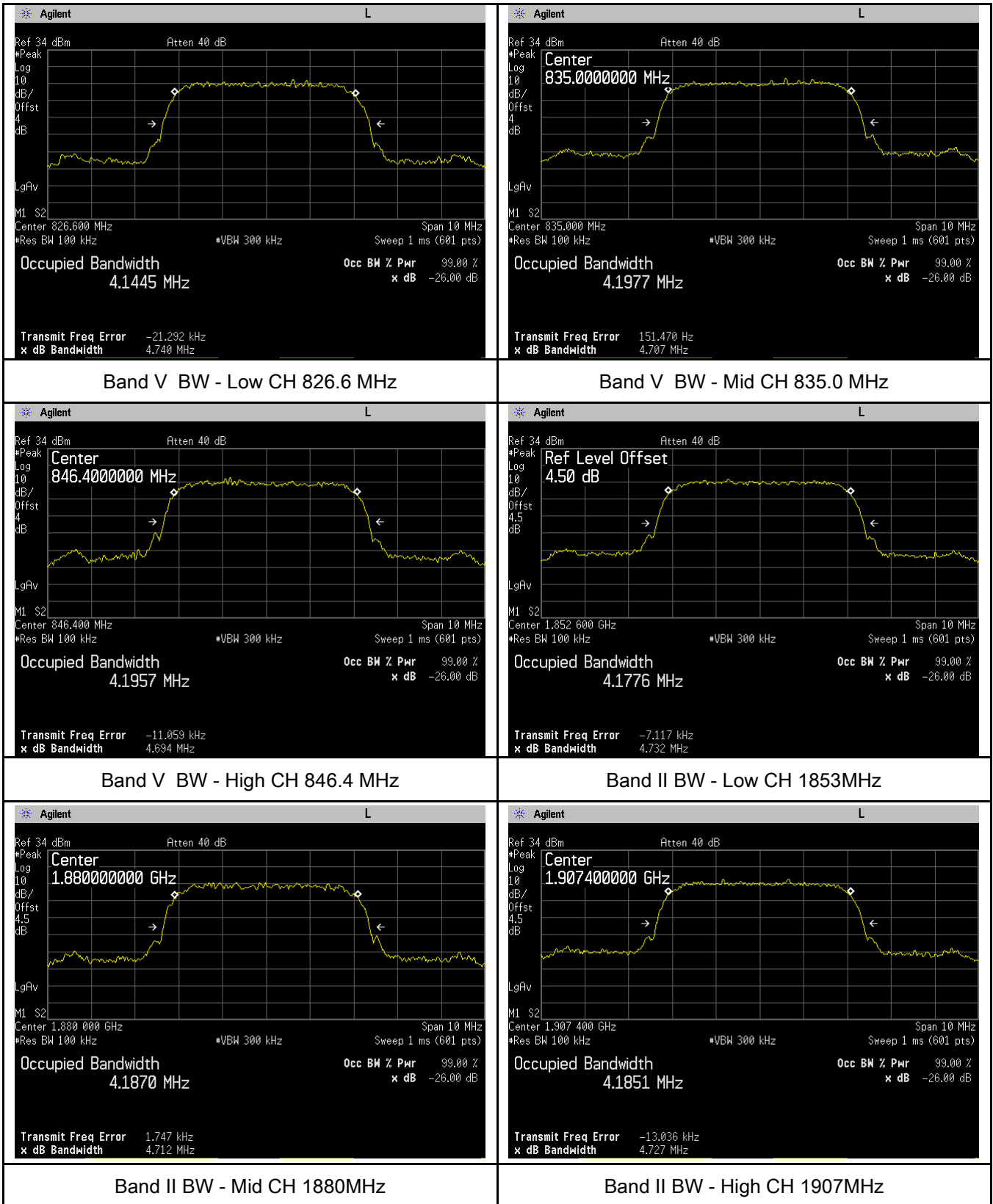

HSUPA:

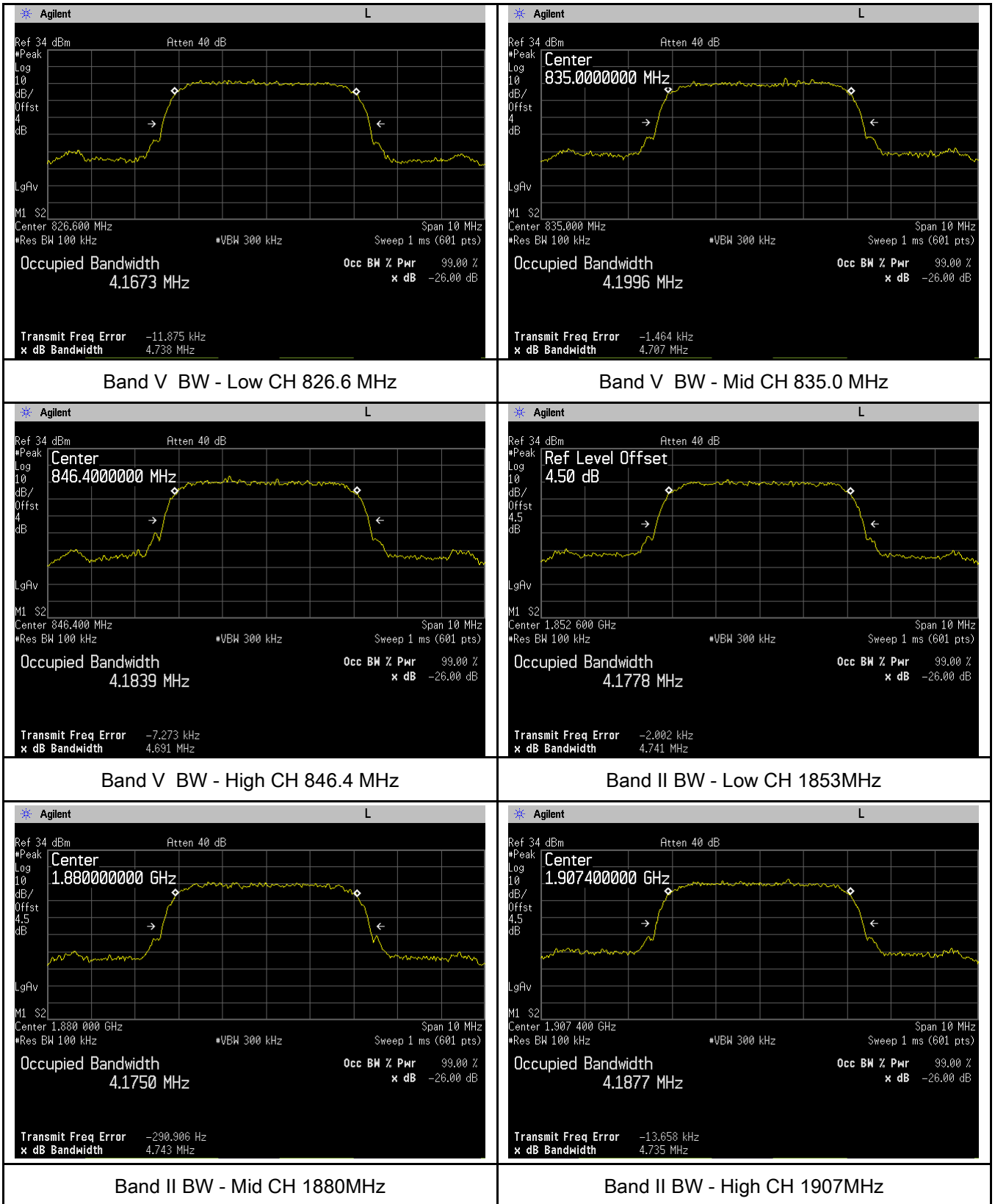

6.5 Spurious Emissions at Antenna Terminals

Temperature	25 °C
Relative Humidity	57%
Atmospheric Pressure	1023mbar
Test date :	January 27, 2018
Tested By :	Aaron Liang

Requirement(s):

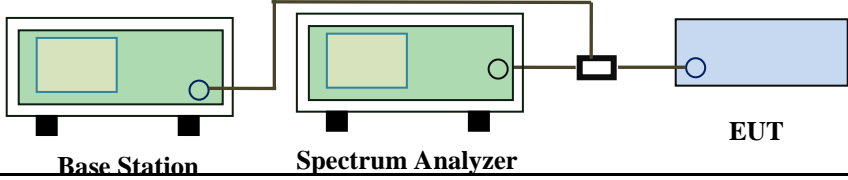
Spec	Item	Requirement	Applicable
§2.1051, §22.917(a)& §24.238(a)	a)	The power of any emission outside of the authorized operating frequency ranges must be lower than the transmitter power (P) by a factor of at least $43 + 10 \log (P)$ dB	<input checked="" type="checkbox"/>
Test Setup	 <p style="text-align: center;"> Base Station Spectrum Analyzer EUT </p>		
Test Procedure	<ul style="list-style-type: none"> - The EUT was connected to Spectrum Analyzer and Base Station via power divider. - The Band Edges of low and high channels for the highest RF powers were measured. - Setting RBW as roughly BW/100. 		
Remark			
Result	<input checked="" type="checkbox"/> Pass <input type="checkbox"/> Fail		

Test Data Yes N/A
 Test Plot Yes (See below) N/A

Test Plots

GSM Voice:

Cellular Band (Part 22H) result

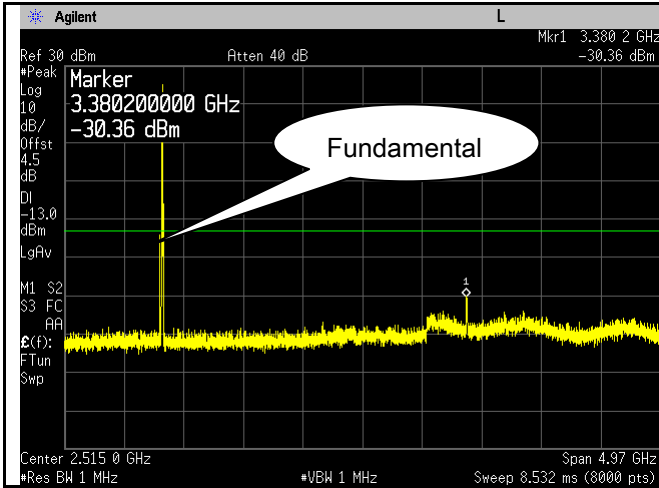

GSM 850 - Low Channel-1

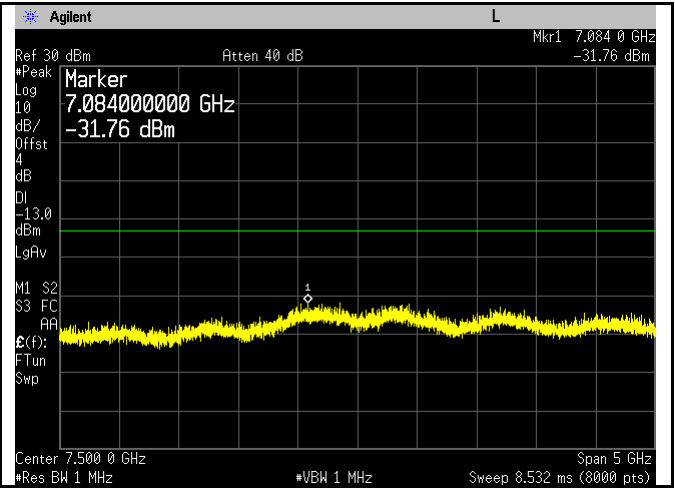

GSM 850 - Low Channel-2

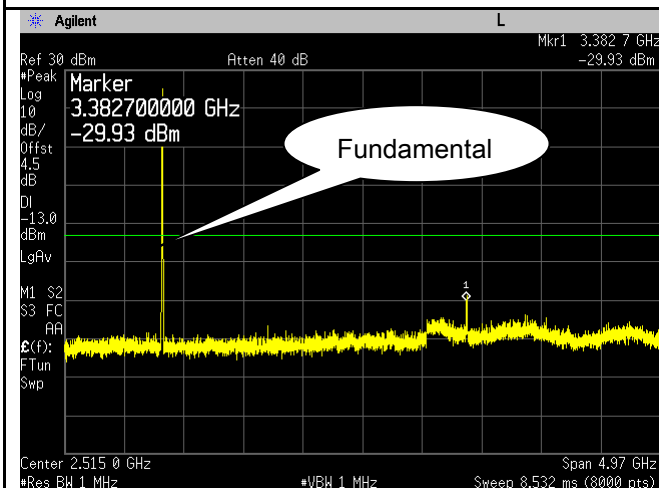

GSM 850 Middle Channel-1

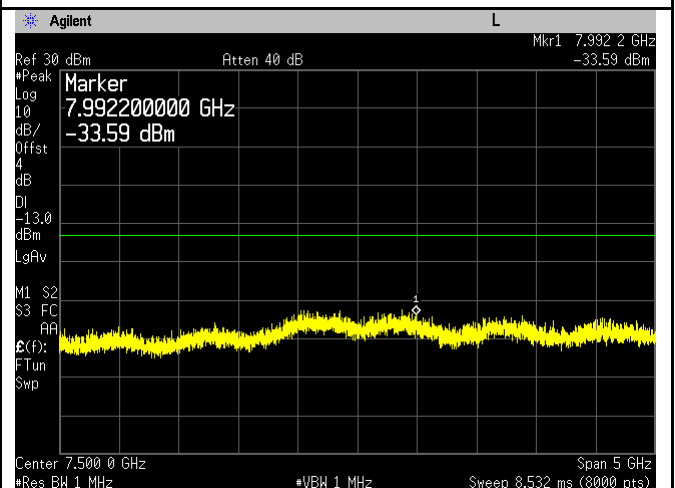

GSM 850 Middle Channel-2

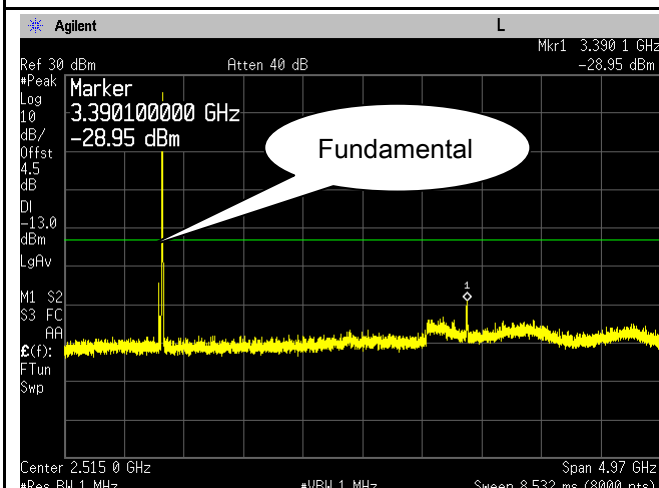

GSM 850 - High Channel-1

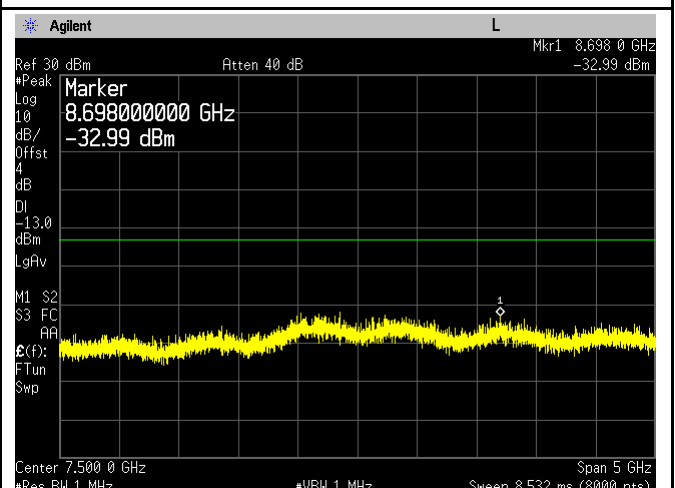

GSM 850 - High Channel-2

PCS Band (Part24E) result

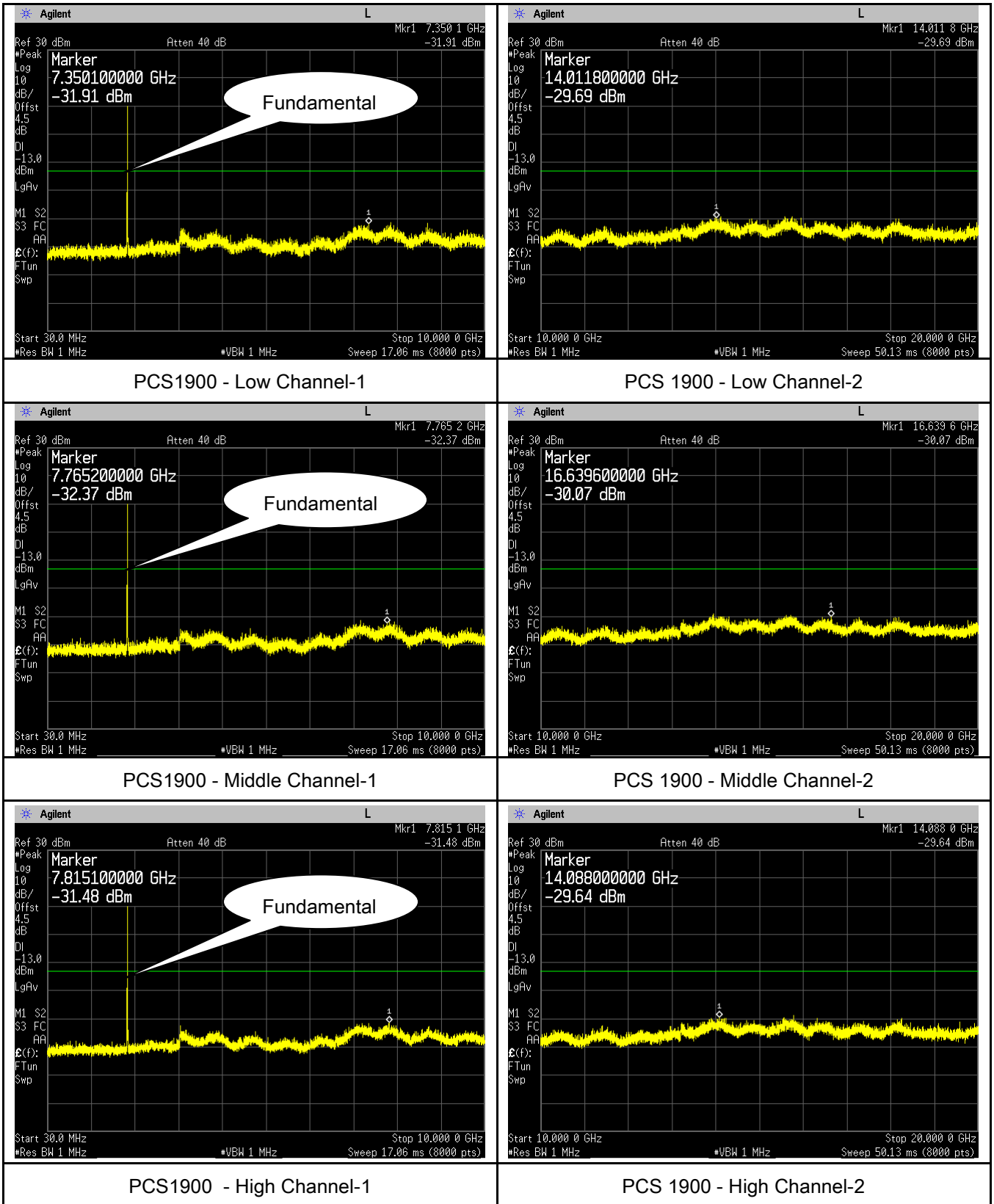

GPRS:

Cellular Band (Part 22H) result

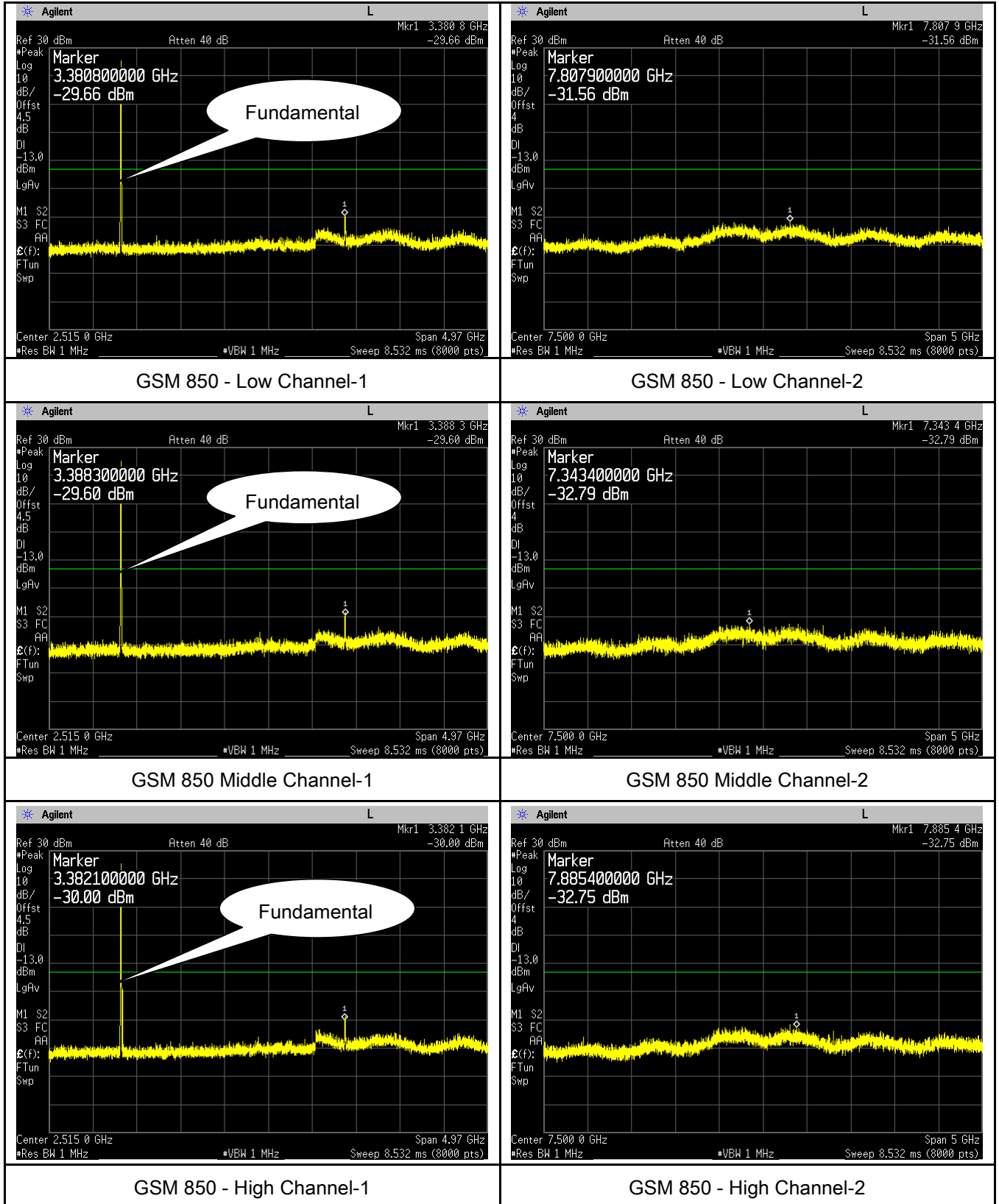

PCS Band (Part24E) result

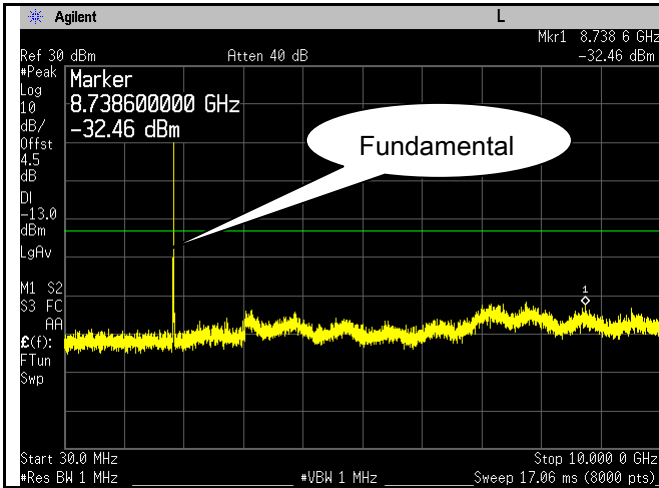

PCS1900 - Low Channel-1

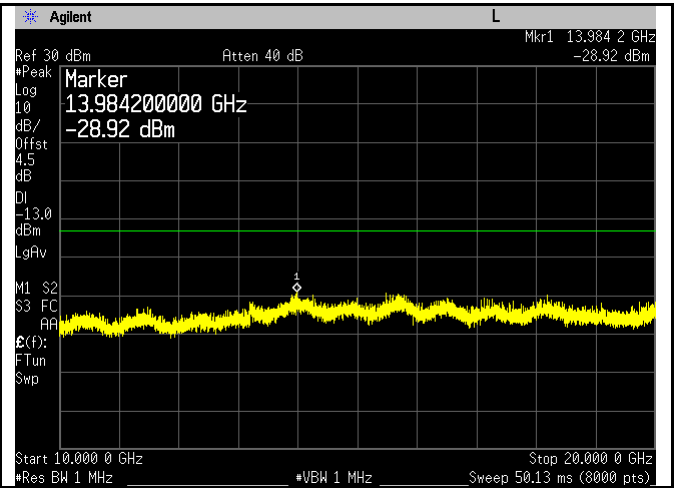

PCS 1900 - Low Channel-2

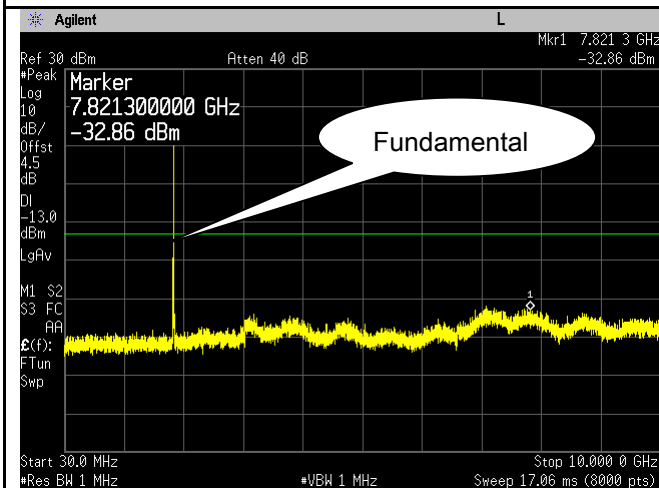

PCS1900 - Middle Channel-1

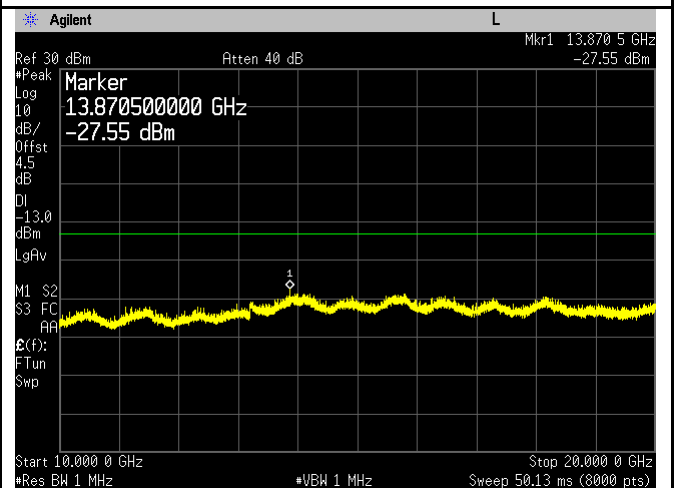

PCS 1900 - Middle Channel-2

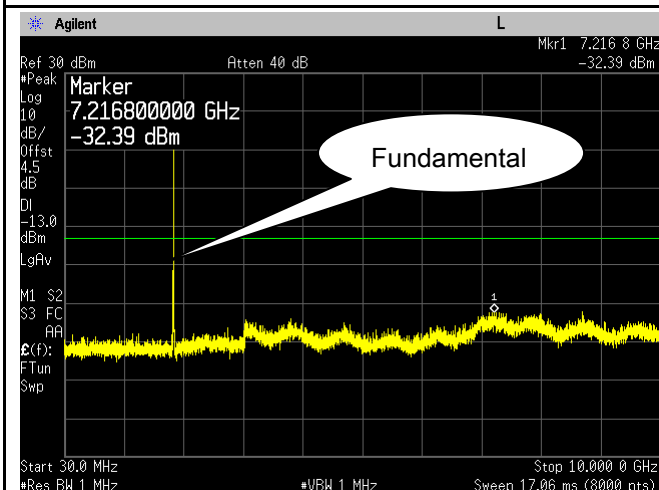

PCS1900 - High Channel-1

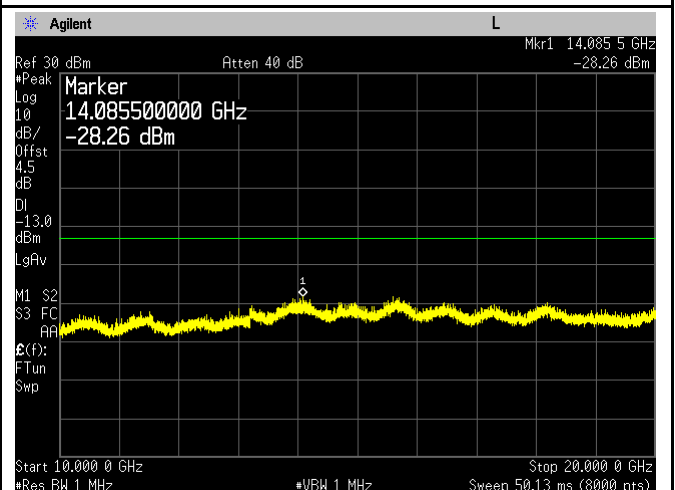

PCS 1900 - High Channel-2

EGPRS (MSC 5):
Cellular Band (Part 22H) result

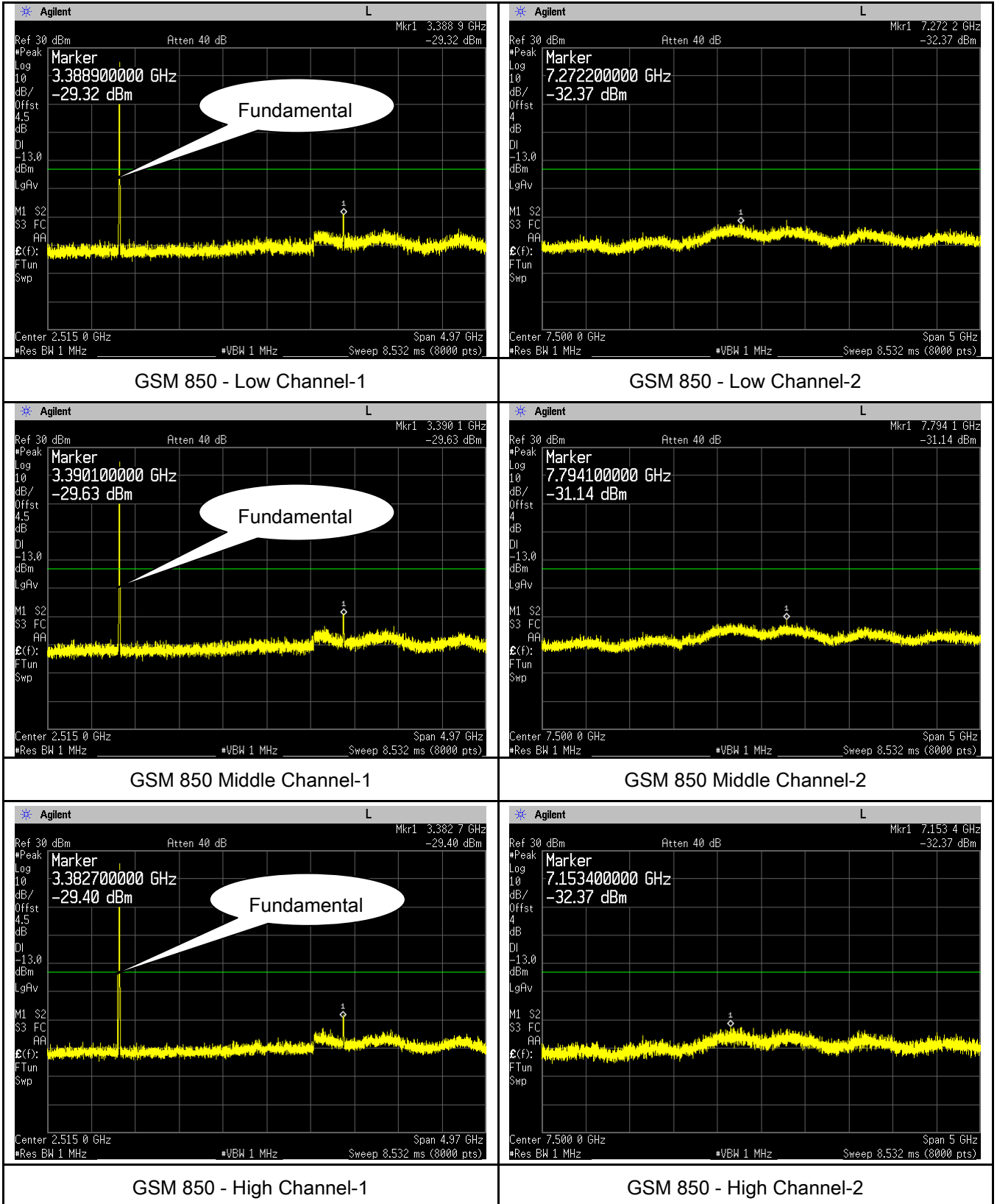

PCS Band (Part24E) result

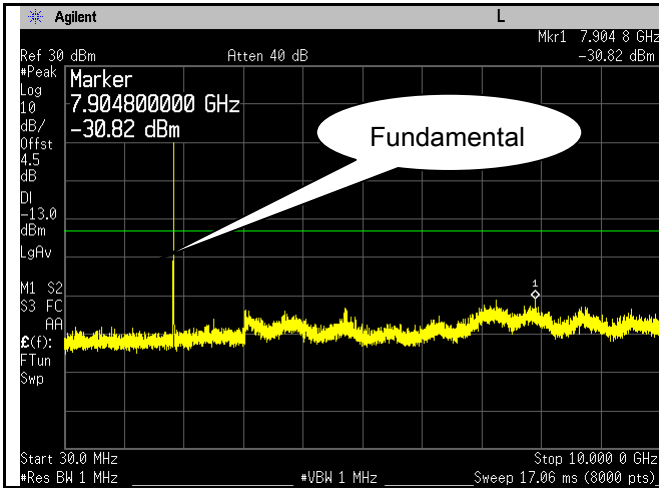

PCS1900 - Low Channel-1

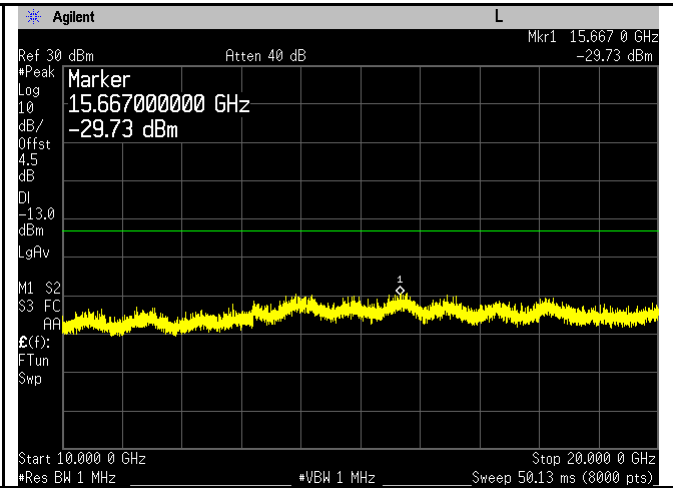

PCS 1900 - Low Channel-2

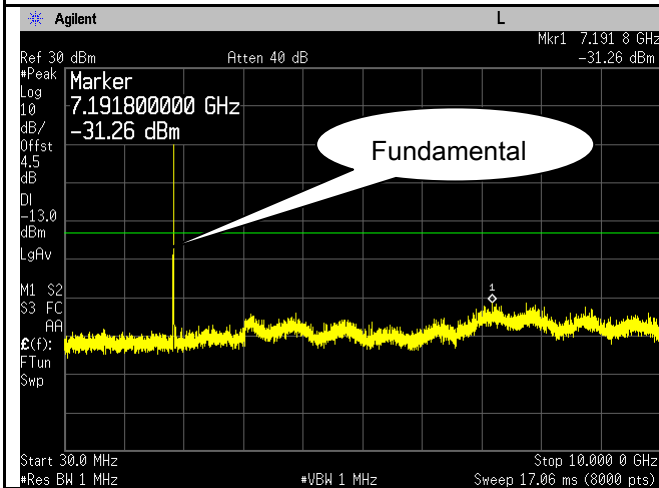

PCS1900 - Middle Channel-1

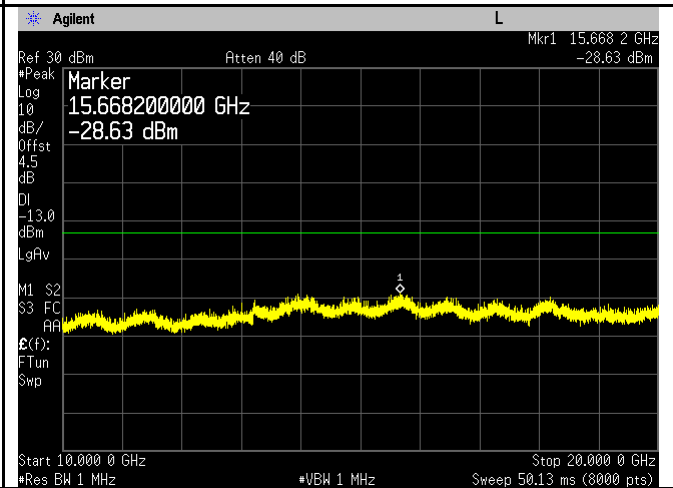

PCS 1900 - Middle Channel-2

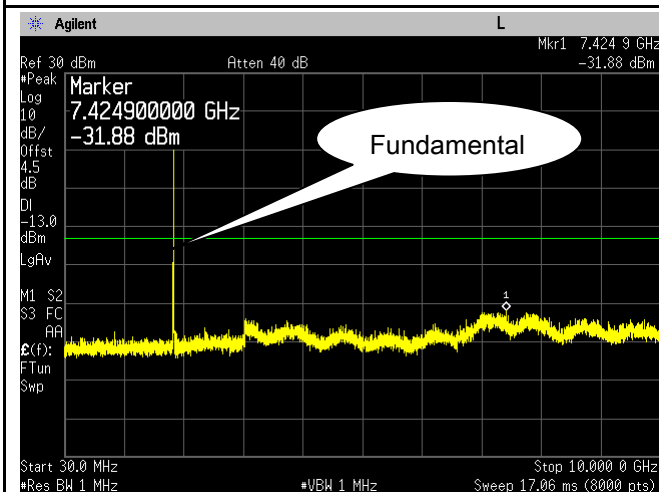

PCS1900 - High Channel-1

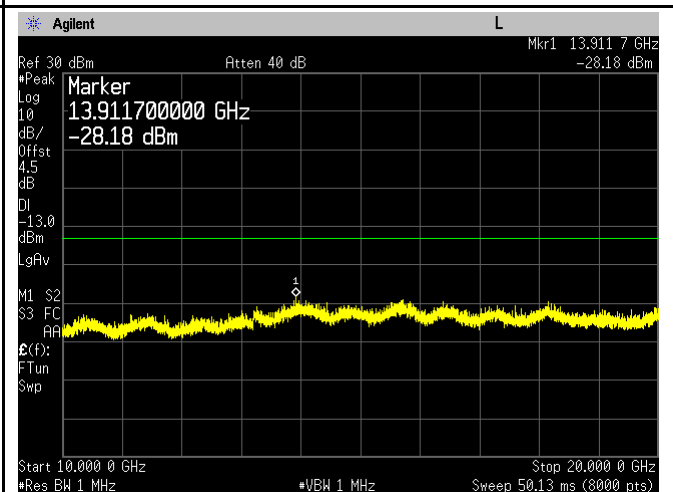

PCS 1900 - High Channel-2

RMC

UMTS-FDD Band V (Part 22H)

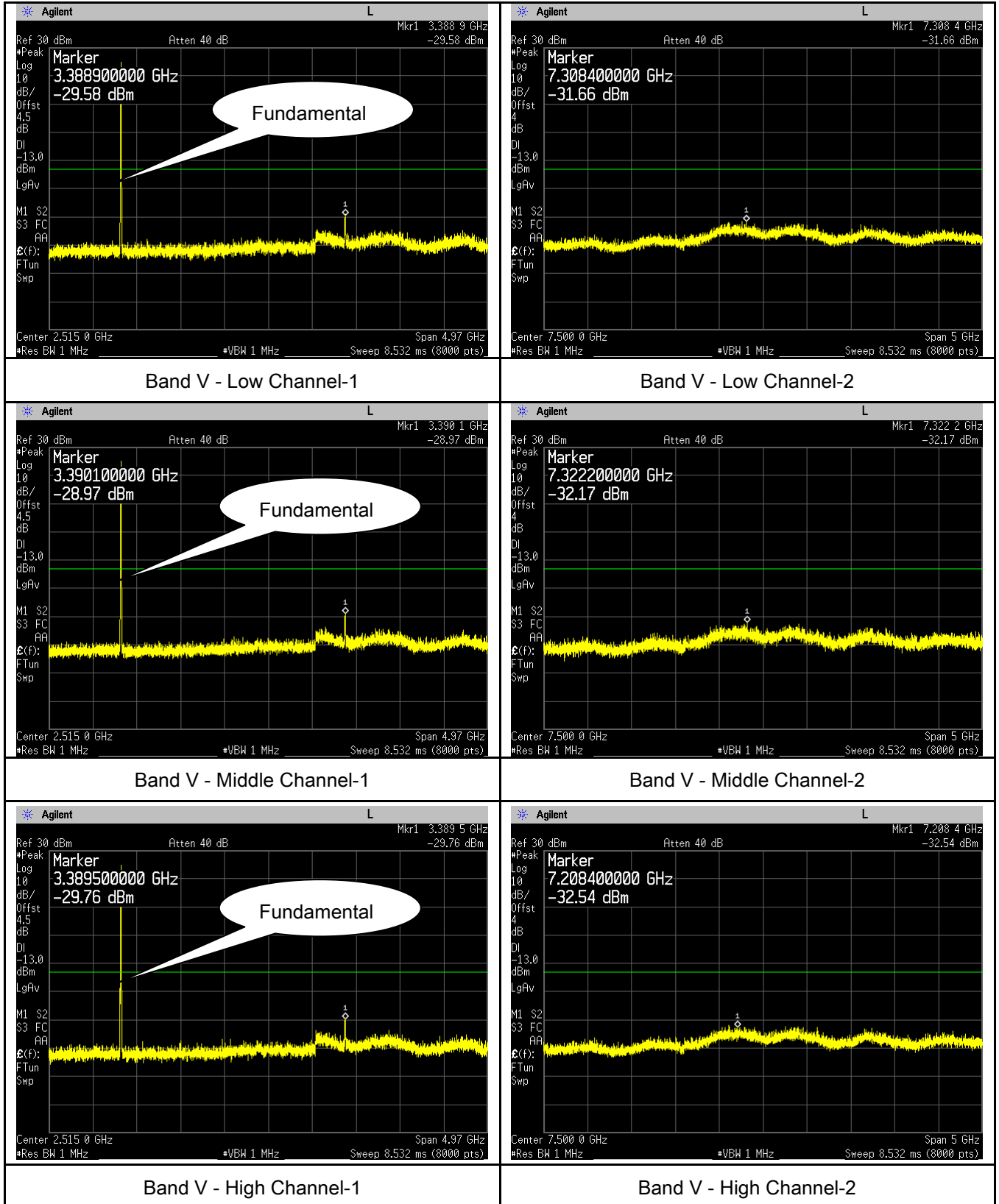

UMTS-FDD Band II (Part 24E)

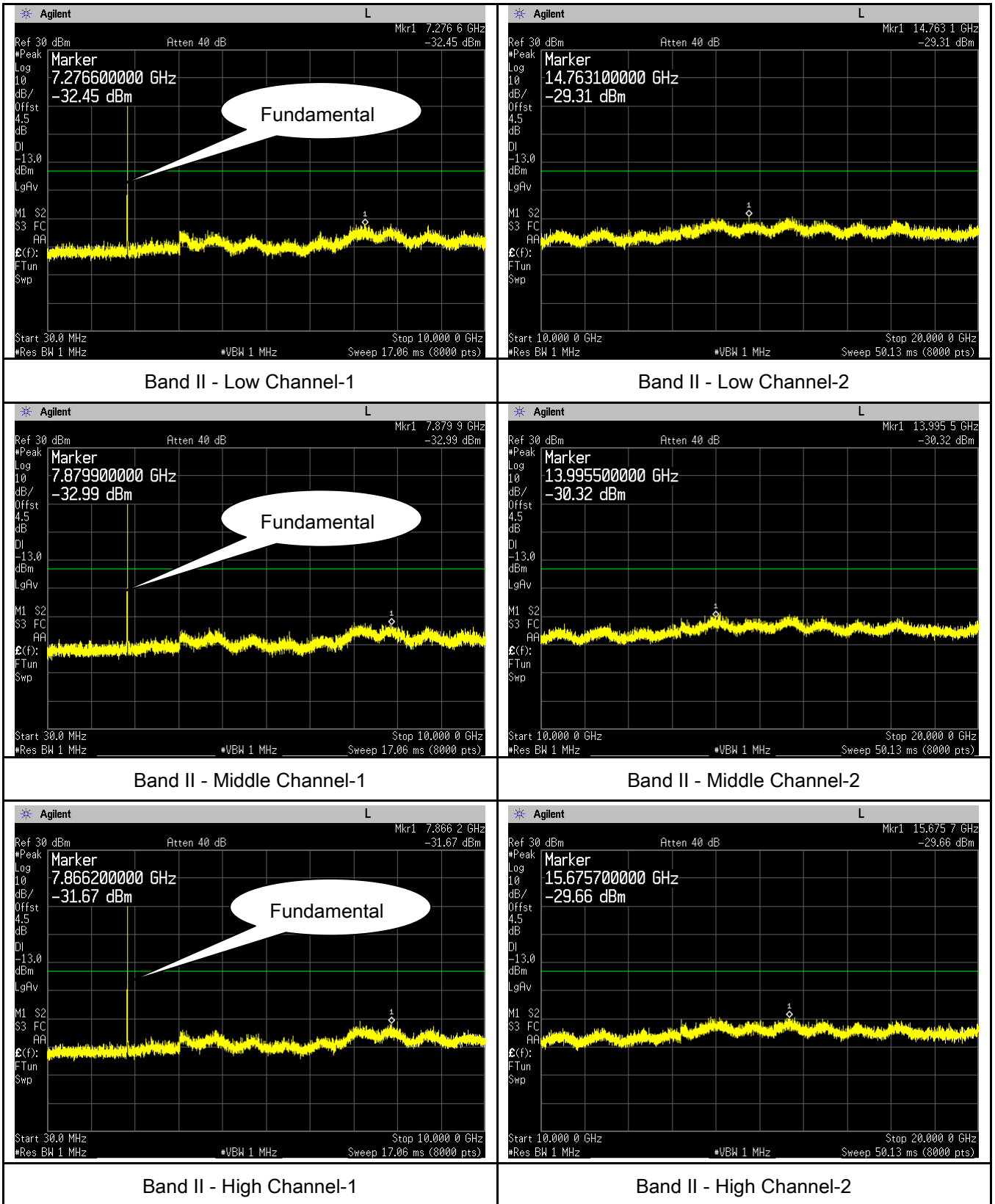

HSDPA:

UMTS-FDD Band V (Part 22H)

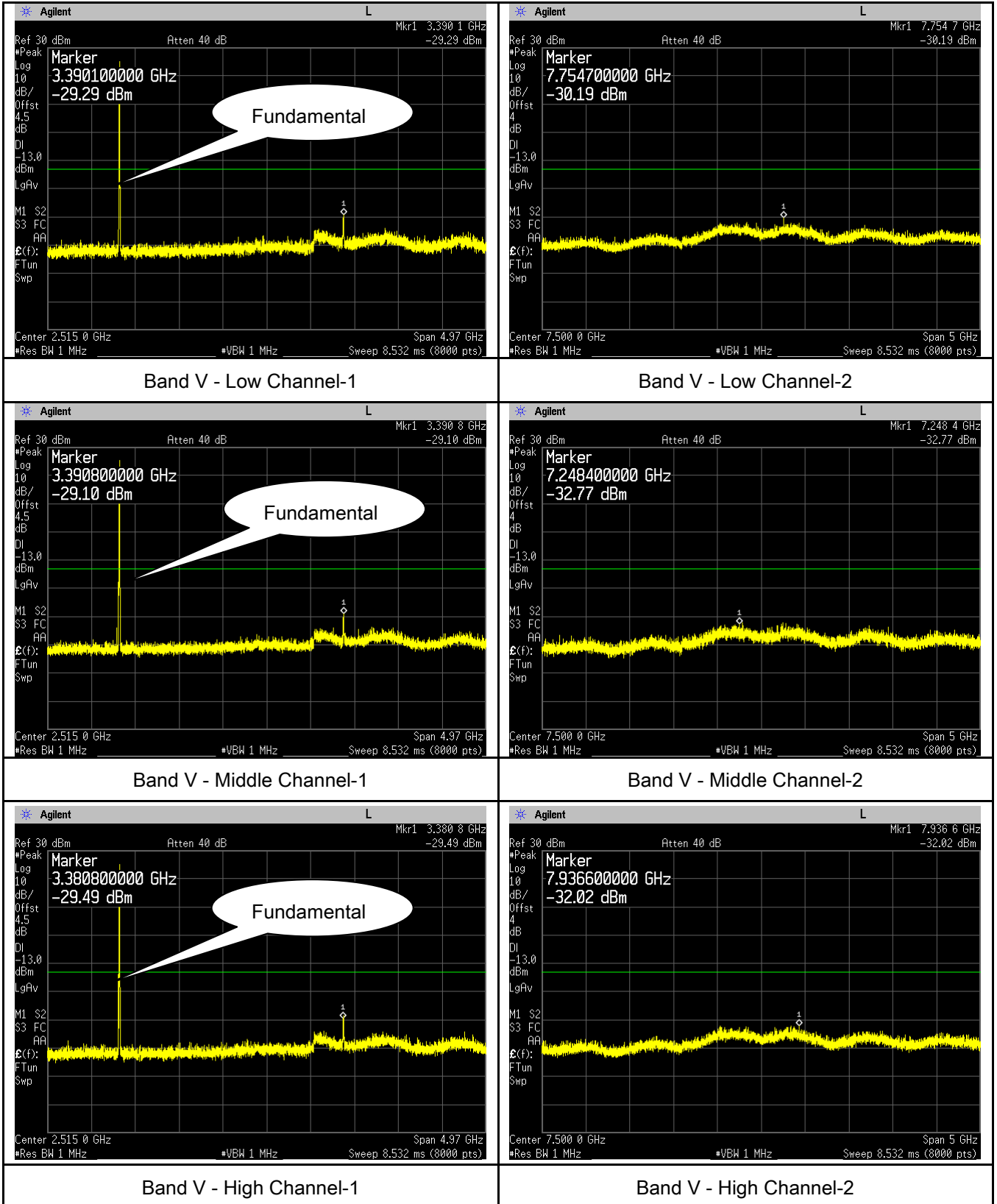

UMTS-FDD Band II (Part 24E)

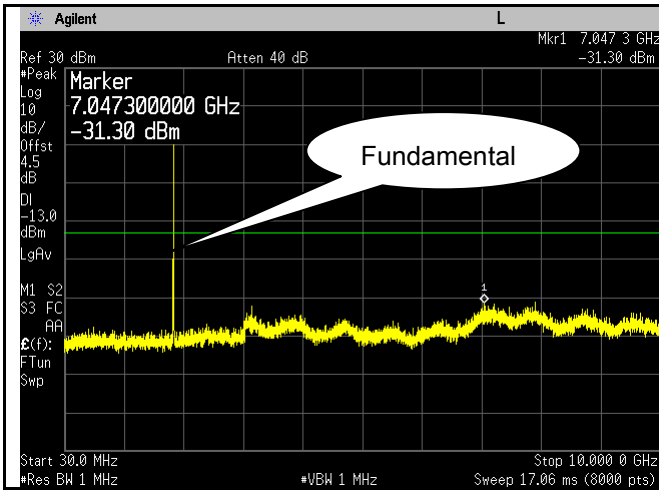

Band II - Low Channel-1

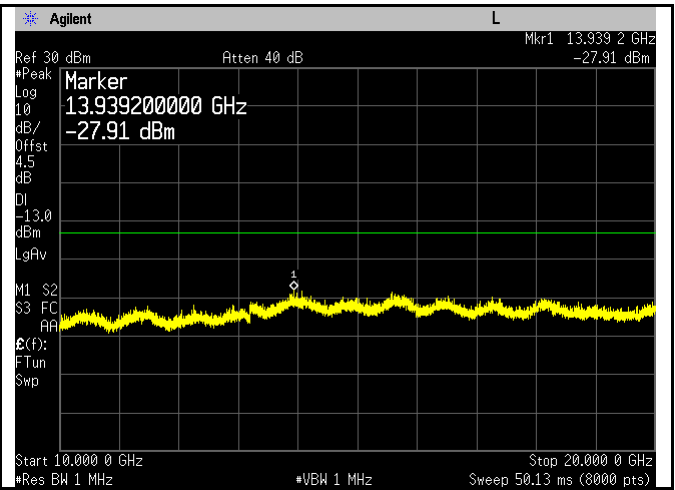

Band II - Low Channel-2

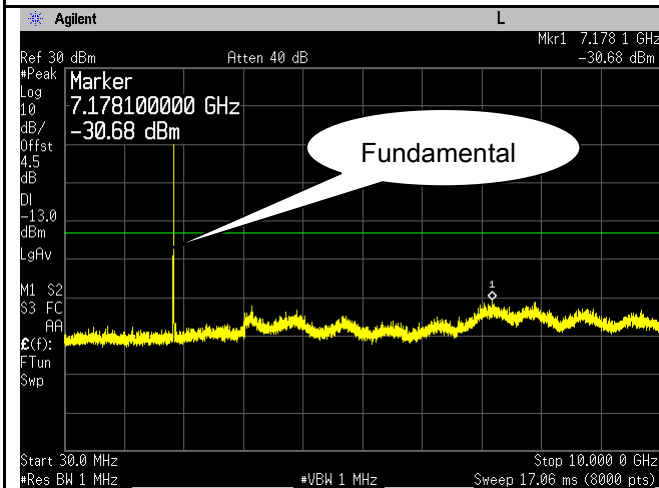

Band II - Middle Channel-1

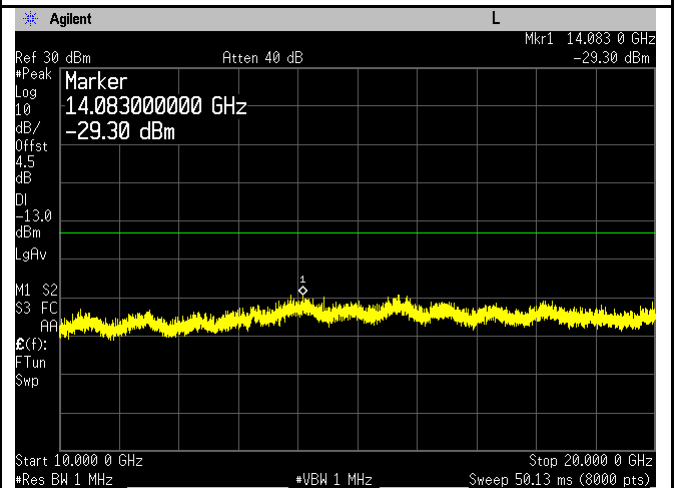

Band II - Middle Channel-2

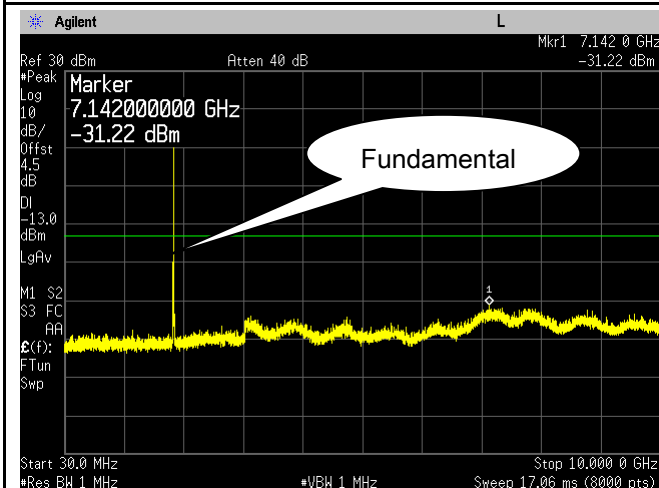

Band II - High Channel-1

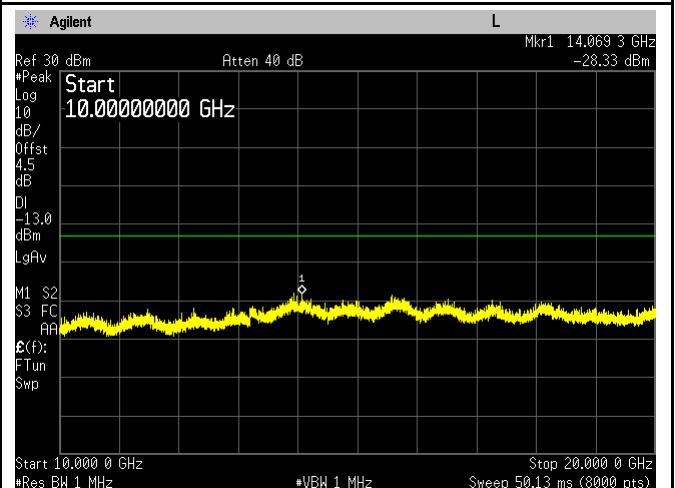

Band II - High Channel-2

HSUPA:

UMTS-FDD Band V (Part 22H)

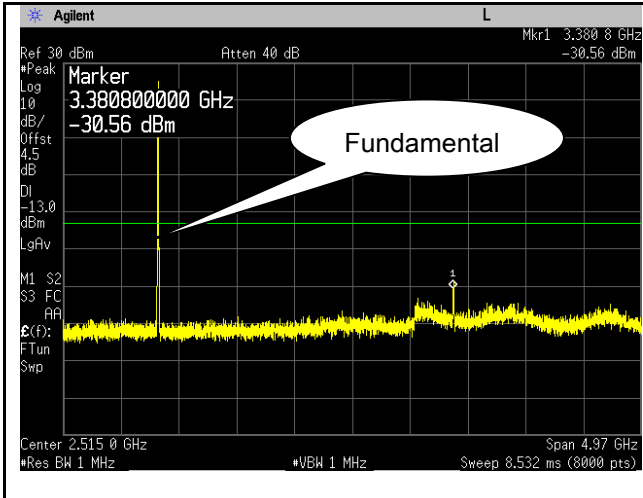

Band V - Low Channel-1

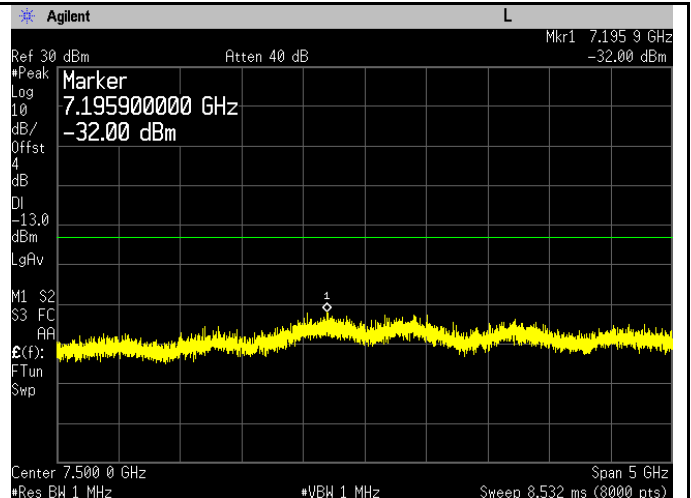

Band V - Low Channel-2

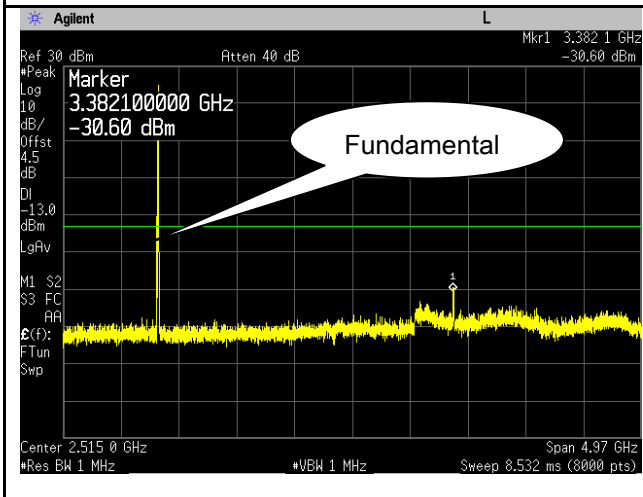

Band V - Middle Channel-1

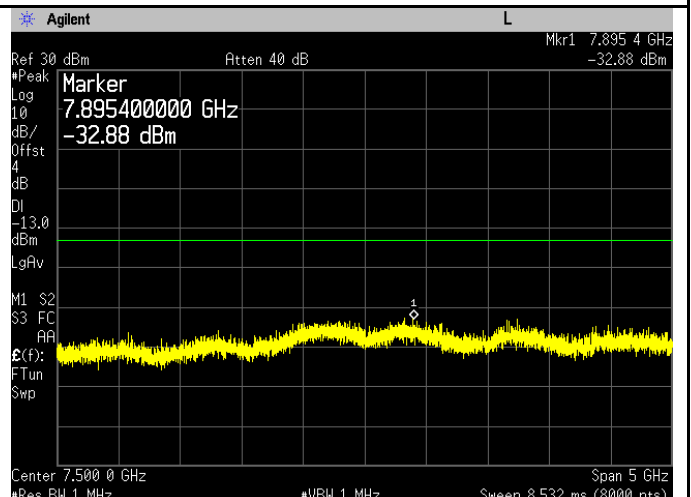

Band V - Middle Channel-2

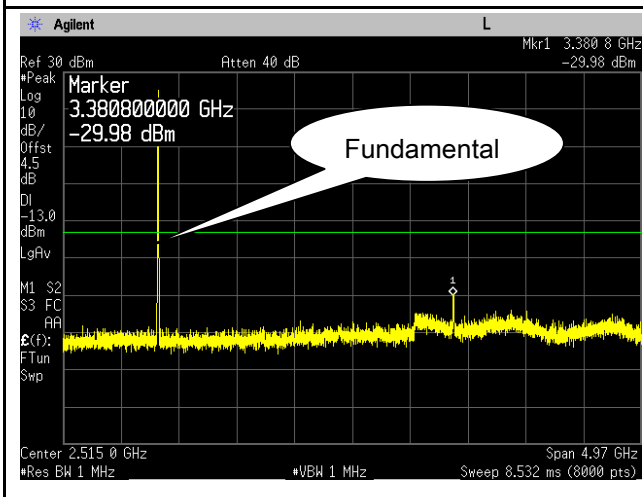

Band V - High Channel-1

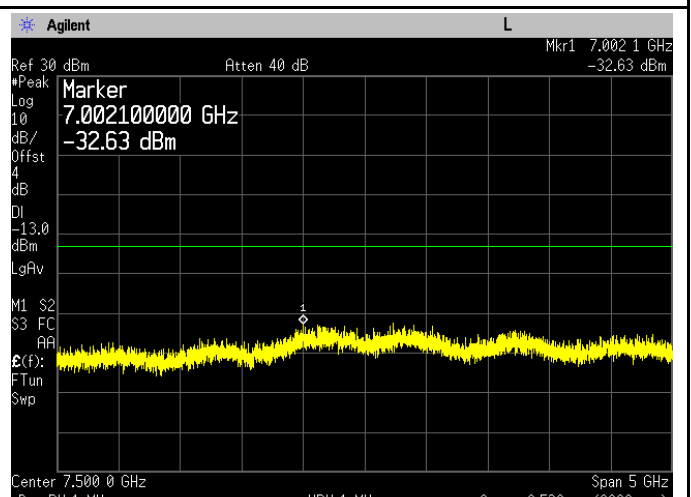

Band V - High Channel-2

UMTS-FDD Band II (Part 24E)

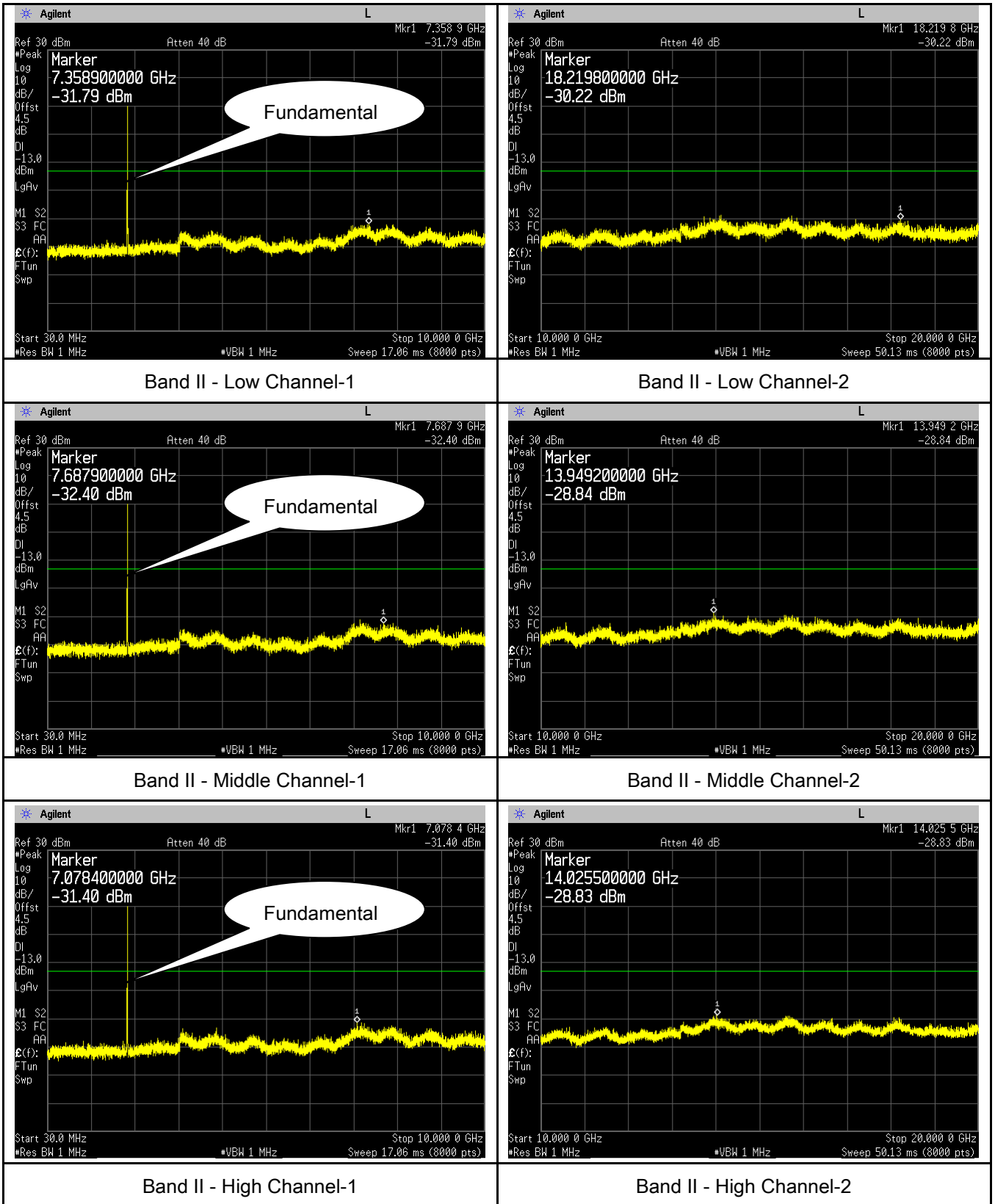

6.6 Spurious Radiated Emissions

Temperature	25 °C
Relative Humidity	57%
Atmospheric Pressure	1023mbar
Test date :	January 27, 2018
Tested By :	Aaron Liang

Requirement(s):

Spec	Item	Requirement	Applicable
§2.1053, §22.917 & §24.238	a)	The power of any emission outside of the authorized operating frequency ranges must be attenuated below the transmitter power (P) by a factor of at least $43 + 10 \log (P)$ dB. The spectrum is scanned from 30 MHz up to a frequency including its 10th harmonic.	<input checked="" type="checkbox"/>

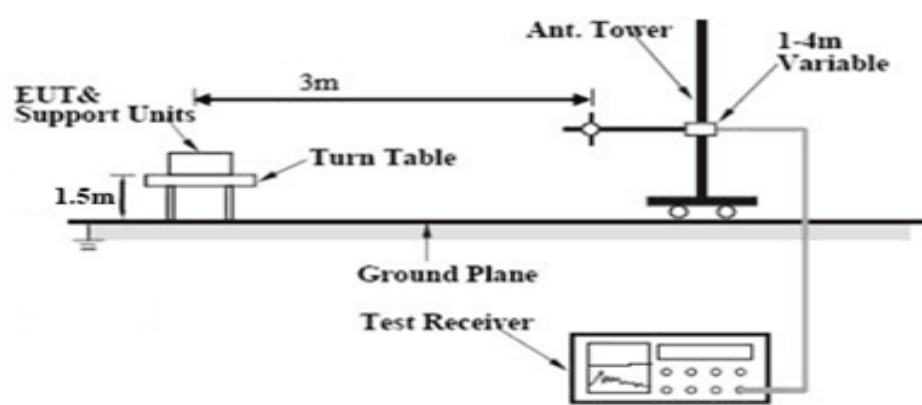
Test setup	
------------	--

Test Procedure	<ol style="list-style-type: none"> The transmitter was placed on a wooden turntable, and it was transmitting into a non-radiating load which was also placed on the turntable. The measurement antenna was placed at a distance of 3 meters from the EUT. During the tests, the antenna height and polarization as well as EUT azimuth were varied in order to identify the maximum level of emissions from the EUT. The test was performed by placing the EUT on 3-orthogonal axis. Remove the EUT and replace it with substitution antenna. A signal generator was connected to the substitution antenna by a non-radiating cable. The absolute levels of the spurious emissions were measured by the substitution. Sample Calculation: EUT Field Strength = Raw Amplitude (dBµV/m) – Amplifier Gain (dB) + Antenna Factor (dB) + Cable Loss (dB) + Filter Attenuation (dB, if used)
----------------	---

Test Report	18070041-FCC-R1
Page	53 of 78

Remark	
Result	<input checked="" type="checkbox"/> Pass <input type="checkbox"/> Fail

Test Data Yes N/A
 Test Plot Yes (See below) N/A

Cellular Band (Part 22H) result

Low channel

Frequency (MHz)	Antenna Polarization (H/V)	Corrected Reading (dBm)	Limit (dBm)	Margin (dB)
1648.4	V	-28.57	-13	-15.57
1648.4	H	-28.82	-13	-15.82
663.88	V	-40.03	-13	-27.03
544.36	H	-36.87	-13	-23.87

Middle channel

Frequency (MHz)	Antenna Polarization (H/V)	Corrected Reading (dBm)	Limit (dBm)	Margin (dB)
1673.2	V	-23.77	-13	-10.77
1673.2	H	-28.24	-13	-15.24
348.06	V	-34.97	-13	-21.97
218.05	H	-39.43	-13	-26.43

High channel

Frequency (MHz)	Antenna Polarization (H/V)	Corrected Reading (dBm)	Limit (dBm)	Margin (dB)
1697.6	V	-31.37	-13	-18.37
1697.6	H	-33.08	-13	-20.08
781.26	V	-38.52	-13	-25.52
647.31	H	-36.18	-13	-23.18

Note:

- 1, The testing has been conformed to $10 \times 848.8 \text{ MHz} = 8,488 \text{ MHz}$
- 2, All other emissions more than 30 dB below the limit
- 3, GSM voice, GPRS and EGPRS mode were investigated. The results above show only the worse cases
- 4, X-Axis, Y-Axis and Z-Axis were investigated. The results above show only the worst case.

PCS Band (Part24E) result

Low channel

Frequency (MHz)	Antenna Polarization (H/V)	Corrected Reading (dBm)	Limit (dBm)	Margin (dB)
3700.4	V	-31.55	-13	-18.55
3700.4	H	-31.11	-13	-18.11
614.31	V	-39.93	-13	-26.93
716.97	H	-39	-13	-26

Middle channel

Frequency (MHz)	Antenna Polarization (H/V)	Corrected Reading (dBm)	Limit (dBm)	Margin (dB)
3760	V	-33.56	-13	-20.56
3760	H	-37.58	-13	-24.58
625.26	V	-35.8	-13	-22.8
825.47	H	-37.94	-13	-24.94

High channel

Frequency (MHz)	Antenna Polarization (H/V)	Corrected Reading (dBm)	Limit (dBm)	Margin (dB)
3819.6	V	-36.16	-13	-23.16
3819.6	H	-30.57	-13	-17.57
755.97	V	-36.17	-13	-23.17
791.79	H	-39.55	-13	-26.55

Note:

- 1, The testing has been conformed to $10 \times 1909.8 \text{ MHz} = 19,098 \text{ MHz}$
- 2, All other emissions more than 30 dB below the limit
- 3, GSM voice, GPRS and EGPRS mode were investigated. The results above show only the worse cases
- 4, X-Axis, Y-Axis and Z-Axis were investigated. The results above show only the worst case.
- 5, The radiated spurious test above 18GHz is subcontracted to SIEMIC (Nanjing-China) Laboratories. and found 30dB below the limit at least.

UMTS-FDD Band V (Part 22H)

Low channel

Frequency (MHz)	Antenna Polarization (H/V)	Corrected Reading (dBm)	Limit (dBm)	Margin (dB)
1652.8	V	-34.55	-13	-21.55
1652.8	H	-26.88	-13	-13.88
566.4	V	-37.87	-13	-24.87
829.25	H	-40.51	-13	-27.51

Middle channel

Frequency (MHz)	Antenna Polarization (H/V)	Corrected Reading (dBm)	Limit (dBm)	Margin (dB)
1670	V	-32.7	-13	-19.7
1670	H	-35.54	-13	-22.54
351.14	V	-40.55	-13	-27.55
789.55	H	-35.56	-13	-22.56

High channel

Frequency (MHz)	Antenna Polarization (H/V)	Corrected Reading (dBm)	Limit (dBm)	Margin (dB)
1693.2	V	-31.82	-13	-18.82
1693.2	H	-31.74	-13	-18.74
375.47	V	-35.78	-13	-22.78
718.59	H	-39.77	-13	-26.77

Note:

1, The testing has been conformed to $10 \times 846.6 \text{ MHz} = 8,466 \text{ MHz}$

2, All other emissions more than 30 dB below the limit

3, RMC, HSUPA and HSDPA mode were investigated. The results above show only the worse cases

4, X-Axis, Y-Axis and Z-Axis were investigated. The results above show only the worst case.

UMTS-FDD Band II (Part 24E)

Low channel

Frequency (MHz)	Antenna Polarization (H/V)	Corrected Reading (dBm)	Limit (dBm)	Margin (dB)
3704.8	V	-37.39	-13	-24.39
3704.8	H	-29.96	-13	-16.96
656.07	V	-34.18	-13	-21.18
371.45	H	-41.11	-13	-28.11

Middle channel

Frequency (MHz)	Antenna Polarization (H/V)	Corrected Reading (dBm)	Limit (dBm)	Margin (dB)
3760	V	-35.07	-13	-22.07
3760	H	-38.85	-13	-25.85
724.27	V	-43.39	-13	-30.39
830.89	H	-42.22	-13	-29.22

High channel

Frequency (MHz)	Antenna Polarization (H/V)	Corrected Reading (dBm)	Limit (dBm)	Margin (dB)
3815.2	V	-36.32	-13	-23.32
3815.2	H	-35.38	-13	-22.38
340.91	V	-39.49	-13	-26.49
676.95	H	-43.6	-13	-30.6

Note:

1, The testing has been conformed to $10 \times 1907.6 \text{ MHz} = 19,076 \text{ MHz}$

2, All other emissions more than 30 dB below the limit

3, RMC, HSUPA and HSDPA mode were investigated. The results above show only the worse cases

4, X-Axis, Y-Axis and Z-Axis were investigated. The results above show only the worst case

5, The radiated spurious test above 18GHz is subcontracted to SIEMIC (Nanjing-China) Laboratories. and found 30dB below the limit at least.

6.7 Band Edge

Temperature	25 °C
Relative Humidity	57%
Atmospheric Pressure	1023mbar
Test date :	January 27, 2018
Tested By :	Aaron Liang

Requirement(s):

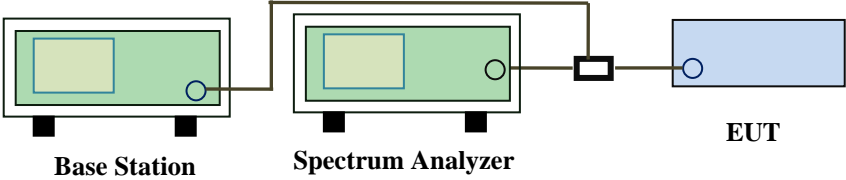
Spec	Item	Requirement	Applicable
§22.917(a) §24.238(a)	a)	The power of any emission outside of the authorized operating frequency ranges must be lower than the transmitter power (P) by a factor of at least $43 + 10 \log (P)$ dB.	<input checked="" type="checkbox"/>
Test setup	 <p>The diagram shows a Base Station (green box) and a Spectrum Analyzer (green box) connected to an EUT (blue box) via a power divider (black box). The Base Station and Spectrum Analyzer are connected to the power divider, which then splits the signal to the EUT.</p>		
Procedure	<ul style="list-style-type: none"> - The EUT was connected to Spectrum Analyzer and Base Station via power divider. - The Band Edges of low and high channels for the highest RF powers were measured. Setting RBW as roughly BW/100. 		
Remark			
Result	<input checked="" type="checkbox"/> Pass <input type="checkbox"/> Fail		

Test Data Yes N/A
 Test Plot Yes (See below) N/A

GSM Voice:

Cellular Band (Part 22H) result

Frequency (MHz)	Emission (dBm)	Limit (dBm)
823.997	-16.02	-13
849.005	-16.32	-13

PCS Band (Part24E) result

Frequency (MHz)	Emission (dBm)	Limit (dBm)
1849.997	-16.81	-13
1910.003	-27.24	-13

GPRS:

Cellular Band (Part 22H) result

Frequency (MHz)	Emission (dBm)	Limit (dBm)
823.992	-16.93	-13
849.012	-17.98	-13

PCS Band (Part24E) result

Frequency (MHz)	Emission (dBm)	Limit (dBm)
1849.997	-18.89	-13
1910.008	-22.61	-13

EGPRS (MSC5):

Cellular Band (Part 22H) result

Frequency (MHz)	Emission (dBm)	Limit (dBm)
823.997	-16.07	-13
849.003	-18.61	-13

PCS Band (Part24E) result

Frequency (MHz)	Emission (dBm)	Limit (dBm)
1849.996	-18.89	-13
1910.003	-21.98	-13

RMC:

UMTS-FDD Band V (Part 22H)

Frequency (MHz)	Emission (dBm)	Limit (dBm)
823.19	-25.38	-13
849.02	-22.37	-13

UMTS-FDD Band II (Part 24E)

Frequency (MHz)	Emission (dBm)	Limit (dBm)
1849.02	-24.32	-13
1910.01	-23.53	-13

HSDPA:

UMTS-FDD Band V (Part 22H)

Frequency (MHz)	Emission (dBm)	Limit (dBm)
822.83	-26.93	-13
849.89	-24.31	-13

UMTS-FDD Band II (Part 24E)

Frequency (MHz)	Emission (dBm)	Limit (dBm)
1849.06	-22.60	-13
1910.01	-26.09	-13

HSUPA:

UMTS-FDD Band V (Part 22H)

Frequency (MHz)	Emission (dBm)	Limit (dBm)
822.83	-25.14	-13
849.02	-24.04	-13

UMTS-FDD Band II (Part 24E)

Frequency (MHz)	Emission (dBm)	Limit (dBm)
1849.13	-24.32	-13
1910.01	-23.55	-13

GSM Voice:

Test Plots

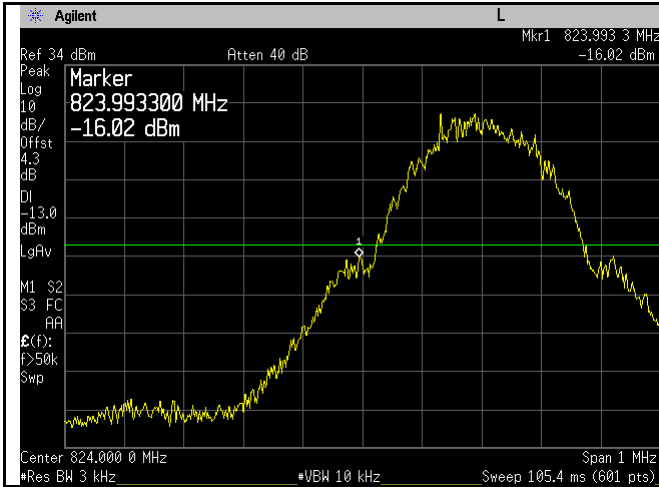

Cellular Band - Low Channel

Note: Offset=Cable loss (4.0) + 10log
(3.23/3)=4.0+0.3=4.3dB

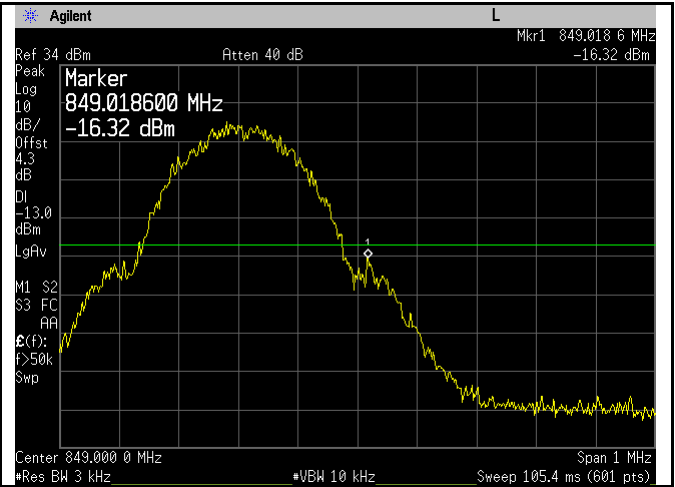

Cellular Band - High Channel

Note: Offset=Cable loss (4.0) + 10log
(3.26/3)=4.0+0.3=4.3dB

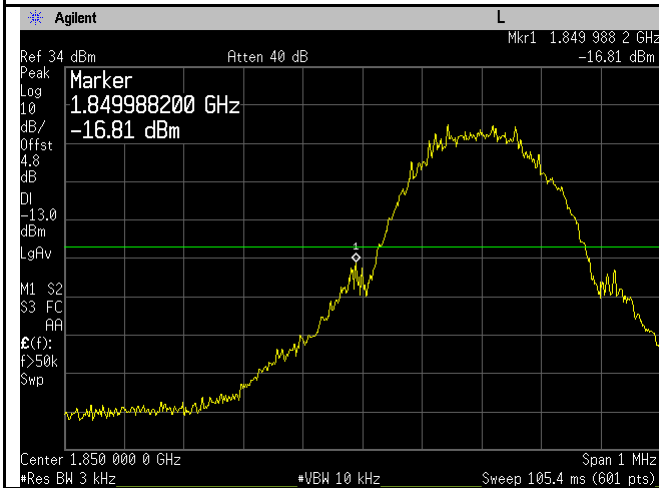

PCS Band - Low Channel

Note: Offset=Cable loss (4.0) + 10log
(3.24/3)=4.5+0.3=4.8dB

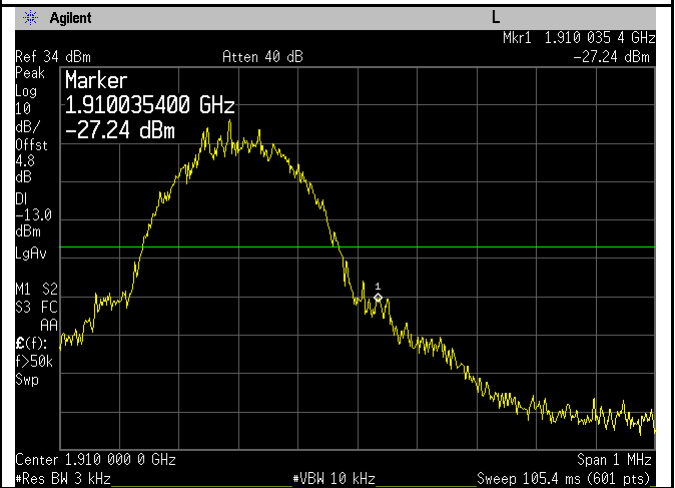

PCS Band - High Channel

Note: Offset=Cable loss (4.0) + 10log
(3.22/3)=4.5+0.3=4.8dB

GPRS:

Test Plots

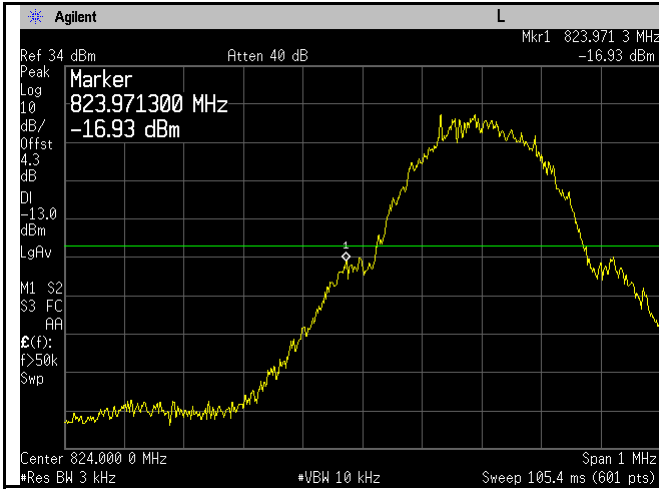

Cellular Band - Low Channel

Note: Offset=Cable loss (4.0) + 10log
(3.17/3)=4.0+0.3=4.3dB

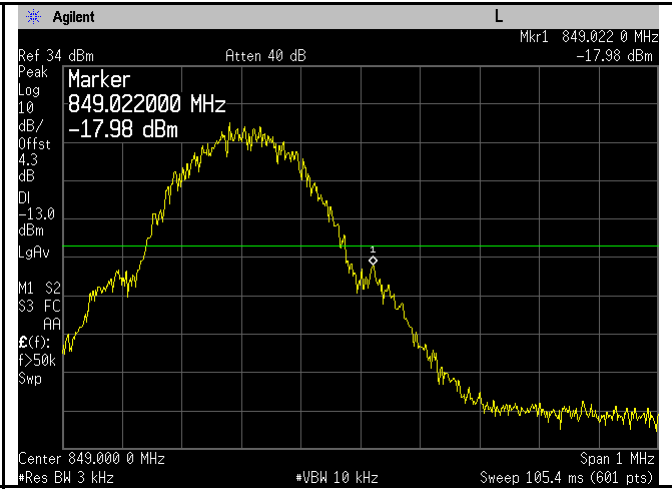

Cellular Band - High Channel

Note: Offset=Cable loss (4.0) + 10log
(3.26/3)=4.0+0.3=4.3dB

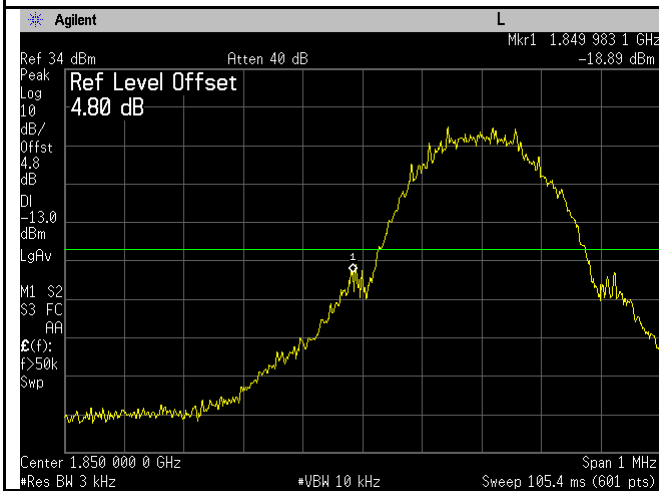

PCS Band - Low Channel

Note: Offset=Cable loss (4.5) + 10log
(3.30/3)=4.5+0.3=4.8dB

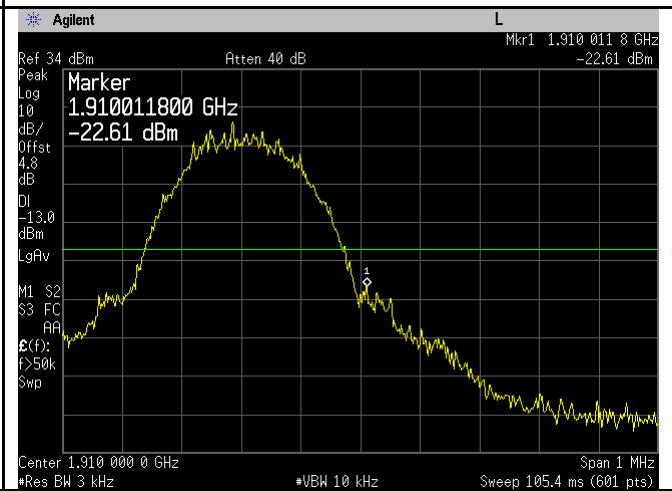

PCS Band - High Channel

Note: Offset=Cable loss (4.5) + 10log
(3.19/3)=4.5+0.3=4.8dB

EGPRS:

Test Plots

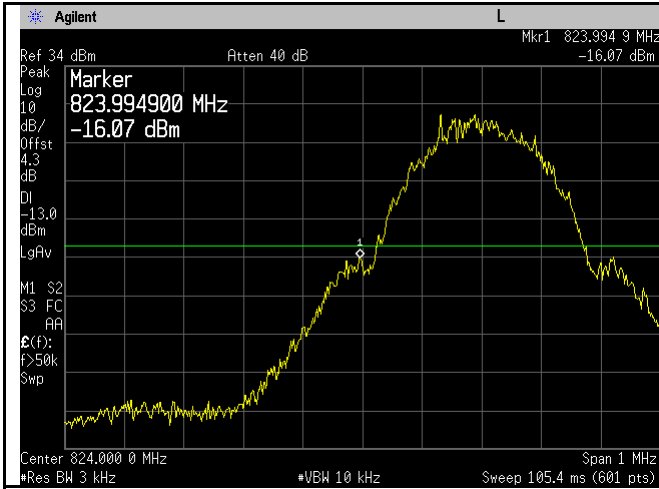

Cellular Band - Low Channel

Note: Offset=Cable loss (4.0) + 10log
(3.18/3)=4.0+0.3=4.3dB

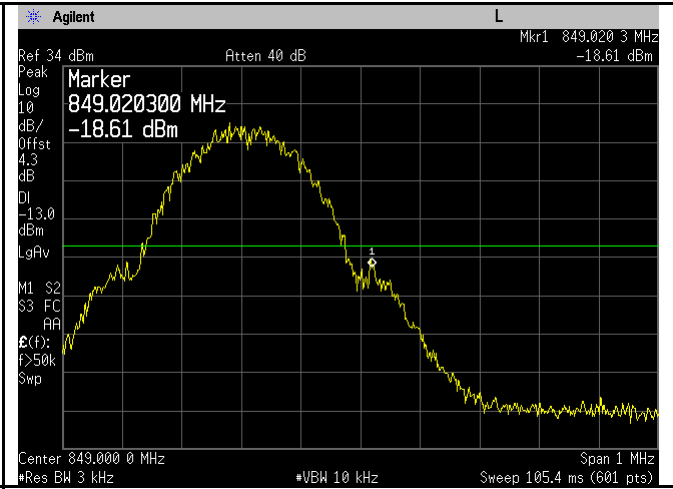

Cellular Band - High Channel

Note: Offset=Cable loss (4.0) + 10log
(3.20/3)=4.0+0.3=4.3dB

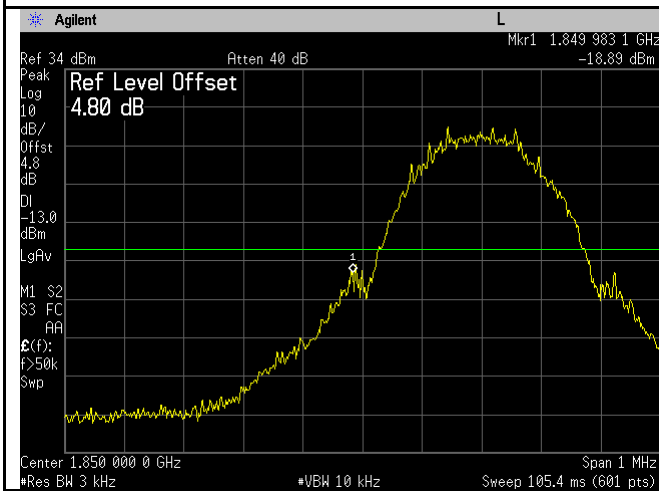

PCS Band - Low Channel

Note: Offset=Cable loss (4.5) + 10log
(3.29/3)=4.5+0.3=4.8dB

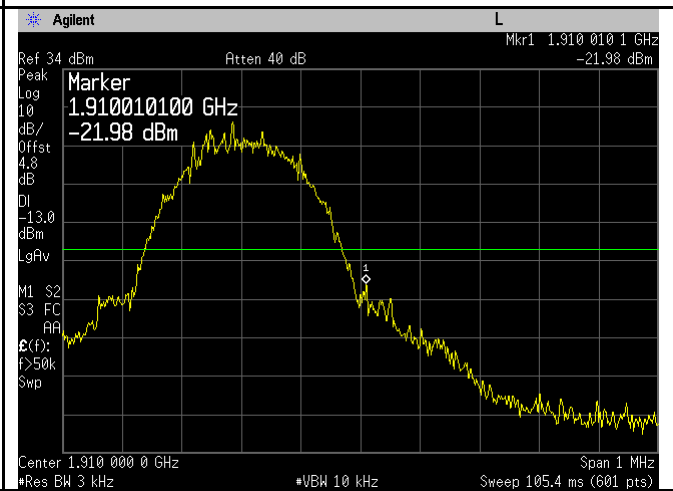

PCS Band - High Channel

Note: Offset=Cable loss (4.5) + 10log
(3.20/3)=4.5+0.3=4.8dB

RMC:

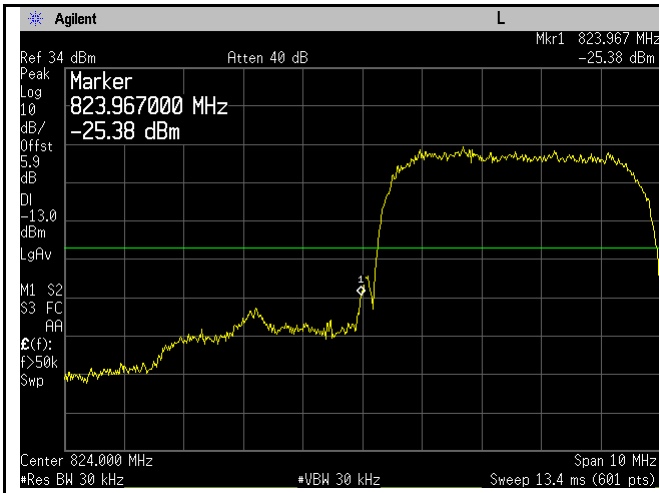

UMTS-FDD Band V - Low Channel

Note: Offset=Cable loss (4.0) + 10log
(47.20/30)=4.0+1.9=5.9dB

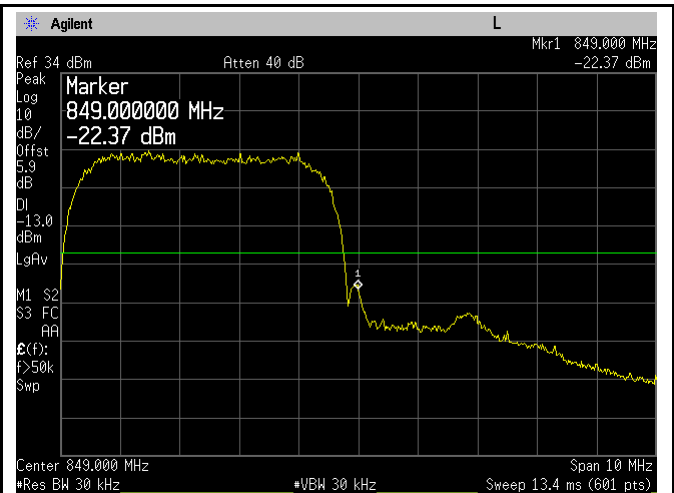

UMTS-FDD Band V - High Channel

Note: Offset=Cable loss (4.0) + 10log
(47.07/30)=4.0+1.9=5.9dB

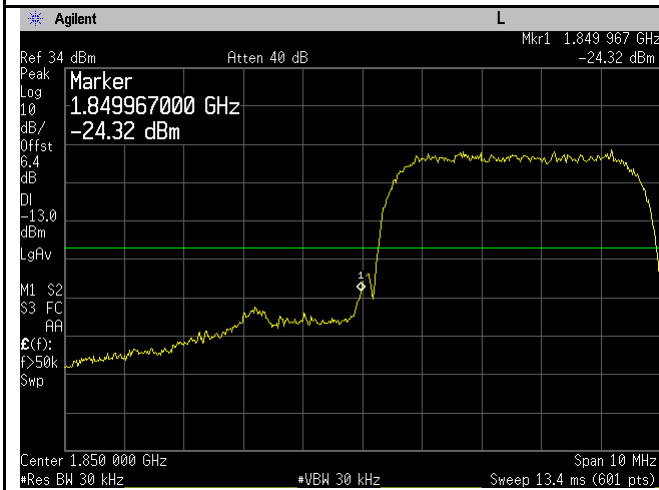

UMTS-FDD Band II - Low Channel

Note: Offset=Cable loss (4.5) + 10log
(47.41/30)=4.5+1.9=6.4dB

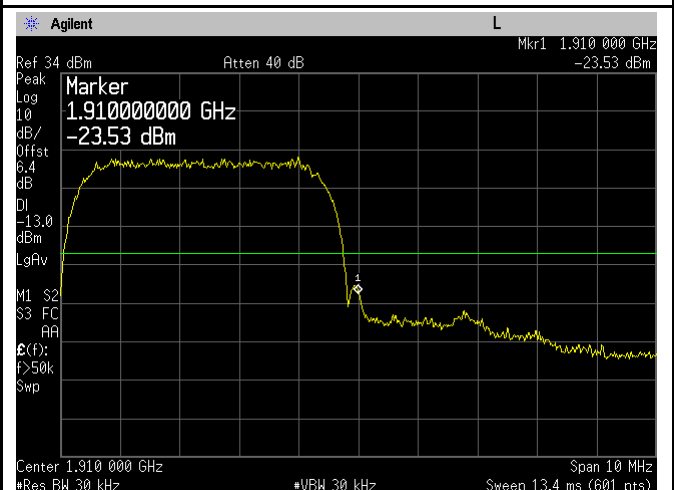

UMTS-FDD Band II - High Channel

Note: Offset=Cable loss (4.5) + 10log
(47.20/30)=4.5+1.9=6.4dB

HSDPA:

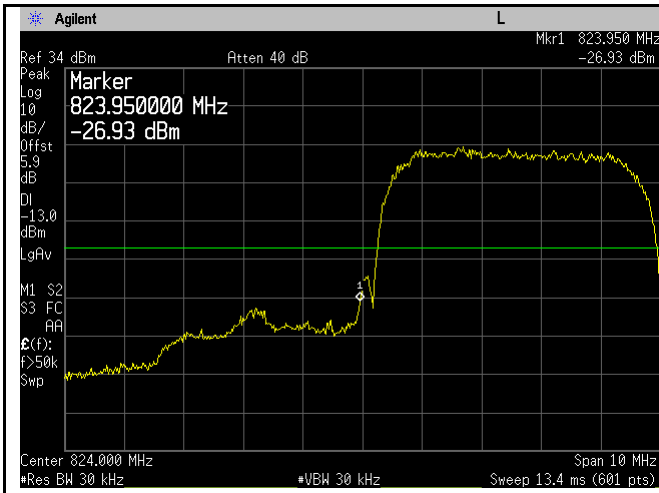

UMTS-FDD Band V - Low Channel

Note: Offset=Cable loss (4.0) + 10log
(47.40/30)=4.0+1.9=5.9dB

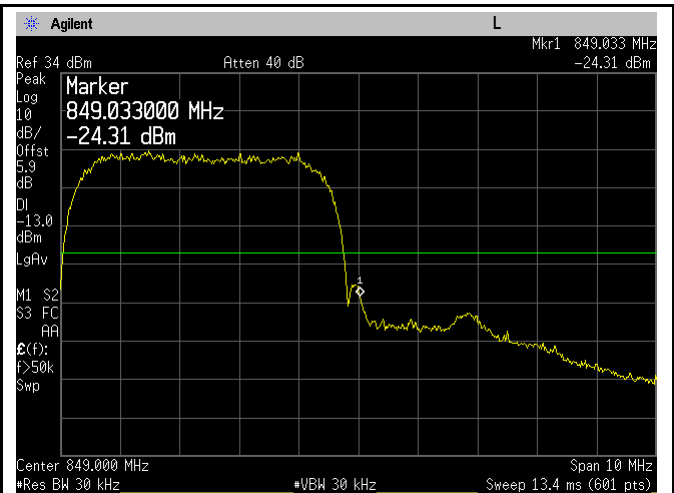

UMTS-FDD Band V - High Channel

Note: Offset=Cable loss (4.0) + 10log
(46.94/30)=4.0+1.9=5.9dB

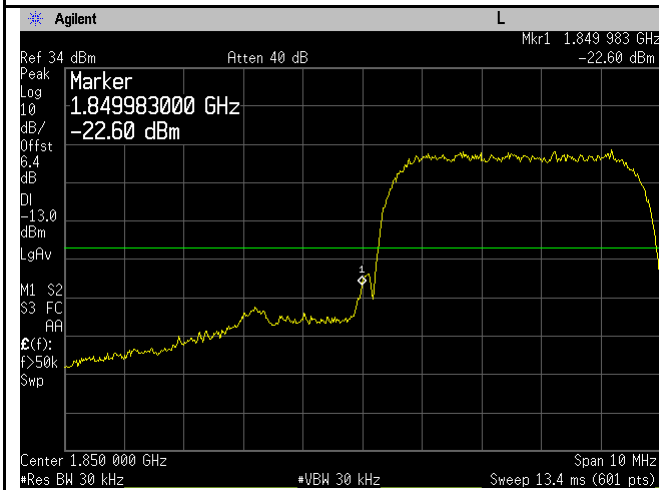

UMTS-FDD Band II - Low Channel

Note: Offset=Cable loss (4.5) + 10log
(47.32/30)=4.5+1.9=6.4dB

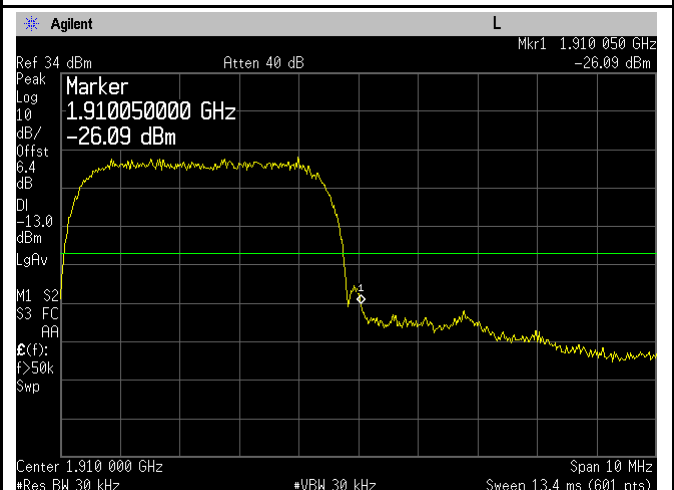

UMTS-FDD Band II - High Channel

Note: Offset=Cable loss (4.5) + 10log
(47.27/30)=4.5+1.9=6.4dB

HSUPA:

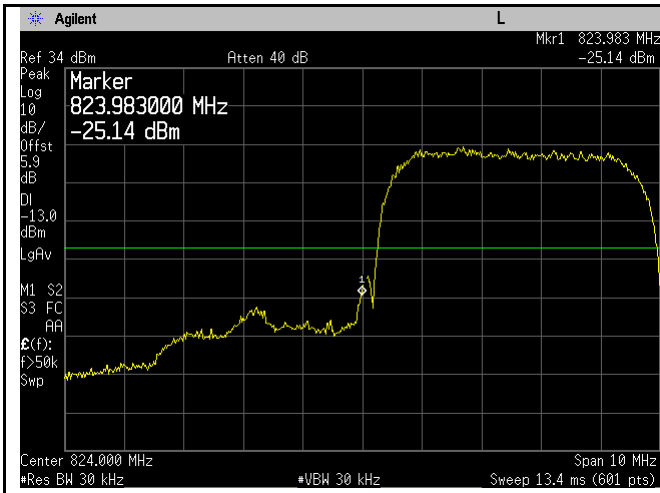

UMTS-FDD Band V - Low Channel

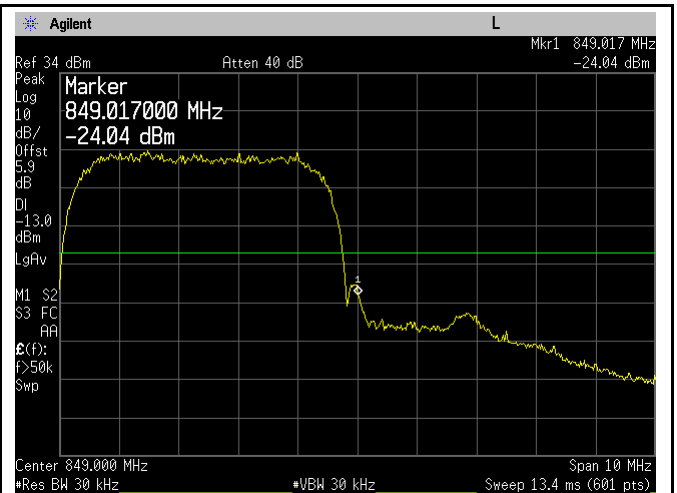

UMTS-FDD Band V - High Channel

Note: Offset=Cable loss (4.0) + 10log
(47.38/30)=4.0+1.9=5.9dB

Note: Offset=Cable loss (4.0) + 10log
(46.91/30)=4.0+1.9=5.9dB

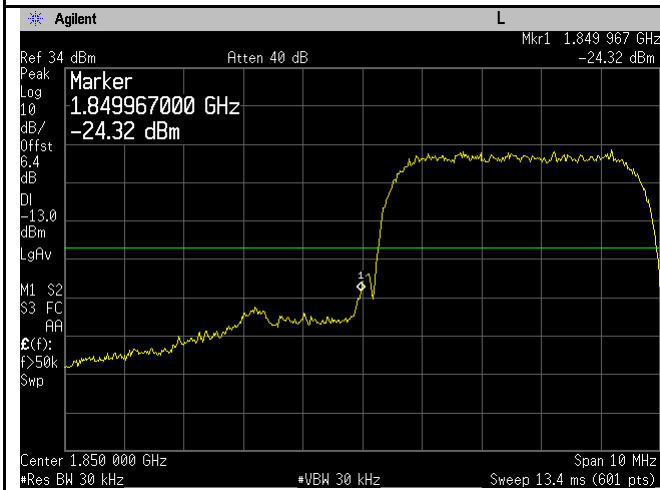

UMTS-FDD Band II - Low Channel

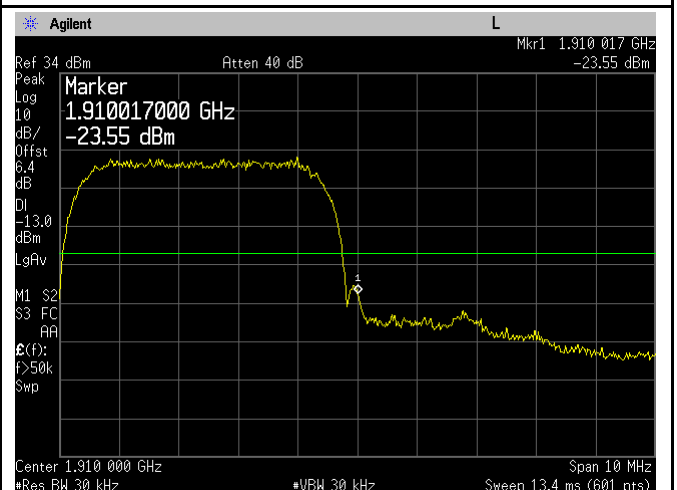

UMTS-FDD Band II - High Channel

Note: Offset=Cable loss (4.5) + 10log
(47.41/30)=4.5+1.9=6.4dB

Note: Offset=Cable loss (4.5) + 10log
(47.35/30)=4.5+1.9=6.4dB

6.8 Frequency Stability

Temperature	23 °C
Relative Humidity	54%
Atmospheric Pressure	1020mbar
Test date :	January 28, 2018
Tested By :	Aaron Liang

Requirement(s):

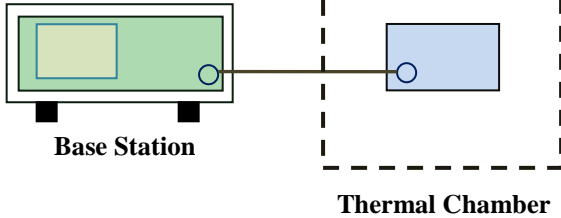
Spec	Item	Requirement	Applicable																																
§2.1055, §22.355 & §24.235	a)	<p>According to §22.355, the carrier frequency of each transmitter in the Public Mobile Services must be maintained within the tolerances given in Table below:</p> <p>Frequency Tolerance for Transmitters in the Public Mobile Services</p> <table border="1"> <thead> <tr> <th>Frequency Range (MHz)</th> <th>Base, fixed (ppm)</th> <th>Mobile ≥ 3 watts (ppm)</th> <th>Mobile ≤ 3 watts (ppm)</th> </tr> </thead> <tbody> <tr> <td>25 to 50</td> <td>20.0</td> <td>20.0</td> <td>50.0</td> </tr> <tr> <td>50 to 450</td> <td>5.0</td> <td>5.0</td> <td>50.0</td> </tr> <tr> <td>450 to 512</td> <td>2.5</td> <td>5.0</td> <td>5.0</td> </tr> <tr> <td>821 to 896</td> <td>1.5</td> <td>2.5</td> <td>2.5</td> </tr> <tr> <td>928 to 929</td> <td>5.0</td> <td>N/A</td> <td>N/A</td> </tr> <tr> <td>929 to 960.</td> <td>1.5</td> <td>N/A</td> <td>N/A</td> </tr> <tr> <td>2110 to 2220</td> <td>10.0</td> <td>N/A</td> <td>N/A</td> </tr> </tbody> </table> <p>According to §24.235, the frequency stability shall be sufficient to ensure that the fundamental emissions stay within the authorized frequency block.</p>	Frequency Range (MHz)	Base, fixed (ppm)	Mobile ≥ 3 watts (ppm)	Mobile ≤ 3 watts (ppm)	25 to 50	20.0	20.0	50.0	50 to 450	5.0	5.0	50.0	450 to 512	2.5	5.0	5.0	821 to 896	1.5	2.5	2.5	928 to 929	5.0	N/A	N/A	929 to 960.	1.5	N/A	N/A	2110 to 2220	10.0	N/A	N/A	<input checked="" type="checkbox"/>
		Frequency Range (MHz)	Base, fixed (ppm)	Mobile ≥ 3 watts (ppm)	Mobile ≤ 3 watts (ppm)																														
25 to 50	20.0	20.0	50.0																																
50 to 450	5.0	5.0	50.0																																
450 to 512	2.5	5.0	5.0																																
821 to 896	1.5	2.5	2.5																																
928 to 929	5.0	N/A	N/A																																
929 to 960.	1.5	N/A	N/A																																
2110 to 2220	10.0	N/A	N/A																																
Test setup		 <p>The diagram shows a Base Station (represented by a green rectangle) connected via a cable to a Thermal Chamber (represented by a blue rectangle inside a dashed box).</p>																																	

Test Report	18070041-FCC-R1
Page	69 of 78

Procedure	<p>A communication link was established between EUT and base station. The frequency error was monitored and measured by base station under variation of ambient temperature and variation of primary supply voltage.</p> <p>Limit: The frequency stability of the transmitter shall be maintained within $\pm 0.00025\%$ ($\pm 2.5\text{ppm}$) of the center frequency.</p>
Remark	
Result	<input checked="" type="checkbox"/> Pass <input type="checkbox"/> Fail

Test Data Yes N/A

Test Plot Yes (See below) N/A

GSM Voice:

Cellular Band (Part 22H) result

Middle Channel, $f_0 = 836.6$ MHz				
Temperature (°C)	Power Supplied (V _{DC})	Frequency Error (Hz)	Frequency Error (ppm)	Limit (ppm)
-10	3.7	20	0.0239	2.5
0		16	0.0191	2.5
10		18	0.0215	2.5
20		13	0.0155	2.5
30		14	0.0167	2.5
40		17	0.0203	2.5
50		20	0.0239	2.5
55		19	0.0227	2.5
25	4.2	20	0.0239	2.5
	3.5	17	0.0203	2.5

PCS Band (Part 24E) result

Middle Channel, $f_0 = 1880$ MHz				
Temperature (°C)	Power Supplied (V _{DC})	Frequency Error (Hz)	Frequency Error (ppm)	Limit (ppm)
-10	3.7	21	0.0112	2.5
0		15	0.0080	2.5
10		18	0.0096	2.5
20		13	0.0069	2.5
30		16	0.0085	2.5
40		16	0.0085	2.5
50		20	0.0106	2.5
55		21	0.0112	2.5
25	4.2	21	0.0112	2.5
	3.5	20	0.0106	2.5

RMC:

UMTS-FDD Band V (Part 22H)

Middle Channel, $f_0 = 835$ MHz				
Temperature (°C)	Power Supplied (V _{DC})	Frequency Error (Hz)	Frequency Error (ppm)	Limit (ppm)
-10	3.7	18	0.0216	2.5
0		18	0.0216	2.5
10		15	0.0180	2.5
20		17	0.0204	2.5
30		14	0.0168	2.5
40		14	0.0168	2.5
50		18	0.0216	2.5
55		18	0.0216	2.5
25	4.2	20	0.0240	2.5
	3.5	19	0.0228	2.5

UMTS-FDD Band II (Part 24E)

Middle Channel, $f_0 = 1880$ MHz				
Temperature (°C)	Power Supplied (V _{DC})	Frequency Error (Hz)	Frequency Error (ppm)	Limit (ppm)
-10	3.7	20	0.0106	2.5
0		18	0.0096	2.5
10		16	0.0085	2.5
20		15	0.0080	2.5
30		14	0.0074	2.5
40		15	0.0080	2.5
50		22	0.0117	2.5
55		17	0.0090	2.5
25	4.2	17	0.0090	2.5
	3.5	17	0.0090	2.5

Annex A. TEST INSTRUMENT

Instrument	Model	Serial #	Cal Date	Cal Due	In use
RF Conducted Test					
Agilent ESA-E SERIES SPECTRUM ANALYZER	E4407B	MY45108319	09/14/2017	09/13/2018	<input checked="" type="checkbox"/>
Power Splitter	1#	1#	08/30/2017	08/29/2018	<input checked="" type="checkbox"/>
Universal Radio Communication Tester	CMU200	121393	09/23/2017	09/22/2018	<input checked="" type="checkbox"/>
Temperature/Humidity Chamber	UHL-270	001	10/07/2017	10/06/2018	<input checked="" type="checkbox"/>
DC Power Supply	E3640A	MY40004013	09/15/2017	09/14/2018	<input checked="" type="checkbox"/>
RF Power Sensor	Dare RPR3006C/P/W	AY554013	09/15/2017	09/14/2018	<input checked="" type="checkbox"/>
Radiated Emissions					
EMI test receiver	ESL6	100262	09/15/2017	09/14/2018	<input checked="" type="checkbox"/>
OPT 010 AMPLIFIER (0.1-1300MHz)	8447E	2727A02430	08/30/2017	08/29/2018	<input checked="" type="checkbox"/>
Microwave Preamplifier (1 ~ 26.5GHz)	8449B	3008A02402	03/23/2017	03/22/2018	<input checked="" type="checkbox"/>
Bilog Antenna (30MHz~6GHz)	JB6	A110712	09/19/2017	09/18/2018	<input checked="" type="checkbox"/>
Bilog Antenna (30MHz~2GHz)	JB1	A112017	09/19/2017	09/18/2018	<input checked="" type="checkbox"/>
Double Ridge Horn Antenna (1 ~18GHz)	AH-118	71259	09/22/2017	09/21/2018	<input checked="" type="checkbox"/>
Double Ridge Horn Antenna (1 ~18GHz)	AH-118	71283	09/22/2017	09/21/2018	<input checked="" type="checkbox"/>
SYNTHESIZED SIGNAL GENERATOR	8665B	3744A01293	09/15/2017	09/14/2018	<input checked="" type="checkbox"/>
Power Amplifier	SMC150D	R1553-0313	03/08/2017	03/07/2018	<input checked="" type="checkbox"/>
Power Amplifier	S41-25D	R1553-0314	05/26/2017	05/25/2018	<input checked="" type="checkbox"/>
Tunable Notch Filter	3NF-800/1000-S	AA4	08/30/2017	08/29/2018	<input checked="" type="checkbox"/>



Test Report	18070041-FCC-R1
Page	73 of 78

Tunable Notch Filter	3NF- 1000/2000-S	AM 4	08/30/2017	08/29/2018	<input checked="" type="checkbox"/>
----------------------	---------------------	------	------------	------------	-------------------------------------

Annex C. TEST SETUP AND SUPPORTING EQUIPMENT

Annex C.ii. TEST SET UP BLOCK

Block Configuration Diagram for Radiated Emissions

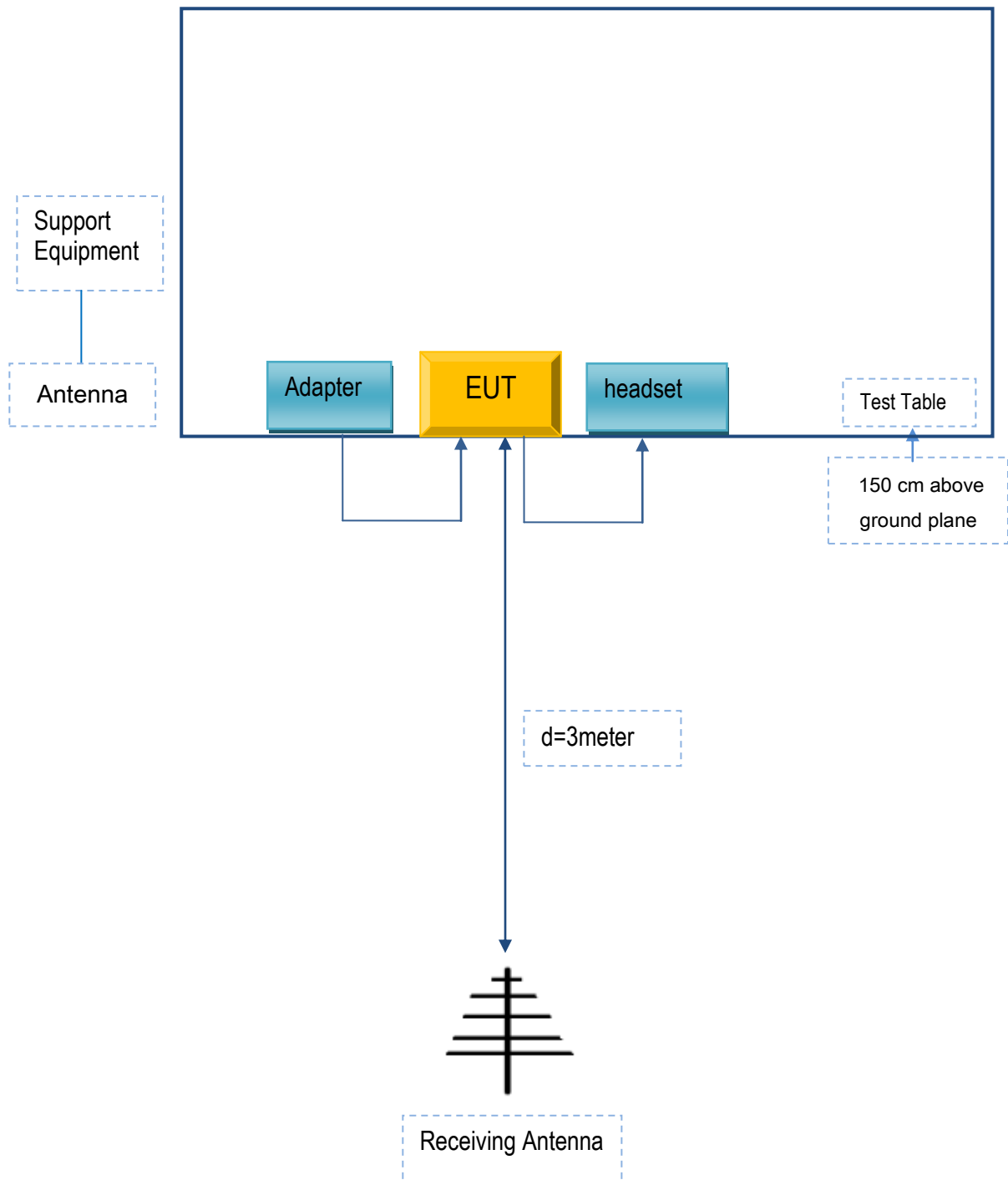

Annex C. ii. SUPPORTING EQUIPMENT DESCRIPTION

The following is a description of supporting equipment and details of cables used with the EUT.

Supporting Equipment:

Manufacturer	Equipment Description	Model	Serial No
TECNO MOBILE LIMITED	Adapter	A31-500500	N/A
SAMSUNG	headset	HS330	N/A
Agilent	Wireless Connectivity Test Set	N4010A	N/A
OEM	omnidirectional antenna	AntSuck	N/A

Supporting Cable:

Cable type	Shield Type	Ferrite Core	Length	Serial No
USB Cable	Un-shielding	No	0.8m	N/A

Test Report	18070041-FCC-R1
Page	76 of 78

Annex C.ii. EUT OPERATING CONKITIONS

N/A

Test Report	18070041-FCC-R1
Page	77 of 78

Annex D. User Manual / Block Diagram / Schematics / Partlist

Please see the attachment

Test Report	18070041-FCC-R1
Page	78 of 78

Annex E. DECLARATION OF SIMILARITY

N/A