

FCC Report

Application Purpose : Original grant
Applicant Name: : TECNO MOBILE LIMITED
FCC ID : 2ADYY-T525
Equipment Type : Mobile Phone
Model Name : T525
Report Number : FCC 15080287-1
Standard(S) : FCC Part 15 Subpart B
Date Of Receipt : August 20,2015
Date Of Issue : August 30,2015

Test By : *Fall Ma*
(Fall Ma)

Reviewed By : *Robie Chen*
(Robie Chen)

Authorized by : *Michal Ling*
(Michal Ling)

Prepared by : **Shenzhen WST Testing Technology Co., Ltd.**
1F,No.9 Building,TGK Science & Technology ParkYangtian
Rd., NO.72 Bao'an Dist., Guangdong, China
(Registration Number: 939433)

REPORT REVISE RECORD

Report Version	Revise Time	Issued Date	Valid Version	Notes
V1.0	/	August 30,2015	Valid	Original Report

Table of Contents	Page
1. GENERAL INFORMATION	4
2. TEST DESCRIPTION	6
2.1 MEASUREMENT UNCERTAINTY	6
2.2 DESCRIPTION OF TEST MODES	7
2.3 CONFIGURATION OF SYSTEM UNDER TEST	8
2.4 DESCRIPTION OF SUPPORT UNITS (CONDUCTED MODE)	8
3. SUMMARY OF TEST RESULTS	9
4. MEASUREMENT INSTRUMENTS	10
5. EMC EMISSION TEST	11
5.1 CONDUCTED EMISSION MEASUREMENT	11
5.1.1 POWER LINE CONDUCTED EMISSION LIMITS	11
5.1.2 TEST PROCEDURE	12
5.1.3 DEVIATION FROM TEST STANDARD	12
5.1.4 TEST SETUP	12
5.1.5 EUT OPERATING CONDITIONS	12
5.1.6 TEST RESULTS	13
5.2 RADIATED EMISSION MEASUREMENT	15
5.2.1 RADIATED EMISSION LIMITS	15
5.2.2 TEST PROCEDURE	16
5.2.3 DEVIATION FROM TEST STANDARD	16
5.2.4 TEST SETUP	17
5.2.5 EUT OPERATING CONDITIONS	17
5.2.5.1 TEST RESULTS (BETWEEN 30M – 1000 MHZ)	18
5.2.5.2 TEST RESULTS(1GHZ TO 6GHZ)	20
12. EUT TEST PHOTO	21
13. PHOTOGRAPHS OF EUT	23

1. GENERAL INFORMATION

Test Model	T525
Applicant	TECNO MOBILE LIMITED
Address	ROOMS 05-15, 13A/F., SOUTH TOWER, WORLD FINANCE CENTRE, HARBOUR CITY, 17 CANTON ROAD, TSIM SHA TSUI, KOWLOON, HONG KONG
Manufacturer	SHENZHEN SMARTTEL CO., LTD
Address	6th Floor, Block 15, shatoujia Free TRADE Zone, Shenyang Road, Yantian District, Shenzhen, Guangdong, P. R. China
Equipment Type	Mobile Phone
Brand Name	TECNO
Hardware	SAGETEL61A-11C-HW
Software	DL72-T525-20141109-T0
Battery information:	Li-ion Battery: BL-5CAT Batterie: 4.255Wh Voltage: 3.7V Capacity: 1150mAh Limited Charge Voltage: 4.2V
Adapter Information:	Adapter : A31-500500 Input: AC 100-240V 50/60Hz 0.2A Output: DC 5V 500mA
Data of receipt	August 20,2015
Date of test	August 20,2015 to August 30,2015
Deviation	None
Condition of Test Sample	Normal

We hereby certify that:

All measurement facilities used to collect the measurement data are located at 1F, No.9 Building, TGK Science & Technology Park Yangtian Rd., NO.72 Bao'an Dist., Guangdong, China. The data evaluation, test procedures, and equipment configurations shown in this report were made in accordance with the procedures given in ANSI C 63.4:2009. The sample tested as described in this report is in compliance with the FCC Rules Part 15 Subpart B. The test results of this report relate only to the tested sample identified in this report.

2. TEST DESCRIPTION

2.1 MEASUREMENT UNCERTAINTY

The reported uncertainty of measurement $y \pm U$, where expanded uncertainty U is based on a standard uncertainty multiplied by a coverage factor of $k=2$, providing a level of confidence of approximately **95** %.

No.	Item	Uncertainty
1	Conducted Emission Test	$\pm 3.2\text{dB}$
2	RF power, conducted	$\pm 0.16\text{dB}$
3	Spurious emissions, conducted	$\pm 0.21\text{dB}$
4	All emissions, radiated(<1G)	$\pm 4.7\text{dB}$
5	All emissions, radiated(>1G)	$\pm 4.7\text{dB}$
6	Temperature	$\pm 0.5^\circ\text{C}$
7	Humidity	$\pm 2\%$

2.2 DESCRIPTION OF TEST MODES

To investigate the maximum EMI emission characteristics generated from EUT, the test system was pre-scanning tested based on the consideration of following EUT operation mode or test configuration mode which possibly have effect on EMI emission level. Each of these EUT operation mode(s) or test configuration mode(s) mentioned above was evaluated respectively.

Pretest Mode	Description
Mode 1	Exchange data

For Conducted Emission	
Final Test Mode	Description
Mode 1	Exchange data

For Radiated Emission	
Final Test Mode	Description
Mode 1	Exchange data

2.3 CONFIGURATION OF SYSTEM UNDER TEST

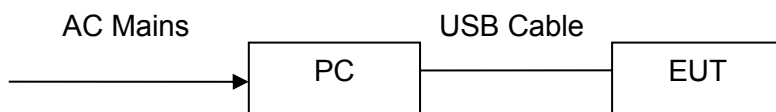

(EUT: Mobile Phone)

I/O Port of EUT			
I/O Port Type	Q'TY	Cable	Tested with
USB port	1	1m USB cable, unshielded	1

2.4 DESCRIPTION OF SUPPORT UNITS (CONDUCTED MODE)

The EUT has been tested as an independent unit together with other necessary accessories or support units. The following support units or accessories were used to form a representative test configuration during the tests.

Item	Equipment	Mfr/Brand	Model/Type No.	Series No.	Note
1	PC	HP	Dx2700	CNG7140T7P	/
2	Keyboard	HP	SK-2880	435302-AA-	/
3	Mouse	DELL	MS111-1	/	/
4	Monitor	HP	HSTND-2F02	CND7160R3Z	/

Note:

- (1) The support equipment was authorized by Declaration of Confirmation.
- (2) For detachable type I/O cable should be specified the length in cm in 『Length』 column.

3. SUMMARY OF TEST RESULTS

Test procedures according to the technical standards:

FCC Part15 , Subpart B			
Standard Section	Test Item	Judgment	Remark
15.107	CONDUCTED EMISSION	PASS	
15.109	RADIATED EMISSION	PASS	

NOTE:

(1) "N/A" denotes test is not applicable in this test report.

4. MEASUREMENT INSTRUMENTS

Kind of Equipment	Manufacturer	Type No.	Serial No.	Last Calibrated	Calibrated until
ESPI Test Receiver	R&S	ESPI	100379	08/19/2015	08/18/2016
ESCI Test Receiver	R&S	ESCI	100005	08/19/2015	08/18/2016
LISN	AFJ	LS16	16010222119	08/19/2015	08/18/2016
LISN(EUT)	Mestec	AN3016	04/10040	08/19/2015	08/18/2016
pre-amplifier	CDSI	PAP-1G18-38	--	08/19/2015	08/18/2016
System Controller	CT	SC100	-	08/19/2015	08/18/2016
Bi-log Antenna	Chase	CBL6111C	2576	08/19/2015	08/18/2016
Spectrum analyzer	R&S	FSU26	200409	08/19/2015	08/18/2016
Horn Antenna	SCHWARZBECK	9120D	1141	08/19/2015	08/18/2016
Bi-log Antenna	Schwarebeck	VULB9163	9163/340	08/19/2015	08/18/2016
Pre Amplifier	H.P.	HP8447E	2945A02715	10/13/2014	10/12/2015
9*6*6 Anechoic	--	--	--	08/21/2015	08/20/2016

5. EMC EMISSION TEST

5.1 CONDUCTED EMISSION MEASUREMENT

5.1.1 POWER LINE CONDUCTED EMISSION Limits (Frequency Range 150KHz-30MHz)

FREQUENCY (MHz)	Class A (dBuV)		Class B (dBuV)		Standard
	Quasi-peak	Average	Quasi-peak	Average	
0.15 -0.5	79.00	66.00	66 - 56 *	56 - 46 *	FCC
0.50 -5.0	73.00	60.00	56.00	46.00	FCC
5.0 -30.0	73.00	60.00	60.00	50.00	FCC

Note:

- (1) The tighter limit applies at the band edges.
- (2) The limit of " * " marked band means the limitation decreases linearly with the logarithm of the frequency in the range.

The following table is the setting of the receiver

Receiver Parameters	Setting
Attenuation	10 dB
Start Frequency	0.15 MHz
Stop Frequency	30 MHz
IF Bandwidth	9 kHz

5.1.2 TEST PROCEDURE

- The EUT was placed 0.4 meters from the horizontal ground plane with EUT being connected to the power mains through a line impedance stabilization network (LISN). All other support equipments powered from additional LISN(s). The LISN provide 50 Ohm/ 50uH of coupling impedance for the measuring instrument.
- Interconnecting cables that hang closer than 40 cm to the ground plane shall be folded back and forth in the center forming a bundle 30 to 40 cm long.
- I/O cables that are not connected to a peripheral shall be bundled in the center. The end of the cable may be terminated, if required, using the correct terminating impedance. The overall length shall not exceed 1 m.
- LISN at least 80 cm from nearest part of EUT chassis.
- For the actual test configuration, please refer to the related Item –EUT Test Photos.

5.1.3 DEVIATION FROM TEST STANDARD

No deviation

5.1.4 TEST SETUP

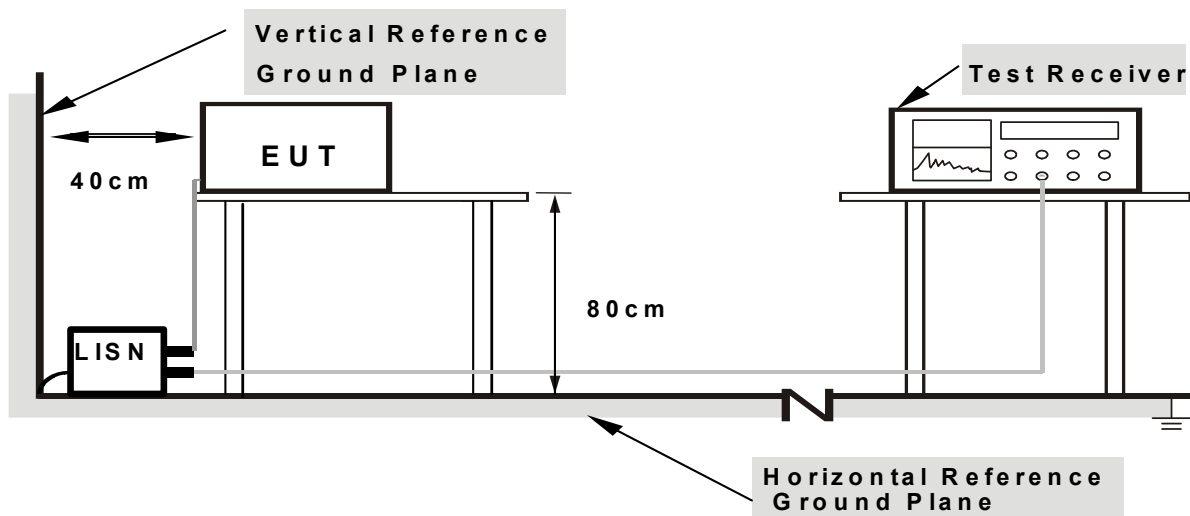

- Note:**
- Support units were connected to second LISN.
 - Both of LISNs (AMN) are 80 cm from EUT and at least 80 from other units and other metal planes

5.1.5 EUT OPERATING CONDITIONS

The EUT was configured for testing in a typical fashion (as a customer would normally use it). The EUT has been programmed to continuously transmit during test. This operating condition was tested and used to collect the included data.

5.1.6 TEST RESULTS

EUT	Mobile Phone	Model Name	T525
Temperature	26 °C	Relative Humidity	54%
Pressure	1010hPa	Phase	L
Test Date	August 24,2015	Test Mode	Mode 1

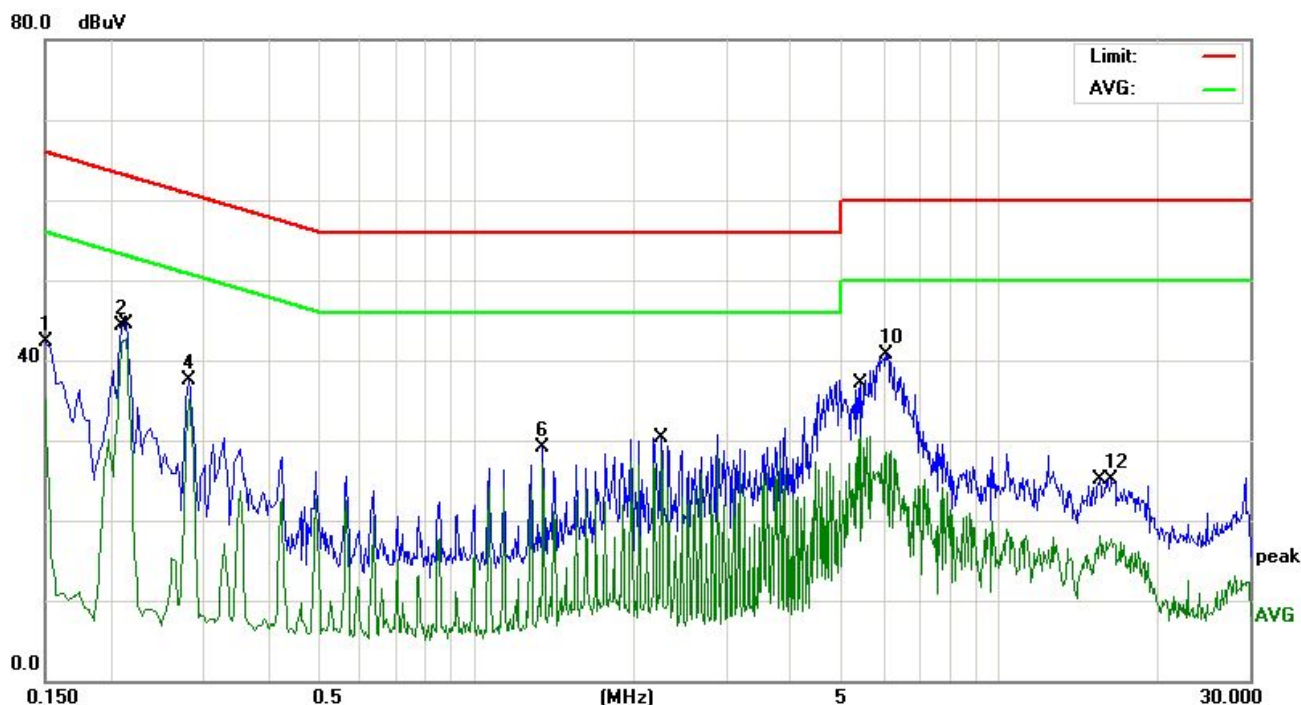

No.	Mk.	Freq. MHz	Reading Level dBuV	Correct Factor dB	Measure- ment dBuV	Limit dBuV	Over dB	Detector
1		0.1500	31.95	10.45	42.40	65.99	-23.59	peak
2		0.2100	34.01	10.34	44.35	63.20	-18.85	peak
3	*	0.2140	32.25	10.35	42.60	53.04	-10.44	AVG
4		0.2819	26.97	10.59	37.56	60.76	-23.20	peak
5		0.2819	24.53	10.59	35.12	50.76	-15.64	AVG
6		1.3420	18.41	10.74	29.15	56.00	-26.85	peak
7		1.3420	16.35	10.74	27.09	46.00	-18.91	AVG
8		2.2580	17.71	10.70	28.41	46.00	-17.59	AVG
9		5.4340	19.96	10.58	30.54	50.00	-19.46	AVG
10		6.0700	30.12	10.56	40.68	60.00	-19.32	peak
11		15.5220	7.70	10.46	18.16	50.00	-31.84	AVG
12		16.3700	14.71	10.46	25.17	60.00	-34.83	peak

EUT	Mobile Phone	Model Name	T525
Temperature	26 °C	Relative Humidity	54%
Pressure	1010hPa	Phase	N
Test Date	August 24,2015	Test Mode	Mode 1

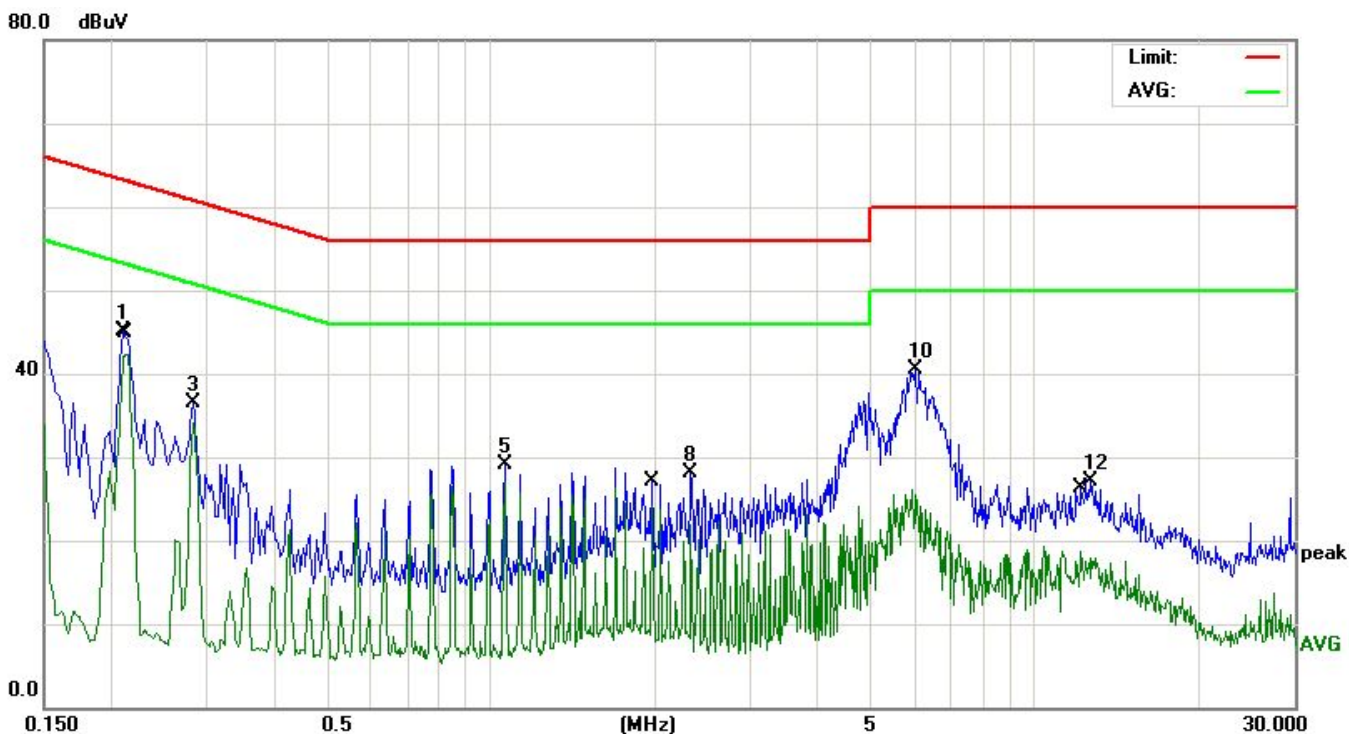

No.	Mk.	Freq. MHz	Reading Level dBuV	Correct Factor dB	Measure- ment dBuV	Limit dBuV	Over dB	Detector
1		0.2100	34.79	10.34	45.13	63.20	-18.07	peak
2	*	0.2140	31.91	10.35	42.26	53.04	-10.78	AVG
3		0.2819	25.97	10.59	36.56	60.76	-24.20	peak
4		0.2819	23.53	10.59	34.12	50.76	-16.64	AVG
5		1.0580	18.36	10.75	29.11	56.00	-26.89	peak
6		1.0580	16.17	10.75	26.92	46.00	-19.08	AVG
7		1.9740	13.30	10.71	24.01	46.00	-21.99	AVG
8		2.3300	17.43	10.70	28.13	56.00	-27.87	peak
9		5.9500	15.46	10.56	26.02	50.00	-23.98	AVG
10		6.0460	29.99	10.56	40.55	60.00	-19.45	peak
11		12.1340	8.38	10.42	18.80	50.00	-31.20	AVG
12		12.6300	16.62	10.43	27.05	60.00	-32.95	peak

5.2 RADIATED EMISSION MEASUREMENT

5.2.1 RADIATED EMISSION LIMITS (Frequency Range 9kHz-1000MHz)

20dBc in any 100 kHz bandwidth outside the operating frequency band. In case the emission fall within the restricted band specified on 15.205(a), then the 15.209(a) limit in the table below has to be followed.

Frequencies (MHz)	Field Strength (micorvolts/meter)	Measurement Distance (meters)
0.009~0.490	2400/F(KHz)	300
0.490~1.705	24000/F(KHz)	30
1.705~30.0	30	30
30~88	100	3
88~216	150	3
216~960	200	3
Above 960	500	3

LIMITS OF RADIATED EMISSION MEASUREMENT (Above 1000MHz)

FREQUENCY (MHz)	Limit (dBuV/m) (at 3M)	
	PEAK	AVERAGE
Above 1000	74	54

Notes:

- (1) The limit for radiated test was performed according to FCC PART 15C.
- (2) The tighter limit applies at the band edges.
- (3) Emission level (dBuV/m)=20log Emission level (uV/m).

Spectrum Parameter	Setting
Attenuation	Auto
Start Frequency	1000 MHz
Stop Frequency	10th carrier harmonic
RB / VB (emission in restricted band)	1 MHz / 1 MHz for Peak, 1 MHz / 10Hz for Average

Receiver Parameter	Setting
Attenuation	Auto
Start ~ Stop Frequency	9kHz~150kHz / RB 200Hz for QP
Start ~ Stop Frequency	150kHz~30MHz / RB 9kHz for QP
Start ~ Stop Frequency	30MHz~1000MHz / RB 120kHz for QP

5.2.2 TEST PROCEDURE

- a. The measuring distance of at 3 m shall be used for measurements at frequency up to 1GHz. For frequencies above 1GHz, any suitable measuring distance may be used.
- b. The EUT was placed on the top of a rotating table 0.8 meters above the ground at a 3 meter open area test site. The table was rotated 360 degrees to determine the position of the highest radiation.
- c. The height of the equipment or of the substitution antenna shall be 0.8 m; the height of the test antenna shall vary between 1 m to 4 m. Both horizontal and vertical polarizations of the antenna are set to make the measurement.
- d. The initial step in collecting conducted emission data is a spectrum analyzer peak detector mode pre-scanning the measurement frequency range. Significant peaks are then marked and then Quasi Peak detector mode re-measured.
- e. If the Peak Mode measured value compliance with and lower than Quasi Peak Mode Limit, the EUT shall be deemed to meet QP Limits and then no additional QP Mode measurement performed.
- f. For the actual test configuration, please refer to the related Item –EUT Test Photos.

Note:

Both horizontal and vertical antenna polarities were tested and performed pretest to three orthogonal axis. The worst case emissions were reported

5.2.3 DEVIATION FROM TEST STANDARD

No deviation

5.2.4 TEST SETUP

(A) Radiated Emission Test-Up Frequency 30MHz~1GHz

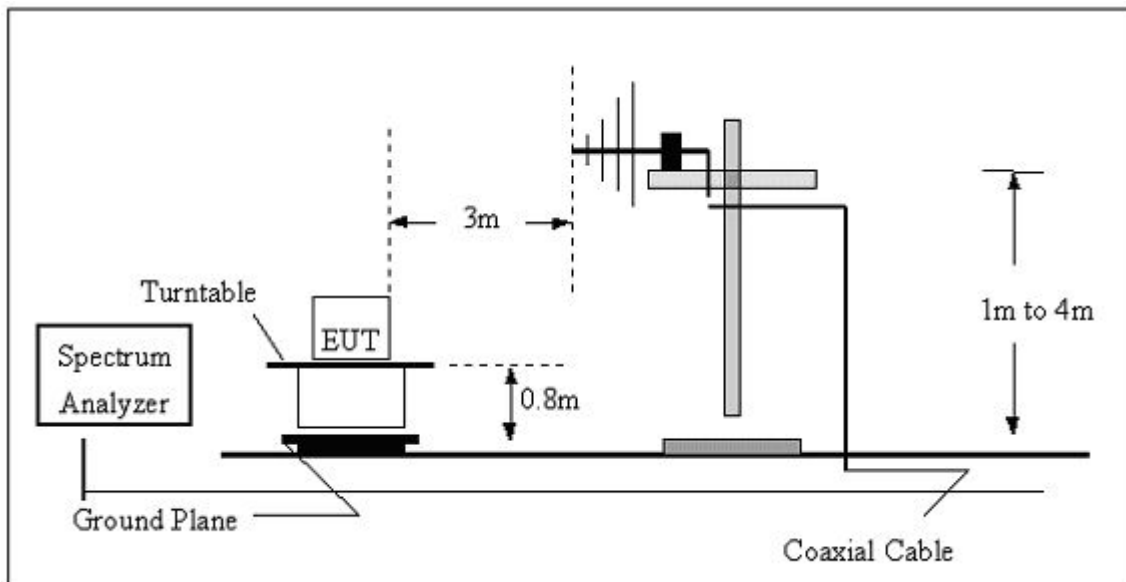

(B) Radiated Emission Test-Up Frequency Above 1GHz

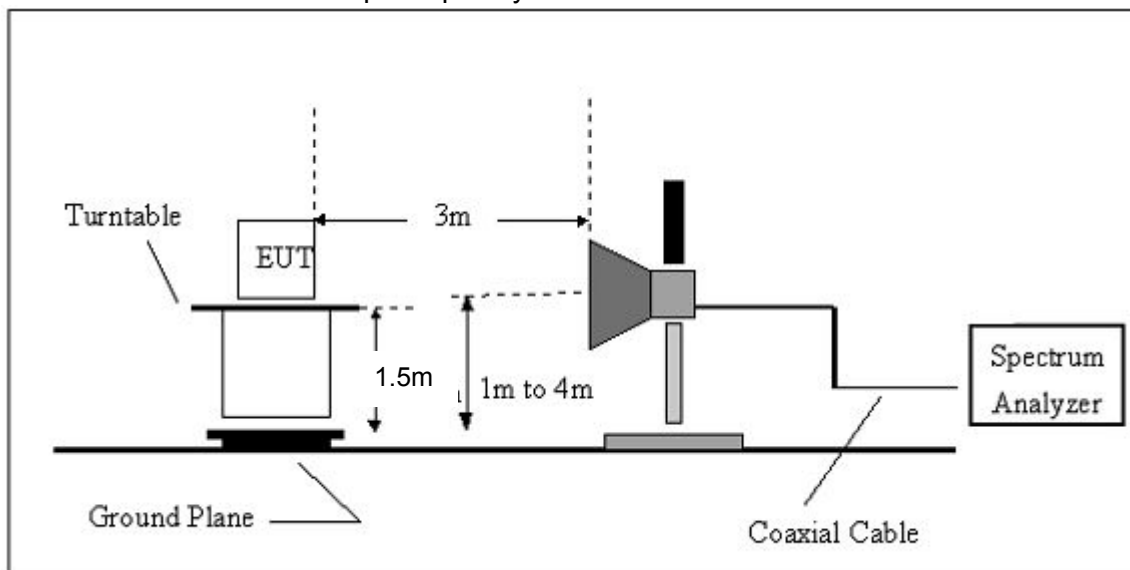

5.2.5 EUT OPERATING CONDITIONS

The EUT tested system was configured as the statements of 2.4 Unless otherwise a special operating condition is specified in the follows during the testing.

5.2.5.1 TEST RESULTS (BETWEEN 30M – 1000 MHZ)

EUT	Mobile Phone	Model Name	T525
Temperature	20 °C	Relative Humidity	48%
Pressure	1010 hPa	Polarization :	Horizontal
Test Mode	Mode 1	Test Date	August 24,2015

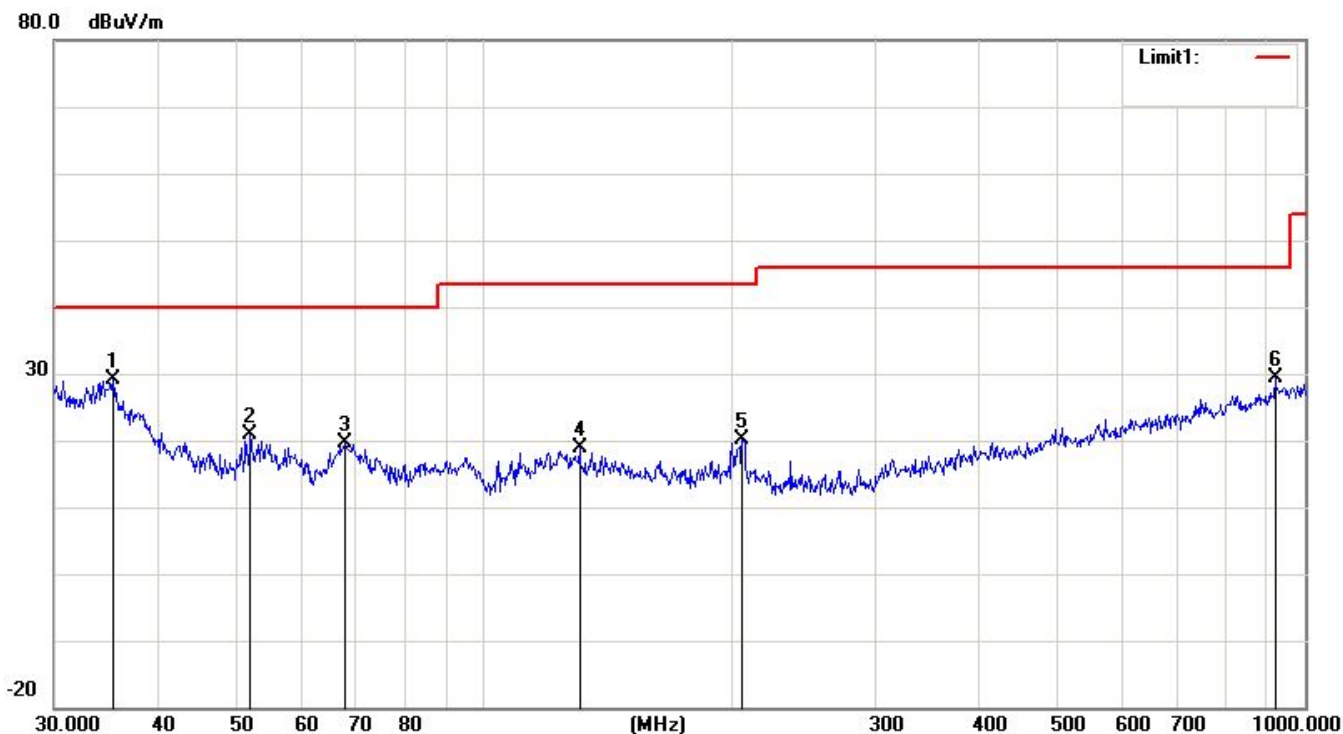

No.	Mk.	Freq.	Reading Level	Correct Factor	Measurement	Limit	Over	Detector
		MHz	dBuV	dB	dBuV/m	dBuV/m	dB	
1	*	35.3750	29.38	-0.14	29.24	40.00	-10.76	peak
2		52.0251	30.05	-9.21	20.84	40.00	-19.16	peak
3		67.6751	27.83	-8.27	19.56	40.00	-20.44	peak
4		130.8369	21.10	-2.33	18.77	43.50	-24.73	peak
5		206.3976	25.09	-5.05	20.04	43.50	-23.46	peak
6		919.2866	22.70	6.62	29.32	46.00	-16.68	peak

EUT	Mobile Phone	Model Name	T525
Temperature	20 °C	Relative Humidity	48%
Pressure	1010 hPa	Polarization :	Vertical
Test Mode	Mode 1	Test Date	August 24,2015

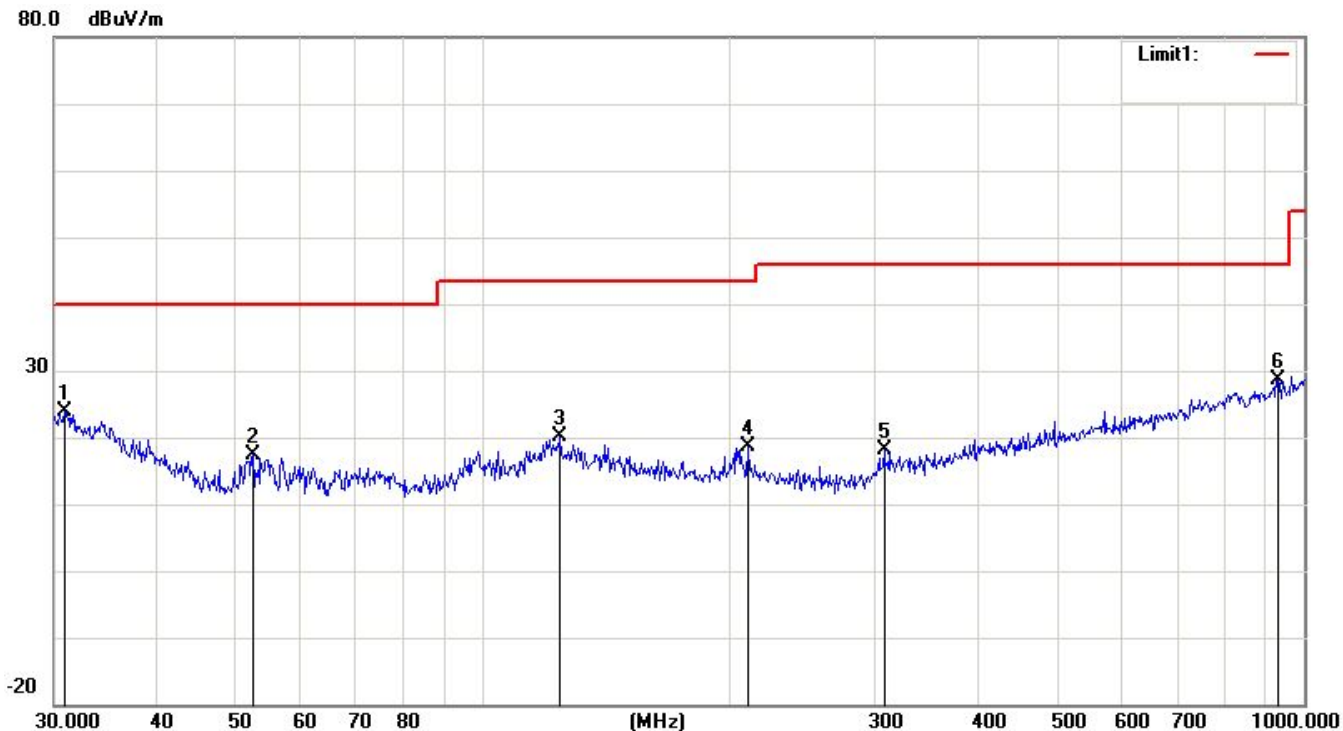

No.	Mk.	Freq. MHz	Reading Level dBuV	Correct Factor dB	Measure- ment dBuV/m	Limit dBuV/m	Over dB	Detector
1	*	30.8535	21.00	2.92	23.92	40.00	-16.08	peak
2		52.3912	26.70	-9.25	17.45	40.00	-22.55	peak
3		124.1330	22.39	-2.16	20.23	43.50	-23.27	peak
4		210.0482	23.84	-5.18	18.66	43.50	-24.84	peak
5		307.8313	22.86	-4.62	18.24	46.00	-27.76	peak
6		929.0082	21.67	6.87	28.54	46.00	-17.46	peak

5.2.5.2 TEST RESULTS(1GHZ TO 6GHZ)

EUT	Mobile Phone	Model Name	T525
Temperature	20 °C	Relative Humidity	48%
Pressure	1010 hPa	Test Mode	Mode 1
Test Date	August 24, 2015		

Freq. (MHz)	Ant. Pol.	Emission Level(dBuV)		Limit 3m(dBuV/m)		Over(dB)	
		PK	AV	PK	AV	PK	AV
1668.48	V	59.18	39.96	74	54	-14.82	-14.04
3005.23	V	59.52	39.67	74	54	-14.48	-14.33
1680.35	H	59.20	40.99	74	54	-14.80	-13.01
3013.48	H	58.44	39.44	74	54	-15.56	-14.56

Remark:

All emissions not reported were more than 20dB below the specified limit or in the noise floor.

Factor = Antenna Factor + Cable Loss – Pre-amplifier.

All the x/y/z orientation has been investigated, and only worst case is presented in this report.

6. EUT TEST PHOTO

CONDUCTED EMISSION TEST



RADIATED EMISSION TEST

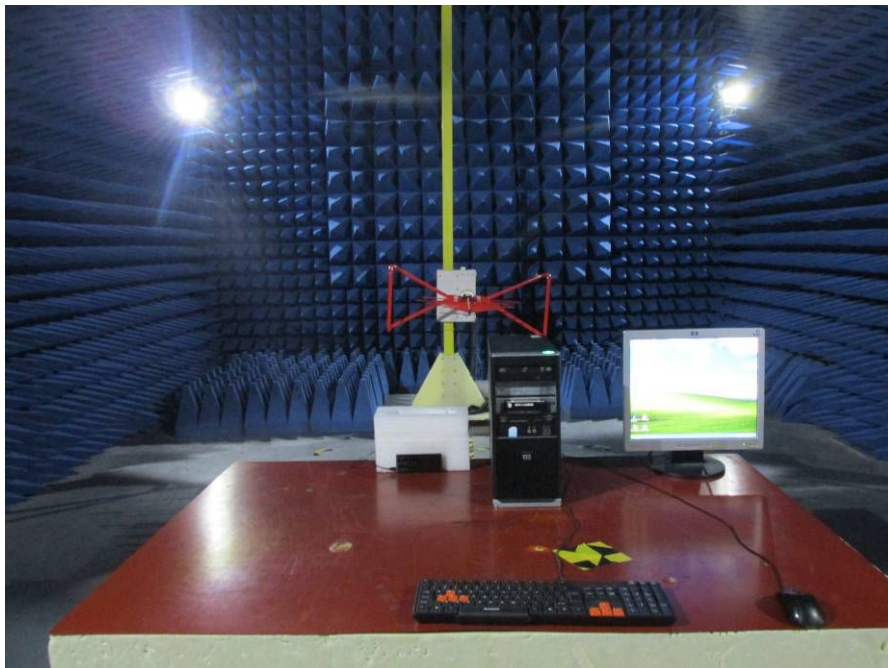

RADIATED EMISSION TEST

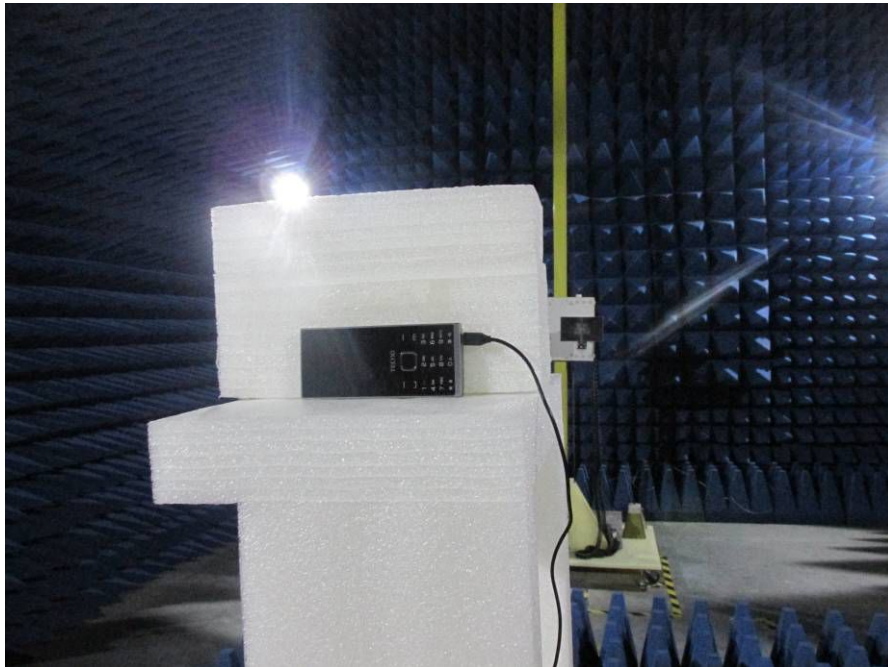

7. PHOTOGRAPHS OF EUT

Appearance photograph of EUT



Appearance photograph of EUT



Appearance photograph of EUT



Appearance photograph of EUT



Appearance photograph of EUT



Appearance photograph of EUT



Appearance photograph of EUT



Internal photograph of EUT



Internal photograph of EUT



Internal photograph of EUT



Internal photograph of EUT

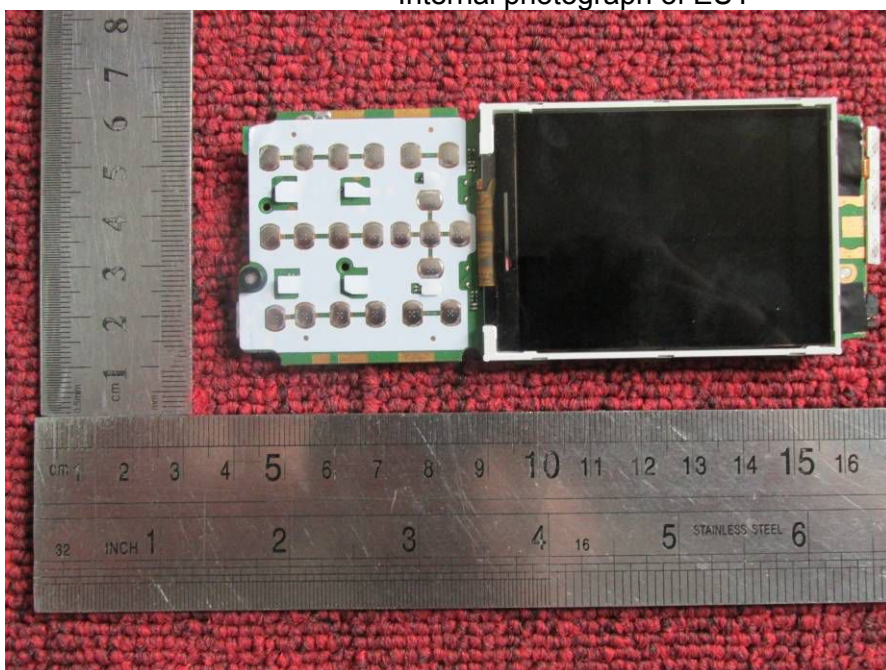

Internal photograph of EUT

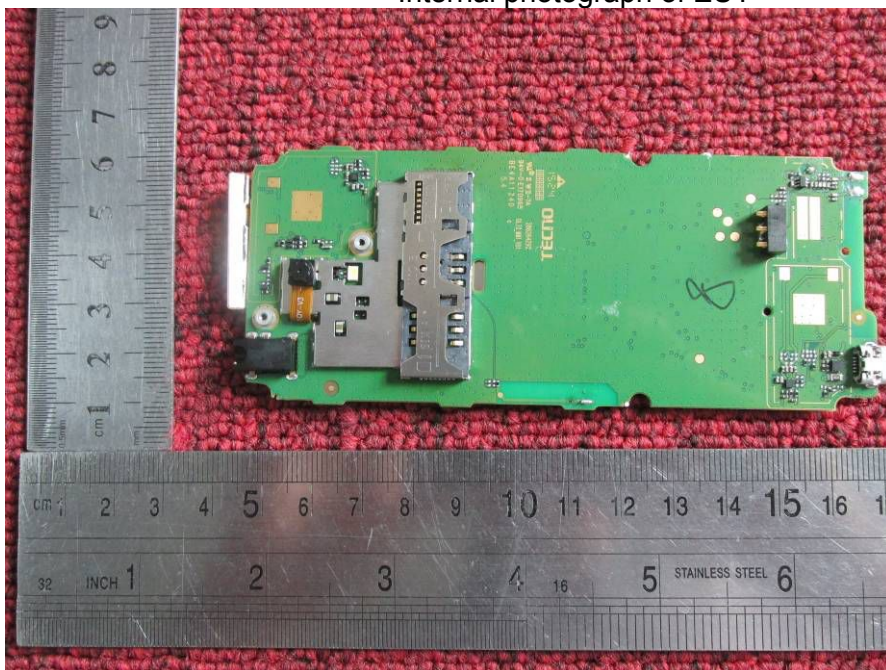

Internal photograph of EUT

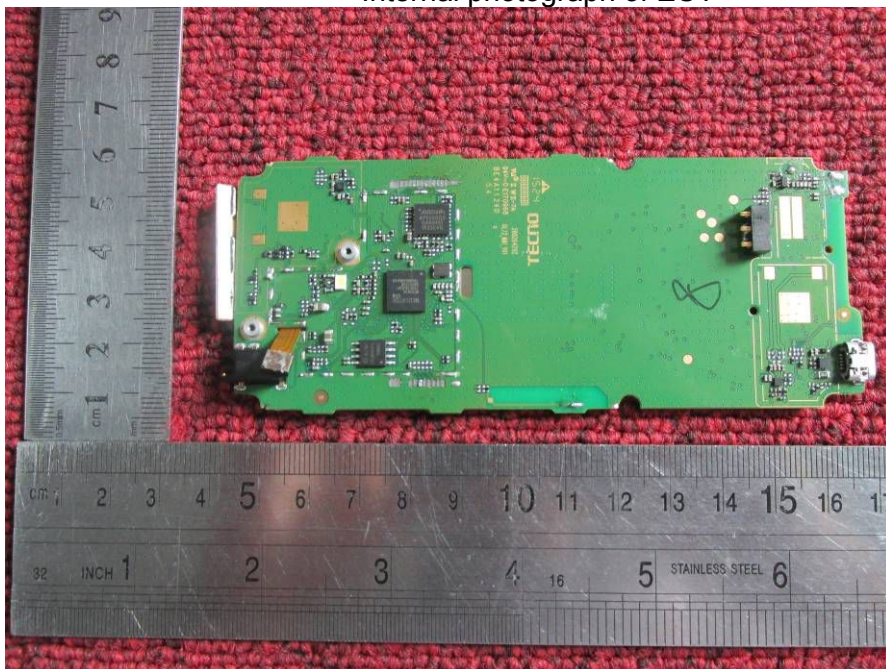

Internal photograph of EUT

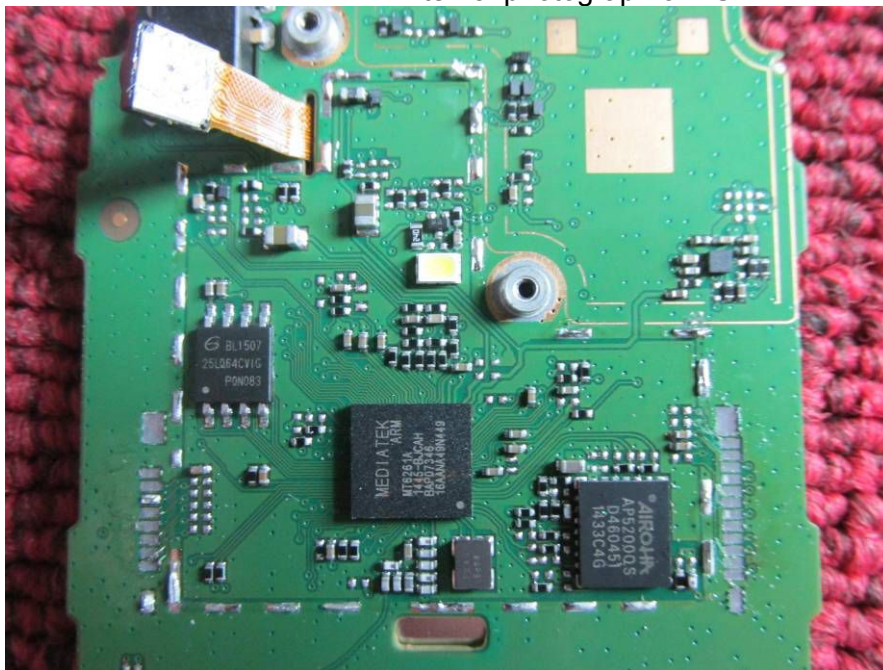

Appearance photograph of adapter



—END OF REPORT—