

# FCC Report

**Application Purpose** : Original grant  
**Applicant Name:** : TECNO MOBILE LIMITED  
**FCC ID** : 2ADYY- T472  
**Equipment Type** : Mobile Phone  
**Model Name** : T472  
**Report Number** : FCC-16073812-2  
**Standard(S)** : FCC Part 15 Subpart B  
**Date Of Receipt** : July 14, 2016  
**Date Of Issue** : August 04, 2016

**Test By** : *Fall Ma*

\_\_\_\_\_  
(Daisy Qin)

**Reviewed By** : *Sol Qin*

\_\_\_\_\_  
(Sol Qin)

**Authorized by** : *Michal Ling*

\_\_\_\_\_  
(Michal Ling)

**Prepared by** :

**QTC Certification & Testing Co., Ltd.**

2nd Floor, Bl Building, Fengyeyuan Industrial Plant,, Liuxian  
2st. Road, Xin'an Street, Bao'an District,, Shenzhen, 518000  
(Registration Number: 588523)

**REPORT REVISE RECORD**

<b>Report Version</b>	<b>Revise Time</b>	<b>Issued Date</b>	<b>Valid Version</b>	<b>Notes</b>
V1.0	/	August 04, 2016	Valid	Original Report
V1.1	August 19, 2016	August 04, 2016	Valid	Original Report

<b>Table of Contents</b>	<b>Page</b>
<b>1. GENERAL INFORMATION</b>	<b>4</b>
<b>2. TEST DESCRIPTION</b>	<b>6</b>
2.1 MEASUREMENT UNCERTAINTY	6
2.2 DESCRIPTION OF TEST MODES	7
2.3 CONFIGURATION OF SYSTEM UNDER TEST	8
2.4 DESCRIPTION OF SUPPORT UNITS (CONDUCTED MODE)	8
<b>3. SUMMARY OF TEST RESULTS</b>	<b>9</b>
<b>4. MEASUREMENT INSTRUMENTS</b>	<b>10</b>
<b>5. EMC EMISSION TEST</b>	<b>11</b>
5.1 CONDUCTED EMISSION MEASUREMENT	11
5.1.1 POWER LINE CONDUCTED EMISSION LIMITS	11
5.1.2 TEST PROCEDURE	12
5.1.3 DEVIATION FROM TEST STANDARD	12
5.1.4 TEST SETUP	12
5.1.5 EUT OPERATING CONDITIONS	12
5.1.6 TEST RESULTS	13
5.2 RADIATED EMISSION MEASUREMENT	15
5.2.1 RADIATED EMISSION LIMITS	15
5.2.2 TEST PROCEDURE	15
5.2.3 DEVIATION FROM TEST STANDARD	16
5.2.4 TEST SETUP	17
5.2.5 EUT OPERATING CONDITIONS	17
5.2.5.1 TEST RESULTS (BETWEEN 30M – 1000 MHZ)	18
5.2.5.2 TEST RESULTS(1GHZ TO 6GHZ)	20
<b>12. EUT TEST PHOTO</b>	<b>21</b>
<b>13. PHOTOGRAPHS OF EUT</b>	<b>23</b>

**1. GENERAL INFORMATION**

Test Model	T472
Applicant	TECNO MOBILE LIMITED
Address	ROOMS 05-15, 13A/F., SOUTH TOWER, WORLD FINANCE CENTRE, HARBOUR CITY, 17 CANTON ROAD, TSIM SHA TSUI, KOWLOON, HONG KONG
Manufacturer	SHENZHEN TECNO TECHNOLOGY CO.,LTD.
Address	1-4th Floor,3rd Building,Pacific Industrial Park,No.2088,Shenyan Road,Yantian District,Shenzhen,Guangdong,China
Equipment Type	Mobile Phone
Brand Name	<b>TECNO</b>
Hardware	T472-UL280-ALL-20160629-T
Software	V00
Battery information:	Li-ion Battery: BL-19CT Batterie :7.03Wh/6.84Wh Voltage: 3.7V Capacity: 1900mAh/1850mAh Limited Charge Voltage: 4.2V
Adapter Information:	Adapter : A31-500500 Input: AC 100-240V 50/60Hz 0.2A Output: DC 5V 500mA
Data of receipt	July 14, 2016
Date of test	July 14, 2016 to July 24, 2016
Deviation	None
Condition of Test Sample	Normal

**We hereby certify that:**

All measurement facilities used to collect the measurement data are located at  
2nd Floor,BI Building,Fengyeyuan Industrial Plant,, Liuxian 2st. Road, Xin'an Street, Bao'an  
District,,Shenzhen,518000

The data evaluation, test procedures, and equipment configurations shown in this report were made in  
accordance with the procedures given in ANSI C 63.4:2014. The sample tested as described in this report  
is in compliance with the FCC Rules Part15 Subpart B.

The test results of this report relate only to the tested sample identified in this report.

## 2. TEST DESCRIPTION

### 2.1 MEASUREMENT UNCERTAINTY

The reported uncertainty of measurement  $y \pm U$ , where expanded uncertainty  $U$  is based on a standard uncertainty multiplied by a coverage factor of  $k=2$ , providing a level of confidence of approximately **95 %**.

No.	Item	Uncertainty
1	Conducted Emission Test	$\pm 3.2\text{dB}$
2	RF power, conducted	$\pm 0.16\text{dB}$
3	Spurious emissions, conducted	$\pm 0.21\text{dB}$
4	All emissions, radiated(<1G)	$\pm 4.7\text{dB}$
5	All emissions, radiated(>1G)	$\pm 4.7\text{dB}$
6	Temperature	$\pm 0.5^\circ\text{C}$
7	Humidity	$\pm 2\%$

## 2.2 DESCRIPTION OF TEST MODES

To investigate the maximum EMI emission characteristics generates from EUT, the test system was pre-scanning tested base on the consideration of following EUT operation mode or test configuration mode which possible have effect on EMI emission level. Each of these EUT operation mode(s) or test configuration mode(s) mentioned above was evaluated respectively.

Pretest Mode	Description
Mode 1	Test with Keyboard and Mouse
Mode 2	Exchange data with U disk

<b>For Conducted Emission</b>	
Final Test Mode	Test with Keyboard and Mouse
Mode 1	Test with Keyboard and Mouse
Mode 2	Exchange data with U disk

<b>For Radiated Emission</b>	
Final Test Mode	Test with Keyboard and Mouse
Mode 1	Test with Keyboard and Mouse
Mode 2	Exchange data with U disk

## 2.3 CONFIGURATION OF SYSTEM UNDER TEST

Mode 1:

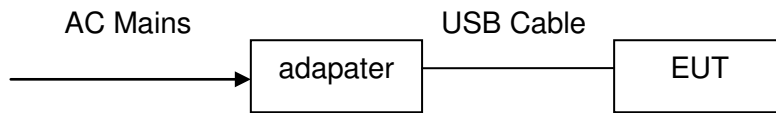

(EUT: Mobile Phone)

I/O Port of EUT			
I/O Port Type	Q'TY	Cable	Tested with
USB port	1	1m USB cable, unshielded	1

## 2.4 DESCRIPTION OF SUPPORT UNITS (CONDUCTED MODE)

The EUT has been tested as an independent unit together with other necessary accessories or support units. The following support units or accessories were used to form a representative test configuration during the tests.

Item	Equipment	Mfr/Brand	Model/Type No.	Series No.	Note
1	Adapater	/	/	/	/
2	Keyboard	/	/	/	/
3	Mouse	/	/	/	/
4	U disk	/	/	/	/

Note:

- (1) The support equipment was authorized by Declaration of Confirmation.
- (2) For detachable type I/O cable should be specified the length in cm in 『Length』 column.



### 3. SUMMARY OF TEST RESULTS

Test procedures according to the technical standards:

<b>FCC Part15 , Subpart B</b>			
Standard Section	Test Item	Judgment	Remark
15.107	CONDUCTED EMISSION	PASS	
15.109	RADIATED EMISSION	PASS	

**NOTE:**

(1) "N/A" denotes test is not applicable in this test report.

**4. MEASUREMENT INSTRUMENTS**

Kind of Equipment	Manufacturer	Type No.	Serial No.	Last Calibrated	Calibrated until
ESCI Test Receiver	R&S	ESCI	100005	08/19/2015	08/18/2016
LISN	AFJ	LS16	16010222119	08/19/2015	08/18/2016
LISN(EUT)	Mestec	AN3016	04/10040	08/19/2015	08/18/2016
pre-amplifier	CDSI	PAP-1G18-38	--	08/19/2015	08/18/2016
System Controller	CT	SC100	-	08/19/2015	08/18/2016
Bi-log Antenna	Chase	CBL6111C	2576	08/19/2015	08/18/2016
Spectrum analyzer	R&S	FSU26	200409	08/19/2015	08/18/2016
Horn Antenna	SCHWARZBECK	9120D	1141	08/19/2015	08/18/2016
Bi-log Antenna	SCHWABEBECK	VULB9163	9163/340	08/19/2015	08/18/2016
Pre Amplifier	H.P.	HP8447E	2945A02715	10/13/2015	10/12/2016
9*6*6 Anechoic	--	--	--	08/21/2015	08/20/2016

## 5. EMC EMISSION TEST

### 5.1 CONDUCTED EMISSION MEASUREMENT

#### 5.1.1 POWER LINE CONDUCTED EMISSION Limits (Frequency Range 150KHz-30MHz)

FREQUENCY (MHz)	Class A (dBuV)		Class B (dBuV)		Standard
	Quasi-peak	Average	Quasi-peak	Average	
0.15 -0.5	79.00	66.00	66 - 56 *	56 - 46 *	FCC
0.50 -5.0	73.00	60.00	56.00	46.00	FCC
5.0 -30.0	73.00	60.00	60.00	50.00	FCC

Note:

- (1) The tighter limit applies at the band edges.
- (2) The limit of " \* " marked band means the limitation decreases linearly with the logarithm of the frequency in the range.

The following table is the setting of the receiver

Receiver Parameters	Setting
Attenuation	10 dB
Start Frequency	0.15 MHz
Stop Frequency	30 MHz
IF Bandwidth	9 kHz

### 5.1.2 TEST PROCEDURE

- The EUT was placed 0.4 meters from the horizontal ground plane with EUT being connected to the power mains through a line impedance stabilization network (LISN). All other support equipments powered from additional LISN(s). The LISN provide 50 Ohm/ 50uH of coupling impedance for the measuring instrument.
- Interconnecting cables that hang closer than 40 cm to the ground plane shall be folded back and forth in the center forming a bundle 30 to 40 cm long.
- I/O cables that are not connected to a peripheral shall be bundled in the center. The end of the cable may be terminated, if required, using the correct terminating impedance. The overall length shall not exceed 1 m.
- LISN at least 80 cm from nearest part of EUT chassis.
- For the actual test configuration, please refer to the related Item –EUT Test Photos.

### 5.1.3 DEVIATION FROM TEST STANDARD

No deviation

### 5.1.4 TEST SETUP

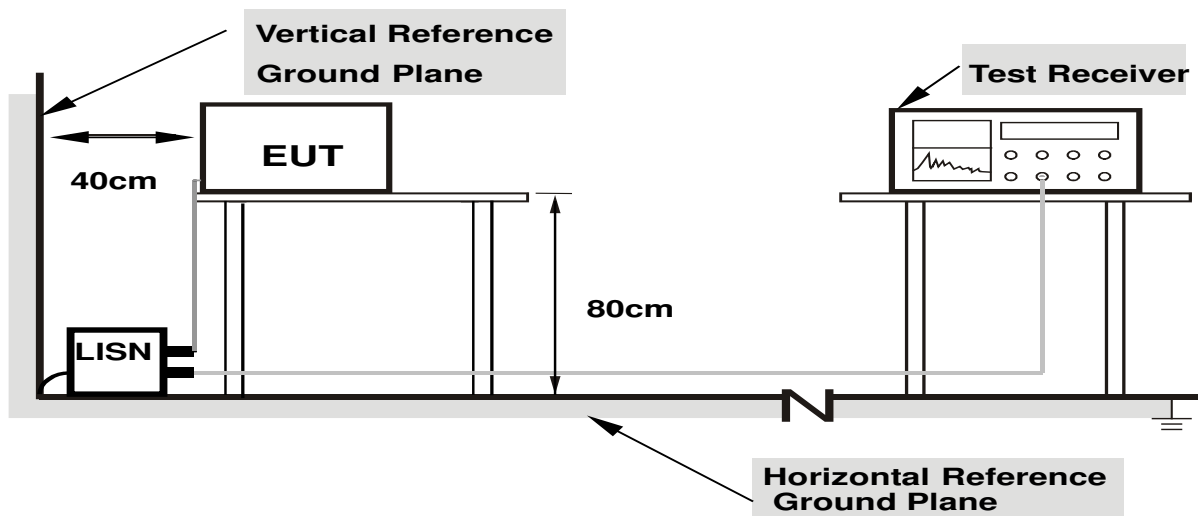

- Note: 1.Support units were connected to second LISN.**  
**2.Both of LISNs (AMN) are 80 cm from EUT and at least 80 from other units and other metal planes**

### 5.1.5 EUT OPERATING CONDITIONS

The EUT was configured for testing in a typical fashion (as a customer would normally use it). The EUT has been programmed to continuously transmit during test. This operating condition was tested and used to collect the included data.

### 5.1.6 TEST RESULTS

EUT	Mobile Phone	Model Name	T472
Temperature	26 °C	Relative Humidity	54%
Pressure	1010hPa	Phase	L
Test Date	February 25, 2016	Test Mode	Mode 1

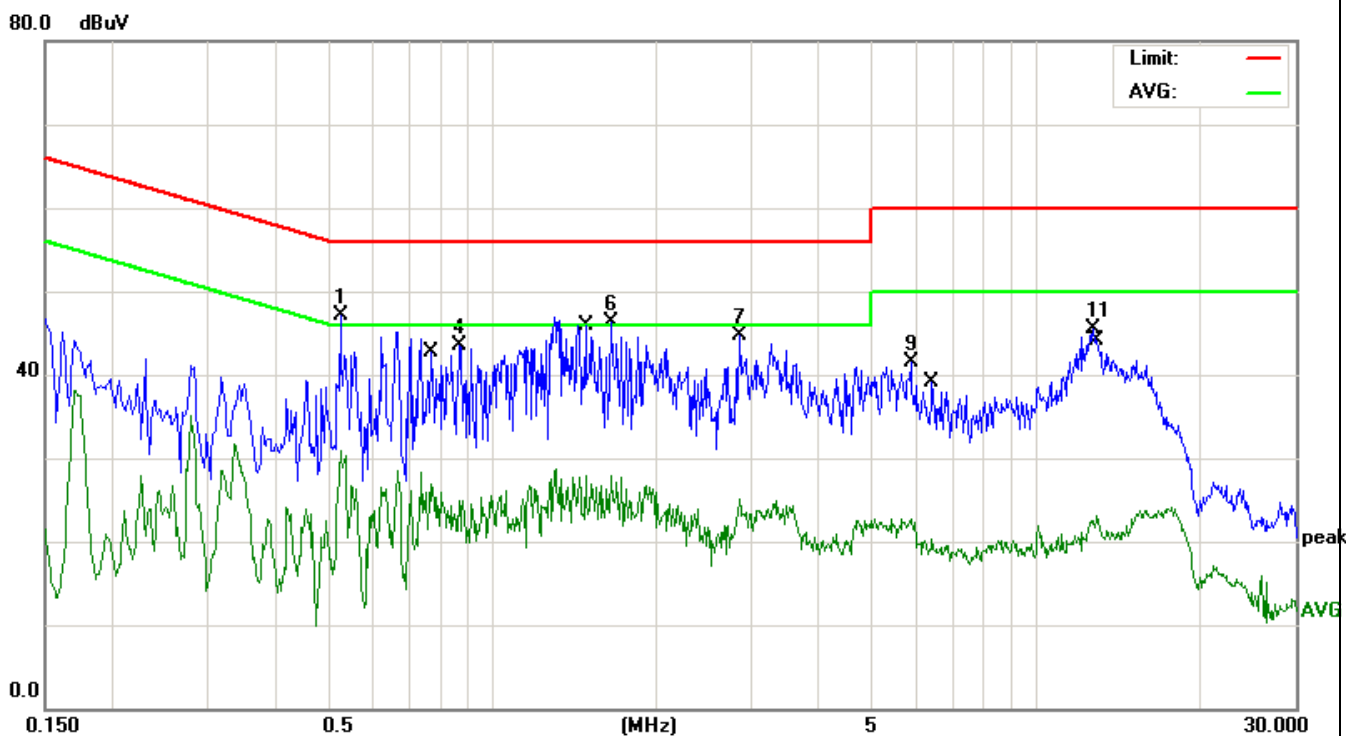

No.	Mk.	Freq. MHz	Reading Level dBuV	Correct Factor dB	Measure- ment dBuV	Limit dBuV	Over dB	Detector
1	*	0.5260	36.66	10.40	47.06	56.00	-8.94	peak
2		0.5260	20.40	10.40	30.80	46.00	-15.20	AVG
3		0.7700	16.58	10.37	26.95	46.00	-19.05	AVG
4		0.8699	33.05	10.36	43.41	56.00	-12.59	peak
5		1.4818	17.61	10.32	27.93	46.00	-18.07	AVG
6		1.6500	35.98	10.31	46.29	56.00	-9.71	peak
7		2.8420	34.38	10.27	44.65	56.00	-11.35	peak
8		2.8420	14.85	10.27	25.12	46.00	-20.88	AVG
9		5.8738	31.23	10.22	41.45	60.00	-18.55	peak
10		6.4298	10.15	10.22	20.37	50.00	-29.63	AVG
11		12.7378	35.31	10.17	45.48	60.00	-14.52	peak
12		12.9458	12.90	10.17	23.07	50.00	-26.93	AVG

EUT	Mobile Phone	Model Name	T472
Temperature	26 °C	Relative Humidity	54%
Pressure	1010hPa	Phase	N
Test Date	February 25, 2016	Test Mode	Mode 1

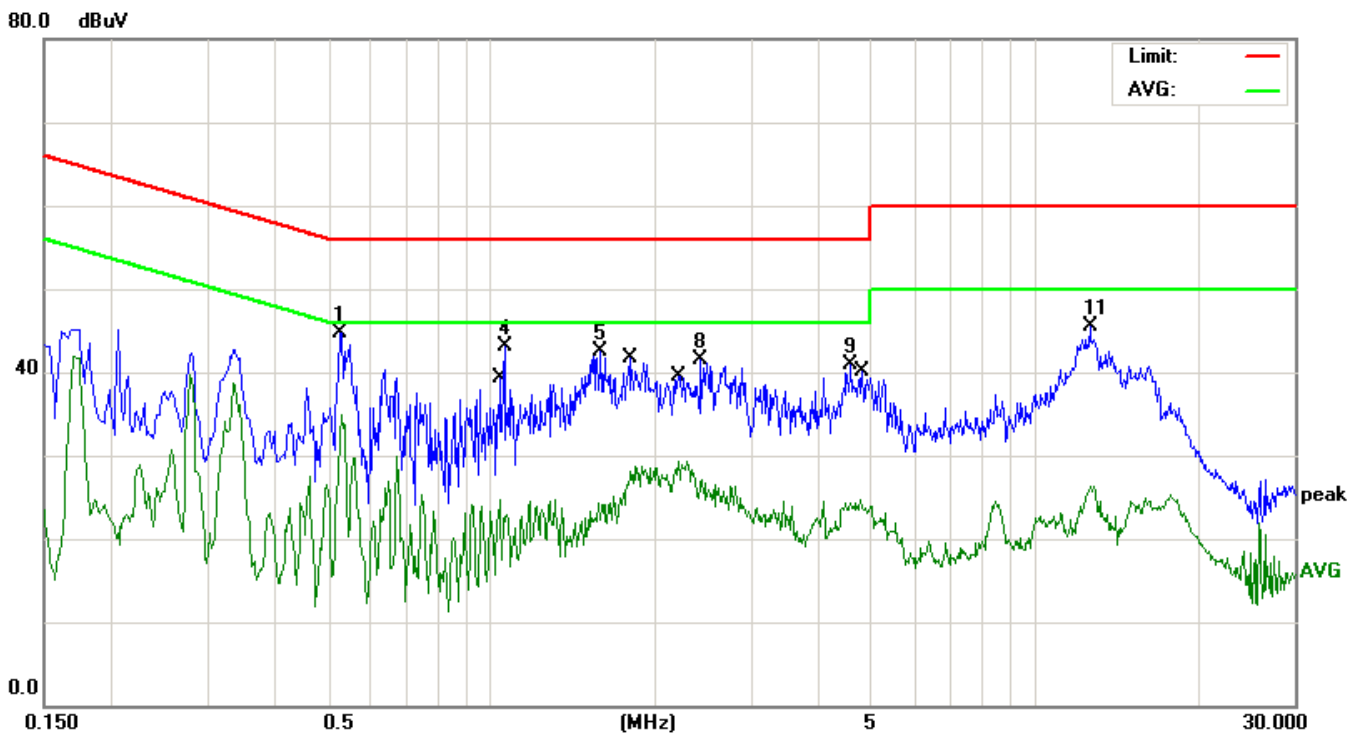

No.	Mk.	Freq. MHz	Reading Level dBuV	Correct Factor dB	Measure- ment dBuV	Limit dBuV	Over dB	Detector
1		0.5260	34.38	10.40	44.78	56.00	-11.22	peak
2	*	0.5299	24.50	10.40	34.90	46.00	-11.10	AVG
3		1.0339	14.31	10.34	24.65	46.00	-21.35	AVG
4		1.0580	32.67	10.34	43.01	56.00	-12.99	peak
5		1.5900	32.22	10.31	42.53	56.00	-13.47	peak
6		1.8060	17.77	10.30	28.07	46.00	-17.93	AVG
7		2.2019	19.08	10.29	29.37	46.00	-16.63	AVG
8		2.4219	31.16	10.28	41.44	56.00	-14.56	peak
9		4.5858	30.62	10.24	40.86	56.00	-15.14	peak
10		4.7538	14.53	10.23	24.76	46.00	-21.24	AVG
11		12.6259	35.38	10.17	45.55	60.00	-14.45	peak
12		12.6259	16.17	10.17	26.34	50.00	-23.66	AVG

## 5.2 RADIATED EMISSION MEASUREMENT

### 5.2.1 RADIATED EMISSION LIMITS (Frequency Range 9kHz-1000MHz)

20dBc in any 100 kHz bandwidth outside the operating frequency band. In case the emission fall within the restricted band specified on 15.205(a), then the 15.209(a) limit in the table below has to be followed.

Frequencies (MHz)	Field Strength (micorvolts/meter)	Measurement Distance (meters)
0.009~0.490	2400/F(KHz)	300
0.490~1.705	24000/F(KHz)	30
1.705~30.0	30	30
30~88	100	3
88~216	150	3
216~960	200	3
Above 960	500	3

### LIMITS OF RADIATED EMISSION MEASUREMENT (Above 1000MHz)

FREQUENCY (MHz)	Limit (dBuV/m) (at 3M)	
	PEAK	AVERAGE
Above 1000	74	54

Notes:

- (1) The limit for radiated test was performed according to FCC PART 15C.
- (2) The tighter limit applies at the band edges.
- (3) Emission level (dBuV/m)=20log Emission level (uV/m).

Spectrum Parameter	Setting
Attenuation	Auto
Start Frequency	1000 MHz
Stop Frequency	10th carrier harmonic
RB / VB (emission in restricted band)	1 MHz / 1 MHz for Peak, 1 MHz / 10Hz for Average

Receiver Parameter	Setting
Attenuation	Auto
Start ~ Stop Frequency	9kHz~150kHz / RB 200Hz for QP
Start ~ Stop Frequency	150kHz~30MHz / RB 9kHz for QP
Start ~ Stop Frequency	30MHz~1000MHz / RB 120kHz for QP

### 5.2.2 TEST PROCEDURE

- a. The measuring distance of at 3 m shall be used for measurements at frequency up to 1GHz. For frequencies above 1GHz, any suitable measuring distance may be used.

- b. The EUT was placed on the top of a rotating table 0.8 meters above the ground at a 3 meter open area test site. The table was rotated 360 degrees to determine the position of the highest radiation.
- c. The height of the equipment or of the substitution antenna shall be 0.8 m; the height of the test antenna shall vary between 1 m to 4 m. Both horizontal and vertical polarizations of the antenna are set to make the measurement.
- d. The initial step in collecting conducted emission data is a spectrum analyzer peak detector mode pre-scanning the measurement frequency range. Significant peaks are then marked and then Quasi Peak detector mode re-measured.
- e. If the Peak Mode measured value compliance with and lower than Quasi Peak Mode Limit, the EUT shall be deemed to meet QP Limits and then no additional QP Mode measurement performed.
- f. For the actual test configuration, please refer to the related Item –EUT Test Photos.

Note:

***Both horizontal and vertical antenna polarities were tested and performed pretest to three orthogonal axis. The worst case emissions were reported***

### **5.2.3 DEVIATION FROM TEST STANDARD**

No deviation



### 5.2.4 TEST SETUP

#### (A) Radiated Emission Test-Up Frequency 30MHz~1GHz

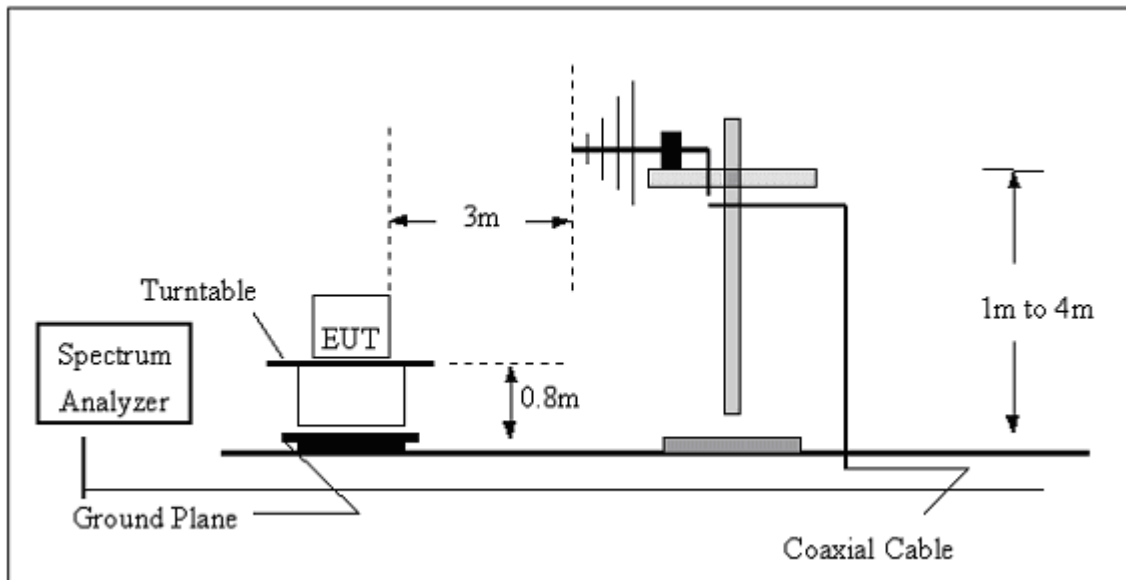

#### (B) Radiated Emission Test-Up Frequency Above 1GHz

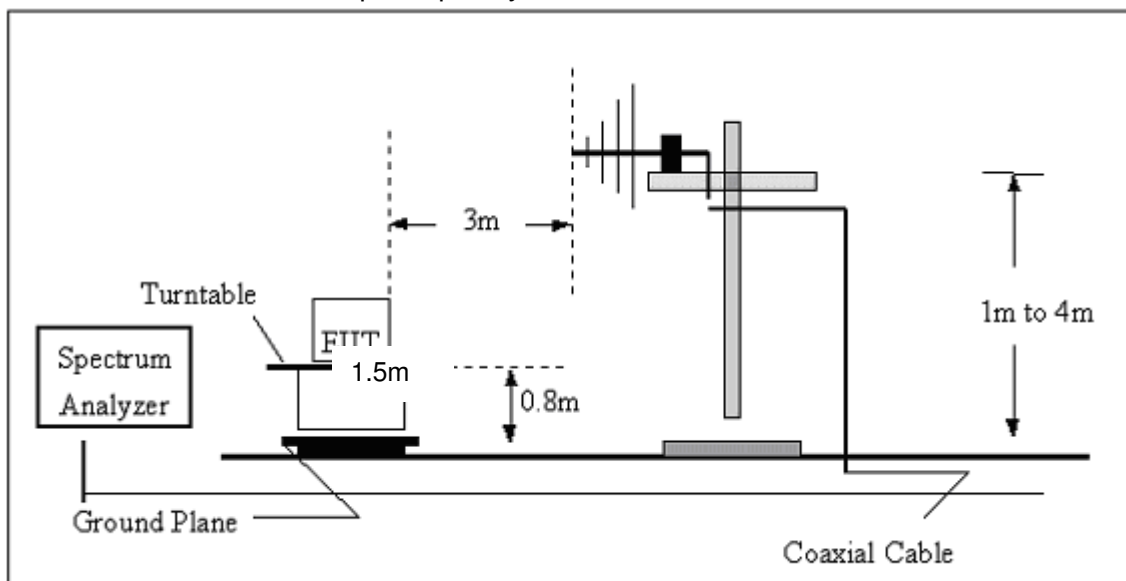

### 5.2.5 EUT OPERATING CONDITIONS

The EUT tested system was configured as the statements of 2.4 Unless otherwise a special operating condition is specified in the follows during the testing.

**5.2.5.1 TEST RESULTS (BETWEEN 30M – 1000 MHZ)**

EUT	Mobile Phone	Model Name	T472
Temperature	20 °C	Relative Humidity	48%
Pressure	1010 hPa	Polarization :	Horizontal
Test Mode	Mode 1	Test Date	February 25, 2016

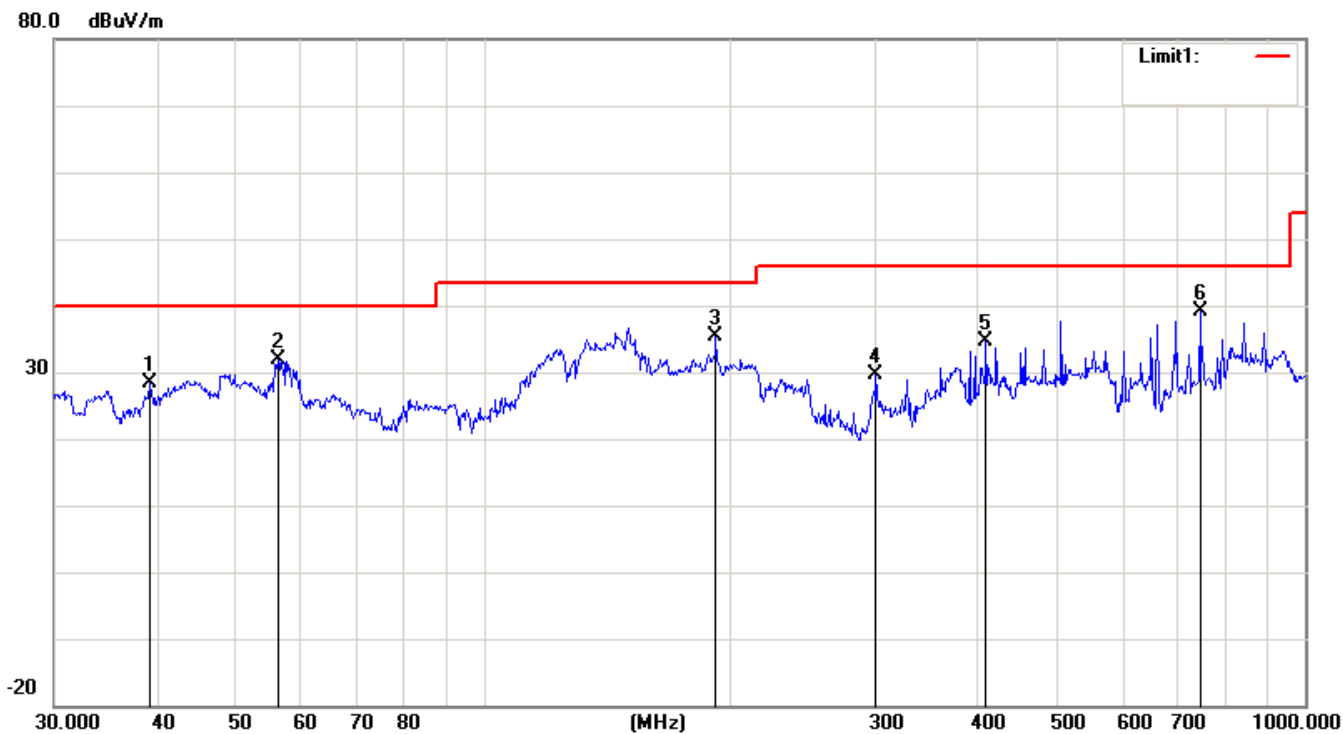

No.	Mk.	Freq. MHz	Reading Level dBuV	Correct Factor dB	Measure- ment dBuV/m	Limit dBuV/m	Over dB	Detector
1		39.1613	31.21	-2.89	28.32	40.00	-11.68	peak
2		56.1974	41.41	-9.48	31.93	40.00	-8.07	peak
3		191.7450	40.78	-5.29	35.49	43.50	-8.01	peak
4		300.3672	35.40	-5.69	29.71	46.00	-16.29	peak
5		408.9460	36.52	-1.98	34.54	46.00	-11.46	peak
6	*	744.8659	35.43	3.58	39.01	46.00	-6.99	peak

EUT	Mobile Phone	Model Name	T472
Temperature	20 °C	Relative Humidity	48%
Pressure	1010 hPa	Polarization :	Vertical
Test Mode	Mode 1	Test Date	February 25, 2016

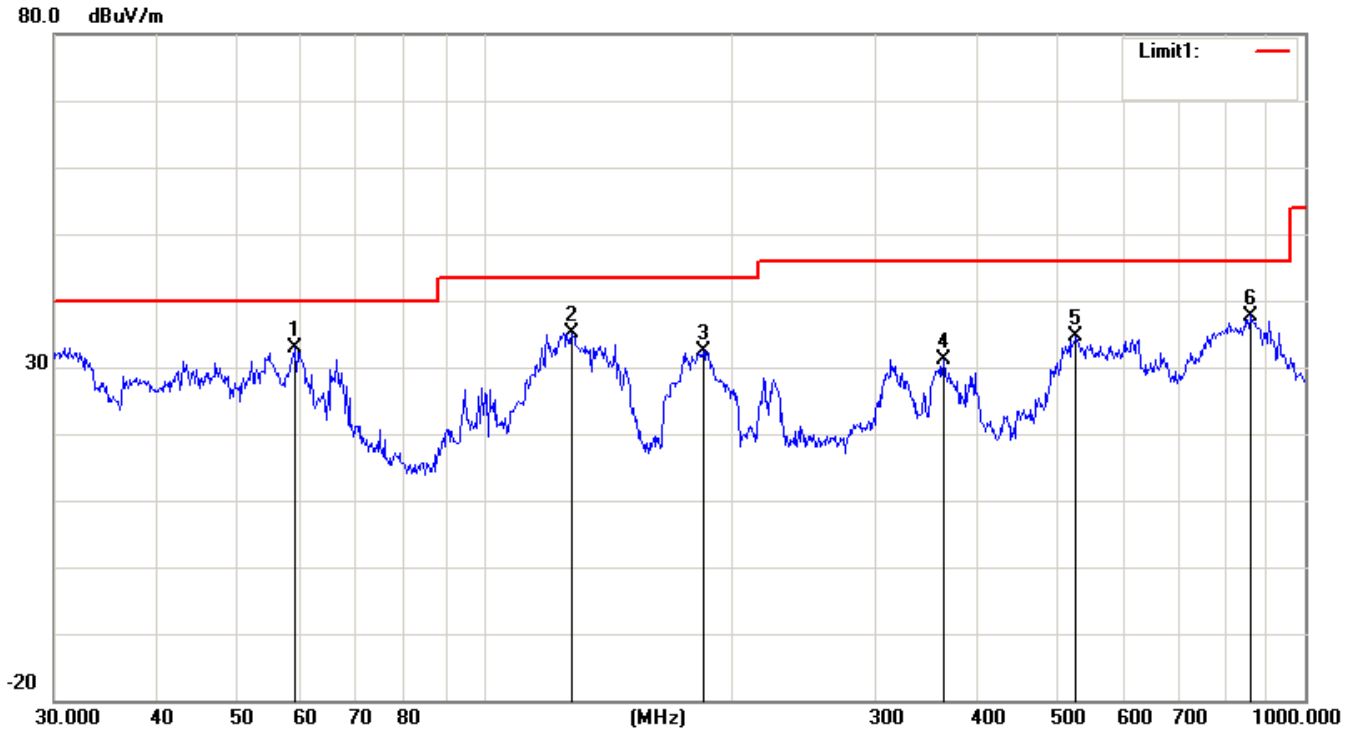

No.	Mk.	Freq. MHz	Reading Level dBuV	Correct Factor dB	Measure- ment dBuV/m	Limit dBuV/m	Over dB	Detector
1	*	58.8185	42.17	-9.41	32.76	40.00	-7.24	peak
2		128.1125	37.38	-2.17	35.21	43.50	-8.29	peak
3		185.1379	37.75	-5.27	32.48	43.50	-11.02	peak
4		362.9844	35.01	-3.83	31.18	46.00	-14.82	peak
5		526.3967	35.03	-0.44	34.59	46.00	-11.41	peak
6		860.0352	32.90	4.85	37.75	46.00	-8.25	peak

**5.2.5.2 TEST RESULTS(1GHZ TO 6GHZ)**

EUT	Mobile Phone	Model Name	T472
Temperature	20 °C	Relative Humidity	48%
Pressure	1010 hPa	Test Mode	Mode 1
Test Date	February 25, 2016		

Freq. (MHz)	Ant. Pol.	Emission Level(dBuV)		Limit 3m(dBuV/m)		Over(dB)	
		PK	AV	PK	AV	PK	AV
1672.55	V	58.17	39.80	74	54	-15.83	-14.20
2839.55	V	58.71	40.83	74	54	-15.29	-13.17
1694.48	H	59.81	40.14	74	54	-14.19	-13.86
2833.56	H	59.99	40.99	74	54	-14.01	-13.01

**Remark:**

All emissions not reported were more than 20dB below the specified limit or in the noise floor.  
Factor = Antenna Factor + Cable Loss – Pre-amplifier.  
All the x/y/z orientation has been investigated, and only worst case is presented in this report.

## 6. EUT TEST PHOTO

CONDUCTED EMISSION TEST



RADIATED EMISSION TEST

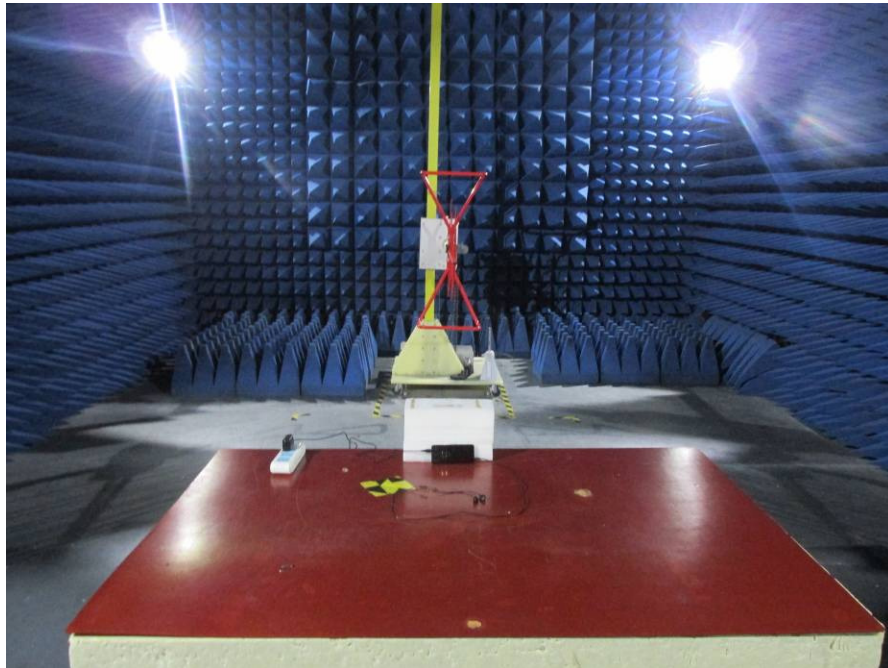

RADIATED EMISSION TEST

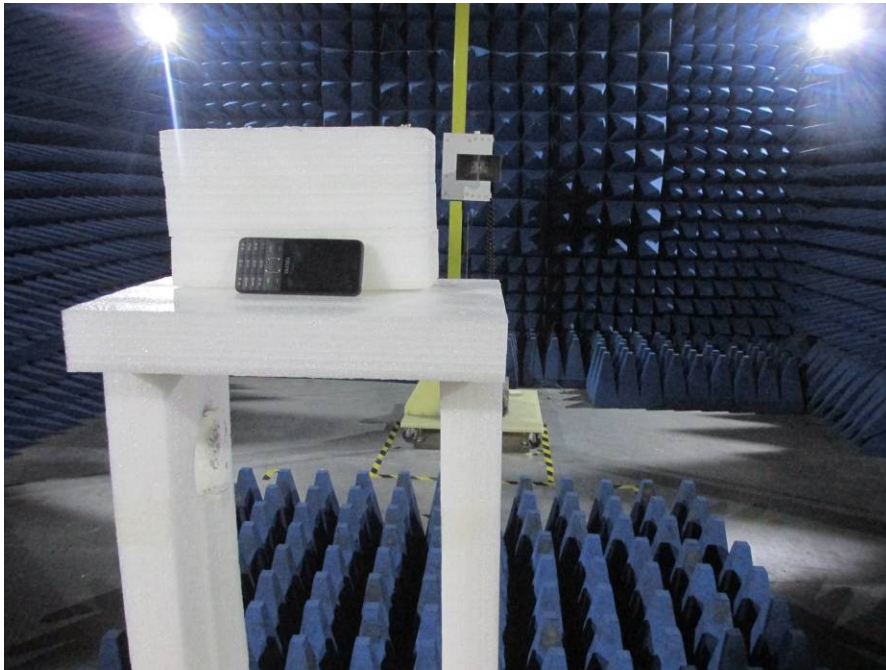

## 7. PHOTOGRAPHS OF EUT

Appearance photograph of EUT



Appearance photograph of EUT



Appearance photograph of EUT



Appearance photograph of EUT

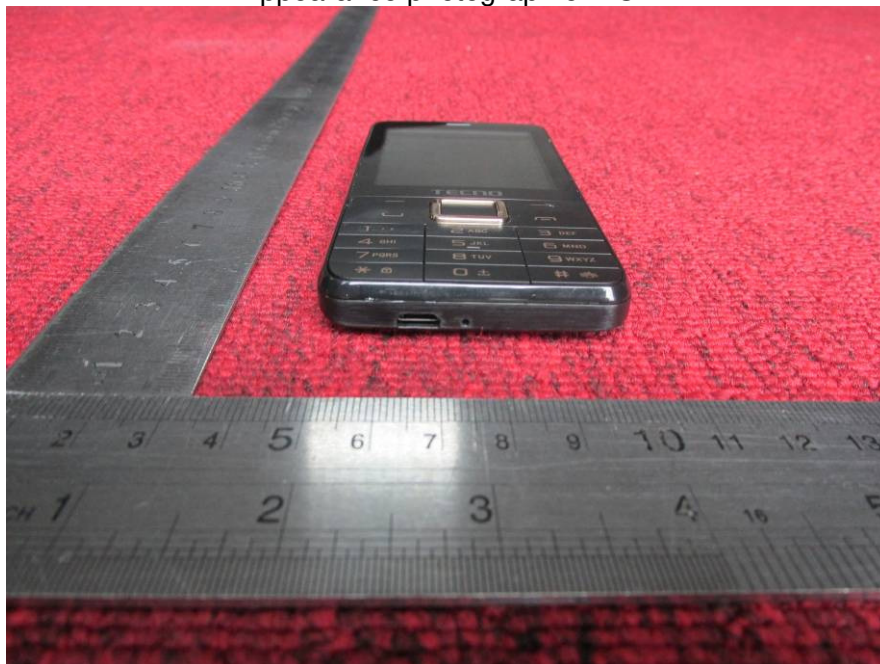



Appearance photograph of EUT



Appearance photograph of EUT



Appearance photograph of EUT



Internal photograph of EUT



Internal photograph of EUT



Internal photograph of EUT

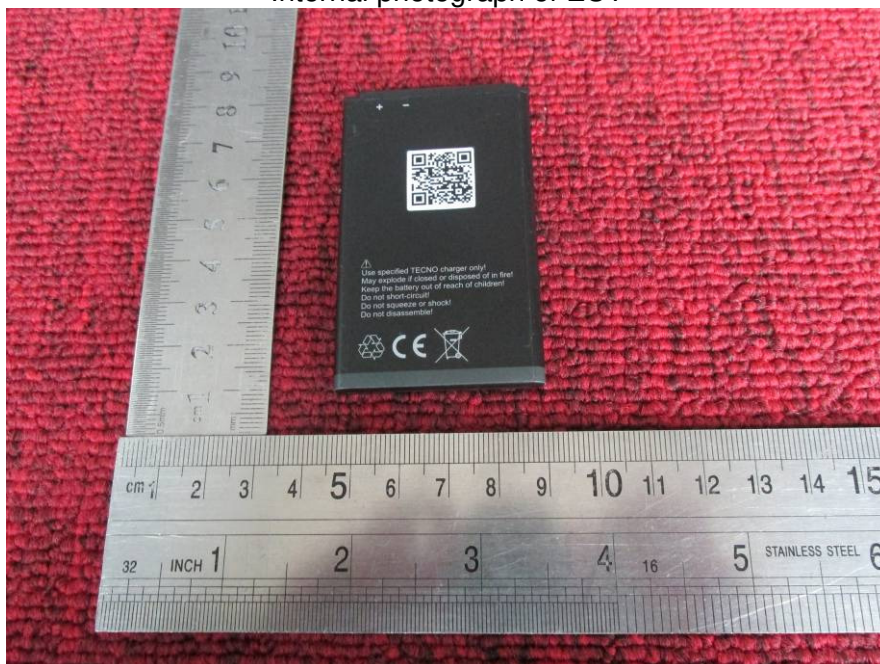

Internal photograph of EUT



Internal photograph of EUT



Internal photograph of EUT



Internal photograph of EUT



Internal photograph of EUT

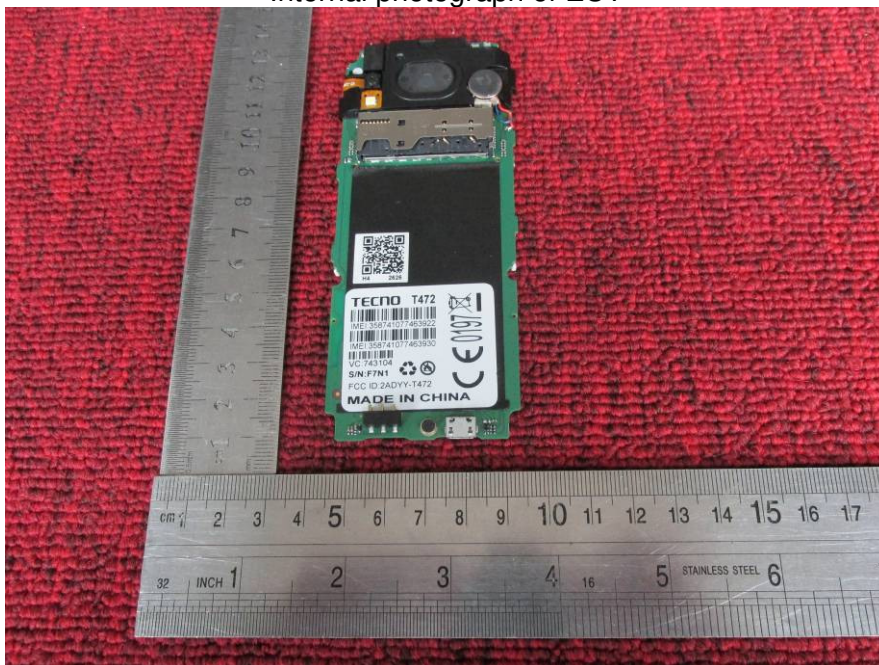

Internal photograph of EUT



Internal photograph of EUT

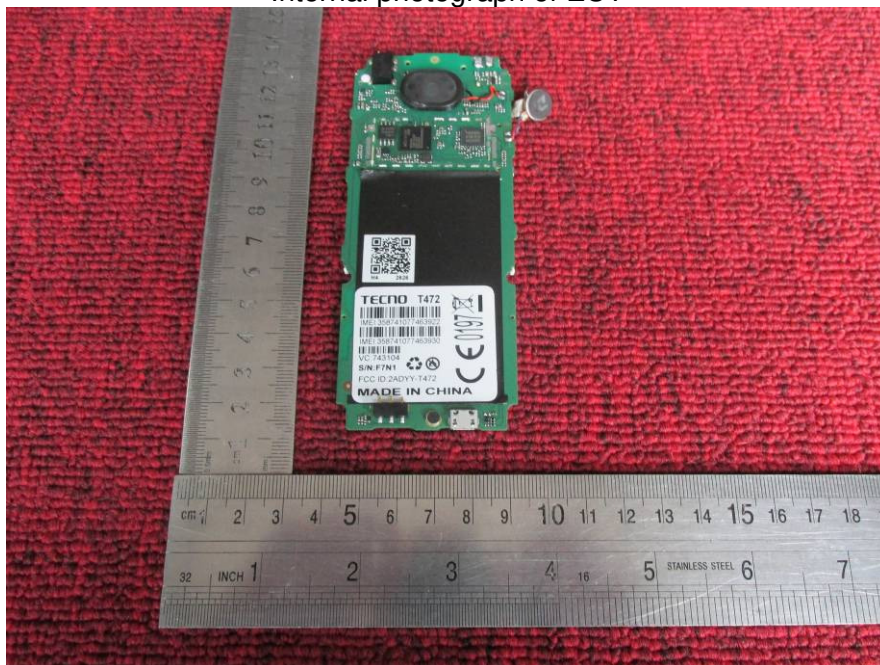

Internal photograph of EUT

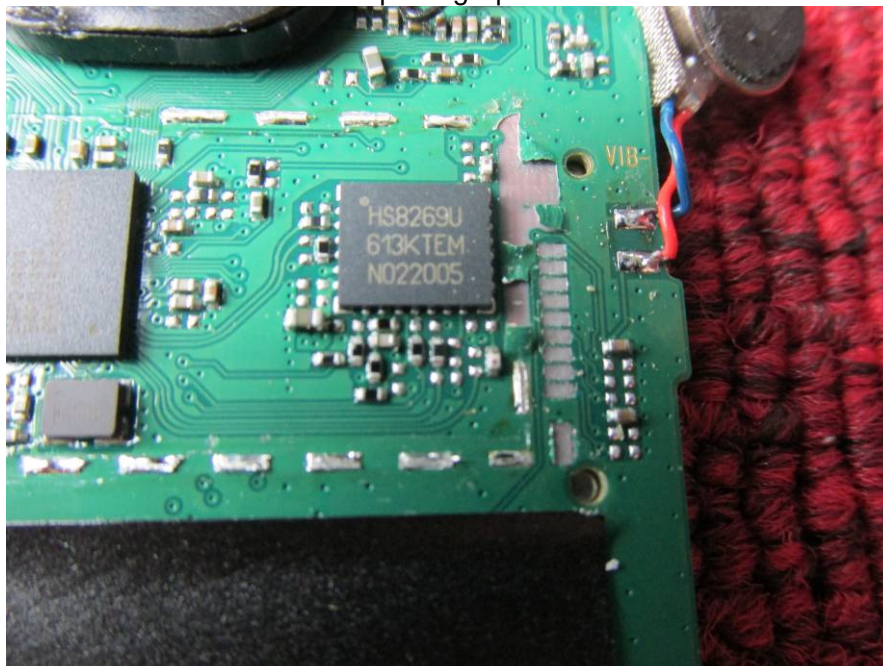

Internal photograph of EUT

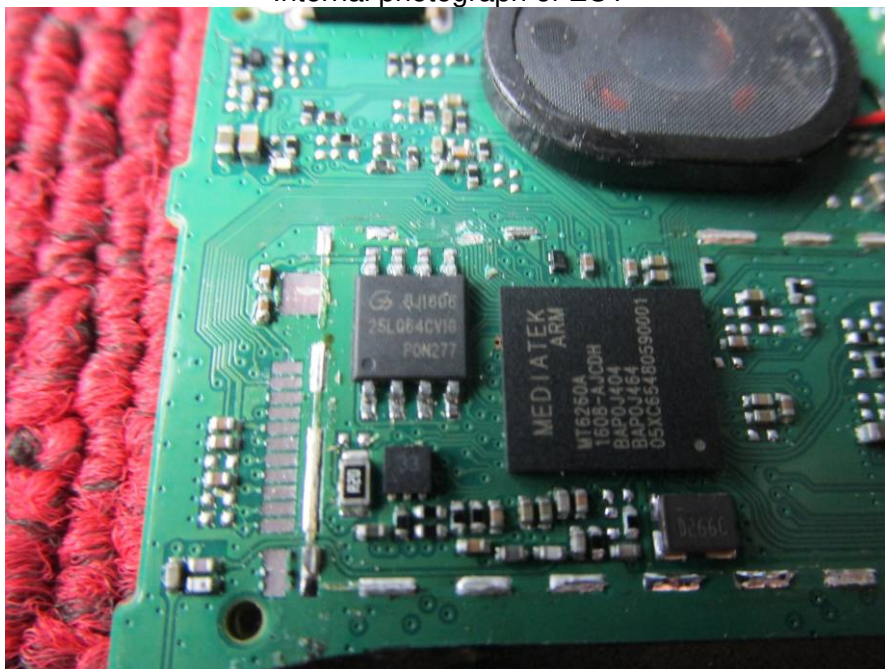

Internal photograph of EUT

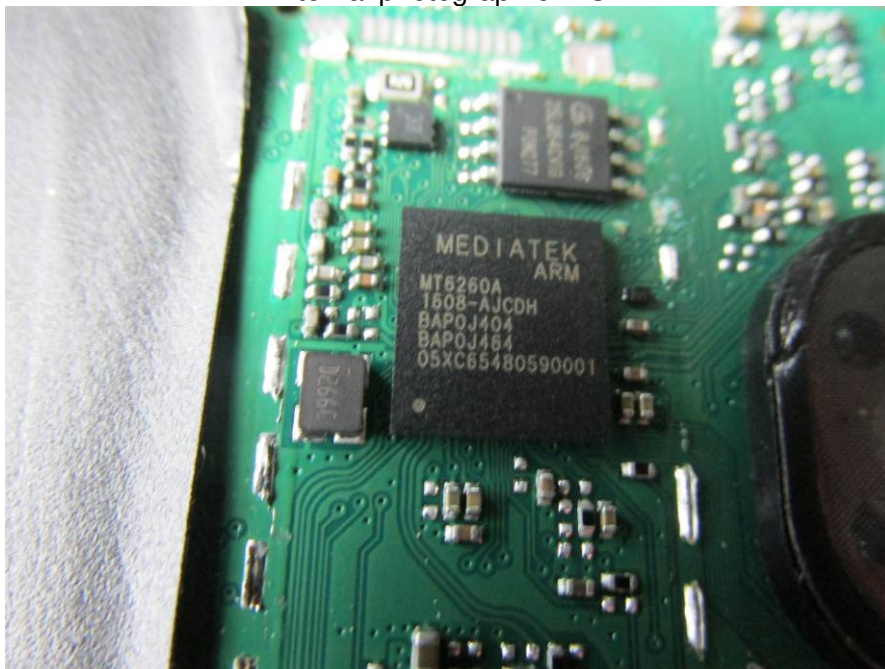



Internal photograph of EUT

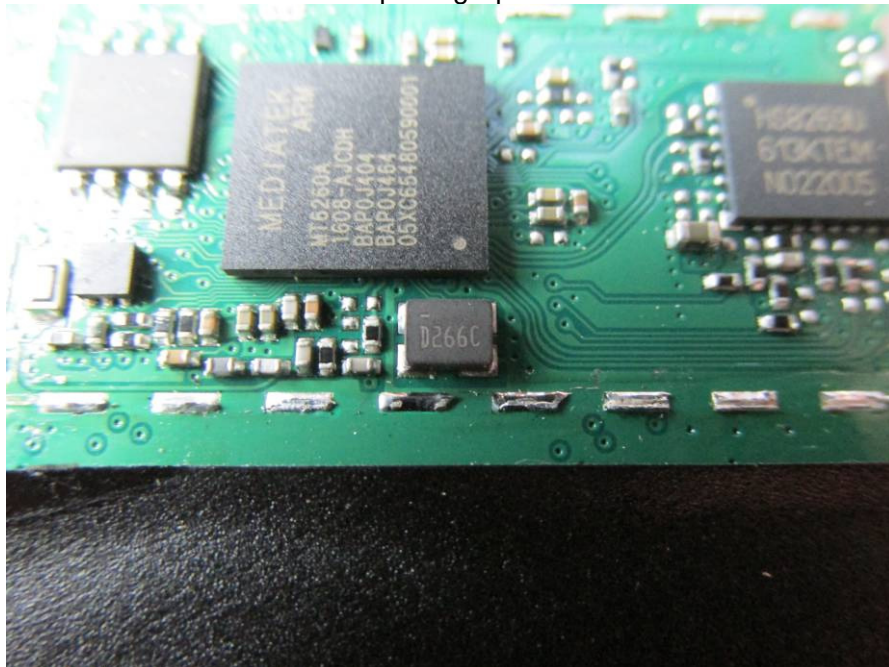

**---END OF REPORT---**