

FCC SAR Compliance Test Report

For

TECNO MOBILE LIMITED

ROOMS 05-15, 13A/F., SOUTH TOWER, WORLD FINANCE CENTRE,
HARBOUR CITY, 17 CANTON ROAD, TSIM SHA TSUI,
KOWLOON, HONG KONG

Model: T463



Prepared By:	Shenzhen WST Testing Technology Co., Ltd. 1F, No.9 Building, TKG Science & Technology Park Ya ngtian Rd., NO.72 Bao'an Dist., GuangDong, China
Report Number:	FCC15016713-2
FCC ID:	2ADYY-T463
Report Date:	2015-01-22
Checked By:	Mark Cheng 
Approved By:	 Michal Ling
Prepared By:	World Standardization Certification & Testing CO., LTD. Building A, Baoshi Science & Technology Park, Baoshi Road, Bao'an District, Shenzhen, Guangdong, China Tel: +86-755-26996192 Fax: +86-755-26996253

Table of contents

1 General information4

1.1 Notes4

1.2 Application details4

1.3 Statement of Compliance.....5

1.4 EUT Information6

2 Testing laboratory7

3 Test Environment.....7

4 Applicant and Manufacturer7

5 Test standard/s:.....8

5.1 RF exposure limits9

5.2 SAR Definition9

6 SAR Measurement System10

6.1 The Measurement System10

6.2 Robot.....11

6.3 Probe11

6.4 Measurement procedure12

6.5 Description of interpolation/extrapolation scheme.....12

6.6 Phantom.....13

6.7 Device Holder14

6.8 Video Positioning System.....15

6.9 Tissue simulating liquids: dielectric properties16

6.10 Tissue simulating liquids: parameters17

7 System Check.....18

7.1 System check procedure18

7.2 System check results19

8 SAR Test Test Configuration20

8.1 GSM Test Configurations.....20

9 Detailed Test Results.....21

9.1 Conducted Power measurements.....21

9.1.1 Conducted Power of GSM850.....21

9.1.2 Conducted Power of GSM1900.....22

9.1.3 Conducted Power of BT22

9.2 SAR test results23

9.2.1 Results overview of GSM850.....24

9.2.2 Results overview of GSM1900.....25

10 Multiple Transmitter Information.....26

10.1.1 Stand-alone SAR test exclusion.....26

10.1.2 Simultaneous Transmission Possibilities.....28

10.1.3 SAR Summation Scenario28

11 Measurement uncertainty evaluation29

11.1 Measurement uncertainty evaluation for SAR test29

11.2 Measurement uncertainty evaluation for system check.....30

12 Test equipment and ancillaries used for tests31

Annex A: System performance verification.....32

Annex B: Measurement results.....32

Annex C: Calibration reports32

Annex D: Photo documentation.....33

Modified History

REV.	Modification Description	Issued Date	Remark
REV.1.0	Initial Test Report Release	2015-01-22	Bruce He

1 General information

1.1 Notes

The test results of this test report relate exclusively to the test item specified in this test report. Shenzhen WST Testing Technology Co., Ltd. does not assume responsibility for any conclusions and generalisations drawn from the test results with regard to other specimens or samples of the type of the equipment represented by the test item. The test report is not to be reproduced or published in full without the prior written permission.

1.2 Application details

Date of receipt of test item: 2015-01-16
 Start of test: 2015-01-16
 End of test: 2015-01-19

1.3 Statement of Compliance

The maximum results of Specific Absorption Rate (SAR) found during testing for T463 is as below:

Band	Position	MAX Reported SAR _{1g} (W/kg)
GSM850	Head	1.290
	Body 10mm	1.145
	Body-worn	0.898
GSM1900	Head	0.798
	Body 10mm	0.629
	Body-worn	0.268
The highest simultaneous SAR is 1.408W/kg per KDB690783 D01		

The device is in compliance with Specific Absorption Rate (SAR) for general population/uncontrolled exposure limits of 1.6 W/Kg as averaged over any 1g tissue according to the FCC rule §2.1093, the ANSI/IEEE C95.1:2005, the NCRP Report Number 86 for uncontrolled environment, according to the Industry Canada Radio Standards Specification RSS-102 for General Population/Uncontrolled exposure, and had been tested in accordance with the measurement methods and procedures specified in IEEE Std 1528-2003 & IEEE Std 1528a-2005.

1.4 EUT Information

Device Information:			
Product Type:	Mobile Phone		
Model:	T463		
Device Type:	Portable device		
Exposure Category:	uncontrolled environment / general population		
Production Unit or Identical Prototype:	Production Unit		
Hardware version:	N/A		
Software version :	N/A		
Antenna Type :	Integral Antenna		
Device Operating Configurations:			
Supporting Mode(s) :	GSM850/1900, BT		
Modulation:	GMSK, GFSK/ $\pi/4$ -DQPSK/ 8-DPSK		
Device Class :	Class B, No DTM Mode		
Operating Frequency Range(s)	Band	TX(MHz)	RX(MHz)
	GSM850	824~849	869~894
	GSM1900	1850~1910	1930~1990
	BT	2402~2480	2402~2480
GPRS class level:	GPRS class 12		
Test Channels (low-mid-high):	128-190-251(GSM850)		
	512-661-810(GSM1900)		
	0-39-78(BT)		
Power Source:	3.7 VDC/1650mAh Rechargeable Battery		

2 Testing laboratory

Test Site	World Standardization Certification & Testing CO., LTD.
Test Location	Building A, Baoshi Science & Technology Park, Baoshi Road, Bao'an District, Shenzhen, Guangdong, China
Telephone	+86-755-26996192
Fax	+86-755-26996253
State of accreditation	The Test laboratory (area of testing) is accredited according to ISO/IEC 17025. CNAS Registration number:L3732

3 Test Environment

	Required	Actual
Ambient temperature:	18 – 25 °C	22 ± 2 °C
Tissue Simulating liquid:	22 ± 2 °C	22 ± 2 °C
Relative humidity content:	30 – 70 %	30 – 70 %

4 Applicant and Manufacturer

Applicant/Client Name:	TECNO MOBILE LIMITED
Applicant Address:	ROOMS 05-15, 13A/F., SOUTH TOWER, WORLD FINANCE CENTRE, HARBOUR CITY, 17 CANTON ROAD, TSIM SHA TSUI, KOWLOON, HONG KONG
Manufacturer Name:	SHENZHEN SMARTTEL CO., LTD
Manufacturer Address:	6th Floor, Block 15, shatoujiao Free TRADE Zone, Shenyang Road, Yantian District, Shenzhen, Guangdong, P.R.China

5 Test standard/s:

ANSI Std C95.1-2005	Safety Levels with Respect to Human Exposure to Radio Frequency Electromagnetic Fields, 3 kHz to 300 GHz.
IEEE Std 1528-2003	Recommended Practice for Determining the Peak Spatial-Average Specific Absorption Rate (SAR) in the Human Head from Wireless Communications Devices: Measurement Techniques
IEEE Std 1528a-2005	IEEE Recommended Practice for Determining the Peak Spatial-Average Specific Absorption Rate (SAR) in the Human Head from Wireless Communications Devices: Measurement Techniques Amendment 1: CAD File for Human Head Model (SAM Phantom)
RSS-102	Radio Frequency Exposure Compliance of Radiocommunication Apparatus (All Frequency Bands (Issue 4 of March 2010)
KDB447498 D01	General RF Exposure Guidance v05r02
KDB648474 D04	Handset SAR v01r02
KDB865664 D01	SAR Measurement 100 MHz to 6 GHz v01r03
KDB865664 D02	RF Exposure Reporting v01r01

5.1 RF exposure limits

Human Exposure	Uncontrolled Environment General Population	Controlled Environment Occupational
Spatial Peak SAR* (Brain/Body/Arms/Legs)	1.60 mW/g	8.00 mW/g
Spatial Average SAR** (Whole Body)	0.08 mW/g	0.40 mW/g
Spatial Peak SAR*** (Hands/Feet/Ankle/Wrist)	4.00 mW/g	20.00 mW/g

The limit applied in this test report is shown in bold letters

Notes:

- * The Spatial Peak value of the SAR averaged over any 1 gram of tissue (defined as a tissue volume in the shape of a cube) and over the appropriate averaging time.
- ** The Spatial Average value of the SAR averaged over the whole body.
- *** The Spatial Peak value of the SAR averaged over any 10 grams of tissue (defined as a tissue volume in the shape of a cube) and over the appropriate averaging time.

Uncontrolled Environments are defined as locations where there is the exposure of individuals who have no knowledge or control of their exposure.

Controlled Environments are defined as locations where there is exposure that may be incurred by persons who are aware of the potential for exposure, (i.e. as a result of employment or occupation).

5.2 SAR Definition

Specific Absorption Rate is defined as the time derivative (rate) of the incremental energy (dW) absorbed by(dissipated in) an incremental mass (dm) contained in a volume element (dV) of a given density (ρ).

$$SAR = \frac{d}{dt} \left(\frac{dW}{dm} \right) = \frac{d}{dt} \left(\frac{dW}{\rho dV} \right)$$

SAR is expressed in units of watts per kilogram (W/kg). SAR can be related to the electric field at a point by

$$SAR = \frac{\sigma |E|^2}{\rho}$$

where:

σ = conductivity of the tissue (S/m)

ρ = mass density of the tissue (kg/m³)

E = rms electric field strength (V/m)

6 SAR Measurement System

6.1 The Measurement System

Comosar is a system that is able to determine the SAR distribution inside a phantom of human being according to different standards. The Comosar system consists of the following items:

- Main computer to control all the system
- 6 axis robot
- Data acquisition system
- Miniature E-field probe
- Device holder
- Head simulating tissue

The following figure shows the system.



The EUT under test operating at the maximum power level is placed in the phone holder, under the phantom, which is filled with head simulating liquid. The E-Field probe measures the electric field inside the phantom. The OpenSAR software computes the results to give a SAR value in a 1g or 10g mass.

6.2 Robot

The COMOSAR system uses the high precision robots KR 6 R900 sixx type out of the newer series from Satimo SA (France). For the 6-axis controller COMOSAR system, the KUKA robot controller version from Satimo is used. The KR 6 R900 sixx robot series have many features that are important for

our application:

- High precision (repeatability 0.02 mm)
- High reliability (industrial design)
- Jerk-free straight movements
- Low ELF interference (the closed metallic construction shields against motor control fields)
- 6-axis controller

6.3 Probe

For the measurements the Specific Dosimetric E-Field Probe SSE 5 with following specifications is used

- Dynamic range: 0.01-100 W/kg
- Tip Diameter : 5 mm
- Distance between probe tip and sensor center: 2.5mm
- Distance between sensor center and the inner phantom surface: 4 mm
(repeatability better than +/- 1mm)
- Probe linearity: <0.25 dB
- Axial Isotropy: <0.25 dB
- Spherical Isotropy: <0.50 dB
- Calibration range: 300 to 2600MHz for head & body simulating liquid.

Angle between probe axis (evaluation axis) and surface normal line: less than 30°

6.4 Measurement procedure

The following steps are used for each test position

- Establish a call with the maximum output power with a base station simulator. The connection between the mobile and the base station simulator is established via air interface.
- Measurement of the local E-field value at a fixed location. This value serves as a reference value for calculating a possible power drift.
- Measurement of the SAR distribution with a grid of 8 to 16 mm * 8 to 16 mm and a constant distance to the inner surface of the phantom. Since the sensors can not directly measure at the inner phantom surface, the values between the sensors and the inner phantom surface are extrapolated. With these values the area of the maximum SAR is calculated by an interpolation scheme.
- Around this point, a cube of 30 * 30 * 30 mm or 32 * 32 * 32 mm is assessed by measuring 5 or 8 * 5 or 8 * 4 or 5 mm. With these data, the peak spatial-average SAR value can be calculated.

6.5 Description of interpolation/extrapolation scheme

- The local SAR inside the phantom is measured using small dipole sensing elements inside a probe body. The probe tip must not be in contact with the phantom surface in order to minimise measurements errors, but the highest local SAR will occur at the surface of the phantom.
- An extrapolation is used to determine these highest local SAR values. The extrapolation is based on a fourth-order least-square polynomial fit of measured data. The local SAR value is then extrapolated from the liquid surface with a 1 mm step.
- The measurements have to be performed over a limited time (due to the duration of the battery) so the step of measurement is high. It could vary between 5 and 8 mm. To obtain an accurate assessment of the maximum SAR average over 10 grams and 1 gram requires a very fine resolution in the three-dimensional scanned data array.

6.6 Phantom

For the measurements the Specific Anthropomorphic Mannequin (SAM) defined by the IEEE SCC-34/SC2 group is used. The phantom is a polyurethane shell integrated in a wooden table. The thickness of the phantom amounts to 2mm +/- 0.2mm. It enables the dosimetric evaluation of left and right phone usage and includes an additional flat phantom part for the simplified performance check. The phantom set-up includes a cover, which prevents the evaporation of the liquid.



System Material	Permittivity	Loss Tangent
Delrin	3.7	0.005

6.7 Device Holder

The positioning system allows obtaining cheek and tilting position with a very good accuracy. In compliance with CENELEC, the tilt angle uncertainty is lower than 1°.

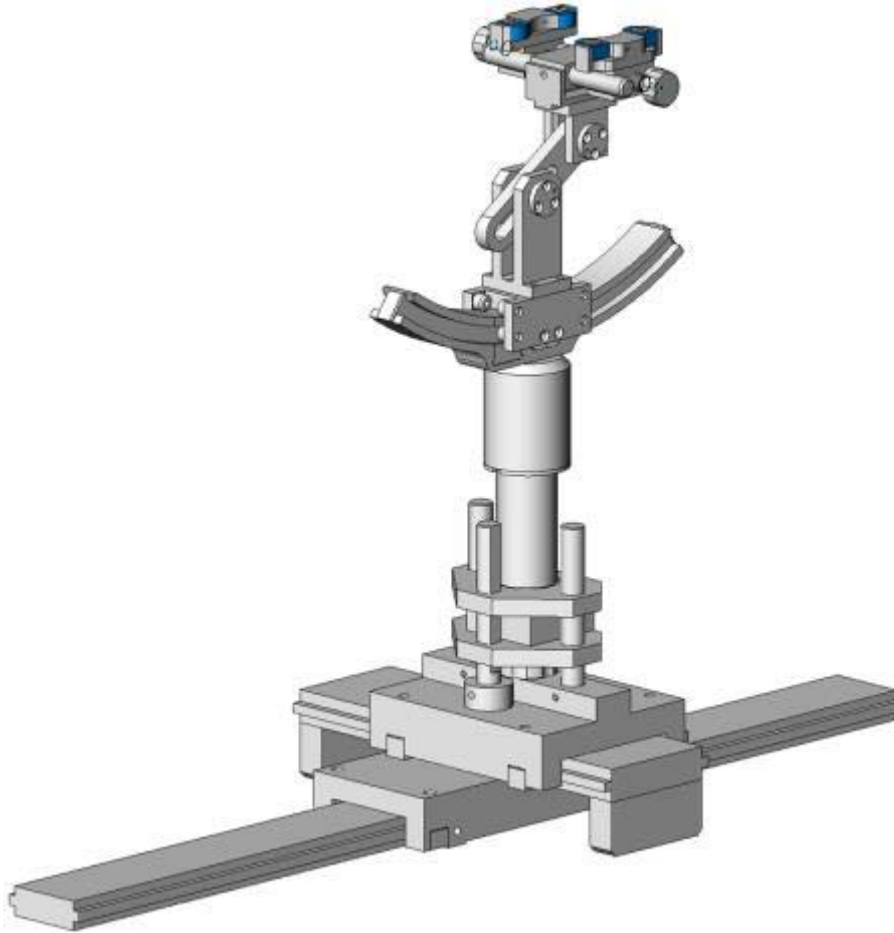

Device holder

System Material	Permittivity	Loss Tangent
Delrin	3.7	0.005

6.8 Video Positioning System

- The video positioning system is used in OpenSAR to check the probe. Which is composed of a camera, LED, mirror and mechanical parts. The camera is piloted by the main computer with firewire link.
- During the process, the actual position of the probe tip with respect to the robot arm is measured, as well as the probe length and the horizontal probe offset. The software then corrects all movements, such that the robot coordinates are valid for the probe tip.
- The repeatability of this process is better than 0.1 mm. If a position has been taught with an aligned probe, the same position will be reached with another aligned probe within 0.1 mm, even if the other probe has different dimensions. During probe rotations, the probe tip will keep its actual position.



6.9 Tissue simulating liquids: dielectric properties

The following materials are used for producing the tissue-equivalent materials.

(Liquids used for tests are marked with ☒):

Ingredients(% of weight)	Frequency (MHz)				
frequency band	<input type="checkbox"/> 450	<input checked="" type="checkbox"/> 835	<input type="checkbox"/> 1800	<input checked="" type="checkbox"/> 1900	<input type="checkbox"/> 2450
Tissue Type	Head	Head	Head	Head	Head
Water	38.56	41.45	52.64	55.242	62.7
Salt (NaCl)	3.95	1.45	0.36	0.306	0.5
Sugar	56.32	56.0	0.0	0.0	0.0
HEC	0.98	1.0	0.0	0.0	0.0
Bactericide	0.19	0.1	0.0	0.0	0.0
Triton X-100	0.0	0.0	0.0	0.0	36.8
DGBE	0.0	0.0	47.0	44.542	0.0
Ingredients(% of weight)	Frequency (MHz)				
frequency band	<input type="checkbox"/> 450	<input checked="" type="checkbox"/> 835	<input type="checkbox"/> 1800	<input checked="" type="checkbox"/> 1900	<input type="checkbox"/> 2450
Tissue Type	Body	Body	Body	Body	Body
Water	51.16	52.4	69.91	69.91	73.2
Salt (NaCl)	1.49	1.40	0.13	0.13	0.04
Sugar	46.78	45.0	0.0	0.0	0.0
HEC	0.52	1.0	0.0	0.0	0.0
Bactericide	0.05	0.1	0.0	0.0	0.0
Triton X-100	0.0	0.0	0.0	0.0	0.0
DGBE	0.0	0.0	29.96	29.96	26.7

Salt: 99+% Pure Sodium Chloride

Sugar: 98+% Pure Sucrose

Water: De-ionized, 16MΩ+ resistivity

HEC: Hydroxyethyl Cellulose

DGBE: 99+% Di(ethylene glycol) butyl ether, [2-(2-butoxyethoxy)ethanol]

Triton X-100(ultra pure): Polyethylene glycol mono [4-(1,1,3,3-tetramethylbutyl)phenyl]ether

6.10 Tissue simulating liquids: parameters

Tissue Type	Measured Frequency (MHz)	Target Tissue		Measured Tissue		Liquid Temp.	Test Date
		ϵ_r (+/-5%)	σ (S/m) (+/-5%)	ϵ_r	σ (S/m)		
835MHz Head	825	41.60 (39.52~43.68)	0.90 (0.86~0.95)	41.57	0.89	21.2°C	2015-01-16
	835	41.50 (39.43~43.58)	0.90 (0.86~0.95)	41.50	0.90		
	850	41.50 (39.43~43.58)	0.92 (0.87~0.97)	41.27	0.92		
835MHz Body	825	55.20 (52.44~57.96)	0.97 (0.92~1.02)	54.41	0.96	21.2°C	2015-01-16
	835	55.20 (52.44~57.96)	0.97 (0.92~1.02)	54.38	0.97		
	850	55.20 (52.44~57.96)	0.99 (0.94~1.04)	54.21	0.99		
1900MHz Head	1850	40.00 (38.00~42.00)	1.40 (1.33~1.47)	40.23	1.35	21.2°C	2015-01-19
	1880	40.00 (38.00~42.00)	1.40 (1.33~1.47)	40.10	1.38		
	1900	40.00 (38.00~42.00)	1.40 (1.33~1.47)	40.00	1.40		
	1910	40.00 (38.00~42.00)	1.40 (1.33~1.47)	39.94	1.41		
1900MHz Body	1850	53.30 (50.64~55.97)	1.52 (1.44~1.60)	53.50	1.47	21.2°C	2015-01-19
	1880	53.30 (50.64~55.97)	1.52 (1.44~1.60)	53.36	1.50		
	1900	53.30 (50.64~55.97)	1.52 (1.44~1.60)	53.31	1.52		
	1910	53.30 (50.64~55.97)	1.52 (1.44~1.60)	53.23	1.53		

ϵ_r = Relative permittivity, σ = Conductivity

7 System Check

7.1 System check procedure

The System check is performed by using a System check dipole which is positioned parallel to the planar part of the SAM phantom at the reference point. The distance of the dipole to the SAM phantom is determined by a spacer. The dipole is connected to the signal source consisting of signal generator and amplifier via a directional coupler, N-connector cable and adaption to SMA. It is fed with a power of 100 mW. To adjust this power a power meter is used. The power sensor is connected to the cable before the System check to measure the power at this point and do adjustments at the signal generator. At the outputs of the directional coupler both return loss as well as forward power are controlled during the validation to make sure that emitted power at the dipole is kept constant. This can also be checked by the power drift measurement after the test (result on plot).

System check results have to be equal or near the values determined during dipole calibration (target SAR in table above) with the relevant liquids and test system.

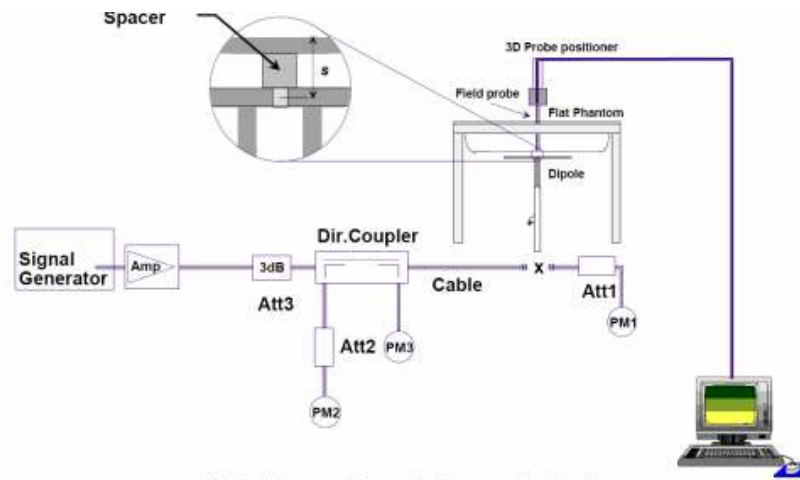

7.2 System check results

The system Check is performed for verifying the accuracy of the complete measurement system and performance of the software. The following table shows System check results for all frequency bands and tissue liquids used during the tests (plot(s) see annex A).

System Check	Target SAR (1W) (+/-10%)		Measured SAR (Normalized to 1W)		Liquid Temp.	Test Date
	1-g (mW/g)	10-g (mW/g)	1-g (mW/g)	10-g (mW/g)		
D835V2 Head	9.56 (8.60~10.52)	6.19 (5.57~6.81)	9.360	6.100	21.2°C	2015-01-16
D1900V2 Head	39.46 (35.51~43.41)	20.42 (18.38~22.46)	39.040	20.270	21.2°C	2015-01-19
D835V2 Body	9.86 (8.87~10.85)	6.38 (5.74~7.02)	9.980	6.510	21.2°C	2015-01-16
D1900V2 Body	40.06 (36.05~44.07)	20.76 (18.68~22.84)	43.700	22.990	21.2°C	2015-01-19

Note: All SAR values are normalized to 1W forward power.

8 SAR Test Test Configuration

8.1 GSM Test Configurations

SAR tests for GSM850 and GSM1900, a communication link is set up with a base station by air link. Using CMU200 the power lever is set to “5”and “0” in SAR of GSM850 and GSM1900. The tests in the band of GSM 850 and GSM 1900 are performed in the mode of GPRS/EGPRS function. Since the GPRS class is 12 for this EUT, it has at most 4 timeslots in uplink and at most 4 timeslots in downlink, the maximum total timeslot is 5.

9 Detailed Test Results

9.1 Conducted Power measurements

The output power was measured using an integrated RF connector and attached RF cable.

9.1.1 Conducted Power of GSM850

GSM850(SIM1)		Burst-Averaged output Power (dBm)			Division Factors	Source Based time Average Power(dBm)		
		128CH	190CH	251CH		128CH	190CH	251CH
GSM(CS)		33.26	33.32	33.44	-9.03	24.23	24.29	24.41
GPRS (GMSK)	1 Tx Slot	32.98	33.18	33.28	-9.03	23.95	24.15	24.25
	2 Tx Slots	29.92	29.83	30.14	-6.02	23.90	23.81	24.12
	3 Tx Slots	28.27	28.44	28.51	-4.26	24.01	24.18	24.25
	4 Tx Slots	27.33	27.46	27.45	-3.01	24.32	24.45	24.44

GSM850(SIM2)		Burst-Averaged output Power (dBm)			Division Factors	Source Based time Average Power(dBm)		
		128CH	190CH	251CH		128CH	190CH	251CH
GSM(CS)		33.18	33.27	33.38	-9.03	24.15	24.24	24.35
GPRS (GMSK)	1 Tx Slot	32.79	32.67	32.95	-9.03	23.76	23.64	23.92
	2 Tx Slots	29.97	29.81	30.00	-6.02	23.95	23.79	23.98
	3 Tx Slots	28.26	28.67	28.43	-4.26	24.00	24.41	24.17
	4 Tx Slots	27.08	27.46	27.41	-3.01	24.07	24.45	24.40

Note: 1) The conducted power of GSM850 is measured with RMS detector.

2) Source Based time Average Power was calculated from the measured burst-averaged output power by converting the slot powers into linear units and calculating the energy over 8 timeslots.

3)The bolded GPRS 4Tx slots mode was selected for SAR testing according the highest Source Based time Average Power table.

4) channel /Frequency: 128/824.2; 190/836.6; 251/848.8

5) For Dual SIM Operation, when the power of deviation of SIM1 and SIM2 not more than 0.5dB, which tested SIM1 mode first,and then tested SIM2 mode at the worst position from SIM1 mode .

9.1.2 Conducted Power of GSM1900

GSM1900(SIM1)		Burst-Averaged output Power (dBm)			Division Factors	Source Based time Average Power(dBm)		
		512CH	661CH	810CH		512CH	661CH	810CH
GSM(CS)		30.15	30.14	29.87	-9.03	21.12	21.11	20.84
GPRS (GMSK)	1 Tx Slot	29.92	29.84	29.82	-9.03	20.89	20.81	20.79
	2 Tx Slots	27.13	27.10	27.08	-6.02	21.11	21.08	21.06
	3 Tx Slots	25.32	25.21	25.12	-4.26	21.06	20.95	20.86
	4 Tx Slots	24.38	24.32	24.30	-3.01	21.37	21.31	21.29

GSM1900(SIM2)		Burst-Averaged output Power (dBm)			Division Factors	Source Based time Average Power(dBm)		
		512CH	661CH	810CH		512CH	661CH	810CH
GSM(CS)		30.23	30.20	30.04	-9.03	21.20	21.17	21.01
GPRS (GMSK)	1 Tx Slot	29.93	29.79	29.80	-9.03	20.90	20.76	20.77
	2 Tx Slots	27.19	27.21	27.06	-6.02	21.17	21.19	21.04
	3 Tx Slots	25.24	25.21	25.16	-4.26	20.98	20.95	20.90
	4 Tx Slots	24.31	24.33	24.32	-3.01	21.30	21.32	21.31

Note: 1) The conducted power of GSM1900 is measured with RMS detector.

2) Source Based time Average Power was calculated from the measured burst-averaged output power by converting the slot powers into linear units and calculating the energy over 8 timeslots.

3)The bolded GPRS 4Tx slots mode was selected for SAR testing according the highest Source Based time Average Power table.

4) channel /Frequency: 512/1850.2; 661/1880; 810/1909.8

5) For Dual SIM Operation, when the power of deviation of SIM1 and SIM2 not more than 0.5dB, which tested SIM1 mode first,and then tested SIM2 mode at the worst position from SIM1 mode .

9.1.3 Conducted Power of BT

The maximum output power of BT is:

BT	Average Conducted Power (dBm)		
	0CH	39CH	78CH
	4.21	4.16	4.03

Note: 1) channel /Frequency:0/2402,39/2441,78/2480.

9.2 SAR test results

Notes:

1) Per KDB447498 D01v05 r02, the SAR test shall be performed at the high, middle and low frequency channels of each operating mode. If the scaled SAR measured at mid-band channel for each test configuration is at least 3.0 dB lower than the SAR limit ($< 0.8 \text{ W/kg}$), testing at the high and low channels is optional.

2) Per KDB447498 D01v05r02, testing of other required channels within the operating mode of a frequency band is not required when the reported 1-g or 10-g SAR for the mid-band or highest output power channel is: $\leq 0.8 \text{ W/kg}$ or 2.0 W/kg , for 1-g or 10-g respectively, when the transmission band is $\leq 100 \text{ MHz}$. When the maximum output power variation across the required test channels is $> \frac{1}{2} \text{ dB}$, instead of the middle channel, the highest output power channel must be used.

3) Per KDB447498 D01v05r02, All measurement SAR result is scaled-up to account for tune-up tolerance is compliant.

4) Per KDB648474 D04v01r02, body-worn accessory testing is typically associated with voice operations. Therefore, GSM voice was evaluated for body-worn with headset SAR.

5) Per KDB865664 D01v01r03, for each frequency band, repeated SAR measurement is required only when the measured SAR is $\geq 0.8 \text{ W/Kg}$; if the deviation among the repeated measurement is $\leq 20\%$, and the measured SAR $< 1.45 \text{ W/Kg}$, only one repeated measurement is required.

6) Per KDB865664 D02v01r01, SAR plot is only required for the highest measured SAR in each exposure configuration, wireless mode and frequency band combination; Plots are also required when the measured SAR is $> 1.5 \text{ W/kg}$, or $> 7.0 \text{ W/kg}$ for occupational exposure. The published RF exposure KDB procedures may require additional plots; for example, to support SAR to peak location separation ratio test exclusion and/or volume scan post-processing (Refer to appendix B for details).

7) Per KDB941225 D06v01r01, the DUT Dimension is bigger than $9 \text{ cm} \times 5 \text{ cm}$, so 10 mm is chosen as the test separation distance for Hotspot mode. When the antenna-to-edge distance is greater than 2.5 cm , such position does not need to be tested.

9.2.1 Results overview of GSM850

Test Position of Head	Test channel /Freq.(MHz)	Test Mode	SAR Value (W/kg)		Power Drift (%)	Conducted Power (dBm)	Tune-up Limit (dBm)	Scaled SAR _{1-g} (W/kg)	Liquid Temp.
			1-g	10-g					
Left Hand Touched	190/836.6	GSM	1.073	0.720	2.520	33.320	34.000	1.255	21.2°C
Left Hand Touched	128/824.2	GSM	1.011	0.692	2.890	33.260	34.000	1.199	21.2°C
Left Hand Touched	251/848.8	GSM	1.110	0.735	-1.390	33.670	34.000	1.198	21.2°C
Left Hand Touched Repeated	251/848.8	GSM	1.152	0.754	3.250	33.670	34.000	1.243	21.2°C
Left Hand Tilted 15°	190/836.6	GSM	0.735	0.529	-2.610	33.320	34.000	0.860	21.2°C
Right Hand Touched	190/836.6	GSM	1.094	0.722	0.730	33.320	34.000	1.279	21.2°C
Right Hand Touched	128/824.2	GSM	1.034	0.689	-1.370	33.260	34.000	1.226	21.2°C
Right Hand Touched	251/848.8	GSM	1.051	0.719	-1.520	33.670	34.000	1.134	21.2°C
Right Hand Touched Repeated	190/836.6	GSM	1.103	0.722	-0.090	33.320	34.000	1.290	21.2°C
Right Hand Tilted 15°	190/836.6	GSM	0.661	0.455	-3.720	33.320	34.000	0.773	21.2°C
Test the SIM2 Card Slot at the Worst Case Position of SIM1 Card Slot									
Left Hand Touched	251/848.8	GSM	1.039	0.692	-4.260	33.380	34.000	1.198	21.2°C
Test the SIM2 Card Slot at the Worst Case Position of SIM1 Card Slot									
Test Position of Body with 15mm	Test channel /Freq.(MHz)	Test Mode	SAR Value (W/kg)		Power Drift (%)	Conducted Power (dBm)	Tune-up Limit (dBm)	Scaled SAR _{1-g} (W/kg)	Liquid Temp.
			1-g	10-g					
Towards Phantom	190/836.6	GPRS 4TS	0.640	0.431	-0.380	27.460	28.000	0.725	21.2°C
Towards Ground	190/836.6	GPRS 4TS	0.930	0.612	-0.970	27.460	28.000	1.053	21.2°C
Towards Ground	128/824.2	GPRS 4TS	0.879	0.574	0.450	27.330	28.000	1.026	21.2°C
Towards Ground	251/848.8	GPRS 4TS	0.914	0.595	3.240	27.450	28.000	1.037	21.2°C
Towards Ground Repeated	190/836.6	GPRS 4TS	1.011	0.705	-3.300	27.460	28.000	1.145	21.2°C
Test the SIM2 Card Slot at the Worst Case Position of SIM1 Card Slot									
Towards Ground	190/836.6	GPRS 4TS	0.946	0.668	0.310	27.460	28.000	1.071	21.2°C
Towards Ground with Headset	190/836.6	GSM	0.768	0.521	-3.960	33.320	34.000	0.898	21.2°C

9.2.2 Results overview of GSM1900

Test Position of Head	Test channel /Freq.(MHz)	Test Mode	SAR Value (W/kg)		Power Drift (%)	Conducted Power (dBm)	Tune-up Limit (dBm)	Scaled SAR _{1-g} (W/kg)	Liquid Temp.
			1-g	10-g					
Left Hand Touched	661/1880	GSM	0.580	0.309	-2.760	30.140	31.000	0.707	21.2°C
Left Hand Tilted 15°	661/1880	GSM	0.508	0.272	1.390	30.140	31.000	0.619	21.2°C
Right Hand Touched	661/1880	GSM	0.665	0.364	0.170	30.140	31.000	0.798	21.2°C
Right Hand Tilted 15°	661/1880	GSM	0.464	0.258	2.470	30.140	31.000	0.566	21.2°C
Test the SIM2 Card Slot at the Worst Case Position of SIM1 Card Slot									
Right Hand Touched	661/1880	GSM	0.647	0.357	-0.700	30.200	31.000	0.778	21.2°C
Test Position of Body with 15mm	Test channel /Freq.(MHz)	Test Mode	SAR Value (W/kg)		Power Drift (%)	Conducted Power (dBm)	Tune-up Limit (dBm)	Scaled SAR _{1-g} (W/kg)	Liquid Temp.
			1-g	10-g					
Towards Phantom	661/1880	GPRS 4TS	0.482	0.276	-0.190	24.320	25.000	0.564	21.2°C
Towards Ground	661/1880	GPRS 4TS	0.538	0.312	2.600	24.320	25.000	0.629	21.2°C
Test the SIM2 Card Slot at the Worst Case Position of SIM1 Card Slot									
Towards Ground	661/1880	GPRS 4TS	0.508	0.294	1.560	24.330	25.000	0.593	21.2°C
Towards Ground with Headset	661/1880	GSM	0.220	0.137	-2.050	30.140	31.000	0.268	21.2°C

10 Multiple Transmitter Information

10.1.1 Stand-alone SAR test exclusion

The 1-g and 10-g SAR test exclusion thresholds for 100 MHz to 6 GHz at test separation distances \leq 50 mm are determined by:

$[(\text{max. power of channel, including tune-up tolerance, mW})/(\text{min. test separation distance, mm})] \cdot [\sqrt{f(\text{GHz})}] \leq 3.0$ for 1-g SAR and ≤ 7.5 for 10-g extremity SAR, where

- $f(\text{GHz})$ is the RF channel transmit frequency in GHz
- Power and distance are rounded to the nearest mW and mm before calculation
- The result is rounded to one decimal place for comparison

When the minimum test separation distance is < 5 mm, a distance of 5 mm is applied to determine SAR test exclusion.

a) Head position

Mode	Pmax(dBm)	Pmax(mW)	Distance(mm)	f(GHz)	Calculation Result	exclusion Threshold	SAR test exclusion
BT	4.5	2.82	5.00	2.450	0.88	3.00	Yes

b) Body-Worn position

Mode	Pmax(dBm)	Pmax(mW)	Distance(mm)	f(GHz)	Calculation Result	exclusion Threshold	SAR test exclusion
BT	4.5	2.82	15.00	2.450	0.29	3.00	Yes

When the standalone SAR test exclusion applies to an antenna that transmits simultaneously with other antennas, the standalone SAR must be estimated according to the following to determine simultaneous transmission SAR test exclusion

$(\text{max. power of channel, including tune-up tolerance, mW}) / (\text{min. test separation distance, mm}) \cdot [\sqrt{f(\text{GHz})} / x]$ W/kg for test separation distances ≤ 50 mm, where $x = 7.5$ for 1-g SAR.

When the minimum test separation distance is < 5 mm, a distance of 5 mm is applied to determine SAR test exclusion.

Mode	Position	Pmax(dBm)	Pmax(mW)	Distance(mm)	f(GHz)	X	Estimated SAR(W/Kg)
BT	Head	4.50	2.82	5.00	2.45	7.50	0.118
BT	Body	4.50	2.82	15.00	2.45	7.50	0.039

10.1.2 Simultaneous Transmission Possibilities

The Simultaneous Transmission Possibilities are as below:

Simultaneous Transmission Possibilities			
Simultaneous Tx Combination	Configuration	Head	Body
1	GSM/GPRS +BT	YES	YES

10.1.3 SAR Summation Scenario

Test Position		Scaled SAR _{Max}		Σ _{1-g} SAR	SPLSP
		GSM850	BT		
Head	Left Hand Touched	1.255	0.118	1.373	NA
	Left Hand Tilted 15°	0.860	0.118	0.978	NA
	Right Hand Touched	1.290	0.118	1.408	NA
	Right Hand Tilted 15°	0.773	0.118	0.891	NA
Body	Towards Phantom	1.145	0.039	1.184	NA
	Towards Ground	0.725	0.039	0.764	NA

Note: Simultaneous Tx Combination of GSM850 and BT

Test Position		Scaled SAR _{Max}		Σ _{1-g} SAR	SPLSP
		GSM1900	BT		
Head	Left Hand Touched	0.707	0.118	0.825	NA
	Left Hand Tilted 15°	0.619	0.118	0.737	NA
	Right Hand Touched	0.811	0.118	0.929	NA
	Right Hand Tilted 15°	0.566	0.118	0.684	NA
Body	Towards Phantom	0.564	0.039	0.603	NA
	Towards Ground	0.629	0.039	0.668	NA

Note: Simultaneous Tx Combination of GSM1900 and BT

MAX.ΣSAR_{1g}=1.408W/kg<1.6 W/kg, so the Simultaneous SAR is not required for BT and GSM antenna.

11 Measurement uncertainty evaluation

11.1 Measurement uncertainty evaluation for SAR test

The following table includes the uncertainty table of the IEEE 1528. The values are determined by Satimo. The breakdown of the individual uncertainties is as follows:

Measurement Uncertainty evaluation for SAR test								
Uncertainty Component	Tol. (±%)	Prob. Dist.	Div.	C _i (1g)	C _i (10g)	1g U _i (±%)	10g U _i (±%)	V _i
measurement system								
Probe Calibration	5.8	N	1	1	1	5.8	5.8	∞
Axial Isotropy	3.5	R	$\sqrt{3}$	$(1-C_p)^{1/2}$	$(1-C_p)^{1/2}$	1.43	1.43	∞
Hemispherical Isotropy	5.9	R	$\sqrt{3}$	$\sqrt{C_p}$	$\sqrt{C_p}$	2.41	2.41	∞
Boundary Effect	1	R	$\sqrt{3}$	1	1	0.58	0.58	∞
Linearity	4.7	R	$\sqrt{3}$	1	1	2.71	2.71	∞
system Detection Limits	1	R	$\sqrt{3}$	1	1	0.58	0.58	∞
Modulation response	3	N	1	1	1	3.00	3.00	∞
Readout Electronics	0.5	N	1	1	1	0.50	0.50	∞
Response Time	0	R	$\sqrt{3}$	1	1	0.00	0.00	∞
Integration Time	1.4	R	$\sqrt{3}$	1	1	0.81	0.81	∞
RF Ambient Conditions-Noise	3	R	$\sqrt{3}$	1	1	1.73	1.73	∞
RF Ambient Conditions-Reflections	3	R	$\sqrt{3}$	1	1	1.73	1.73	∞
Probe Positioner Mechanical Tolerance	1.4	R	$\sqrt{3}$	1	1	0.81	0.81	∞
Probe positioning with respect to Phantom Shell	1.4	R	$\sqrt{3}$	1	1	0.81	0.81	∞
Extrapolation, interpolation and Integration Algorithms for Max.SAR Evaluation	2.3	R	$\sqrt{3}$	1	1	1.33	1.33	∞
Test sample Related								
Test Sample Positioning	2.6	N	1	1	1	2.60	2.60	11
Device Holder Uncertainty	3	N	1	1	1	3.00	3.00	7
Output Power Variation-SAR drift measurement	5	R	$\sqrt{3}$	1	1	2.89	2.89	∞
SAR scaling	2	R	$\sqrt{3}$	1	1	1.15	1.15	∞
Phantom and Tissue Parameters								
Phantom Uncertainty (shape and thickness tolerances)	4	R	$\sqrt{3}$	1	1	2.31	2.31	∞
Uncertainty in SAR correction for deviation (in permittivity and conductivity)	2	N	1	1	0.84	2.00	1.68	∞
Liquid conductivity (meas.)	2.5	N	1	0.64	0.43	1.60	1.08	5
Liquid conductivity (target.)	5	R	$\sqrt{3}$	0.64	0.43	1.85	1.24	5
Liquid Permittivity (meas.)	2.5	N	1	0.60	0.49	1.50	1.23	∞
Liquid Permittivity (target.)	5	R	$\sqrt{3}$	0.60	0.49	1.73	1.42	∞
Combined Standard Uncertainly		Rss				10.63	10.54	
Expanded Uncertainty{95% CONFIDENCE INTERVAL}		k				21.26	21.08	

11.2 Measurement uncertainty evaluation for system check

The following table includes the uncertainty table of the IEEE 1528. The values are determined by Satimo. The breakdown of the individual uncertainties is as follows:

Uncertainty For System Performance Check								
Uncertainty Component	Tol. (±%)	Prob. Dist.	Div.	C _i 1g	C _i 10g	1g U _i (±%)	10g U _i (±%)	V _i
measurement system								
Probe Calibration	5.8	N	1	1	1	5.80	5.80	∞
Axial Isotropy	3.5	R	$\sqrt{3}$	$(1-C_p)^{1/2}$	$(1-C_p)^{1/2}$	1.43	1.43	∞
Hemispherical Isotropy	5.9	R	$\sqrt{3}$	$\sqrt{C_p}$	$\sqrt{C_p}$	2.41	2.41	∞
Boundary Effect	1	R	$\sqrt{3}$	1	1	0.58	0.58	∞
Linearity	4.7	R	$\sqrt{3}$	1	1	2.71	2.71	∞
system detection Limits	1	R	$\sqrt{3}$	1	1	0.58	0.58	∞
Modulation response	0	N	1	1	1	0.00	0.00	∞
Readout Electronics	0.5	N	1	1	1	0.50	0.50	∞
Response Time	0	R	$\sqrt{3}$	1	1	0.00	0.00	∞
Integration Time	1.4	R	$\sqrt{3}$	1	1	0.81	0.81	∞
RF ambient Conditions - Noise	3	R	$\sqrt{3}$	1	1	1.73	1.73	∞
RF ambient Conditions – Reflections	3	R	$\sqrt{3}$	1	1	1.73	1.73	∞
Probe positioned Mechanical Tolerance	1.4	R	$\sqrt{3}$	1	1	0.81	0.81	∞
Probe positioning with respect to Phantom Shell	1.4	R	$\sqrt{3}$	1	1	0.81	0.81	∞
Extrapolation, interpolation and integration Algorithms for Max. SAR Evaluation	2.3	R	$\sqrt{3}$	1	1	1.33	1.33	∞
Dipole								
Deviation of experimental source from numerical source	4	N	1	1	1	4.00	4.00	∞
Input power and SAR drift measurement	5	R	$\sqrt{3}$	1	1	2.89	2.89	∞
Dipole axis to liquid Distance	2	R	$\sqrt{3}$	1	1	1.16	1.16	∞
Phantom and Tissue Parameters								
Phantom Uncertainty (shape and thickness tolerances)	4	R	$\sqrt{3}$	1	1	2.31	2.31	∞
Uncertainty in SAR correction for deviation (in permittivity and conductivity)	2	N	1	1	0.84	2.00	1.68	∞
Liquid conductivity (meas.)	2.5	N	1	0.64	0.43	1.60	1.08	5
Liquid conductivity (target.)	5	R	$\sqrt{3}$	0.64	0.43	1.85	1.24	5
Liquid Permittivity (meas.)	2.5	N	1	0.60	0.49	1.50	1.23	∞
Liquid Permittivity (target.)	5	R	$\sqrt{3}$	0.60	0.49	1.73	1.41	∞
Combined Standard Uncertainty		Rss				10.28	9.98	
Expanded Uncertainty (95% Confidence interval)		k				20.57	19.95	

12 Test equipment and ancillaries used for tests

To simplify the identification of the test equipment and/or ancillaries which were used, the reporting of the relevant test cases only refer to the test item number as specified in the table below.

	Manufacturer	Device Type	Type(Model)	Serial number	calibration	
					Last Cal.	Due Date
<input checked="" type="checkbox"/>	SATIMO	COMOSAR DOSIMETRIC E FIELD PROBE	SSE5	SN 09/13 EP170	2014-05-07	2015-05-06
<input checked="" type="checkbox"/>	SATIMO	COMOSAR 835 MHz REFERENCE DIPOLE	SID835	SN 14/13 DIP0G835-235	2014-05-07	2015-05-06
<input type="checkbox"/>	SATIMO	COMOSAR 900 MHz REFERENCE DIPOLE	SID900	SN 14/13 DIP0G900-231	2014-05-07	2015-05-06
<input type="checkbox"/>	SATIMO	COMOSAR 1800 MHz REFERENCE DIPOLE	SID1800	SN 14/13 DIP1G800-232	2014-05-07	2015-05-06
<input checked="" type="checkbox"/>	SATIMO	COMOSAR 1900 MHz REFERENCE DIPOLE	SID1900	SN 14/13 DIP1G900-236	2014-05-07	2015-05-06
<input type="checkbox"/>	SATIMO	COMOSAR 2000 MHz REFERENCE DIPOLE	SID2000	SN 14/13 DIP2G000-237	2014-05-07	2015-05-06
<input type="checkbox"/>	SATIMO	COMOSAR 2450 MHz REFERENCE DIPOLE	SID2450	SN 14/13 DIP2G450-238	2014-05-07	2015-05-06
<input type="checkbox"/>	SATIMO	COMOSAR 2600 MHz REFERENCE DIPOLE	SID2600	SN 28/14 DIP2G600-327	2014-07-10	2015-07-09
<input checked="" type="checkbox"/>	SATIMO	Software	OPENSAR	N/A	N/A	N/A
<input checked="" type="checkbox"/>	SATIMO	Phantom	COMOSAR IEEE SAM PHANTOM	SN 14/13 SAM99	N/A	N/A
<input checked="" type="checkbox"/>	R & S	Universal Radio Communication Tester	CMU 200	117528	2014-08-19	2015-08-18
<input checked="" type="checkbox"/>	HP	Network Analyser	8753D	3410A08889	2014-08-19	2015-08-18
<input checked="" type="checkbox"/>	HP	Signal Generator	E4421B	GB39340770	2014-08-19	2015-08-18
<input checked="" type="checkbox"/>	Keithley	Multimeter	Keithley 2000	4014539	2014-08-19	2015-08-18
<input checked="" type="checkbox"/>	SATIMO	Amplifier	Power Amplifier	MODU-023-A-0004	2014-10-13	2015-10-12
<input checked="" type="checkbox"/>	Agilent	Power Meter	E4418B	GB43312909	2014-10-13	2015-10-12
<input checked="" type="checkbox"/>	Agilent	Power Meter Sensor	E4412A	MY41500046	2014-10-13	2015-10-12
<input checked="" type="checkbox"/>	Agilent	Power Meter	E4417A	GB41291826	2014-10-13	2015-10-12
<input checked="" type="checkbox"/>	Agilent	Power Meter Sensor	8481H	MY41091215	2014-10-13	2015-10-12

Annex A: System performance verification

(Please See the SAR Measurement Plots of annex A.)

Annex B: Measurement results

(Please See the SAR Measurement Plots of annex B.)

Annex C: Calibration reports

(Please See the Calibration reports of annex C.)

Annex D: Photo documentation

Photo 1: Measurement System OPENSAR

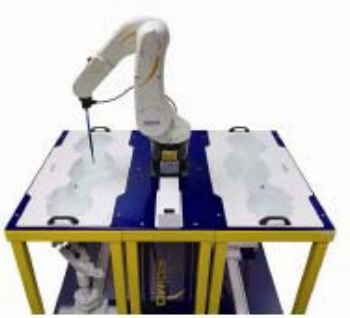

Photo 2: Front view

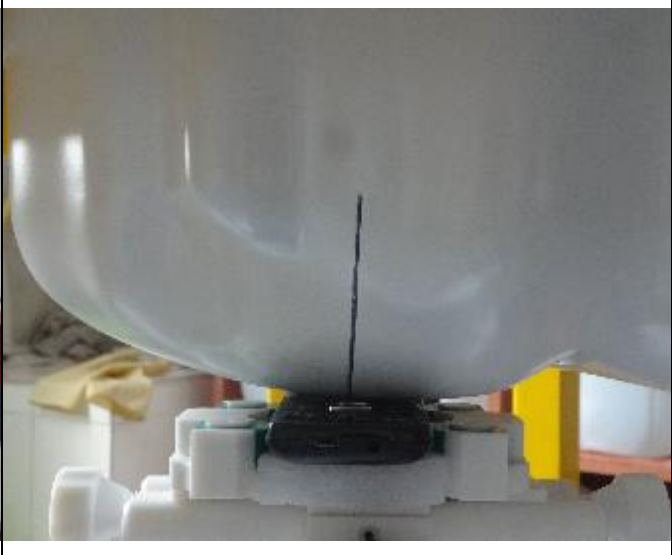



Photo 3: Rear View



Photo 4: Left Hand Touched



Photo 5: Left Hand Tilted 15°	Photo 6: Right Hand Touched
 A photograph showing a white anthropomorphic hand model holding a black mobile phone. The hand is tilted to the left at a 15-degree angle. The phone is held in the palm, and the fingers are wrapped around it. The background shows a laboratory setting with white and yellow equipment.	 A photograph showing a white anthropomorphic hand model holding a black mobile phone. The hand is held in a neutral, slightly flexed position. The phone is held in the palm. The background shows a laboratory setting with white and yellow equipment.
Photo 7: Right Hand Tilted 15°	Photo 8: Towards Phantom 5mm
 A photograph showing a white anthropomorphic hand model holding a black mobile phone. The hand is tilted to the right at a 15-degree angle. The phone is held in the palm. The background shows a laboratory setting with white and yellow equipment.	 A photograph showing a white anthropomorphic hand model holding a black mobile phone. The hand is held in a neutral position, but the phone is positioned very close to the hand, specifically towards the phantom (the hand model). The background shows a laboratory setting with white and yellow equipment.

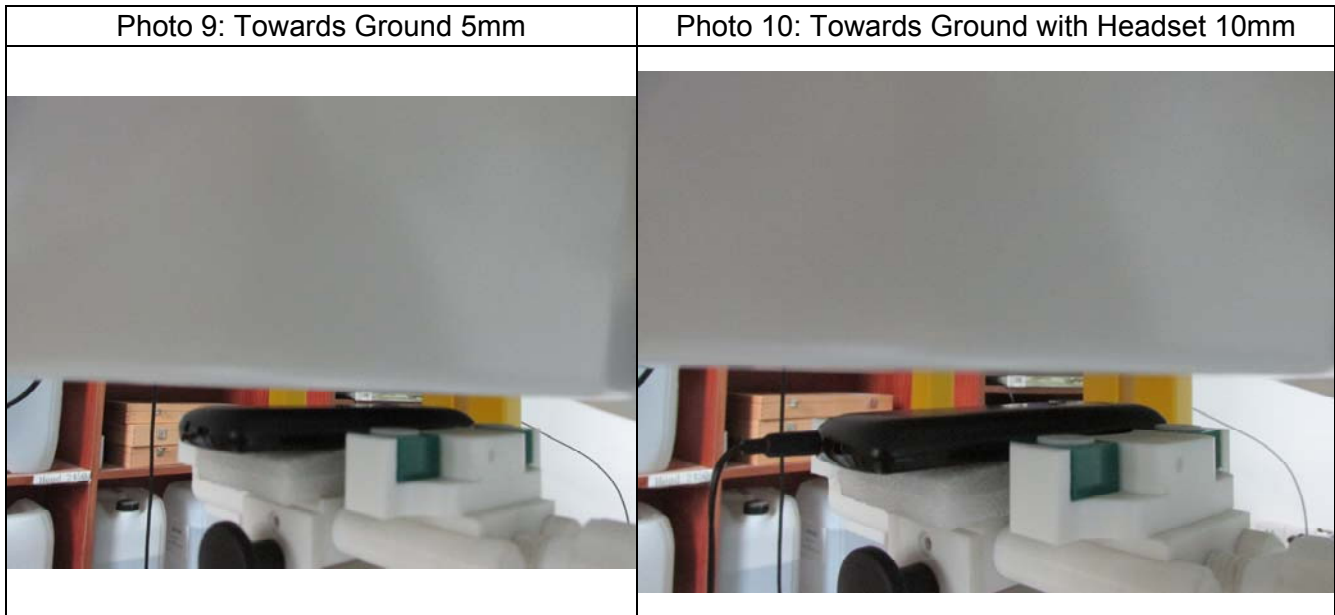



Photo 101: Liquid Depth $\geq 15.0\text{cm}$



End

	Annex A: System Performance Verification
	Project Name :T463
	Report Number: FCC15016713-2

I. RESULTS

<u>TYPE</u>	<u>BAND</u>	<u>PARAMETERS</u>
Validation	CW835	<u>Measurement 1:</u> Validation Plane with Dipole device position on Middle Channel in CW mode
Validation	CW835	<u>Measurement 2:</u> Validation Plane with Dipole device position on Middle Channel in CW mode
Validation	CW1900	<u>Measurement 3:</u> Validation Plane with Dipole device position on Middle Channel in CW mode
Validation	CW1900	<u>Measurement 4:</u> Validation Plane with Dipole device position on Middle Channel in CW mode

MEASUREMENT 1

Verification_with_Head_liquid

Type: Validation measurement (Complete)

Date of measurement: 16/1/2015

Measurement duration: 12 minutes 19 seconds

A. Experimental conditions.

<u>Area Scan</u>	<u>dx=8mm dy=8mm</u>
<u>ZoomScan</u>	<u>5x5x7, dx=8mm dy=8mm</u> <u>dz=5mm, Complete</u>
<u>Phantom</u>	<u>Validation plane</u>
<u>Device Position</u>	<u>Dipole</u>
<u>Band</u>	<u>CW835</u>
<u>Channels</u>	<u>Middle</u>
<u>Signal</u>	<u>CW (Crest factor: 1.0)</u>

B. Instrumentations.

Equipment description	Manufacturer/Model	Identification No.	Current calibration date	Next calibration date
SAR Probe	SATIMO	SN_0913_EP1 70/nCF: 5.64	5/2014	5/2015

C. SAR Measurement Results

Middle Band SAR (Channel -1):

Frequency (MHz)	835.000000
Relative permittivity (real part)	41.502300
Relative permittivity (imaginary part)	19.419001
Conductivity (S/m)	0.900826
Variation (%)	0.070000

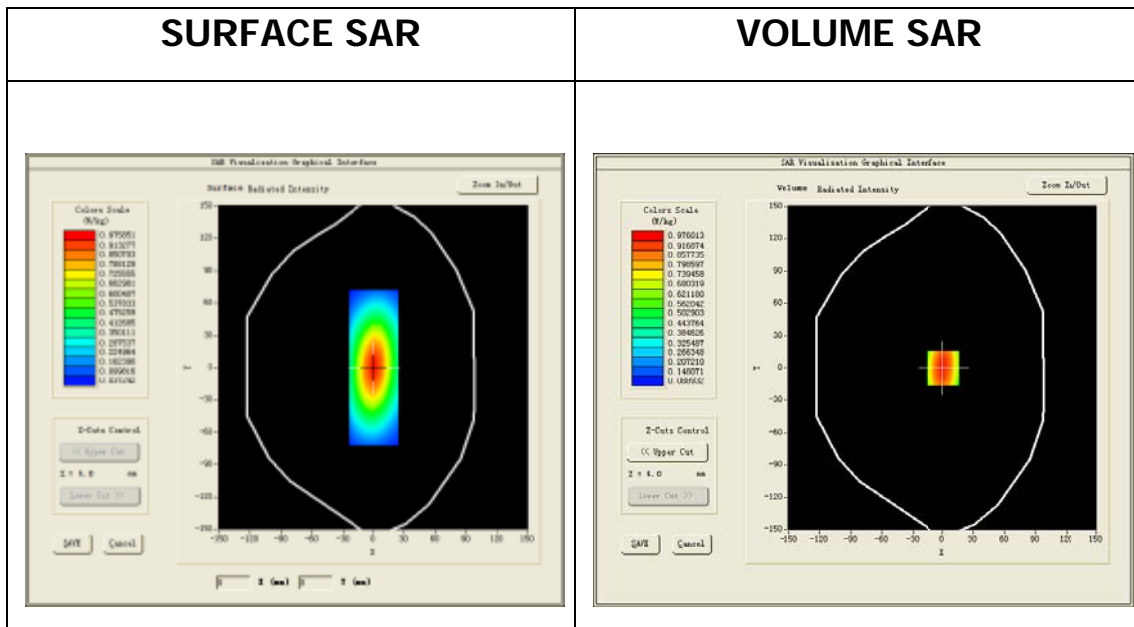



Maximum location: X=0.00, Y=0.00

SAR Peak: 1.34 W/kg

SAR 10g (W/Kg)	0.609821
SAR 1g (W/Kg)	0.936451

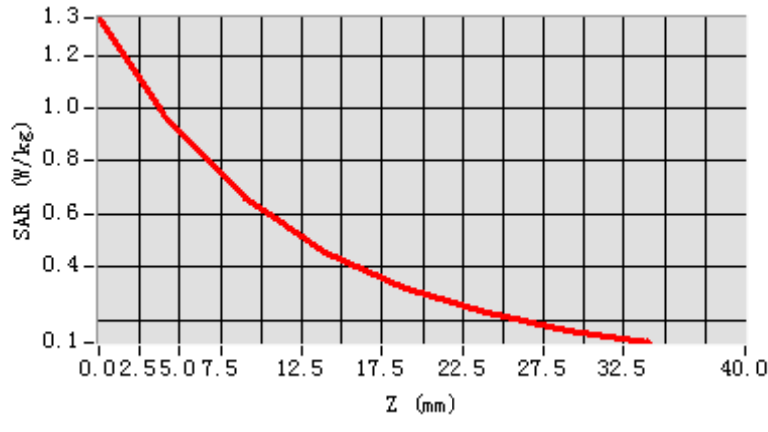
Z (mm)	0.00	4.00	9.00	14.00	19.00	24.00	29.00
SAR (W/Kg)	1.3421	0.9760	0.6587	0.4548	0.3177	0.2240	0.1591

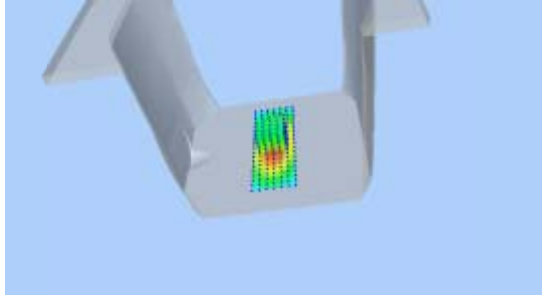

3D screen shot	Hot spot position
	

MEASUREMENT 2

Verification_with_Body_liquid

Type: Validation measurement (Complete)

Date of measurement: 16/1/2015

Measurement duration: 12 minutes 18 seconds

A. Experimental conditions.

<u>Area Scan</u>	<u>dx=8mm dy=8mm</u>
<u>ZoomScan</u>	<u>5x5x7, dx=8mm dy=8mm</u> <u>dz=5mm, Complete</u>
<u>Phantom</u>	<u>Validation plane</u>
<u>Device Position</u>	<u>Dipole</u>
<u>Band</u>	<u>CW835</u>
<u>Channels</u>	<u>Middle</u>
<u>Signal</u>	<u>CW (Crest factor: 1.0)</u>

B. Instrumentations.

Equipment description	Manufacturer/Model	Identification No.	Current calibration date	Next calibration date
SAR Probe	SATIMO	SN_0913_EP1 70/nCF: 5.86	5/2014	5/2015

C. SAR Measurement Results

Middle Band SAR (Channel -1):

Frequency (MHz)	835.000000
Relative permittivity (real part)	54.375099
Relative permittivity (imaginary part)	20.985201
Conductivity (S/m)	0.973480
Variation (%)	0.650000

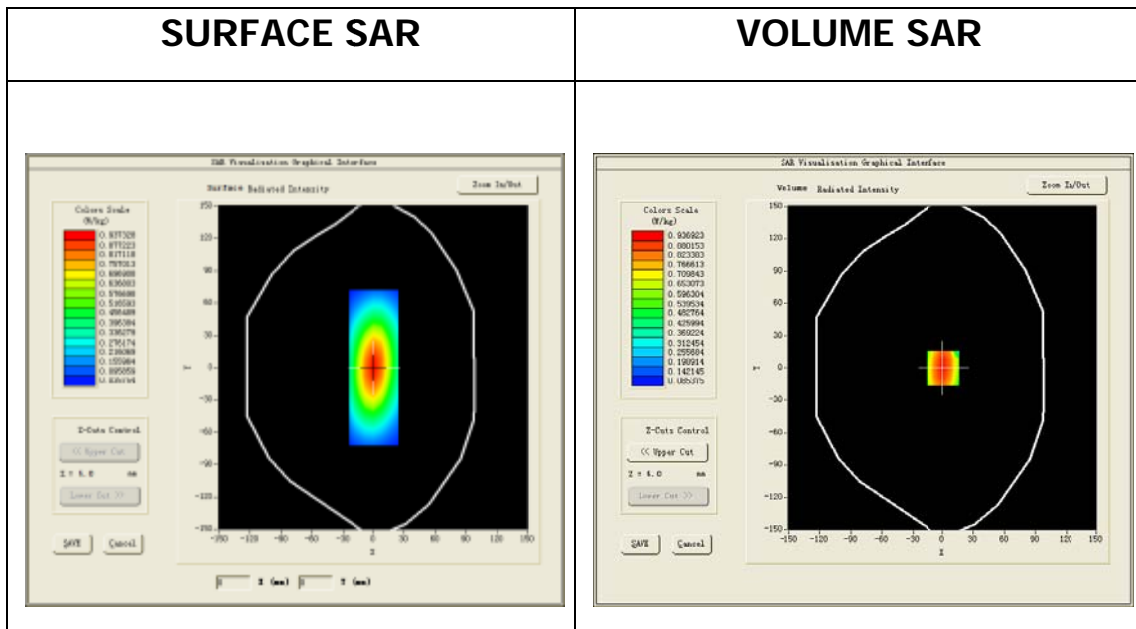



Maximum location: X=0.00, Y=0.00

SAR Peak: 1.41 W/kg

SAR 10g (W/Kg)	0.650753
SAR 1g (W/Kg)	0.997771

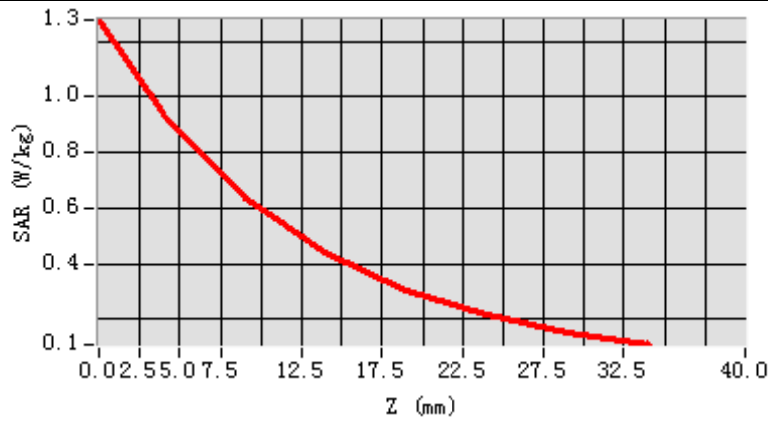
Z (mm)	0.00	4.00	9.00	14.00	19.00	24.00	29.00
SAR (W/Kg)	1.2772	0.9369	0.6371	0.4386	0.3063	0.2157	0.1530

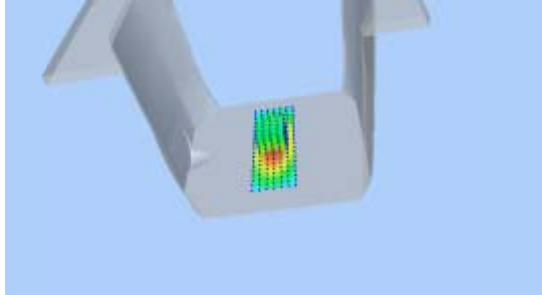

3D screen shot	Hot spot position
	

MEASUREMENT 3

Verification_with_Head_liquid

Type: Validation measurement (Complete)

Date of measurement: 19/1/2015

Measurement duration: 11 minutes 35 seconds

A. Experimental conditions.

<u>Area Scan</u>	<u>dx=8mm dy=8mm</u>
<u>ZoomScan</u>	<u>5x5x7, dx=8mm dy=8mm</u> <u>dz=5mm, Complete</u>
<u>Phantom</u>	<u>Validation plane</u>
<u>Device Position</u>	<u>Dipole</u>
<u>Band</u>	<u>CW1900</u>
<u>Channels</u>	<u>Middle</u>
<u>Signal</u>	<u>CW (Crest factor: 1.0)</u>

B. Instrumentations.

Equipment description	Manufacturer/Model	Identification No.	Current calibration date	Next calibration date
SAR Probe	SATIMO	SN_0913_EP1 70/nCF: 5.26	5/2014	5/2015

C. SAR Measurement Results

Middle Band SAR (Channel -1):

Frequency (MHz)	1900.000000
Relative permittivity (real part)	40.000999
Relative permittivity (imaginary part)	13.258200
Conductivity (S/m)	1.399477
Variation (%)	1.060000

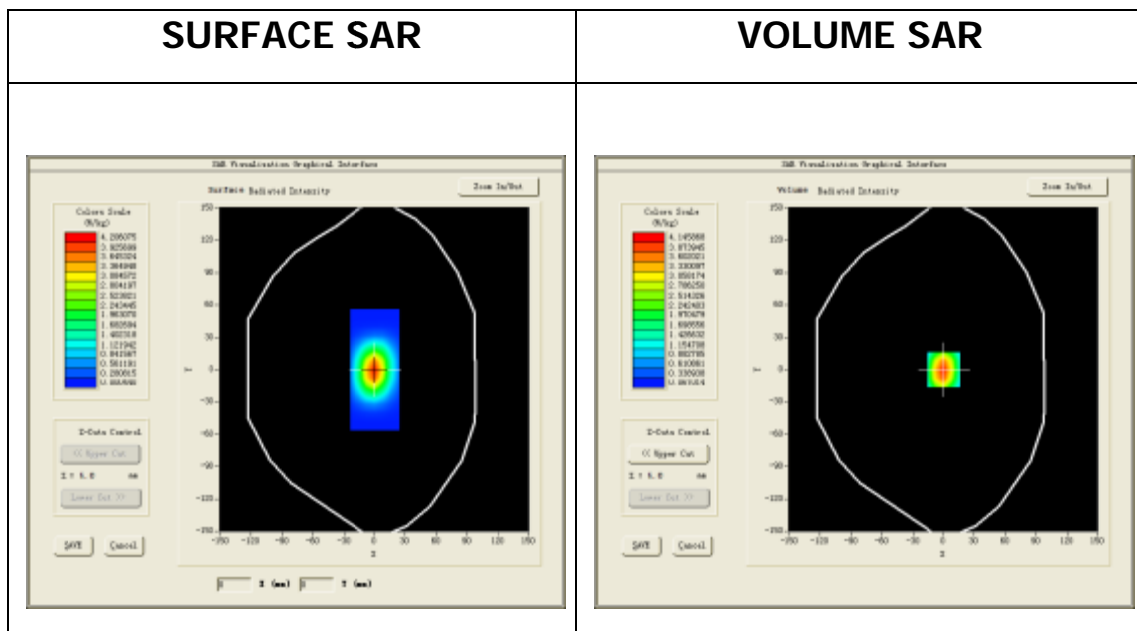

Maximum location: X=0.00, Y=0.00

SAR Peak: 6.47 W/kg

SAR 10g (W/Kg)	2.026713
SAR 1g (W/Kg)	3.903555

Z (mm)	0.00	4.00	9.00	14.00	19.00	24.00	29.00
SAR (W/Kg)	6.5156	4.1459	2.3061	1.3328	0.7763	0.4560	0.2705

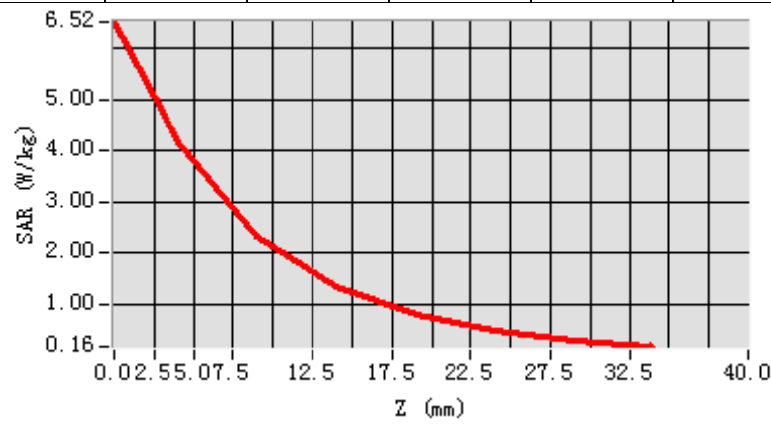

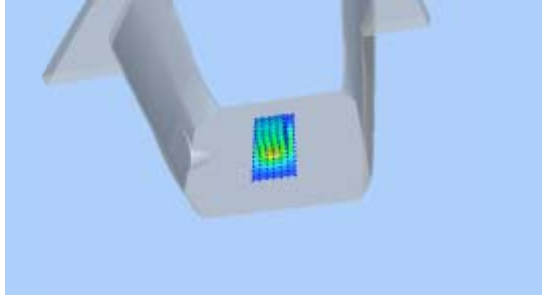
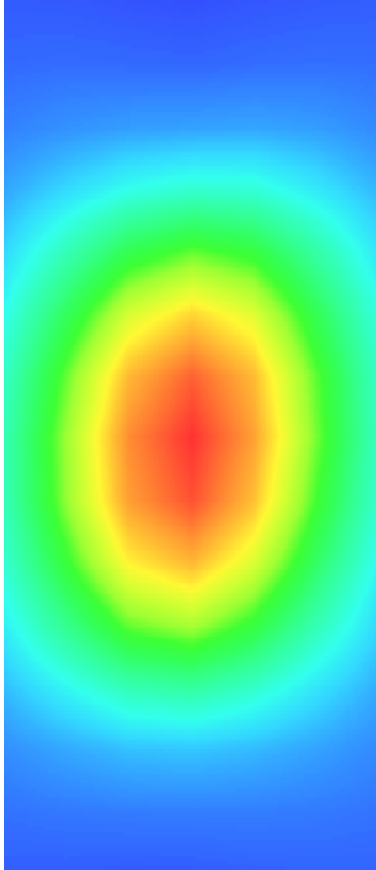
3D screen shot	Hot spot position
	

MEASUREMENT 4

Verification_with_Body_liquid

Type: Validation measurement (Complete)

Date of measurement: 19/1/2015

Measurement duration: 11 minutes 21 seconds

A. Experimental conditions.

<u>Area Scan</u>	<u>dx=8mm dy=8mm</u>
<u>ZoomScan</u>	<u>5x5x7, dx=8mm dy=8mm</u> <u>dz=5mm, Complete</u>
<u>Phantom</u>	<u>Validation plane</u>
<u>Device Position</u>	<u>Dipole</u>
<u>Band</u>	<u>CW1900</u>
<u>Channels</u>	<u>Middle</u>
<u>Signal</u>	<u>CW (Crest factor: 1.0)</u>

B. Instrumentations.

Equipment description	Manufacturer/Model	Identification No.	Current calibration date	Next calibration date
SAR Probe	SATIMO	SN_0913_EP1 70/nCF: 5.41	5/2014	5/2015

C. SAR Measurement Results

Middle Band SAR (Channel -1):

Frequency (MHz)	1900.000000
Relative permittivity (real part)	53.308899
Relative permittivity (imaginary part)	14.399800
Conductivity (S/m)	1.519979
Variation (%)	-0.050000

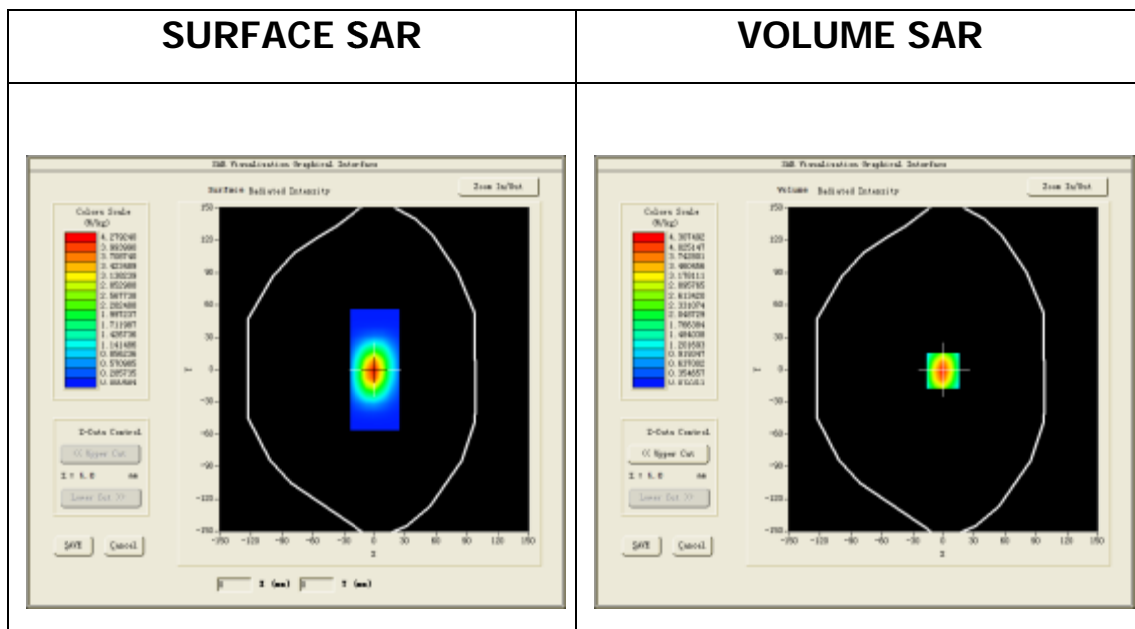

Maximum location: X=-1.00, Y=-1.00

SAR Peak: 7.25 W/kg

SAR 10g (W/Kg)	2.239348
SAR 1g (W/Kg)	4.369623

Z (mm)	0.00	4.00	9.00	14.00	19.00	24.00	29.00
SAR (W/Kg)	6.7295	4.3075	2.4157	1.3965	0.8174	0.4810	0.2857

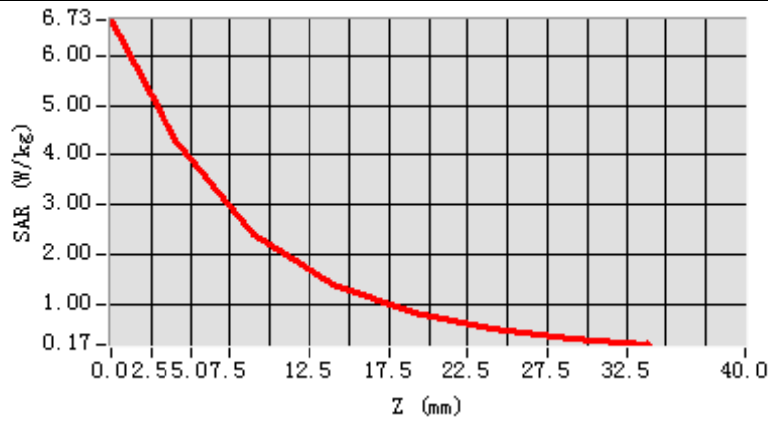

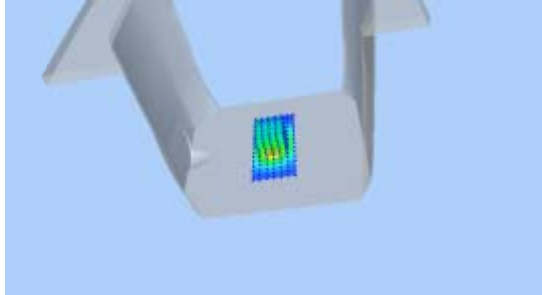
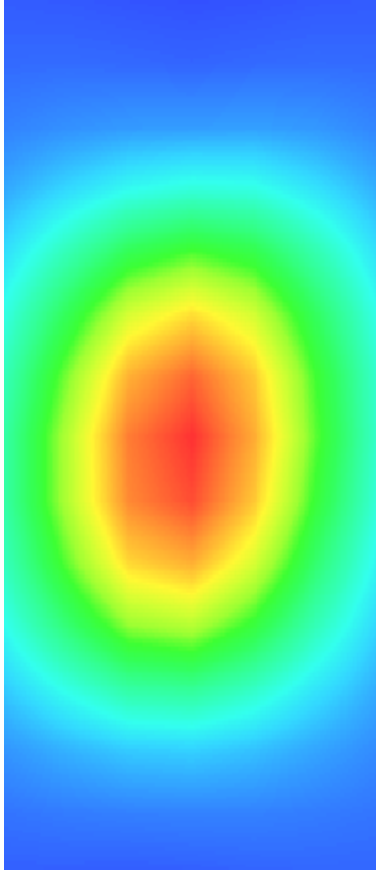
3D screen shot	Hot spot position
	

	Annex B: Measurement Results
	Project Name : T463
	Report Number: FCC15016713-2

I. RESULTS

<u>TYPE</u>	<u>BAND</u>	<u>PARAMETERS</u>
Phone	GSM850	<u>Measurement 1:</u> Right Head with Cheek device position on Middle Channel in GSM mode
Phone	GSM1900	<u>Measurement 2:</u> Right Head with Cheek device position on Middle Channel in GSM mode
Phone	CUSTOM	<u>Measurement 3:</u> Validation Plane with Body device position (band GPRS850_4Tx)
Phone	CUSTOM	<u>Measurement 4:</u> Validation Plane with Body device position (band GPRS1900_4Tx)

MEASUREMENT 1

Right_head_cheek_with_repeated

Type: Phone measurement (Complete)

Date of measurement: 17/1/2015

Measurement duration: 8 minutes 31 seconds

A. Experimental conditions.

<u>Area Scan</u>	<u>dx=15mm dy=15mm</u>
<u>ZoomScan</u>	<u>5x5x7, dx=8mm dy=8mm</u> <u>dz=5mm, Complete</u>
<u>Phantom</u>	<u>Right head</u>
<u>Device Position</u>	<u>Cheek</u>
<u>Band</u>	<u>GSM850</u>
<u>Channels</u>	<u>Middle</u>
<u>Signal</u>	<u>TDMA (Crest factor: 8.0)</u>

B. Instrumentations.

Equipment description	Manufacturer/Model	Identification No.	Current calibration date	Next calibration date
SAR Probe	SATIMO	SN_0913_EP1 70/nCF: 5.64	5/2014	5/2015

C. SAR Measurement Results

Middle Band SAR (Channel 190):

Frequency (MHz)	836.599976
Relative permittivity (real part)	41.464142
Relative permittivity (imaginary part)	19.416460
Conductivity (S/m)	0.902434
Variation (%)	-0.090000

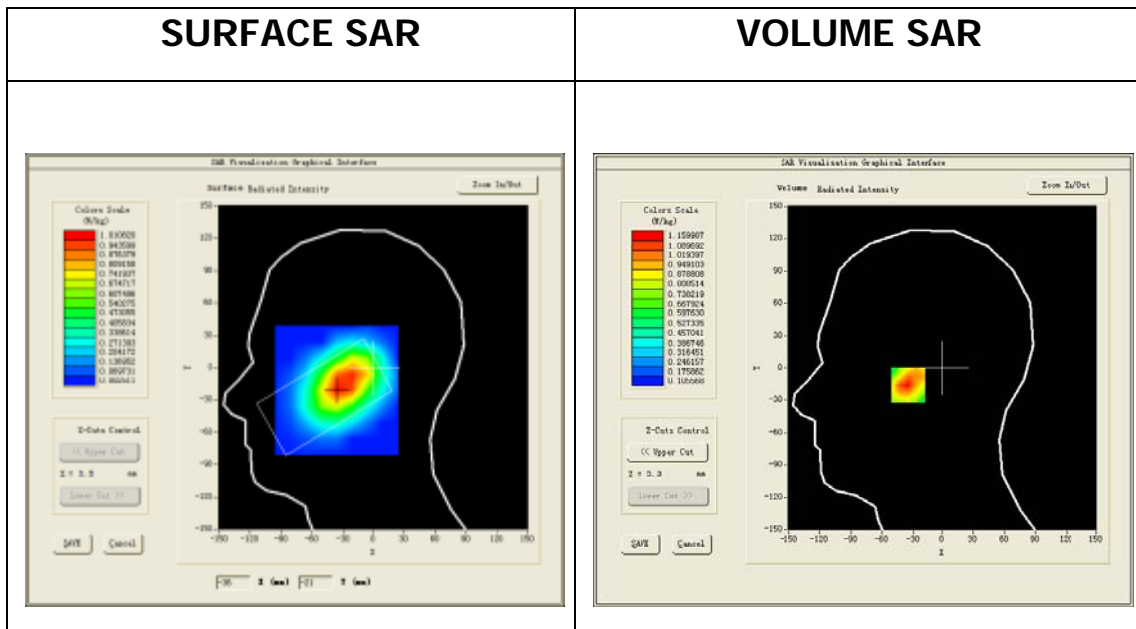

Maximum location: X=-30.00, Y=-16.00

SAR Peak: 1.64 W/kg

SAR 10g (W/Kg)	0.722188
SAR 1g (W/Kg)	1.103203

Z (mm)	0.00	4.00	9.00	14.00	19.00	24.00	29.00
SAR (W/Kg)	1.6408	1.1600	0.8157	0.5936	0.4923	0.3757	0.2751

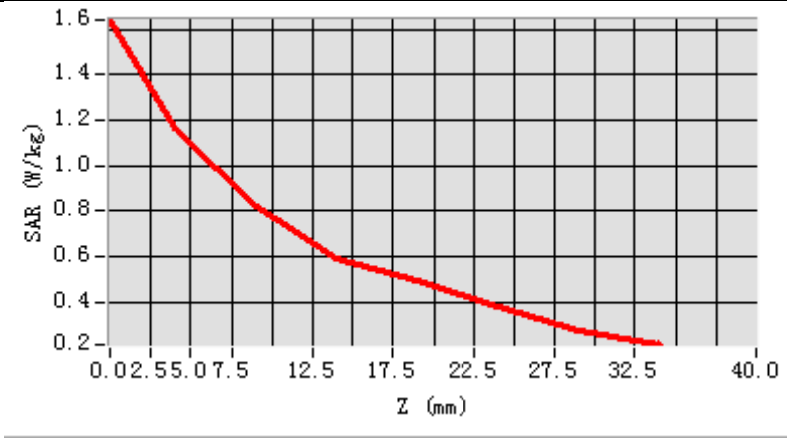

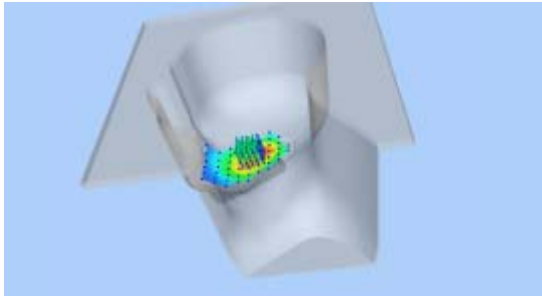
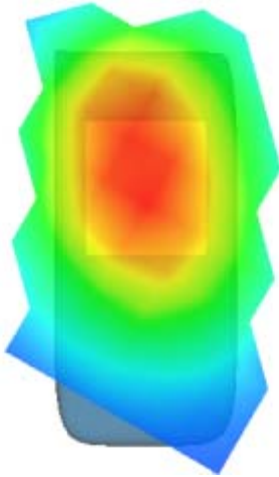
3D screen shot	Hot spot position
	

MEASUREMENT 2

Right_head_cheek

Type: Phone measurement (Complete)

Date of measurement: 19/1/2015

Measurement duration: 8 minutes 16 seconds

A. Experimental conditions.

<u>Area Scan</u>	<u>dx=15mm dy=15mm</u>
<u>ZoomScan</u>	<u>5x5x7, dx=8mm dy=8mm</u> <u>dz=5mm, Complete</u>
<u>Phantom</u>	<u>Right head</u>
<u>Device Position</u>	<u>Cheek</u>
<u>Band</u>	<u>GSM1900</u>
<u>Channels</u>	<u>Middle</u>
<u>Signal</u>	<u>TDMA (Crest factor: 8.0)</u>

B. Instrumentations.

Equipment description	Manufacturer/Model	Identification No.	Current calibration date	Next calibration date
SAR Probe	SATIMO	SN_0913_EP1 70/nCF: 5.26	5/2014	5/2015

C. SAR Measurement Results

Middle Band SAR (Channel 661):

Frequency (MHz)	1880.000000
Relative permittivity (real part)	40.102001
Relative permittivity (imaginary part)	13.250600
Conductivity (S/m)	1.383952
Variation (%)	0.170000

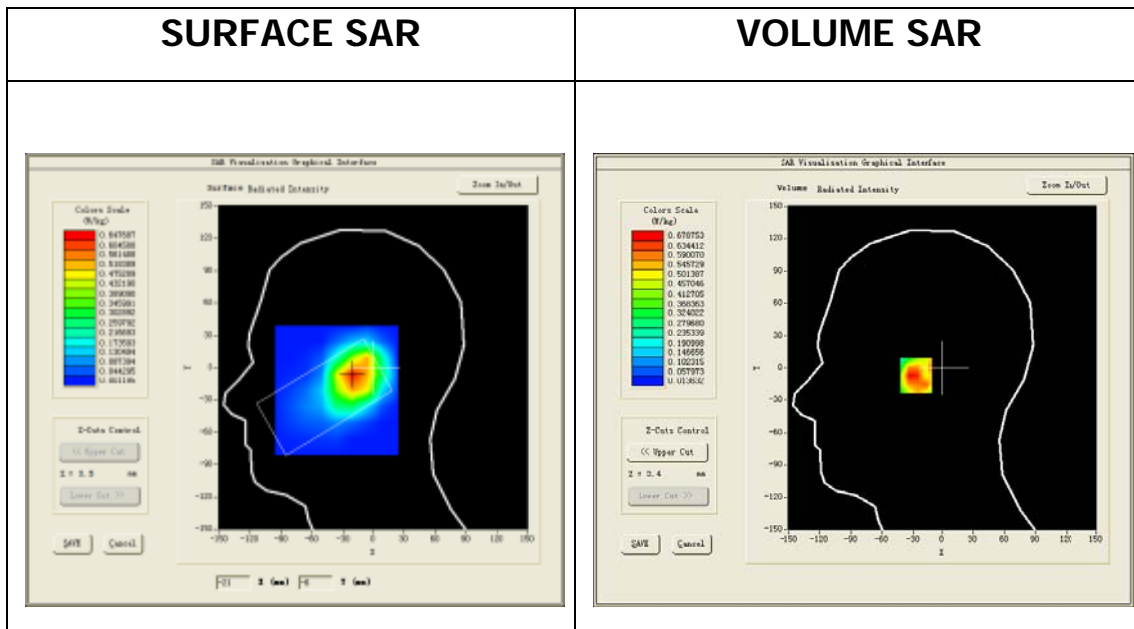

Maximum location: X=-21.00, Y=-7.00

SAR Peak: 1.07 W/kg

SAR 10g (W/Kg)	0.363894
SAR 1g (W/Kg)	0.655225

Z (mm)	0.00	4.00	9.00	14.00	19.00	24.00	29.00
SAR (W/Kg)	1.0085	0.6672	0.3893	0.2299	0.1401	0.0862	0.0583

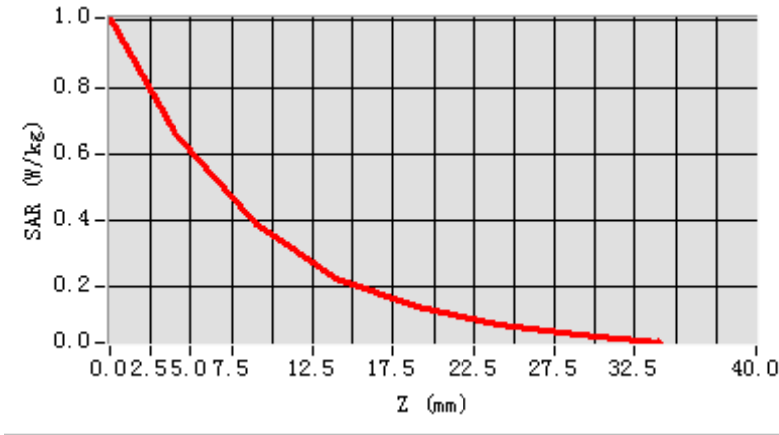

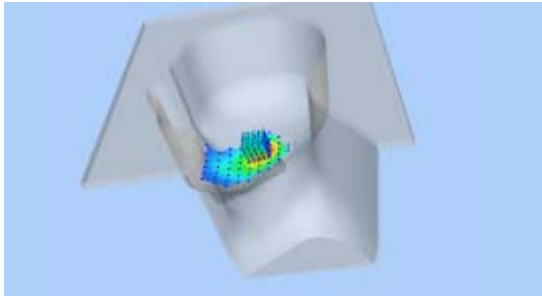
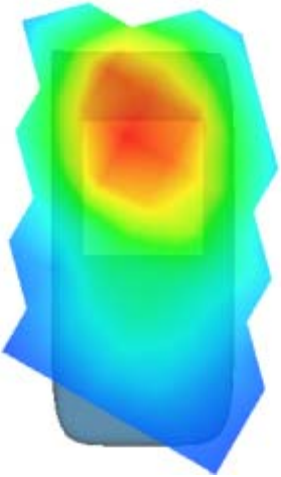
3D screen shot	Hot spot position
	

MEASUREMENT 3

Towards_ground_middle_5mm_with_repeated

Type: Phone measurement (Complete)

Date of measurement: 17/1/2015

Measurement duration: 11 minutes 11 seconds

A. Experimental conditions.

<u>Area Scan</u>	<u>dx=15mm dy=15mm</u>
<u>ZoomScan</u>	<u>5x5x7,dx=8mm dy=8mm</u> <u>dz=5mm,Complete</u>
<u>Phantom</u>	<u>Validation plane</u>
<u>Device Position</u>	<u>Body</u>
<u>Band</u>	<u>CUSTOM (GPRS850 4Tx)</u>
<u>Channels</u>	<u>Middle</u>
<u>Signal</u>	<u>Duty Cycle: 50% (Crest factor: 2.0)</u>

B. Instrumentations.

Equipment description	Manufacturer/Model	Identification No.	Current calibration date	Next calibration date
SAR Probe	SATIMO	SN_0913_EP1 70/nCF: 5.86	5/2014	5/2015

C. SAR Measurement Results

Frequency (MHz)	836.599976
Relative permittivity (real part)	54.353921
Relative permittivity (imaginary part)	20.951701
Conductivity (S/m)	0.974622
Variation (%)	-3.300000

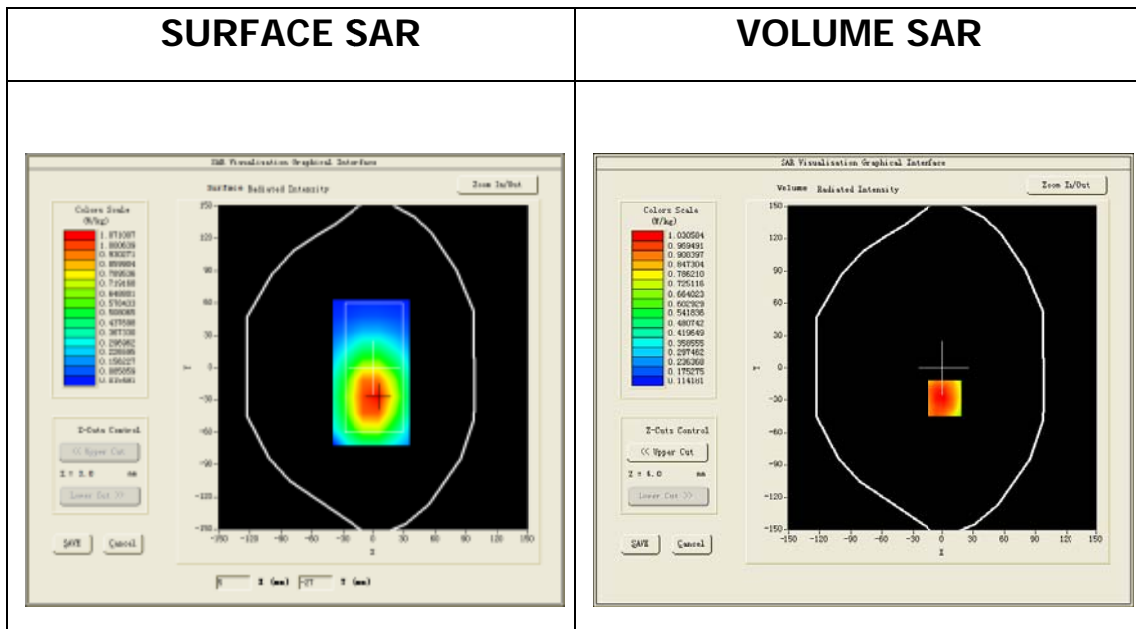

Maximum location: X=2.00, Y=-28.00

SAR Peak: 1.38 W/kg

SAR 10g (W/Kg)	0.705425
SAR 1g (W/Kg)	1.010979

Z (mm)	0.00	4.00	9.00	14.00	19.00	24.00	29.00
SAR (W/Kg)	1.3563	1.0306	0.7489	0.5551	0.4223	0.3119	0.2304

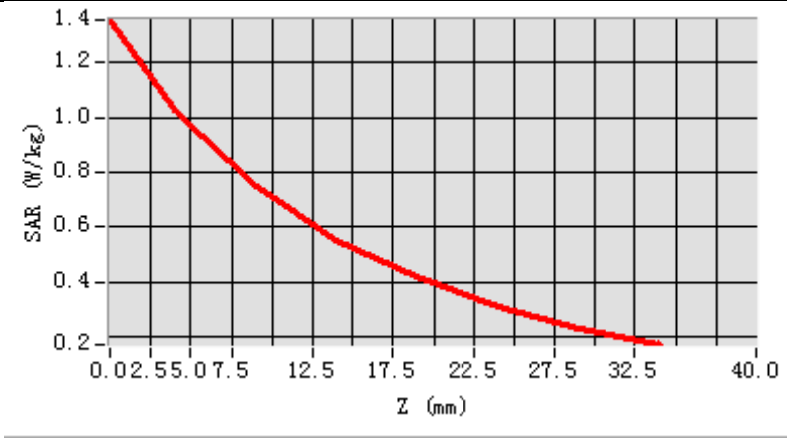

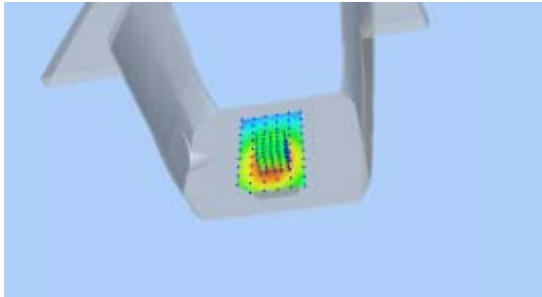
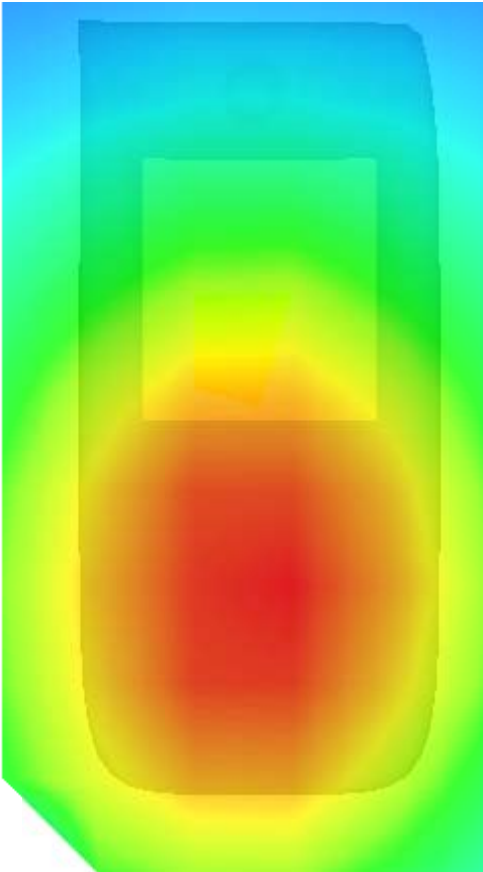
3D screen shot	Hot spot position
	

MEASUREMENT 4

Towards_ground_middle_5mm

Type: Phone measurement (Complete)

Date of measurement: 19/1/2015

Measurement duration: 9 minutes 42 seconds

A. Experimental conditions.

<u>Area Scan</u>	<u>dx=15mm dy=15mm</u>
<u>ZoomScan</u>	<u>5x5x7,dx=8mm dy=8mm</u> <u>dz=5mm,Complete</u>
<u>Phantom</u>	<u>Validation plane</u>
<u>Device Position</u>	<u>Body</u>
<u>Band</u>	<u>CUSTOM (GPRS1900 4Tx)</u>
<u>Channels</u>	<u>Middle</u>
<u>Signal</u>	<u>Duty Cycle: 50% (Crest factor: 2.0)</u>

B. Instrumentations.

Equipment description	Manufacturer/Model	Identification No.	Current calibration date	Next calibration date
SAR Probe	SATIMO	SN_0913_EP1 70/nCF: 5.41	5/2014	5/2015

C. SAR Measurement Results

Frequency (MHz)	1880.000000
Relative permittivity (real part)	53.363213
Relative permittivity (imaginary part)	14.403221
Conductivity (S/m)	1.504622
Variation (%)	2.600000

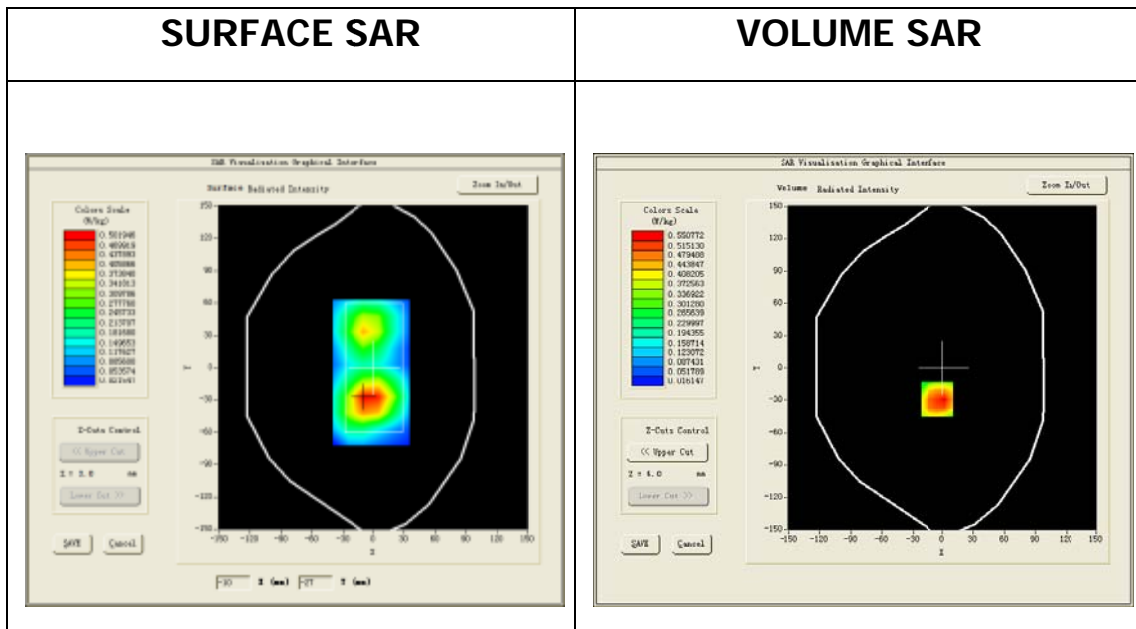

Maximum location: X=-6.00, Y=-29.00

SAR Peak: 0.85 W/kg

SAR 10g (W/Kg)	0.311835
SAR 1g (W/Kg)	0.538172

Z (mm)	0.00	4.00	9.00	14.00	19.00	24.00	29.00
SAR (W/Kg)	0.7509	0.5210	0.3256	0.2077	0.1296	0.0799	0.0502

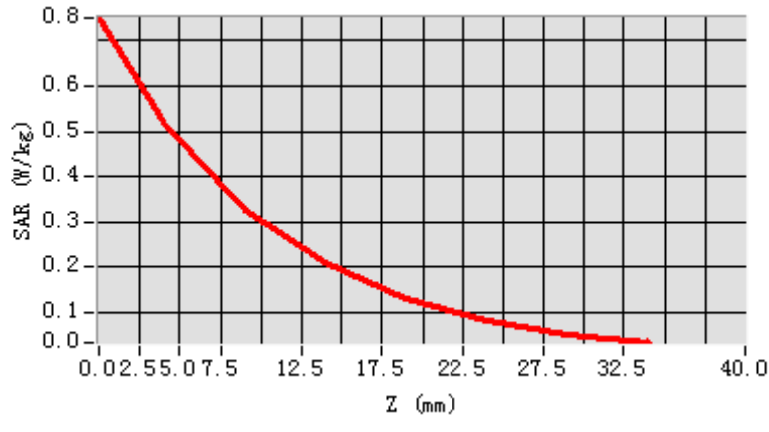

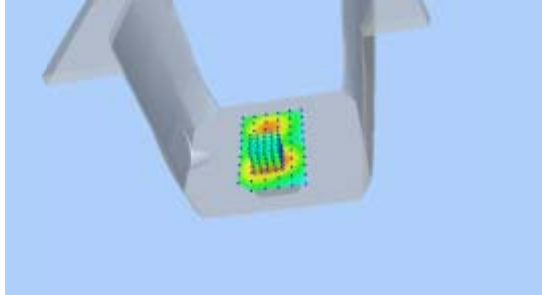
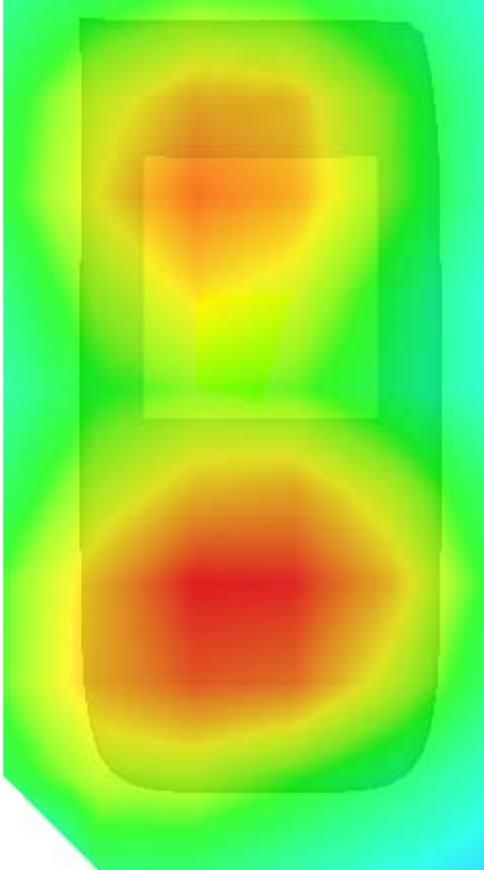
3D screen shot	Hot spot position
	



SATIMO 225, rue Pierre Rivoalon 29200 Brest - France
Tel: +33 (0)2 98 05 13 34; Fax: +33 (0)2 98 05 53 87; www.satimo.com



Annex C: Calibration reports

Project name : T463

Report Number:

FCC15016713-2

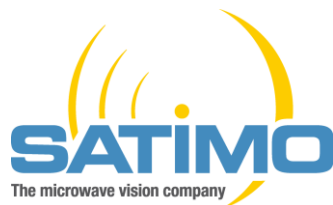

COMOSAR E-Field Probe Calibration Report

Ref : ACR.127.1.14.SATU.B

WORLD STANDARDIZATION CERTIFICATION & TESTING CO.,LTD

BLOCK A, BAO SHI SCIENCE PARK,BAO SHI ROAD,
BAO'AN DISTRICT

SHENZHEN 518108,P.R. CHINA

SATIMO COMOSAR DOSIMETRIC E-FIELD PROBE

SERIAL NO.: SN 09/13 EP170

Calibrated at SATIMO US

2105 Barrett Park Dr. - Kennesaw, GA 30144



05/07/2014

Summary:

This document presents the method and results from an accredited COMOSAR Dosimetric E-Field Probe calibration performed in SATIMO USA using the CALISAR / CALIBAIR test bench, for use with a SATIMO COMOSAR system only. All calibration results are traceable to national metrology institutions.

	<i>Name</i>	<i>Function</i>	<i>Date</i>	<i>Signature</i>
<i>Prepared by :</i>	Jérôme LUC	Product Manager	5/7/2014	<i>JL</i>
<i>Checked by :</i>	Jérôme LUC	Product Manager	5/7/2014	<i>JL</i>
<i>Approved by :</i>	Kim RUTKOWSKI	Quality Manager	5/7/2014	<i>Kim Rutkowski</i>

	<i>Customer Name</i>
<i>Distribution :</i>	World Standardization Certification & Testing Co.,Ltd

<i>Issue</i>	<i>Date</i>	<i>Modifications</i>
A	5/7/2014	Initial release
B	7/7/2014	Add 2600 MHz factor

TABLE OF CONTENTS

1	Device Under Test	4
2	Product Description	4
2.1	General Information	4
3	Measurement Method	4
3.1	Linearity	4
3.2	Sensitivity	5
3.3	Lower Detection Limit	5
3.4	Isotropy	5
3.5	Boundary Effect	5
4	Measurement Uncertainty	5
5	Calibration Measurement Results	6
5.1	Sensitivity in air	6
5.2	Linearity	7
5.3	Sensitivity in liquid	7
5.4	Isotropy	8
6	List of Equipment	9

1 DEVICE UNDER TEST

Device Under Test	
Device Type	COMOSAR DOSIMETRIC E FIELD PROBE
Manufacturer	Satimo
Model	SSE5
Serial Number	SN 09/13 EP170
Product Condition (new / used)	Used
Frequency Range of Probe	0.3 GHz-3GHz
Resistance of Three Dipoles at Connector	Dipole 1: R1=0.216 MΩ Dipole 2: R2=0.224 MΩ Dipole 3: R3=0.215 MΩ

A yearly calibration interval is recommended.

2 PRODUCT DESCRIPTION

2.1 GENERAL INFORMATION

Satimo's COMOSAR E field Probes are built in accordance to the IEEE 1528, OET 65 Bulletin C and CEI/IEC 62209 standards.



Figure 1 – Satimo COMOSAR Dosimetric E field Dipole

Probe Length	330 mm
Length of Individual Dipoles	4.5 mm
Maximum external diameter	8 mm
Probe Tip External Diameter	5 mm
Distance between dipoles / probe extremity	2.7 mm

3 MEASUREMENT METHOD

The IEEE 1528, OET 65 Bulletin C, CENELEC EN50361 and CEI/IEC 62209 standards provide recommended practices for the probe calibrations, including the performance characteristics of interest and methods by which to assess their affect. All calibrations / measurements performed meet the fore mentioned standards.

3.1 LINEARITY

The evaluation of the linearity was done in free space using the waveguide, performing a power sweep to cover the SAR range 0.01W/kg to 100W/kg.

3.2 SENSITIVITY

The sensitivity factors of the three dipoles were determined using a two step calibration method (air and tissue simulating liquid) using waveguides as outlined in the standards.

3.3 LOWER DETECTION LIMIT

The lower detection limit was assessed using the same measurement set up as used for the linearity measurement. The required lower detection limit is 10 mW/kg.

3.4 ISOTROPY

The axial isotropy was evaluated by exposing the probe to a reference wave from a standard dipole with the dipole mounted under the flat phantom in the test configuration suggested for system validations and checks. The probe was rotated along its main axis from 0 - 360 degrees in 15 degree steps. The hemispherical isotropy is determined by inserting the probe in a thin plastic box filled with tissue-equivalent liquid, with the plastic box illuminated with the fields from a half wave dipole. The dipole is rotated about its axis (0°–180°) in 15° increments. At each step the probe is rotated about its axis (0°–360°).

3.5 BOUNDARY EFFECT

The boundary effect is defined as the deviation between the SAR measured data and the expected exponential decay in the liquid when the probe is oriented normal to the interface. To evaluate this effect, the liquid filled flat phantom is exposed to fields from either a reference dipole or waveguide. With the probe normal to the phantom surface, the peak spatial average SAR is measured and compared to the analytical value at the surface.

4 MEASUREMENT UNCERTAINTY

The guidelines outlined in the IEEE 1528, OET 65 Bulletin C, CENELEC EN50361 and CEI/IEC 62209 standards were followed to generate the measurement uncertainty associated with an E-field probe calibration using the waveguide technique. All uncertainties listed below represent an expanded uncertainty expressed at approximately the 95% confidence level using a coverage factor of k=2, traceable to the Internationally Accepted Guides to Measurement Uncertainty.

Uncertainty analysis of the probe calibration in waveguide					
ERROR SOURCES	Uncertainty value (%)	Probability Distribution	Divisor	ci	Standard Uncertainty (%)
Incident or forward power	3.00%	Rectangular	$\sqrt{3}$	1	1.732%
Reflected power	3.00%	Rectangular	$\sqrt{3}$	1	1.732%
Liquid conductivity	5.00%	Rectangular	$\sqrt{3}$	1	2.887%
Liquid permittivity	4.00%	Rectangular	$\sqrt{3}$	1	2.309%
Field homogeneity	3.00%	Rectangular	$\sqrt{3}$	1	1.732%
Field probe positioning	5.00%	Rectangular	$\sqrt{3}$	1	2.887%
Field probe linearity	3.00%	Rectangular	$\sqrt{3}$	1	1.732%

Combined standard uncertainty					5.831%
Expanded uncertainty 95 % confidence level k = 2					12.0%

5 CALIBRATION MEASUREMENT RESULTS

Calibration Parameters	
Liquid Temperature	21 °C
Lab Temperature	21 °C
Lab Humidity	45 %

5.1 SENSITIVITY IN AIR

Normx dipole 1 (μV/(V/m) ²)	Normy dipole 2 (μV/(V/m) ²)	Normz dipole 3 (μV/(V/m) ²)
5.73	6.15	6.21

DCP dipole 1 (mV)	DCP dipole 2 (mV)	DCP dipole 3 (mV)
97	93	90

Calibration curves $e_i=f(V)$ ($i=1,2,3$) allow to obtain H-field value using the formula:

$$E = \sqrt{E_1^2 + E_2^2 + E_3^2}$$

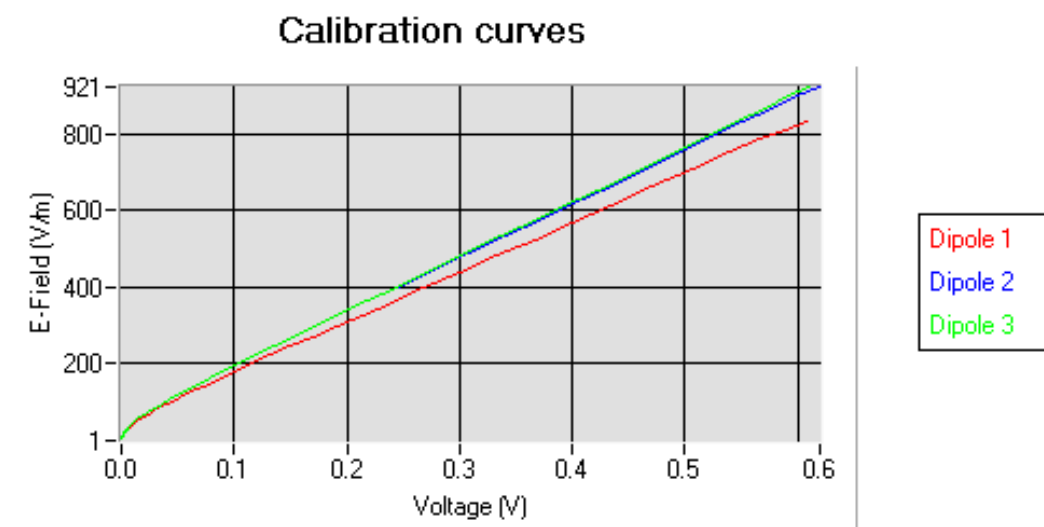

5.2 LINEARITY

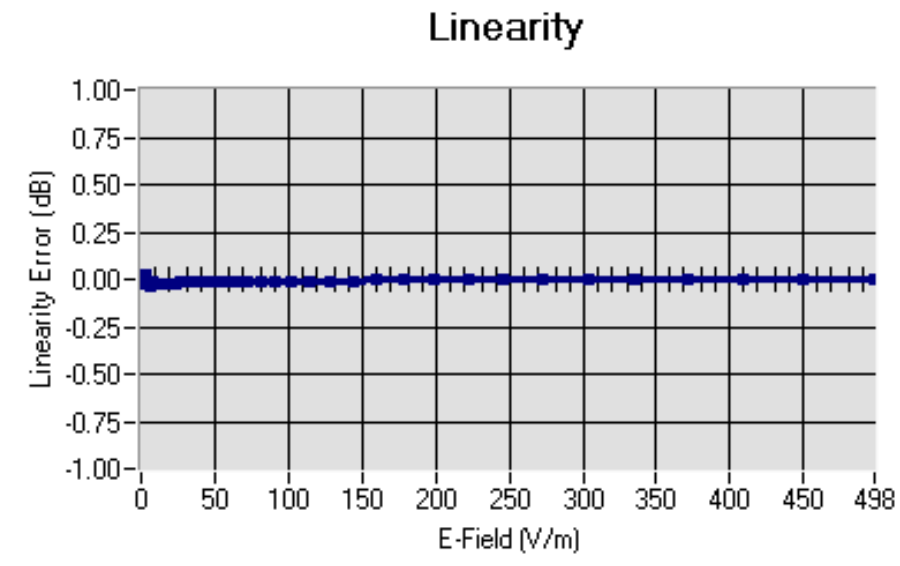

Linearity: $\pm 0.74\%$ ($\pm 0.03\text{dB}$)

5.3 SENSITIVITY IN LIQUID

Liquid	Frequency (MHz +/- 100MHz)	Permittivity	Epsilon (S/m)	ConvF
HL300	300	44.58	0.82	5.23
BL300	300	59.69	0.90	5.38
HL450	450	43.02	0.85	6.44
BL450	450	57.52	0.96	6.68
HL850	835	43.03	0.87	5.64
BL850	835	53.35	0.96	5.86
HL900	900	42.29	0.96	5.37
BL900	900	56.82	1.06	5.54
HL1800	1800	40.93	1.36	4.95
BL1800	1800	52.57	1.47	5.05
HL1900	1900	40.92	1.45	5.26
BL1900	1900	53.60	1.52	5.41
HL2000	2000	39.36	1.44	5.02
BL2000	2000	52.17	1.53	5.22
HL2450	2450	39.12	1.78	4.84
BL2450	2450	52.17	1.90	5.00
HL2600	2600	39.12	1.78	5.22
BL2600	2600	52.17	1.90	5.41

LOWER DETECTION LIMIT: 7mW/kg

5.4 ISOTROPY

HL900 MHz

- Axial isotropy: 0.04 dB
- Hemispherical isotropy: 0.07 dB

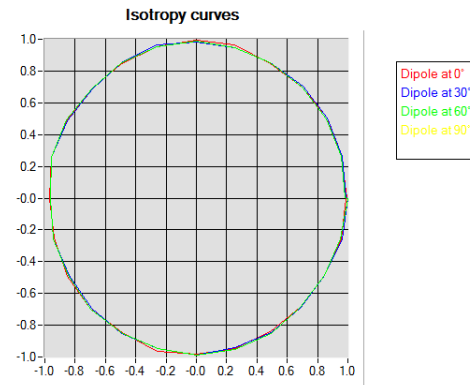

HL1800 MHz

- Axial isotropy: 0.05 dB
- Hemispherical isotropy: 0.07 dB

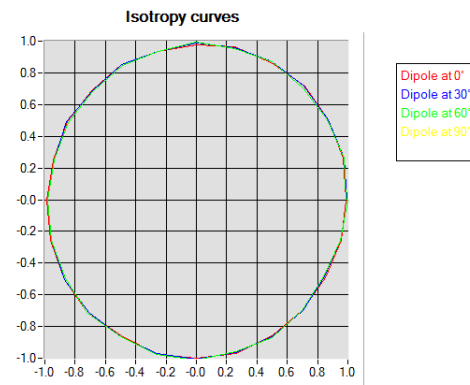

6 LIST OF EQUIPMENT

Equipment Summary Sheet				
Equipment Description	Manufacturer / Model	Identification No.	Current Calibration Date	Next Calibration Date
Flat Phantom	Satimo	SN-20/09-SAM71	Validated. No cal required.	Validated. No cal required.
COMOSAR Test Bench	Version 3	NA	Validated. No cal required.	Validated. No cal required.
Network Analyzer	Rhode & Schwarz ZVA	SN100132	02/2013	02/2016
Reference Probe	Satimo	EP 94 SN 37/08	Characterized prior to test. No cal required.	Characterized prior to test. No cal required.
Multimeter	Keithley 2000	1188656	12/2013	12/2016
Signal Generator	Agilent E4438C	MY49070581	12/2013	12/2016
Amplifier	Aethercomm	SN 046	Characterized prior to test. No cal required.	Characterized prior to test. No cal required.
Power Meter	HP E4418A	US38261498	12/2013	12/2016
Power Sensor	HP ECP-E26A	US37181460	12/2013	12/2016
Directional Coupler	Narda 4216-20	01386	Characterized prior to test. No cal required.	Characterized prior to test. No cal required.
Waveguide	Mega Industries	069Y7-158-13-712	Validated. No cal required.	Validated. No cal required.
Waveguide Transition	Mega Industries	069Y7-158-13-701	Validated. No cal required.	Validated. No cal required.
Waveguide Termination	Mega Industries	069Y7-158-13-701	Validated. No cal required.	Validated. No cal required.
Temperature / Humidity Sensor	Control Company	11-661-9	8/2012	8/2015

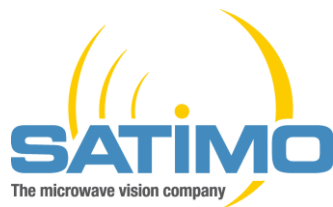

SAR Reference Dipole Calibration Report

Ref : ACR.127.4.14.SATU.A

WORLD STANDARDIZATION CERTIFICATION & TESTING CO.,LTD

**BLOCK A, BAO SHI SCIENCE PARK, BAO SHI ROAD,
BAO'AN DISTRICT**

SHENZHEN 518108, P.R. CHINA

SATIMO COMOSAR REFERENCE DIPOLE

FREQUENCY: 835 MHZ

SERIAL NO.: SN 14/13 DIP 0G835-235

Calibrated at SATIMO US



2105 Barrett Park Dr. - Kennesaw, GA 30144



05/07/2014

Summary:

This document presents the method and results from an accredited SAR reference dipole calibration performed in SATIMO USA using the COMOSAR test bench. All calibration results are traceable to national metrology institutions.

	<i>Name</i>	<i>Function</i>	<i>Date</i>	<i>Signature</i>
<i>Prepared by :</i>	Jérôme LUC	Product Manager	5/7/2014	
<i>Checked by :</i>	Jérôme LUC	Product Manager	5/7/2014	
<i>Approved by :</i>	Kim RUTKOWSKI	Quality Manager	5/7/2014	

	<i>Customer Name</i>
<i>Distribution :</i>	World Standardization Certification & Testing Co .,Ltd

<i>Issue</i>	<i>Date</i>	<i>Modifications</i>
A	5/7/2014	Initial release

TABLE OF CONTENTS

1	Introduction.....	4
2	Device Under Test	4
3	Product Description	4
3.1	General Information	4
4	Measurement Method	5
4.1	Return Loss Requirements	5
4.2	Mechanical Requirements	5
5	Measurement Uncertainty	5
5.1	Return Loss	5
5.2	Dimension Measurement	5
5.3	Validation Measurement	5
6	Calibration Measurement Results	6
6.1	Return Loss and Impedance	6
6.2	Mechanical Dimensions	6
7	Validation measurement	7
7.1	Measurement Condition	7
7.2	Head Liquid Measurement	7
7.3	Measurement Result	8
7.4	Body Measurement Result	9
8	List of Equipment	10

1 INTRODUCTION

This document contains a summary of the requirements set forth by the IEEE 1528, OET 65 Bulletin C and CEI/IEC 62209 standards for reference dipoles used for SAR measurement system validations and the measurements that were performed to verify that the product complies with the fore mentioned standards.

2 DEVICE UNDER TEST

Device Under Test	
Device Type	COMOSAR 835 MHz REFERENCE DIPOLE
Manufacturer	Satimo
Model	SID835
Serial Number	SN 14/13 DIP 0G835-235
Product Condition (new / used)	Used

A yearly calibration interval is recommended.

3 PRODUCT DESCRIPTION

3.1 GENERAL INFORMATION

Satimo’s COMOSAR Validation Dipoles are built in accordance to the IEEE 1528, OET 65 Bulletin C and CEI/IEC 62209 standards. The product is designed for use with the COMOSAR test bench only.



Figure 1 – Satimo COMOSAR Validation Dipole

4 MEASUREMENT METHOD

The IEEE 1528, OET 65 Bulletin C and CEI/IEC 62209 standards provide requirements for reference dipoles used for system validation measurements. The following measurements were performed to verify that the product complies with the fore mentioned standards.

4.1 RETURN LOSS REQUIREMENTS

The dipole used for SAR system validation measurements and checks must have a return loss of -20 dB or better. The return loss measurement shall be performed against a liquid filled flat phantom, with the phantom constructed as outlined in the fore mentioned standards.

4.2 MECHANICAL REQUIREMENTS

The IEEE Std. 1528 and CEI/IEC 62209 standards specify the mechanical components and dimensions of the validation dipoles, with the dimensions frequency and phantom shell thickness dependent. The COMOSAR test bench employs a 2 mm phantom shell thickness therefore the dipoles sold for use with the COMOSAR test bench comply with the requirements set forth for a 2 mm phantom shell thickness.

5 MEASUREMENT UNCERTAINTY

All uncertainties listed below represent an expanded uncertainty expressed at approximately the 95% confidence level using a coverage factor of k=2, traceable to the Internationally Accepted Guides to Measurement Uncertainty.

5.1 RETURN LOSS

The following uncertainties apply to the return loss measurement:

Frequency band	Expanded Uncertainty on Return Loss
400-6000MHz	0.1 dB

5.2 DIMENSION MEASUREMENT

The following uncertainties apply to the dimension measurements:

Length (mm)	Expanded Uncertainty on Length
3 - 300	0.05 mm

5.3 VALIDATION MEASUREMENT

The guidelines outlined in the IEEE 1528, OET 65 Bulletin C, CENELEC EN50361 and CEI/IEC 62209 standards were followed to generate the measurement uncertainty for validation measurements.

Scan Volume	Expanded Uncertainty
1 g	20.3 %
10 g	20.1 %

6 CALIBRATION MEASUREMENT RESULTS

6.1 RETURN LOSS AND IMPEDANCE

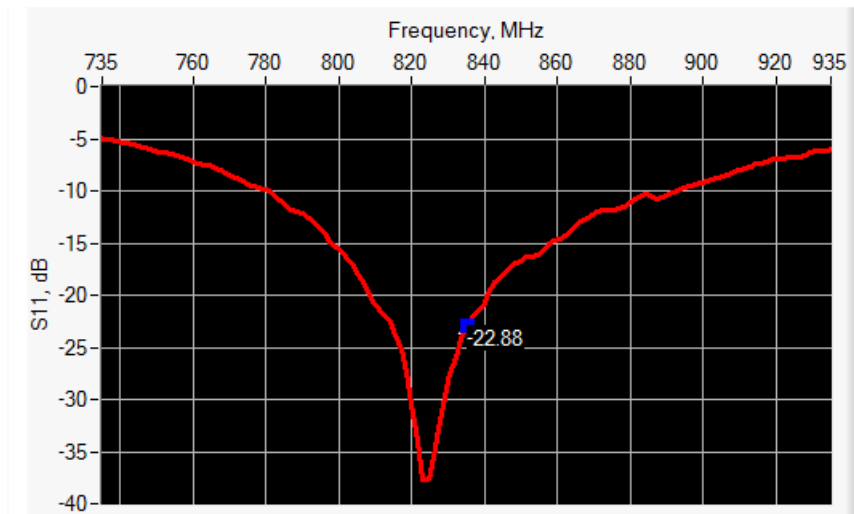

Frequency (MHz)	Return Loss (dB)	Requirement (dB)	Impedance
835	-22.88	-20	57.6 Ω - 0.2 jΩ

6.2 MECHANICAL DIMENSIONS

Frequency MHz	L mm		h mm		d mm	
	required	measured	required	measured	required	measured
300	420.0 ±1 %.		250.0 ±1 %.		6.35 ±1 %.	
450	290.0 ±1 %.		166.7 ±1 %.		6.35 ±1 %.	
750	176.0 ±1 %.		100.0 ±1 %.		6.35 ±1 %.	
835	161.0 ±1 %.	PASS	89.8 ±1 %.	PASS	3.6 ±1 %.	PASS
900	149.0 ±1 %.		83.3 ±1 %.		3.6 ±1 %.	
1450	89.1 ±1 %.		51.7 ±1 %.		3.6 ±1 %.	
1500	80.5 ±1 %.		50.0 ±1 %.		3.6 ±1 %.	
1640	79.0 ±1 %.		45.7 ±1 %.		3.6 ±1 %.	
1750	75.2 ±1 %.		42.9 ±1 %.		3.6 ±1 %.	
1800	72.0 ±1 %.		41.7 ±1 %.		3.6 ±1 %.	
1900	68.0 ±1 %.		39.5 ±1 %.		3.6 ±1 %.	
1950	66.3 ±1 %.		38.5 ±1 %.		3.6 ±1 %.	
2000	64.5 ±1 %.		37.5 ±1 %.		3.6 ±1 %.	
2100	61.0 ±1 %.		35.7 ±1 %.		3.6 ±1 %.	
2300	55.5 ±1 %.		32.6 ±1 %.		3.6 ±1 %.	
2450	51.5 ±1 %.		30.4 ±1 %.		3.6 ±1 %.	
2600	48.5 ±1 %.		28.8 ±1 %.		3.6 ±1 %.	
3000	41.5 ±1 %.		25.0 ±1 %.		3.6 ±1 %.	
3500	37.0 ±1 %.		26.4 ±1 %.		3.6 ±1 %.	
3700	34.7 ±1 %.		26.4 ±1 %.		3.6 ±1 %.	

7 VALIDATION MEASUREMENT

The IEEE Std. 1528, OET 65 Bulletin C and CEI/IEC 62209 standards state that the system validation measurements must be performed using a reference dipole meeting the fore mentioned return loss and mechanical dimension requirements. The validation measurement must be performed against a liquid filled flat phantom, with the phantom constructed as outlined in the fore mentioned standards. Per the standards, the dipole shall be positioned below the bottom of the phantom, with the dipole length centered and parallel to the longest dimension of the flat phantom, with the top surface of the dipole at the described distance from the bottom surface of the phantom.

7.1 MEASUREMENT CONDITION

Software	OPENSAR V4
Phantom	SN 20/09 SAM71
Probe	SN 18/11 EPG122
Liquid	Head Liquid Values: ϵ_r : 43.8 sigma : 0.91
Distance between dipole center and liquid	15.0 mm
Area scan resolution	$dx=8mm/dy=8mm$
Zoon Scan Resolution	$dx=8mm/dy=8m/dz=5mm$
Frequency	835 MHz
Input power	20 dBm
Liquid Temperature	21 °C
Lab Temperature	21 °C
Lab Humidity	45 %

7.2 HEAD LIQUID MEASUREMENT

Frequency MHz	Relative permittivity (ϵ_r)		Conductivity (σ) S/m	
	required	measured	required	measured
300	45.3 ±5 %		0.87 ±5 %	
450	43.5 ±5 %		0.87 ±5 %	
750	41.9 ±5 %		0.89 ±5 %	
835	41.5 ±5 %	PASS	0.90 ±5 %	PASS
900	41.5 ±5 %		0.97 ±5 %	
1450	40.5 ±5 %		1.20 ±5 %	
1500	40.4 ±5 %		1.23 ±5 %	
1640	40.2 ±5 %		1.31 ±5 %	
1750	40.1 ±5 %		1.37 ±5 %	
1800	40.0 ±5 %		1.40 ±5 %	
1900	40.0 ±5 %		1.40 ±5 %	
1950	40.0 ±5 %		1.40 ±5 %	
2000	40.0 ±5 %		1.40 ±5 %	
2100	39.8 ±5 %		1.49 ±5 %	
2300	39.5 ±5 %		1.67 ±5 %	
2450	39.2 ±5 %		1.80 ±5 %	
2600	39.0 ±5 %		1.96 ±5 %	
3000	38.5 ±5 %		2.40 ±5 %	
3500	37.9 ±5 %		2.91 ±5 %	

7.3 MEASUREMENT RESULT

The IEEE Std. 1528 and CEI/IEC 62209 standards state that the system validation measurements should produce the SAR values shown below (for phantom thickness of 2 mm), within the uncertainty for the system validation. All SAR values are normalized to 1 W forward power. In bracket, the measured SAR is given with the used input power.

Frequency MHz	1 g SAR (W/kg/W)		10 g SAR (W/kg/W)	
	required	measured	required	measured
300	2.85		1.94	
450	4.58		3.06	
750	8.49		5.55	
835	9.56	9.56 (0.96)	6.22	6.19 (0.62)
900	10.9		6.99	
1450	29		16	
1500	30.5		16.8	
1640	34.2		18.4	
1750	36.4		19.3	
1800	38.4		20.1	
1900	39.7		20.5	
1950	40.5		20.9	
2000	41.1		21.1	
2100	43.6		21.9	
2300	48.7		23.3	
2450	52.4		24	
2600	55.3		24.6	
3000	63.8		25.7	
3500	67.1		25	

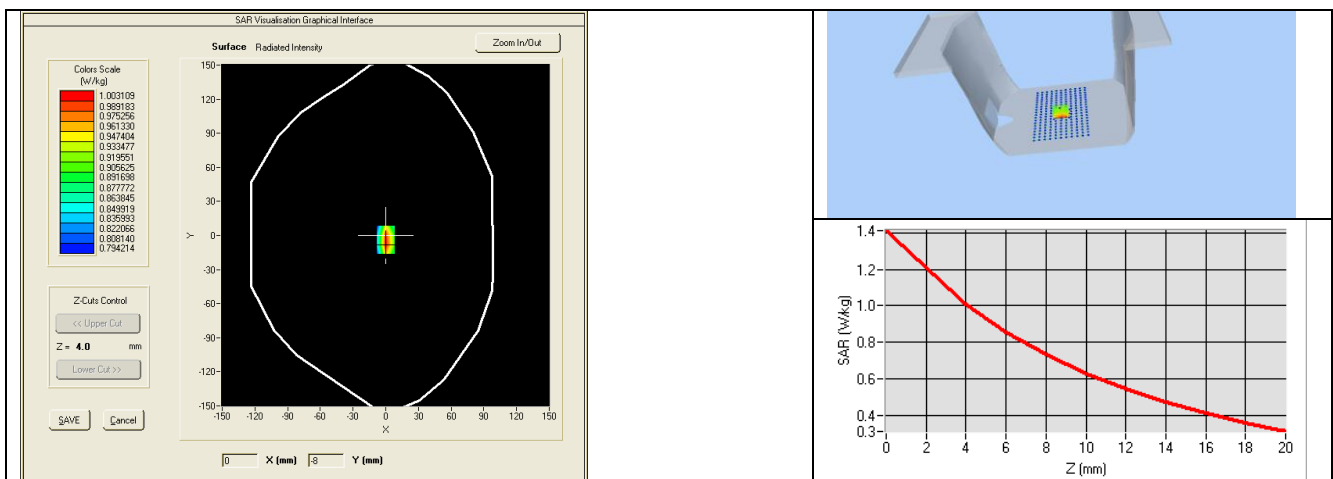

7.4 BODY MEASUREMENT RESULT

Software	OPENSAR V4
Phantom	SN 20/09 SAM71
Probe	SN 18/11 EPG122
Liquid	Body Liquid Values: eps' : 54.4 sigma : 0.94
Distance between dipole center and liquid	15.0 mm
Area scan resolution	dx=8mm/dy=8mm
Zoon Scan Resolution	dx=8mm/dy=8m/dz=5mm
Frequency	835 MHz
Input power	20 dBm
Liquid Temperature	21 °C
Lab Temperature	21 °C
Lab Humidity	45 %

Frequency MHz	1 g SAR (W/kg/W)	10 g SAR (W/kg/W)
	measured	measured
835	9.86 (0.99)	6.38 (0.64)

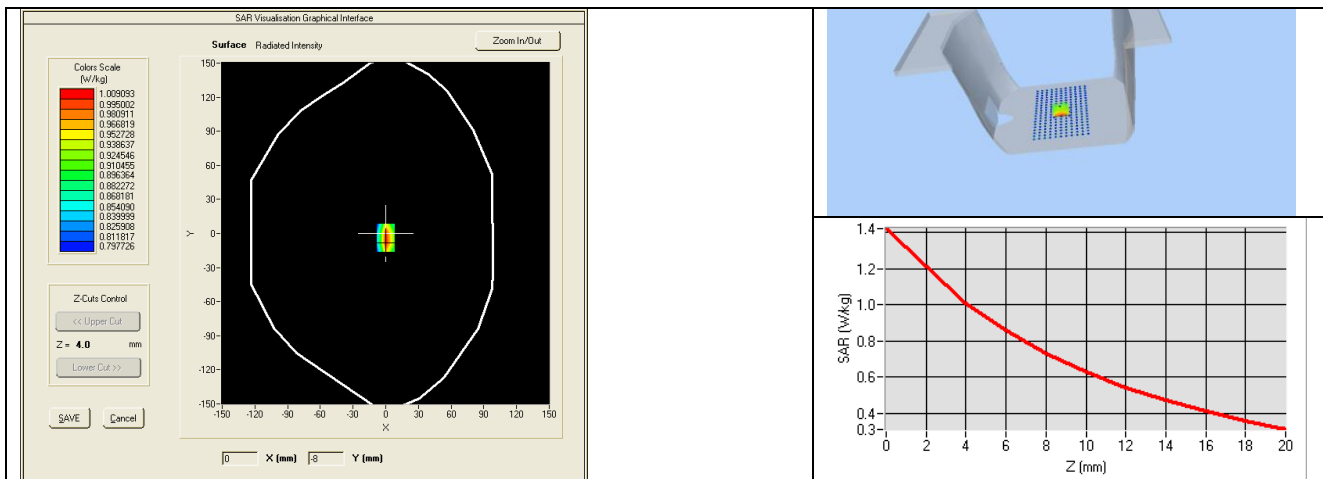

8 LIST OF EQUIPMENT

Equipment Summary Sheet				
Equipment Description	Manufacturer / Model	Identification No.	Current Calibration Date	Next Calibration Date
SAM Phantom	Satimo	SN-20/09-SAM71	Validated. No cal required.	Validated. No cal required.
COMOSAR Test Bench	Version 3	NA	Validated. No cal required.	Validated. No cal required.
Network Analyzer	Rhode & Schwarz ZVA	SN100132	02/2013	02/2016
Calipers	Carrera	CALIPER-01	12/2013	12/2016
Reference Probe	Satimo	EPG122 SN 18/11	Characterized prior to test. No cal required.	Characterized prior to test. No cal required.
Multimeter	Keithley 2000	1188656	12/2013	12/2016
Signal Generator	Agilent E4438C	MY49070581	12/2013	12/2016
Amplifier	Aethercomm	SN 046	Characterized prior to test. No cal required.	Characterized prior to test. No cal required.
Power Meter	HP E4418A	US38261498	12/2013	12/2016
Power Sensor	HP ECP-E26A	US37181460	12/2013	12/2016
Directional Coupler	Narda 4216-20	01386	Characterized prior to test. No cal required.	Characterized prior to test. No cal required.
Temperature and Humidity Sensor	Control Company	11-661-9	8/2012	8/2015

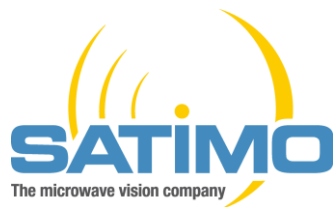

SAR Reference Dipole Calibration Report

Ref : ACR.127.7.14.SATU.A

**WORLD STANDARDIZATION CERTIFICATION
& TESTING CO.,LTD**

**BLOCK A, BAO SHI SCIENCE PARK,BAO SHI ROAD,
BAO'AN DISTRICT**

SHENZHEN 518108,P.R. CHINA

SATIMO COMOSAR REFERENCE DIPOLE

FREQUENCY: 1900 MHZ

SERIAL NO.: SN 14/13 DIP 1G900-236

Calibrated at SATIMO US



2105 Barrett Park Dr. - Kennesaw, GA 30144



05/07/2014

Summary:

This document presents the method and results from an accredited SAR reference dipole calibration performed in SATIMO USA using the COMOSAR test bench. All calibration results are traceable to national metrology institutions.

	<i>Name</i>	<i>Function</i>	<i>Date</i>	<i>Signature</i>
<i>Prepared by :</i>	Jérôme LUC	Product Manager	5/7/2014	
<i>Checked by :</i>	Jérôme LUC	Product Manager	5/7/2014	
<i>Approved by :</i>	Kim RUTKOWSKI	Quality Manager	5/7/2014	

	<i>Customer Name</i>
<i>Distribution :</i>	World Standardization Certification & Testing Co.,Ltd

<i>Issue</i>	<i>Date</i>	<i>Modifications</i>
A	5/7/2014	Initial release

TABLE OF CONTENTS

1	Introduction.....	4
2	Device Under Test	4
3	Product Description	4
3.1	General Information	4
4	Measurement Method	5
4.1	Return Loss Requirements	5
4.2	Mechanical Requirements	5
5	Measurement Uncertainty	5
5.1	Return Loss	5
5.2	Dimension Measurement	5
5.3	Validation Measurement	5
6	Calibration Measurement Results	6
6.1	Return Loss and Impedance	6
6.2	Mechanical Dimensions	6
7	Validation measurement	7
7.1	Measurement Condition	7
7.2	Head Liquid Measurement	7
7.3	Measurement Result	8
7.4	Body Measurement Result	9
8	List of Equipment	10

1 INTRODUCTION

This document contains a summary of the requirements set forth by the IEEE 1528, OET 65 Bulletin C and CEI/IEC 62209 standards for reference dipoles used for SAR measurement system validations and the measurements that were performed to verify that the product complies with the fore mentioned standards.

2 DEVICE UNDER TEST

Device Under Test	
Device Type	COMOSAR 1900 MHz REFERENCE DIPOLE
Manufacturer	Satimo
Model	SID1900
Serial Number	SN 14/13 DIP 1G900-236
Product Condition (new / used)	Used

A yearly calibration interval is recommended.

3 PRODUCT DESCRIPTION

3.1 GENERAL INFORMATION

Satimo’s COMOSAR Validation Dipoles are built in accordance to the IEEE 1528, OET 65 Bulletin C and CEI/IEC 62209 standards. The product is designed for use with the COMOSAR test bench only.



Figure 1 – Satimo COMOSAR Validation Dipole

4 MEASUREMENT METHOD

The IEEE 1528, OET 65 Bulletin C and CEI/IEC 62209 standards provide requirements for reference dipoles used for system validation measurements. The following measurements were performed to verify that the product complies with the fore mentioned standards.

4.1 RETURN LOSS REQUIREMENTS

The dipole used for SAR system validation measurements and checks must have a return loss of -20 dB or better. The return loss measurement shall be performed against a liquid filled flat phantom, with the phantom constructed as outlined in the fore mentioned standards.

4.2 MECHANICAL REQUIREMENTS

The IEEE Std. 1528 and CEI/IEC 62209 standards specify the mechanical components and dimensions of the validation dipoles, with the dimensions frequency and phantom shell thickness dependent. The COMOSAR test bench employs a 2 mm phantom shell thickness therefore the dipoles sold for use with the COMOSAR test bench comply with the requirements set forth for a 2 mm phantom shell thickness.

5 MEASUREMENT UNCERTAINTY

All uncertainties listed below represent an expanded uncertainty expressed at approximately the 95% confidence level using a coverage factor of k=2, traceable to the Internationally Accepted Guides to Measurement Uncertainty.

5.1 RETURN LOSS

The following uncertainties apply to the return loss measurement:

Frequency band	Expanded Uncertainty on Return Loss
400-6000MHz	0.1 dB

5.2 DIMENSION MEASUREMENT

The following uncertainties apply to the dimension measurements:

Length (mm)	Expanded Uncertainty on Length
3 - 300	0.05 mm

5.3 VALIDATION MEASUREMENT

The guidelines outlined in the IEEE 1528, OET 65 Bulletin C, CENELEC EN50361 and CEI/IEC 62209 standards were followed to generate the measurement uncertainty for validation measurements.

Scan Volume	Expanded Uncertainty
1 g	20.3 %
10 g	20.1 %

6 CALIBRATION MEASUREMENT RESULTS

6.1 RETURN LOSS AND IMPEDANCE

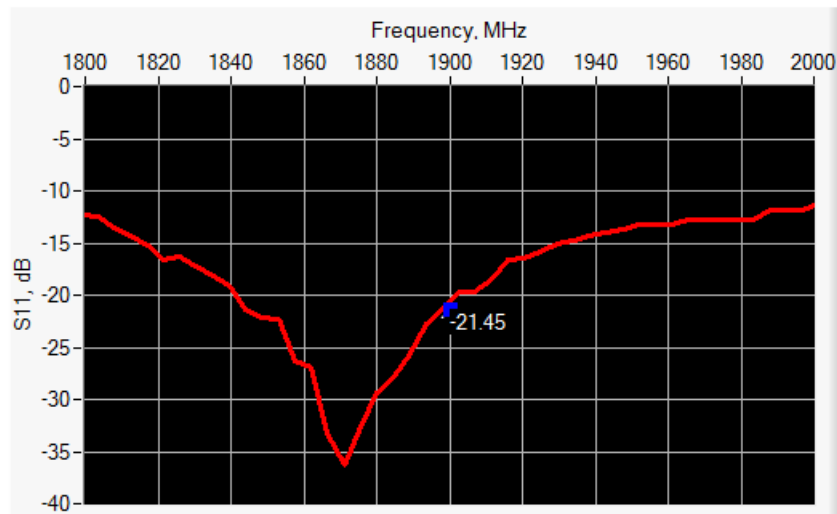

Frequency (MHz)	Return Loss (dB)	Requirement (dB)	Impedance
1900	-21.45	-20	53.2 Ω + 8.2 jΩ

6.2 MECHANICAL DIMENSIONS

Frequency MHz	L mm		h mm		d mm	
	required	measured	required	measured	required	measured
300	420.0 ±1 %.		250.0 ±1 %.		6.35 ±1 %.	
450	290.0 ±1 %.		166.7 ±1 %.		6.35 ±1 %.	
750	176.0 ±1 %.		100.0 ±1 %.		6.35 ±1 %.	
835	161.0 ±1 %.		89.8 ±1 %.		3.6 ±1 %.	
900	149.0 ±1 %.		83.3 ±1 %.		3.6 ±1 %.	
1450	89.1 ±1 %.		51.7 ±1 %.		3.6 ±1 %.	
1500	80.5 ±1 %.		50.0 ±1 %.		3.6 ±1 %.	
1640	79.0 ±1 %.		45.7 ±1 %.		3.6 ±1 %.	
1750	75.2 ±1 %.		42.9 ±1 %.		3.6 ±1 %.	
1800	72.0 ±1 %.		41.7 ±1 %.		3.6 ±1 %.	
1900	68.0 ±1 %.	PASS	39.5 ±1 %.	PASS	3.6 ±1 %.	PASS
1950	66.3 ±1 %.		38.5 ±1 %.		3.6 ±1 %.	
2000	64.5 ±1 %.		37.5 ±1 %.		3.6 ±1 %.	
2100	61.0 ±1 %.		35.7 ±1 %.		3.6 ±1 %.	
2300	55.5 ±1 %.		32.6 ±1 %.		3.6 ±1 %.	
2450	51.5 ±1 %.		30.4 ±1 %.		3.6 ±1 %.	
2600	48.5 ±1 %.		28.8 ±1 %.		3.6 ±1 %.	
3000	41.5 ±1 %.		25.0 ±1 %.		3.6 ±1 %.	
3500	37.0 ±1 %.		26.4 ±1 %.		3.6 ±1 %.	
3700	34.7 ±1 %.		26.4 ±1 %.		3.6 ±1 %.	

7 VALIDATION MEASUREMENT

The IEEE Std. 1528, OET 65 Bulletin C and CEI/IEC 62209 standards state that the system validation measurements must be performed using a reference dipole meeting the fore mentioned return loss and mechanical dimension requirements. The validation measurement must be performed against a liquid filled flat phantom, with the phantom constructed as outlined in the fore mentioned standards. Per the standards, the dipole shall be positioned below the bottom of the phantom, with the dipole length centered and parallel to the longest dimension of the flat phantom, with the top surface of the dipole at the described distance from the bottom surface of the phantom.

7.1 MEASUREMENT CONDITION

Software	OPENSAR V4
Phantom	SN 20/09 SAM71
Probe	SN 18/11 EPG122
Liquid	Head Liquid Values: ϵ_s' : 40.9 σ : 1.45
Distance between dipole center and liquid	10.0 mm
Area scan resolution	$dx=8mm/dy=8mm$
Zoon Scan Resolution	$dx=8mm/dy=8m/dz=5mm$
Frequency	1900 MHz
Input power	20 dBm
Liquid Temperature	21 °C
Lab Temperature	21 °C
Lab Humidity	45 %

7.2 HEAD LIQUID MEASUREMENT

Frequency MHz	Relative permittivity (ϵ_r')		Conductivity (σ) S/m	
	required	measured	required	measured
300	45.3 ±5 %		0.87 ±5 %	
450	43.5 ±5 %		0.87 ±5 %	
750	41.9 ±5 %		0.89 ±5 %	
835	41.5 ±5 %		0.90 ±5 %	
900	41.5 ±5 %		0.97 ±5 %	
1450	40.5 ±5 %		1.20 ±5 %	
1500	40.4 ±5 %		1.23 ±5 %	
1640	40.2 ±5 %		1.31 ±5 %	
1750	40.1 ±5 %		1.37 ±5 %	
1800	40.0 ±5 %		1.40 ±5 %	
1900	40.0 ±5 %	PASS	1.40 ±5 %	PASS
1950	40.0 ±5 %		1.40 ±5 %	
2000	40.0 ±5 %		1.40 ±5 %	
2100	39.8 ±5 %		1.49 ±5 %	
2300	39.5 ±5 %		1.67 ±5 %	
2450	39.2 ±5 %		1.80 ±5 %	
2600	39.0 ±5 %		1.96 ±5 %	
3000	38.5 ±5 %		2.40 ±5 %	
3500	37.9 ±5 %		2.91 ±5 %	

7.3 MEASUREMENT RESULT

The IEEE Std. 1528 and CEI/IEC 62209 standards state that the system validation measurements should produce the SAR values shown below (for phantom thickness of 2 mm), within the uncertainty for the system validation. All SAR values are normalized to 1 W forward power. In bracket, the measured SAR is given with the used input power.

Frequency MHz	1 g SAR (W/kg/W)		10 g SAR (W/kg/W)	
	required	measured	required	measured
300	2.85		1.94	
450	4.58		3.06	
750	8.49		5.55	
835	9.56		6.22	
900	10.9		6.99	
1450	29		16	
1500	30.5		16.8	
1640	34.2		18.4	
1750	36.4		19.3	
1800	38.4		20.1	
1900	39.7	39.46 (3.95)	20.5	20.42 (2.04)
1950	40.5		20.9	
2000	41.1		21.1	
2100	43.6		21.9	
2300	48.7		23.3	
2450	52.4		24	
2600	55.3		24.6	
3000	63.8		25.7	
3500	67.1		25	

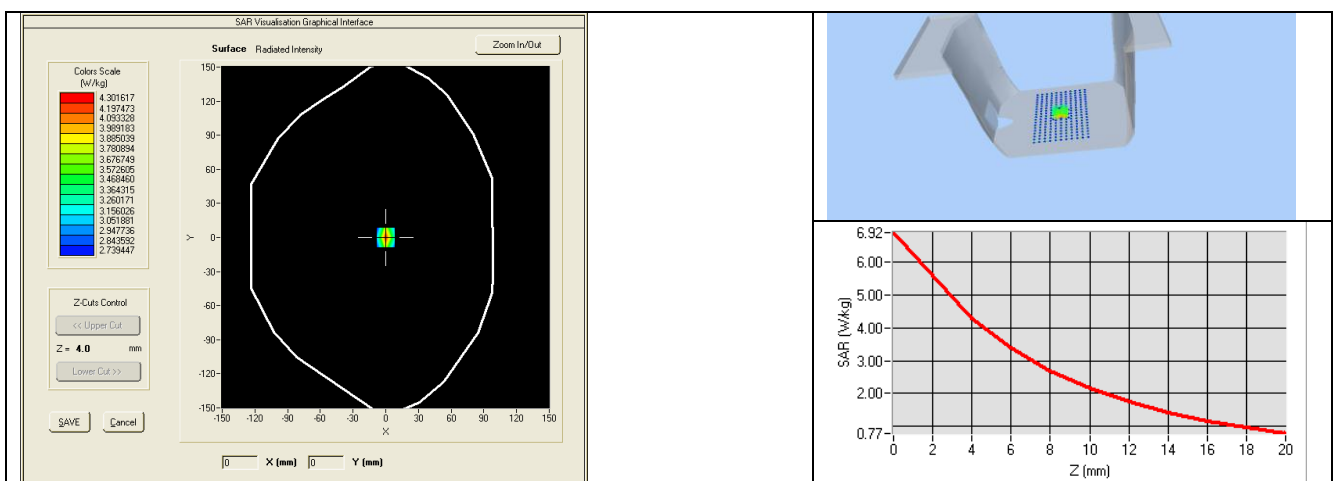

7.4 BODY MEASUREMENT RESULT

Software	OPENSAR V4
Phantom	SN 20/09 SAM71
Probe	SN 18/11 EPG122
Liquid	Body Liquid Values: ϵ_{ps} : 53.6 σ : 1.52
Distance between dipole center and liquid	10.0 mm
Area scan resolution	$dx=8mm/dy=8mm$
Zoon Scan Resolution	$dx=8mm/dy=8m/dz=5mm$
Frequency	1900 MHz
Input power	20 dBm
Liquid Temperature	21 °C
Lab Temperature	21 °C
Lab Humidity	45 %

Frequency MHz	1 g SAR (W/kg/W)	10 g SAR (W/kg/W)
	measured	measured
1900	40.06 (4.01)	20.76 (2.08)

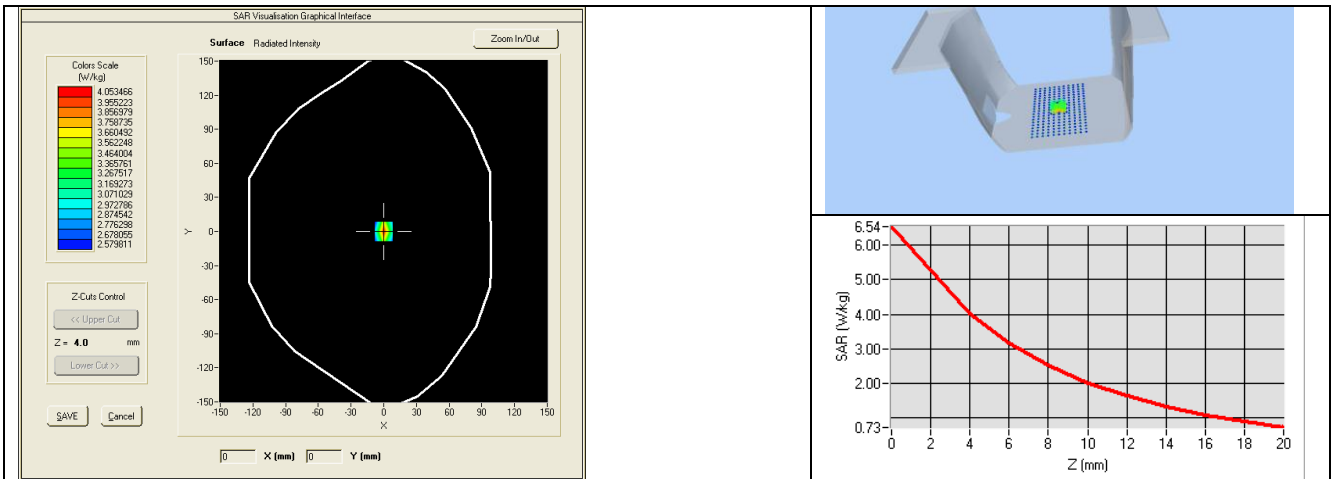

8 LIST OF EQUIPMENT

Equipment Summary Sheet				
Equipment Description	Manufacturer / Model	Identification No.	Current Calibration Date	Next Calibration Date
SAM Phantom	Satimo	SN-20/09-SAM71	Validated. No cal required.	Validated. No cal required.
COMOSAR Test Bench	Version 3	NA	Validated. No cal required.	Validated. No cal required.
Network Analyzer	Rhode & Schwarz ZVA	SN100132	02/2013	02/2016
Calipers	Carrera	CALIPER-01	12/2013	12/2016
Reference Probe	Satimo	EPG122 SN 18/11	Characterized prior to test. No cal required.	Characterized prior to test. No cal required.
Multimeter	Keithley 2000	1188656	12/2013	12/2016
Signal Generator	Agilent E4438C	MY49070581	12/2013	12/2016
Amplifier	Aethercomm	SN 046	Characterized prior to test. No cal required.	Characterized prior to test. No cal required.
Power Meter	HP E4418A	US38261498	12/2013	12/2016
Power Sensor	HP ECP-E26A	US37181460	12/2013	12/2016
Directional Coupler	Narda 4216-20	01386	Characterized prior to test. No cal required.	Characterized prior to test. No cal required.
Temperature and Humidity Sensor	Control Company	11-661-9	8/2012	8/2015