



BT Test Report

Application Purpose : Original grant
Applicant Name: : TECNO MOBILE LIMITED
FCC ID : 2ADYY- T349
Equipment Type : Mobile Phone
Model Name : T349
Report Number : FCC16073806-2
Standard(S) : FCC Part 15 Subpart C
Date Of Receipt : July 14, 2016
Date Of Issue : August 03, 2016

Test By : 
(Daisy Qin)

Reviewed By : 
(Sol Qin)

Authorized by : 
(Michal Ling)

Prepared by : **QTC Certification & Testing Co., Ltd.**
2nd Floor, BI Building, Fengyeyuan Industrial Plant,, Liuxian
2st. Road, Xin'an Street, Bao'an District,, Shenzhen, 518000
(Registration Number: 588523)

REPORT REVISE RECORD

Report Version	Revise Time	Issued Date	Valid Version	Notes
V1.0	/	August 03, 2016	Valid	Original Report
V1.1	August 18, 2016	August 03, 2016	Valid	Original Report

Table of Contents	Page
1. GENERAL INFORMATION	5
2. TEST DESCRIPTION	7
2.1 MEASUREMENT UNCERTAINTY	7
2.2 DESCRIPTION OF TEST MODES	8
2.3 TABLE OF PARAMETERS OF TEXT SOFTWARE SETTING	9
2.4 CONFIGURATION OF SYSTEM UNDER TEST	9
2.5 DESCRIPTION OF SUPPORT UNITS (CONDUCTED MODE)	10
3. SUMMARY OF TEST RESULTS	11
4. MEASUREMENT INSTRUMENTS	12
5. EMC EMISSION TEST	13
5.1 CONDUCTED EMISSION MEASUREMENT	13
5.1.1 POWER LINE CONDUCTED EMISSION LIMITS	13
5.1.2 TEST PROCEDURE	14
5.1.3 DEVIATION FROM TEST STANDARD	14
5.1.4 TEST SETUP	14
5.1.5 EUT OPERATING CONDITIONS	14
5.1.6 TEST RESULTS	15
5.2 RADIATED EMISSION MEASUREMENT	17
5.2.1 RADIATED EMISSION LIMITS	17
5.2.2 TEST PROCEDURE	18
5.2.3 DEVIATION FROM TEST STANDARD	18
5.2.4 TEST SETUP	19
5.2.5 EUT OPERATING CONDITIONS	20
5.2.5.1 RESULTS (BELOW 30 MHZ)	21
5.2.5.2 TEST RESULTS (BETWEEN 30M – 1000 MHZ)	22
5.2.5.3 TEST RESULTS(1GHZ TO 25GHZ)	24
5.3 CONDUCTED SPURIOUS EMISSION MEASUREMENT	32
5.3.1 CONDUCTED SPURIOUS EMISSION LIMITS	32
5.3.2 TEST PROCEDURE	32
5.3.3 DEVIATION FROM STANDARD	32
5.3.4 TEST SETUP	32
5.3.5 EUT OPERATION CONDITIONS	32
5.3.6 TEST RESULTS	33
6. NUMBER OF HOPPING CHANNEL	
6.1 APPLIED PROCEDURES / LIMIT	41
6.2 TEST PROCEDURE	41
6.3 DEVIATION FROM STANDARD	41

Table of Contents	Page
6.4 TEST SETUP	41
6.5 EUT OPERATION CONDITIONS	41
6.6 TEST RESULTS	42
7. AVERAGE TIME OF OCCUPANCY	
7.1 APPLIED PROCEDURES / LIMIT	43
7.2 TEST PROCEDURE	43
7.3 DEVIATION FROM STANDARD	43
7.4 TEST SETUP	43
7.5 EUT OPERATION CONDITIONS	43
7.6 TEST RESULTS	44
8. HOPPING CHANNEL SEPARATION MEASUREMENT	
8.1 APPLIED PROCEDURES / LIMIT	46
8.2 TEST PROCEDURE	46
8.3 DEVIATION FROM STANDARD	46
8.4 TEST SETUP	46
8.5 EUT OPERATION CONDITIONS	46
8.6 TEST RESULTS	47
9. BANDWIDTH TEST	
9.1 APPLIED PROCEDURES / LIMIT	53
9.2 TEST PROCEDURE	53
9.3 DEVIATION FROM STANDARD	53
9.4 TEST SETUP	53
9.5 EUT OPERATION CONDITIONS	53
9.6 TEST RESULTS	54
10. PEAK OUTPUT POWER TEST	
10.1 APPLIED PROCEDURES / LIMIT	60
10.2 TEST PROCEDURE	60
10.3 DEVIATION FROM STANDARD	60
10.4 TEST SETUP	60
10.5 EUT OPERATION CONDITIONS	60
10.6 TEST RESULTS	61
11. ANTENNA APPLICATION	66
12. EUT TEST PHOTO	67
13. PHOTOGRAPHS OF EUT	69

1. GENERAL INFORMATION

GENERAL DESCRIPTION OF EUT

Test Model	T349
Applicant	TECNO MOBILE LIMITED
Address	ROOMS 05-15, 13A/F., SOUTH TOWER, WORLD FINANCE CENTRE, HARBOUR CITY, 17 CANTON ROAD, TSIM SHA TSUI, KOWLOON, HONG KONG
Manufacturer	SHENZHEN TECNO TECHNOLOGY CO.,LTD.
Address	1-4th Floor,3rd Building,Pacific Industrial Park,No.2088,Shenyan Road,Yantian District,Shenzhen,Guangdong,China
Equipment Type	Mobile Phone
Brand Name	TECNO
Hardware version:	T349-DL181-SAM-20160702
Software version:	PCBA-MB-DL181-V00-MTK
Battery information:	Li-ion Battery: BL-5CAT Batterie :4.255Wh Voltage: 3.7V Capacity: 1150mAh Limited Charge Voltage: 4.2V
Adapter Information:	Adapter : A31-500500 Input: AC 100-240V 50/60Hz 0.2A Output: DC 5V 500mA
Operating Frequency	2402-2480MHz
Channels	79
Channel Spacing	1MHz
Modulation Type	GFSK, $\pi/4$ -DQPSK, 8-DPSK
Version	3.0
Antenna Type:	Integral Antenna
Antenna gain:	-1dBi
Data of receipt	July 14, 2016
Date of test	July 14, 2016 to July 24, 2016
Deviation	None
Condition of Test Sample	Normal

We hereby certify that:

All measurement facilities used to collect the measurement data are located at
2nd Floor, BI Building, Fengyeyuan Industrial Plant,, Liuxian 2st. Road, Xin'an Street, Bao'an
District,, Shenzhen, 518000

The data evaluation, test procedures, and equipment configurations shown in this report were made in
accordance with the procedures given in ANSI C 63.4:2014. The sample tested as described in this
report is in compliance with the FCC Rules Part 15 Subpart C.

ALL the testing were referenced KDB NO.453039

The test results of this report relate only to the tested sample identified in this report.

2. TEST DESCRIPTION

2.1 MEASUREMENT UNCERTAINTY

The reported uncertainty of measurement $y \pm U$, where expanded uncertainty U is based on a standard uncertainty multiplied by a coverage factor of $k=2$, providing a level of confidence of approximately **95** %.

No.	Item	Uncertainty
1	Conducted Emission Test	± 3.2 dB
2	RF power, conducted	± 0.16 dB
3	Spurious emissions, conducted	± 0.21 dB
4	All emissions, radiated(<1G)	± 4.7 dB
5	All emissions, radiated(>1G)	± 4.7 dB
6	Temperature	± 0.5 °C
7	Humidity	± 2 %

2.2 DESCRIPTION OF TEST MODES

To investigate the maximum EMI emission characteristics generated from EUT, the test system was pre-scanning tested based on the consideration of following EUT operation mode or test configuration mode which possibly have effect on EMI emission level. Each of these EUT operation mode(s) or test configuration mode(s) mentioned above was evaluated respectively.

Pretest Mode	Description
Mode 1	CH00
Mode 2	CH39
Mode 3	CH78
Mode 4	Normal Hopping

For Conducted Emission	
Final Test Mode	Description
Mode 4	Normal Hopping

For Radiated Emission	
Final Test Mode	Description
Mode 1	CH00
Mode 2	CH39
Mode 3	CH78

Note:

- (1) The measurements are performed at the highest, middle, lowest available channels.**
- (2) The data rate was set in 1Mbps, 2 Mbps, 3 Mbps for radiated emission due to the highest RF output power.**
- (3) Record the worst case of each test item in this report.**

2.3 TABLE OF PARAMETERS OF TEXT SOFTWARE SETTING

During testing channel & power controlling software provided by the customer was used to control the operating channel as well as the output power level. The RF output power selection is for the setting of RF output power expected by the customer and is going to be fixed on the firmware of the final end product power parameters of FHSS

Test software Version	N/A		
Test program	N/A		
Frequency	2402 MHz	2441 MHz	2480 MHz
Parameters(1Mbps)	DEF	DEF	DEF
Parameters(2Mbps)	DEF	DEF	DEF
Parameters(3Mbps)	DEF	DEF	DEF

2.4 CONFIGURATION OF SYSTEM UNDER TEST

(1)Conducted emission measurement

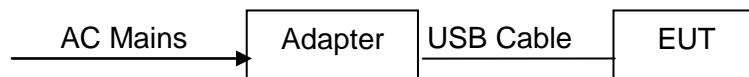

(2)Radiated emission measurement



(EUT: Mobile Phone)

I/O Port of EUT			
I/O Port Type	Q'TY	Cable	Tested with
USB port	1	1m cable, unshielded, fixed with adaptor	1
Note: the AC Adaptor with a fixed cable that is marketed with the device and tested			

2.5 DESCRIPTION OF SUPPORT UNITS (CONDUCTED MODE)

The EUT has been tested as an independent unit together with other necessary accessories or support units. The following support units or accessories were used to form a representative test configuration during the tests.

Item	Equipment	Mfr/Brand	Model/Type No.	Series No.	Note
1	/	/	/	/	/

Note:

- (1) The support equipment was authorized by Declaration of Confirmation.
- (2) For detachable type I/O cable should be specified the length in cm in 『Length』 column.
- (3) “YES” is means “shielded” “with core”; “NO” is means “unshielded” “without core”.
- (4) The adapter supply by the applicant.

3. SUMMARY OF TEST RESULTS

Test procedures according to the technical standards:

FCC Part15 (15.247) , Subpart C			
Standard Section	Test Item	Judgment	Remark
15.207	Conducted Emission	PASS	
15.247(a)(1)	Hopping Channel Separation	PASS	
15.247(b)(1)	Peak Output Power	PASS	
15.247(c)	Radiated Spurious Emission	PASS	
15.247(d)	Conducted Spurious Emission	PASS	
15.247(a)(iii)	Number of Hopping Frequency	PASS	
15.247(a)(iii)	Dwell Time	PASS	
15.247(a)(1)	Bandwidth	PASS	
15.205	Band Edge Emission	PASS	
15.203	Antenna Requirement	PASS	

NOTE:

(1) "N/A" denotes test is not applicable in this test report.

4. MEASUREMENT INSTRUMENTS

Kind of Equipment	Manufacturer	Type No.	Serial No.	Last Calibrated	Calibrated until
ESPI Test Receiver	R&S	ESPI	100379	08/19/2015	08/18/2016
EMI Test Receiver	R&S	ESCI	100005	08/19/2015	08/18/2016
LISN	AFJ	LS16	16010222119	08/19/2015	08/18/2016
LISN(EUT)	Mestec	AN3016	04/10040	08/19/2015	08/18/2016
Ultra Broadband ANT	R&S	HL562	100157	08/19/2015	08/18/2016
pre-amplifier	CDSI	PAP-1G18-38	--	08/19/2015	08/18/2016
System Controller	CT	SC100	-	08/19/2015	08/18/2016
Bi-log Antenna	Chase	CBL6111C	2576	08/19/2015	08/18/2016
Spectrum analyzer	R&S	FSU26	200409	08/19/2015	08/18/2016
Spectrum Analyzer	Aglient	E4440A	MY42510159	12/02/2015	12/01/2016-
Horn Antenna	SCHWARZBECK	9120D	1141	08/19/2015	08/18/2016
Bi-log Antenna	Schwarebeck	VULB9163	9163/340	08/19/2015	08/18/2016
Loop Antenna	EMCO	6502	00042960	08/22/2015	08/21/2016
Pre Amplifier	H.P.	HP8447E	2945A02715	10/13/2015	10/12/2016
9*6*6 Anechoic	--	--	--	08/21/2015	08/20/2016
Horn Antenna	COMPLIANCE ENGINEERING	CE18000	--	09/13/2015	09/12/2016
Power meter	Anritsu	ML2487A	6K00003613	08/23/2015	08/22/2016
H & T Chamber	Guangzhou gongwen	GDJS-500-40	0329	08/19/2015	08/18/2016
EXA Signal Analyzer	Aglient	N9020A	--	08/19/2015	08/18/2016
Power sensor	Anritsu	MA2482D	--	08/19/2015	08/18/2016
RF cable	H+S	SUCOFLEX 102	--	08/19/2015	08/18/2016
Horn Antenna	SCHWARZBECK	BBHA 9170	1123	08/19/2015	08/18/2016

5. EMC EMISSION TEST

5.1 CONDUCTED EMISSION MEASUREMENT

5.1.1 POWER LINE CONDUCTED EMISSION Limits (Frequency Range 150KHz-30MHz)

FREQUENCY (MHz)	Class A (dBuV)		Class B (dBuV)		Standard
	Quasi-peak	Average	Quasi-peak	Average	
0.15 -0.5	79.00	66.00	66 - 56 *	56 - 46 *	FCC
0.50 -5.0	73.00	60.00	56.00	46.00	FCC
5.0 -30.0	73.00	60.00	60.00	50.00	FCC

Note:

- (1) The tighter limit applies at the band edges.
- (2) The limit of " * " marked band means the limitation decreases linearly with the logarithm of the frequency in the range.

The following table is the setting of the receiver

Receiver Parameters	Setting
Attenuation	10 dB
Start Frequency	0.15 MHz
Stop Frequency	30 MHz
IF Bandwidth	9 kHz

5.1.2 TEST PROCEDURE

- The EUT was placed 0.4 meters from the horizontal ground plane with EUT being connected to the power mains through a line impedance stabilization network (LISN). All other support equipments powered from additional LISN(s). The LISN provide 50 Ohm/ 50uH of coupling impedance for the measuring instrument.
- Interconnecting cables that hang closer than 40 cm to the ground plane shall be folded back and forth in the center forming a bundle 30 to 40 cm long.
- I/O cables that are not connected to a peripheral shall be bundled in the center. The end of the cable may be terminated, if required, using the correct terminating impedance. The overall length shall not exceed 1 m.
- LISN at least 80 cm from nearest part of EUT chassis.
- For the actual test configuration, please refer to the related Item –EUT Test Photos.

5.1.3 DEVIATION FROM TEST STANDARD

No deviation

5.1.4 TEST SETUP

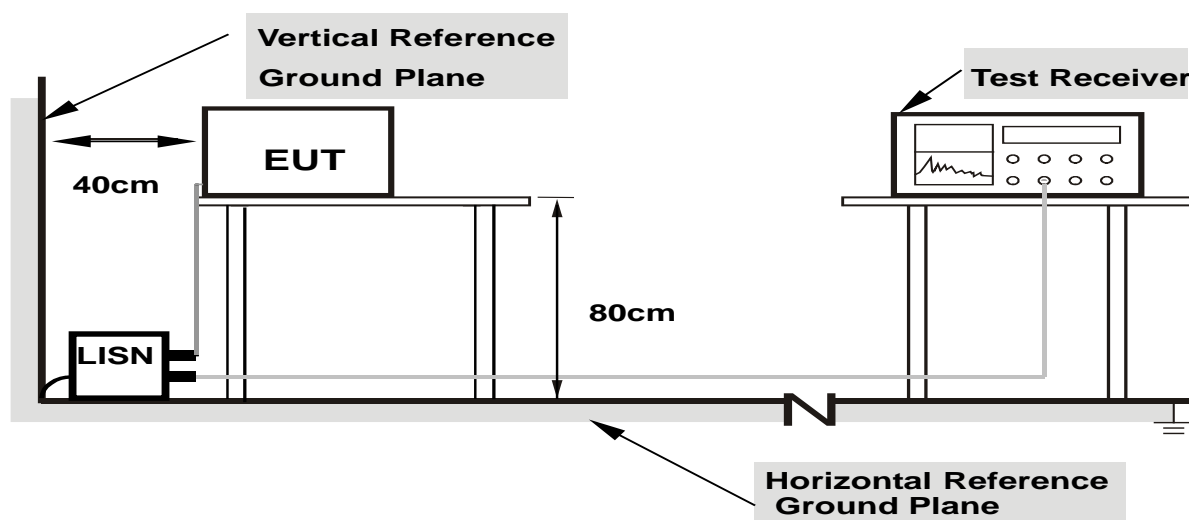

- Note: 1.Support units were connected to second LISN.**
2.Both of LISNs (AMN) are 80 cm from EUT and at least 80 cm from other units and other metal planes

5.1.5 EUT OPERATING CONDITIONS

The EUT was configured for testing in a typical fashion (as a customer would normally use it). The EUT has been programmed to continuously transmit during test. This operating condition was tested and used to collect the included data.

5.1.6 TEST RESULTS

EUT	Mobile Phone	Model Name	T349
Temperature	26 °C	Relative Humidity	54%
Pressure	1010hPa	Phase	L
Test Date	July 15, 2016	Test Mode	Mode 4
Voltage	120V/60Hz		

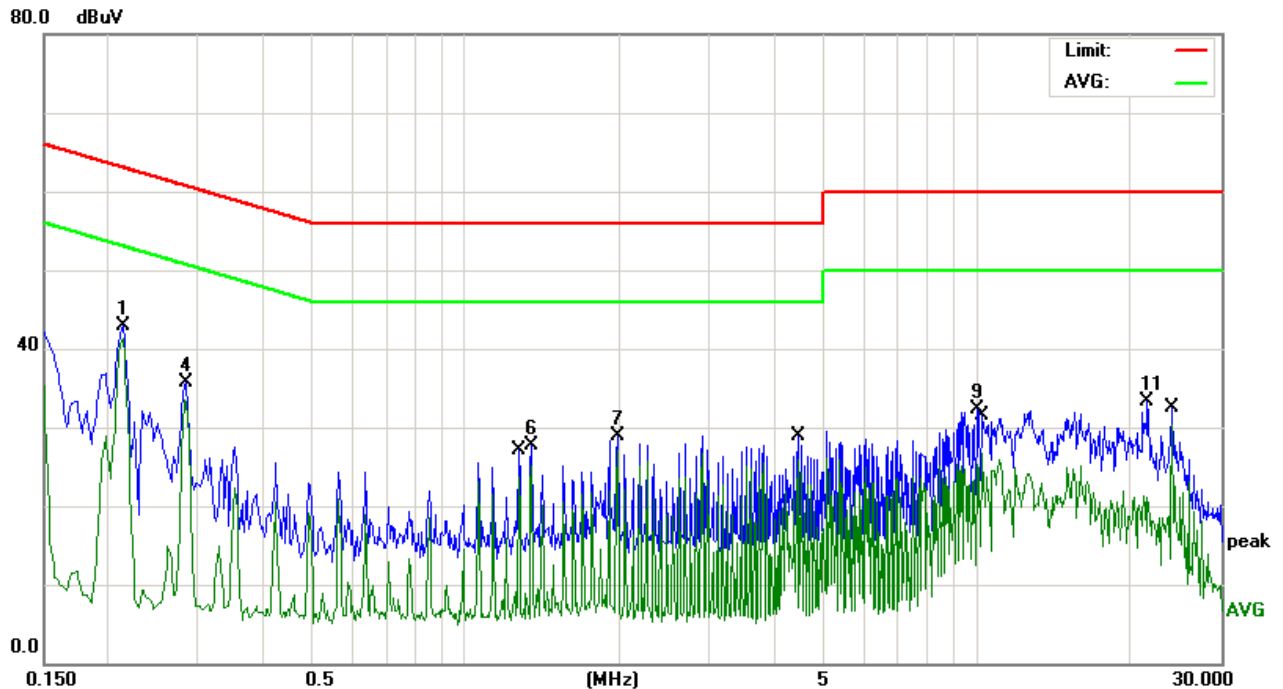

No.	Mk.	Freq. MHz	Reading Level dBuV	Correct Factor dB	Measure- ment dBuV	Limit dBuV	Over dB	Detector
1		0.2140	32.58	10.35	42.93	63.04	-20.11	peak
2	*	0.2140	30.96	10.35	41.31	53.04	-11.73	AVG
3		0.2819	22.91	10.59	33.50	50.76	-17.26	AVG
4		0.2860	25.16	10.60	35.76	60.64	-24.88	peak
5		1.2740	13.15	10.58	23.73	46.00	-22.27	AVG
6		1.3460	17.11	10.58	27.69	56.00	-28.31	peak
7		1.9820	18.26	10.60	28.86	56.00	-27.14	peak
8		4.4580	15.31	10.67	25.98	46.00	-20.02	AVG
9		10.0460	21.83	10.40	32.23	60.00	-27.77	peak
10		10.1860	16.29	10.40	26.69	50.00	-23.31	AVG
11		21.5500	22.92	10.38	33.30	60.00	-26.70	peak
12		24.0340	19.95	10.37	30.32	50.00	-19.68	AVG

Remark: All the modes have been investigated, and only worst mode is presented in this report.

EUT	Mobile Phone	Model Name	T349
Temperature	26 °C	Relative Humidity	54%
Pressure	1010hPa	Phase	N
Test Date	July 15, 2016	Test Mode	Mode 4
Voltage	120V/60Hz		

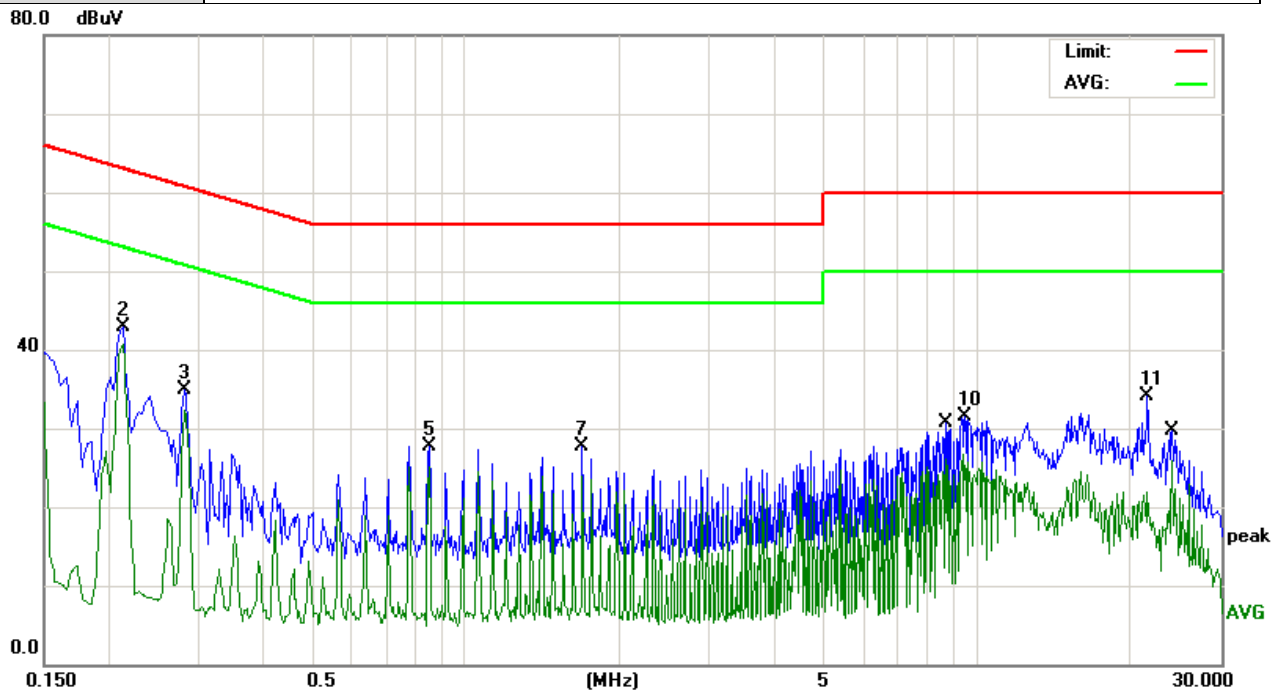

No.	Mk.	Freq. MHz	Reading Level dBuV	Correct Factor dB	Measure- ment dBuV	Limit dBuV	Over dB	Detector
1	*	0.2117	29.64	10.34	39.98	53.13	-13.15	AVG
2		0.2140	32.61	10.35	42.96	63.04	-20.08	peak
3		0.2819	24.40	10.59	34.99	60.76	-25.77	peak
4		0.2819	21.74	10.59	32.33	50.76	-18.43	AVG
5		0.8500	17.01	10.72	27.73	56.00	-28.27	peak
6		0.8500	14.29	10.72	25.01	46.00	-20.99	AVG
7		1.6980	17.07	10.59	27.66	56.00	-28.34	peak
8		1.6980	13.26	10.59	23.85	46.00	-22.15	AVG
9		8.6940	15.63	10.48	26.11	50.00	-23.89	AVG
10		9.4700	21.09	10.43	31.52	60.00	-28.48	peak
11		21.5540	23.66	10.38	34.04	60.00	-25.96	peak
12		24.0340	15.48	10.37	25.85	50.00	-24.15	AVG

Remark: All the modes have been investigated, and only worst mode is presented in this report.

5.2 RADIATED EMISSION MEASUREMENT

5.2.1 RADIATED EMISSION LIMITS (Frequency Range 9kHz-1000MHz)

20dBc in any 100 kHz bandwidth outside the operating frequency band. In case the emission fall within the restricted band specified on 15.205(a), then the 15.209(a) limit in the table below has to be followed.

Frequencies (MHz)	Field Strength (micorvolts/meter)	Measurement Distance (meters)
0.009~0.490	2400/F(KHz)	300
0.490~1.705	24000/F(KHz)	30
1.705~30.0	30	30
30~88	100	3
88~216	150	3
216~960	200	3
Above 960	500	3

LIMITS OF RADIATED EMISSION MEASUREMENT (Above 1000MHz)

FREQUENCY (MHz)	Limit (dBuV/m) (at 3M)	
	PEAK	AVERAGE
Above 1000	74	54

Notes:

- (1) The limit for radiated test was performed according to FCC PART 15C.
- (2) The tighter limit applies at the band edges.
- (3) Emission level (dBuV/m)=20log Emission level (uV/m).

Spectrum Parameter	Setting
Attenuation	Auto
Start Frequency	1000 MHz
Stop Frequency	10th carrier harmonic
RB / VB (emission in restricted band)	1 MHz / 1 MHz for Peak, 1 MHz / 10Hz for Average

Receiver Parameter	Setting
Attenuation	Auto
Start ~ Stop Frequency	9kHz~150kHz / RB 200Hz for QP
Start ~ Stop Frequency	150kHz~30MHz / RB 9kHz for QP
Start ~ Stop Frequency	30MHz~1000MHz / RB 120kHz for QP

5.2.2 TEST PROCEDURE

- a. The measuring distance of at 3 m shall be used for measurements at frequency up to 1GHz. For frequencies above 1GHz, any suitable measuring distance may be used.
- b. The EUT was placed on the top of a rotating table 0.8 meters above the ground at a 3 meter open area test site. The table was rotated 360 degrees to determine the position of the highest radiation.
- c. The height of the equipment or of the substitution antenna shall be 0.8 m; the height of the test antenna shall vary between 1 m to 4 m. Both horizontal and vertical polarizations of the antenna are set to make the measurement.
- d. The initial step in collecting conducted emission data is a spectrum analyzer peak detector mode pre-scanning the measurement frequency range. Significant peaks are then marked and then Quasi Peak detector mode re-measured.
- e. If the Peak Mode measured value compliance with and lower than Quasi Peak Mode Limit, the EUT shall be deemed to meet QP Limits and then no additional QP Mode measurement performed.
- f. For the actual test configuration, please refer to the related Item –EUT Test Photos.

Note:

Both horizontal and vertical antenna polarities were tested and performed pretest to three orthogonal axis. The worst case emissions were reported

5.2.3 DEVIATION FROM TEST STANDARD

No deviation

5.2.4 TEST SETUP

(A) Radiated Emission Test-Up Frequency Below 30MHz

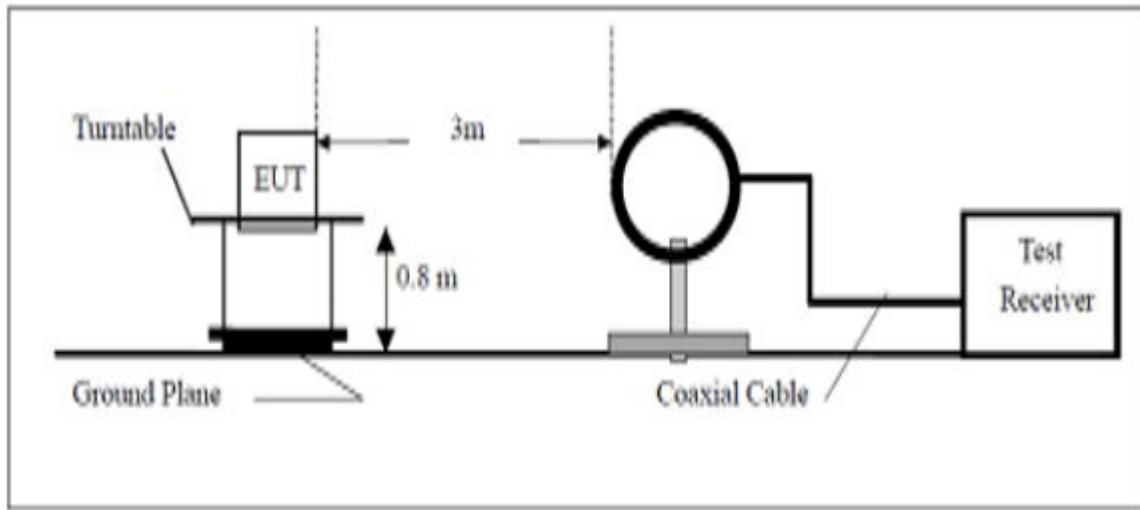

(B) Radiated Emission Test-Up Frequency 30MHz~1GHz

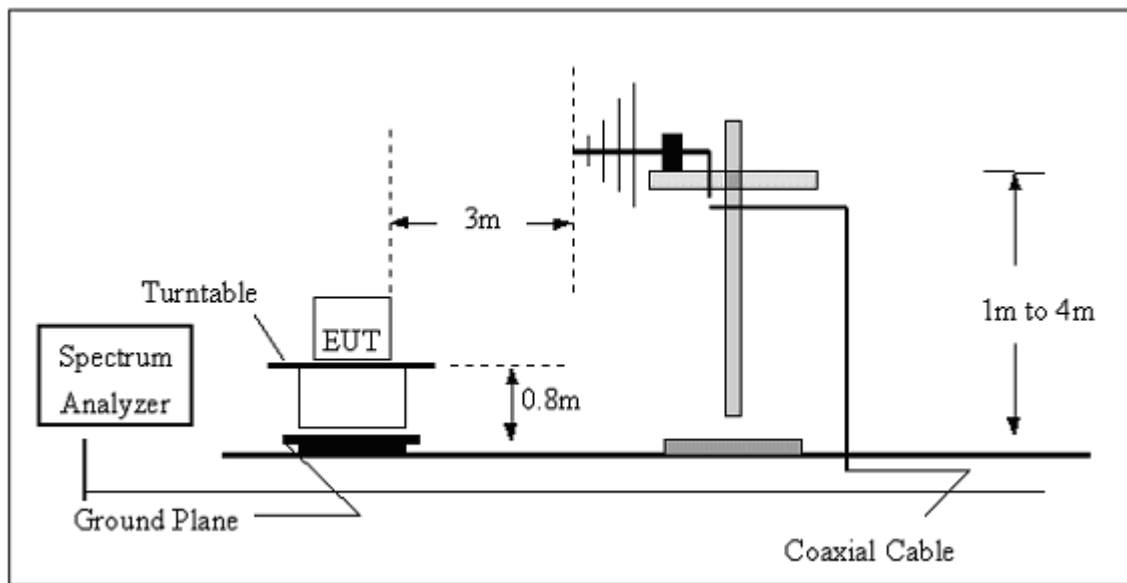

(C) Radiated Emission Test-Up Frequency Above 1GHz

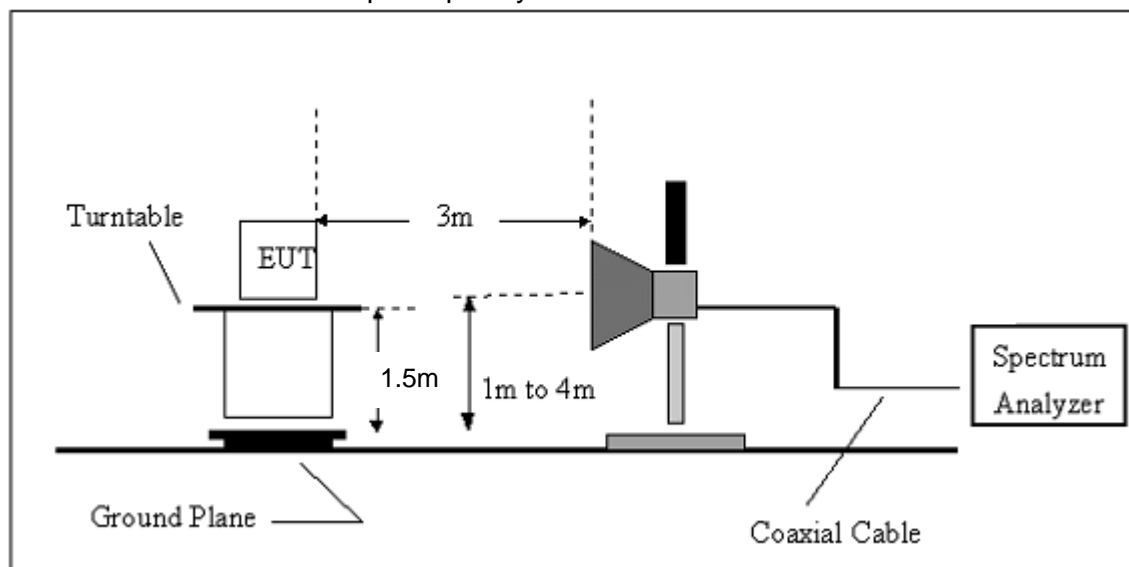
**5.2.5 EUT OPERATING CONDITIONS**

The EUT tested system was configured as the statements of 2.4 Unless otherwise a special operating condition is specified in the follows during the testing.

5.2.5.1 RESULTS (BELOW 30 MHZ)

EUT	Mobile Phone	Model Name	T349
Temperature	20 °C	Relative Humidity	48%
Pressure	1010 hPa	Polarization	---
Test Mode	Mode 1/ Mode 2/ Mode 3/Mode 4	Test Date	July 15, 2016

Freq.	Reading	Limit	Margin	State
(MHz)	(dBuV/m)	(dBuV/m)	(dB)	P/F
--	--	--	--	P
--	--	--	--	P

NOTE:

No result in this part for margin above 20dB.

Distance extrapolation factor = $20 \log (\text{specific distance}/\text{test distance})(\text{dB})$;

Limit line = specific limits(dBuV) + distance extrapolation factor.

5.2.5.2 TEST RESULTS (BETWEEN 30M – 1000 MHZ)

EUT	Mobile Phone	Model Name	T349
Temperature	20 °C	Relative Humidity	48%
Pressure	1010 hPa	Polarization	Horizontal
Test Mode	Mode 1 with 1Mbps(GFSK)	Test Date	July 15, 2016

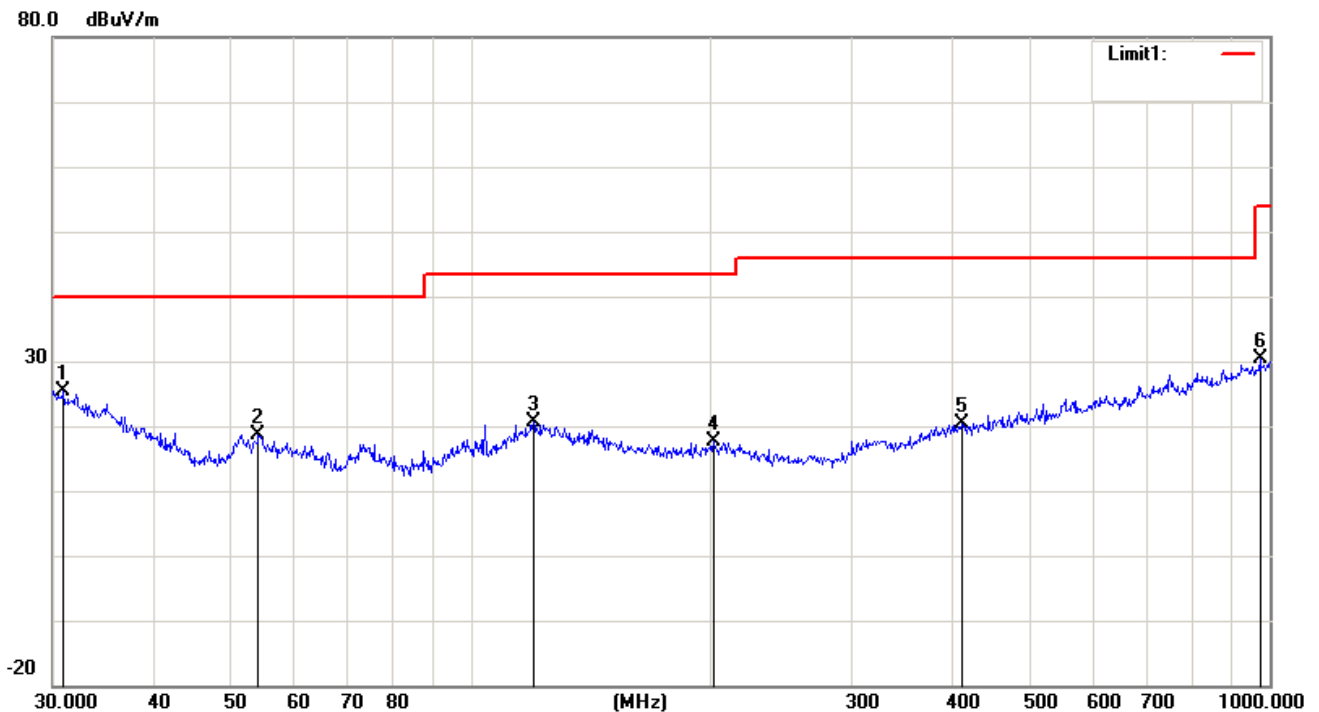

No.	Mk.	Freq. MHz	Reading Level dBuV	Correct Factor dB	Measure- ment dBuV/m	Limit dBuV/m	Over dB	Detector
1	*	30.9619	22.59	2.85	25.44	40.00	-14.56	peak
2		54.2610	28.07	-9.43	18.64	40.00	-21.36	peak
3		119.8556	22.87	-2.33	20.54	43.50	-22.96	peak
4		201.3930	22.38	-4.87	17.51	43.50	-25.99	peak
5		411.8240	22.29	-2.02	20.27	46.00	-25.73	peak
6		972.3374	7.66	22.63	30.29	54.00	-23.71	peak

Remark: All the modes have been investigated, and only worst mode is presented in this report.

EUT	Mobile Phone	Model Name	T349
Temperature	20 °C	Relative Humidity	48%
Pressure	1010 hPa	Polarization	Vertical
Test Mode	Mode 1 with 1Mbps(GFSK)	Test Date	July 15, 2016

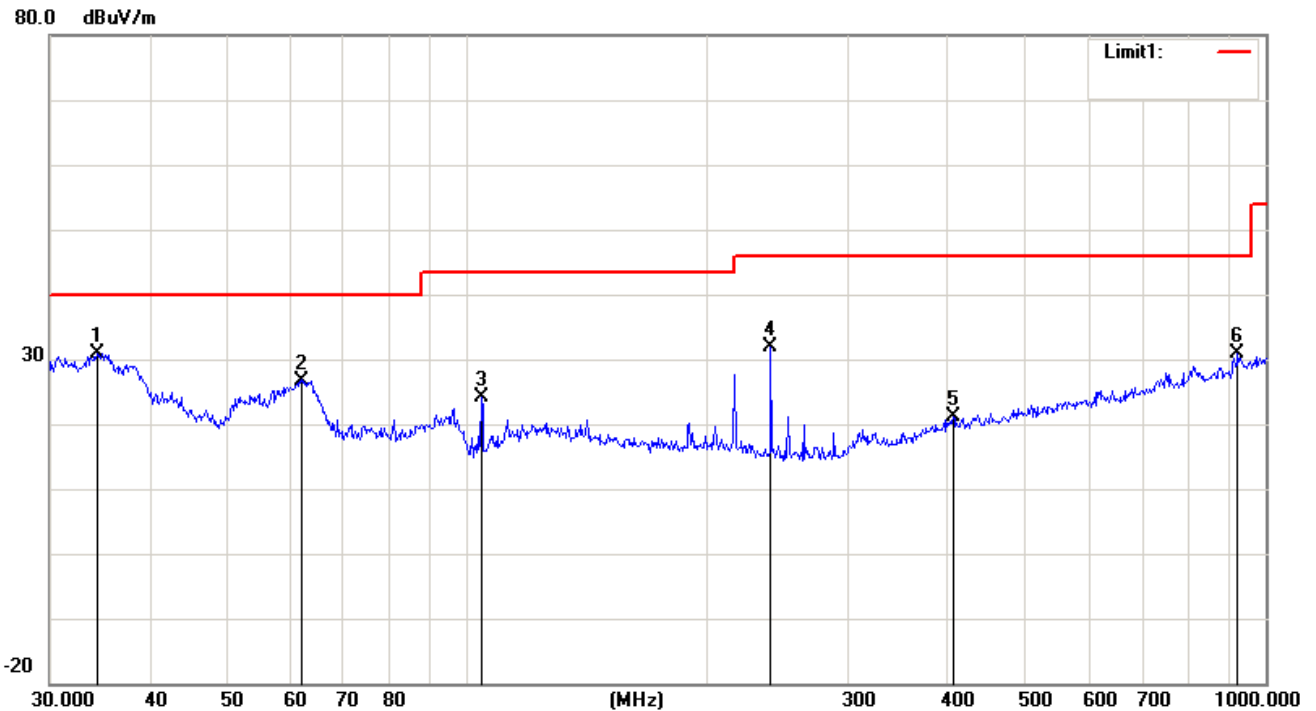

No.	Mk.	Freq. MHz	Reading Level dBuV	Correct Factor dB	Measure- ment dBuV/m	Limit dBuV/m	Over dB	Detector
1	*	34.3964	30.23	0.54	30.77	40.00	-9.23	peak
2		61.9951	35.90	-9.15	26.75	40.00	-13.25	peak
3		104.1701	29.29	-5.18	24.11	43.50	-19.39	peak
4		239.9874	38.22	-6.24	31.98	46.00	-14.02	peak
5		406.0880	23.16	-2.12	21.04	46.00	-24.96	peak
6		922.5157	24.10	6.70	30.80	46.00	-15.20	peak

Remark: All the modes have been investigated, and only worst mode is presented in this report.

5.2.5.3 TEST RESULTS(1GHZ TO 25GHZ)

Note: *the worst case is 1Mbps(GFSK)mode as result in this part.*

EUT	Mobile Phone	Model Name	T349
Temperature	20 °C	Relative Humidity	48%
Pressure	1010 hPa	Test Mode	Mode 1 TX(1Mbps)
Test Date	July 15, 2016		

Freq. (MHz)	Ant. Pol.	Emission Level(dBuV)		Limit 3m(dBuV/m)		Over(dB)	
		PK	AV	PK	AV	PK	AV
4804	V	58.09	39.92	74	54	-15.91	-14.08
7206	V	58.04	39.91	74	54	-15.96	-14.09
4804	H	58.31	39.94	74	54	-15.69	-14.06
7206	H	58.35	39.35	74	54	-15.65	-14.65

Remark:

All emissions not reported were more than 20dB below the specified limit or in the noise floor.
All the x/y/z orientation has been investigated, and only worst case is presented in this report.

EUT	Mobile Phone	Model Name	T349
Temperature	20 °C	Relative Humidity	48%
Pressure	1010 hPa	Test Mode	Mode 2 TX(1Mbps)
Test Date	July 15, 2016		

Freq. (MHz)	Ant.Pol.	Emission Level(dBuV)		Limit 3m(dBuV/m)		Over(dB)	
		PK	AV	PK	AV	PK	AV
4882	V	58.78	41.89	74	54	-15.22	-12.11
7323	V	59.26	40.40	74	54	-14.74	-13.60
4882	H	59.55	39.34	74	54	-14.45	-14.66
7323	H	59.61	40.61	74	54	-14.39	-13.39

Remark:

All emissions not reported were more than 20dB below the specified limit or in the noise floor.
All the x/y/z orientation has been investigated, and only worst case is presented in this report.

EUT	Mobile Phone	Model Name	T349
Temperature	20 °C	Relative Humidity	48%
Pressure	1010 hPa	Test Mode	Mode 3 TX(1Mbps)
Test Date	July 15, 2016		

Freq. (MHz)	Ant.Pol.	Emission Level(dBuV)		Limit 3m(dBuV/m)		Over(dB)	
		PK	AV	PK	AV	PK	AV
4960	V	59.64	39.77	74	54	-14.36	-14.23
7440	V	58.99	39.24	74	54	-15.01	-14.76
4960	H	58.69	40.99	74	54	-15.31	-13.01
7440	H	58.84	39.84	74	54	-15.16	-14.16

Remark:

All emissions not reported were more than 20dB below the specified limit or in the noise floor.
All the x/y/z orientation has been investigated, and only worst case is presented in this report.

5.2.5.4 TEST RESULTS (Restricted Bands Requirements)

Test result for 1Mbps Mode:

EUT	Mobile Phone	Model Name	T349
Temperature	20 °C	Relative Humidity	48%
Pressure	1010 hPa	Test Date	July 15, 2016
Test Mode	TX /2402MHz-1Mbps	Polarization	Vertical

Frequency (MHz)	Meter Reading (dBμV)	Factor (dB)	Emission Level (dBμV/m)	Limits (dBμV/m)	Margin (dB)	Detector Type
2382	62.61	-8.76	53.85	74	20.15	peak
2382	54.23	-8.76	45.47	54	8.53	AVG
2390	61.47	-8.73	52.74	74	21.26	peak
2390	54.86	-8.73	46.13	54	7.87	AVG

Remark:

Factor = Antenna Factor + Cable Loss – Pre-amplifier.

All the x/y/z orientation has been investigated, and only worst case is presented in this report.

EUT	Mobile Phone	Model Name	T349
Temperature	20 °C	Relative Humidity	48%
Pressure	1010 hPa	Test Date	July 15, 2016
Test Mode	TX /2402MHz-1Mbps	Polarization	Horizontal

Frequency (MHz)	Meter Reading (dBμV)	Factor (dB)	Emission Level (dBμV/m)	Limits (dBμV/m)	Margin (dB)	Detector Type
2376	60.30	-8.78	51.52	74	22.48	peak
2376	53.02	-8.78	44.24	54	9.76	AVG
2390	59.80	-8.73	51.07	74	22.93	peak
2390	55.05	-8.73	46.32	54	7.68	AVG

Remark:

Factor = Antenna Factor + Cable Loss – Pre-amplifier.

All the x/y/z orientation has been investigated, and only worst case is presented in this report.

EUT	Mobile Phone	Model Name	T349
Temperature	20 °C	Relative Humidity	48%
Pressure	1010 hPa	Test Date	July 15, 2016
Test Mode	TX /2480MHz-1Mbps	Polarization	Vertical

Frequency	Meter Reading	Factor	Emission Level	Limits	Margin	Detector Type
(MHz)	(dBμV)	(dB)	(dBμV/m)	(dBμV/m)	(dB)	
2483.5	60.71	-8.17	52.54	74	21.46	peak
2483.5	54.50	-8.17	46.33	54	7.67	AVG

Remark:

Factor = Antenna Factor + Cable Loss – Pre-amplifier.

All the x/y/z orientation has been investigated, and only worst case is presented in this report.

EUT	Mobile Phone	Model Name	T349
Temperature	20 °C	Relative Humidity	48%
Pressure	1010 hPa	Test Date	July 15, 2016
Test Mode	TX /2480MHz-1Mbps	Polarization	Horizontal

Frequency	Meter Reading	Factor	Emission Level	Limits	Margin	Detector Type
(MHz)	(dBμV)	(dB)	(dBμV/m)	(dBμV/m)	(dB)	
2483.5	64.10	-8.17	55.93	74	18.07	peak
2483.5	54.26	-8.17	46.09	54	7.91	AVG

Remark:

Factor = Antenna Factor + Cable Loss – Pre-amplifier.

All the x/y/z orientation has been investigated, and only worst case is presented in this report.

Test result for 3Mbps Mode:

EUT	Mobile Phone	Model Name	T349
Temperature	20 °C	Relative Humidity	48%
Pressure	1010 hPa	Test Date	July 15, 2016
Test Mode	TX /2402MHz-3Mbps	Polarization	Vertical

Frequency	Meter Reading	Factor	Emission Level	Limits	Margin	Detector Type
(MHz)	(dB μ V)	(dB)	(dB μ V/m)	(dB μ V/m)	(dB)	
2387	62.71	-8.74	53.97	74	20.03	peak
2387	55.19	-8.74	46.45	54	7.55	AVG
2390	59.04	-8.73	50.31	74	23.69	peak
2390	56.76	-8.73	48.03	54	5.97	AVG

Remark:

Factor = Antenna Factor + Cable Loss – Pre-amplifier.

All the x/y/z orientation has been investigated, and only worst case is presented in this report.

EUT	Mobile Phone	Model Name	T349
Temperature	20 °C	Relative Humidity	48%
Pressure	1010 hPa	Test Date	July 15, 2016
Test Mode	TX /2402MHz-3Mbps	Polarization	Horizontal

Frequency	Meter Reading	Factor	Emission Level	Limits	Margin	Detector Type
(MHz)	(dB μ V)	(dB)	(dB μ V/m)	(dB μ V/m)	(dB)	
2384	60.45	-8.75	51.70	74	22.30	peak
2384	53.66	-8.75	44.91	54	9.09	AVG
2390	60.15	-8.73	51.42	74	22.58	peak
2390	54.12	-8.73	45.39	54	8.61	AVG

Remark:

Factor = Antenna Factor + Cable Loss – Pre-amplifier.

All the x/y/z orientation has been investigated, and only worst case is presented in this report.

EUT	Mobile Phone	Model Name	T349
Temperature	20 °C	Relative Humidity	48%
Pressure	1010 hPa	Test Date	July 15, 2016
Test Mode	TX /2480MHz-3Mbps	Polarization	Vertical

Frequency	Meter Reading	Factor	Emission Level	Limits	Margin	Detector Type
(MHz)	(dBμV)	(dB)	(dBμV/m)	(dBμV/m)	(dB)	
2483.5	61.71	-8.17	53.54	74	20.46	peak
2483.5	54.92	-8.17	46.75	54	7.25	AVG

Remark:

Factor = Antenna Factor + Cable Loss – Pre-amplifier.

All the x/y/z orientation has been investigated, and only worst case is presented in this report.

EUT	Mobile Phone	Model Name	T349
Temperature	20 °C	Relative Humidity	48%
Pressure	1010 hPa	Test Date	July 15, 2016
Test Mode	TX /2480MHz-3Mbps	Polarization	Horizontal

Frequency	Meter Reading	Factor	Emission Level	Limits	Margin	Detector Type
(MHz)	(dBμV)	(dB)	(dBμV/m)	(dBμV/m)	(dB)	
2483.5	62.23	-8.17	54.06	74	19.94	peak
2483.5	53.46	-8.17	45.29	54	8.71	AVG

Remark:

Factor = Antenna Factor + Cable Loss – Pre-amplifier.

All the x/y/z orientation has been investigated, and only worst case is presented in this report.

Test result for hopping mode:

EUT	Mobile Phone	Model Name	T349
Temperature	20 °C	Relative Humidity	48%
Pressure	1010 hPa	Test Date	July 15, 2016
Test Mode	hopping mode -1Mbps	Polarization	Vertical

Frequency (MHz)	Meter Reading (dB μ V)	Factor (dB)	Emission Level (dB μ V/m)	Limits (dB μ V/m)	Margin (dB)	Detector Type
2381	62.89	-8.76	54.13	74	19.87	peak
2381	56.65	-8.76	47.89	54	6.11	AVG
2390	62.48	-8.73	53.75	74	20.25	peak
2390	56.86	-8.73	48.13	54	5.87	AVG

Remark:

Factor = Antenna Factor + Cable Loss – Pre-amplifier.

All the x/y/z orientation has been investigated, and only worst case is presented in this report.

EUT	Mobile Phone	Model Name	T349
Temperature	20 °C	Relative Humidity	48%
Pressure	1010 hPa	Test Date	July 15, 2016
Test Mode	Hopping mode -1Mbps	Polarization	Horizontal

Frequency (MHz)	Meter Reading (dB μ V)	Factor (dB)	Emission Level (dB μ V/m)	Limits (dB μ V/m)	Margin (dB)	Detector Type
2378	63.02	-8.77	54.25	74	19.75	peak
2378	53.70	-8.77	44.93	54	9.07	AVG
2390	62.24	-8.73	53.51	74	20.49	peak
2390	57.67	-8.73	48.94	54	5.06	AVG

Remark:

Factor = Antenna Factor + Cable Loss – Pre-amplifier.

All the x/y/z orientation has been investigated, and only worst case is presented in this report.

EUT	Mobile Phone	Model Name	T349
Temperature	20 °C	Relative Humidity	48%
Pressure	1010 hPa	Test Date	July 15, 2016
Test Mode	hopping mode -1Mbps	Polarization	Vertical

Frequency	Meter Reading	Factor	Emission Level	Limits	Margin	Detector Type
(MHz)	(dB μ V)	(dB)	(dB μ V/m)	(dB μ V/m)	(dB)	
2483.5	62.89	-8.17	54.72	74	19.28	peak
2483.5	53.27	-8.17	45.10	54	8.90	AVG

Remark:

Factor = Antenna Factor + Cable Loss – Pre-amplifier.

All the x/y/z orientation has been investigated, and only worst case is presented in this report.

EUT	Mobile Phone	Model Name	T349
Temperature	20 °C	Relative Humidity	48%
Pressure	1010 hPa	Test Date	July 15, 2016
Test Mode	hopping mode -1Mbps	Polarization	Horizontal

Frequency	Meter Reading	Factor	Emission Level	Limits	Margin	Detector Type
(MHz)	(dB μ V)	(dB)	(dB μ V/m)	(dB μ V/m)	(dB)	
2483.5	62.84	-8.17	54.67	74	19.33	peak
2483.5	53.95	-8.17	45.78	54	8.22	AVG

Remark:

Factor = Antenna Factor + Cable Loss – Pre-amplifier.

All the x/y/z orientation has been investigated, and only worst case is presented in this report.

5.3 CONDUCTED SPURIOUS EMISSION MEASUREMENT

5.3.1 CONDUCTED SPURIOUS EMISSION LIMITS

FCC §15.247 (d)

Limit = -20 dBc

5.3.2 TEST PROCEDURE

According to the dictates of DA-000705

- a. The transmitter output is connected to a spectrum analyzer. The resolution bandwidth is set to 100 kHz. The video bandwidth is set to 300 kHz.
- b. The spectrum from 30 MHz to 25 GHz is investigated with the transmitter set to the lowest, middle, and highest channels.
- c. The band edges at 2.4 and 2.4835 GHz are investigated with the transmitter set to the normal hopping mode.

Note: The correction factor has been added to the spectrum analyzer.

5.3.3 DEVIATION FROM STANDARD

No deviation.

5.3.4 TEST SETUP

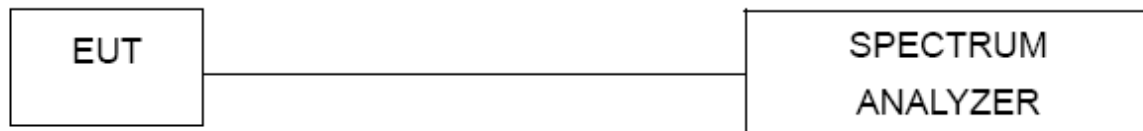

5.3.5 EUT OPERATION CONDITIONS

The EUT tested system was configured as the statements of 2.4 Unless otherwise a special operating condition is specified in the follows during the testing.

5.3.6 TEST RESULTS

Operating Mode: GFSK (1 Mbps)

Low Channel

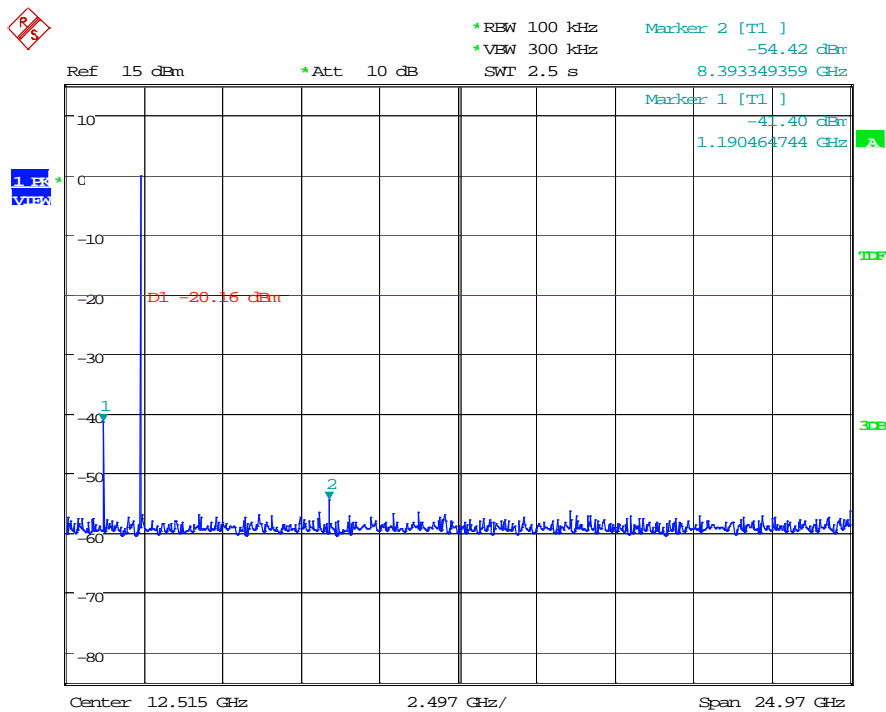
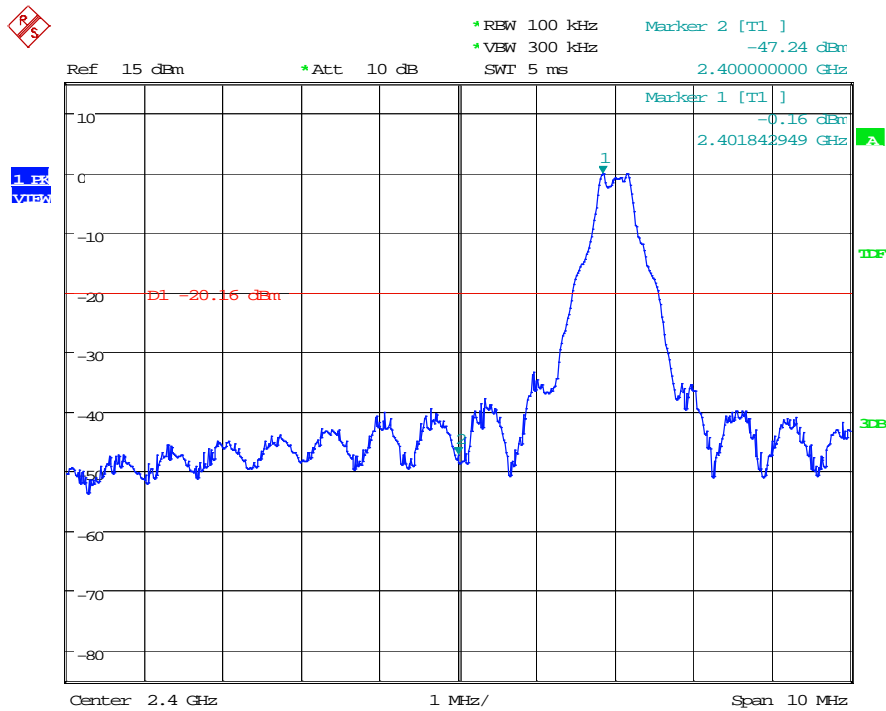

Middle Channel

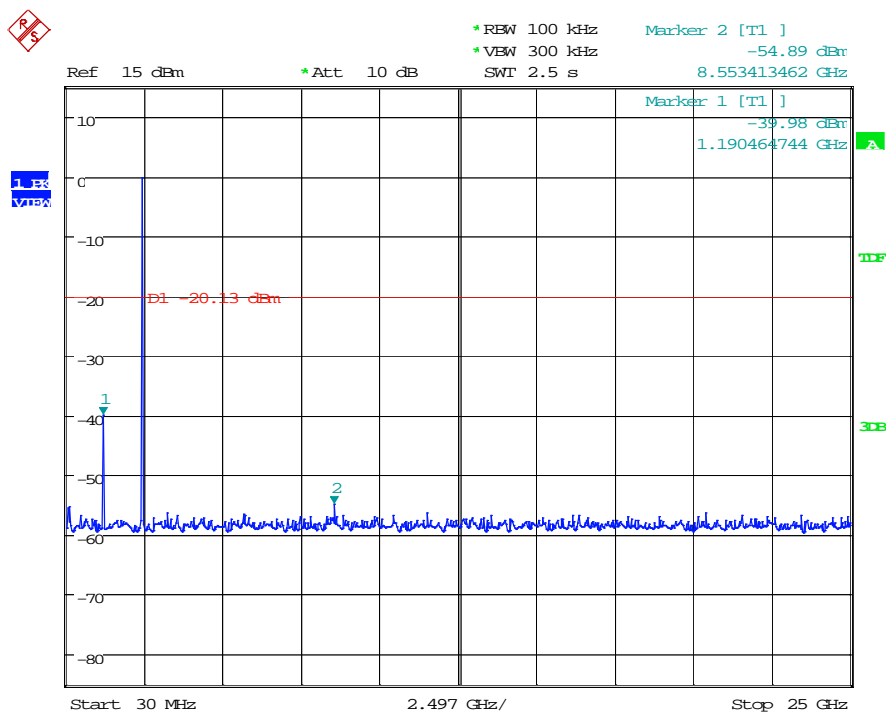
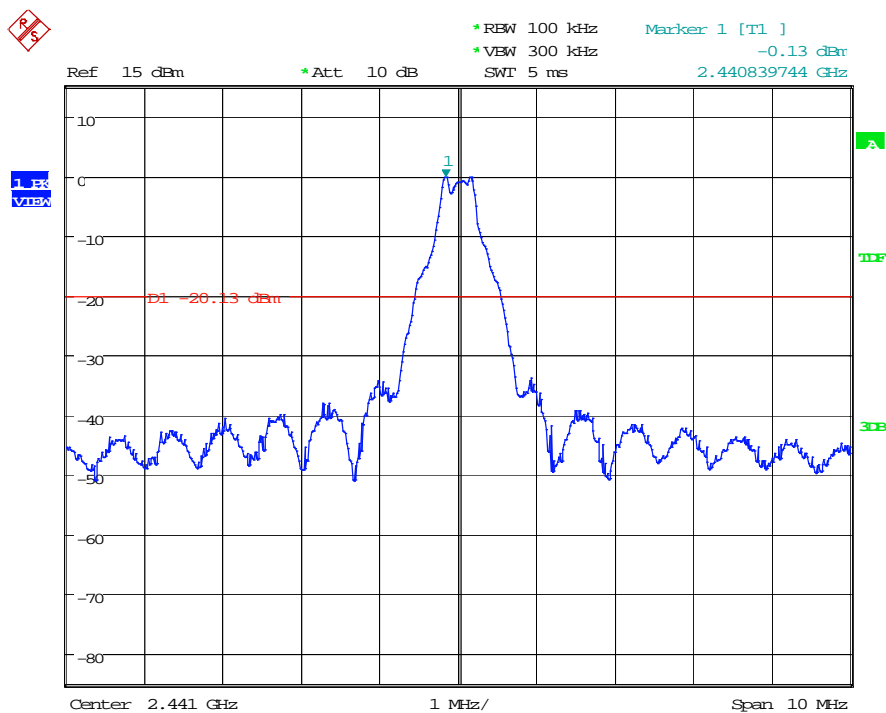

High Channel

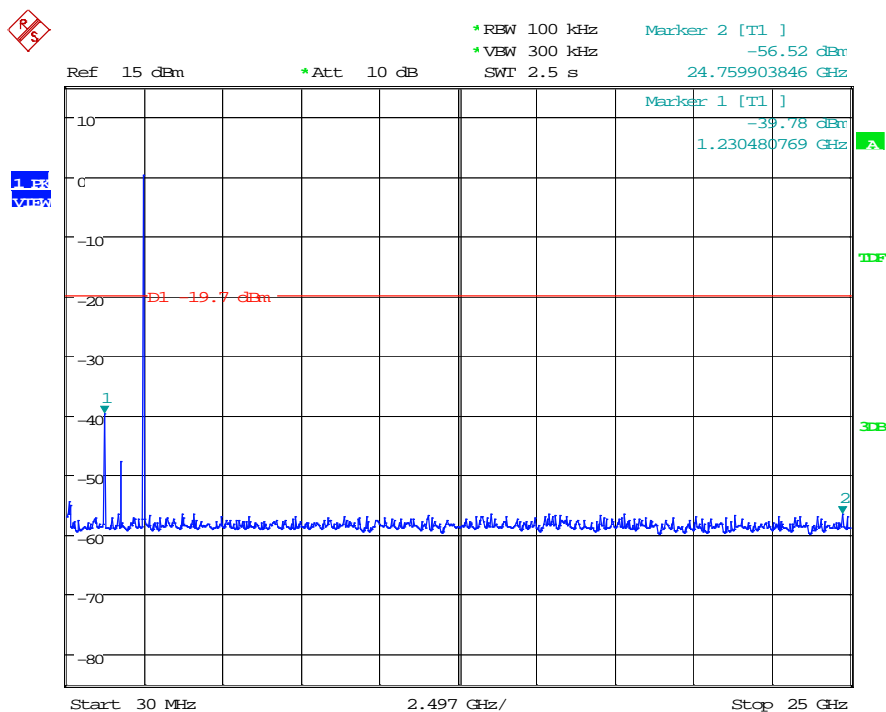
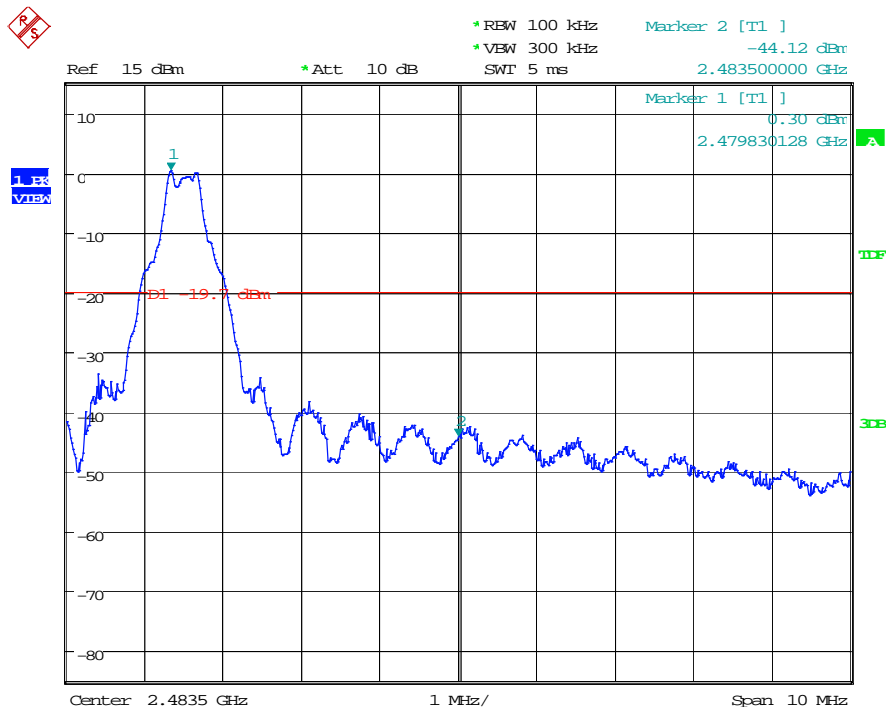

Bandedge at Hopping

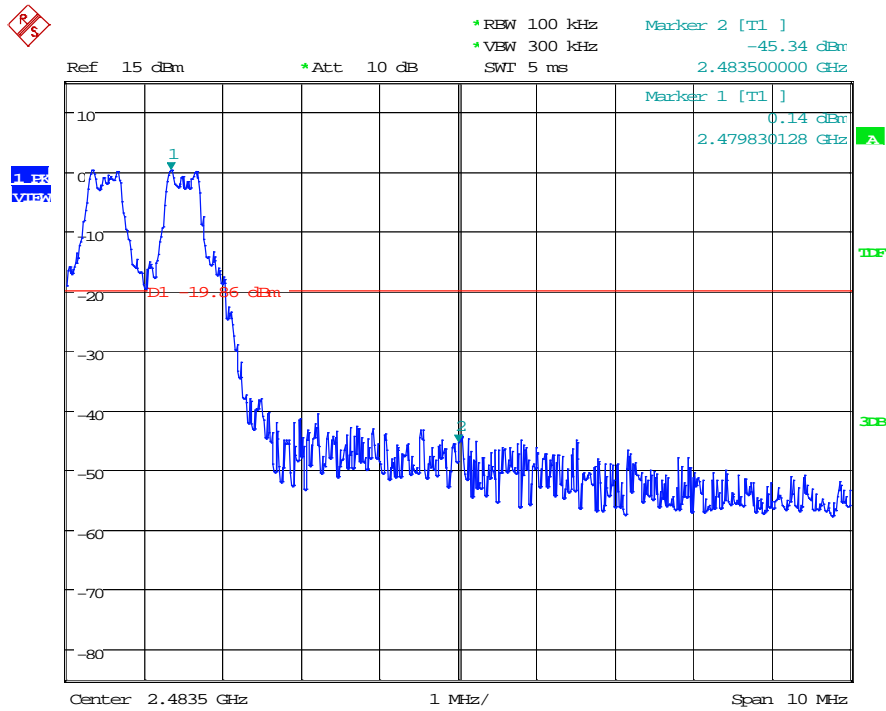
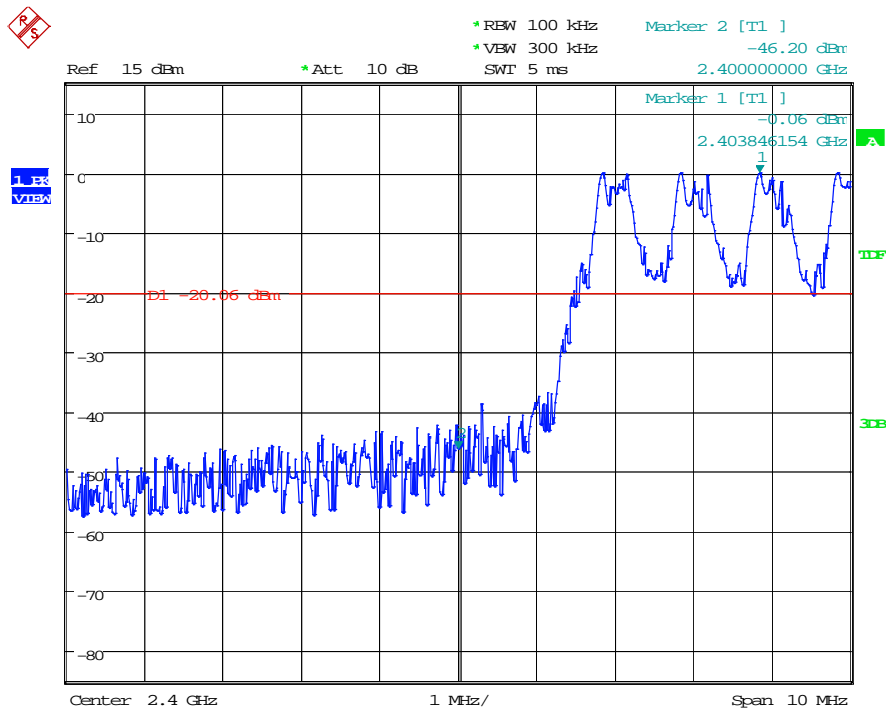

Operating Mode: 8DPSK(3 Mbps)

Low Channel

Report No.: FCC16073806-2

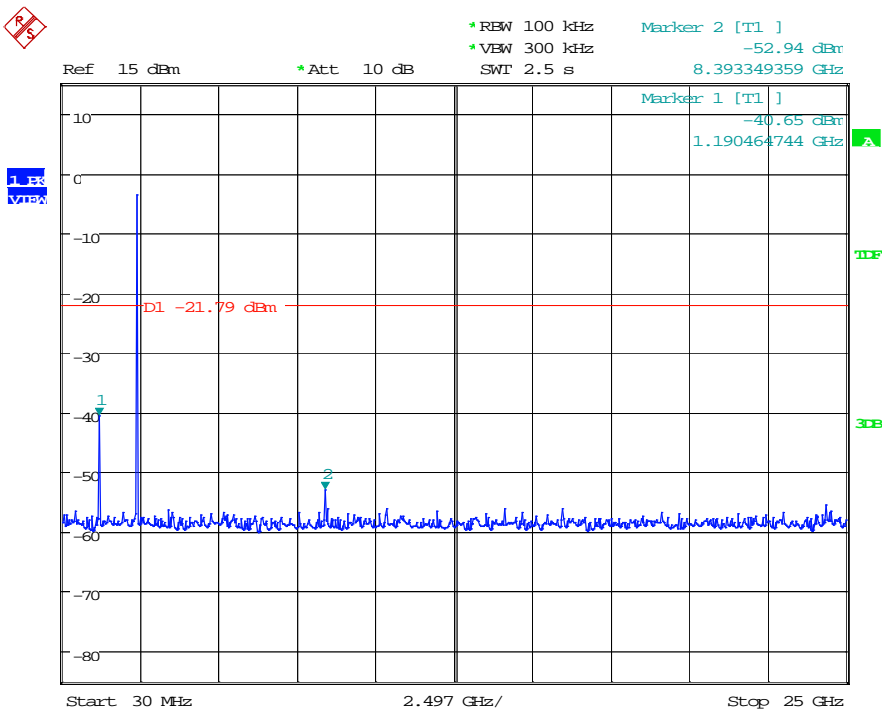
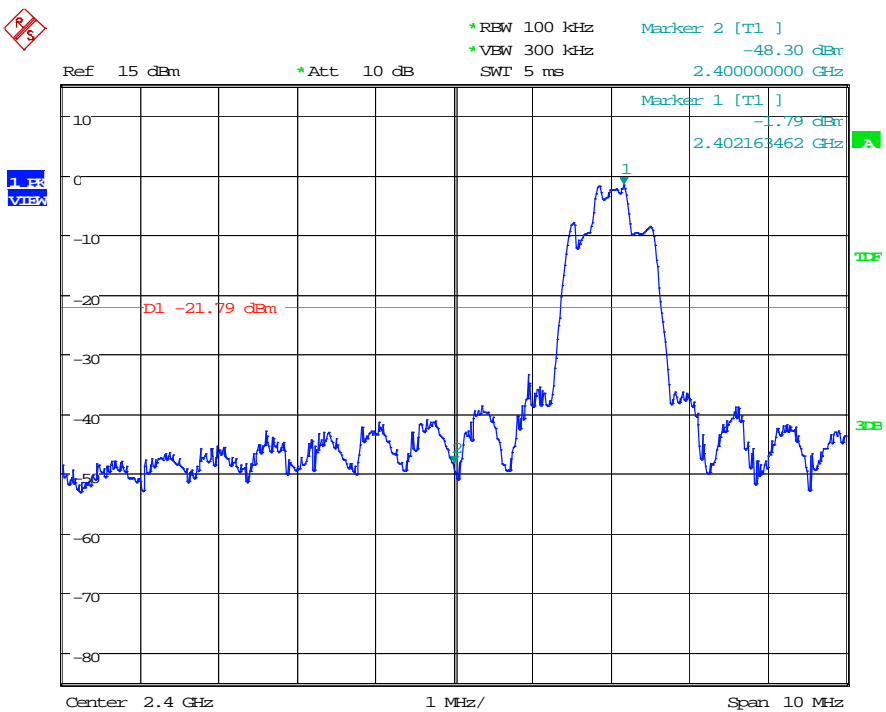

Middle Channel

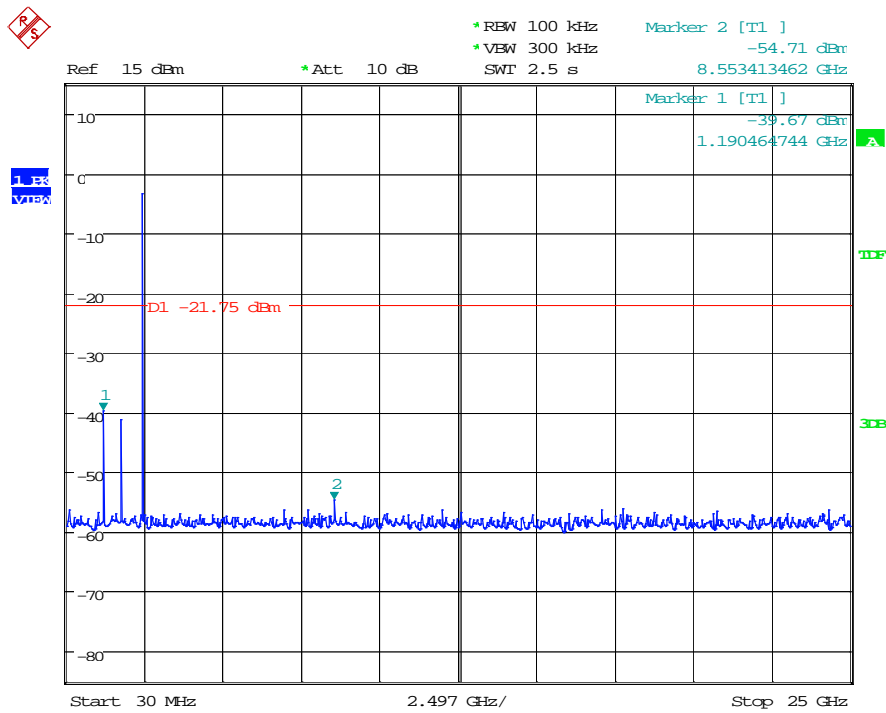
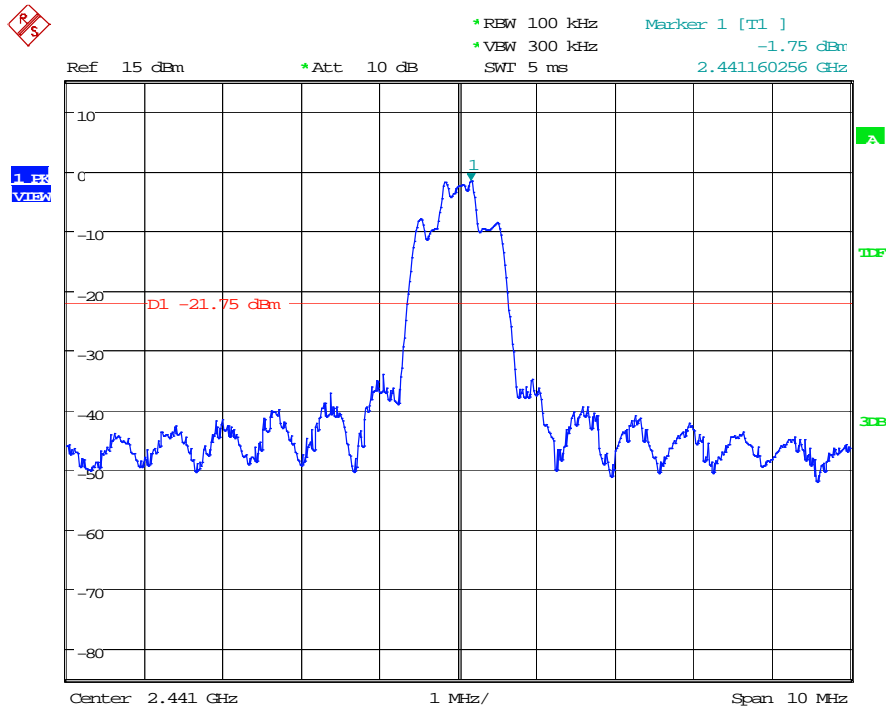

High Channel

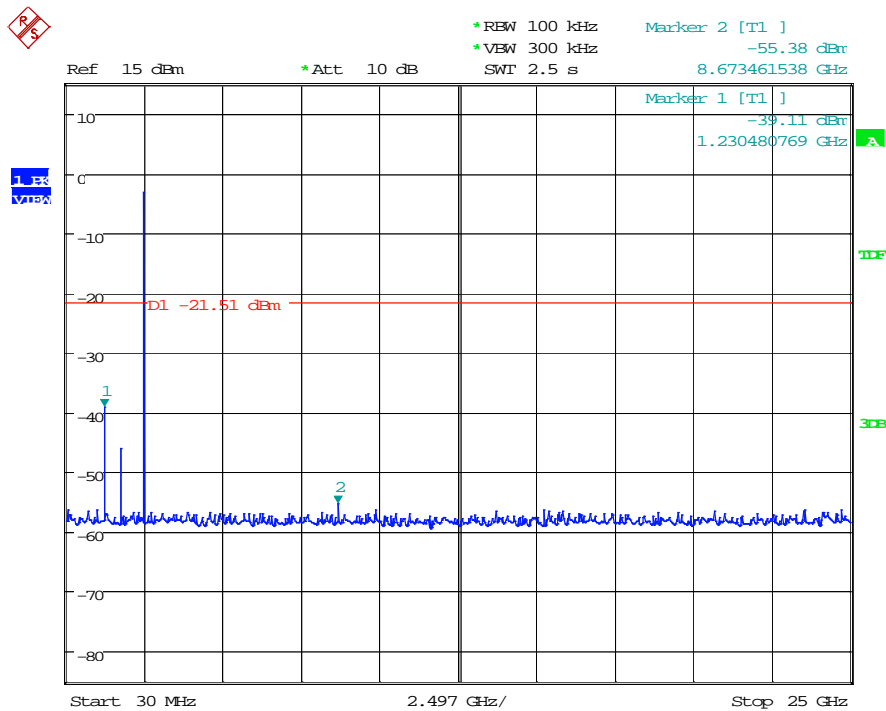
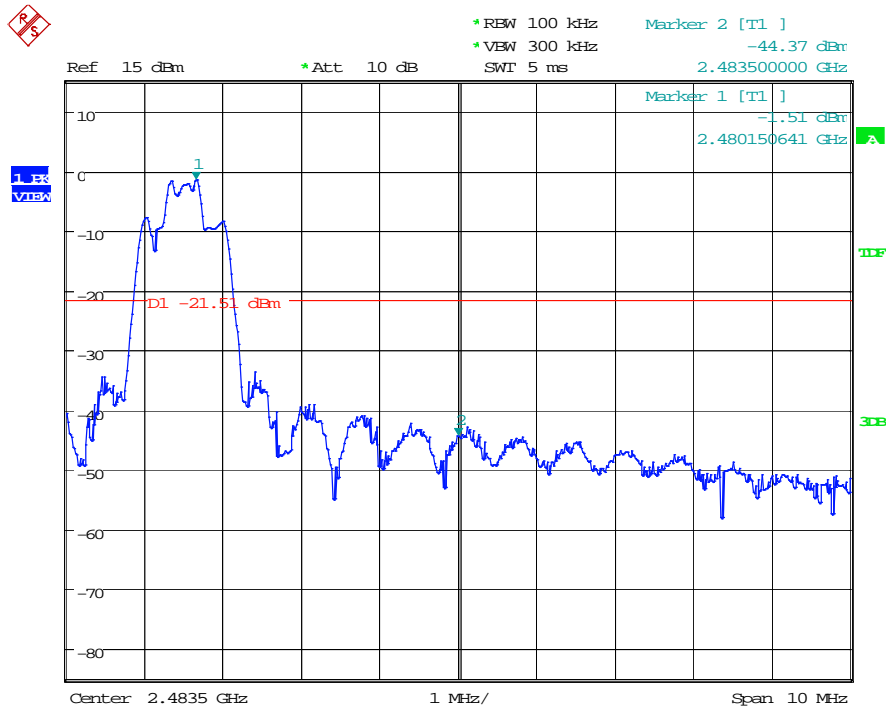

Bandedge at Hopping

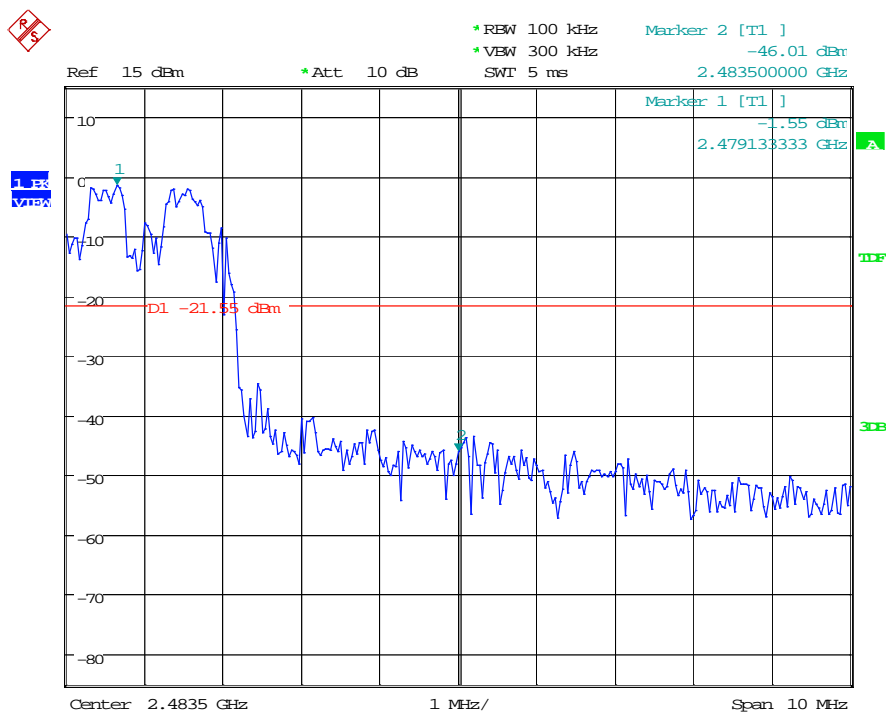
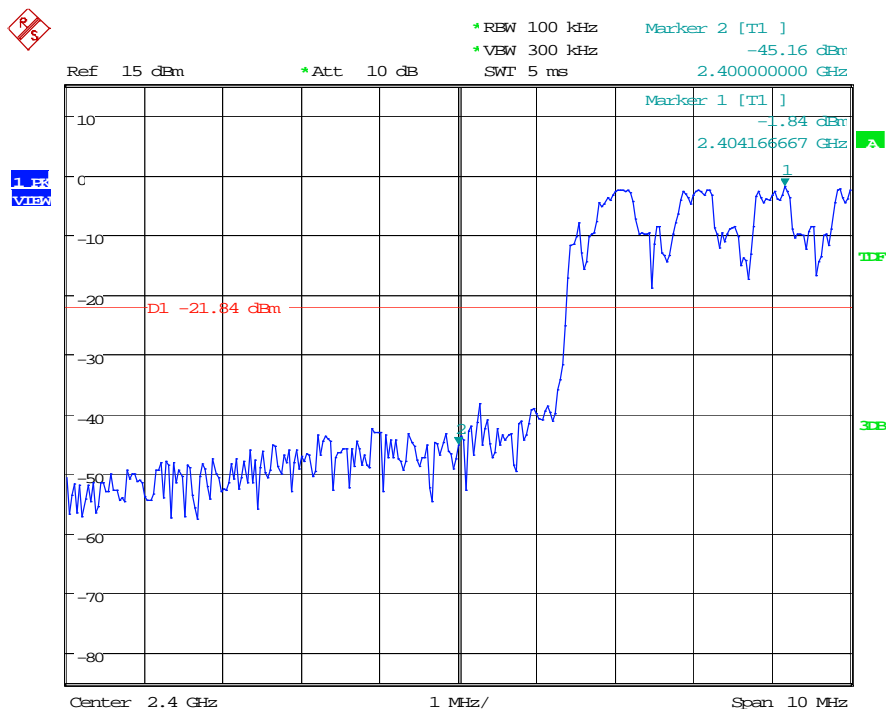

6. NUMBER OF HOPPING CHANNEL**6.1 APPLIED PROCEDURES / LIMIT**

FCC Part15 (15.247) , Subpart C				
Section	Test Item	Limit	Frequency Range (MHz)	Result
15.247 (a)(1)(iii)	Number of Hopping Channel	≥15	2400-2483.5	PASS

Spectrum Parameters	Setting
Attenuation	Auto
Span Frequency	> Operating Frequency Range
RB	1MHz
VB	3MHz
Detector	Peak
Trace	Max Hold
Sweep Time	Auto

6.2 TEST PROCEDURE

- a. The EUT was directly connected to the spectrum analyzer and antenna output port as show in the block diagram below,
- b. Spectrum Setting: RBW= 1MHz, VBW=3MHz, Sweep time = Auto.

6.3 DEVIATION FROM STANDARD

No deviation.

6.4 TEST SETUP**6.5 EUT OPERATION CONDITIONS**

The EUT tested system was configured as the statements of 2.4 Unless otherwise a special operating condition is specified in the follows during the testing.

6.6 TEST RESULTS

EUT	Mobile Phone	Model Name	T349
Temperature	25 °C	Relative Humidity	60%
Pressure	1015 hPa	Test Date	July 15, 2016
Test Mode	Hopping Mode	Number of Hopping Channel	79

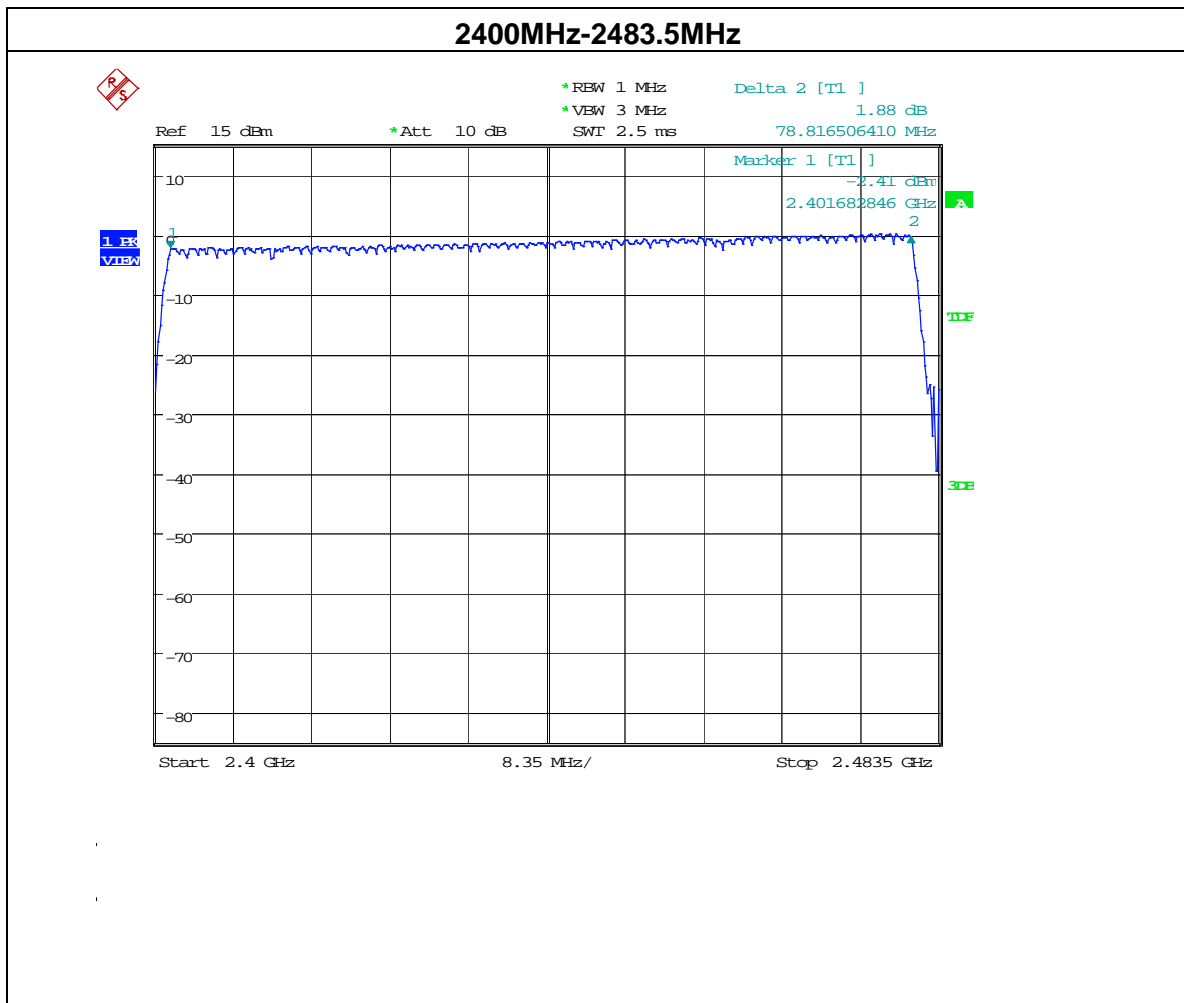

7. AVERAGE TIME OF OCCUPANCY

7.1 APPLIED PROCEDURES / LIMIT

FCC Part15 (15.247) , Subpart C				
Section	Test Item	Limit	Frequency Range (MHz)	Result
15.247 (a)(1)(iii)	Average Time of Occupancy	0.4sec	2400-2483.5	PASS

7.2 TEST PROCEDURE

- The transmitter output (antenna port) was connected to the spectrum analyzer
- Set RBW of spectrum analyzer to 1MHz and VBW to 3MHz.
- Use a video trigger with the trigger level set to enable triggering only on full pulses.
- Sweep Time is more than once pulse time.
- Set the center frequency on any frequency would be measure and set the frequency span to zero span.
- Measure the maximum time duration of one single pulse.
- Set the EUT for DH5, DH3 and DH1 packet transmitting.
- Measure the maximum time duration of one single pulse.
- DH1 Dwell time = Pulse time*(1600/2/79)*31.6S
DH3 Dwell time = Pulse time*(1600/4/79)*31.6S
DH5 Dwell time = Pulse time*(1600/6/79)*31.6S

7.3 DEVIATION FROM STANDARD

No deviation.

7.4 TEST SETUP



7.5 EUT OPERATION CONDITIONS

The EUT tested system was configured as the statements of 2.4 Unless otherwise a special operating condition is specified in the follows during the testing.

7.6 TEST RESULTS

Note: *the worst case is DH-3Mbps as result in this part.*

EUT	Mobile Phone	Model Name	T349
Temperature	25 °C	Relative Humidity	60%
Pressure	1012 hPa	Test Date	July 15, 2016
Test Mode	DH5-3Mbps		

Data Packet	Frequency	Pulse time(ms)	Dwell Time(S)	Limits (S)
DH5	2402MHz	2.8800	0.307	0.4
DH5	2441MHz	2.8800	0.307	0.4
DH5	2480MHz	2.9000	0.309	0.4

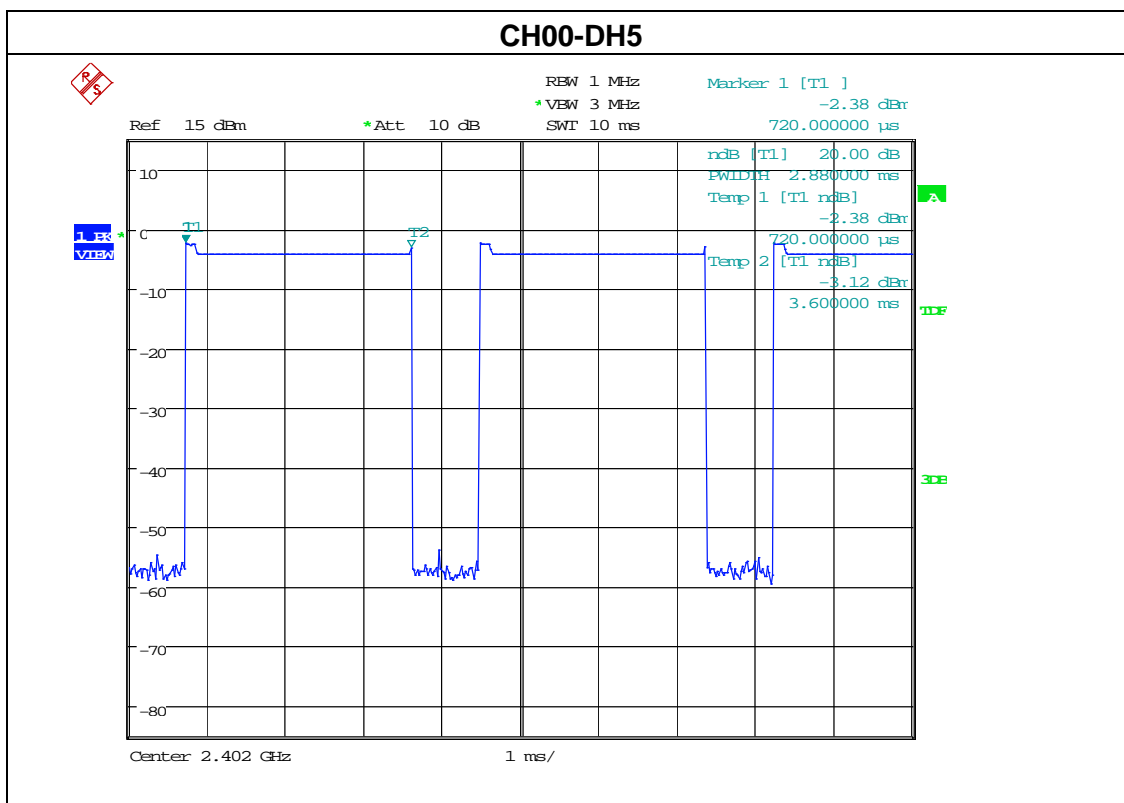

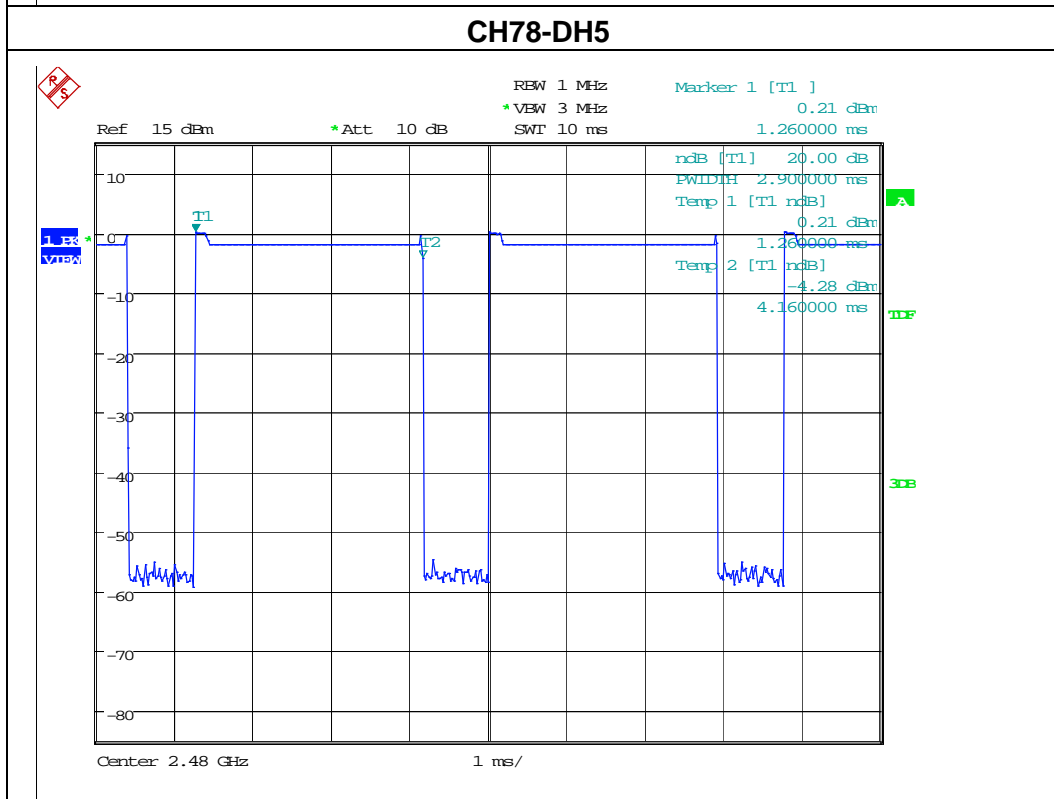
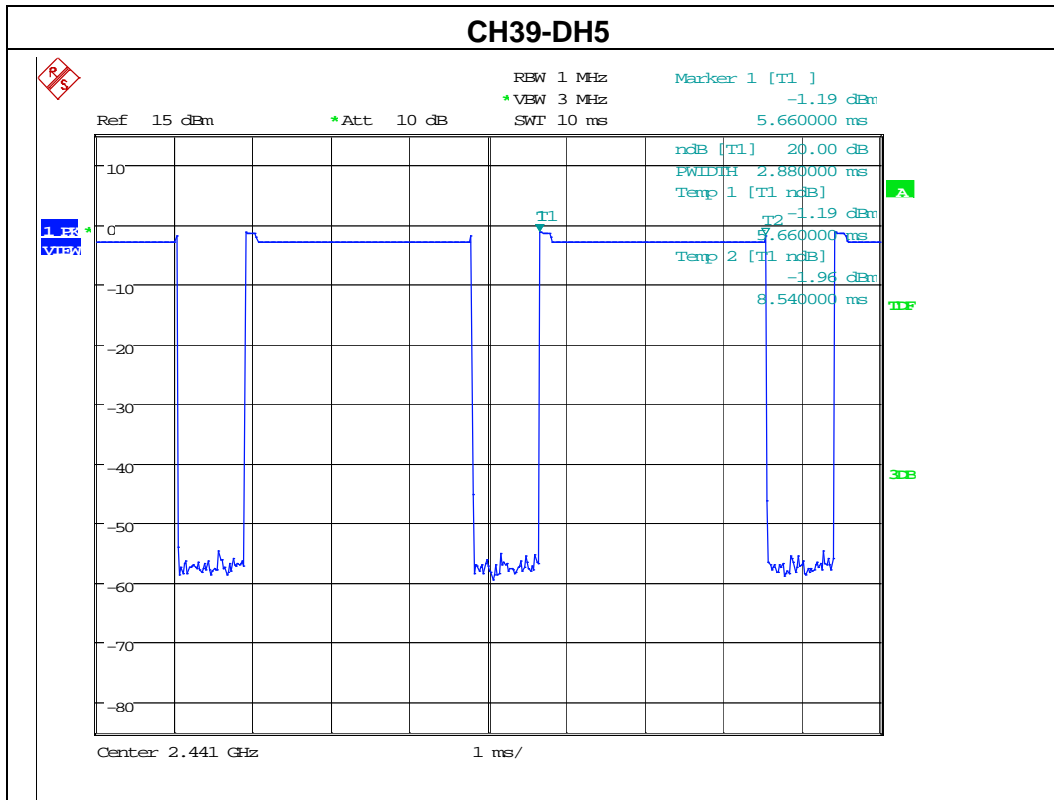

8. HOPPING CHANNEL SEPARATION MEASUREMENT

8.1 APPLIED PROCEDURES / LIMIT

Frequency hopping systems operating in the 2400-2483.5 MHz band may have hopping channel carrier frequencies that are separated by 25 kHz or two-thirds of the 20 dB bandwidth of the hopping channel, whichever is greater.

Spectrum Parameter	Setting
Attenuation	Auto
Span Frequency	> Measurement Bandwidth or Channel Separation
RB	Resolution (or IF) Bandwidth (RBW) \geq 1% of the span
VB	Video (or Average) Bandwidth (VBW) \geq RBW
Detector	Peak
Trace	Max hold
Sweep Time	Auto

8.2 TEST PROCEDURE

1. Check the calibration of the measuring instrument using either an internal calibrator or a known signal from an external generator.
2. Set the spectrum analyzer as follows: Span = wide enough to capture the peaks of two adjacent channels: Resolution (or IF) Bandwidth (RBW) \geq 1% of the span; Video (or Average) Bandwidth (VBW) \geq RBW; Sweep = auto; Detector function = peak; Trace = max hold
3. Measure the separation between the peaks of the adjacent channels using the marker-delta function.
4. Repeat above procedures until all frequencies measured were complete.

8.3 DEVIATION FROM STANDARD

No deviation.

8.4 TEST SETUP

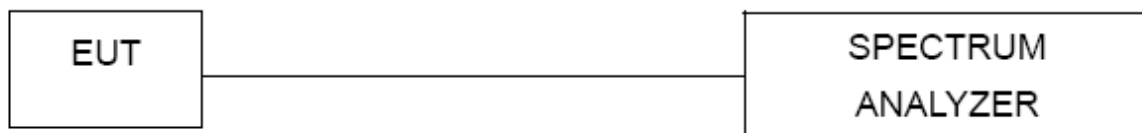

8.5 EUT OPERATION CONDITIONS

The EUT was programmed to be in continuously transmitting mode.

8.6 TEST RESULTS

EUT	Mobile Phone	Model Name	T349
Temperature	25 °C	Relative Humidity	60%
Pressure	1012 hPa	Test Result	Pass
Test Mode	CH00 / CH39 /CH78 (1Mbps Mode)	Test Date	July 15, 2016

Channel number	Channel frequency (MHz)	Separation Read value (KHz)	Separation limit 2/3 20db down BW(KHz)
00	2402	1008.0	>560.15
39	2441	1002.0	>560.15
78	2480	1002.0	>555.74

Note: 20db bandwidth refer to section 6.1.5

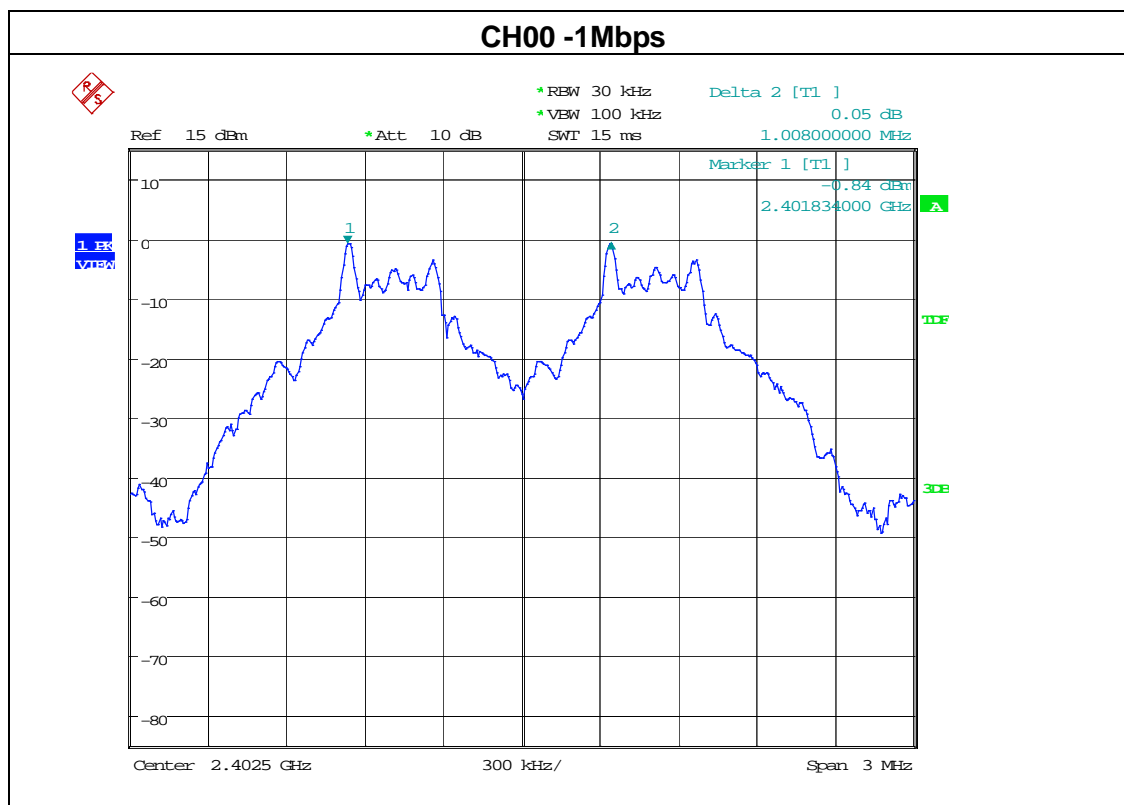

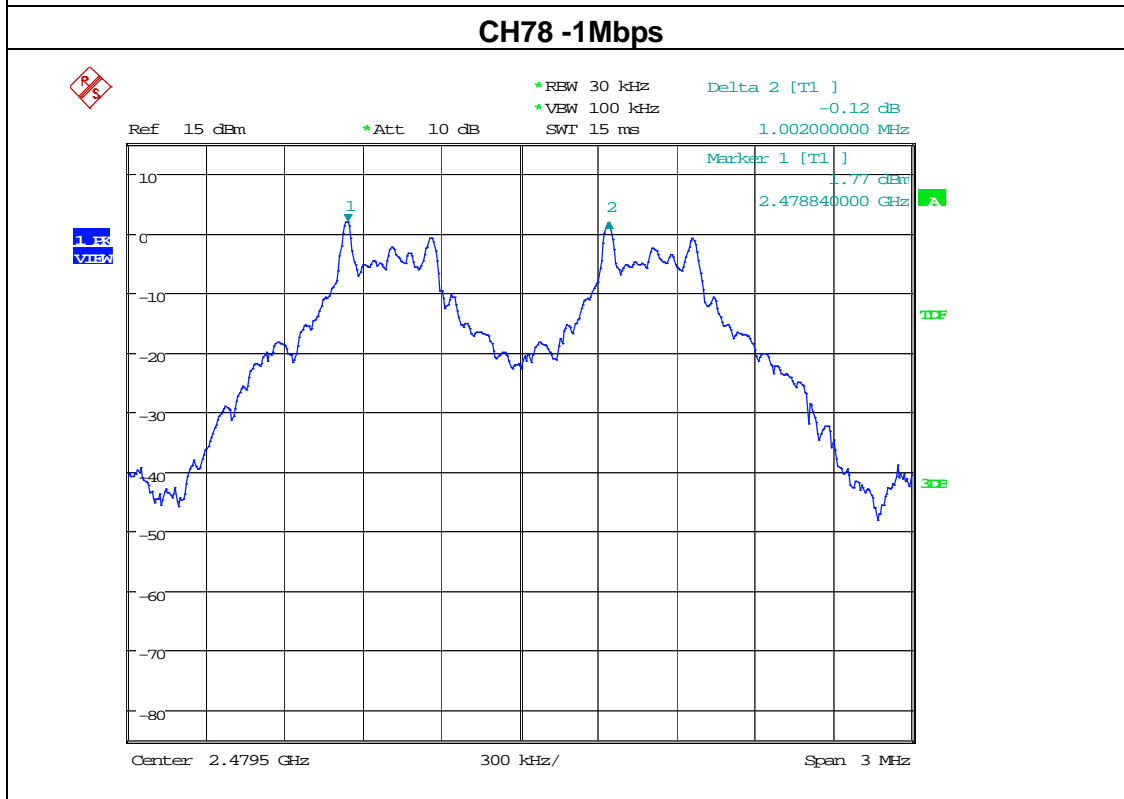
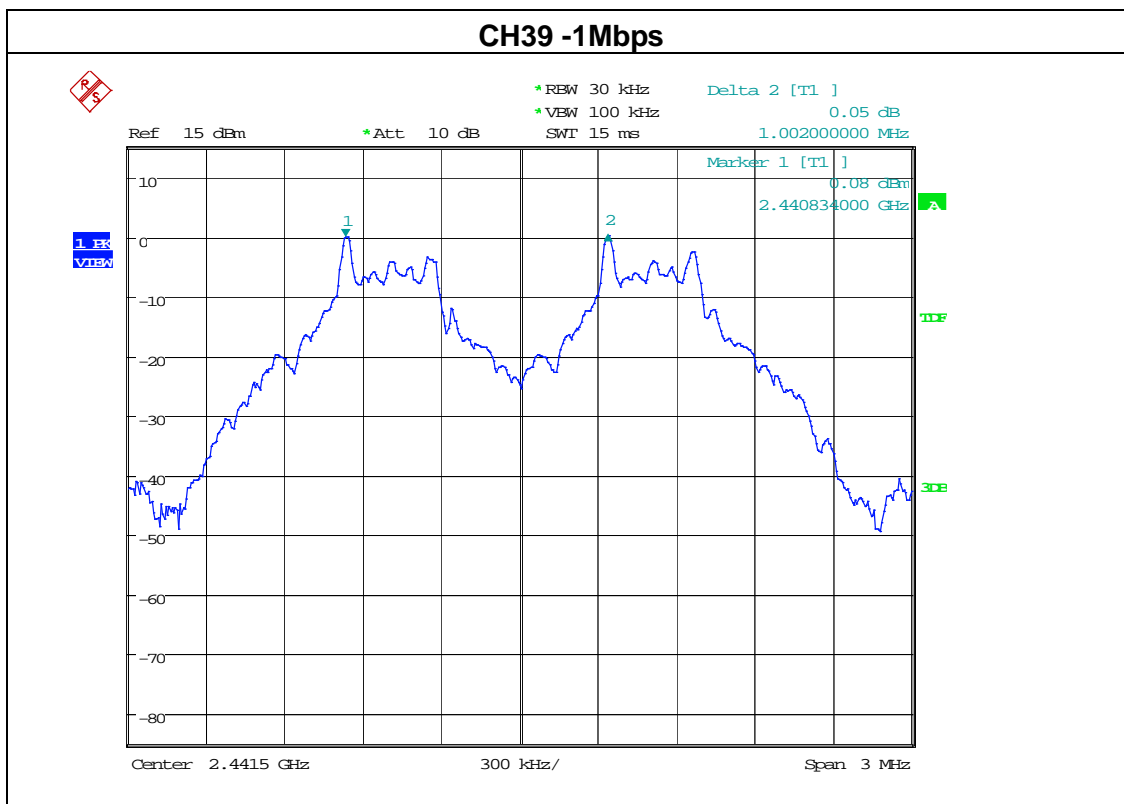

EUT	Mobile Phone	Model Name	T349
Temperature	25 °C	Relative Humidity	60%
Pressure	1012 hPa	Test Result	Pass
Test Mode	CH00 / CH39 /CH78 (2Mbps Mode)	Test Date	July 15, 2016

Channel number	Channel frequency (MHz)	Separation Read value (KHz)	Separation limit 2/3 20db down BW(KHz)
00	2402	1002.0	>766.67
39	2441	1002.0	>774.00
78	2480	1002.0	>776.67

Note: 20db bandwidth refer to section 6.1.5

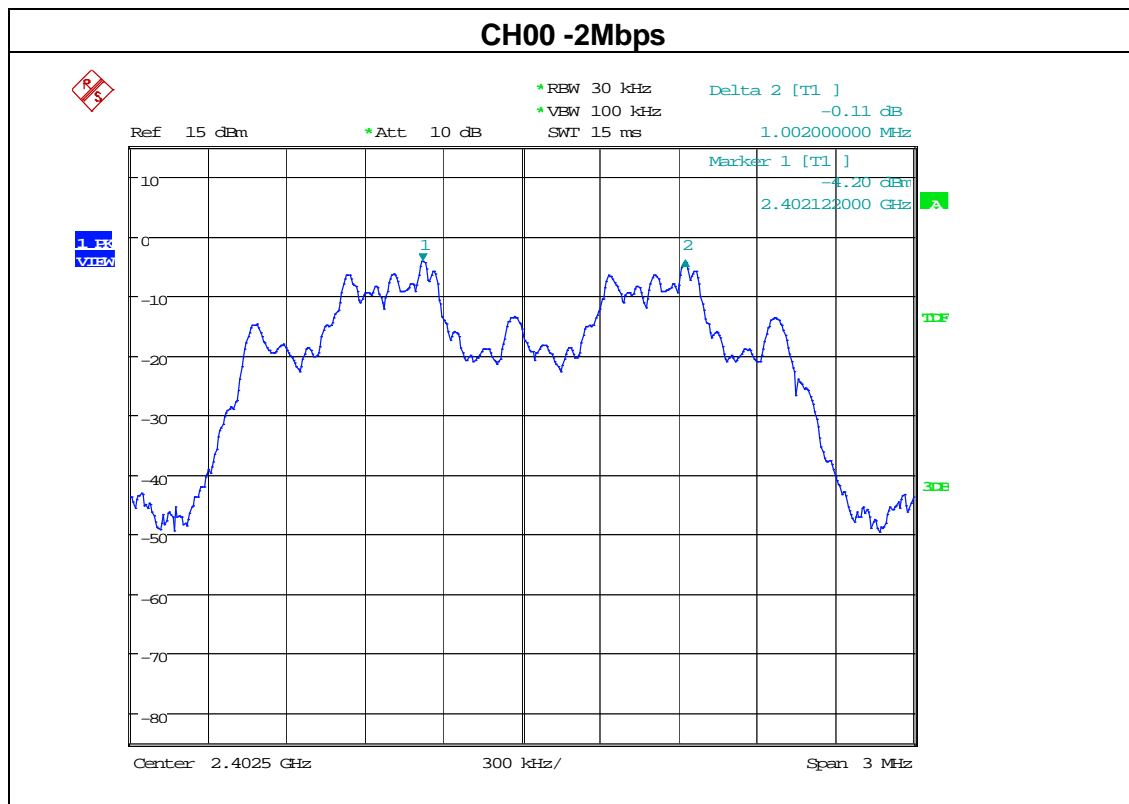

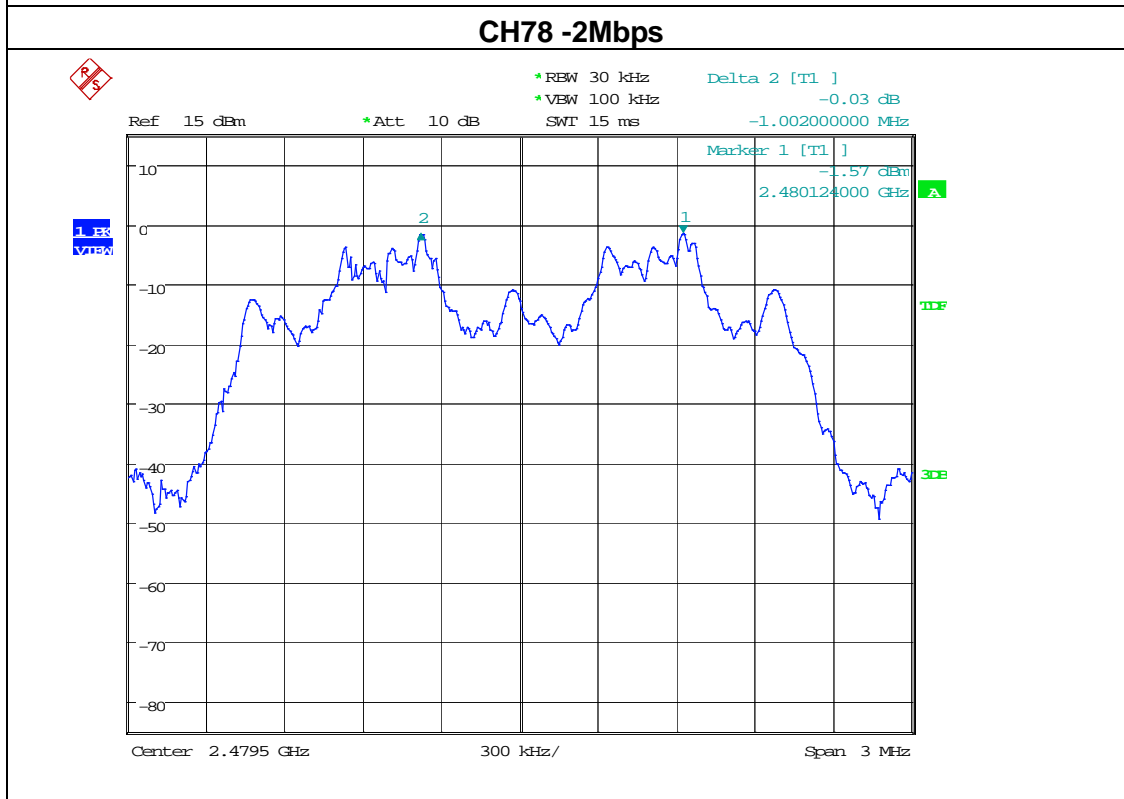
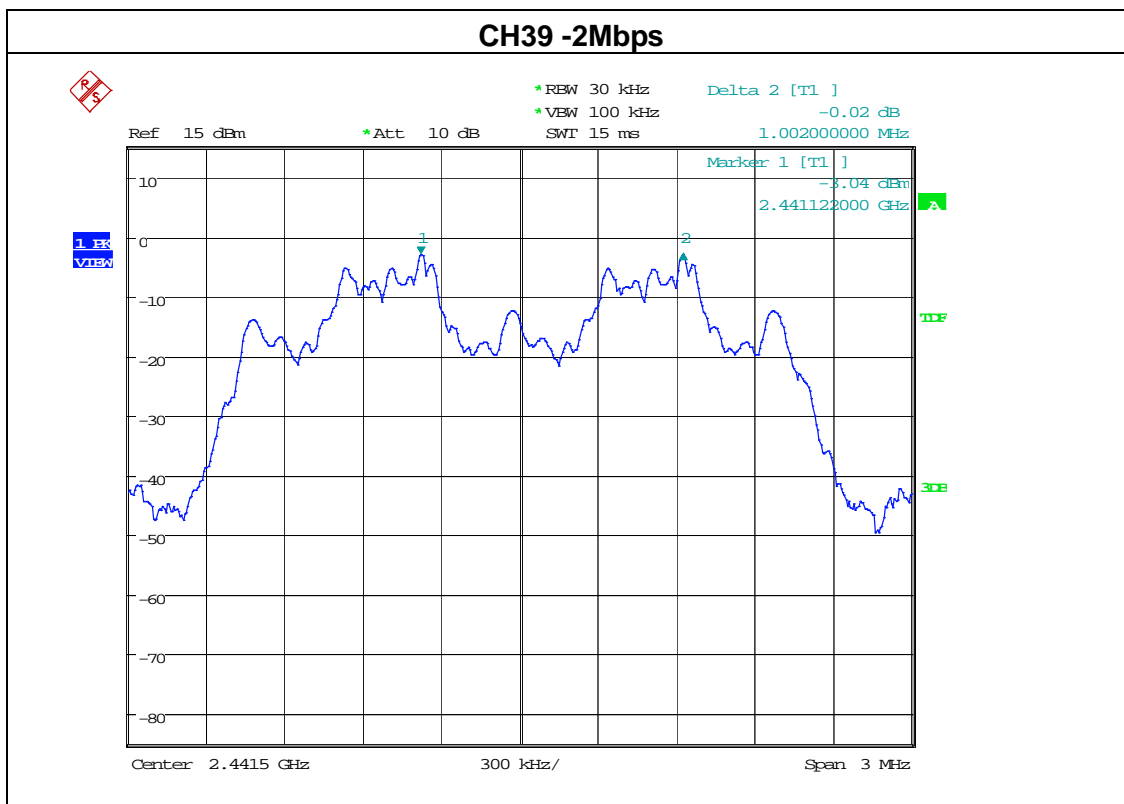

EUT	Mobile Phone	Model Name	T349
Temperature	25 °C	Relative Humidity	60%
Pressure	1012 hPa	Test Result	Pass
Test Mode	CH00 / CH39 /CH78 (3Mbps Mode)	Test Date	July 15, 2016

Channel number	Channel frequency (MHz)	Separation Read value (KHz)	Separation limit 2/3 20db down BW(KHz)
00	2402	1002.0	>769.33
39	2441	1002.0	>769.33
78	2480	1002..0	>776.00

Note: 20db bandwidth refer to section 6.1.5

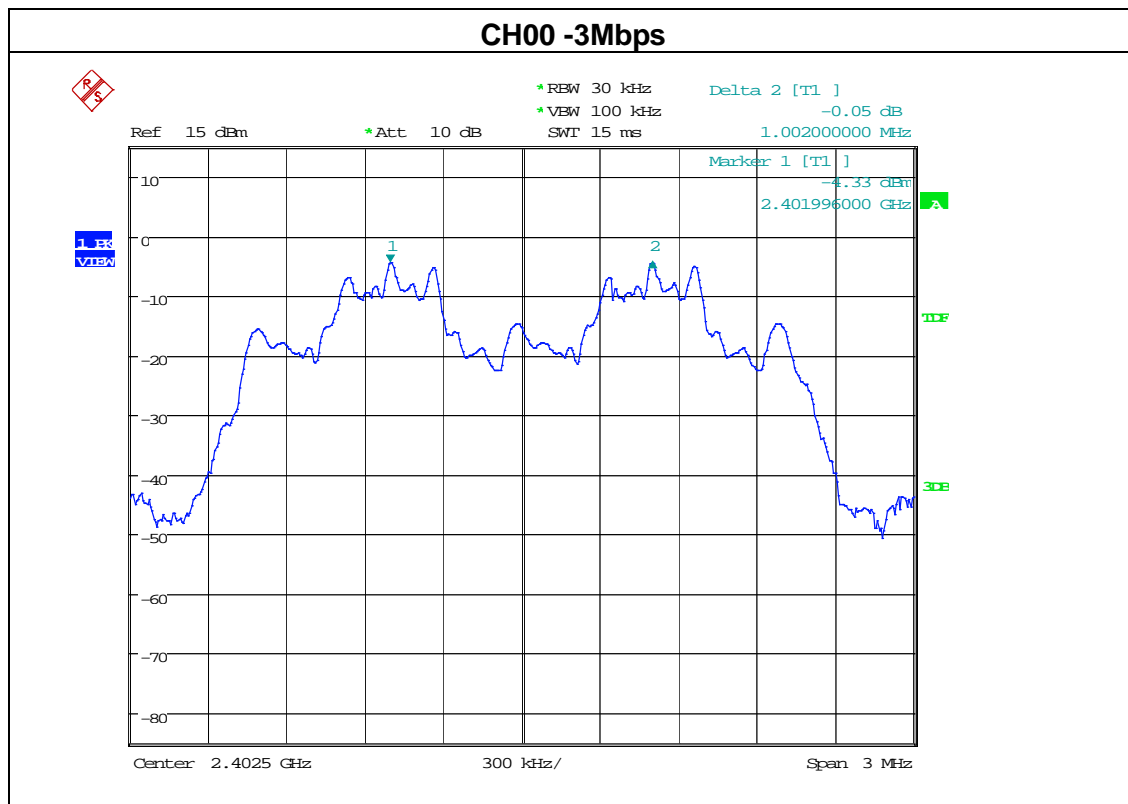

CH39 -3Mbps

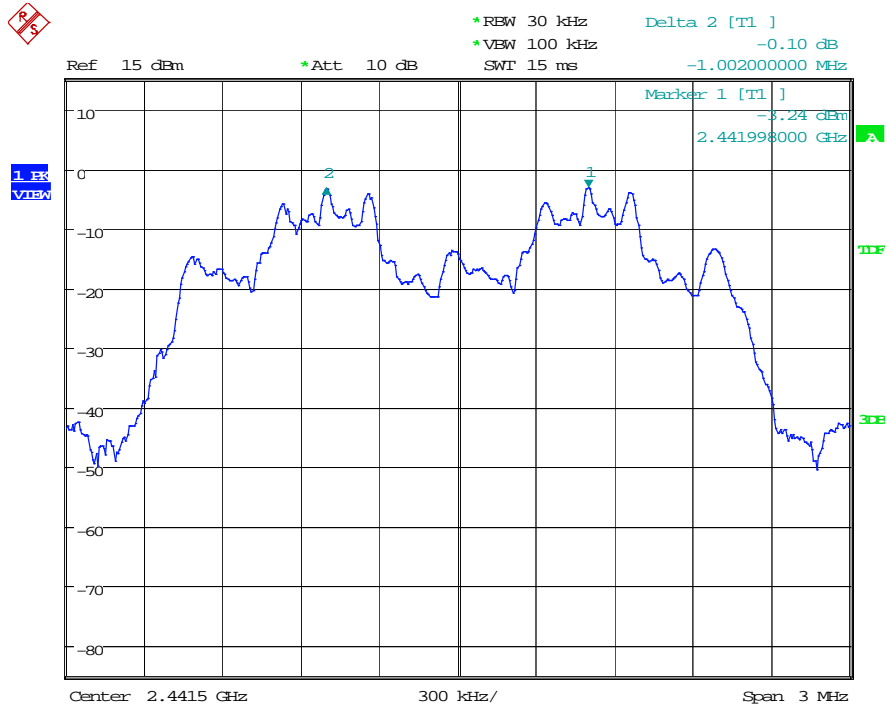

CH78 -3Mbps

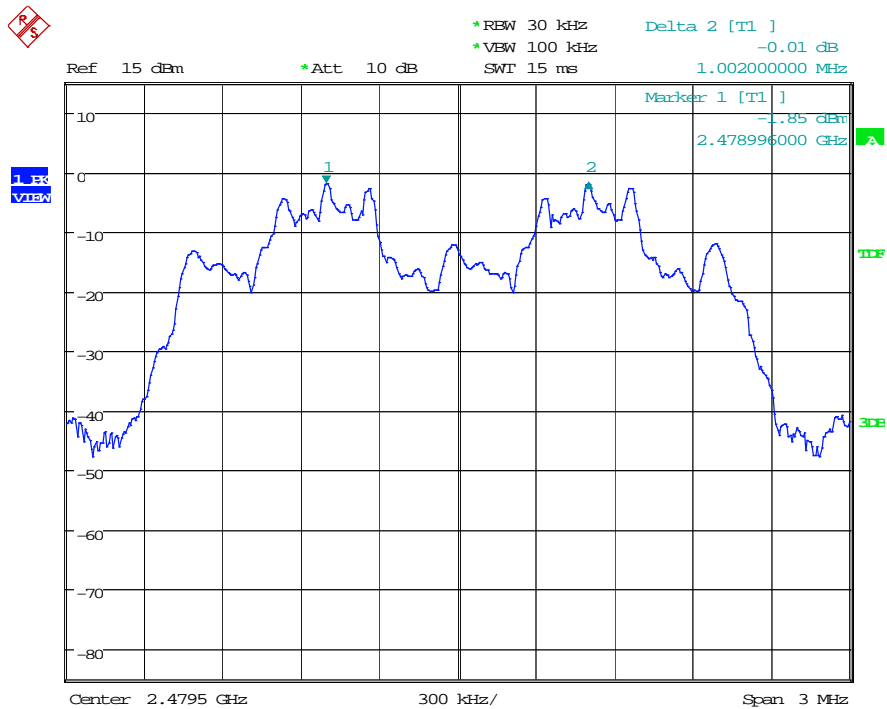

9. BANDWIDTH TEST

9.1 APPLIED PROCEDURES / LIMIT

FCC Part15 (15.247) , Subpart C				
Section	Test Item	Limit	Frequency Range (MHz)	Result
15.247 (a)(1)	Bandwidth	(20dB bandwidth)	2400-2483.5	PASS

Spectrum Parameter	Setting
Attenuation	Auto
Span Frequency	> Measurement Bandwidth or Channel Separation
RB	100kHz
VB	300kHz
Detector	Peak
Trace	Max hold
Sweep Time	Auto

9.2 TEST PROCEDURE

1. Check the calibration of the measuring instrument (spectrum analyzer) using either an internal calibrator or a known signal from an external generator.
2. Set the spectrum analyzer as follows: VBW =100kHz, RBW=300kHz, Sweep = auto
Detector function = peak ,Trace = max hold
3. Measure the highest amplitude appearing on spectral display and record the level to calculate results.
4. Repeat above procedures until all frequencies measured were complete.

9.3 DEVIATION FROM STANDARD

No deviation.

9.4 TEST SETUP

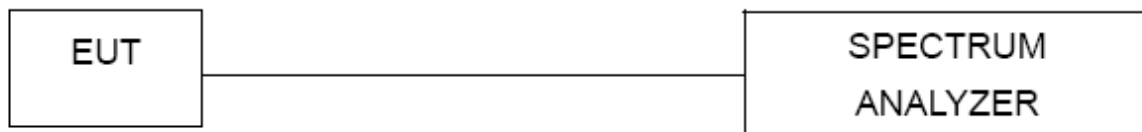

9.5 EUT OPERATION CONDITIONS

The EUT tested system was configured as the statements of 2.4 Unless otherwise a special operating condition is specified in the follows during the testing.

9.6 TEST RESULTS

EUT	Mobile Phone	Model Name	T349
Temperature	25 °C	Relative Humidity	60%
Pressure	1012 hPa	Test Mode	CH00/CH39/C78(1Mbps)
Test Date	July 15, 2016		

Frequency	20dB Bandwidth (kHz)	Result
2402 MHz	840.23	PASS
2441 MHz	840.23	PASS
2480 MHz	833.62	PASS

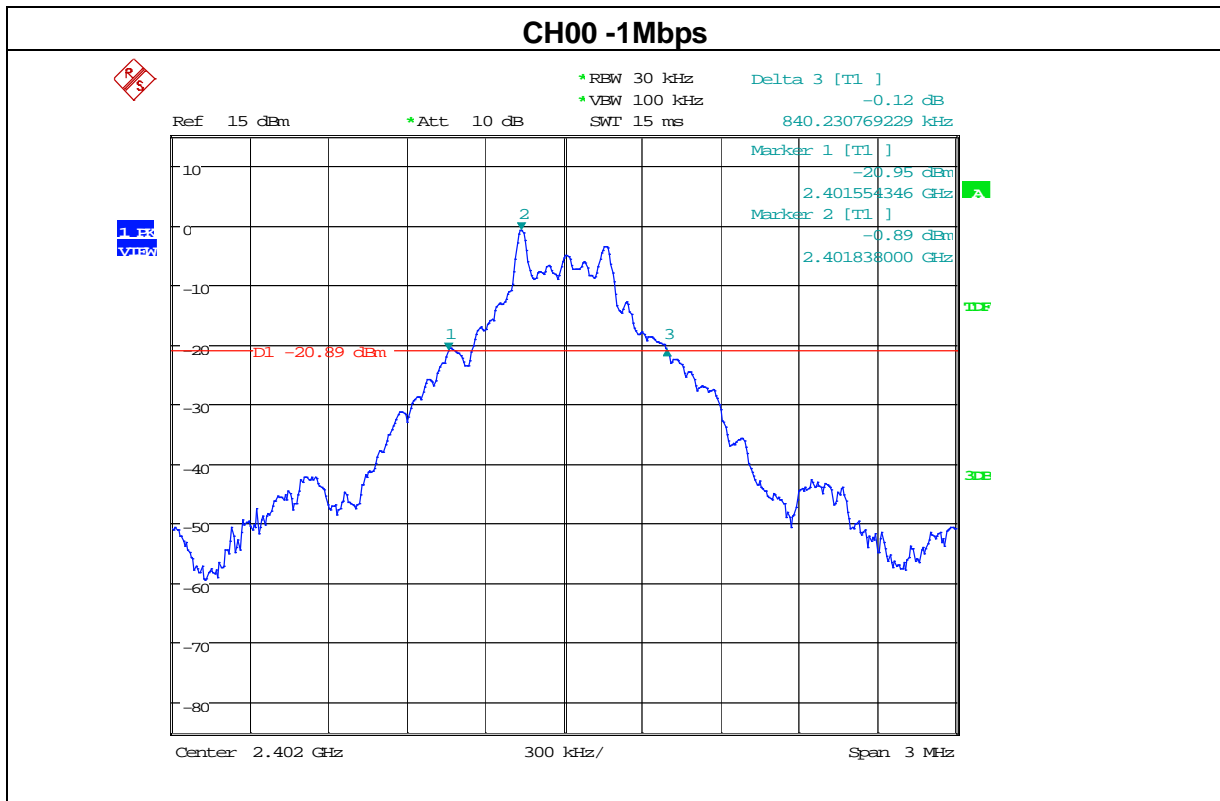

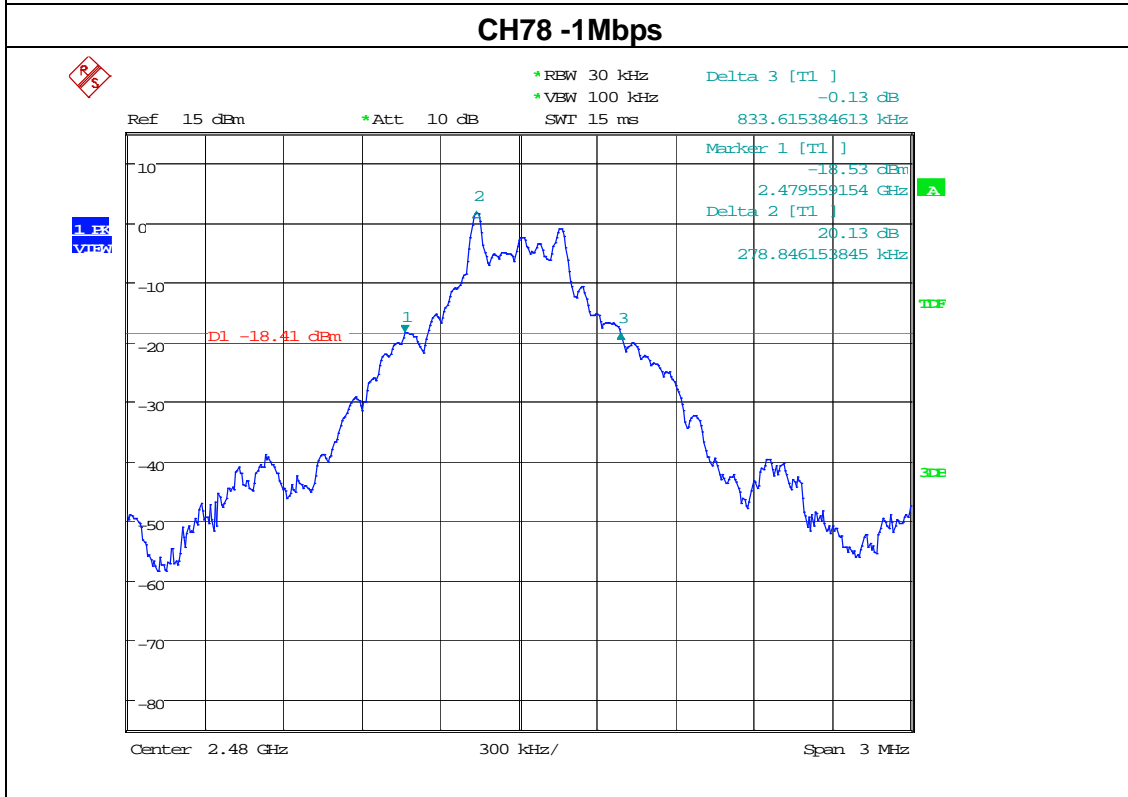
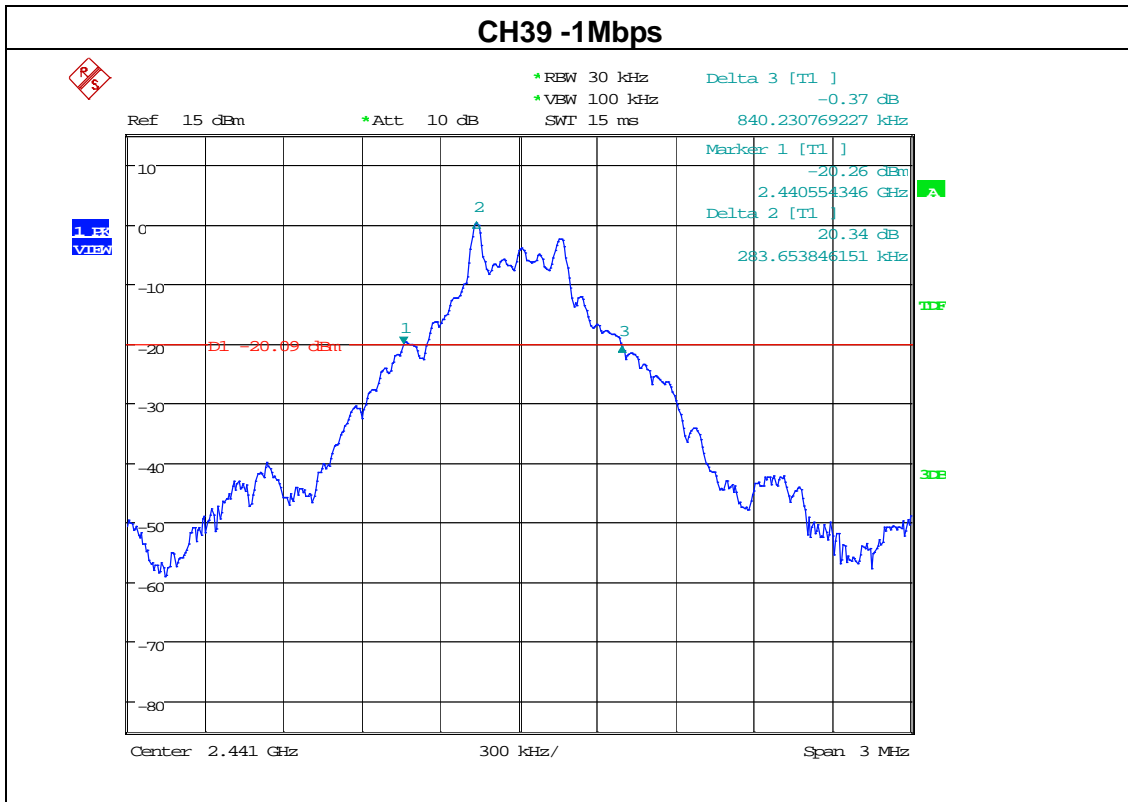

EUT	Mobile Phone	Model Name	T349
Temperature	25 °C	Relative Humidity	60%
Pressure	1012 hPa	Test Mode	CH00/CH39/C78(2Mbps)
Test Date	July 15, 2016		

Frequency	20dB Bandwidth (kHz)	Result
2402 MHz	1150	PASS
2441 MHz	1161	PASS
2480 MHz	1165	PASS

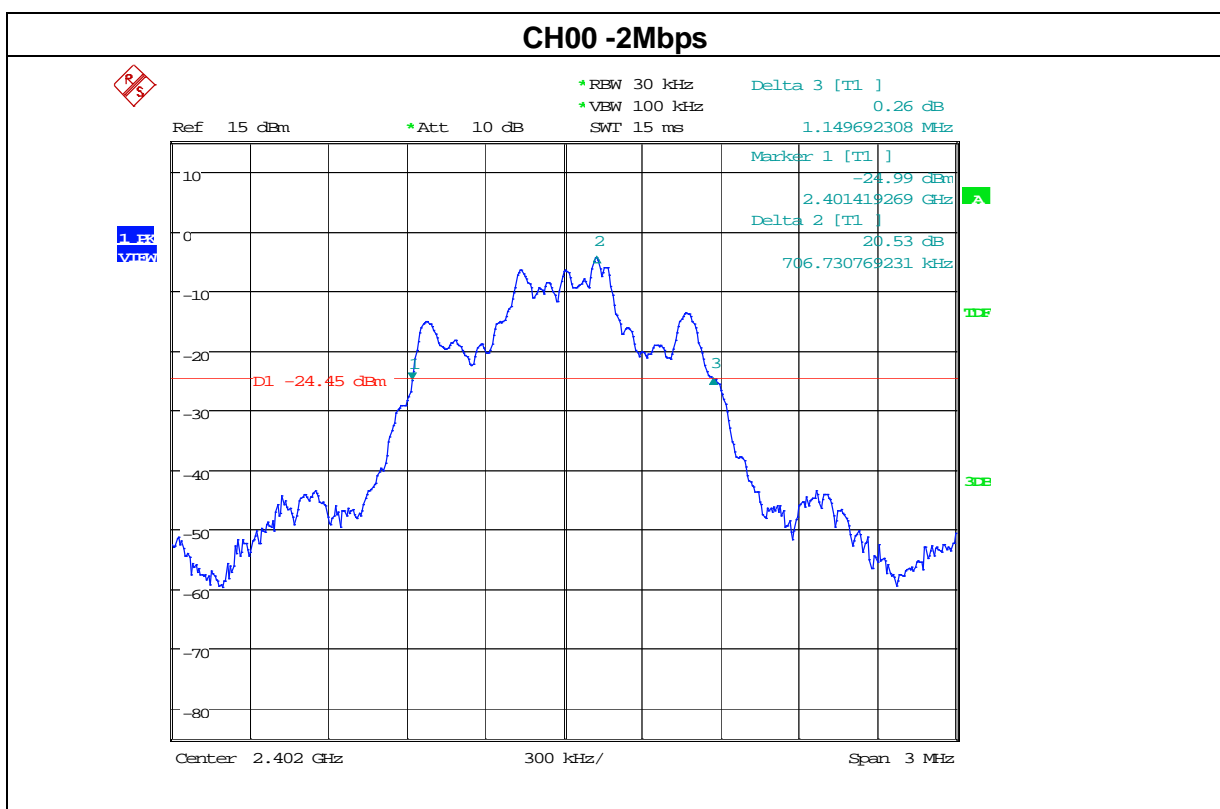

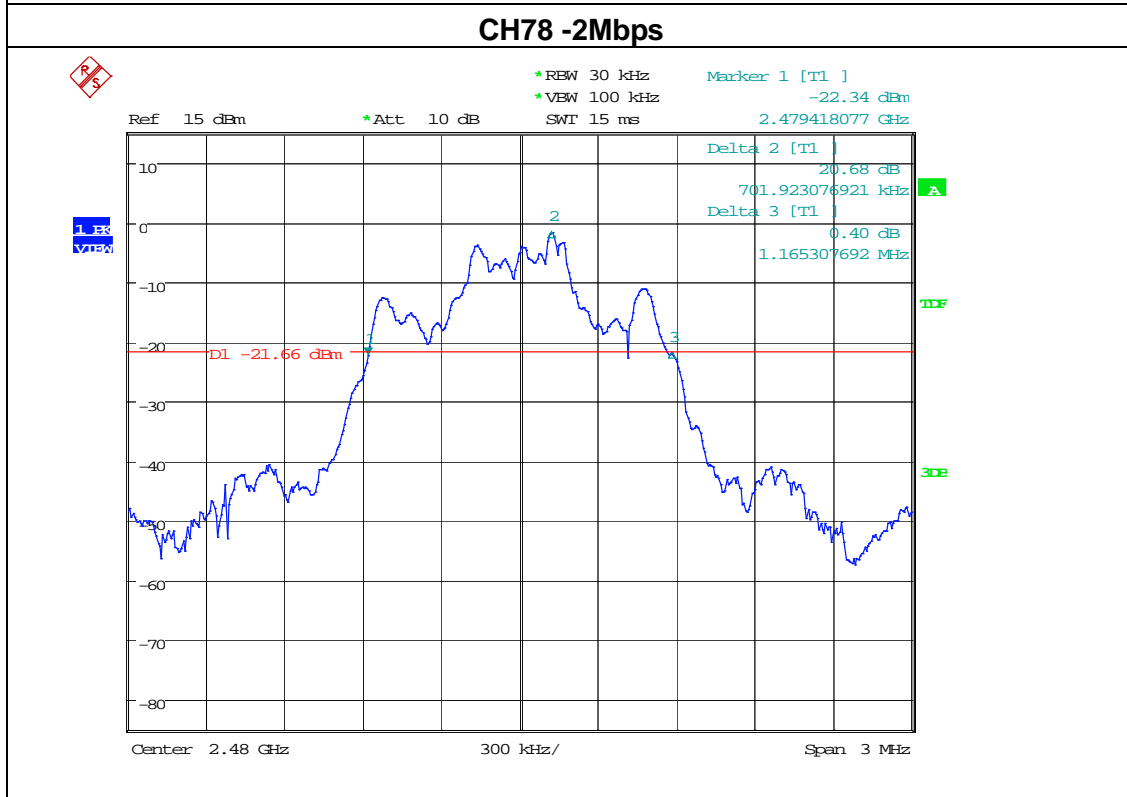
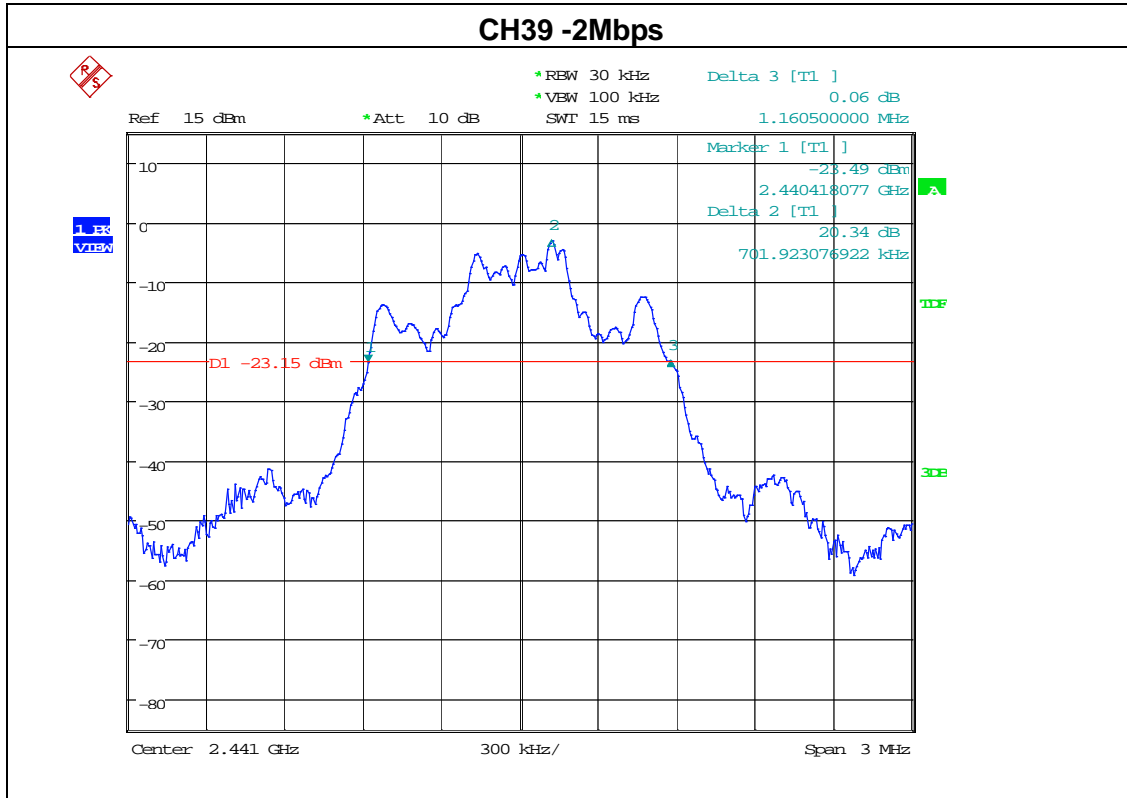

EUT	Mobile Phone	Model Name	T349
Temperature	25 °C	Relative Humidity	60%
Pressure	1012 hPa	Test Mode	CH00/CH39/C78(3Mbps)
Test Date	July 15, 2016		

Frequency	20dB Bandwidth (kHz)	Result
2402 MHz	1154	PASS
2441 MHz	1154	PASS
2480 MHz	1164	PASS

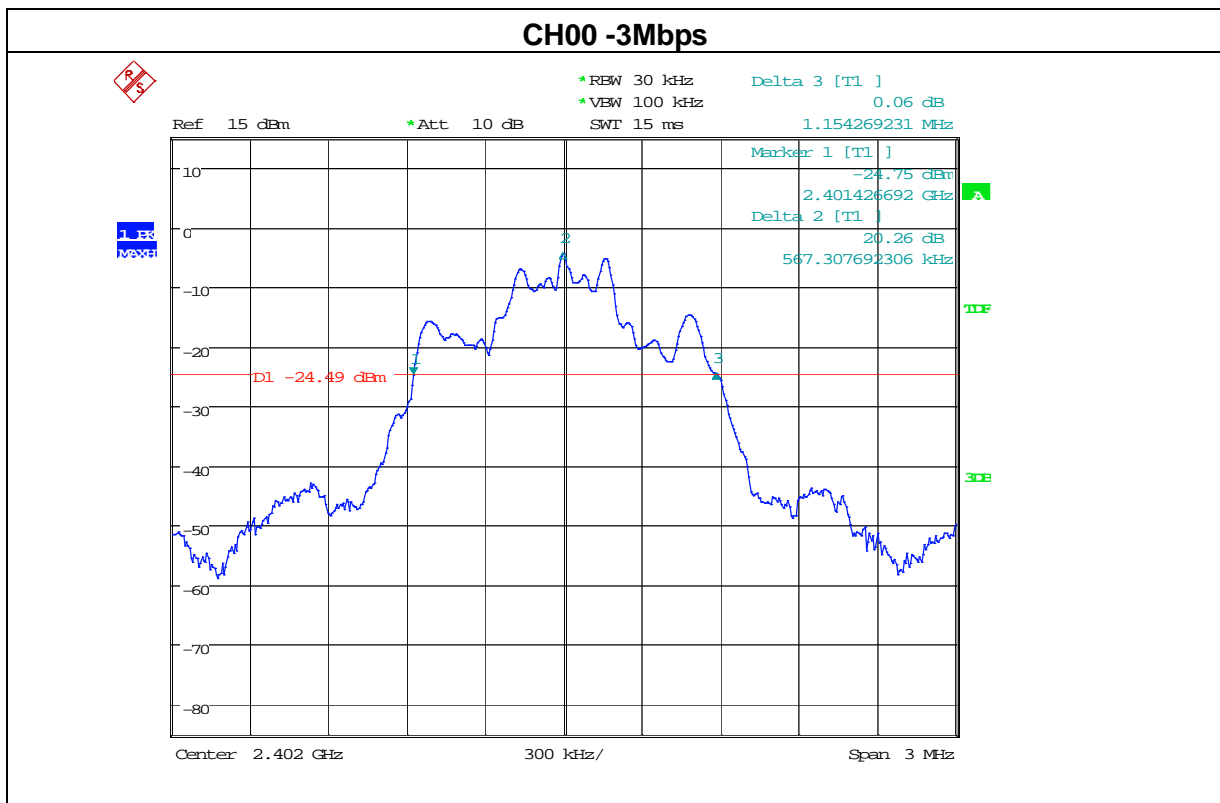

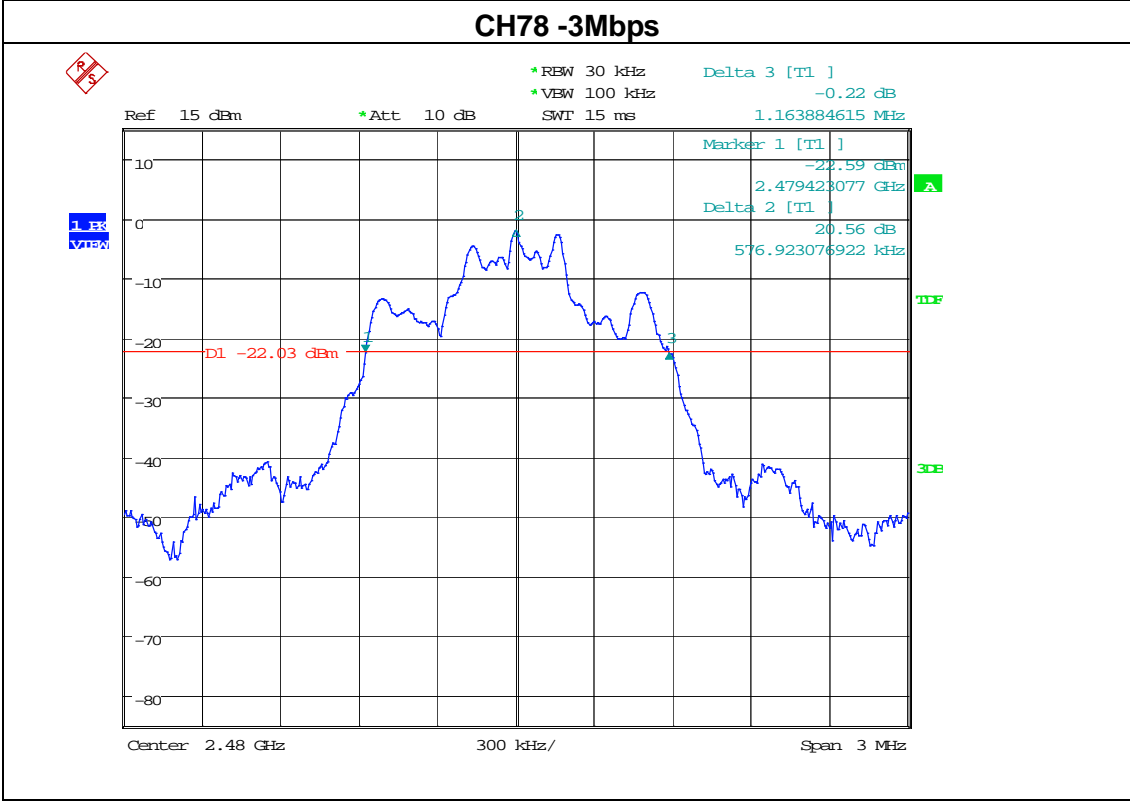
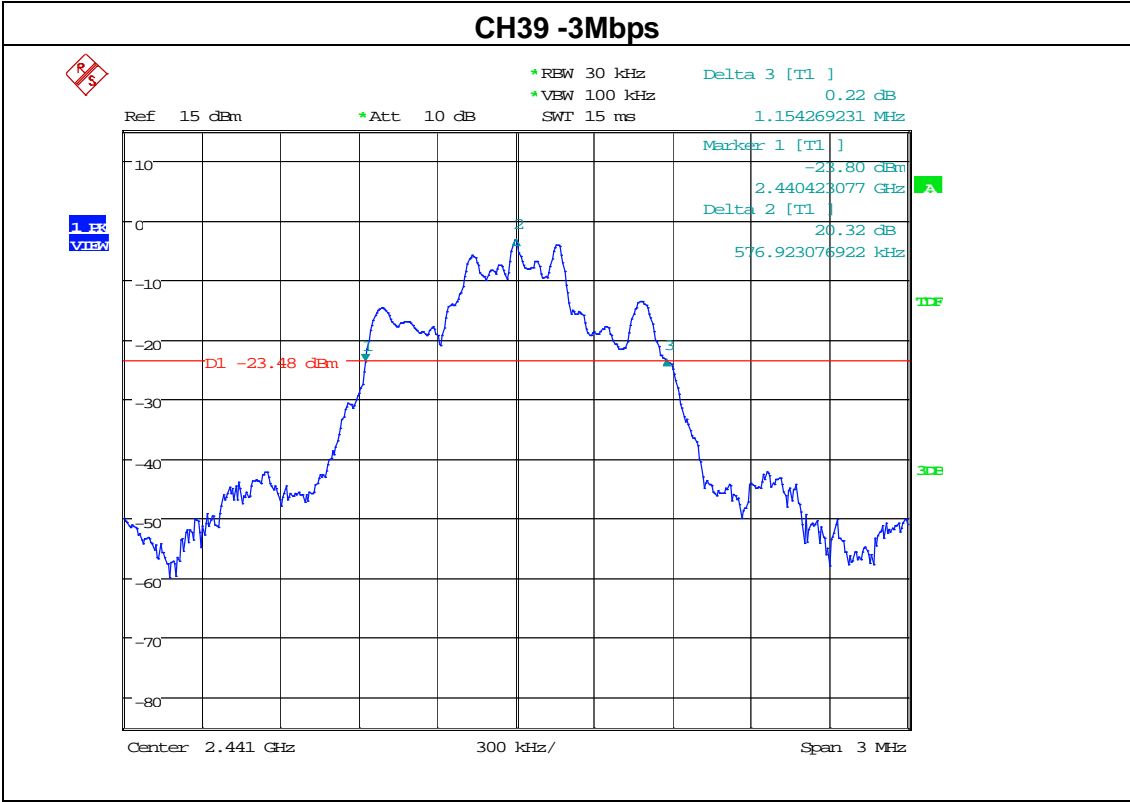

10. PEAK OUTPUT POWER TEST**10.1 APPLIED PROCEDURES / LIMIT**

FCC Part15 (15.247) , Subpart C				
Section	Test Item	Limit	Frequency Range (MHz)	Result
15.247 (b)(i)	Peak Output Power	0.125 w or 20.96dBm	2400-2483.5	PASS

10.2 TEST PROCEDURE

- a. The EUT was directly connected to the spectrum analyzer and antenna output port as show in the block diagram below,
- b. Setting : RBW \geq the 20 dB bandwidth of the emission being measured
 - Span \geq approximately 3 times the 20 dB bandwidth, centered on a hopping channel
 - VBW \geq RBW
 - Sweep = auto
 - Detector function = peak
 - Trace = max hold

10.3 DEVIATION FROM STANDARD

No deviation.

10.4 TEST SETUP**10.5 EUT OPERATION CONDITIONS**

The EUT tested system was configured as the statements of 2.4 Unless otherwise a special operating condition is specified in the follows during the testing.

10.6 TEST RESULTS

EUT :	Mobile Phone	Model Name :	T349
Temperature :	25 °C	Relative Humidity :	60%
Pressure :	1012 hPa	Test Mode :	CH00/ CH39 /CH78 (1M/2M/3Mbps Mode)
Test Date	July 15, 2016		

1Mbps				
Test Channel	Frequency (MHz)	Peak Output Power (dBm)	LIMIT(dBm)	Result
CH00	2402	1.89	20.96	Pass
CH39	2441	2.22	20.96	Pass
CH78	2480	1.79	20.96	Pass
2Mbps				
CH00	2402	0.76	20.96	Pass
CH39	2441	0.10	20.96	Pass
CH78	2480	-0.21	20.96	Pass
3Mbps				
CH00	2402	-0.26	20.96	Pass
CH39	2441	-0.14	20.96	Pass
CH78	2480	--0.18	20.96	Pass

CH00 -1Mbps

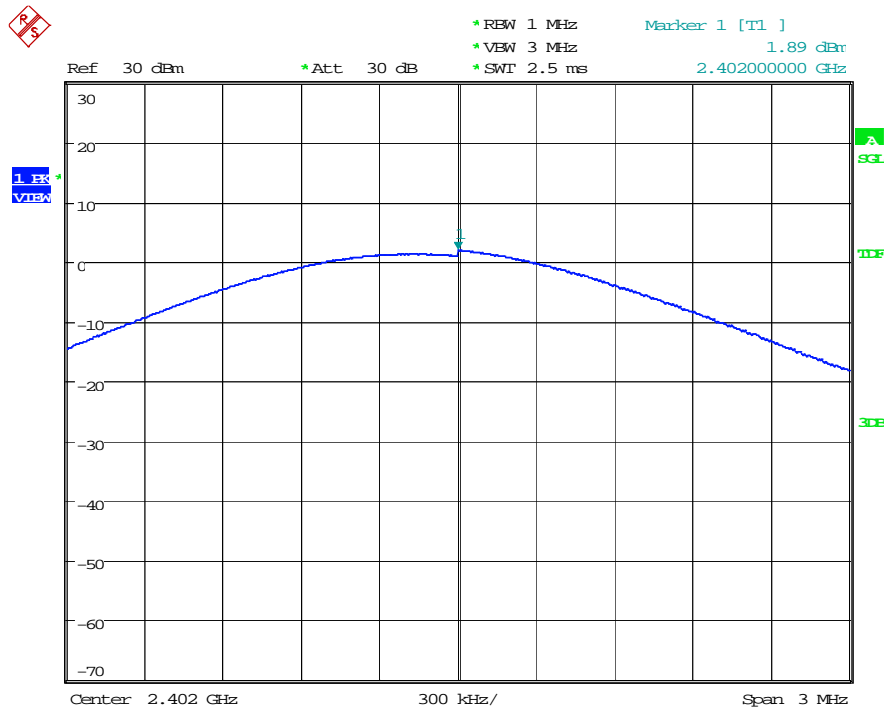

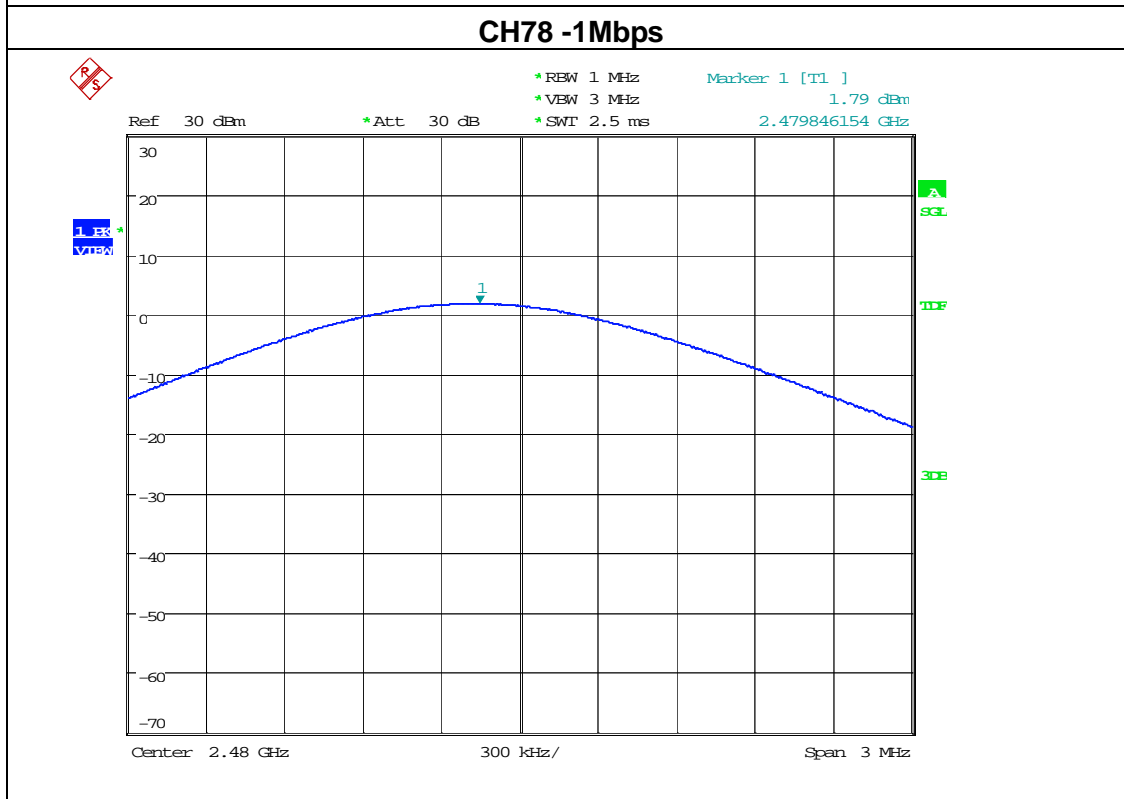
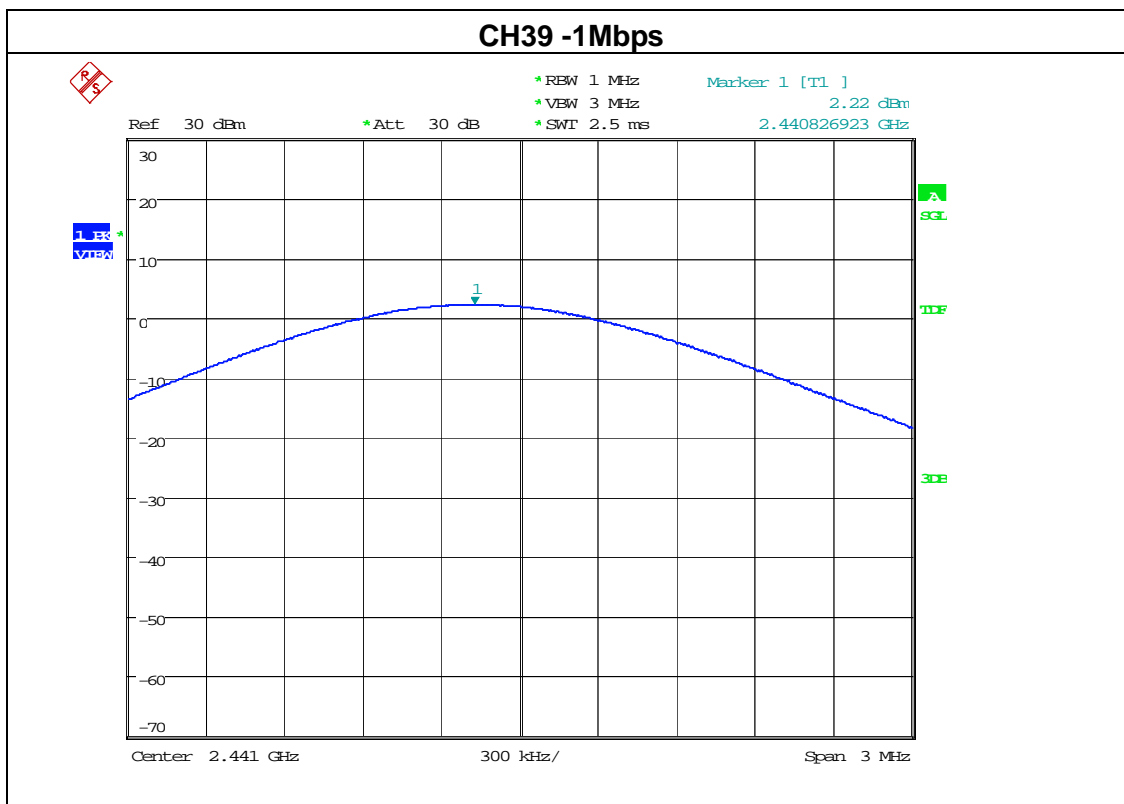

CH00 -2Mbps

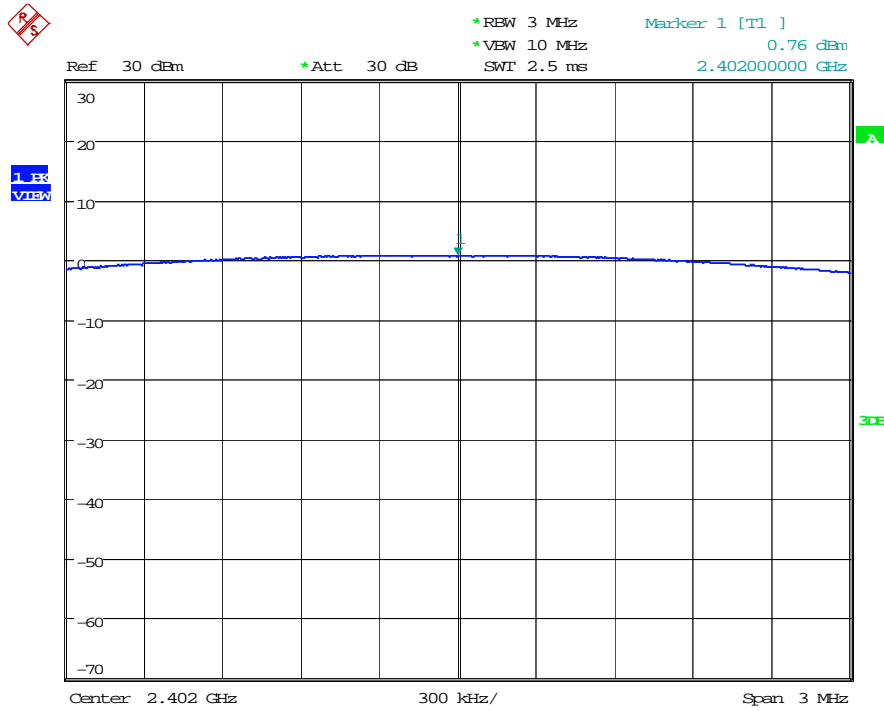

CH39 -2Mbps

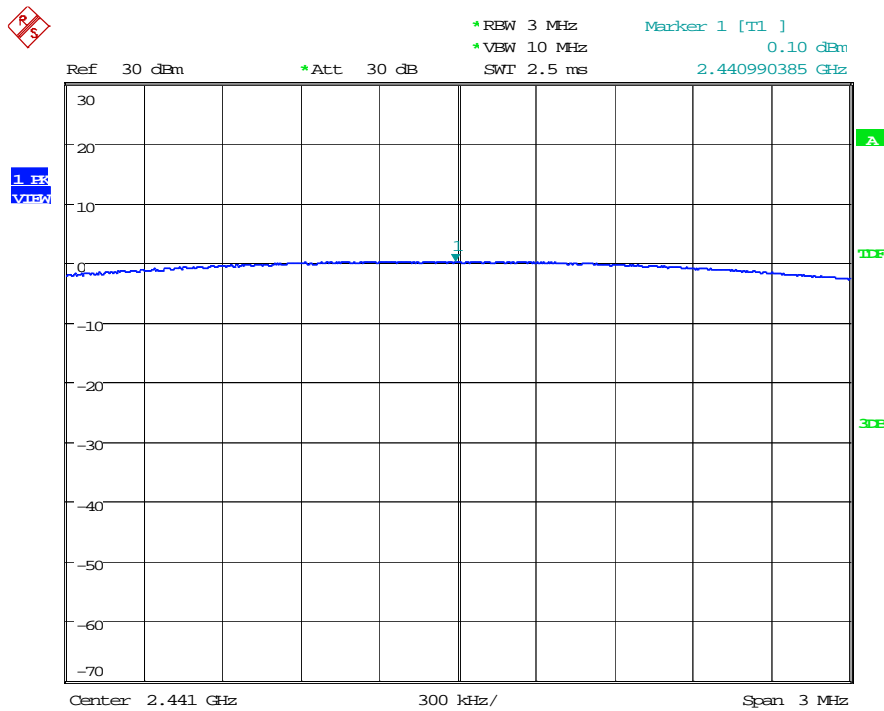

CH78 -2Mbps

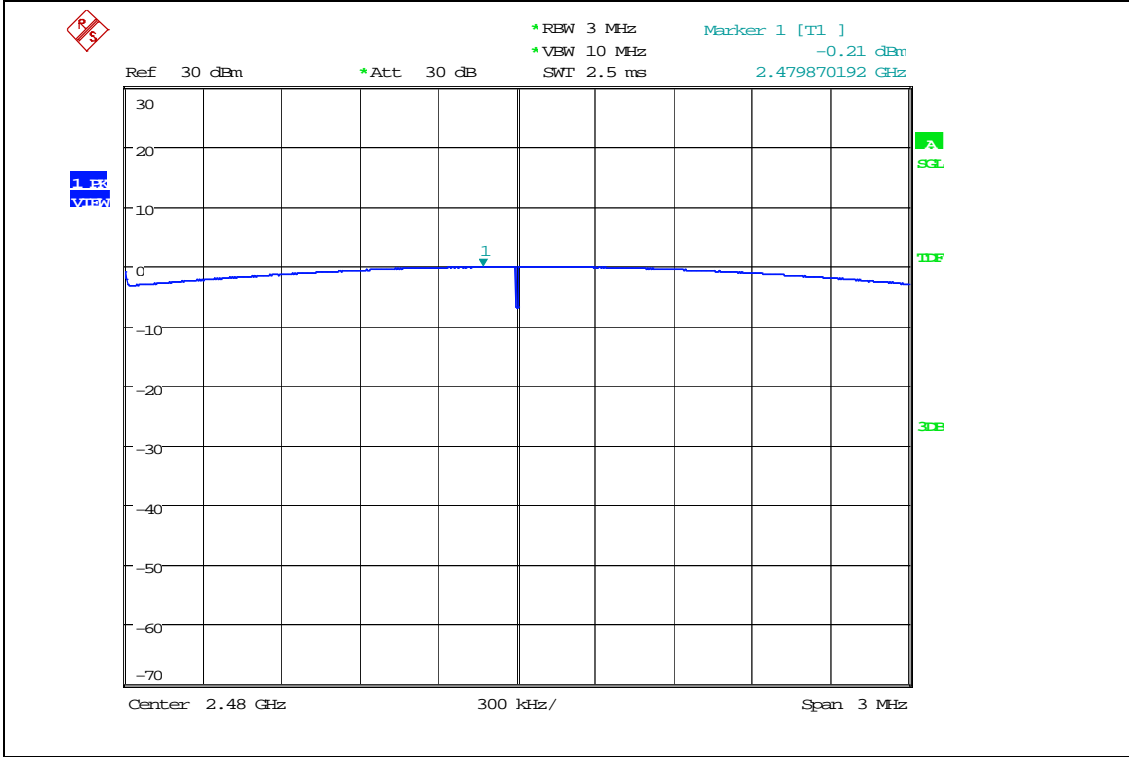

CH00 -3Mbps

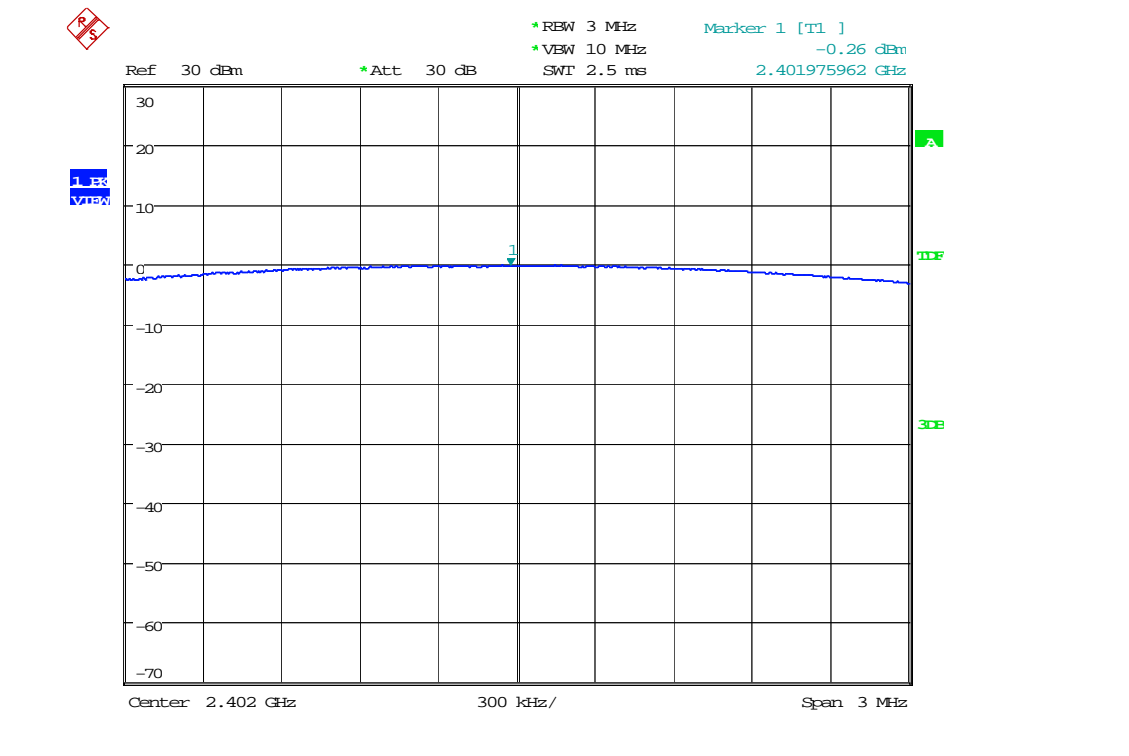

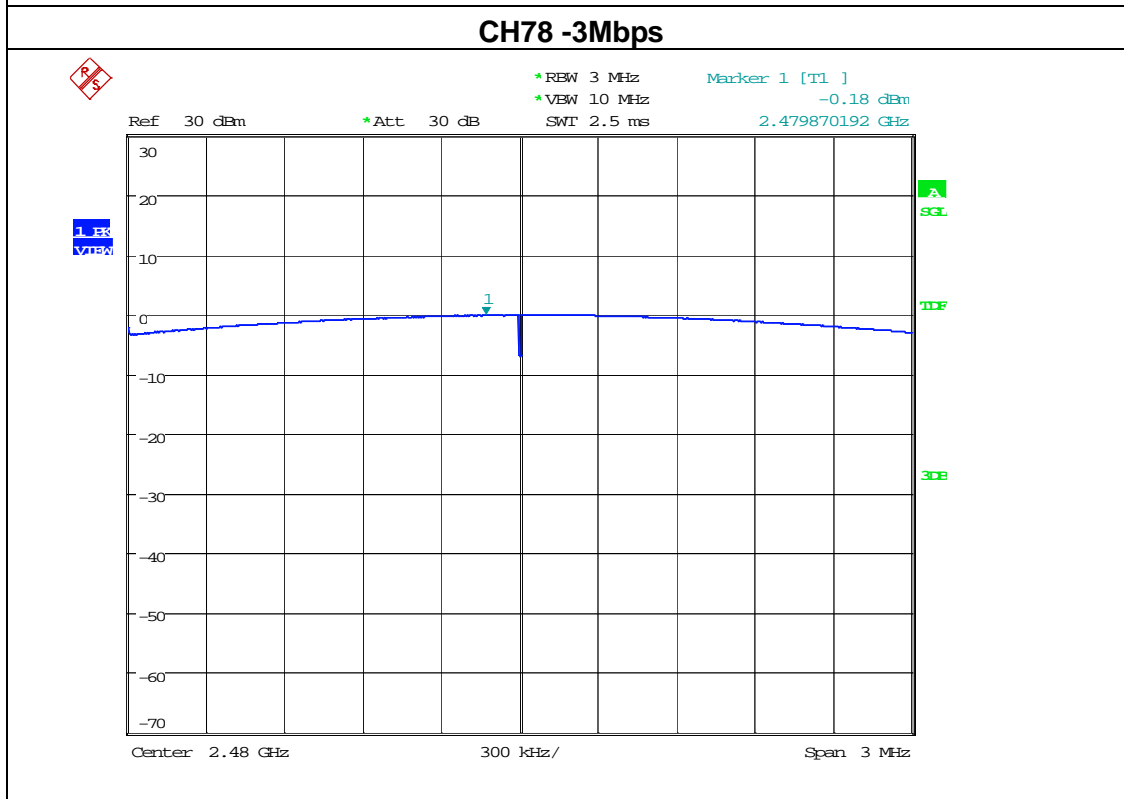
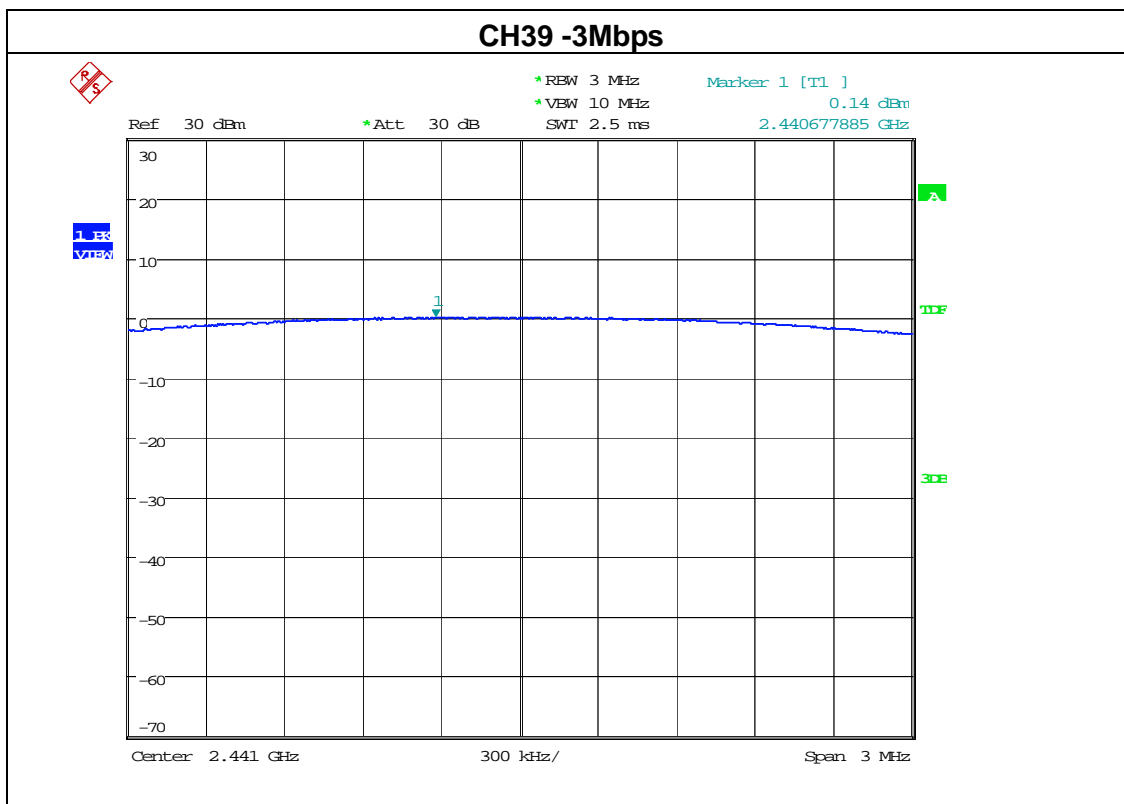

11. ANTENNA APPLICATION

11.1 Antenna requirement

The EUT'S antenna is met the requirement of FCC part 15C section 15.203 and 15.247

11.2 Result

The EUT's antenna integrated on PCB, The antenna's gain is 1.55dBi and meets the requirement.

12. EUT TEST PHOTO

CONDUCTED EMISSION TEST



RADIATED EMISSION TEST

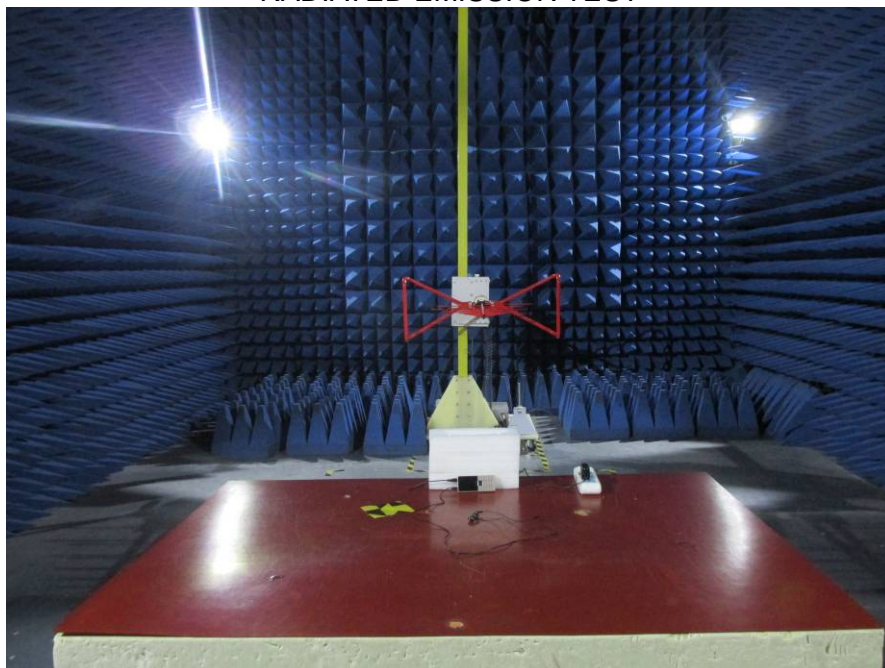

RADIATED EMISSION TEST

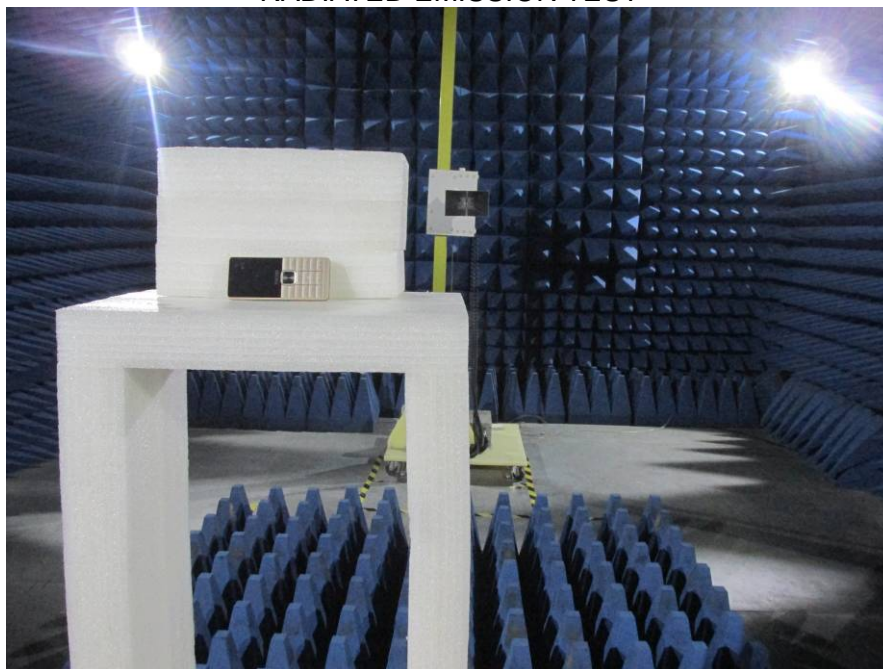

RF TEST



13. PHOTOGRAPHS OF EUT

Appearance photograph of EUT



Appearance photograph of EUT



Appearance photograph of EUT



Appearance photograph of EUT



Appearance photograph of EUT



Appearance photograph of EUT



Appearance photograph of EUT



Internal photograph of EUT



Internal photograph of EUT



Internal photograph of EUT



Internal photograph of EUT

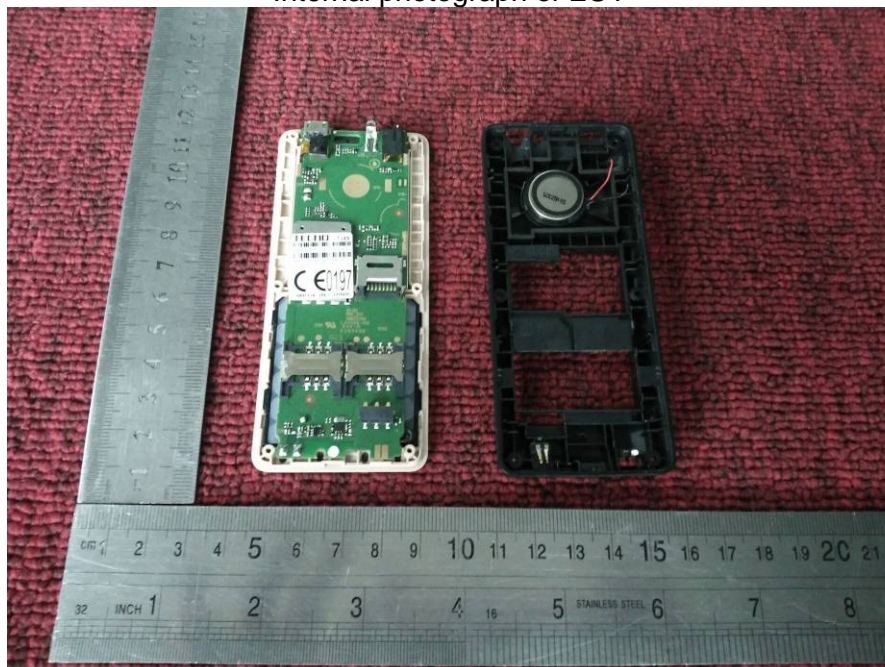

Internal photograph of EUT

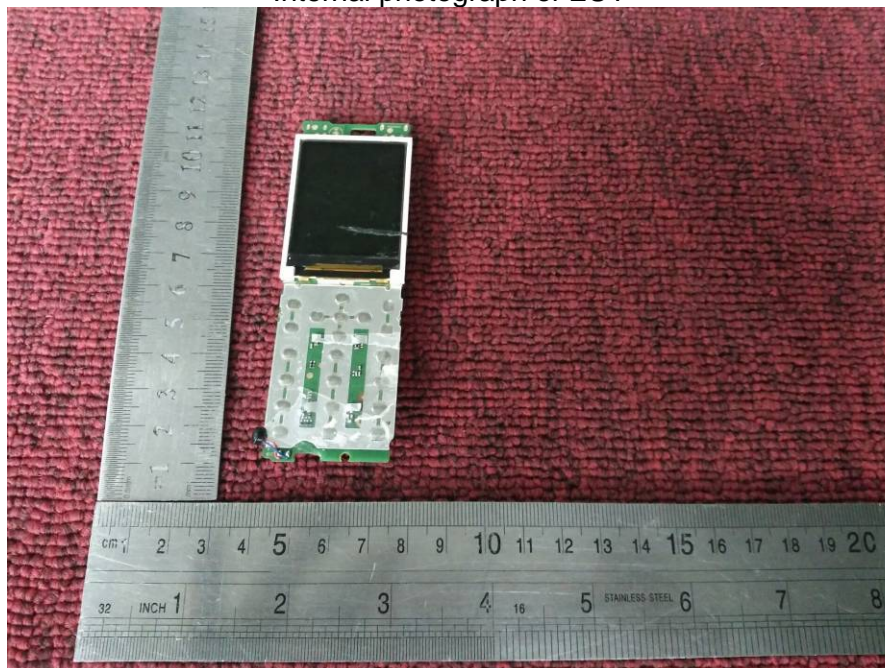

Internal photograph of EUT

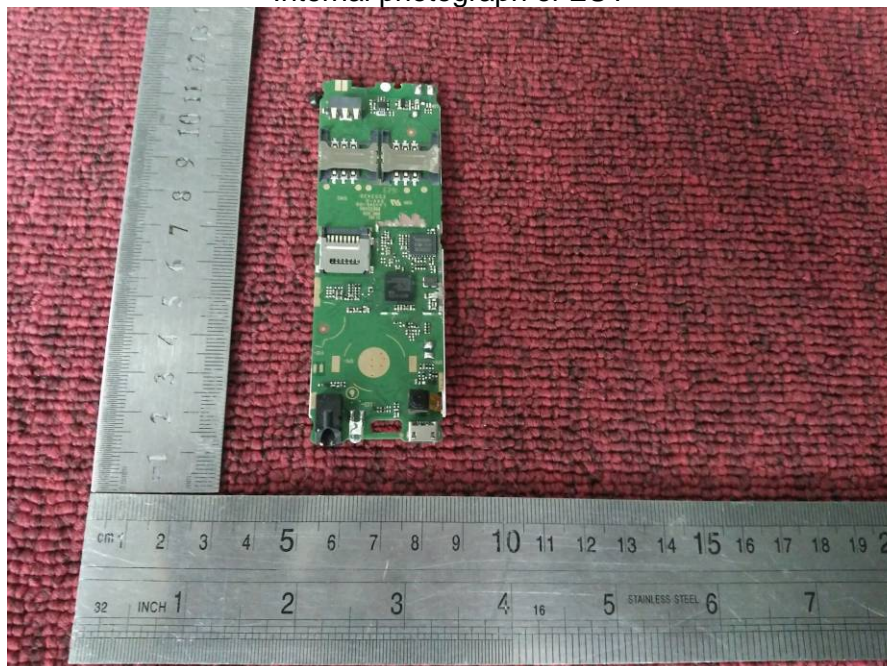

Internal photograph of EUT



—END OF REPORT—