

## TEST REPORT

**Applicant:** TECNO MOBILE LIMITED  
**Address:** FLAT N 16/F BLOCK B UNIVERSAL INDUSTRIAL CENTRE  
19-25 SHAN MEI STREET FOTAN NT HONGKONG  
**Product Name:** Tablet  
**FCC ID:** 2ADYY-T1001  
**Standard(s):** 47 CFR Part 2, 47 CFR Part 22, Subpart H  
47 CFR Part 24, Subpart E  
47 CFR Part 27  
ANSI C63.26-2015  
**Report Number:** 2402U81179E-RF-00E  
**Report Date:** 2024/7/25

The above device has been tested and found compliant with the requirement of the relative standards by Bay Area Compliance Laboratories Corp. (Dongguan).

*Gavin Xu*

**Reviewed By:** Gavin Xu  
Title: RF Engineer

*Ivan Cao*

**Approved By:** Ivan Cao  
Title: EMC Manager

---

**Bay Area Compliance Laboratories Corp. (Dongguan)**  
No.12, Pulong East 1<sup>st</sup> Road, Tangxia Town, Dongguan, Guangdong, China

Tel: +86-769-86858888

Fax: +86-769-86858891

[www.baclcorp.com.cn](http://www.baclcorp.com.cn)

Note: The information marked ▲ is provided by the applicant, the laboratory is not responsible for its authenticity and this information can affect the validity of the result in the test report. Unless otherwise stated the results shown in this test report refer only to the sample(s) tested. This report cannot be reproduced except in full, without prior written approval of the Company. This report is valid only with a valid digital signature. The digital signature may be available only under the Adobe software above version 7.0. This report may contain data that are not covered by the accreditation scope and shall be marked with ★. This report must not be used by the client to claim product certification, approval, or endorsement by NVLAP, NIST, or any agency of the U.S. Government.

## CONTENTS

<b>DOCUMENT REVISION HISTORY .....</b>	<b>3</b>
<b>1. GENERAL INFORMATION .....</b>	<b>4</b>
<b>1.1 PRODUCT DESCRIPTION FOR EQUIPMENT UNDER TEST (EUT) .....</b>	<b>4</b>
<b>1.2 ACCESSORY INFORMATION.....</b>	<b>4</b>
<b>1.3 OPERATION VOLTAGE(<math>V_{DC}</math>)▲: .....</b>	<b>5</b>
<b>1.4 TRANSMISSION ANTENNA INFORMATION▲ .....</b>	<b>5</b>
<b>1.5 EQUIPMENT MODIFICATIONS .....</b>	<b>5</b>
<b>2. SUMMARY OF TEST RESULTS .....</b>	<b>6</b>
<b>3. DESCRIPTION OF TEST CONFIGURATION .....</b>	<b>7</b>
<b>3.1 EUT OPERATION CONDITION: .....</b>	<b>7</b>
<b>3.2 EUT EXERCISE SOFTWARE.....</b>	<b>12</b>
<b>3.3 SUPPORT EQUIPMENT LIST AND DETAILS .....</b>	<b>12</b>
<b>3.4 SUPPORT CABLE LIST AND DETAILS .....</b>	<b>12</b>
<b>3.5 BLOCK DIAGRAM OF TEST SETUP .....</b>	<b>12</b>
<b>3.6 TEST FACILITY.....</b>	<b>13</b>
<b>3.7 MEASUREMENT UNCERTAINTY .....</b>	<b>13</b>
<b>4. REQUIREMENTS AND TEST PROCEDURES .....</b>	<b>14</b>
<b>4.1 APPLICABLE STANDARD FOR PART 22 SUBPART H: .....</b>	<b>14</b>
<b>4.2 APPLICABLE STANDARD FOR PART 24 SUBPART E: .....</b>	<b>16</b>
<b>4.3 APPLICABLE STANDARD FOR PART 27: .....</b>	<b>17</b>
<b>4.4 TEST METHOD: .....</b>	<b>20</b>
<b>5. Test DATA AND RESULTS.....</b>	<b>27</b>
<b>5.1 ANTENNA PORT TEST DATA AND RESULTS: .....</b>	<b>27</b>
<b>5.2 RADIATED SPURIOUS EMISSIONS.....</b>	<b>28</b>
<b>EXHIBIT A - EUT PHOTOGRAPHS.....</b>	<b>37</b>
<b>EXHIBIT B - TEST SETUP PHOTOGRAPHS .....</b>	<b>38</b>

---

## DOCUMENT REVISION HISTORY

---

Revision Number	Report Number	Description of Revision	Date of Revision
1.0	2402U81179E-RF-00E	Original Report	2024/7/25

## 1. GENERAL INFORMATION

### 1.1 Product Description for Equipment under Test (EUT)

<b>EUT Name:</b>	Tablet
<b>EUT Model:</b>	T1001
<b>Operation Bands and modes:</b>	GSM/GPRS/EDGE: 850/1900 WCDMA: Band 5 LTE: Band 5/7/38/41
<b>Modulation Type:</b>	GMSK, 8PSK, BPSK, QPSK, 16QAM
<b>Rated Input Voltage:</b>	DC 3.85V from battery or DC 5/9/12V from adapter
<b>Serial Number:</b>	2N1N-4(For Radiated spurious emission test) 2N1N-3(For RF Conducted Test)
<b>EUT Received Date:</b>	2024/6/18
<b>EUT Received Status:</b>	Good

### Optional Material:

Material Description	Manufacturer	Model
Screen 1	Shenzhen HJR Electronics Technology Co.,LTD	TLCM-HJR101059D-A0
Screen 2	SAT INTERNATIONAL CO.,LTD	SAT101AT451M0712-Q0054
Camera 1	XINFENG SEGA SCIENCE AND TECHNOLOGY CO., LTD	/
Camera 2	SHENZHEN CHENGXIANG TECHNOLOGY CO.,LTD	/
Battery 1	HuiZhou Ganfeng LiEnergy Battery Tech Co., LTD	T1001 11CP3/92/161
Battery 2	Hunan Gaoyuan Battery Co.,Ltd.	T1001 11CP3/92/161
eMMC 1	Shenzhen Longsys Electronics Co., Ltd.	FEMDNN256G
eMMC 2	Phison Electronics Corp.	PTE8A0HR-X28E
DDR 1	Shenzhen Longsys Electronics Co., Ltd.	FLXC4004G-W6
DDR 2	Samsung Electronics Co., Ltd.	K4UBE3D
PCB 1	/	Green Color
PCB 2	/	Black Color
Enclosure 1	/	Gold Color
Enclosure 2	/	Grey Color

Note 1: test was performed with the configuration with Screen 1+Camera 1+Battery 1+eMMC 1+DDR 1, since it was the worst combination per 15B EMC test.  
Note 2: the Color of PCB and Enclosure is not affect the EMC test.

### 1.2 Accessory Information

Accessory Description	Manufacturer	Model	Parameters
Adapter	TECNO MOBILE LIMITED	FC447U	Input: 100-240Vac 50/60Hz 0.5A MAX Output: 5.0Vdc 3A 15W or 9Vdc 2.22A 19.98W or 12Vdc 1.67A 20.04W

**1.3 Operation Voltage( $V_{DC}$ )▲ :**

Lowest:	3.6	Normal:	3.85	Highest:	4.4
---------	-----	---------	------	----------	-----

**1.4 Transmission Antenna Information ▲**

Manufacturer	Antenna Type	Operation Bands	Antenna Frequency Range (MHz)	Antenna Gain (Gr) (dBi)	Lc (dB)
SHENZHEN Xingyuanchuang TECHNOLOGY CO.,LTD	FPC	GSM850	824-849	-3.19	/
		PCS1900	1850-1910	1.91	/
		WCDMA B5	824-849	-3.19	/
		LTE B5	824-849	-3.19	/
		LTE B7	2500-2570	0.53	/
		LTE B38	2570-2620	0.25	/
		LTE B41	2535-2655	0.92	/

**1.5 Equipment Modifications**

No modifications are made to the EUT during all test items.

## 2. SUMMARY OF TEST RESULTS

Rules	Description of Test	Result
FCC§2.1046; § 22.913; § 24.232; §27.50	RF Output Power	Compliant
FCC§ 2.1047	Modulation Characteristics	Not Applicable
FCC§ 2.1049; § 22.905 § 22.917; § 24.238; §27.53	Occupied Bandwidth	Compliant
FCC§ 2.1051, § 22.917; § 24.238; §27.53	Spurious Emissions at Antenna Terminal	Compliant
FCC§ 22.917; § 24.238; §27.53	Out of band emission, Band Edge	Compliant
FCC§ 2.1055 § 22.355; § 24.235; §27.54	Frequency stability vs. temperature Frequency stability vs. voltage	Compliant
FCC§ 2.1053 § 22.917; § 24.238; §27.53	Radiated Spurious Emission	Compliant

### 3. ESCRIPTION OF TEST CONFIGURATION

#### 3.1 EUT Operation Condition:

The EUT was configured for testing according to ANSI C63.26-2015.

The test items were performed with the EUT operating at testing mode. The device operates on GSM Band 850/1900MHz, WCDMA Band 5, and LTE band 5/7/38/41, test was performed with channels as below table:

Frequency Bands	Bandwidth (MHz)	Test Frequency(MHz)		
		Low	Middle	High
GPRS/EDGE850	0.25	824.2	836.6	848.8
GPRS/EDGE1900	0.25	1850.2	1880	1909.8
WCDMA Band 5	4.2	826.4	836.6	846.6
LTE Band 5	1.4	824.7	836.5	848.3
	3	825.5	836.5	847.5
	5	826.5	836.5	846.5
	10	829	836.5	844
LTE Band 7	5	2502.5	2535	2567.5
	10	2505	2535	2565
	15	2507.5	2535	2562.5
	20	2510	2535	2560
LTE Band 38	5	2572.5	2595	2617.5
	10	2575	2595	2615
	15	2577.5	2595	2612.5
	20	2580	2595	2610
LTE Band 41	5	2498.5	2593	2687.5
	10	2501	2593	2685
	15	2503.5	2593	2682.5
	20	2506	2593	2680

The maximum power was configured per 3GPP Standard for each operation modes as below setting:

GSM/GPRS/EGPRS

Function: Menu select > GSM Mobile Station > GSM 850/1900  
 Press Connection control to choose the different menus  
 Press RESET > choose all the reset all settings  
 Connection Press Signal Off to turn off the signal and change settings  
 Network Support > GSM + GPRS or GSM + EGSM  
 Main Service > Packet Data  
 Service selection > Test Mode A – Auto Slot Config. off  
 MS Signal Press Slot Config Bottom on the right twice to select and change the number of time slots and power setting  
     > Slot configuration > Uplink/Gamma  
     > 33 dBm for GPRS 850  
     > 30 dBm for GPRS 1900  
     > 27 dBm for EGPRS 850  
     > 26 dBm for EGPRS 1900  
 BS Signal Enter the same channel number for TCH channel (test channel) and BCCH channel  
 Frequency Offset > + 0 Hz  
 Mode > BCCH and TCH

BCCH Level > -85 dBm (May need to adjust if link is not stable)  
 BCCH Channel > choose desire test channel [Enter the same channel number for TCH channel (test channel) and BCCH channel]

Channel Type > Off  
 P0 > 4 dB  
 Slot Config > Unchanged (if already set under MS signal)  
 TCH > choose desired test channel  
 Hopping > Off  
 Main Timeslot > 3  
 Network Coding Scheme > CS4 (GPRS) and MCS5 (EGPRS)

Bit Stream > 2E9-1 PSR Bit Stream  
 AF/RF Enter appropriate offsets for Ext. Att. Output and Ext. Att. Input  
 Connection Press Signal on to turn on the signal and change settings



**WCDMA**

The following tests were conducted according to the test requirements outlines in section 5.2 of the 3GPP TS34.121-1 specification.

	Mode	HSUPA	HSUPA	HSUPA	HSUPA	HSUPA
	Subset	1	2		4	5
<b>WCDMA General Settings</b>	Loopback Mode	Test Mode 1				
	Rel99 RMC	12.2kbps RMC				
	HSDPA FRC	H-Set1				
	HSUPA Test	HSUPA Loopback				
	Power Control Algorithm	Algorithm2				
	$\beta_c$	11/15	6/15	15/15	2/15	15/15
	$\beta_d$	15/15	15/15	9 / 15	1 / 5	0
	$\beta_{ec}$	20 /225	12/15	30 / 15	2/15	5/15
	$\beta_c / \beta_d$	11/15	6/15	15/9	2/15	-
	$\beta_{hs}$	22/15	12/15	30 / 15	4/15	5/15
CM(dB)	1.0	3.0	2.0	3.0	1.0	
PR(dB)	0	2	1	2	0	
<b>HSDPA Specific Settings</b>	DACK	8				
	DNAK	8				
	DCQI	8				
	Ack-Nack repetition factor	3				
	CQI Feedback	4ms				
	CQI Repetition Factor	2				
	$A_{hs} = \beta_{hs} / \beta_c$	30/15				
<b>HSUPA Specific Settings</b>	DE-DPCCH	6		8	5	7
	DHARQ	0	0	0	0	0
	AG Index	20	12	15	17	21
	ETFCI	75	67	92	71	81
	Associated Max UL Data Rate k ps	242.1	174.9	482.8	205.8	308.9
	Referenc E_F 1	E-TFCI 11 E E-TFCI PO 4 E-TFCI 67 E-TFCI PO 18 E-TFCI 71 E-TFCI PO23 E-TFCI 75 E-TFCI PO26 E-TFCI 81 E-TFCI PO 27	E-TFCI 11 E-TFCI PO4 E-TFCI 92 E-TFCI PO 18	E-TFCI 11 E E-TFCI PO 4 E-TFCI 67 E-TFCI PO 18 E-TFCI 71 E-TFCI PO23 E-TFCI 75 E-TFCI PO26 E-TFCI 81 E-TFCI PO 27		

**LTE (FDD):**

The following tests were conducted according to the test requirements in 3GPP TS36.101

The following tests were conducted according to the test requirements outlined in section 6.2 of the 3GPP TS36.101 specification.

UE Power Class: 3 (23 +/- 2dBm). The allowed Maximum Power Reduction (MPR) for the maximum output power due to higher order modulation and transmit bandwidth configuration (resource blocks) is specified in Table 6.2.3-1 of the 3GPP TS36.101.

**Table 6.2.3-1: Maximum Power Reduction (MPR) for Power Class 3**

Modulation	Channel bandwidth / Transmission bandwidth (RB)						MPR (dB)
	1.4 MHz	3.0 MHz	5 MHz	10 MHz	15 MHz	20 MHz	
QPSK	> 5	> 4	> 8	> 12	> 16	> 18	≤ 1
16 QAM	≤ 5	≤ 4	≤ 8	≤ 12	≤ 16	≤ 18	≤ 1
16 QAM	> 5	> 4	> 8	> 12	> 16	> 18	≤ 2

The allowed A-MPR values specified below in Table 6.2.4.-1 of 3GPP TS36.101 are in addition to the allowed MPR requirements. All the measurements below were performed with A-MPR disabled, by using Network Signaling Value of "NS\_01".

**Table 6.2.4-1: Additional Maximum Power Reduction (A-MPR)**

Network Signalling value	Requirements (sub-clause)	E-UTRA Band	Channel bandwidth (MHz)	Resources Blocks ( $N_{RB}$ )	A-MPR (dB)
NS_01	6.6.2.1.1	Table 5.5-1	1.4, 3, 5, 10, 15, 20	Table 5.6-1	NA
NS_03	6.6.2.2.1	2, 4, 10, 23, 25, 35, 36	3	>5	≤ 1
			5	>6	≤ 1
			10	>6	≤ 1
			15	>8	≤ 1
			20	>10	≤ 1
NS_04	6.6.2.2.2	41	5	>6	≤ 1
			10, 15, 20	See Table 6.2.4-4	
NS_05	6.6.3.3.1	1	10, 15, 20	≥ 50	≤ 1
NS_06	6.6.2.2.3	12, 13, 14, 17	1.4, 3, 5, 10	Table 5.6-1	n/a
NS_07	6.6.2.2.3	13	10	Table 6.2.4-2	Table 6.2.4-2
	6.6.3.3.2				
NS_08	6.6.3.3.3	19	10, 15	> 44	≤ 3
NS_09	6.6.3.3.4	21	10, 15	> 40	≤ 1
				> 55	≤ 2
				Table 6.2.4-3	
NS_10		20	15, 20	Table 6.2.4-3	Table 6.2.4-3
NS_11	6.6.2.2.1	23 <sup>1</sup>	1.4, 3, 5, 10	Table 6.2.4-5	Table 6.2.4-5
..					
NS_32	-	-	-	-	-

Note 1: Applies to the lower block of Band 23, i.e. a carrier placed in the 2000-2010 MHz region.

**LTE(TDD):**

Table 4.2-1: Configuration of special subframe (lengths of DwPTS/GP/UpPTS).

Special subframe configuration	Normal cyclic prefix in downlink				Extended cyclic prefix in downlink		
	DwPTS	UpPTS		DwPTS	UpPTS		
		Normal cyclic prefix in uplink	Extended cyclic prefix in uplink		Normal cyclic prefix in uplink	Extended cyclic prefix in uplink	
0	$6592 \cdot T_s$	$2192 \cdot T_s$	$2560 \cdot T_s$	$7680 \cdot T_s$	$2192 \cdot T_s$	$2560 \cdot T_s$	
1	$19760 \cdot T_s$			$20480 \cdot T_s$			
2	$21952 \cdot T_s$			$23040 \cdot T_s$			
3	$24144 \cdot T_s$			$25600 \cdot T_s$			
4	$26336 \cdot T_s$			$7680 \cdot T_s$			
5	$6592 \cdot T_s$	$4384 \cdot T_s$	$5120 \cdot T_s$	$20480 \cdot T_s$	$4384 \cdot T_s$	$5120 \cdot T_s$	
6	$19760 \cdot T_s$			$23040 \cdot T_s$			
7	$21952 \cdot T_s$			$12800 \cdot T_s$			
8	$24144 \cdot T_s$			-			
9	$13168 \cdot T_s$			-			

Table 4.2-2: Uplink-downlink configurations.

Uplink-downlink configuration	Downlink-to-Uplink Switch-point periodicity	Subframe number									
		0	1	2	3	4	5	6	7	8	9
0	5 ms	D	S	U	U	U	D	S	U	U	U
1	5 ms	D	S	U	U	D	D	S	U	U	D
2	5 ms	D	S	U	D	D	D	S	U	D	D
3	10 ms	D	S	U	U	U	D	D	D	D	D
4	10 ms	D	S	U	U	D	D	D	D	D	D
5	10 ms	D	S	U	D	D	D	D	D	D	D
6	5 ms	D	S	U	U	U	D	S	U	U	D

**Calculated Duty Cycle**

Uplink-Downlink Configuration	Downlink-to-Uplink Switch-point Periodicity	Subframe Number										Calculated Duty Cycle (%)
		0	1	2	3	4	5	6	7	8	9	
0	5 ms	D	S	U	U	U	D	S	U	U	U	63.33
1	5 ms	D	S	U	U	D	D	S	U	U	D	43.33
2	5 ms	D	S	U	D	D	D	S	U	D	D	23.33
3	10 ms	D	S	U	U	U	D	D	D	D	D	31.67
4	10 ms	D	S	U	U	D	D	D	D	D	D	21.67
5	10 ms	D	S	U	D	D	D	D	D	D	D	11.67
6	5 ms	D	S	U	U	U	D	S	U	U	D	53.33

Calculated Duty Cycle = Extended cyclic prefix in uplink x (T<sub>s</sub>) x # of S + # of U

Example for Calculated Duty Cycle for Uplink-Downlink Configuration 0:  
 Calculated Duty Cycle =  $5120 \times [1/(15000 \times 2048)] \times 2 + 6 \text{ ms} = 63.33\%$   
 where  
 T<sub>s</sub> = 1/(15000 x 2048) seconds

### 3.2 EUT Exercise Software

No software was used in test.

### 3.3 Support Equipment List and Details

Manufacturer	Description	Model	Serial Number
R&S	Wideband Radio Communication Tester	CMW500	149216
Unknown	Antenna	Unknown	Unknown

### 3.4 Support Cable List and Details

Cable Description	Shielding Type	Ferrite Core	Length (m)	From Port	To
USB Cable	No	No	0.8	Adapter	EUT
Earphone Cable	No	No	1.2	Earphone	EUT

### 3.5 Block Diagram of Test Setup

Radiated Spurious Emission:

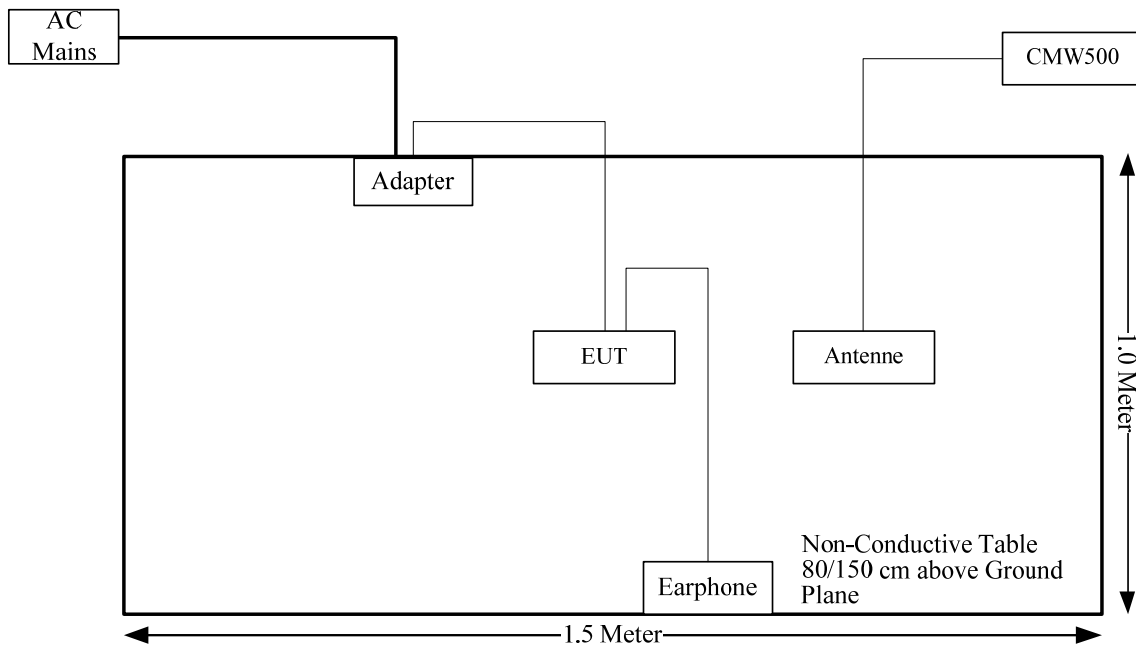

### 3.6 Test Facility

The Test site used by Bay Area Compliance Laboratories Corp. (Dongguan) to collect test data is located on the No.12, Pulong East 1st Road, Tangxia Town, Dongguan, Guangdong, China.

The lab has been recognized as the FCC accredited lab under the KDB 974614 D01 and is listed in the FCC Public Access Link (PAL) database, FCC Registration No. : 829273, the FCC Designation No. : CN5044.

The lab has been recognized by Innovation, Science and Economic Development Canada to test to Canadian radio equipment requirements, the CAB identifier: CN0022.

### 3.7 Measurement Uncertainty

Otherwise required by the applicant or Product Regulations, Decision Rule in this report did not consider the uncertainty. The extended uncertainty given in this report is obtained by combining the standard uncertainty times the coverage factor K with the 95% confidence interval.

Parameter	Measurement Uncertainty
Occupied Channel Bandwidth	±5 %
RF output power, conducted	±0.61dB
Power Spectral Density, conducted	±0.61 dB
Unwanted Emissions, radiated	30MHz~200MHz: 4.55 dB, 200MHz~1GHz: 5.92 dB, 1GHz~6GHz: 4.98 dB, 6GHz~18GHz: 5.89 dB, 18GHz~26.5GHz:5.47 dB, 26.5GHz~40GHz:5.63 dB
Unwanted Emissions, conducted	±2.47 dB
Temperature	±1 °C
Humidity	±5%
DC and low frequency voltages	±0.4%
Duty Cycle	1%
RF Frequency	±0.082×10 <sup>-6</sup>

## 4. REQUIREMENTS AND TEST PROCEDURES

---

### 4.1 Applicable Standard For Part 22 Subpart H:

#### 4.1.1 RF Output Power

FCC §22.913

(a)(5) The ERP of mobile transmitters and auxiliary test transmitters must not exceed 7watts.

(d) *Power measurement.* Measurement of the ERP of Cellular base transmitters and repeaters must be made using an average power measurement technique. The peak-to-average ratio (PAR) of the transmission must not exceed 13 dB. Power measurements for base transmitters and repeaters must be made in accordance with either of the following:

- (1) A Commission-approved average power technique (*see* FCC Laboratory's Knowledge Database); or
- (2) For purposes of this section, peak transmit power must be measured over an interval of continuous transmission using instrumentation calibrated in terms of an rms-equivalent voltage. The measurement results shall be properly adjusted for any instrument limitations, such as detector response times, limited resolution bandwidth capability when compared to the emission bandwidth, sensitivity, *etc.*, so as to obtain a true peak measurement for the emission in question over the full bandwidth of the channel.

#### 4.1.2 Spurious Emissions

FCC §22.917

(a) Out of band emissions. The power of any emission outside of the authorized operating frequency ranges must be attenuated below the transmitting power (P) by a factor of at least  $43 + 10 \log(P)$  dB.

(b) Measurement procedure. Compliance with these rules is based on the use of measurement instrumentation employing a reference bandwidth as follows:

- (1) In the spectrum below 1 GHz, instrumentation should employ a reference bandwidth of 100 kHz or greater. In the 1 MHz bands immediately outside and adjacent to the frequency block, a resolution bandwidth of at least one percent of the emission bandwidth of the fundamental emission of the transmitter may be employed. A narrower resolution bandwidth is permitted in all cases to improve measurement accuracy, provided that the measured power is integrated over the full required reference bandwidth (i.e., 100 kHz or 1 percent of emission bandwidth, as specified). The emission bandwidth is defined as the width of the signal between two points, one below the carrier center frequency and one above the carrier center frequency, outside of which all emissions are attenuated at least 26 dB below the transmitter power.
- (2) In the spectrum above 1 GHz, instrumentation should employ a reference bandwidth of 1 MHz

#### 4.1.3 Frequency stability

FCC §22.355

Except as otherwise provided in this part, the carrier frequency of each transmitter in the Public Mobile Services must be maintained within the tolerances given in Table C-1 of this section.

Table C-1 - Frequency Tolerance for Transmitters in the Public Mobile Services

<b>Frequency range (MHz)</b>	<b>Base, fixed (ppm)</b>	<b>Mobile &gt;3 watts (ppm)</b>	<b>Mobile <math>\leq</math>3 watts (ppm)</b>
25 to 50	20	20	50
50 to 450	5	5	50
450 to 512	2.5	5	5
821 to 896	1.5	<b>2.5</b>	<b>2.5</b>
928 to 929	5	n/a	n/a
929 to 960	1.5	n/a	n/a
2110 to 2220	10	n/a	n/a

## 4.2 Applicable Standard For Part 24 Subpart E:

### 4.2.1 RF Output Power

FCC §24.232

(c) Mobile and portable stations are limited to 2 watts EIRP and the equipment must employ a means for limiting power to the minimum necessary for successful communications.

(d) Power measurements for transmissions by stations authorized under this section may be made either in accordance with a Commission-approved average power technique or in compliance with paragraph (e) of this section. In both instances, equipment employed must be authorized in accordance with the provisions of § 24.51. In measuring transmissions in this band using an average power technique, the peak-to-average ratio (PAR) of the transmission may not exceed 13 dB.

### 4.2.2 Spurious Emissions

FCC §24.238

The rules in this section govern the spectral characteristics of emissions in the Broadband Personal Communications Service.

(a) Out of band emissions. The power of any emission outside of the authorized operating frequency ranges must be attenuated below the transmitting power (P) by a factor of at least  $43 + 10 \log(P)$  dB.

(b) Measurement procedure. Compliance with these rules is based on the use of measurement instrumentation employing a resolution bandwidth of 1 MHz or greater. However, in the 1 MHz bands immediately outside and adjacent to the frequency block a resolution bandwidth of at least one percent of the emission bandwidth of the fundamental emission of the transmitter may be employed. A narrower resolution bandwidth is permitted in all cases to improve measurement accuracy provided the measured power is integrated over the full required measurement bandwidth (i.e. 1 MHz or 1 percent of emission bandwidth, as specified). The emission bandwidth is defined as the width of the signal between two points, one below the carrier center frequency and one above the carrier center frequency, outside of which all emissions are attenuated at least 26 dB below the transmitter power.

(c) Alternative out of band emission limit. Licensees in this service may establish an alternative out of band emission limit to be used at specified band edge(s) in specified geographical areas, in lieu of that set forth in this section, pursuant to a private contractual arrangement of all affected licensees and applicants. In this event, each party to such contract shall maintain a copy of the contract in their station files and disclose it to prospective assignees or transferees and, upon request, to the FCC.

(d) Interference caused by out of band emissions. If any emission from a transmitter operating in this service results in interference to users of another radio service, the FCC may require a greater attenuation of that emission than specified in this section.

### 4.2.3 Frequency stability

FCC §24.235

The frequency stability shall be sufficient to ensure that the fundamental emission stays within the authorized frequency block.



### 4.3 Applicable Standard For Part 27:

#### 4.3.1 RF Output Power

FCC §27.50

(a)(3) *Mobile and portable stations.*

(i) For mobile and portable stations transmitting in the 2305-2315 MHz band or the 2350-2360 MHz band, the average EIRP must not exceed 50 milliwatts within any 1 megahertz of authorized bandwidth, *except that* for mobile and portable stations compliant with 3GPP LTE standards or another advanced mobile broadband protocol that avoids concentrating energy at the edge of the operating band the average EIRP must not exceed 250 milliwatts within any 5 megahertz of authorized bandwidth but may exceed 50 milliwatts within any 1 megahertz of authorized bandwidth. For mobile and portable stations using time division duplexing (TDD) technology, the duty cycle must not exceed 38 percent in the 2305-2315 MHz and 2350-2360 MHz bands. Mobile and portable stations using FDD technology are restricted to transmitting in the 2305-2315 MHz band. Power averaging shall not include intervals in which the transmitter is off.

(ii) Mobile and portable stations are not permitted to transmit in the 2315-2320 MHz and 2345-2350 MHz bands.

(iii) *Automatic transmit power control.* Mobile and portable stations transmitting in the 2305-2315 MHz band or in the 2350-2360 MHz band must employ automatic transmit power control when operating so the stations operate with the minimum power necessary for successful communications.

(iv) *Prohibition on external vehicle-mounted antennas.* The use of external vehicle-mounted antennas for mobile and portable stations transmitting in the 2305-2315 MHz band or the 2350-2360 MHz band is prohibited.

(b)(10) Portable stations (hand-held devices) transmitting in the 746-757 MHz, 776-788 MHz, and 805-806 MHz bands are limited to 3 watts ERP.

(c)(10) Portable stations (hand-held devices) in the 600 MHz uplink band and the 698-746 MHz band, and fixed and mobile stations in the 600 MHz uplink band are limited to 3 watts ERP.

(d)(4) Fixed, mobile, and portable (hand-held) stations operating in the 1710-1755 MHz band and mobile and portable stations operating in the 1695-1710 MHz and 1755-1780 MHz bands are limited to 1 watt EIRP. Fixed stations operating in the 1710-1755 MHz band are limited to a maximum antenna height of 10 meters above ground. Mobile and portable stations operating in these bands must employ a means for limiting power to the minimum necessary for successful communications.

(h) The following power limits shall apply in the BRS and EBS:

(2) Mobile and other user stations. Mobile stations are limited to 2.0 watts EIRP. All user stations are limited to 2.0 watts transmitter output power.

#### 4.3.2 Spurious Emissions

FCC §27.53

(a) For operations in the 2305-2320 MHz band and the 2345-2360 MHz band, the power of any emission outside a licensee's frequency band(s) of operation shall be attenuated below the transmitter power P (with averaging performed only during periods of transmission) within the licensed band(s) of operation, in watts, by the following amounts:

(4) For mobile and portable stations operating in the 2305-2315 MHz and 2350-2360 MHz bands:

(i) By a factor of not less than:  $43 + 10 \log (P)$  dB on all frequencies between 2305 and 2320 MHz and on all frequencies between 2345 and 2360 MHz that are outside the licensed band(s) of operation, not less than  $55 + 10 \log (P)$  dB on all frequencies between 2320 and 2324 MHz and on all frequencies between 2341 and 2345 MHz, not less than  $61 + 10 \log (P)$  dB on all frequencies between 2324 and 2328 MHz and on all frequencies between 2337 and 2341 MHz, and not less than  $67 + 10 \log (P)$  dB on all frequencies between 2328 and 2337 MHz;

(ii) By a factor of not less than  $43 + 10 \log (P)$  dB on all frequencies between 2300 and 2305 MHz,  $55 + 10 \log (P)$  dB on all frequencies between 2296 and 2300 MHz,  $61 + 10 \log (P)$  dB on all frequencies between 2292 and 2296 MHz,  $67 + 10 \log (P)$  dB on all frequencies between 2288 and 2292 MHz, and  $70 + 10 \log (P)$  dB below 2288 MHz;

(iii) By a factor of not less than  $43 + 10 \log (P)$  dB on all frequencies between 2360 and 2365 MHz, and not less than  $70 + 10 \log (P)$  dB above 2365 MHz.

(c) For operations in the 746-758 MHz band and the 776-788 MHz band, the power of any emission outside the licensee's frequency band(s) of operation shall be attenuated below the transmitter power (P) within the licensed band(s) of operation, measured in watts, in accordance with the following:

(1) On any frequency outside the 746-758 MHz band, the power of any emission shall be attenuated outside the band below the transmitter power (P) by at least  $43 + 10 \log (P)$  dB;

(2) On any frequency outside the 776-788 MHz band, the power of any emission shall be attenuated outside the band below the transmitter power (P) by at least  $43 + 10 \log (P)$  dB;

(3) On all frequencies between 763-775 MHz and 793-805 MHz, by a factor not less than  $76 + 10 \log (P)$  dB in a 6.25 kHz band segment, for base and fixed stations;

(4) On all frequencies between 763-775 MHz and 793-805 MHz, by a factor not less than  $65 + 10 \log (P)$  dB in a 6.25 kHz band segment, for mobile and portable stations;

(5) Compliance with the provisions of paragraphs (c)(1) and (c)(2) of this section is based on the use of measurement instrumentation employing a resolution bandwidth of 100 kHz or greater. However, in the 100 kHz bands immediately outside and adjacent to the frequency block, a resolution bandwidth of at least 30 kHz may be employed;

(6) Compliance with the provisions of paragraphs (c)(3) and (c)(4) of this section is based on the use of measurement instrumentation such that the reading taken with any resolution bandwidth setting should be adjusted to indicate spectral energy in a 6.25 kHz segment.

(f) For operations in the 746-758 MHz, 775-788 MHz, and 805-806 MHz bands, emissions in the band 1559-1610 MHz shall be limited to - 70 dBW/MHz equivalent isotropically radiated power (EIRP) for wideband signals, and - 80 dBW EIRP for discrete emissions of less than 700 Hz bandwidth. For the purpose of equipment authorization, a transmitter shall be tested with an antenna that is representative of the type that will be used with the equipment in normal operation.

(g) For operations in the 600 MHz band and the 698-746 MHz band, the power of any emission outside a licensee's frequency band(s) of operation shall be attenuated below the transmitter power (P) within the licensed band(s) of operation, measured in watts, by at least  $43 + 10 \log (P)$  dB. Compliance with this provision is based on the use of measurement instrumentation employing a resolution bandwidth of 100 kilohertz or greater. However, in the 100 kilohertz bands immediately outside and adjacent to a licensee's frequency block, a resolution bandwidth of at least 30 kHz may be employed.

(h) AWS emission limits

(1) **General protection levels.** Except as otherwise specified below, for operations in the 1695-1710 MHz, 1710-1755 MHz, 1755-1780 MHz, 1915-1920 MHz, 1995-2000 MHz, 2000-2020 MHz, 2110-2155 MHz, 2155-2180 MHz, and 2180-2200 bands, the power of any emission outside a licensee's frequency block shall be attenuated below the transmitter power (P) in watts by at least  $43 + 10 \log_{10} (P)$  dB.

(m)(4) For mobile digital stations, the attenuation factor shall be not less than  $40 + 10 \log (P)$  dB on all frequencies between the channel edge and 5 megahertz from the channel edge,  $43 + 10 \log (P)$  dB on all frequencies between 5 megahertz and X megahertz from the channel edge, and  $55 + 10 \log (P)$  dB on all frequencies more than X megahertz from the channel edge, where X is the greater of 6 megahertz or the actual emission bandwidth as defined in paragraph (m)(6) of this section. In addition, the attenuation factor shall not be less than  $43 + 10 \log (P)$  dB on all frequencies between 2490.5 MHz and 2496 MHz and  $55 + 10 \log (P)$  dB at or below 2490.5 MHz. Mobile Satellite Service licensees operating on frequencies below 2495 MHz may also submit a documented interference complaint against BRS licensees operating on channel BRS Channel 1 on the same terms and conditions as adjacent channel BRS or EBS licensees.

#### **4.3.3 Frequency stability**

FCC §27.54

The frequency stability shall be sufficient to ensure that the fundamental emissions stay within the authorized bands of operation.

#### 4.4 Test Method:

##### 4.4.1 Transmitter output power, e.r.p. and e.i.r.p

According to CFR Part 2.1046, ANSI C63.26-2015 Section 5.2.5.5:

The relevant equation for determining the ERP or EIRP from the conducted RF output power measured using the guidance provided above is:

$$\text{ERP or EIRP} = P_{\text{Meas}} + G_T - L_C$$

where:

ERP or EIRP = effective radiated power or equivalent isotropically radiated power, respectively  
(expressed in the same units as  $P_{\text{Meas}}$ , typically dBW or dBm);

$P_{\text{Meas}}$  = measured transmitter output power or PSD, in dBm or dBW;

$G_T$  = gain of the transmitting antenna, in dBd (ERP) or dBi (EIRP);

$L_C$  = signal attenuation in the connecting cable between the transmitter and antenna, in dB.

#### Test Setup Block:

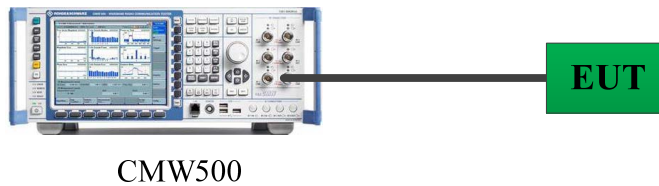

Note: The Insertion loss of the RF cable was offset into the Reading of CMW500.

#### 4.4.2 Occupied Bandwidth

According to ANSI C63.26-2015 Section 5.4.4

The OBW is the frequency bandwidth such that, below its lower and above its upper frequency limits, the mean powers are each equal to 0.5% of the total mean power of the given emission.

The following procedure shall be used for measuring (99%) power bandwidth:

- a) The spectrum analyzer center frequency is set to the nominal EUT channel center frequency. The frequency span for the spectrum analyzer shall be set wide enough to capture all modulation products including the emission skirts (typically a span of  $1.5 \times \text{OBW}$  is sufficient).
- b) The nominal IF filter 3 dB bandwidth (RBW) shall be in the range of 1% to 5% of the anticipated OBW, and the VBW shall be set  $\geq 3 \times \text{RBW}$ .
- c) Set the reference level of the instrument as required to prevent the signal amplitude from exceeding the maximum spectrum analyzer input mixer level for linear operation. See guidance provided in 4.2.3. NOTE—Step a), step b), and step c) may require iteration to adjust within the specified tolerances.
- d) Set the detection mode to peak, and the trace mode to max-hold.
- e) If the instrument does not have a 99% OBW function, recover the trace data points and sum directly in linear power terms. Place the recovered amplitude data points, beginning at the lowest frequency, in a running sum until 0.5% of the total is reached. Record that frequency as the lower OBW frequency. Repeat the process until 99.5% of the total is reached and record that frequency as the upper OBW frequency. The 99% power OBW can be determined by computing the difference these two frequencies.
- f) The OBW shall be reported and plot(s) of the measuring instrument display shall be provided with the test report. The frequency and amplitude axis and scale shall be clearly labeled. Tabular data can be reported in addition to the plot(s).

#### Test Setup Block:

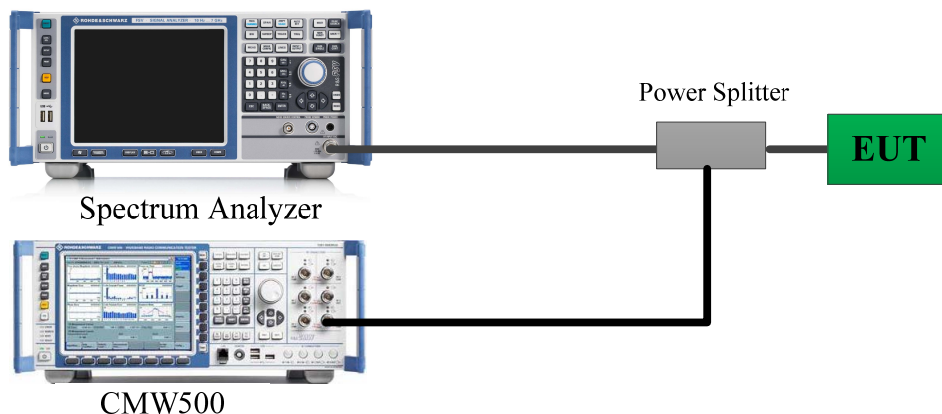

Note: The Insertion loss of the RF cable and Power Splitter was offset into the Reading of Spectrum Analyzer.

**4.4.3 Transmitter unwanted emissions-at antenna terminals**

According to ANSI C63.26-2015 Section 5.7.4:

the applicable rule part specifies the reference bandwidth for measuring unwanted emission levels (typically, 100 kHz if the authorized frequency band/block is at or below 1 GHz and 1 MHz if the authorized frequency band/block is above 1 GHz),8 effectively depicting the unwanted emission limit in terms of a power spectral density. In those cases where no reference bandwidth is explicitly specified, the values in the preceding sentence should be used.

**Test Setup Block:**

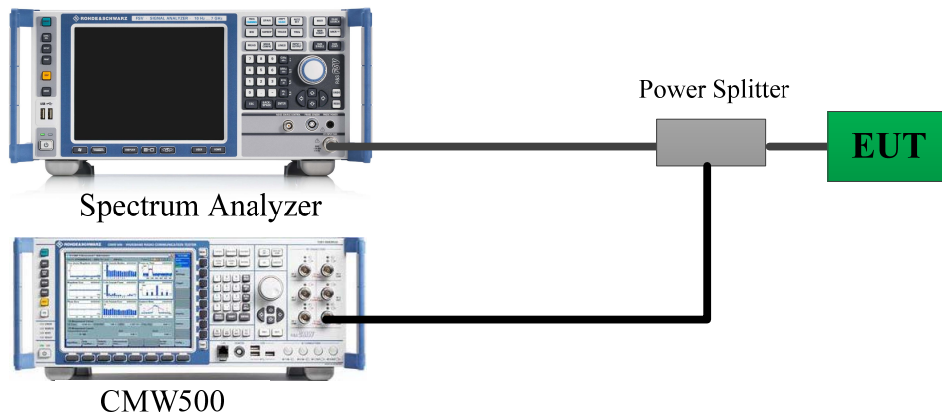

Note: The Insertion loss of the RF cable and Power Splitter was offset into the Reading of Spectrum Analyzer.

#### 4.4.4 Transmitter unwanted emissions-Out of band emission

According to ANSI C63.26-2015 Section 5.7.3:

Typically, a measurement (resolution) bandwidth smaller than the reference bandwidth is allowed for measurements within a specified frequency range at the edge of the authorized frequency block/band (e.g., within the first Y MHz outside of the authorized frequency band/block, where the value of Y is specified in the relevant rule part). Some FCC out-of-band emission rules permit the use of a narrower RBW (typically limited to a minimum RBW of 1 % of the OBW) for measuring the out-of-band emissions without a requirement to integrate the result over the full reference bandwidth. Beyond the specified frequency range in which this relaxation of the uniform reference bandwidth is permitted, it typically is also acceptable to use a narrower RBW (again limited to a minimum of 1 % of OBW) to increase accuracy, but the measurement result must subsequently be integrated over the full reference bandwidth.

##### Test Setup Block:

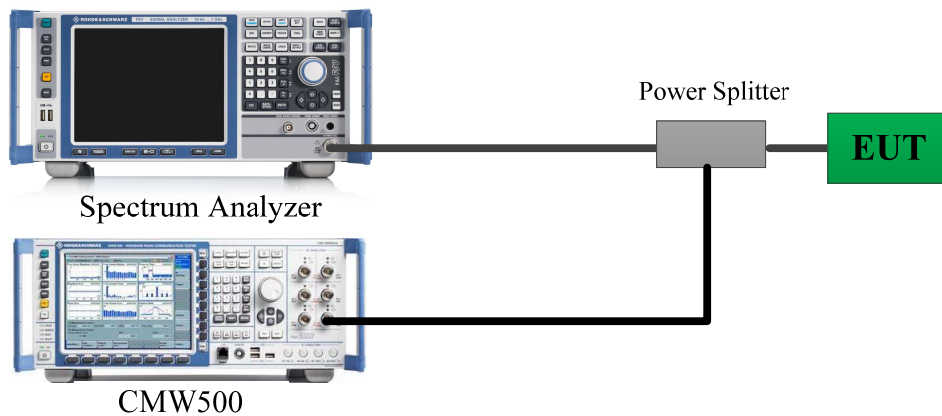

Note: The Insertion loss of the RF cable and Power Splitter was offset into the Reading of Spectrum Analyzer.

#### 4.4.5 Frequency stability

According to ANSI C63.26-2015 Section 5.6:

Frequency stability is a measure of the frequency drift due to temperature and supply voltage variations, with reference to the frequency measured at +20 °C and rated supply voltage.

The operating carrier frequency shall be set up in accordance with the manufacturer's published operation and instruction manual prior to the commencement of these tests. No adjustment of any frequency determining circuit element shall be made subsequent to this initial set-up. Frequency stability is tested:

- a) At 10 °C intervals of temperatures between -30 °C and +50 °C at the manufacturer's rated supply voltage, and
- b) At +20 °C temperature and ±15% supply voltage variations. If a product is specified to operate over a range of input voltage then the -15% variation is applied to the lowermost voltage and the +15% is applied to the uppermost voltage.

During the test all necessary settings, adjustments and control of the EUT have to be performed without disturbing the test environment, i.e., without opening the environmental chamber. The frequency stabilities can be maintained to a lesser temperature range provided that the transmitter is automatically inhibited from operating outside the lesser temperature range. For handheld equipment that is only capable of operating from internal batteries and the supply voltage cannot be varied, the frequency stability tests shall be performed at the nominal battery voltage and the battery end point voltage specified by the manufacturer. An external supply voltage can be used and set at the internal battery nominal voltage, and again at the battery operating end point voltage which shall be specified by the equipment manufacturer.

If an unmodulated carrier is not available, the mean frequency of a modulated carrier can be obtained by using a frequency counter with gating time set to an appropriately large multiple of bit periods (gating time depending on the required accuracy). Full details on the choice of values shall be included in the test report.

#### Test Setup Block:

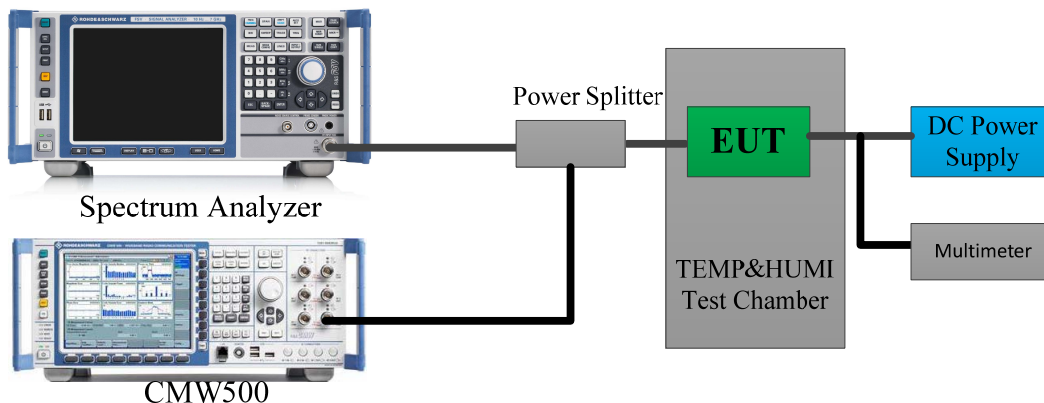



**4.4.6 Transmitter unwanted emissions- Radiated Spurious emissions**

According to ANSI C63.26-2015 Section 5.5.3:

**Test setup:**

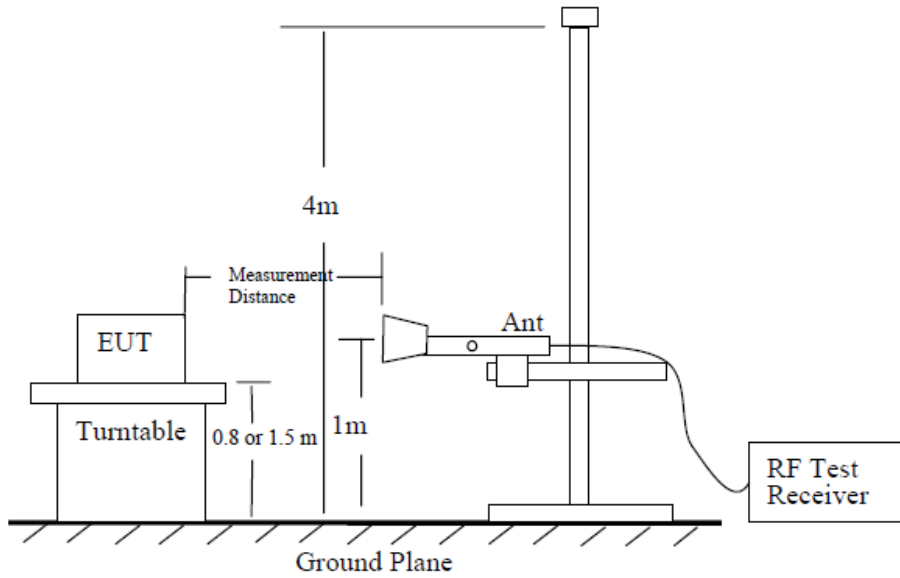

**Figure 6—Test site-up for radiated ERP and/or EIRP measurements**

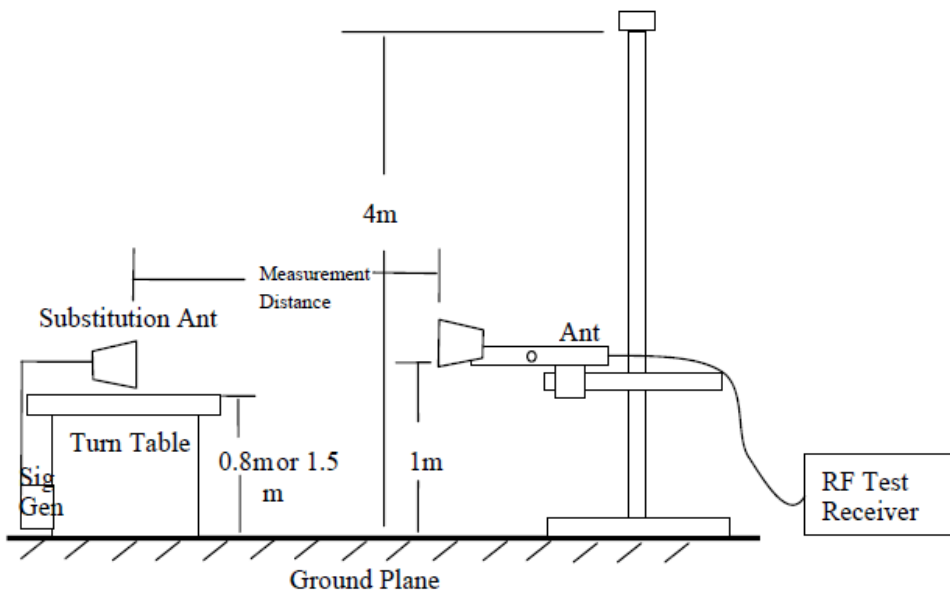

**Figure 7—Substitution method set-up for radiated emission**

**Test Procedure:**

- a) Place the EUT in the center of the turntable. The EUT shall be configured to transmit into the standard non-radiating load (for measuring radiated spurious emissions), connected with cables of minimal length unless specified otherwise. If the EUT uses an adjustable antenna, the antenna shall be positioned to the length that produces the worst case emission at the fundamental operating frequency.
- b) Each emission under consideration shall be evaluated:
  - 1) Raise and lower the measurement antenna in accordance 5.5.2, as necessary to enable detection of the maximum emission amplitude relative to measurement antenna height.
  - 2) Rotate the EUT through 360° to determine the maximum emission level relative to the axial position.
  - 3) Return the turntable to the azimuth where the highest emission amplitude level was observed.
  - 4) Vary the measurement antenna height again through 1 m to 4 m again to find the height associated with the maximum emission amplitude.
  - 5) Record the measured emission amplitude level and frequency using the appropriate RBW.
- c) Repeat step b) for each emission frequency with the measurement antenna oriented in both the horizontal and vertical polarizations to determine the orientation that gives the maximum emissions amplitude.
- d) Set-up the substitution measurement with the reference point of the substitution antenna located as near as possible to where the center of the EUT radiating element was located during the initial EUT measurement.
- e) Maintain the previous measurement instrument settings and test set-up, with the exception that the EUT is removed and replaced by the substitution antenna.
- f) Connect a signal generator to the substitution antenna; locate the signal generator so as to minimize any potential influences on the measurement results. Set the signal generator to the frequency where emissions are detected, and set an output power level such that the radiated signal can be detected by the measurement instrument, with sufficient dynamic range relative to the noise floor.
- g) For each emission that was detected and measured in the initial test [i.e., in step b) and step c)]:
  - 1) Vary the measurement antenna height between 1 m to 4 m to maximize the received (measured) signal amplitude.
  - 2) Adjust the signal generator output power level until the amplitude detected by the measurement instrument equals the amplitude level of the emission previously measured directly in step b) and step c).
  - 3) Record the output power level of the signal generator when equivalence is achieved in step 2).
- h) Repeat step e) through step g) with the measurement antenna oriented in the opposite polarization.
- i) Calculate the emission power in dBm referenced to a half-wave dipole using the following equation:
$$P_e = P_s(\text{dBm}) - \text{cable loss (dB)} + \text{antenna gain (dBd)}$$
where
  - $P_e$  = equivalent emission power in dBm
  - $P_s$  = source (signal generator) power in dBmNOTE—dBd refers to the measured antenna gain in decibels relative to a half-wave dipole.
- j) Correct the antenna gain of the substitution antenna if necessary to reference the emission power to a half-wave dipole. When using measurement antennas with the gain specified in dBi, the equivalent dipole-referenced gain can be determined from:  $\text{gain (dBd)} = \text{gain (dBi)} - 2.15 \text{ dB}$ . If necessary, the antenna gain can be calculated from calibrated antenna factor information
- k) Provide the complete measurement results as a part of the test report.

## **5. Test DATA AND RESULTS**

---

### **5.1 Antenna Port Test Data and Results:**

Please refer to the attachment Appendix A, B and C.

**5.2 Radiated Spurious Emissions**

Serial Number:	2N1N-4	Test Date:	Below 1GHz: 2024/6/20 Above 1GHz: 2024/7/5
Test Site:	Chamber 10m, Chamber B	Test Mode:	Transmitting
Tester:	Leesin Xiang, Leo Xiao, Colin Yang	Test Result:	Pass

**Environmental Conditions:**

Temperature: (°C)	27.1	Relative Humidity: (%)	43~56	ATM Pressure: (kPa)	100.2~100.6
----------------------	------	---------------------------	-------	---------------------------	-------------

**Test Equipment List and Details:**

Manufacturer	Description	Model	Serial Number	Calibration Date	Calibration Due Date
30MHz~1000MHz					
Sunol Sciences	Hybrid Antenna	JB3	A060611-1	2023/9/6	2026/9/5
Narda	Coaxial Attenuator	779-6dB	04269	2023/9/6	2026/9/5
Unknown	Coaxial Cable	C-NJNJ-50	C-1000-01	2023/8/1	2024/7/31
Unknown	Coaxial Cable	C-NJNJ-50	C-0400-04	2023/8/1	2024/7/31
Unknown	Coaxial Cable	C-NJNJ-50	C-0530-01	2023/8/1	2024/7/31
Sonoma	Amplifier	310N	185914	2023/8/1	2024/7/31
R&S	EMI Test Receiver	ESCI	100224	2023/8/18	2024/8/17
EMCO	Adjustable Dipole Antenna	3121C	9109-753	N/A	N/A
Micro-Coax	Coaxial Cable	UFA210B	99G1448	2023/9/9	2024/9/8
Agilent	Signal Generator	E8247C	MY43321350	2023/10/18	2024/10/17
Sinoscite	Band Rejection Filter	BSF824-862MS	1438001	2024/6/7	2025/6/6

Manufacturer	Description	Model	Serial Number	Calibration Date	Calibration Due Date
Above 1GHz					
ETS-Lindgren	Horn Antenna	3115	000 527 35	2023/9/7	2026/9/6
AH	Horn Antenna	SAS-571	1177	2023/2/22	2026/2/21
Ducommun Technologies	Horn Antenna	ARH-4223-02	1007726-02 1304	2023/2/22	2026/2/21
Ducommun Technologies	Horn Antenna	ARH-4223-02	1007726-03 1304	2023/2/22	2026/2/21
Ducommun Technologies	Horn Antenna	ARH-2823-02	1007726-01 1302	2023/2/22	2026/2/21
Ducommun Technologies	Horn Antenna	ARH-2823-02	1007726-02 1302	2023/2/22	2026/2/21
Xinhang Macrowave	Coaxial Cable	XH750A-N/J-SMA/J-10M	20231117004 #0001	2023/11/17	2024/11/16
Micro-Coax	Coaxial Cable	UFA210B	99G1448	2023/9/9	2024/9/8
Agilent	Signal Generator	E8247C	MY43321350	2023/10/18	2024/10/17
AH	Preamplifier	PAM-0118P	469	2023/8/19	2024/8/18
AH	Preamplifier	PAM-1840VH	191	2023/9/7	2024/9/6
R&S	Spectrum Analyzer	FSV40	101944	2023/10/18	2024/10/17
R&S	Wideband Radio Communication Tester	CMW500	147473	2023/10/18	2024/10/17
Mini-Circuits	High Pass Filter	VHF-1200+	31102	2023/8/1	2024/7/31
Mini-Circuits	High Pass Filter	VHF-2700A+	31222	2024/6/4	2025/6/4
Sinoscite	Band Rejection Filter	BSF1850-1910MS	0935V2001	2024/6/11	2025/6/10
Sinoscite	Band Rejection Filter	BSF2500-2750MS	1439001	2024/6/7	2025/6/6

\* Statement of Traceability: Bay Area Compliance Laboratories Corp. (Dongguan) attests that all calibrations have been performed, traceable to National Primary Standards and International System of Units (SI).

**Test Data:**

After pre-scan in the X, Y and Z axes of orientation, the worst case is below:

**Cellular Band (30MHz-10GHz)**

Frequency (MHz)	Polar (H/V)	Receiver Reading (dBµV)	Substituted Method			Absolute Level (dBm)	Limit (dBm)	Margin (dB)
			Substituted Level (dBm)	Antenna Gain (dBd/dBi)	Cable Loss (dB)			
GSM 850 Frequency:824.2MHz								
181.32	H	52.80	-58.35	0.00	0.24	-58.59	-13.00	45.59
49.40	V	54.37	-40.44	-15.49	0.19	-56.12	-13.00	43.12
1648.40	H	62.41	-62.72	10.44	0.71	-52.99	-13.00	39.99
1648.40	V	56.97	-68.76	10.44	0.71	-59.03	-13.00	46.03
2472.60	H	76.05	-46.73	12.88	1.25	-35.10	-13.00	22.10
2472.60	V	69.72	-53.11	12.88	1.25	-41.48	-13.00	28.48
3296.80	H	51.33	-68.06	13.60	1.59	-56.05	-13.00	43.05
3296.80	V	53.69	-65.70	13.60	1.59	-53.69	-13.00	40.69
GSM 850 Frequency:836.6MHz								
182.47	H	53.27	-57.83	0.00	0.23	-58.06	-13.00	45.06
50.54	V	52.89	-42.81	-14.65	0.19	-57.65	-13.00	44.65
1673.20	H	58.39	-66.36	10.61	0.73	-56.48	-13.00	43.48
1673.20	V	55.10	-70.25	10.61	0.73	-60.37	-13.00	47.37
2509.80	H	65.43	-57.45	13.11	1.25	-45.59	-13.00	32.59
2509.80	V	63.79	-59.11	13.11	1.25	-47.25	-13.00	34.25
3346.40	H	48.33	-70.88	13.83	1.61	-58.66	-13.00	45.66
3346.40	V	49.59	-69.67	13.83	1.61	-57.45	-13.00	44.45
GSM 850 Frequency:848.8MHz								
181.52	H	54.50	-56.64	0.00	0.24	-56.88	-13.00	43.88
76.80	V	53.11	-52.41	-1.60	0.18	-54.19	-13.00	41.19
1697.60	H	56.66	-67.71	10.78	0.75	-57.68	-13.00	44.68
1697.60	V	55.53	-69.44	10.78	0.75	-59.41	-13.00	46.41
2546.40	H	62.14	-60.73	13.15	1.27	-48.85	-13.00	35.85
2546.40	V	60.20	-62.81	13.15	1.27	-50.93	-13.00	37.93
3395.20	H	48.32	-70.67	14.08	1.64	-58.23	-13.00	45.23
3395.20	V	50.42	-68.67	14.08	1.64	-56.23	-13.00	43.23

**PCS Band (30MHz-20GHz)**

Frequency (MHz)	Polar (H/V)	Receiver Reading (dBµV)	Substituted Method			Absolute Level (dBm)	Limit (dBm)	Margin (dB)
			Substituted Level (dBm)	Antenna Gain (dBd/dBi)	Cable Loss (dB)			
GSM 1900 Frequency:1850.2MHz								
183.26	H	52.74	-58.32	0.00	0.23	-58.55	-13.00	45.55
75.80	V	52.57	-53.10	-2.10	0.18	-55.38	-13.00	42.38
3700.40	H	50.31	-68.26	14.00	1.83	-56.09	-13.00	43.09
3700.40	V	54.47	-64.08	14.00	1.83	-51.91	-13.00	38.91
5550.60	H	55.24	-58.87	13.95	1.27	-46.19	-13.00	33.19
5550.60	V	54.49	-59.47	13.95	1.27	-46.79	-13.00	33.79
GSM 1900 Frequency:1880MHz								
182.40	H	53.68	-57.42	0.00	0.23	-57.65	-13.00	44.65
76.24	V	51.67	-53.93	-1.88	0.18	-55.99	-13.00	42.99
3760.00	H	49.91	-67.93	13.76	1.63	-55.80	-13.00	42.80
3760.00	V	52.78	-64.93	13.76	1.63	-52.80	-13.00	39.80
5640.00	H	57.88	-55.84	14.02	1.31	-43.13	-13.00	30.13
5640.00	V	58.30	-55.31	14.02	1.31	-42.60	-13.00	29.60
GSM 1900 Frequency:1909.8MHz								
181.85	H	54.08	-57.05	0.00	0.23	-57.28	-13.00	44.28
76.57	V	52.30	-53.25	-1.72	0.18	-55.15	-13.00	42.15
3819.60	H	47.51	-69.76	13.56	1.50	-57.70	-13.00	44.70
3819.60	V	52.63	-64.45	13.56	1.50	-52.39	-13.00	39.39
5729.40	H	58.69	-55.33	13.96	1.31	-42.68	-13.00	29.68
5729.40	V	59.21	-54.78	13.96	1.31	-42.13	-13.00	29.13

**WCDMA Band 5(30MHz-10GHz):**

Frequency (MHz)	Polar (H/V)	Receiver Reading (dBµV)	Substituted Method			Absolute Level (dBm)	Limit (dBm)	Margin (dB)
			Substituted Level (dBm)	Antenna Gain (dBd/dBi)	Cable Loss (dB)			
WCDMA Band 5 Frequency:826.4 MHz								
183.22	H	52.15	-58.91	0.00	0.23	-59.14	-13.00	46.14
49.40	V	53.04	-41.77	-15.49	0.19	-57.45	-13.00	44.45
1652.80	H	58.72	-66.34	10.47	0.72	-56.59	-13.00	43.59
1652.80	V	55.37	-70.29	10.47	0.72	-60.54	-13.00	47.54
2479.20	H	63.59	-59.21	12.93	1.25	-47.53	-13.00	34.53
2479.20	V	60.55	-62.29	12.93	1.25	-50.61	-13.00	37.61
3305.60	H	50.36	-69.03	13.63	1.59	-56.99	-13.00	43.99
3305.60	V	52.41	-66.99	13.63	1.59	-54.95	-13.00	41.95
WCDMA Band 5 Frequency:836.6MHz								
183.41	H	53.10	-57.95	0.00	0.23	-58.18	-13.00	45.18
76.28	V	52.77	-52.83	-1.86	0.18	-54.87	-13.00	41.87
1673.20	H	56.70	-68.05	10.61	0.73	-58.17	-13.00	45.17
1673.20	V	55.35	-70.00	10.61	0.73	-60.12	-13.00	47.12
2509.80	H	63.58	-59.30	13.11	1.25	-47.44	-13.00	34.44
2509.80	V	62.42	-60.48	13.11	1.25	-48.62	-13.00	35.62
3346.40	H	50.53	-68.68	13.83	1.61	-56.46	-13.00	43.46
3346.40	V	51.74	-67.52	13.83	1.61	-55.30	-13.00	42.30
WCDMA Band 5 Frequency:846.6MHz								
181.52	H	52.28	-58.86	0.00	0.24	-59.10	-13.00	46.10
49.48	V	51.67	-43.18	-15.41	0.19	-58.78	-13.00	45.78
1693.20	H	56.55	-67.89	10.75	0.75	-57.89	-13.00	44.89
1693.20	V	55.48	-69.56	10.75	0.75	-59.56	-13.00	46.56
2539.80	H	65.20	-57.67	13.14	1.27	-45.80	-13.00	32.80
2539.80	V	63.72	-59.27	13.14	1.27	-47.40	-13.00	34.40
3386.40	H	51.62	-67.41	14.03	1.63	-55.01	-13.00	42.01
3386.40	V	52.47	-66.65	14.03	1.63	-54.25	-13.00	41.25



**LTE Bands:**

(The Worst modulation and bandwidth was below)

**LTE Band 5(30MHz-10GHz):**

Frequency (MHz)	Polar (H/V)	Receiver Reading (dBµV)	Substituted Method			Absolute Level (dBm)	Limit (dBm)	Margin (dB)
			Substituted Level (dBm)	Antenna Gain (dBd/dBi)	Cable Loss (dB)			
1RB, 1.4MHz, QPSK, Frequency: 824.7 MHz								
185.20	H	55.97	-54.99	0.00	0.22	-55.21	-13.00	42.21
76.56	V	50.89	-54.66	-1.72	0.18	-56.56	-13.00	43.56
1649.40	H	60.17	-64.94	10.45	0.71	-55.20	-13.00	42.20
1649.40	V	55.18	-70.53	10.45	0.71	-60.79	-13.00	47.79
2474.10	H	65.93	-56.85	12.89	1.25	-45.21	-13.00	32.21
2474.10	V	56.22	-66.61	12.89	1.25	-54.97	-13.00	41.97
3298.80	H	47.85	-71.56	13.60	1.59	-59.55	-13.00	46.55
3298.80	V	48.06	-71.35	13.60	1.59	-59.34	-13.00	46.34
1RB, 1.4MHz, QPSK, Frequency: 836.5 MHz								
185.41	H	54.37	-56.58	0.00	0.22	-56.80	-13.00	43.80
76.33	V	51.00	-54.59	-1.84	0.18	-56.61	-13.00	43.61
1673.00	H	63.19	-61.56	10.61	0.73	-51.68	-13.00	38.68
1673.00	V	55.45	-69.90	10.61	0.73	-60.02	-13.00	47.02
2509.50	H	65.65	-57.23	13.11	1.25	-45.37	-13.00	32.37
2509.50	V	56.66	-66.24	13.11	1.25	-54.38	-13.00	41.38
3346.00	H	48.43	-70.78	13.83	1.61	-58.56	-13.00	45.56
3346.00	V	48.62	-70.64	13.83	1.61	-58.42	-13.00	45.42
1RB, 1.4MHz, QPSK, Frequency: 848.3 MHz								
184.20	H	54.61	-56.40	0.00	0.23	-56.63	-13.00	43.63
76.11	V	50.22	-55.40	-1.95	0.18	-57.53	-13.00	44.53
1696.60	H	64.79	-59.59	10.78	0.75	-49.56	-13.00	36.56
1696.60	V	57.87	-67.11	10.78	0.75	-57.08	-13.00	44.08
2544.90	H	69.87	-53.00	13.14	1.27	-41.13	-13.00	28.13
2544.90	V	56.92	-66.09	13.14	1.27	-54.22	-13.00	41.22
3393.20	H	48.52	-70.48	14.07	1.64	-58.05	-13.00	45.05
3393.20	V	48.19	-70.90	14.07	1.64	-58.47	-13.00	45.47

**LTE Band 7(30MHz-26GHz):**

Frequency (MHz)	Polar (H/V)	Receiver Reading (dBμV)	Substituted Method			Absolute Level (dBm)	Limit (dBm)	Margin (dB)
			Substituted Level (dBm)	Antenna Gain (dBd/dBi)	Cable Loss (dB)			
1RB, 5MHz, QPSK, Frequency: 2502.5 MHz								
179.38	H	55.54	-55.67	0.00	0.24	-55.91	-25.00	30.91
76.56	V	47.24	-58.31	-1.72	0.18	-60.21	-25.00	35.21
5005.00	H	53.75	-63.90	14.00	1.43	-51.33	-25.00	26.33
5005.00	V	50.03	-67.38	14.00	1.43	-54.81	-25.00	29.81
7507.50	H	48.13	-61.00	13.20	1.33	-49.13	-25.00	24.13
7507.50	V	48.44	-61.17	13.20	1.33	-49.30	-25.00	24.30
1RB, 5MHz, QPSK, Frequency: 2535 MHz								
183.26	H	53.40	-57.66	0.00	0.23	-57.89	-25.00	32.89
74.35	V	48.24	-57.65	-2.83	0.18	-60.66	-25.00	35.66
5070.00	H	56.08	-60.83	13.93	1.34	-48.24	-25.00	23.24
5070.00	V	49.87	-66.85	13.93	1.34	-54.26	-25.00	29.26
7605.00	H	48.32	-61.09	13.21	1.40	-49.28	-25.00	24.28
7605.00	V	48.08	-61.73	13.21	1.40	-49.92	-25.00	24.92
1RB, 5MHz, QPSK, Frequency: 2567.5 MHz								
183.40	H	53.72	-57.33	0.00	0.23	-57.56	-25.00	32.56
75.40	V	49.87	-55.86	-2.30	0.18	-58.34	-25.00	33.34
5135.00	H	65.78	-50.72	13.94	1.38	-38.16	-25.00	13.16
5135.00	V	50.14	-66.28	13.94	1.38	-53.72	-25.00	28.72
7702.50	H	54.18	-55.51	13.40	1.47	-43.58	-25.00	18.58
7702.50	V	48.35	-61.66	13.40	1.47	-49.73	-25.00	24.73

**LTE Band 38(30MHz-26.5GHz):**

Frequency (MHz)	Polar (H/V)	Receiver Reading (dBμV)	Substituted Method			Absolute Level (dBm)	Limit (dBm)	Margin (dB)
			Substituted Level (dBm)	Antenna Gain (dBd/dBi)	Cable Loss (dB)			
1RB, 5MHz,QPSK, Frequency: 2572.5 MHz								
179.48	H	56.24	-54.97	0.00	0.24	-55.21	-25.00	30.21
74.88	V	47.76	-58.05	-2.56	0.18	-60.79	-25.00	35.79
5145.00	H	61.70	-54.78	13.95	1.40	-42.23	-25.00	17.23
5145.00	V	50.37	-66.05	13.95	1.40	-53.50	-25.00	28.50
7717.50	H	53.48	-56.25	13.38	1.48	-44.35	-25.00	19.35
7717.50	V	48.06	-61.98	13.38	1.48	-50.08	-25.00	25.08
1RB, 5MHz,QPSK, Frequency:2595 MHz								
173.56	H	55.02	-56.06	0.00	0.24	-56.30	-25.00	31.30
78.50	V	47.69	-57.57	-0.75	0.18	-58.50	-25.00	33.50
5190.00	H	67.91	-48.47	13.99	1.51	-35.99	-25.00	10.99
5190.00	V	51.72	-64.72	13.99	1.51	-52.24	-25.00	27.24
7785.00	H	55.65	-54.28	13.32	1.53	-42.49	-25.00	17.49
7785.00	V	48.36	-61.82	13.32	1.53	-50.03	-25.00	25.03
1RB, 5MHz,QPSK, Frequency: 2617.5 MHz								
175.47	H	54.58	-56.54	0.00	0.24	-56.78	-25.00	31.78
78.58	V	48.68	-56.57	-0.71	0.18	-57.46	-25.00	32.46
5235.00	H	67.78	-48.81	14.11	1.40	-36.10	-25.00	11.10
5235.00	V	50.90	-65.77	14.11	1.40	-53.06	-25.00	28.06
7852.50	H	60.29	-49.83	13.25	1.58	-38.16	-25.00	13.16
7852.50	V	48.35	-61.97	13.25	1.58	-50.30	-25.00	25.30

**LTE Band 41(30MHz-27GHz):**

Frequency (MHz)	Polar (H/V)	Receiver Reading (dBµV)	Substituted Method			Absolute Level (dBm)	Limit (dBm)	Margin (dB)
			Substituted Level (dBm)	Antenna Gain (dBd/dBi)	Cable Loss (dB)			
1RB, 5MHz,QPSK, Frequency: 2537.5 MHz								
185.20	H	55.41	-55.55	0.00	0.22	-55.77	-25.00	30.77
76.75	V	48.96	-56.56	-1.63	0.18	-58.37	-25.00	33.37
5075.00	H	48.28	-68.58	13.93	1.34	-55.99	-25.00	30.99
5075.00	V	46.59	-70.08	13.93	1.34	-57.49	-25.00	32.49
7612.50	H	47.35	-62.08	13.23	1.40	-50.25	-25.00	25.25
7612.50	V	46.86	-62.97	13.23	1.40	-51.14	-25.00	26.14
1RB, 5MHz,QPSK, Frequency:2595 MHz								
180.38	H	54.54	-56.66	0.00	0.24	-56.90	-25.00	31.90
76.52	V	55.66	-49.90	-1.74	0.18	-51.82	-25.00	26.82
5190.00	H	47.23	-69.15	13.99	1.51	-56.67	-25.00	31.67
5190.00	V	46.77	-69.67	13.99	1.51	-57.19	-25.00	32.19
7785.00	H	47.18	-62.75	13.32	1.53	-50.96	-25.00	25.96
7785.00	V	46.61	-63.57	13.32	1.53	-51.78	-25.00	26.78
1RB, 5MHz,QPSK, Frequency: 2652.5 MHz								
183.50	H	54.21	-56.84	0.00	0.23	-57.07	-25.00	32.07
76.56	V	50.35	-55.20	-1.72	0.18	-57.10	-25.00	32.10
5305.00	H	47.35	-69.49	14.29	1.17	-56.37	-25.00	31.37
5305.00	V	47.19	-69.73	14.29	1.17	-56.61	-25.00	31.61
7957.50	H	46.83	-63.60	13.32	1.66	-51.94	-25.00	26.94
7957.50	V	46.91	-63.62	13.32	1.66	-51.96	-25.00	26.96

Note:

- 1) The unit of Antenna Gain is dBd for frequency below 1GHz, and the unit of Antenna Gain is dBi for frequency above 1GHz.
- 2) Absolute Level = Substituted Level - Cable loss + Antenna Gain
- 3) Margin = Limit-Absolute Level

## **EXHIBIT A - EUT PHOTOGRAPHS**

---

Please refer to the attachment 2402U81179E-RF-EXP EUT EXTERNAL PHOTOGRAPHS and 2402U81179E-RF-INP EUT INTERNAL PHOTOGRAPHS

## **EXHIBIT B - TEST SETUP PHOTOGRAPHS**

---

Please refer to the attachment 2402U81179E-RF-00E-TSP TEST SETUP PHOTOGRAPHS.

**\*\*\*\*\* END OF REPORT \*\*\*\*\***