



FCC PART 27  
FCC PART 22H, PART 24E  
TEST REPORT

For

**TECNO MOBILE LIMITED**

FLAT 39 8/F BLOCK D WAH LOK INDUSTRIAL CENTRE 31-35 SHAN MEI STREET  
FOTAN NT Hong Kong

**FCC ID: 2ADYY-PR651**

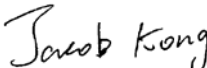
<b>Report Type:</b> Original Report	<b>Product Type:</b> 4G smart phone
<b>Report Number:</b> SZ1210422-13136E-00C	
<b>Report Date:</b> 2021-06-08	
Jacob Kong 	
<b>Reviewed By:</b> RF Engineer	
<b>Prepared By:</b> Bay Area Compliance Laboratories Corp. (Shenzhen) 5F(B-West) ,6F,7F,the 3rd Phase of Wan Li Industrial Building D,Shihua Rd, FuTian Free Trade Zone, Shenzhen, China Tel: +86-755-33320018 Fax: +86-755-33320008 <a href="http://www.baclcorp.com.cn">www.baclcorp.com.cn</a>	

**Note:** This report may contain data that are not covered by the A2LA accreditation and are marked with an asterisk “★”.

BACL is not responsible for the authenticity of any test data provided by the applicant. Data included from the applicant that may affect test results are marked with an asterisk ‘\*’. Customer model name, addresses, names, trademarks etc. are not considered data.

This report cannot be reproduced except in full, without prior written approval of the Company. Unless otherwise stated the results shown in this test report refer only to the sample(s) tested. This report is valid only with a valid digital signature. The digital signature may be available only under the Adobe software above version 7.0.

## TABLE OF CONTENTS

<b>GENERAL INFORMATION.....</b>	<b>3</b>
PRODUCT DESCRIPTION FOR EQUIPMENT UNDER TEST (EUT).....	3
OBJECTIVE.....	3
TEST METHODOLOGY.....	4
MEASUREMENT UNCERTAINTY.....	4
TEST FACILITY.....	4
<b>SYSTEM TEST CONFIGURATION.....</b>	<b>5</b>
DESCRIPTION OF TEST CONFIGURATION.....	5
EQUIPMENT MODIFICATIONS.....	6
SUPPORT EQUIPMENT LIST AND DETAILS.....	6
SUPPORT CABLE DESCRIPTION.....	6
BLOCK DIAGRAM OF TEST SETUP.....	7
<b>SUMMARY OF TEST RESULTS.....</b>	<b>8</b>
<b>TEST EQUIPMENT LIST.....</b>	<b>9</b>
<b>FCC §1.1307(B) &amp; §2.1093 - RF EXPOSURE INFORMATION.....</b>	<b>11</b>
APPLICABLE STANDARD.....	11
TEST RESULT.....	11
<b>FCC §2.1047 - MODULATION CHARACTERISTIC.....</b>	<b>12</b>
<b>FCC § 2.1046, § 22.913 (A) &amp; § 24.232 (C); §27.50 (C) (D) (H) - RF OUTPUT POWER.....</b>	<b>13</b>
APPLICABLE STANDARD.....	13
TEST PROCEDURE.....	13
TEST DATA.....	13
<b>FCC §2.1049, §22.917, §22.905 &amp; §24.238 &amp; §27.53 - OCCUPIED BANDWIDTH.....</b>	<b>45</b>
APPLICABLE STANDARD.....	45
TEST PROCEDURE.....	45
TEST DATA.....	45
<b>FCC §2.1051, §22.917(A) &amp; §24.238(A); §27.53 - SPURIOUS EMISSIONS AT ANTENNA TERMINALS.....</b>	<b>76</b>
APPLICABLE STANDARD.....	76
TEST PROCEDURE.....	76
TEST DATA.....	76
<b>FCC § 2.1053; § 22.917 (A);§ 24.238 (A); §27.53 SPURIOUS RADIATED EMISSIONS.....</b>	<b>94</b>
APPLICABLE STANDARD.....	94
TEST PROCEDURE.....	94
TEST DATA.....	94
<b>FCC § 22.917 (A);§ 24.238 (A); §27.53(C) (H)(M) - BAND EDGES.....</b>	<b>105</b>
APPLICABLE STANDARD.....	105
TEST PROCEDURE.....	105
TEST DATA.....	105
<b>FCC § 2.1055; § 22.355; § 24.235; §27.54 - FREQUENCY STABILITY.....</b>	<b>119</b>
APPLICABLE STANDARD.....	119
TEST PROCEDURE.....	119
TEST DATA.....	120

## GENERAL INFORMATION

### Product Description for Equipment under Test (EUT)

Product	4G smart phone
Tested Model	PR651
Frequency Range	EGSM 850: 824-849MHz(TX); 869-894MHz(RX) PCS 1900: 1850-1910MHz(TX); 1930-1990MHz(RX) WCDMA Band 2: 1850-1910MHz(TX); 1930-1990MHz(RX) WCDMA Band 4: 1710-1755MHz(TX); 2110-2155MHz(RX) WCDMA Band 5: 824-849MHz(TX); 869-894MHz(RX) LTE Band 2: 1850-1910MHz(TX); 1930-1990MHz(RX) LTE Band 4: 1710-1755MHz(TX); 2110-2155MHz(RX) LTE Band 5: 824-849MHz(TX); 869-894MHz(RX) LTE Band 7: 2500-2570MHz(TX); 2620-2690MHz(RX) LTE Band 17: 704-716MHz(TX); 734-746MHz(RX) LTE Band 38: 2570-2620MHz(TX/RX) LTE Band 41: 2535-2655MHz(TX/RX) LTE Band 66: 1710-1780MHz(TX); 2110-2180MHz(RX)
Modulation Technique	2G: GMSK, 8PSK 3G: BPSK, QPSK, 16QAM 4G: QPSK, 16QAM
Antenna Specification*	EGSM850/WCDMA Band 5/LTE Band 5: -1.6dBi PCS1900/WCDMA Band 2: -0.7dBi WCDMA Band 2/Band 4/ LTE Band 2/ Band 4/ Band 66: -0.7dBi LTE Band 7/Band 38/Band 41: -0.4dBi LTE Band 17: -1.6dBi (provided by the applicant)
Voltage Range	DC 3.87V from battery or DC 5.0V from adapter
Date of Test	2021-04-29 to 2021-06-06
Sample serial number	SZ1210422-13136E-RF-S_3F9 (Assigned by BA CL, Shenzhen)
Received date	2021-04-22
Sample/EUT Status	Good condition
Adapter information	Model: U100TSA Input: AC 100-240V~50/60Hz, 0.3A Output: DC 5.0V, 2.0A

### Objective

This test report is in accordance with Part 2-Subpart J, Part 22-Subpart H and Part 24-Subpart E and Subpart 27 of the Federal Communication Commissions rules.

The objective is to determine the compliance of the EUT with FCC rules for output power, modulation characteristic, occupied bandwidth, and spurious emission at antenna terminal, spurious radiated emission, frequency stability and band edge.

## Test Methodology

All tests and measurements indicated in this document were performed in accordance with the Code of Federal Regulations Title 47 Part 2-Subpart J as well as the following parts:

Part 22 Subpart H - Public Mobile Services  
 Part 24 Subpart E - Personal Communication Services  
 Part 27 – Miscellaneous wireless communications services

ANSI C63.26-2015: American National Standard for Compliance Testing of Transmitters Used in Licensed Radio Services

All emissions measurement was performed at Bay Area Compliance Laboratories Corp. (Shenzhen). The radiated testing was performed at an antenna-to-EUT distance of 3 meters. Each test item follows test standards and with no deviation.

## Measurement Uncertainty

Parameter		Uncertainty
Occupied Channel Bandwidth		±5%
RF output power, conducted		±0.73dB
Unwanted Emission, conducted		±1.6dB
Emissions, Radiated	Below 1GHz	±4.75dB
	Above 1GHz	±4.88dB
Temperature		±1°C
Humidity		±6%
Supply voltages		±0.4%

*Note: The extended uncertainty given in this report is obtained by combining the standard uncertainty times the coverage factor K with the 95% confidence interval. Otherwise required by the applicant or Product Regulations, Decision Rule in this report did not consider the uncertainty.*

## Test Facility

The Test site used by Bay Area Compliance Laboratories Corp. (Shenzhen) to collect test data is located on the 5F(B-West) ,6F,7F,the 3rd Phase of Wan Li Industrial Building D,Shihua Rd, FuTian Free Trade Zone, Shenzhen, China.

The test site has been approved by the FCC under the KDB 974614 D01 and is listed in the FCC Public Access Link (PAL) database, FCC Registration No.: 342867, the FCC Designation No.: CN1221.

The test site has been registered with ISED Canada under ISED Canada Registration Number 3062B.

## SYSTEM TEST CONFIGURATION

### Description of Test Configuration

The final qualification test was performed with the EUT operating at normal mode.

Test was performed as below table:

Frequency band	Bandwidth (MHz)	Test Frequency(MHz)		
		Low	Middle	High
EGSM850	0.25	824.2	836.6	848.8
DCS1900	0.25	1850.2	1880	1909.8
WCDMA B2	4.2	1852.4	1880	1907.6
WCDMA B4	4.2	1712.4	1732.6	1752.6
WCDMA B5	4.2	826.4	836.6	846.6
LTE B2	1.4	1850.7	1880	1909.3
	3	1851.5	1880	1908.5
	5	1852.5	1880	1907.5
	10	1855	1880	1905
	15	1857.5	1880	1902.5
	20	1860	1880	1900
LTE B4	1.4	1710.7	1732.5	1754.3
	3	1711.5	1732.5	1753.5
	5	1712.5	1732.5	1752.5
	10	1715	1732.5	1750
	15	1717.5	1732.5	1747.5
	20	1720	1732.5	1745
LTE B5	1.4	824.7	836.5	848.3
	3	825.5	836.5	847.5
	5	826.5	836.5	846.5
	10	829	836.5	844
LTE B7	5	2502.5	2535	2567.5
	10	2505	2535	2565
	15	2507.5	2535	2562.5
	20	2510	2535	2560
LTE B17	5	706.5	710	713.5
	10	709	710	711
LTE B38	5	2572.5	2595	2617.5
	10	2575	2595	2615
	15	2577.5	2595	2612.5
	20	2580	2595	2610

Frequency band	Bandwidth (MHz)	Test Frequency(MHz)		
		Low	Middle	High
LTE B41	5	2537.5	2593	2652.5
	10	2540	2593	2650
	15	2542.5	2593	2647.5
	20	2545	2593	2645
LTE B66	1.4	1710.7	1745	1779.3
	3	1711.5	1745	1778.5
	5	1712.5	1745	1777.5
	10	1715	1745	1775
	15	1717.5	1745	1772.5
	20	1720	1745	1770

**Equipment Modifications**

No modification was made to the EUT.

**Support Equipment List and Details**

Manufacturer	Description	Model	Serial Number
Rohde & Schwarz	Universal Radio Communication Tester	CMU200	110605
Rohde & Schwarz	Wideband Radio Communication Tester	CMW500	1201.002K50-146520-wh

**Support Cable Description**

Cable Description	Length (m)	From / Port	To
Unshielded Un-detachable AC cable	1.2	AC Power	CMU200

**Block Diagram of Test Setup**

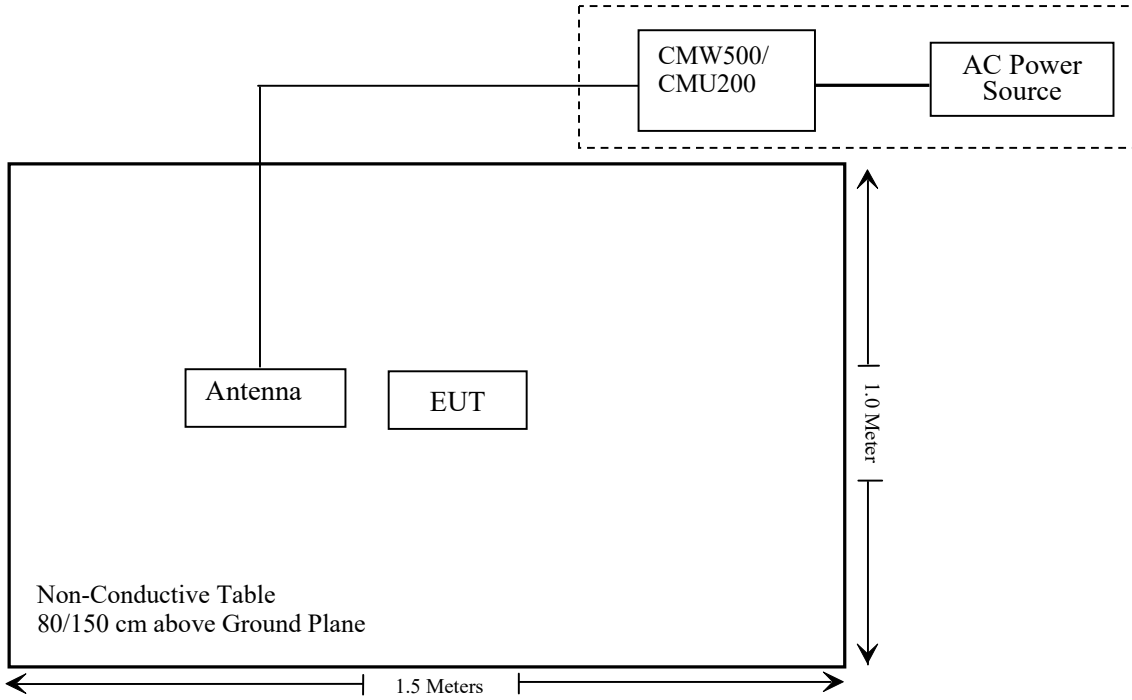

**SUMMARY OF TEST RESULTS**

<b>FCC Rules</b>	<b>Description of Test</b>	<b>Result</b>
§ 1.1307 , §2.1093	RF Exposure (SAR)	Compliant*
§2.1046; § 22.913 (a); § 24.232 (c); §27.50 (c) (d) (h)	RF Output Power	Compliant
§ 2.1047	Modulation Characteristics	Not Applicable
§ 2.1049; § 22.905; § 22.917; § 24.238; §27.53	Occupied Bandwidth	Compliant
§ 2.1051; § 22.917 (a); § 24.238 (a); §27.53	Spurious Emissions at Antenna Terminal	Compliant
§ 2.1053; § 22.917 (a); § 24.238 (a); §27.53	Field Strength of Spurious Radiation	Compliant
§ 22.917 (a); § 24.238 (a); §27.53(c)(h) (m)	Band Edge	Compliant
§ 2.1055; § 22.355; § 24.235; §27.54;	Frequency stability	Compliant

Note: \* Please refer to SAR report released by BACL, report number: SZ1210422-13136E-SA.



**TEST EQUIPMENT LIST**

Manufacturer	Description	Model	Serial Number	Calibration Date	Calibration Due Date
<b>Radiated Emission Test</b>					
R&S	EMI Test Receiver	ESR3	102455	2020/08/04	2021/08/03
Sonoma instrument	Pre-amplifier	310 N	186238	2020/08/04	2021/08/03
Sunol Sciences	Broadband Antenna	JB1	A040904-2	2020/12/22	2023/12/21
COM-POWER	Dipole Antenna	AD-100	721027	NCR	NCR
Unknown	Cable 2	RF Cable 2	F-03-EM197	2020/11/29	2021/11/28
Unknown	Cable	Chamber Cable 1	F-03-EM236	2020/11/29	2021/11/28
Rohde & Schwarz	Spectrum Analyzer	FSV40-N	102259	2020/08/04	2021/08/03
COM-POWER	Pre-amplifier	PA-122	181919	2020/11/29	2021/11/28
Quinstar	Amplifier	QLW-18405536-J0	15964001002	2020/11/28	2021/11/27
Sunol Sciences	Horn Antenna	3115	9107-3694	2021/01/15	2024/01/14
A.H.System	Horn Antenna	SAS-200/571	135	2018/09/01	2021/08/31
Insulted Wire Inc.	RF Cable	SPS-2503-3150	02222010	2020/11/29	2021/11/28
Unknown	RF Cable	W1101-EQ1 OUT	F-19-EM005	2020/11/29	2021/11/28
MICRO-TRONICS	Passband filter	HPM50111	F-19-EM006	2021/04/20	2022/04/20
Unknown	High Pass filter	1.3GHz	101120	2021/04/20	2022/04/20
Ducommun Technologies	Horn antenna	ARH-4223-02	1007726-01 1304	2020/12/06	2023/12/05
Ducommun Technologies	Horn antenna	ARH-4223-02	1007726-02 1304	2020/12/06	2023/12/05
Agilent	Signal Generator	N5183A	MY51040755	2020/12/29	2021/12/28
Rohde & Schwarz	Wideband Radio Communication Tester	CMW500	1201.002K50-146520-wh	2020/08/04	2021/08/03
Rohde & Schwarz	Universal Radio Communication Tester	CMU200	115500	2020/07/31	2021/07/30

Manufacturer	Description	Model	Serial Number	Calibration Date	Calibration Due Date
<b>RF Conducted Test</b>					
Rohde & Schwarz	Signal and Spectrum Analyzer	FSV40	101473	2020/08/04	2021/08/03
Rohde & Schwarz	Wideband Radio Communication Tester	CMW500	1201.002K50-146520-wh	2020/08/04	2021/08/03
Unknown	RF Cable	Unknown	2301 276	2020/11/29	2021/11/28
Unknown	RF Cable	Unknown	DLO J5/W6102	2020/11/29	2021/11/28
Weinschel	Power divider	1515	MY628	2020/11/29	2021/11/28
Rohde & Schwarz	Universal Radio Communication Tester	CMU200	115500	2020/07/31	2021/07/30
instek	DC Power Supply	GPS-3030DD	EM832096	NCR	NCR
ESPEC	Temperature & Humidity Chamber	EL-10KA	9107726	2021/02/23	2022/02/22
Fluke	Digital Multimeter	287	19000011	2020/07/23	2021/07/22

\* Statement of Traceability: Bay Area Compliance Laboratories Corp. (Shenzhen) attests that all calibrations have been performed in accordance to requirements that traceable to National Primary Standards and International System of Units (SI).

---

## **FCC §1.1307(b) & §2.1093 - RF EXPOSURE INFORMATION**

---

### **Applicable Standard**

FCC§1.1310 and §2.1093.

### **Test Result**

Compliant, please refer to the SAR report: SZ1210422-13136E-SA.

---

## **FCC §2.1047 - MODULATION CHARACTERISTIC**

---

According to FCC § 2.1047(d), Part 22H & 24E & 27 there is no specific requirement for digital modulation, therefore modulation characteristic is not presented.

**FCC § 2.1046, § 22.913 (a) & § 24.232 (c); §27.50 (c) (d) (h) - RF OUTPUT POWER**

**Applicable Standard**

According to FCC §2.1046 and §22.913 (a), the ERP of mobile transmitters and auxiliary test transmitters must not exceed 7 watts.

According to FCC §2.1046 and §24.232 (C), mobile and portable stations are limited to 2 watts EIRP and the equipment must employ a means for limiting power to the minimum necessary for successful communications.

The peak-to-average power ratio (PAPR) of the transmitter output power must not exceed 13 dB.

According to §27.50(c), Portable stations (hand-held devices) in the 600 MHz uplink band and the 698-746 MHz band, and fixed and mobile stations in the 600 MHz uplink band are limited to 3 watts ERP.

According to §27.50(d), the maximum EIRP must not exceed 1Watts (30dBm) for 1710-1780MHz.

According to §27.50(h), the maximum EIRP must not exceed 2Watts (33dBm) for 2500-2570MHz & 2496-2690MHz.

**Test Procedure**

*Conducted method:*

The RF output of the transmitter was connected to the CMW500/CMU200 through sufficient attenuation.

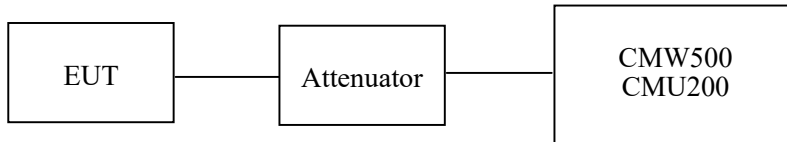

**Test Data**

**Environmental Conditions**

<b>Temperature:</b>	28.2~28.6 °C
<b>Relative Humidity:</b>	52~56 %
<b>ATM Pressure:</b>	100.9~101.0 kPa

*The testing was performed by Pedro Yun from 2021-05-05 to 2021-05-31.*

**Conducted Power**

**Cellular Band (Part 22H)**

Mode	Channel	Frequency (MHz)	Average Output Power (dBm)	ERP (dBm)	Limit (dBm)
GSM	128	824.2	32.8	29.05	38.45
	190	836.6	32.7	28.95	38.45
	251	848.8	32.5	28.75	38.45

Mode	Channel	Frequency (MHz)	Average Output Power (dBm)				ERP(dBm)				Limit (dBm)
			1 slot	2 slots	3 slots	4 slots	1 slot	2 slots	3 slots	4 slots	
GPRS	128	824.2	32.16	30.24	28.38	26.43	28.41	26.49	24.63	22.68	38.45
	190	836.6	32.41	30.29	28.42	26.48	28.66	26.54	24.67	22.73	38.45
	251	848.8	32.42	30.31	28.41	26.55	28.67	26.56	24.66	22.80	38.45

Mode	Channel	Frequency (MHz)	Average Output Power (dBm)				ERP(dBm)				Limit (dBm)
			1 slot	2 slots	3 slots	4 slots	1 slot	2 slots	3 slots	4 slots	
EGPRS	128	824.2	26.24	25.93	24.62	21.85	22.49	22.18	20.87	18.10	38.45
	190	836.6	26.43	26.10	24.98	22.13	22.68	22.35	21.23	18.38	38.45
	251	848.8	26.12	25.74	24.56	21.73	22.37	21.99	20.81	17.98	38.45

Mode	Test Mode	3GPP Sub Test	Average Output Power (dBm)			ERP(dBm)		
			Low	Mid	High	Low	Mid	High
WCDMA (Band 5)	RMC12.2k		16.30	16.44	16.52	12.55	12.69	12.77
	HSDPA	1	15.02	14.82	15.40	11.27	11.07	11.65
		2	15.15	15.08	15.42	11.40	11.33	11.67
		3	15.09	14.82	15.50	11.34	11.07	11.75
		4	15.06	14.89	15.50	11.31	11.14	11.75
	HSUPA	1	15.04	14.78	15.42	11.29	11.03	11.67
		2	14.91	14.96	15.61	11.16	11.21	11.86
		3	14.82	15.11	15.51	11.07	11.36	11.76
		4	14.83	15.08	15.57	11.08	11.33	11.82
		5	14.84	14.96	15.70	11.09	11.21	11.95
HSPA+	1	14.94	14.99	15.69	11.19	11.24	11.94	

Note: ERP(dBm) = Conducted Power(dBm) + Antenna Gain(dBd)  
 For GSM850/WCDMA Band 5: Antenna Gain = -1.6dBi = -3.75dBd (0dBd=2.15dBi)  
 The limit: ERP ≤ 38.45dBm

**PCS Band (Part 24E)**

Mode	Channel	Frequency (MHz)	Average Output Power (dBm)	EIRP(dBm)	Limit (dBm)
GSM	512	1850.2	28.7	28.0	33
	661	1880.0	28.9	28.2	33
	810	1909.8	28.9	28.2	33

Mode	Channel	Frequency (MHz)	Average Output Power (dBm)				EIRP(dBm)				Limit (dBm)
			1 slot	2 slots	3 slots	4 slots	1 slot	2 slots	3 slots	4 slots	
GPRS	512	1850.2	28.76	26.59	24.69	22.79	28.06	25.89	23.99	22.09	33
	661	1880.0	28.46	26.70	24.43	22.65	27.76	26.00	23.73	21.95	33
	810	1909.8	28.43	26.45	24.13	22.59	27.73	25.75	23.43	21.89	33

Mode	Channel	Frequency (MHz)	Average Output Power (dBm)				EIRP(dBm)				Limit (dBm)
			1 slot	2 slots	3 slots	4 slots	1 slot	2 slots	3 slots	4 slots	
EGPRS	512	1850.2	23.04	22.68	22.25	21.72	22.34	21.98	21.55	21.02	33
	661	1880.0	23.23	22.83	22.37	22.14	22.53	22.13	21.67	21.44	33
	810	1909.8	23.02	22.58	22.08	21.92	22.32	21.88	21.38	21.22	33

Mode	Test Mode	3GPP Sub Test	Average Output Power (dBm)			EIRP(dBm)		
			Low	Mid	High	Low	Mid	High
WCDMA (Band 2)	RMC12.2k		14.71	15.50	15.35	14.01	14.80	14.65
	HSDPA	1	12.96	14.63	15.02	12.26	13.93	14.32
		2	12.95	14.61	14.92	12.25	13.91	14.22
		3	13.08	14.44	14.87	12.38	13.74	14.17
		4	12.99	14.22	14.75	12.29	13.52	14.05
	HSUPA	1	13.03	14.67	15.08	12.33	13.97	14.38
		2	12.96	14.65	15.17	12.26	13.95	14.47
		3	13.09	14.59	15.40	12.39	13.89	14.70
		4	12.94	14.34	15.30	12.24	13.64	14.60
		5	12.91	14.53	15.22	12.21	13.83	14.52
	HSPA+	1	13.03	14.58	15.11	12.33	13.88	14.41

Note: EIRP(dBm) = Conducted Power(dBm) + Antenna Gain(dBi)  
 For PCS1900/WCDMA Band 2: Antenna Gain = -0.7dBi  
 The limit: EIRP ≤ 33dBm

**AWS Band (Part 27)**

Mode	Test Mode	3GPP Sub Test	Average Output Power (dBm)			EIRP(dBm)		
			Low	Mid	High	Low	Mid	High
WCDMA (Band 4)	RMC12.2k		16.15	16.20	16.27	15.45	15.50	15.57
	HSDPA	1	14.68	15.18	15.32	13.98	14.48	14.62
		2	14.56	15.13	15.42	13.86	14.43	14.72
		3	14.41	15.08	15.40	13.71	14.38	14.70
		4	14.63	15.08	15.52	13.93	14.38	14.82
	HSUPA	1	14.57	15.12	15.22	13.87	14.42	14.52
		2	14.58	15.13	15.25	13.88	14.43	14.55
		3	14.64	15.07	15.01	13.94	14.37	14.31
		4	14.49	14.93	14.97	13.79	14.23	14.27
		5	14.61	15.12	15.05	13.91	14.42	14.35
	HSPA+	1	14.68	15.18	15.32	13.98	14.48	14.62

Note: EIRP(dBm) = Conducted Power(dBm) + Antenna Gain(dBi)  
 For WCDMA Band 4: Antenna Gain = -0.7dBi  
 The limit: EIRP ≤ 30dBm



**Peak-to-average ratio (PAR)**

**Cellular Band**

Mode	Channel	PAR (dB)	Limit (dB)
GSM	Low	3.16	13
	Middle	3.43	13
	High	3.45	13

Mode	Channel	PAR (dB)	Limit (dB)
EGPRS	Low	3.25	13
	Middle	3.26	13
	High	3.42	13

Mode	Channel	PAR (dB)	Limit (dB)
RMC (BPSK)	Low	3.51	13
	Middle	3.42	13
	High	3.47	13
HSDPA (16QAM)	Low	3.43	13
	Middle	3.17	13
	High	3.45	13
HSUPA (BPSK)	Low	3.14	13
	Middle	3.25	13
	High	3.44	13
HSPA+	Low	3.48	13
	Middle	3.31	13
	High	3.45	13

**PCS Band**

Mode	Channel	PAR (dB)	Limit (dB)
GSM	Low	3.24	13
	Middle	3.26	13
	High	3.54	13

Mode	Channel	PAR (dB)	Limit (dB)
EGPRS	Low	3.21	13
	Middle	3.34	13
	High	3.49	13

Mode	Channel	PAR (dB)	Limit (dB)
RMC (BPSK)	Low	3.61	13
	Middle	3.52	13
	High	3.42	13
HSDPA (16QAM)	Low	3.56	13
	Middle	3.34	13
	High	3.44	13
HSUPA (BPSK)	Low	3.33	13
	Middle	3.65	13
	High	3.47	13
HSPA+	Low	3.16	13
	Middle	3.35	13
	High	3.26	13

**AWS Band**

Mode	Channel	PAR (dB)	Limit (dB)
RMC (BPSK)	Low	3.15	13
	Middle	3.31	13
	High	3.51	13
HSDPA (16QAM)	Low	3.25	13
	Middle	3.26	13
	High	3.33	13
HSUPA (BPSK)	Low	3.24	13
	Middle	3.39	13
	High	3.35	13
HSPA+	Low	3.31	13
	Middle	3.39	13
	High	3.40	13

**LTE Band 2:**

**Maximum Output Power**

Bandwidth (MHz)	Modulation	RB size/ RB Offset	Conducted Average Output Power (dBm)			EIRP(dBm)		
			Low	Mid	High	Low	Mid	High
1.4	QPSK	RB1#0	17.14	17.29	17.25	16.44	16.59	16.55
		RB1#3	16.01	17.50	17.51	15.31	16.80	16.81
		RB1#5	15.89	17.31	17.29	15.19	16.61	16.59
		RB3#0	16.06	17.44	17.45	15.36	16.74	16.75
		RB3#3	15.97	17.46	17.43	15.27	16.76	16.73
		RB6#0	15.21	16.68	16.67	14.51	15.98	15.97
	16QAM	RB1#0	15.29	16.56	16.57	14.59	15.86	15.87
		RB1#3	15.43	16.77	16.76	14.73	16.07	16.06
		RB1#5	15.19	16.59	16.56	14.49	15.89	15.86
		RB3#0	15.27	16.80	16.90	14.57	16.10	16.20
		RB3#3	15.27	16.79	16.90	14.57	16.09	16.20
		RB6#0	15.43	15.76	15.77	14.73	15.06	15.07
3.0	QPSK	RB1#0	16.12	17.40	17.44	15.42	16.70	16.74
		RB1#8	16.11	17.75	17.65	15.41	17.05	16.95
		RB1#14	15.96	17.63	17.50	15.26	16.93	16.80
		RB6#0	15.49	16.90	16.82	14.79	16.20	16.12
		RB6#9	15.27	16.85	16.88	14.57	16.15	16.18
		RB15#0	15.38	16.90	16.88	14.68	16.20	16.18
	16QAM	RB1#0	16.01	16.82	16.70	15.31	16.12	16.00
		RB1#8	15.99	17.01	16.92	15.29	16.31	16.22
		RB1#14	15.81	16.89	16.79	15.11	16.19	16.09
		RB6#0	14.63	15.97	15.85	13.93	15.27	15.15
		RB6#9	14.48	16.00	15.92	13.78	15.30	15.22
		RB15#0	14.60	15.94	16.03	13.90	15.24	15.33

Bandwidth (MHz)	Modulation	RB size/ RB Offset	Conducted Average Output Power (dBm)			EIRP(dBm)		
			Low	Mid	High	Low	Mid	High
5.0	QPSK	RB1#0	16.10	17.40	17.01	15.40	16.70	16.31
		RB1#13	16.45	18.01	17.71	15.75	17.31	17.01
		RB1#24	15.82	17.42	17.25	15.12	16.72	16.55
		RB15#0	15.65	17.04	16.77	14.95	16.34	16.07
		RB15#10	15.48	17.06	16.89	14.78	16.36	16.19
		RB25#0	15.55	17.01	16.79	14.85	16.31	16.09
	16QAM	RB1#0	15.32	16.91	16.36	14.62	16.21	15.66
		RB1#13	15.55	17.54	17.06	14.85	16.84	16.36
		RB1#24	14.88	16.94	16.60	14.18	16.24	15.90
		RB15#0	14.72	16.12	15.86	14.02	15.42	15.16
		RB15#10	14.56	16.15	15.99	13.86	15.45	15.29
		RB25#0	14.61	16.12	15.89	13.91	15.42	15.19
10.0	QPSK	RB1#0	16.62	16.97	16.74	15.92	16.27	16.04
		RB1#25	16.46	17.43	16.91	15.76	16.73	16.21
		RB1#49	16.89	17.43	17.51	16.19	16.73	16.81
		RB25#0	16.01	16.52	16.12	15.31	15.82	15.42
		RB25#25	15.21	16.70	16.59	14.51	16.00	15.89
		RB50#0	15.23	16.69	16.43	14.53	15.99	15.73
	16QAM	RB1#0	15.83	16.35	16.03	15.13	15.65	15.33
		RB1#25	15.70	16.76	16.25	15.00	16.06	15.55
		RB1#49	16.13	16.72	16.83	15.43	16.02	16.13
		RB25#0	14.41	15.59	15.36	13.71	14.89	14.66
		RB25#25	14.54	15.86	15.82	13.84	15.16	15.12
		RB50#0	14.46	15.72	15.54	13.76	15.02	14.84

Bandwidth (MHz)	Modulation	RB size/ RB Offset	Conducted Average Output Power (dBm)			EIRP(dBm)		
			Low	Mid	High	Low	Mid	High
15.0	QPSK	RB1#0	16.44	17.28	16.92	15.74	16.58	16.22
		RB1#38	16.05	17.63	16.58	15.35	16.93	15.88
		RB1#74	16.51	17.40	16.81	15.81	16.70	16.11
		RB36#0	15.59	16.71	16.11	14.89	16.01	15.41
		RB36#39	15.68	16.73	16.11	14.98	16.03	15.41
		RB75#0	15.64	16.72	16.12	14.94	16.02	15.42
	16QAM	RB1#0	16.36	16.49	16.82	15.66	15.79	16.12
		RB1#38	16.06	16.93	16.26	15.36	16.23	15.56
		RB1#74	16.46	16.62	16.72	15.76	15.92	16.02
		RB36#0	14.72	15.84	15.19	14.02	15.14	14.49
		RB36#39	14.81	15.86	15.14	14.11	15.16	14.44
		RB75#0	14.74	15.85	15.09	14.04	15.15	14.39
20.0	QPSK	RB1#0	16.67	17.49	17.59	15.97	16.79	16.89
		RB1#50	16.25	17.55	16.64	15.55	16.85	15.94
		RB1#99	17.86	18.17	17.52	17.16	17.47	16.82
		RB50#0	15.58	16.58	16.52	14.88	15.88	15.82
		RB50#50	16.29	16.95	16.42	15.59	16.25	15.72
		RB100#0	15.92	16.75	16.46	15.22	16.05	15.76
	16QAM	RB1#0	16.29	16.79	17.98	15.59	16.09	17.28
		RB1#50	15.78	16.91	16.49	15.08	16.21	15.79
		RB1#99	17.35	17.43	17.68	16.65	16.73	16.98
		RB50#0	14.48	15.66	15.45	13.78	14.96	14.75
		RB50#50	15.17	16.06	15.32	14.47	15.36	14.62
		RB100#0	14.85	15.86	15.37	14.15	15.16	14.67

Note: EIRP(dBm) = Conducted Power(dBm) + Antenna Gain(dBi)  
 For LTE Band2: Antenna Gain = -0.7dBi  
 The Limit: EIRP ≤ 33dBm

**Peak-to-average ratio (PAR)****20MHz Bandwidth**

<b>Modulation</b>	<b>Low channel (dB)</b>	<b>Middle channel (dB)</b>	<b>High channel (dB)</b>	<b>PAR Limit (dB)</b>	<b>Result</b>
QPSK (1RB Size)	6.41	5.54	5.83	13	Pass
QPSK (100RB Size)	5.87	5.77	5.93	13	Pass
16QAM (1RB Size)	7.37	6.28	7.21	13	Pass
16QAM (100RB Size)	6.54	6.63	6.54	13	Pass

**LTE Band 4**

Bandwidth (MHz)	Modulation	RB size/ RB Offset	Conducted Average Output Power (dBm)			EIRP(dBm)		
			Low	Mid	High	Low	Mid	High
1.4	QPSK	RB1#0	18.10	18.08	18.12	17.40	17.38	17.42
		RB1#3	18.11	18.01	18.04	17.41	17.31	17.34
		RB1#5	18.13	18.04	18.09	17.43	17.34	17.39
		RB3#0	18.21	18.12	17.96	17.51	17.42	17.26
		RB3#3	18.21	18.14	18.07	17.51	17.44	17.37
		RB6#0	17.06	17.07	17.03	16.36	16.37	16.33
	16QAM	RB1#0	17.78	17.78	17.00	17.08	17.08	16.30
		RB1#3	17.83	17.71	16.99	17.13	17.01	16.29
		RB1#5	17.79	17.75	16.96	17.09	17.05	16.26
		RB3#0	17.26	16.94	17.01	16.56	16.24	16.31
		RB3#3	17.30	16.92	17.00	16.60	16.22	16.30
		RB6#0	16.68	16.22	16.39	15.98	15.52	15.69
3.0	QPSK	RB1#0	18.13	18.07	18.09	17.43	17.37	17.39
		RB1#8	18.20	18.11	18.12	17.50	17.41	17.42
		RB1#14	18.10	18.09	18.13	17.40	17.39	17.43
		RB6#0	17.19	17.14	17.10	16.49	16.44	16.40
		RB6#9	17.12	17.04	17.07	16.42	16.34	16.37
		RB15#0	17.12	17.04	17.11	16.42	16.34	16.41
	16QAM	RB1#0	17.59	17.82	17.04	16.89	17.12	16.34
		RB1#8	17.57	17.81	16.98	16.87	17.11	16.28
		RB1#14	17.42	17.78	16.99	16.72	17.08	16.29
		RB6#0	16.43	16.24	16.38	15.73	15.54	15.68
		RB6#9	16.15	16.26	16.38	15.45	15.56	15.68
		RB15#0	16.57	16.17	16.21	15.87	15.47	15.51

Bandwidth (MHz)	Modulation	RB size/ RB Offset	Conducted Average Output Power (dBm)			EIRP(dBm)		
			Low	Mid	High	Low	Mid	High
5.0	QPSK	RB1#0	18.20	18.09	18.02	17.50	17.39	17.32
		RB1#13	18.18	18.09	18.02	17.48	17.39	17.32
		RB1#24	18.23	18.18	17.96	17.53	17.48	17.26
		RB15#0	17.21	17.13	17.14	16.51	16.43	16.44
		RB15#10	17.12	17.04	17.07	16.42	16.34	16.37
		RB25#0	17.19	17.06	17.19	16.49	16.36	16.49
	16QAM	RB1#0	16.34	17.28	16.72	15.64	16.58	16.02
		RB1#13	16.26	17.26	16.76	15.56	16.56	16.06
		RB1#24	16.32	17.30	16.74	15.62	16.60	16.04
		RB15#0	16.60	16.15	16.74	15.90	15.45	16.04
		RB15#10	16.33	16.11	16.24	15.63	15.41	15.54
		RB25#0	16.31	16.25	16.16	15.61	15.55	15.46
10.0	QPSK	RB1#0	18.25	18.36	18.34	17.55	17.66	17.64
		RB1#25	18.18	18.29	18.31	17.48	17.59	17.61
		RB1#49	18.06	18.29	18.27	17.36	17.59	17.57
		RB25#0	17.36	17.09	17.14	16.66	16.39	16.44
		RB25#25	17.24	17.23	17.11	16.54	16.53	16.41
		RB50#0	17.28	17.16	17.14	16.58	16.46	16.44
	16QAM	RB1#0	17.49	17.44	16.65	16.79	16.74	15.95
		RB1#25	17.52	17.31	16.84	16.82	16.61	16.14
		RB1#49	17.45	17.73	16.74	16.75	17.03	16.04
		RB25#0	16.37	16.43	16.35	15.67	15.73	15.65
		RB25#25	16.38	16.39	16.35	15.68	15.69	15.65
		RB50#0	16.31	16.43	16.73	15.61	15.73	16.03



Bandwidth (MHz)	Modulation	RB size/ RB Offset	Conducted Average Output Power (dBm)			EIRP(dBm)		
			Low	Mid	High	Low	Mid	High
15.0	QPSK	RB1#0	18.18	18.37	18.36	17.48	17.67	17.66
		RB1#38	18.22	18.34	18.31	17.52	17.64	17.61
		RB1#74	18.24	18.37	18.22	17.54	17.67	17.52
		RB36#0	17.29	17.34	17.14	16.59	16.64	16.44
		RB36#39	17.26	17.67	17.33	16.56	16.97	16.63
		RB75#0	17.40	17.29	17.21	16.70	16.59	16.51
	16QAM	RB1#0	17.55	17.41	17.49	16.85	16.71	16.79
		RB1#38	17.51	17.43	17.47	16.81	16.73	16.77
		RB1#74	17.46	17.49	17.55	16.76	16.79	16.85
		RB36#0	16.45	16.40	16.81	15.75	15.70	16.11
		RB36#39	16.46	16.75	16.85	15.76	16.05	16.15
		RB75#0	16.46	16.35	16.30	15.76	15.65	15.60
20.0	QPSK	RB1#0	18.53	18.32	18.32	17.83	17.62	17.62
		RB1#50	18.36	18.29	18.29	17.66	17.59	17.59
		RB1#99	18.37	18.38	18.33	17.67	17.68	17.63
		RB50#0	17.31	17.22	17.32	16.61	16.52	16.62
		RB50#50	17.26	17.69	17.32	16.56	16.99	16.62
		RB100#0	17.22	17.36	17.14	16.52	16.66	16.44
	16QAM	RB1#0	17.38	17.68	18.04	16.68	16.98	17.34
		RB1#50	17.23	17.64	17.90	16.53	16.94	17.20
		RB1#99	17.36	17.69	17.99	16.66	16.99	17.29
		RB50#0	16.47	16.51	16.77	15.77	15.81	16.07
		RB50#50	16.94	16.94	16.79	16.24	16.24	16.09
		RB100#0	16.92	16.47	16.87	16.22	15.77	16.17

Note: EIRP(dBm) = Conducted Power(dBm) + Antenna Gain(dBi)  
 For LTE Band 4: Antenna Gain = -0.7dBi  
 The Limit: EIRP ≤ 30dBm

**Peak-to-average ratio (PAR)****20MHz Bandwidth**

<b>Modulation</b>	<b>Low channel (dB)</b>	<b>Middle channel (dB)</b>	<b>High channel (dB)</b>	<b>PAR Limit (dB)</b>	<b>Result</b>
QPSK (1RB Size)	5.48	5.38	5.16	13	Pass
QPSK (100RB Size)	5.77	5.61	5.71	13	Pass
16QAM (1RB Size)	6.51	6.54	6.12	13	Pass
16QAM (100RB Size)	6.57	6.44	6.54	13	Pass

**LTE Band 5:**

Maximum Output Power

Bandwidth (MHz)	Modulation	RB size/ RB Offset	Conducted Average Output Power (dBm)			ERP(dBm)		
			Low	Mid	High	Low	Mid	High
1.4	QPSK	RB1#0	25.65	25.44	25.65	21.90	21.69	21.90
		RB1#3	25.63	25.54	25.67	21.88	21.79	21.92
		RB1#5	25.63	25.61	25.67	21.88	21.86	21.92
		RB3#0	25.77	25.67	25.76	22.02	21.92	22.01
		RB3#3	25.71	25.73	25.68	21.96	21.98	21.93
		RB6#0	24.64	24.54	24.60	20.89	20.79	20.85
	16QAM	RB1#0	25.26	25.32	24.47	21.51	21.57	20.72
		RB1#3	25.17	25.28	24.49	21.42	21.53	20.74
		RB1#5	25.24	25.22	24.53	21.49	21.47	20.78
		RB3#0	24.84	24.52	24.82	21.09	20.77	21.07
		RB3#3	24.91	24.47	24.81	21.16	20.72	21.06
		RB6#0	23.92	23.67	24.45	20.17	19.92	20.70
3.0	QPSK	RB1#0	25.55	25.51	25.72	21.80	21.76	21.97
		RB1#8	25.62	25.64	25.71	21.87	21.89	21.96
		RB1#14	25.62	25.59	25.74	21.87	21.84	21.99
		RB6#0	24.80	24.61	24.69	21.05	20.86	20.94
		RB6#9	24.99	24.55	24.70	21.24	20.80	20.95
		RB15#0	24.80	24.55	24.65	21.05	20.80	20.90
	16QAM	RB1#0	25.10	25.36	24.39	21.35	21.61	20.64
		RB1#8	25.04	25.28	24.32	21.29	21.53	20.57
		RB1#14	25.47	25.29	24.36	21.72	21.54	20.61
		RB6#0	23.71	23.72	23.93	19.96	19.97	20.18
		RB6#9	24.06	23.64	24.41	20.31	19.89	20.66
		RB15#0	23.77	23.67	23.68	20.02	19.92	19.93

Bandwidth (MHz)	Modulation	RB size/ RB Offset	Conducted Average Output Power (dBm)			ERP(dBm)		
			Low	Mid	High	Low	Mid	High
5.0	QPSK	RB1#0	25.79	25.56	26.03	22.04	21.81	22.28
		RB1#13	25.85	25.64	25.60	22.10	21.89	21.85
		RB1#24	25.62	25.70	25.58	21.87	21.95	21.83
		RB15#0	24.79	24.72	25.14	21.04	20.97	21.39
		RB15#10	25.13	24.72	24.65	21.38	20.97	20.90
		RB25#0	25.08	24.65	24.77	21.33	20.90	21.02
	16QAM	RB1#0	23.87	24.81	24.72	20.12	21.06	20.97
		RB1#13	24.25	24.75	24.38	20.50	21.00	20.63
		RB1#24	23.78	24.81	24.36	20.03	21.06	20.61
		RB15#0	23.80	23.61	24.27	20.05	19.86	20.52
		RB15#10	24.16	23.52	23.72	20.41	19.77	19.97
		RB25#0	24.20	23.65	23.62	20.45	19.90	19.87
10.0	QPSK	RB1#0	25.66	25.79	25.66	21.91	22.04	21.91
		RB1#25	25.63	25.87	25.73	21.88	22.12	21.98
		RB1#49	25.57	25.93	25.76	21.82	22.18	22.01
		RB25#0	25.10	24.64	24.73	21.35	20.89	20.98
		RB25#25	24.57	24.68	24.62	20.82	20.93	20.87
		RB50#0	24.76	24.57	24.70	21.01	20.82	20.95
	16QAM	RB1#0	24.93	24.85	24.24	21.18	21.10	20.49
		RB1#25	24.87	24.87	24.26	21.12	21.12	20.51
		RB1#49	24.78	24.89	24.23	21.03	21.14	20.48
		RB25#0	24.13	23.89	24.34	20.38	20.14	20.59
		RB25#25	23.68	24.24	23.85	19.93	20.49	20.10
		RB50#0	23.69	23.73	23.75	19.94	19.98	20.00

Note: ERP(dBm) = Conducted Power(dBm) + Antenna Gain(dBd)  
 For LTE Band 5: Antenna Gain = -1.6dBi = -3.75dBd (0dBd=2.15dBi)  
 Limit: ERP ≤ 38.45dBm

**Peak-to-average ratio (PAR)****10MHz bandwidth**

<b>Modulation</b>	<b>Low channel (dB)</b>	<b>Middle channel (dB)</b>	<b>High channel (dB)</b>	<b>PAR Limit (dB)</b>	<b>Result</b>
QPSK (1RB Size)	5.67	5.19	5.42	13	Pass
QPSK (50RB Size)	5.61	5.77	5.71	13	Pass
16QAM (1RB Size)	6.38	6.47	6.41	13	Pass
16QAM (50RB Size)	6.54	6.54	6.63	13	Pass

**LTE Band 7:**

**Maximum Output Power**

Bandwidth (MHz)	Modulation	RB size/ RB Offset	Conducted Average Output Power (dBm)			EIRP(dBm)		
			Low	Mid	High	Low	Mid	High
5.0	QPSK	RB1#0	16.08	15.14	15.12	15.68	14.74	14.72
		RB1#13	16.35	15.88	16.22	15.95	15.48	15.82
		RB1#24	15.46	15.27	16.09	15.06	14.87	15.69
		RB15#0	15.21	14.79	14.95	14.81	14.39	14.55
		RB15#10	15.01	14.86	15.31	14.61	14.46	14.91
		RB25#0	15.05	14.80	15.11	14.65	14.40	14.71
	16QAM	RB1#0	14.79	14.60	14.43	14.39	14.20	14.03
		RB1#13	15.11	15.33	15.37	14.71	14.93	14.97
		RB1#24	14.23	14.73	15.25	13.83	14.33	14.85
		RB15#0	14.32	13.82	14.06	13.92	13.42	13.66
		RB15#10	14.09	13.90	14.42	13.69	13.50	14.02
		RB25#0	14.18	13.84	14.21	13.78	13.44	13.81
10.0	QPSK	RB1#0	16.66	14.85	14.89	16.26	14.45	14.49
		RB1#25	16.33	15.81	15.71	15.93	15.41	15.31
		RB1#49	15.93	15.65	16.80	15.53	15.25	16.40
		RB25#0	15.67	14.68	14.49	15.27	14.28	14.09
		RB25#25	15.20	15.07	15.45	14.80	14.67	15.05
		RB50#0	15.45	14.90	15.02	15.05	14.50	14.62
	16QAM	RB1#0	16.33	14.22	14.16	15.93	13.82	13.76
		RB1#25	15.98	15.11	14.80	15.58	14.71	14.40
		RB1#49	15.60	14.98	15.93	15.20	14.58	15.53
		RB25#0	14.78	13.78	13.66	14.38	13.38	13.26
		RB25#25	14.30	14.17	14.59	13.90	13.77	14.19
		RB50#0	14.52	13.97	14.09	14.12	13.57	13.69

Bandwidth (MHz)	Modulation	RB size/ RB Offset	Conducted Average Output Power (dBm)			EIRP(dBm)		
			Low	Mid	High	Low	Mid	High
15.0	QPSK	RB1#0	16.86	14.74	15.58	16.46	14.34	15.18
		RB1#38	15.85	15.83	15.70	15.45	15.43	15.30
		RB1#74	15.39	15.00	16.86	14.99	14.60	16.46
		RB36#0	15.64	14.66	14.77	15.24	14.26	14.37
		RB36#39	14.67	14.83	15.44	14.27	14.43	15.04
		RB75#0	15.20	14.77	15.12	14.80	14.37	14.72
	16QAM	RB1#0	16.60	14.14	15.23	16.20	13.74	14.83
		RB1#38	15.53	15.15	15.25	15.13	14.75	14.85
		RB1#74	15.12	14.36	16.37	14.72	13.96	15.97
		RB36#0	14.69	13.69	13.94	14.29	13.29	13.54
		RB36#39	13.71	13.88	14.60	13.31	13.48	14.20
		RB75#0	14.22	13.79	14.24	13.82	13.39	13.84
20.0	QPSK	RB1#0	17.07	14.40	16.29	16.67	14.00	15.89
		RB1#50	15.57	15.84	15.54	15.17	15.44	15.14
		RB1#99	16.54	15.26	17.56	16.14	14.86	17.16
		RB50#0	15.47	14.40	14.84	15.07	14.00	14.44
		RB50#50	15.10	14.90	15.56	14.70	14.50	15.16
		RB100#0	15.31	14.67	15.22	14.91	14.27	14.82
	16QAM	RB1#0	16.50	13.94	16.07	16.10	13.54	15.67
		RB1#50	14.91	15.23	15.24	14.51	14.83	14.84
		RB1#99	15.93	14.73	17.23	15.53	14.33	16.83
		RB50#0	14.47	13.39	14.05	14.07	12.99	13.65
		RB50#50	14.05	13.92	14.55	13.65	13.52	14.15
		RB100#0	14.28	13.67	14.16	13.88	13.27	13.76

Note: ERP(dBm) = Conducted Power(dBm) + Antenna Gain(dBi)  
 For LTE Band7: Antenna Gain = -0.4dBi  
 Limit: EIRP ≤ 33dBm

**Peak-to-average ratio (PAR)****20MHz bandwidth**

<b>Modulation</b>	<b>Low channel (dB)</b>	<b>Middle channel (dB)</b>	<b>High channel (dB)</b>	<b>PAR Limit (dB)</b>	<b>Result</b>
QPSK (1RB Size)	6.38	5.80	6.51	13	Pass
QPSK (100RB Size)	5.80	5.64	5.87	13	Pass
16QAM (1RB Size)	7.18	6.25	7.40	13	Pass
16QAM (100RB Size)	6.73	6.47	7.23	13	Pass



**LTE Band 17:**

**Maximum Output Power**

Bandwidth (MHz)	Modulation	RB size/ RB Offset	Conducted Average Output Power (dBm)			ERP(dBm)		
			Low	Mid	High	Low	Mid	High
5.0	QPSK	RB1#0	25.08	24.98	25.00	21.33	21.23	21.25
		RB1#13	25.14	25.05	24.92	21.39	21.30	21.17
		RB1#24	25.17	25.01	24.94	21.42	21.26	21.19
		RB15#0	24.06	23.98	24.09	20.31	20.23	20.34
		RB15#10	24.05	24.55	24.50	20.30	20.80	20.75
		RB25#0	24.01	24.02	24.12	20.26	20.27	20.37
	16QAM	RB1#0	23.26	23.97	24.05	19.51	20.22	20.30
		RB1#13	23.17	24.35	23.78	19.42	20.60	20.03
		RB1#24	23.27	24.04	24.07	19.52	20.29	20.32
		RB15#0	23.58	23.42	23.13	19.83	19.67	19.38
		RB15#10	23.13	23.43	23.53	19.38	19.68	19.78
		RB25#0	23.18	23.57	22.98	19.43	19.82	19.23
10.0	QPSK	RB1#0	24.96	24.99	25.18	21.21	21.24	21.43
		RB1#25	24.99	25.20	25.17	21.24	21.45	21.42
		RB1#49	24.91	25.11	25.19	21.16	21.36	21.44
		RB25#0	24.07	24.03	24.02	20.32	20.28	20.27
		RB25#25	24.50	24.09	24.13	20.75	20.34	20.38
		RB50#0	24.03	23.95	24.50	20.28	20.20	20.75
	16QAM	RB1#0	24.12	24.33	23.54	20.37	20.58	19.79
		RB1#25	24.16	24.23	24.08	20.41	20.48	20.33
		RB1#49	24.10	24.58	24.08	20.35	20.83	20.33
		RB25#0	23.05	23.11	23.60	19.30	19.36	19.85
		RB25#25	23.54	23.13	23.14	19.79	19.38	19.39
		RB50#0	23.67	23.63	23.59	19.92	19.88	19.84

Note: ERP(dBm) = Conducted Power(dBm) + Antenna Gain(dBd)  
 For LTE Band17: Antenna Gain = -1.6dBi = -3.75dBd (0dBd=2.15dBi)  
 Limit: ERP ≤ 34.77dBm

**Peak-to-average ratio (PAR)****10MHz bandwidth**

<b>Modulation</b>	<b>Low channel (dB)</b>	<b>Middle channel (dB)</b>	<b>High channel (dB)</b>	<b>PAR Limit (dB)</b>	<b>Result</b>
QPSK (1RB Size)	5.68	5.90	5.58	13	Pass
QPSK (50RB Size)	5.91	5.86	5.15	13	Pass
16QAM (1RB Size)	6.77	6.44	6.28	13	Pass
16QAM (50RB Size)	6.38	6.47	6.44	13	Pass

**LTE Band 38**

**Maximum Output Power**

Bandwidth (MHz)	Modulation	RB size/ RB Offset	Conducted Average Output Power (dBm)			EIRP(dBm)		
			Low	Mid	High	Low	Mid	High
5.0	QPSK	RB1#0	15.57	15.78	15.28	15.17	15.38	14.88
		RB1#13	15.58	16.31	15.30	15.18	15.91	14.90
		RB1#24	15.62	15.61	15.28	15.22	15.21	14.88
		RB15#0	14.68	15.01	14.34	14.28	14.61	13.94
		RB15#10	14.73	14.96	14.34	14.33	14.56	13.94
		RB25#0	14.60	14.96	14.38	14.20	14.56	13.98
	16QAM	RB1#0	14.38	14.81	14.57	13.98	14.41	14.17
		RB1#13	14.50	15.17	14.58	14.10	14.77	14.18
		RB1#24	14.48	14.44	14.73	14.08	14.04	14.33
		RB15#0	13.96	13.80	13.56	13.56	13.40	13.16
		RB15#10	13.87	13.76	13.59	13.47	13.36	13.19
		RB25#0	13.70	13.82	13.57	13.30	13.42	13.17
10.0	QPSK	RB1#0	15.75	15.83	15.52	15.35	15.43	15.12
		RB1#25	15.71	16.28	15.44	15.31	15.88	15.04
		RB1#49	16.08	16.31	15.43	15.68	15.91	15.03
		RB25#0	14.53	15.00	14.51	14.13	14.60	14.11
		RB25#25	14.82	15.14	14.44	14.42	14.74	14.04
		RB50#0	14.59	15.08	14.37	14.19	14.68	13.97
	16QAM	RB1#0	15.00	14.91	14.67	14.60	14.51	14.27
		RB1#25	14.85	15.04	14.59	14.45	14.64	14.19
		RB1#49	15.26	15.20	15.35	14.86	14.80	14.95
		RB25#0	13.66	13.84	13.74	13.26	13.44	13.34
		RB25#25	13.70	13.99	13.61	13.30	13.59	13.21
		RB50#0	13.72	13.90	13.56	13.32	13.50	13.16

Bandwidth (MHz)	Modulation	RB size/ RB Offset	Conducted Average Output Power (dBm)			EIRP(dBm)		
			Low	Mid	High	Low	Mid	High
15.0	QPSK	RB1#0	15.84	16.03	15.36	15.44	15.63	14.96
		RB1#38	15.88	16.30	15.45	15.48	15.90	15.05
		RB1#74	16.31	16.03	15.37	15.91	15.63	14.97
		RB36#0	14.66	15.08	14.63	14.26	14.68	14.23
		RB36#39	15.09	15.00	14.48	14.69	14.60	14.08
		RB75#0	14.71	15.05	14.53	14.31	14.65	14.13
	16QAM	RB1#0	14.91	15.20	14.69	14.51	14.80	14.29
		RB1#38	14.79	15.26	14.64	14.39	14.86	14.24
		RB1#74	15.53	15.19	14.54	15.13	14.79	14.14
		RB36#0	13.66	13.87	13.71	13.26	13.47	13.31
		RB36#39	13.84	13.80	13.53	13.44	13.40	13.13
		RB75#0	13.85	13.88	13.70	13.45	13.48	13.30
20.0	QPSK	RB1#0	15.62	15.89	15.76	15.22	15.49	15.36
		RB1#50	15.97	16.23	15.62	15.57	15.83	15.22
		RB1#99	17.41	16.44	15.56	17.01	16.04	15.16
		RB50#0	14.54	14.90	14.52	14.14	14.50	14.12
		RB50#50	15.84	15.17	14.52	15.44	14.77	14.12
		RB100#0	15.22	15.04	14.56	14.82	14.64	14.16
	16QAM	RB1#0	14.84	14.71	15.30	14.44	14.31	14.90
		RB1#50	15.05	15.07	15.16	14.65	14.67	14.76
		RB1#99	16.57	15.26	15.12	16.17	14.86	14.72
		RB50#0	13.90	13.79	13.63	13.50	13.39	13.23
		RB50#50	14.54	14.05	13.51	14.14	13.65	13.11
		RB100#0	13.94	13.87	13.71	13.54	13.47	13.31

Note: EIRP(dBm) = Conducted Power(dBm) + Antenna Gain(dBi)  
 For LTE Band38: Antenna Gain = -0.4dBi  
 Limit: EIRP ≤ 33dBm

**Peak-to-average ratio (PAR)****20MHz bandwidth**

<b>Modulation</b>	<b>Low channel (dB)</b>	<b>Middle channel (dB)</b>	<b>High channel (dB)</b>	<b>PAR Limit (dB)</b>	<b>Result</b>
QPSK (1RB Size)	5.32	5.21	5.97	13	Pass
QPSK (100RB Size)	6.92	6.21	6.28	13	Pass
16QAM (1RB Size)	6.46	6.02	6.33	13	Pass
16QAM (100RB Size)	7.69	7.53	7.46	13	Pass

**LTE Band 41:**

**Maximum Output Power**

Bandwidth (MHz)	Modulation	RB size/ RB Offset	Conducted Average Output Power (dBm)			EIRP(dBm)		
			Low	Mid	High	Low	Mid	High
5.0	QPSK	RB1#0	16.07	15.88	15.17	15.67	15.48	14.77
		RB1#13	16.02	16.41	15.19	15.62	16.01	14.79
		RB1#24	16.11	15.69	15.27	15.71	15.29	14.87
		RB15#0	15.00	15.08	14.40	14.60	14.68	14.00
		RB15#10	15.00	15.04	14.34	14.60	14.64	13.94
		RB25#0	15.05	15.02	14.41	14.65	14.62	14.01
	16QAM	RB1#0	15.27	14.89	14.27	14.87	14.49	13.87
		RB1#13	14.70	15.29	14.10	14.30	14.89	13.70
		RB1#24	15.37	14.89	14.22	14.97	14.49	13.82
		RB15#0	14.17	13.93	13.66	13.77	13.53	13.26
		RB15#10	14.17	13.88	13.68	13.77	13.48	13.28
		RB25#0	14.14	13.89	13.56	13.74	13.49	13.16
10.0	QPSK	RB1#0	16.04	15.93	15.30	15.64	15.53	14.90
		RB1#25	16.04	16.37	15.28	15.64	15.97	14.88
		RB1#49	15.94	16.39	15.34	15.54	15.99	14.94
		RB25#0	15.08	15.07	14.33	14.68	14.67	13.93
		RB25#25	14.90	15.21	14.32	14.50	14.81	13.92
		RB50#0	15.00	15.15	14.39	14.60	14.75	13.99
	16QAM	RB1#0	14.74	14.97	14.41	14.34	14.57	14.01
		RB1#25	14.78	15.12	14.44	14.38	14.72	14.04
		RB1#49	14.73	15.27	14.44	14.33	14.87	14.04
		RB25#0	14.14	13.91	13.48	13.74	13.51	13.08
		RB25#25	14.09	14.08	13.58	13.69	13.68	13.18
		RB50#0	14.20	13.97	13.42	13.80	13.57	13.02

Bandwidth (MHz)	Modulation	RB size/ RB Offset	Conducted Average Output Power (dBm)			EIRP(dBm)		
			Low	Mid	High	Low	Mid	High
15.0	QPSK	RB1#0	16.13	16.10	15.08	15.73	15.70	14.68
		RB1#38	16.03	16.38	15.25	15.63	15.98	14.85
		RB1#74	15.96	16.10	15.33	15.56	15.70	14.93
		RB36#0	15.08	15.14	14.30	14.68	14.74	13.90
		RB36#39	15.00	15.07	14.47	14.60	14.67	14.07
		RB75#0	15.06	15.11	14.35	14.66	14.71	13.95
	16QAM	RB1#0	14.71	15.25	14.45	14.31	14.85	14.05
		RB1#38	14.84	15.33	14.44	14.44	14.93	14.04
		RB1#74	14.81	14.82	14.56	14.41	14.42	14.16
		RB36#0	14.13	13.93	13.41	13.73	13.53	13.01
		RB36#39	13.93	13.85	13.59	13.53	13.45	13.19
		RB75#0	14.08	13.93	13.50	13.68	13.53	13.10
20.0	QPSK	RB1#0	16.04	15.93	15.46	15.64	15.53	15.06
		RB1#50	15.85	16.27	15.35	15.45	15.87	14.95
		RB1#99	15.87	16.49	15.55	15.47	16.09	15.15
		RB50#0	14.99	14.94	14.30	14.59	14.54	13.90
		RB50#50	14.85	15.20	14.40	14.45	14.80	14.00
		RB100#0	14.88	15.08	14.29	14.48	14.68	13.89
	16QAM	RB1#0	15.25	14.74	15.12	14.85	14.34	14.72
		RB1#50	15.01	15.11	15.08	14.61	14.71	14.68
		RB1#99	15.15	15.30	15.35	14.75	14.90	14.95
		RB50#0	14.24	13.84	13.44	13.84	13.44	13.04
		RB50#50	14.05	14.09	13.52	13.65	13.69	13.12
		RB100#0	13.95	13.91	13.39	13.55	13.51	12.99

Note: ERP(dBm) = Conducted Power(dBm) + Antenna Gain(dBi)  
 For LTE Band 41: Antenna Gain = -0.4dBi  
 Limit: EIRP ≤ 33dBm

**Peak-to-average ratio (PAR)****20MHz bandwidth**

<b>Modulation</b>	<b>Low channel (dB)</b>	<b>Middle channel (dB)</b>	<b>High channel (dB)</b>	<b>PAR Limit (dB)</b>	<b>Result</b>
QPSK (1RB Size)	4.68	4.90	4.97	13	Pass
QPSK (100RB Size)	5.51	5.67	5.51	13	Pass
16QAM (1RB Size)	5.77	6.44	5.71	13	Pass
16QAM (100RB Size)	6.38	6.47	6.44	13	Pass



**LTE Band 66:**

**Maximum Output Power**

Bandwidth (MHz)	Modulation	RB size/ RB Offset	Conducted Average Output Power (dBm)			EIRP(dBm)		
			Low	Mid	High	Low	Mid	High
1.4	QPSK	RB1#0	17.48	17.50	15.47	16.78	16.80	14.77
		RB1#3	17.73	17.64	15.60	17.03	16.94	14.90
		RB1#5	17.46	17.40	15.34	16.76	16.70	14.64
		RB3#0	17.58	17.62	15.58	16.88	16.92	14.88
		RB3#3	17.61	17.56	15.53	16.91	16.86	14.83
		RB6#0	16.55	16.57	14.46	15.85	15.87	13.76
	16QAM	RB1#0	16.41	16.64	14.40	15.71	15.94	13.70
		RB1#3	16.66	16.80	14.56	15.96	16.10	13.86
		RB1#5	16.49	16.55	14.32	15.79	15.85	13.62
		RB3#0	16.79	16.64	14.63	16.09	15.94	13.93
		RB3#3	16.82	16.59	14.55	16.12	15.89	13.85
		RB6#0	15.76	15.67	14.56	15.06	14.97	13.86
3.0	QPSK	RB1#0	17.49	17.67	15.89	16.79	16.97	15.19
		RB1#8	17.68	17.64	15.70	16.98	16.94	15.00
		RB1#14	17.57	17.38	15.42	16.87	16.68	14.72
		RB6#0	16.60	16.73	14.81	15.90	16.03	14.11
		RB6#9	16.67	16.54	14.53	15.97	15.84	13.83
		RB15#0	16.68	16.68	14.70	15.98	15.98	14.00
	16QAM	RB1#0	17.10	16.83	14.84	16.40	16.13	14.14
		RB1#8	17.31	16.79	14.65	16.61	16.09	13.95
		RB1#14	17.19	16.54	14.39	16.49	15.84	13.69
		RB6#0	15.84	15.81	13.91	15.14	15.11	13.21
		RB6#9	15.89	15.63	13.62	15.19	14.93	12.92
		RB15#0	15.90	15.67	13.90	15.20	14.97	13.20

Bandwidth (MHz)	Modulation	RB size/ RB Offset	Conducted Average Output Power (dBm)			EIRP(dBm)		
			Low	Mid	High	Low	Mid	High
5.0	QP SK	RB1#0	17.27	17.58	16.05	16.57	16.88	15.35
		RB1#13	17.88	17.85	16.02	17.18	17.15	15.32
		RB1#24	17.36	17.09	15.14	16.66	16.39	14.44
		RB15#0	16.64	16.86	15.09	15.94	16.16	14.39
		RB15#10	16.69	16.65	14.72	15.99	15.95	14.02
		RB25#0	16.62	16.72	14.86	15.92	16.02	14.16
	16QAM	RB1#0	16.12	16.90	15.08	15.42	16.20	14.38
		RB1#13	16.75	17.16	15.05	16.05	16.46	14.35
		RB1#24	16.23	16.37	14.18	15.53	15.67	13.48
		RB15#0	15.85	15.77	14.25	15.15	15.07	13.55
		RB15#10	15.88	15.58	13.88	15.18	14.88	13.18
		RB25#0	15.83	15.66	14.04	15.13	14.96	13.34
10.0	QPSK	RB1#0	17.06	17.79	17.44	16.36	17.09	16.74
		RB1#25	17.46	17.70	16.57	16.76	17.00	15.87
		RB1#49	17.84	17.50	15.91	17.14	16.80	15.21
		RB25#0	16.32	16.95	16.12	15.62	16.25	15.42
		RB25#25	16.67	16.73	15.25	15.97	16.03	14.55
		RB50#0	16.50	16.84	15.72	15.80	16.14	15.02
	16QAM	RB1#0	16.58	17.08	16.42	15.88	16.38	15.72
		RB1#25	17.05	16.86	15.54	16.35	16.16	14.84
		RB1#49	17.35	16.77	14.88	16.65	16.07	14.18
		RB25#0	15.58	16.03	15.33	14.88	15.33	14.63
		RB25#25	15.91	15.80	14.45	15.21	15.10	13.75
		RB50#0	15.70	15.90	14.86	15.00	15.20	14.16

Bandwidth (MHz)	Modulation	RB size/ RB Offset	Conducted Average Output Power (dBm)			EIRP(dBm)		
			Low	Mid	High	Low	Mid	High
15.0	QPSK	RB1#0	17.29	18.29	18.46	16.59	17.59	17.76
		RB1#38	17.52	17.68	17.27	16.82	16.98	16.57
		RB1#74	17.93	17.21	15.86	17.23	16.51	15.16
		RB36#0	16.51	17.16	17.23	15.81	16.46	16.53
		RB36#39	16.74	16.49	15.65	16.04	15.79	14.95
		RB75#0	16.62	16.85	16.51	15.92	16.15	15.81
	16QAM	RB1#0	16.93	17.43	17.91	16.23	16.73	17.21
		RB1#38	17.09	16.84	16.73	16.39	16.14	16.03
		RB1#74	17.47	16.33	15.32	16.77	15.63	14.62
		RB36#0	15.62	16.24	16.32	14.92	15.54	15.62
		RB36#39	15.79	15.57	14.72	15.09	14.87	14.02
		RB75#0	15.68	15.92	15.60	14.98	15.22	14.90
20.0	QPSK	RB1#0	17.30	18.72	18.58	16.60	18.02	17.88
		RB1#50	17.43	17.72	17.87	16.73	17.02	17.17
		RB1#99	18.88	18.10	16.60	18.18	17.40	15.90
		RB50#0	16.34	17.20	17.43	15.64	16.50	16.73
		RB50#50	17.19	16.77	16.28	16.49	16.07	15.58
		RB100#0	16.77	16.98	16.89	16.07	16.28	16.19
	16QAM	RB1#0	16.72	17.92	18.23	16.02	17.22	17.53
		RB1#50	16.75	16.95	17.49	16.05	16.25	16.79
		RB1#99	18.26	17.27	16.24	17.56	16.57	15.54
		RB50#0	15.41	16.28	16.53	14.71	15.58	15.83
		RB50#50	16.24	15.82	15.38	15.54	15.12	14.68
		RB100#0	15.85	16.05	15.99	15.15	15.35	15.29

Note: EIRP(dBm) = Conducted Power(dBm) + Antenna Gain(dBi)  
 For LTE Band 66: Antenna Gain = -0.7dBi  
 The Limit: EIRP ≤ 30dBm

**Peak-to-average ratio (PAR)****20MHz bandwidth**

<b>Modulation</b>	<b>Low channel (dB)</b>	<b>Middle channel (dB)</b>	<b>High channel (dB)</b>	<b>PAR Limit (dB)</b>	<b>Result</b>
QPSK (1RB Size)	5.47	5.69	5.73	13	Pass
QPSK (100RB Size)	6.69	6.18	6.63	13	Pass
16QAM (1RB Size)	7.11	7.43	6.47	13	Pass
16QAM (100RB Size)	6.71	6.76	7.05	13	Pass

**FCC §2.1049, §22.917, §22.905 & §24.238 & §27.53 - OCCUPIED BANDWIDTH**

**Applicable Standard**

FCC 47 §2.1049, §22.917, §22.905, §24.238 and §27.53.

**Test Procedure**

The RF output of the transmitter was connected to the simulator and the spectrum analyzer through sufficient attenuation.

The resolution bandwidth of the spectrum analyzer was set at 1% to 5% of the anticipated emission bandwidth and the 26 dB & 99% bandwidth was recorded.

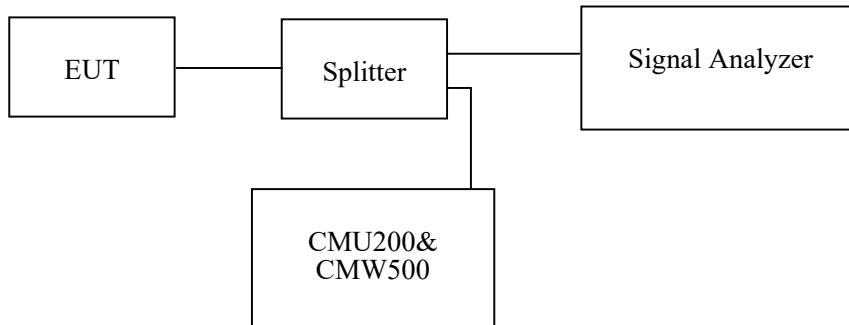

**Test Data**

**Environmental Conditions**

<b>Temperature:</b>	28.2~28.6 °C
<b>Relative Humidity:</b>	52~56 %
<b>ATM Pressure:</b>	100.9~101.0 kPa

*The testing was performed by Pedro Yun from 2021-05-05 to 2021-06-06.*

*EUT operation mode: Transmitting*

**Test Result: Pass**

*Please refer to the following tables and plots.*

**Cellular Band (Part 22H)**

Mode	Channel	Frequency (MHz)	99% Occupied Bandwidth (kHz)	26 dB Emission Bandwidth (kHz)
GSM(GMSK)	128	824.2	241.99	312.82
	190	836.6	240.38	312.18
	251	848.8	243.59	314.42
EGPRS(8PSK)	128	824.2	248.40	320.83
	190	836.6	250.00	326.28
	251	848.8	250.00	309.29

	Frequency (MHz)	Occupied Bandwidth (MHz)	26dB Bandwidth (MHz)
RMC	826.4	4.13	4.67
	836.6	4.15	4.67
	846.6	4.15	4.69
HSDPA	826.4	4.13	4.68
	836.6	4.17	4.69
	846.6	4.15	4.70
HSUPA	826.4	4.12	4.67
	836.6	4.15	4.69
	846.6	4.15	4.70

**PCS Band (Part 24E)**

Mode	Channel	Frequency (MHz)	99% Occupied Bandwidth (kHz)	26 dB Emission Bandwidth (kHz)
GSM(GMSK)	512	1850.2	243.59	317.31
	661	1880.0	243.59	316.03
	810	1909.8	240.38	312.50
EGPRS(8PSK)	512	1850.2	243.59	307.69
	661	1880.0	240.38	309.29
	810	1909.8	241.99	301.60

Frequency (MHz)		Occupied Bandwidth (MHz)	26dB Bandwidth (MHz)
RMC	1852.4	4.15	4.69
	1880.0	4.15	4.69
	1907.6	4.15	4.68
HSDPA	1852.4	4.15	4.69
	1880.0	4.15	4.68
	1907.6	4.15	4.67
HSUPA	1852.4	4.17	4.69
	1880.0	4.15	4.66
	1907.6	4.15	4.66

**AWS Band (Part 27)**

Frequency (MHz)		Occupied Bandwidth (MHz)	26dB Bandwidth (MHz)
RMC	1712.4	4.16	4.69
	1732.6	4.16	4.71
	1752.6	4.16	4.70
HSDPA	1712.4	4.16	4.68
	1732.6	4.16	4.71
	1752.6	4.16	4.70
HSUPA	1712.4	4.15	4.69
	1732.6	4.16	4.70
	1752.6	4.16	4.68

**Cellular Band (Part 22H)**

**26 dB Emissions & 99% Occupied Bandwidth for GSM (GMSK) Mode, Low channel**

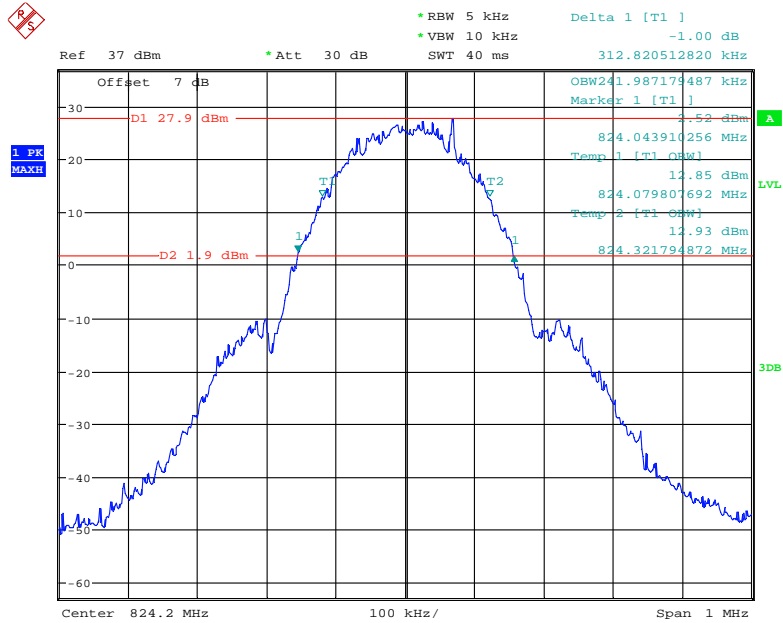

Date: 5.MAY.2021 09:48:09

**26 dB Emissions & 99% Occupied Bandwidth for GSM (GMSK) Mode, Middle channel**

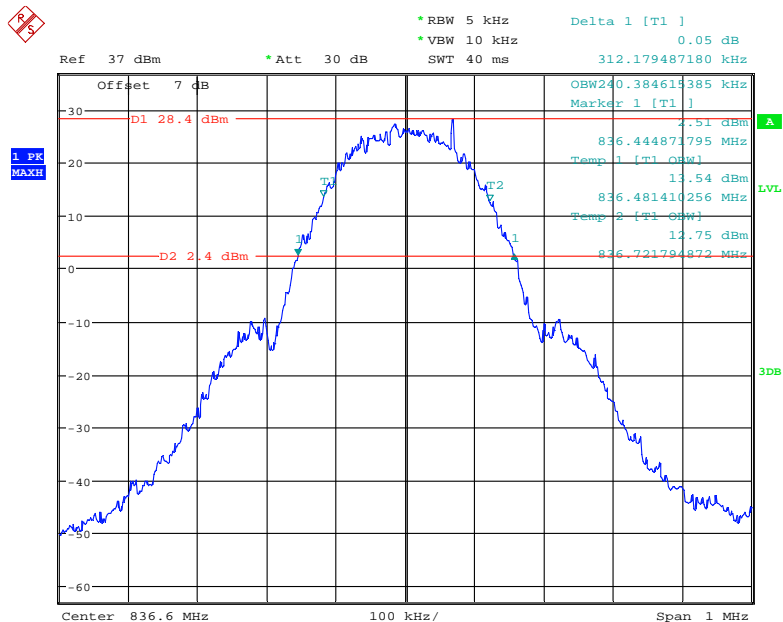

Date: 5.MAY.2021 09:52:22



26 dB Emissions & 99% Occupied Bandwidth for GSM (GMSK) Mode, High channel

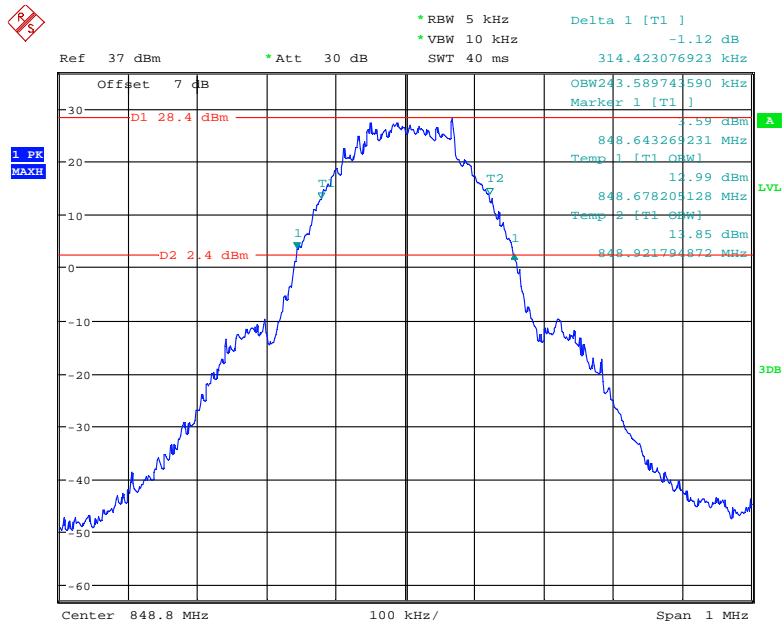

Date: 5.MAY.2021 09:54:16

26 dB Emissions & 99% Occupied Bandwidth for EGPRS (8PSK) Mode, Low channel

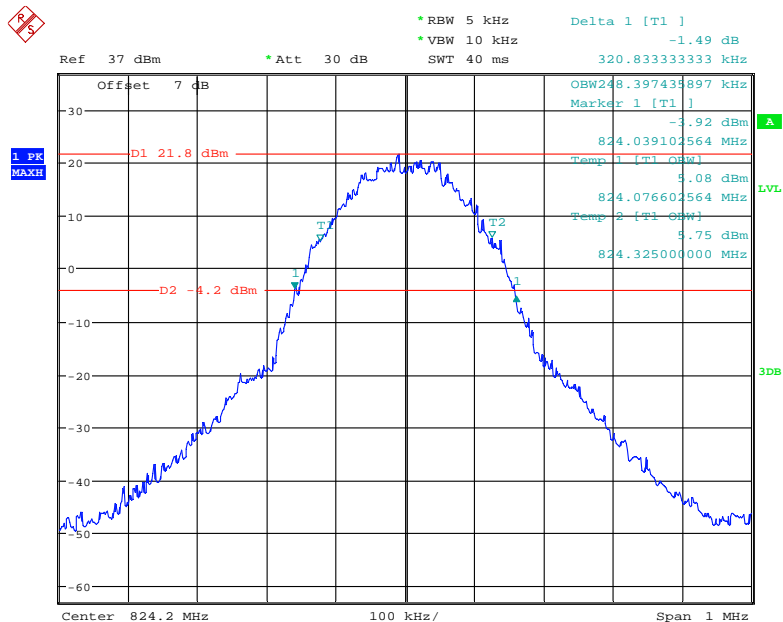

Date: 5.MAY.2021 09:45:35

26 dB Emissions & 99% Occupied Bandwidth for EGPRS (8PSK) Mode, Middle channel

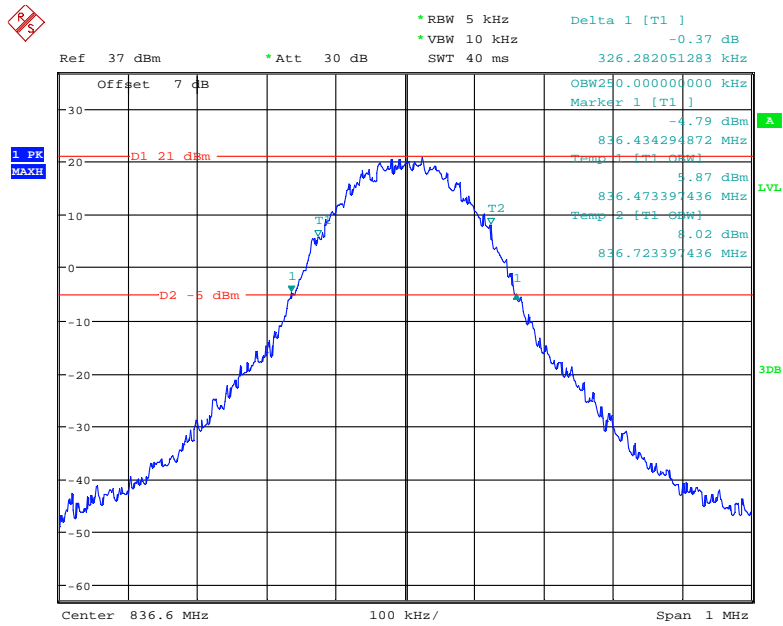

Date: 5.MAY.2021 09:43:00

26 dB Emissions & 99% Occupied Bandwidth for EGPRS (8PSK) Mode, High channel

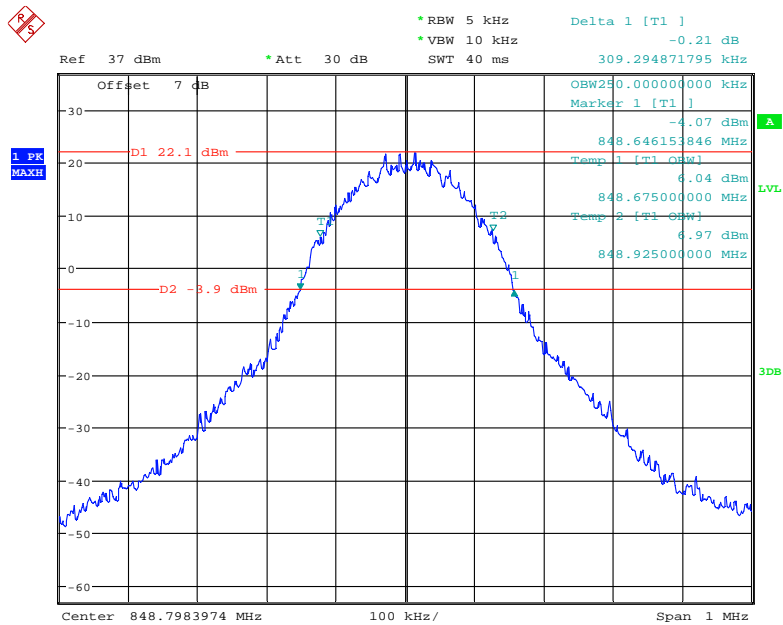

Date: 5.MAY.2021 09:40:04

**26 dB Emissions & 99% Occupied Bandwidth for RMC (BPSK) Mode, Low channel**

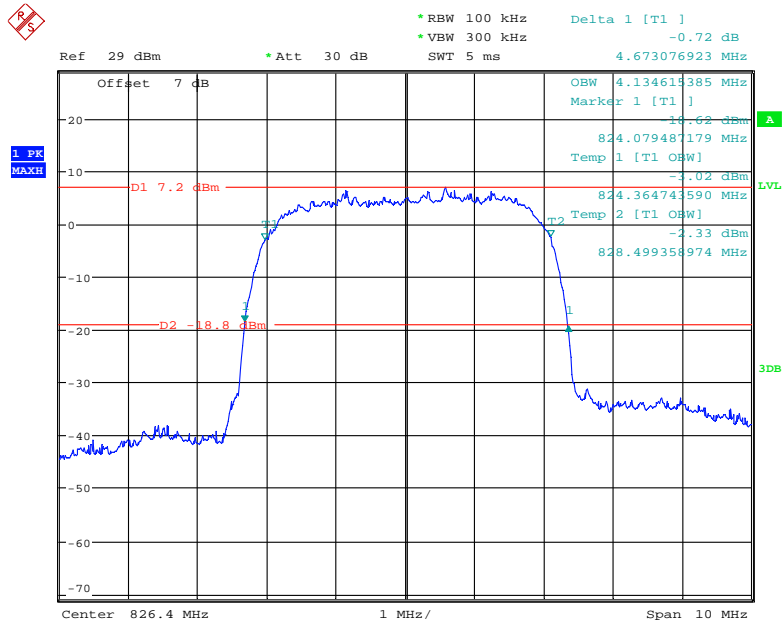

Date: 5.MAY.2021 17:07:32

**26 dB Emissions & 99% Occupied Bandwidth for RMC (BPSK) Mode, Middle channel**

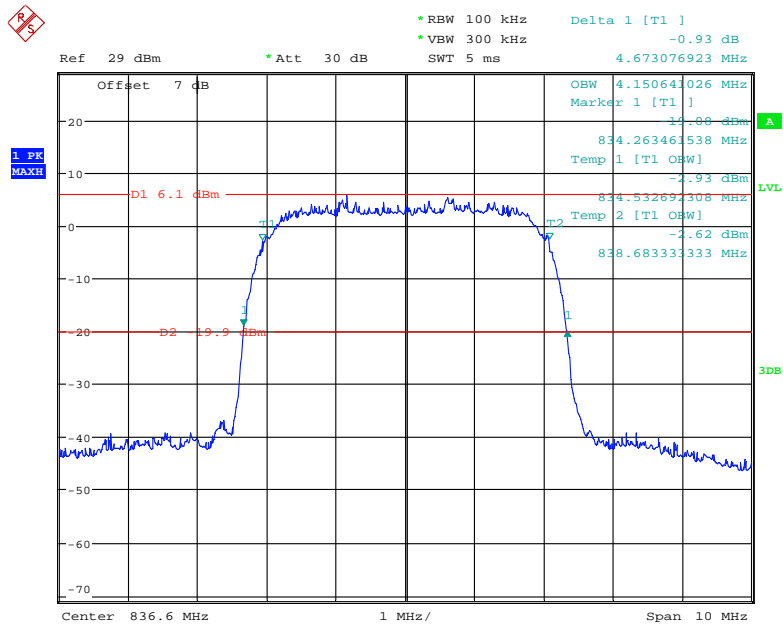

Date: 5.MAY.2021 17:09:44

**26 dB Emissions & 99% Occupied Bandwidth for RMC (BPSK) Mode, High channel**

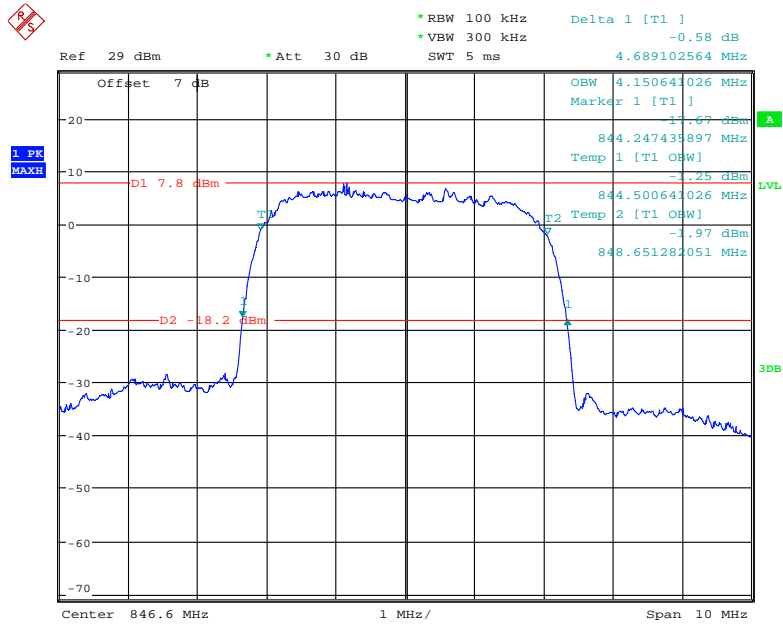

Date: 5.MAY.2021 17:12:35

**26 dB Emissions & 99% Occupied Bandwidth for HSUPA (BPSK) Mode, Low channel**

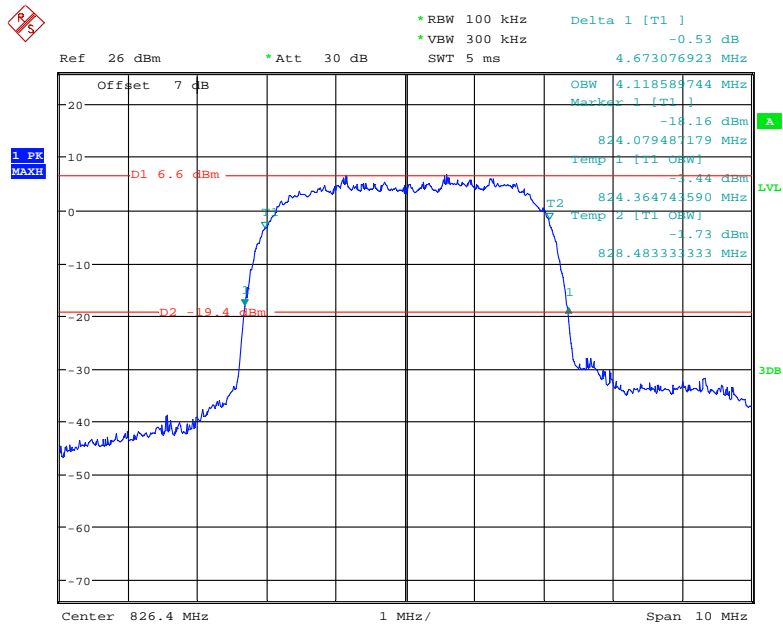

Date: 5.MAY.2021 18:46:54

**26 dB Emissions & 99% Occupied Bandwidth for HSUPA (BPSK) Mode, Middle channel**

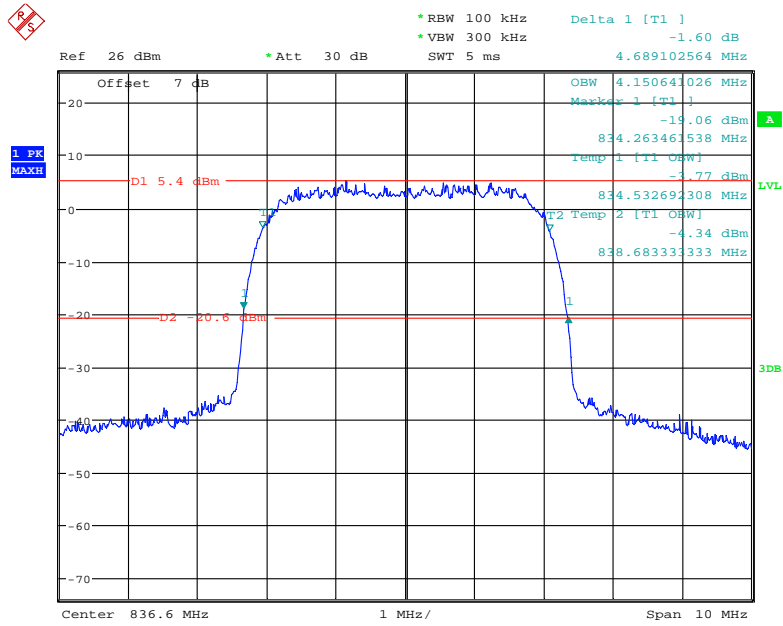

Date: 5.MAY.2021 18:48:16

**26 dB Emissions & 99% Occupied Bandwidth for HSUPA (BPSK) Mode, High channel**

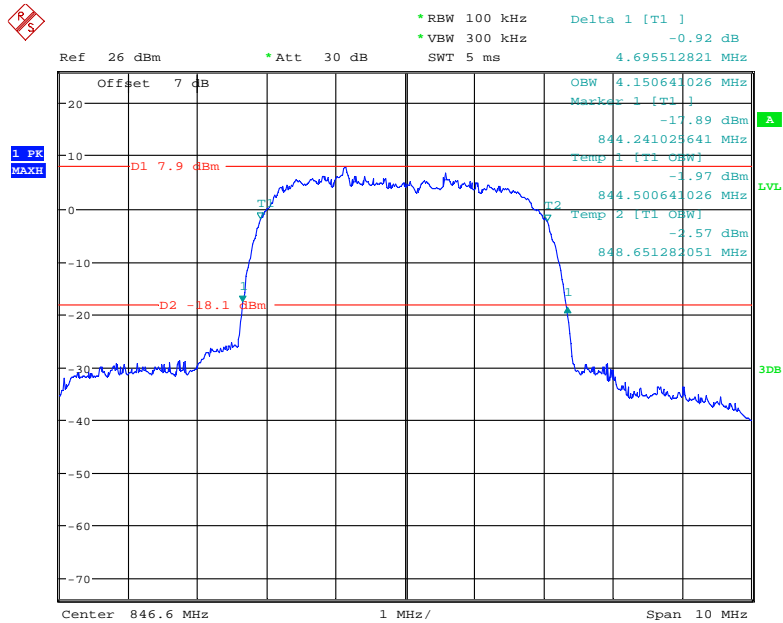

Date: 5.MAY.2021 18:49:58

**26 dB Emissions & 99% Occupied Bandwidth for HSDPA (16QAM) Mode, Low channel**

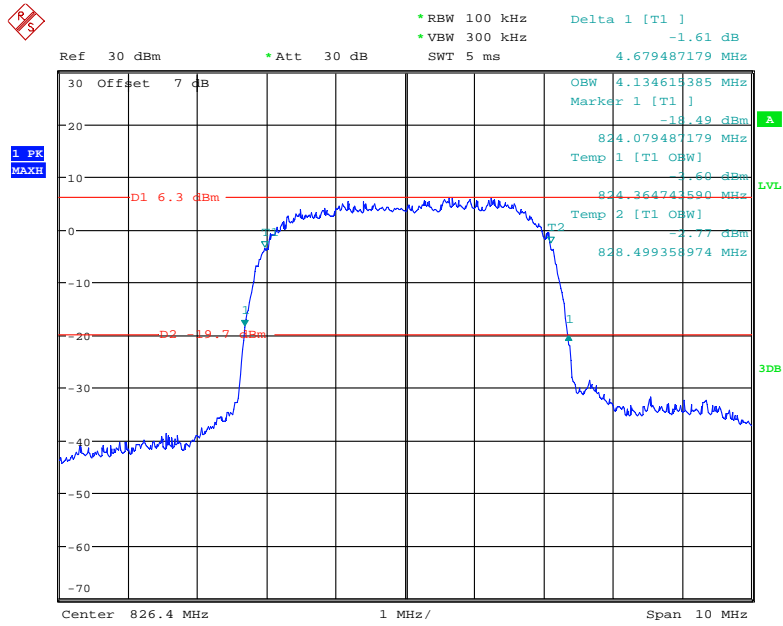

Date: 5.MAY.2021 18:18:56

**26 dB Emissions & 99% Occupied Bandwidth for HSDPA (16QAM) Mode, Middle channel**

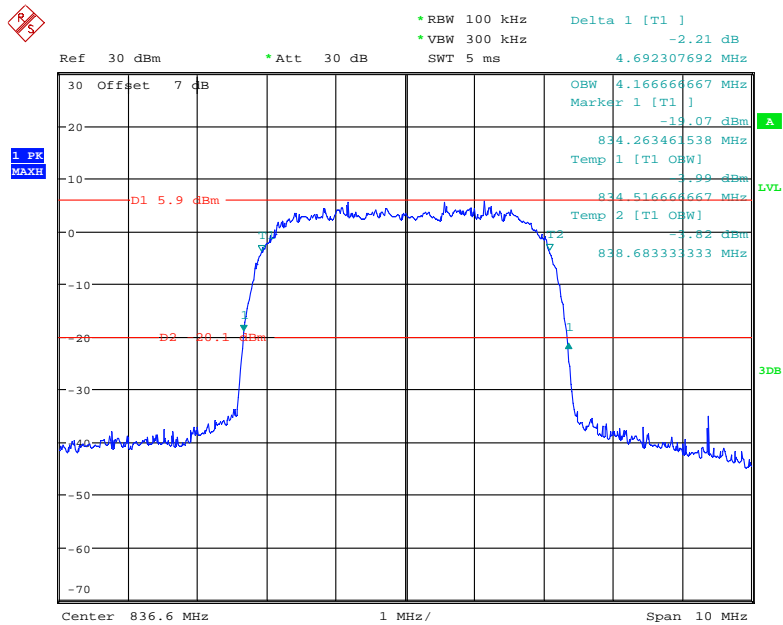

Date: 5.MAY.2021 18:16:06

26 dB Emissions & 99% Occupied Bandwidth for HSDPA (16QAM) Mode, High channel

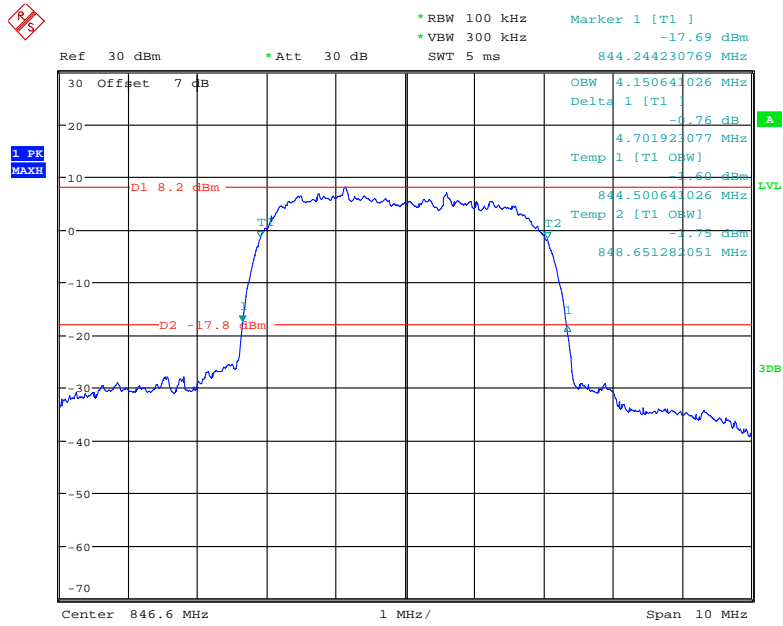

Date: 5.MAY.2021 18:12:58

PCS Band (Part 24E)

26 dB Emissions & 99% Occupied Bandwidth for GSM (GMSK) Mode, Low channel

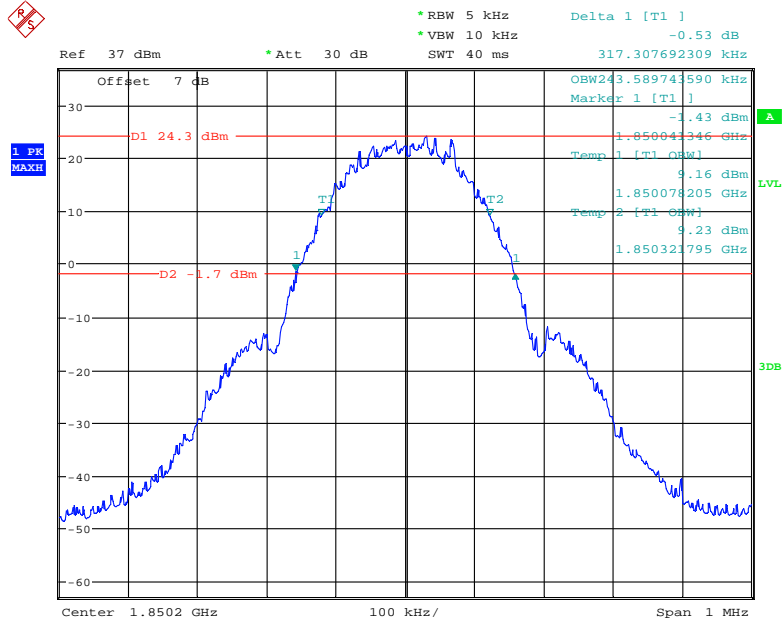

Date: 5.MAY.2021 10:33:17

26 dB Emissions & 99% Occupied Bandwidth for GSM (GMSK) Mode, Middle channel

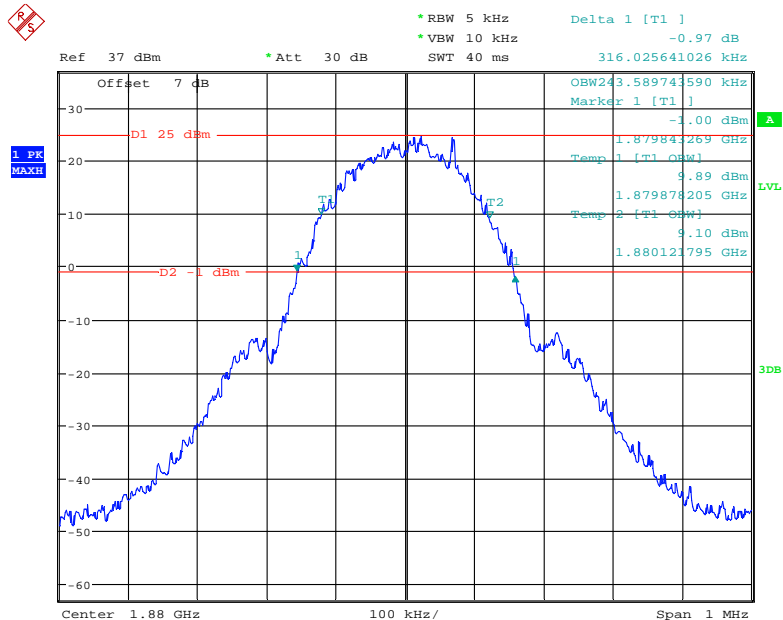

Date: 5.MAY.2021 10:34:41



**26 dB Emissions & 99% Occupied Bandwidth for GSM (GMSK) Mode, High channel**

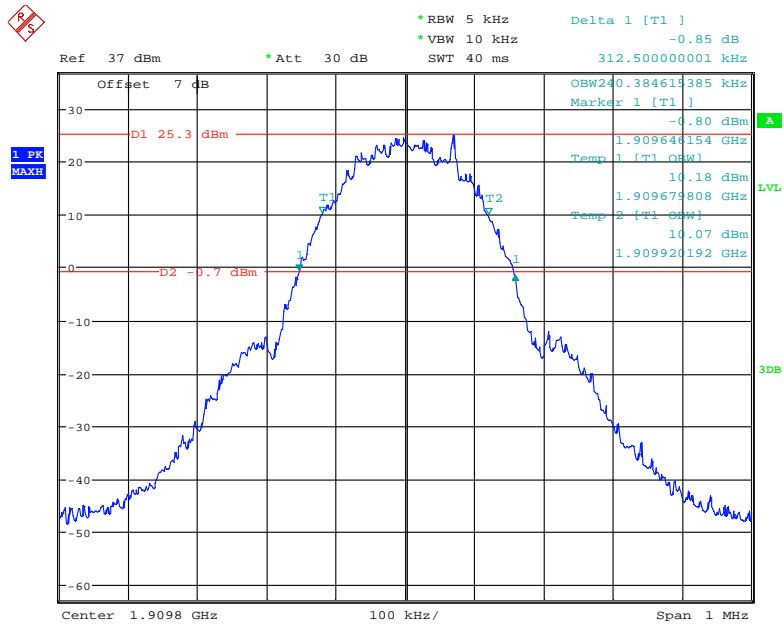

Date: 5.MAY.2021 10:36:43

**26 dB Emissions & 99% Occupied Bandwidth for EGPRS (8PSK) Mode, Low channel**

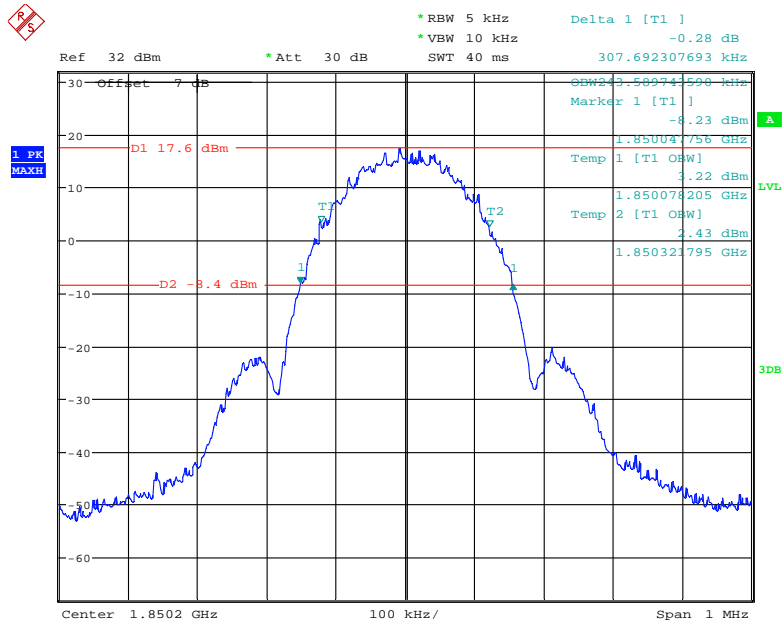

Date: 5.MAY.2021 10:30:36

**26 dB Emissions & 99% Occupied Bandwidth for EGPRS (8PSK) Mode, Middle channel**

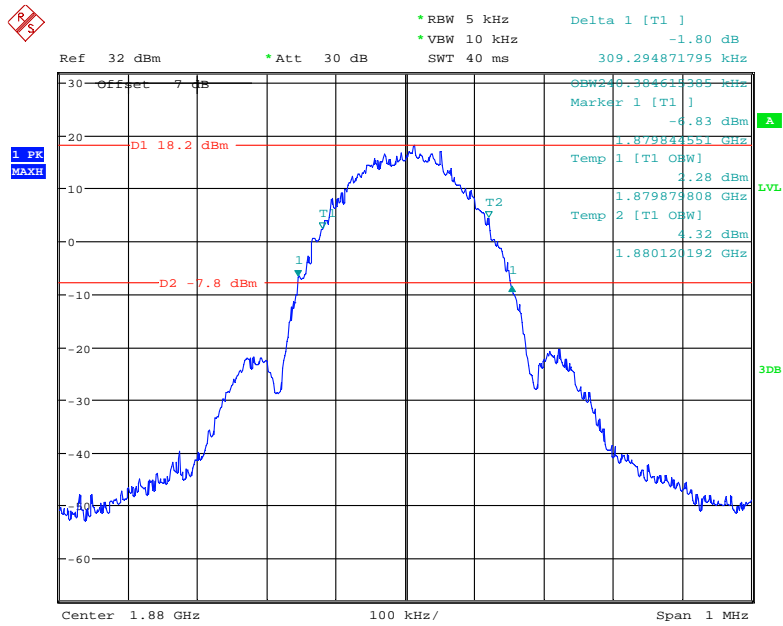

Date: 5.MAY.2021 10:26:20

**26 dB Emissions & 99% Occupied Bandwidth for EGPRS (8PSK) Mode, High channel**

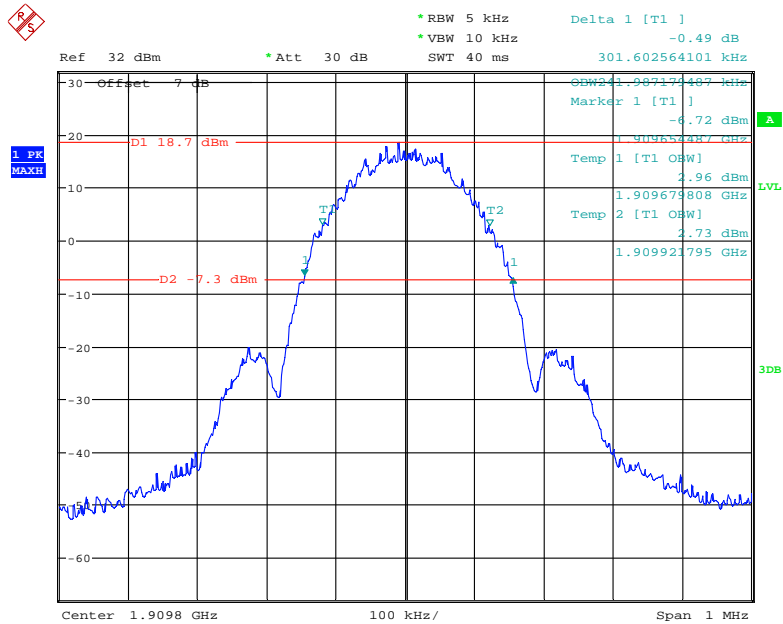

Date: 5.MAY.2021 10:28:03

**26 dB Emissions & 99% Occupied Bandwidth for RMC (BPSK) Mode, Low channel**

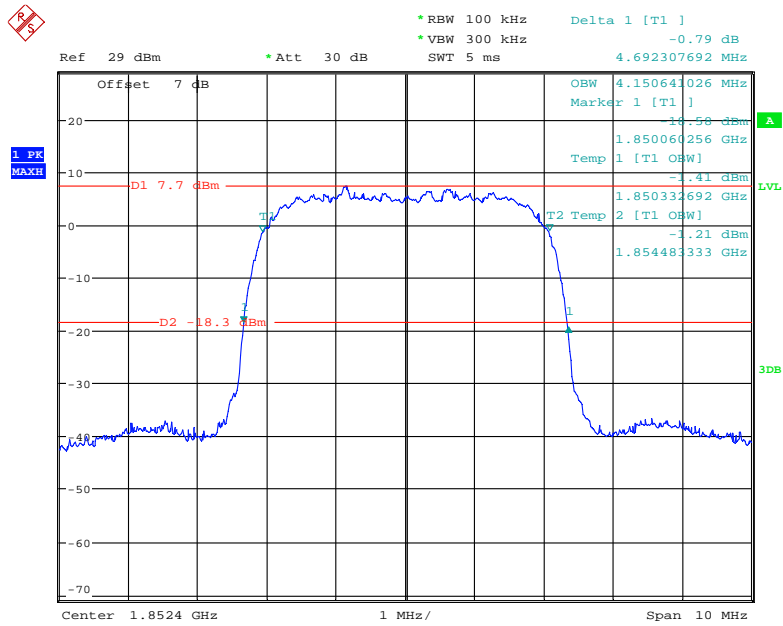

Date: 5.MAY.2021 17:03:22

**26 dB Emissions & 99% Occupied Bandwidth for RMC (BPSK) Mode, Middle channel**

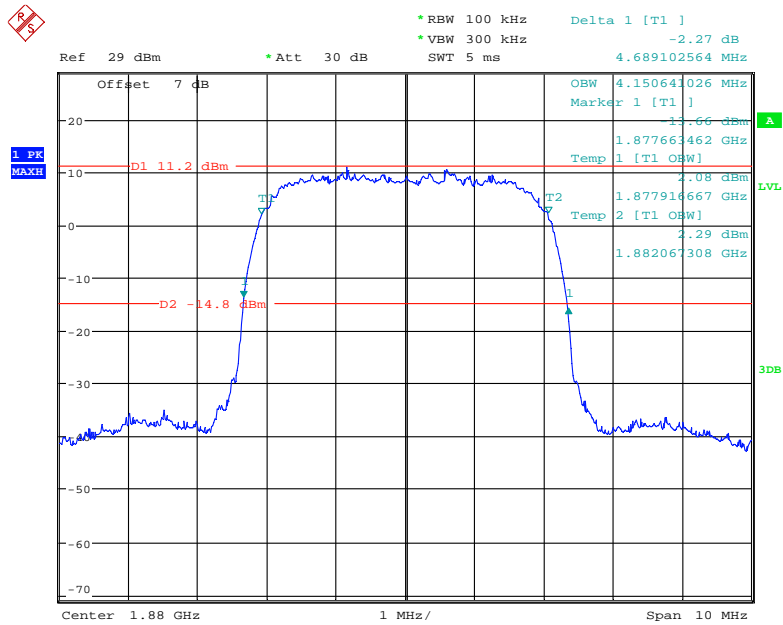

Date: 5.MAY.2021 17:04:45

**26 dB Emissions & 99% Occupied Bandwidth for RMC (BPSK) Mode, High channel**

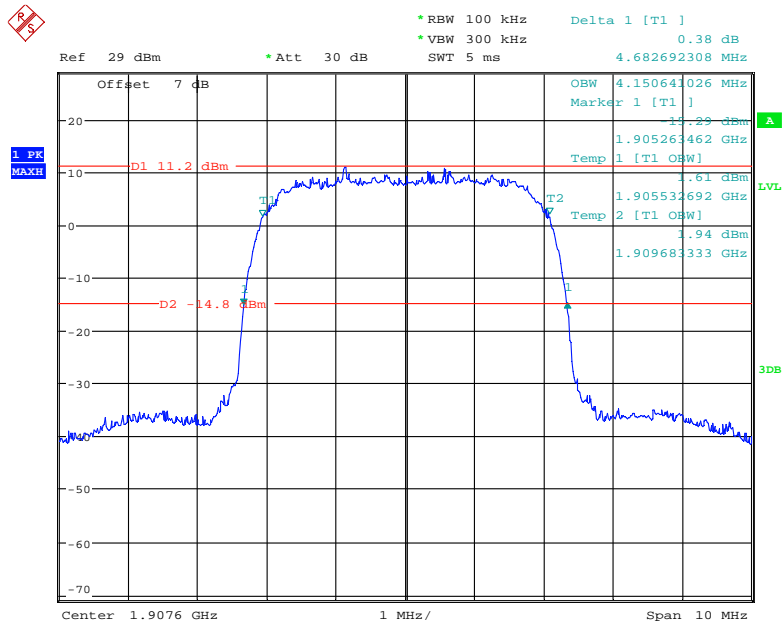

Date: 5.MAY.2021 17:06:01

**26 dB Emissions & 99% Occupied Bandwidth for HSUPA (BPSK) Mode, Low channel**

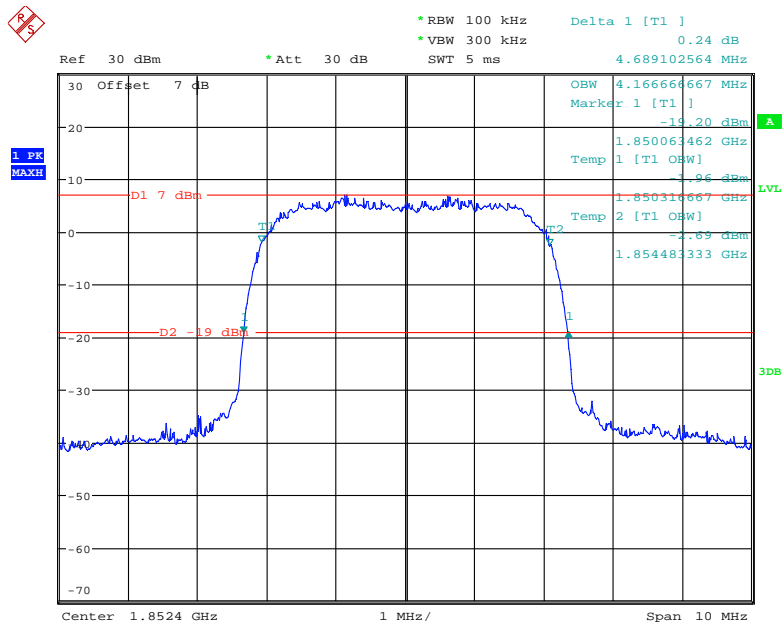

Date: 5.MAY.2021 18:38:55

**26 dB Emissions & 99% Occupied Bandwidth for HSUPA (BPSK) Mode, Middle channel**

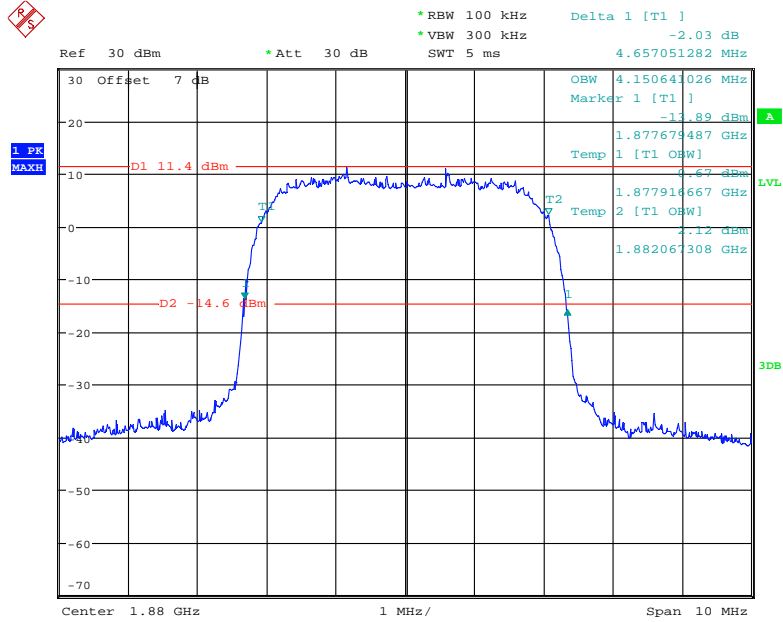

Date: 5.MAY.2021 18:40:21

**26 dB Emissions & 99% Occupied Bandwidth for HSUPA (BPSK) Mode, High channel**

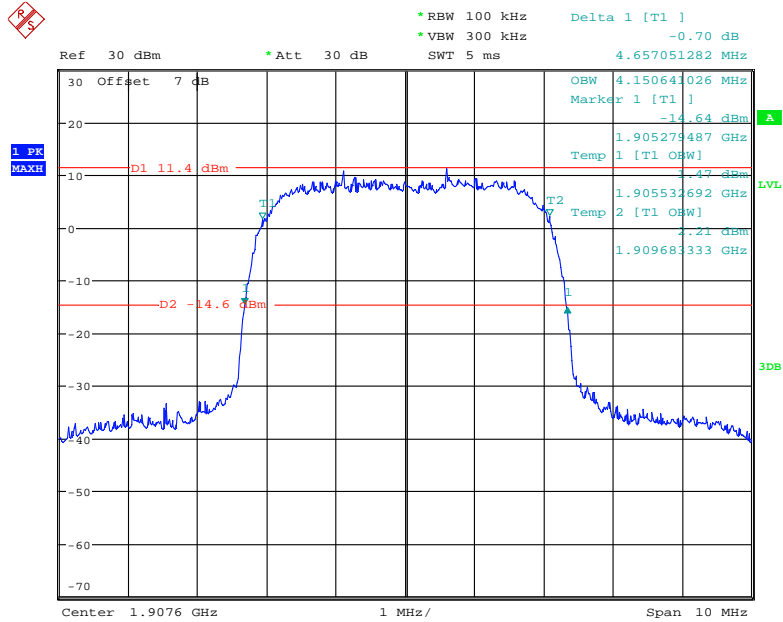

Date: 5.MAY.2021 18:41:11

**26 dB Emissions & 99% Occupied Bandwidth for HSDPA (16QAM) Mode, Low channel**

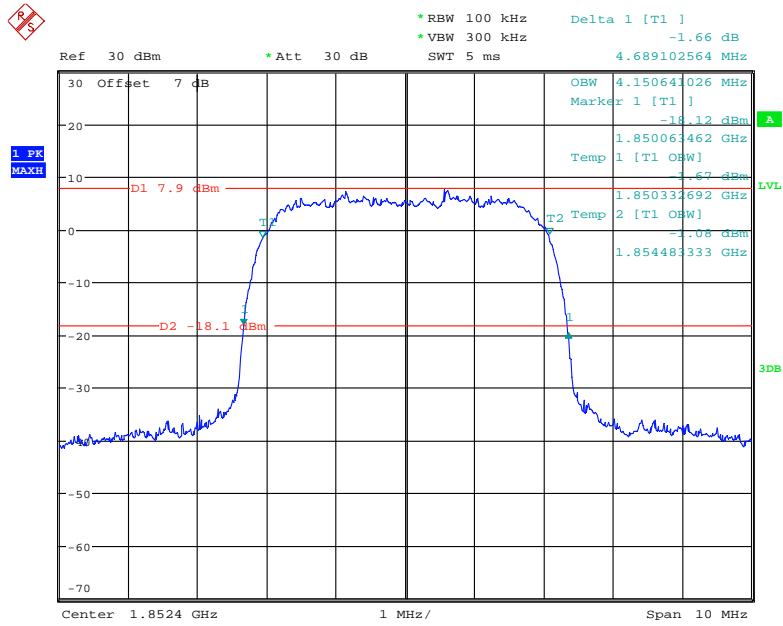

Date: 5.MAY.2021 18:34:30

**26 dB Emissions & 99% Occupied Bandwidth for HSDPA (16QAM) Mode, Middle channel**

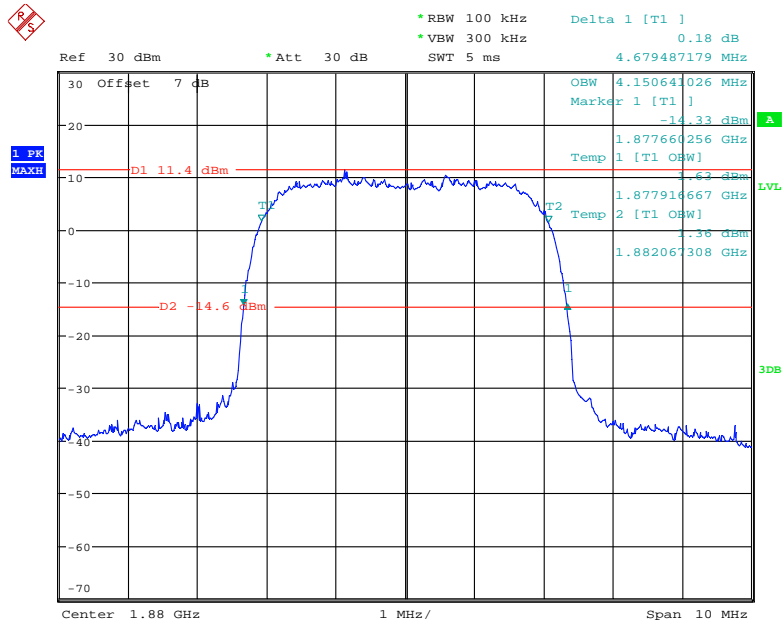

Date: 5.MAY.2021 18:31:58

26 dB Emissions & 99% Occupied Bandwidth for HSDPA (16QAM) Mode, High channel

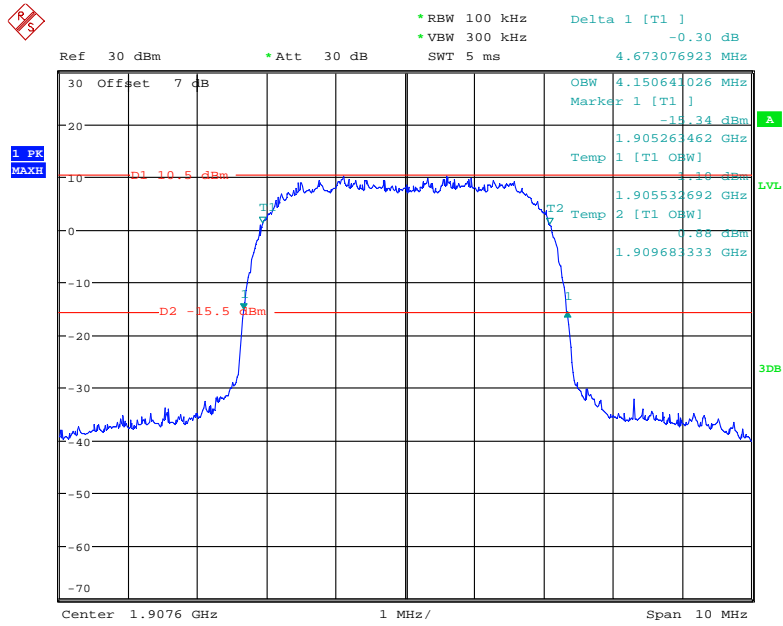

Date: 5.MAY.2021 18:26:14

**AWS Band (Part 27)**

**26 dB Emissions & 99% Occupied Bandwidth for RMC (BPSK) Mode, Low channel**

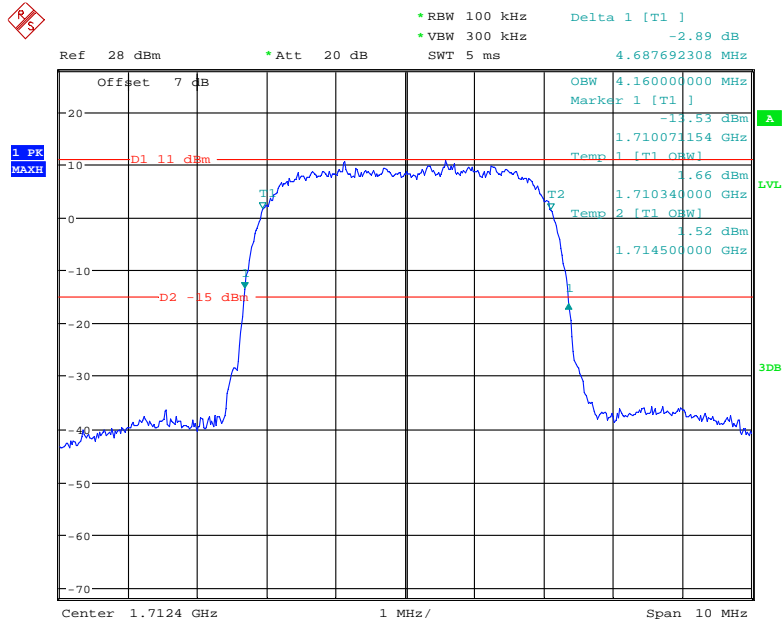

Date: 31.MAY.2021 18:02:46

**26 dB Emissions & 99% Occupied Bandwidth for RMC (BPSK) Mode, Middle channel**

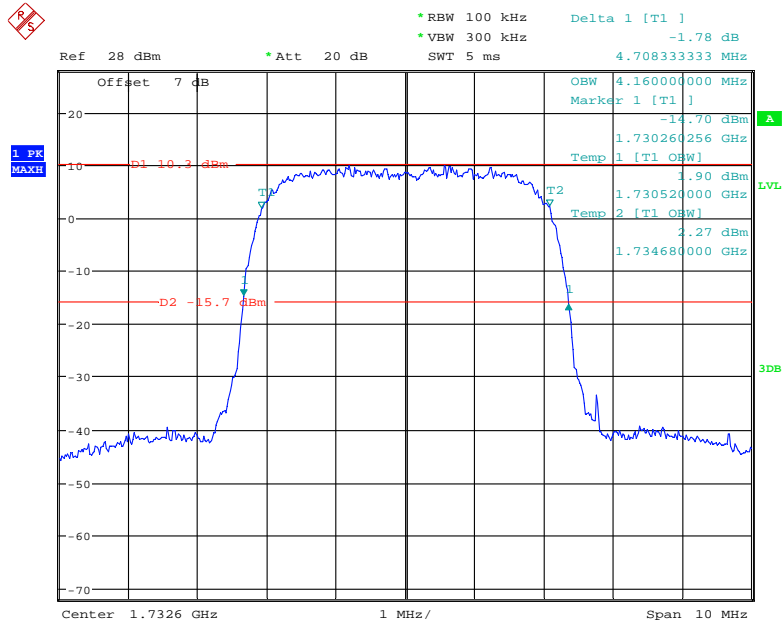

Date: 31.MAY.2021 18:05:25



**26 dB Emissions & 99% Occupied Bandwidth for RMC (BPSK) Mode, High channel**

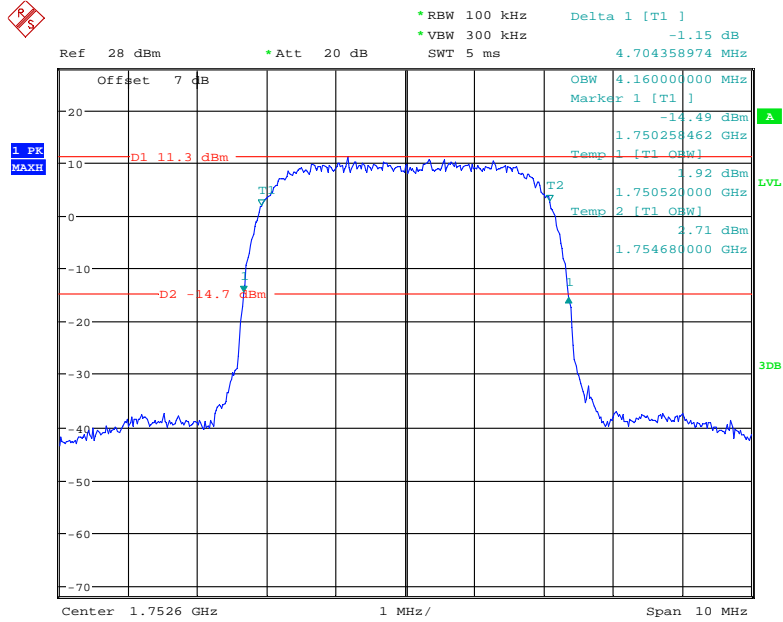

Date: 31.MAY.2021 18:09:15

**26 dB Emissions & 99% Occupied Bandwidth for HSUPA (BPSK) Mode, Low channel**

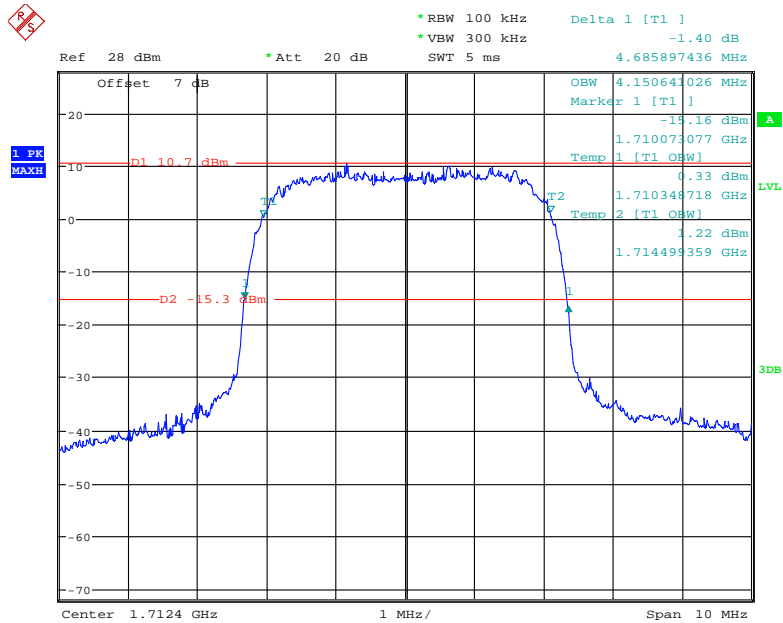

Date: 31.MAY.2021 18:37:36

**26 dB Emissions & 99% Occupied Bandwidth for HSUPA (BPSK) Mode, Middle channel**

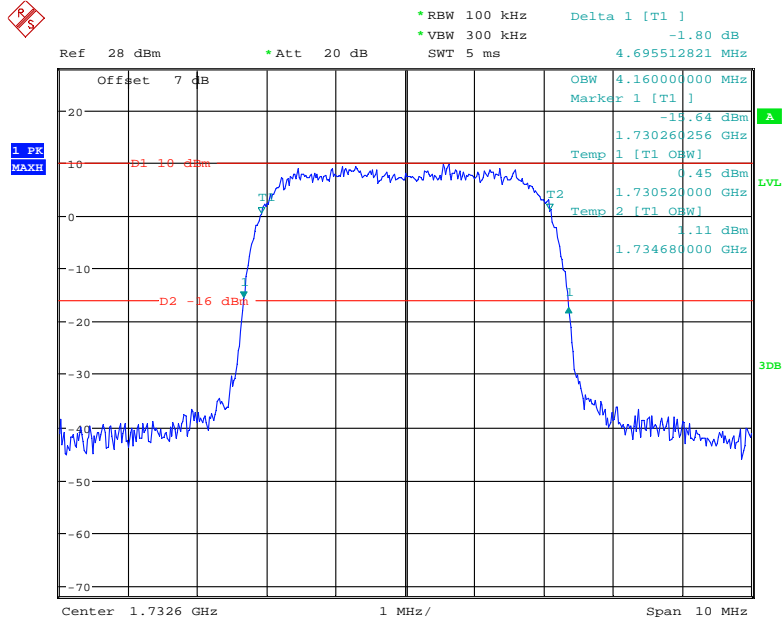

Date: 31.MAY.2021 18:31:33

**26 dB Emissions & 99% Occupied Bandwidth for HSUPA (BPSK) Mode, High channel**

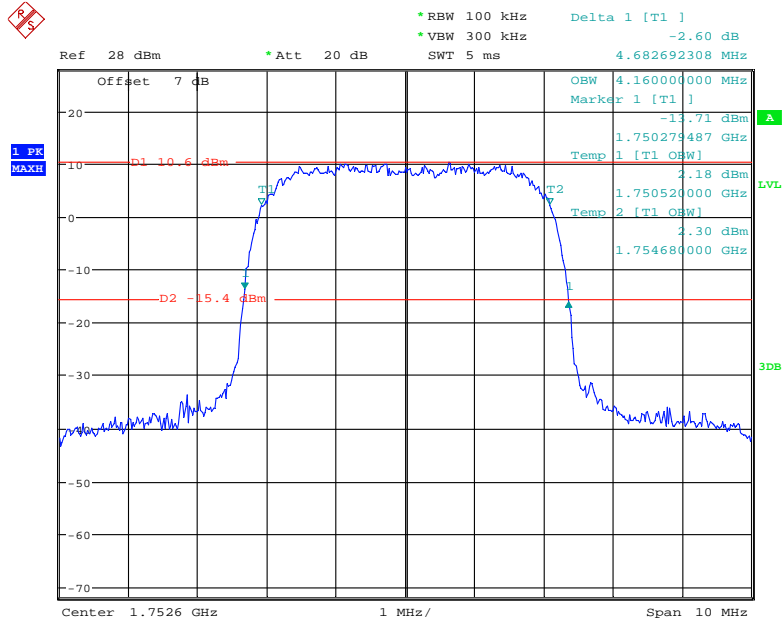

Date: 31.MAY.2021 18:29:46

**26 dB Emissions & 99% Occupied Bandwidth for HSDPA (16QAM) Mode, Low channel**

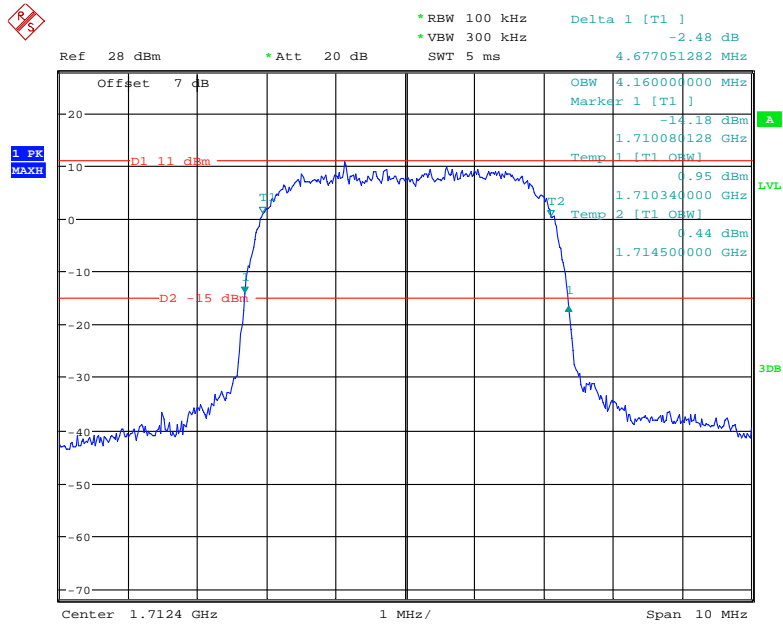

Date: 31.MAY.2021 18:25:41

**26 dB Emissions & 99% Occupied Bandwidth for HSDPA (16QAM) Mode, Middle channel**

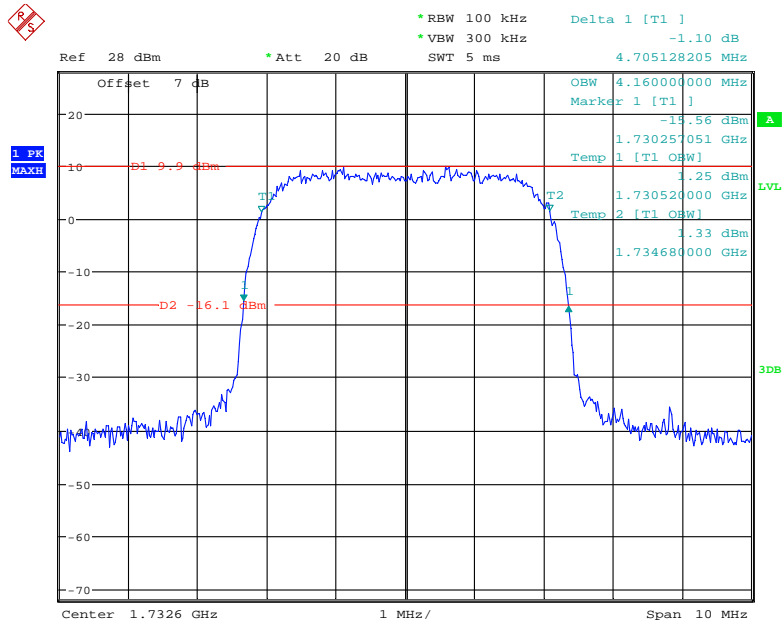

Date: 31.MAY.2021 18:27:02

26 dB Emissions & 99% Occupied Bandwidth for HSDPA (16QAM) Mode, High channel

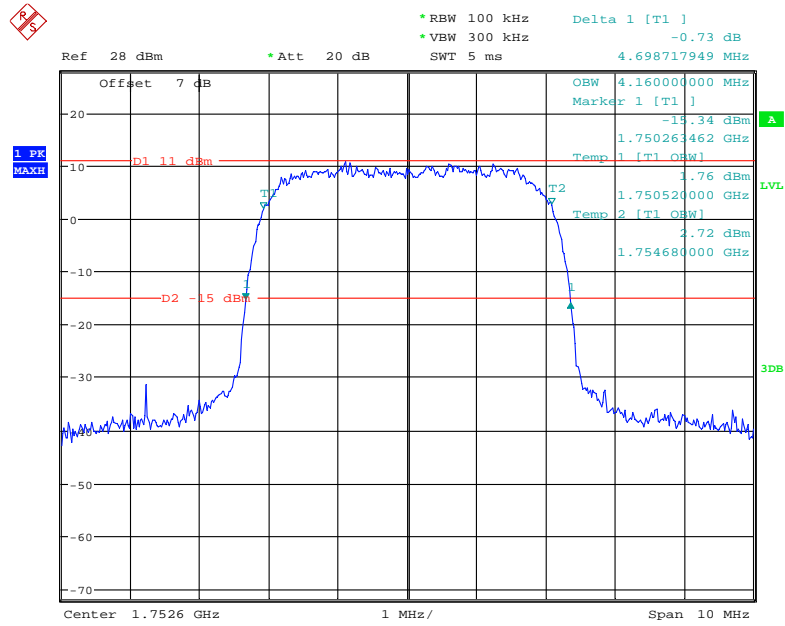

Date: 31.MAY.2021 18:28:31

**LTE Band 2:**

Bandwidth (MHz)	Modulation	Channel	99% Occupied Bandwidth (MHz)	26 dB Emission Bandwidth (MHz)
1.4	QPSK	Low	1.104	1.260
		Middle	1.104	1.254
		High	1.098	1.260
	16QAM	Low	1.110	1.266
		Middle	1.098	1.254
		High	1.104	1.254
3	QPSK	Low	2.700	2.988
		Middle	2.712	3.024
		High	2.688	3.024
	16QAM	Low	2.700	3.024
		Middle	2.700	2.988
		High	2.700	3.024
5	QPSK	Low	4.540	5.000
		Middle	4.540	5.020
		High	4.520	4.960
	16QAM	Low	4.520	4.980
		Middle	4.540	5.000
		High	4.520	4.980
10	QPSK	Low	9.000	9.760
		Middle	8.960	9.680
		High	8.960	9.800
	16QAM	Low	9.000	9.680
		Middle	8.960	9.760
		High	8.960	9.760
15	QPSK	Low	13.620	15.120
		Middle	13.500	14.940
		High	13.560	15.060
	16QAM	Low	13.560	14.940
		Middle	13.560	15.000
		High	13.560	15.000
20	QPSK	Low	18.000	19.600
		Middle	18.000	19.680
		High	18.080	19.760
	16QAM	Low	18.080	19.680
		Middle	18.000	19.680
		High	18.080	19.840

**Band 4:**

Bandwidth (MHz)	Modulation	Channel	99% Occupied Bandwidth (MHz)	26 dB Emission Bandwidth (MHz)
1.4	QPSK	Low	1.104	1.260
		Middle	1.104	1.254
		High	1.104	1.254
	16QAM	Low	1.116	1.254
		Middle	1.092	1.248
		High	1.104	1.254
3	QPSK	Low	2.700	2.988
		Middle	2.700	3.012
		High	2.700	3.012
	16QAM	Low	2.700	3.012
		Middle	2.700	3.012
		High	2.700	3.024
5	QPSK	Low	4.540	4.980
		Middle	4.520	4.980
		High	4.500	4.980
	16QAM	Low	4.500	4.960
		Middle	4.540	5.040
		High	4.540	5.000
10	QPSK	Low	8.960	9.760
		Middle	8.960	9.760
		High	8.960	9.800
	16QAM	Low	8.920	9.640
		Middle	9.000	9.880
		High	9.000	9.800
15	QPSK	Low	13.500	14.940
		Middle	13.500	15.000
		High	13.620	15.180
	16QAM	Low	13.560	15.060
		Middle	13.620	15.120
		High	13.560	15.120
20	QPSK	Low	17.920	19.520
		Middle	18.000	19.600
		High	18.160	19.920
	16QAM	Low	18.000	19.600
		Middle	18.000	19.680
		High	18.080	19.760

**Band 5:**

Bandwidth (MHz)	Modulation	Channel	99% Occupied Bandwidth (MHz)	26 dB Emission Bandwidth (MHz)
1.4	QPSK	Low	1.104	1.254
		Middle	1.098	1.266
		High	1.110	1.272
	16QAM	Low	1.110	1.260
		Middle	1.098	1.260
		High	1.110	1.254
3	QPSK	Low	2.700	2.988
		Middle	2.700	3.000
		High	2.700	3.024
	16QAM	Low	2.700	3.012
		Middle	2.688	3.012
		High	2.700	3.036
5	QPSK	Low	4.520	4.940
		Middle	4.520	5.000
		High	4.520	4.960
	16QAM	Low	4.500	4.960
		Middle	4.540	5.000
		High	4.520	5.060
10	QPSK	Low	8.920	9.680
		Middle	9.000	9.760
		High	8.920	9.720
	16QAM	Low	8.920	9.720
		Middle	9.000	9.800
		High	8.920	9.680

**Band 7**

Bandwidth (MHz)	Modulation	Channel	99% Occupied Bandwidth (MHz)	26 dB Emission Bandwidth (MHz)
5	QPSK	Low	4.520	5.000
		Middle	4.540	4.980
		High	4.520	4.960
	16QAM	Low	4.520	5.000
		Middle	4.540	5.000
		High	4.540	5.000
10	QPSK	Low	9.000	9.760
		Middle	8.960	9.760
		High	8.960	9.760
	16QAM	Low	9.000	9.720
		Middle	8.960	9.720
		High	8.960	9.760
15	QPSK	Low	13.560	14.940
		Middle	13.560	14.880
		High	13.500	15.000
	16QAM	Low	13.620	15.000
		Middle	13.620	15.000
		High	13.500	15.120
20	QPSK	Low	18.000	19.520
		Middle	18.080	19.600
		High	18.000	19.600
	16QAM	Low	18.000	19.600
		Middle	18.000	19.760
		High	18.000	19.680



**Band 17**

Bandwidth (MHz)	Modulation	Channel	99% Occupied Bandwidth (MHz)	26 dB Emission Bandwidth (MHz)
5	QPSK	Low	4.480	4.900
		Middle	4.540	4.980
		High	4.520	4.960
	16QAM	Low	4.460	4.920
		Middle	4.540	4.980
		High	4.560	5.020
10	QPSK	Low	8.920	9.600
		Middle	8.960	9.680
		High	9.040	9.840
	16QAM	Low	8.880	9.560
		Middle	8.960	9.640
		High	9.040	9.800

**LTE Band 38:**

Bandwidth (MHz)	Modulation	Channel	99% Occupied Bandwidth (MHz)	26 dB Emission Bandwidth (MHz)
5	QPSK	Low	4.500	5.040
		Middle	4.520	4.980
		High	4.520	4.980
	16QAM	Low	4.500	4.960
		Middle	4.520	5.040
		High	4.520	5.040
10	QPSK	Low	8.960	9.720
		Middle	8.960	9.800
		High	8.960	9.760
	16QAM	Low	8.960	9.800
		Middle	8.960	9.800
		High	8.960	9.840
15	QPSK	Low	13.620	15.120
		Middle	13.500	15.000
		High	13.560	15.300
	16QAM	Low	13.560	15.060
		Middle	13.500	15.000
		High	13.560	15.000
20	QPSK	Low	18.000	19.520
		Middle	18.000	19.600
		High	18.080	19.680
	16QAM	Low	18.000	19.600
		Middle	18.000	19.520
		High	17.920	19.600

**LTE Band 41:**

Bandwidth (MHz)	Modulation	Channel	99% Occupied Bandwidth (MHz)	26 dB Emission Bandwidth (MHz)
5	QPSK	Low	4.520	4.980
		Middle	4.520	4.960
		High	4.520	5.020
	16QAM	Low	4.520	4.980
		Middle	4.520	5.000
		High	4.520	4.980
10	QPSK	Low	8.960	9.720
		Middle	8.960	9.840
		High	8.960	9.800
	16QAM	Low	8.960	9.720
		Middle	8.960	9.720
		High	8.960	9.800
15	QPSK	Low	13.560	15.120
		Middle	13.500	15.120
		High	13.500	15.120
	16QAM	Low	13.560	14.940
		Middle	13.620	15.120
		High	13.560	15.000
20	QPSK	Low	18.000	19.600
		Middle	18.000	19.600
		High	18.000	19.760
	16QAM	Low	17.920	19.680
		Middle	18.000	19.520
		High	18.000	19.760

**LTE Band 66**

Bandwidth (MHz)	Modulation	Channel	99% Occupied Bandwidth (MHz)	26 dB Emission Bandwidth (MHz)
1.4	QPSK	Low	1.098	1.248
		Middle	1.104	1.260
		High	1.110	1.254
	16QAM	Low	1.110	1.260
		Middle	1.098	1.254
		High	1.104	1.254
3	QPSK	Low	2.700	2.988
		Middle	2.712	3.012
		High	2.700	3.012
	16QAM	Low	2.688	3.024
		Middle	2.688	3.012
		High	2.700	3.012
5	QPSK	Low	4.520	4.980
		Middle	4.520	5.000
		High	4.520	5.000
	16QAM	Low	4.520	4.980
		Middle	4.560	5.020
		High	4.520	5.000
10	QPSK	Low	8.960	9.680
		Middle	8.960	9.720
		High	8.960	9.800
	16QAM	Low	9.000	9.640
		Middle	8.960	9.800
		High	8.960	9.840
15	QPSK	Low	13.500	15.060
		Middle	13.500	15.060
		High	13.560	15.180
	16QAM	Low	13.500	15.000
		Middle	13.620	15.060
		High	13.560	15.060
20	QPSK	Low	18.000	19.520
		Middle	18.000	19.680
		High	18.080	19.840
	16QAM	Low	17.920	19.680
		Middle	18.000	19.760
		High	18.000	19.680

The test plots of LTE band please refer to the Appendix A.

**FCC §2.1051, §22.917(a) & §24.238(a); §27.53 - SPURIOUS EMISSIONS AT ANTENNA TERMINALS**

**Applicable Standard**

FCC §2.1051, §22.917(a) and §24.238(a) and §27.53.

The spectrum was to be investigated to the tenth harmonics of the highest fundamental frequency as specified in § 2.1051.

**Test Procedure**

The RF output of the transceiver was connected to a spectrum analyzer and simulator through appropriate attenuation. The resolution bandwidth of the spectrum analyzer was set at 1MHz. Sufficient scans were taken to show any out of band emissions up to 10<sup>th</sup> harmonic.

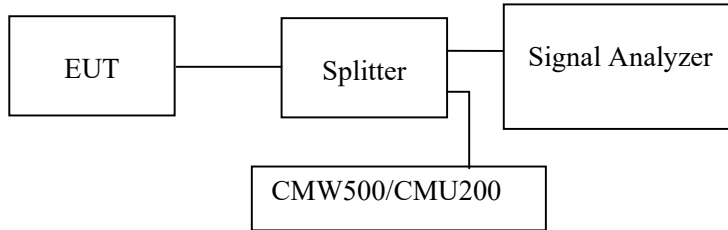

**Test Data**

**Environmental Conditions**

<b>Temperature:</b>	28.2~28.6 °C
<b>Relative Humidity:</b>	52~56 %
<b>ATM Pressure:</b>	100.9~101.0 kPa

*The testing was performed by Pedro Yun from 2021-05-04 to 2021-05-31.*

*EUT operation mode: Transmitting*

**Test result: Pass**

*Please refer to the following plots.*

**Cellular Band (Part 22H)**  
**Low Channel:**

**30 MHz – 1 GHz (GSM Mode)**

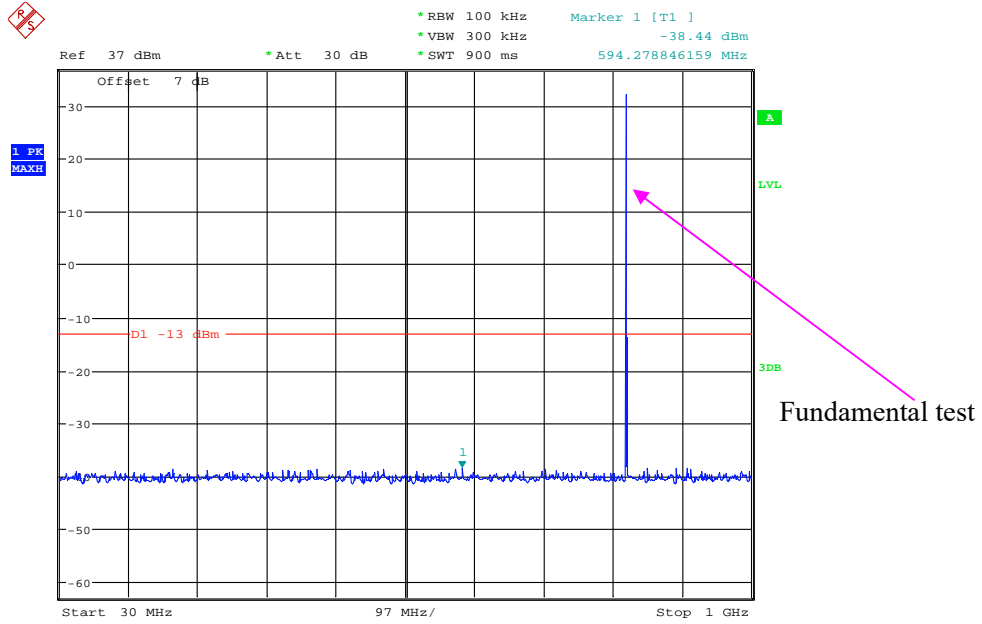

Date: 5.MAY.2021 09:58:20

**1 GHz – 10 GHz (GSM Mode)**

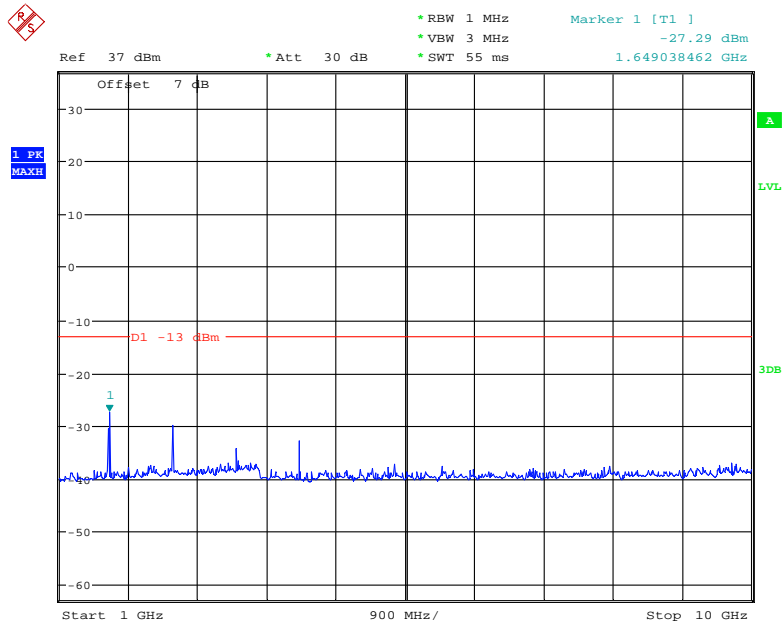

Date: 5.MAY.2021 09:59:15

### 30 MHz – 1 GHz (WCDMA Mode)

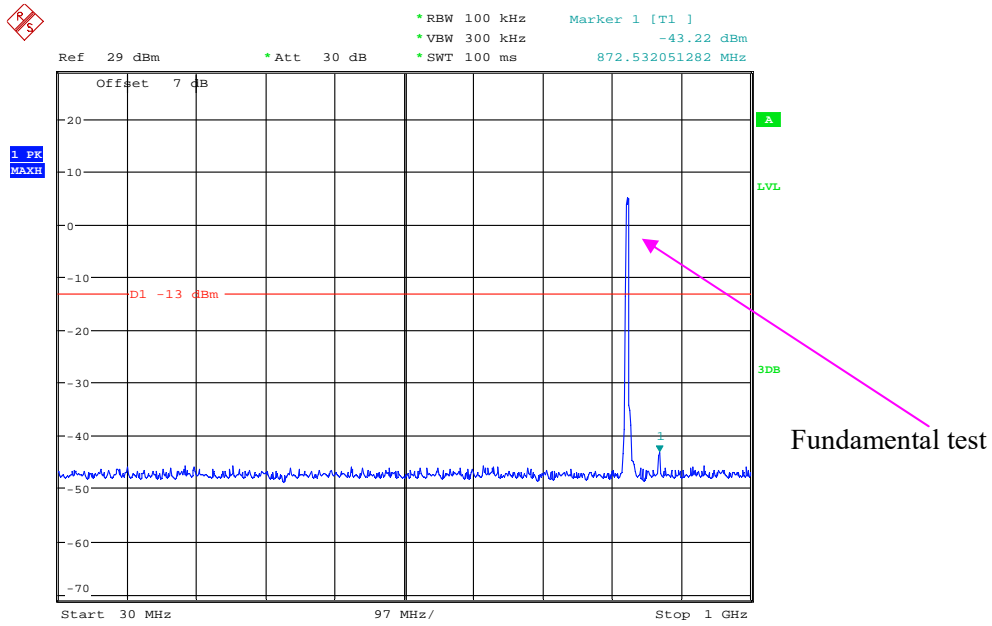

Date: 5.MAY.2021 17:27:55

### 1 GHz – 10 GHz (WCDMA Mode)

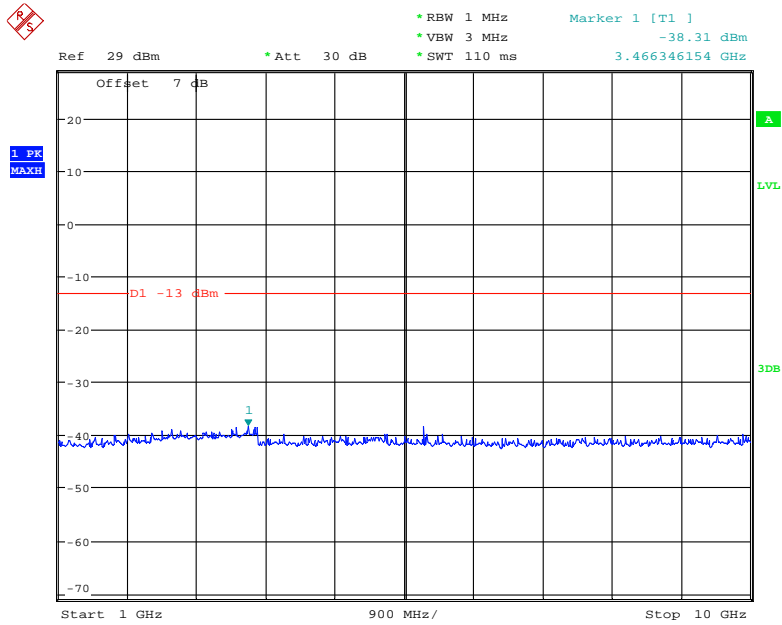

Date: 5.MAY.2021 17:32:01

Middle Channel:

30 MHz – 1 GHz (GSM Mode)

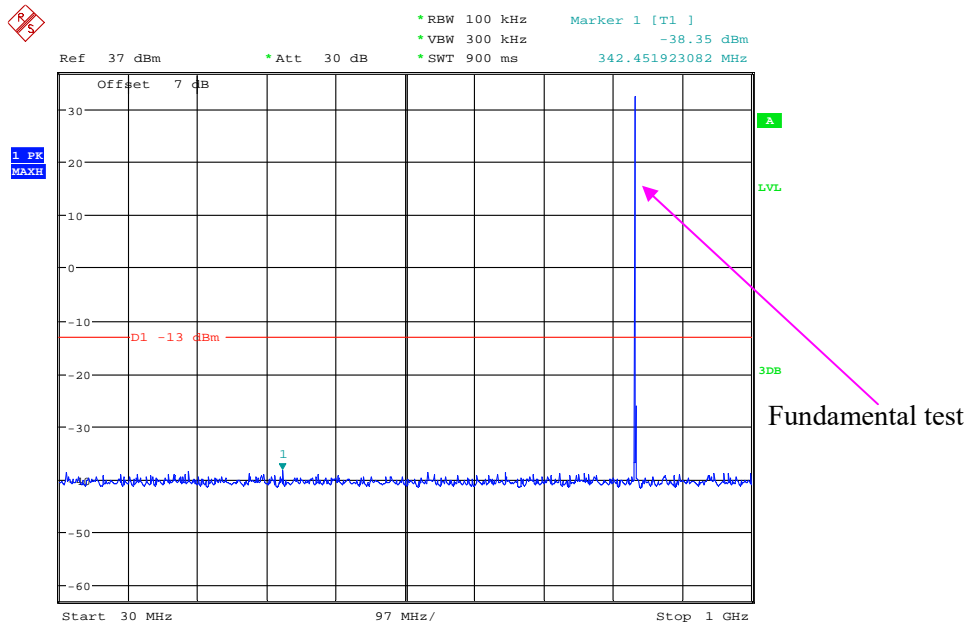

Date: 5.MAY.2021 09:57:35

1 GHz – 10 GHz (GSM Mode)

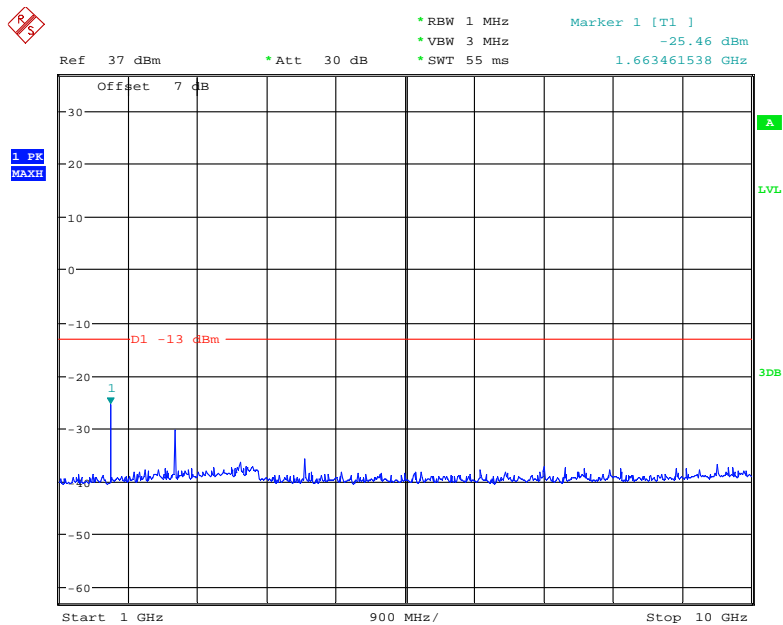

Date: 5.MAY.2021 09:59:52

### 30 MHz – 1 GHz (WCDMA Mode)

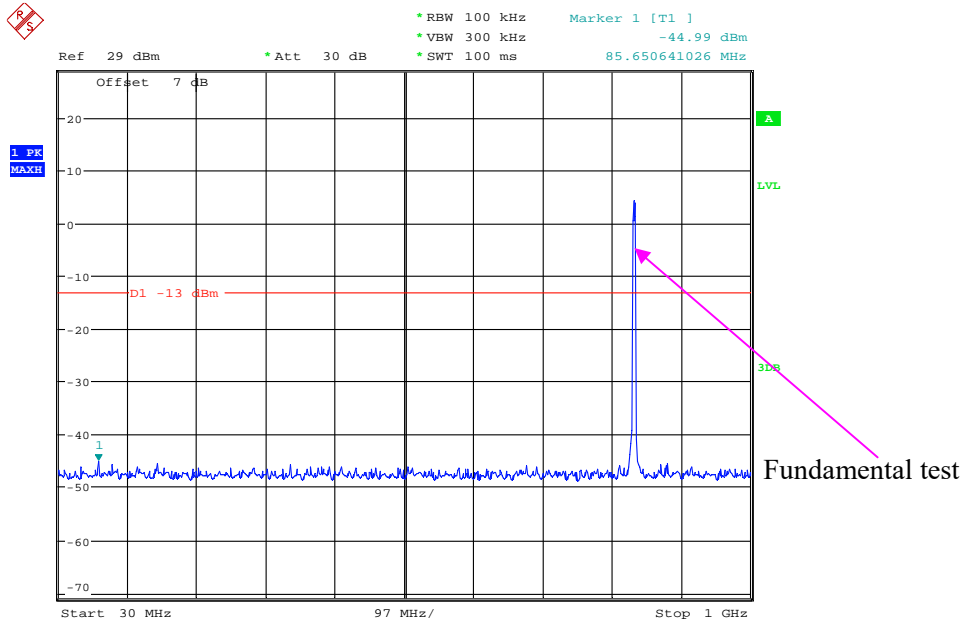

Date: 5.MAY.2021 17:29:16

### 1 GHz – 10 GHz (WCDMA Mode)

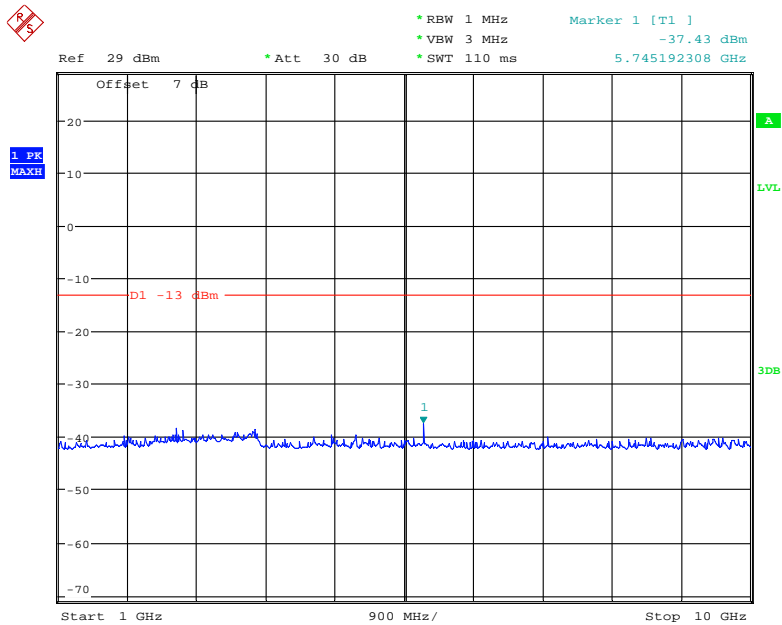

Date: 5.MAY.2021 17:31:18



High Channel:

30 MHz – 1 GHz (WCDMA Mode)

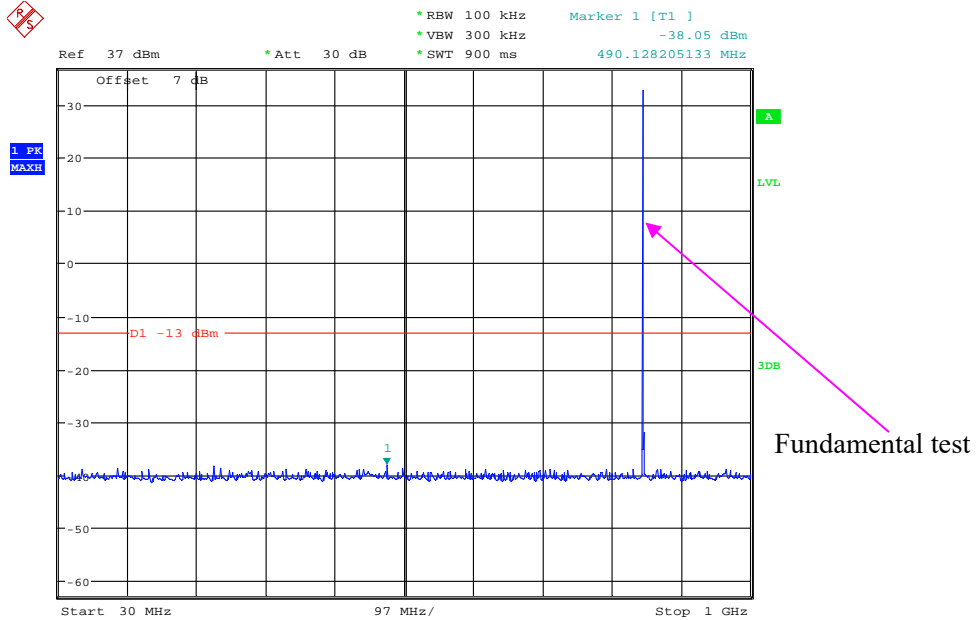

Date: 5.MAY.2021 09:56:18

1 GHz – 10 GHz (WCDMA Mode)

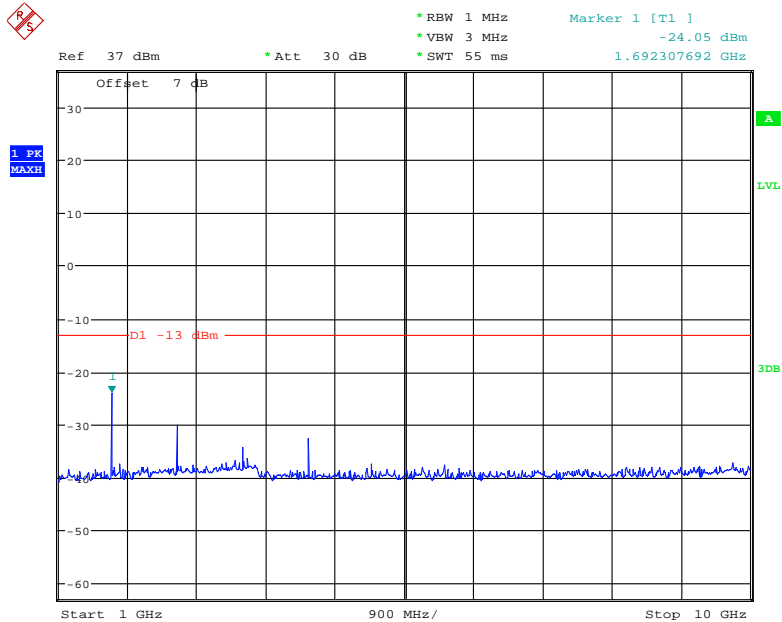

Date: 5.MAY.2021 10:00:24

### 30 MHz – 1 GHz (WCDMA Mode)

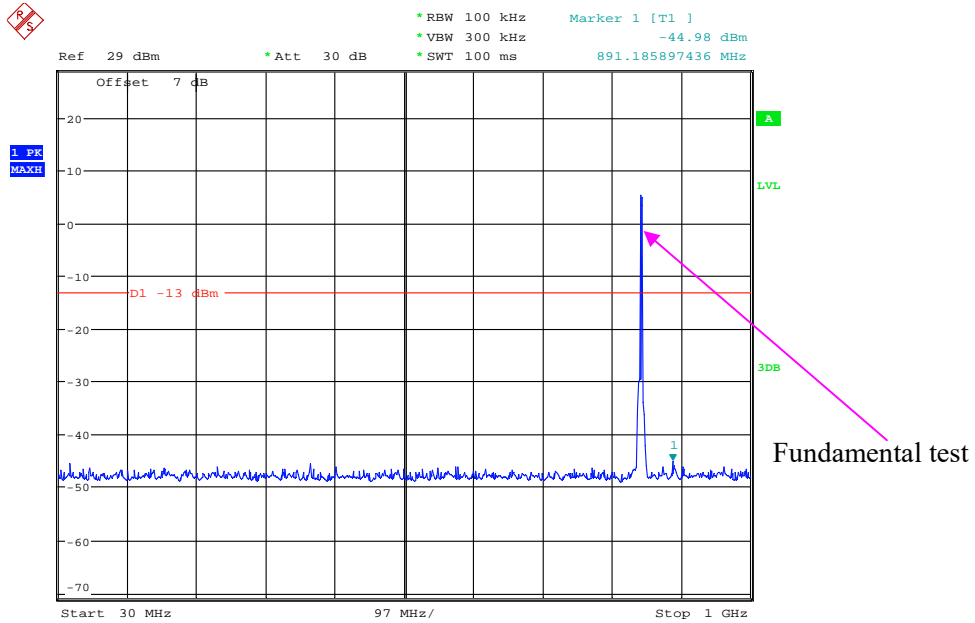

Date: 5.MAY.2021 17:29:50

### 1 GHz – 10 GHz (WCDMA Mode)

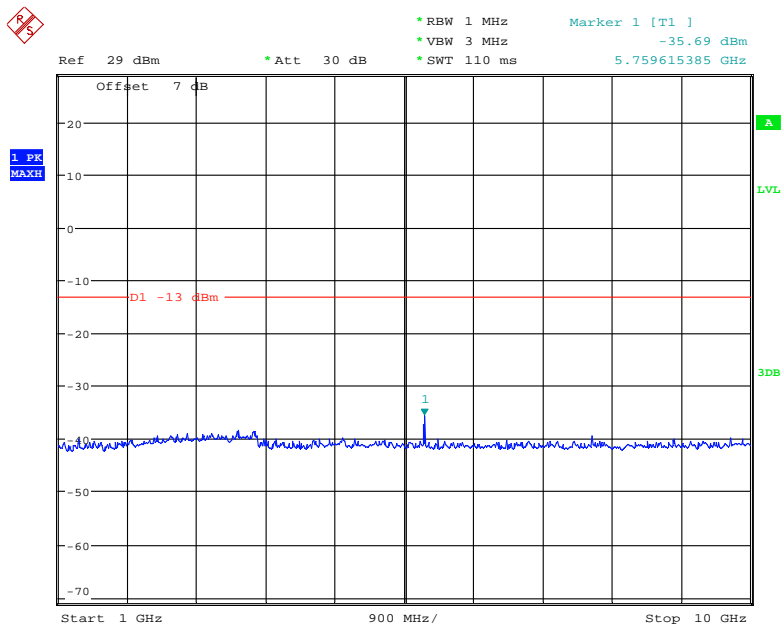

Date: 5.MAY.2021 17:30:52

PCS Band (Part 24E) Low Channel:

30 MHz – 1 GHz (GSM Mode)

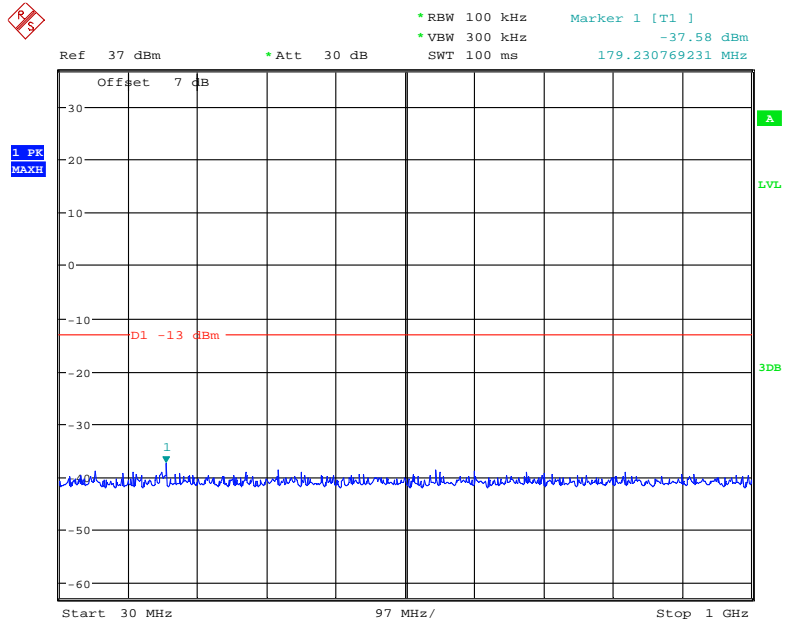

Date: 5.MAY.2021 10:42:06

1 GHz – 2GHz (GSM Mode)

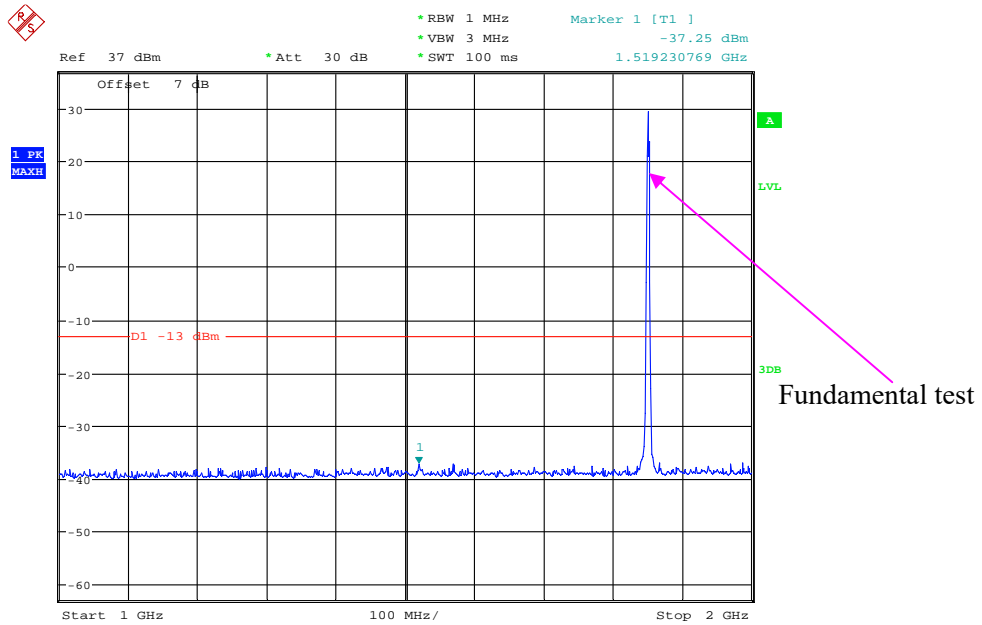

Date: 5.MAY.2021 10:43:15

### 2 GHz – 20 GHz (GSM Mode)

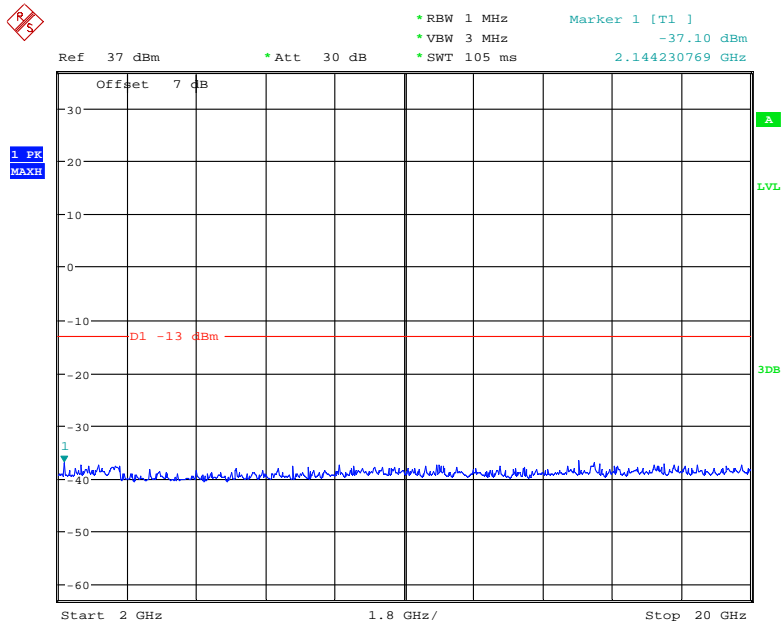

Date: 5.MAY.2021 10:46:18

### 30 MHz – 1 GHz (WCDMA Mode)

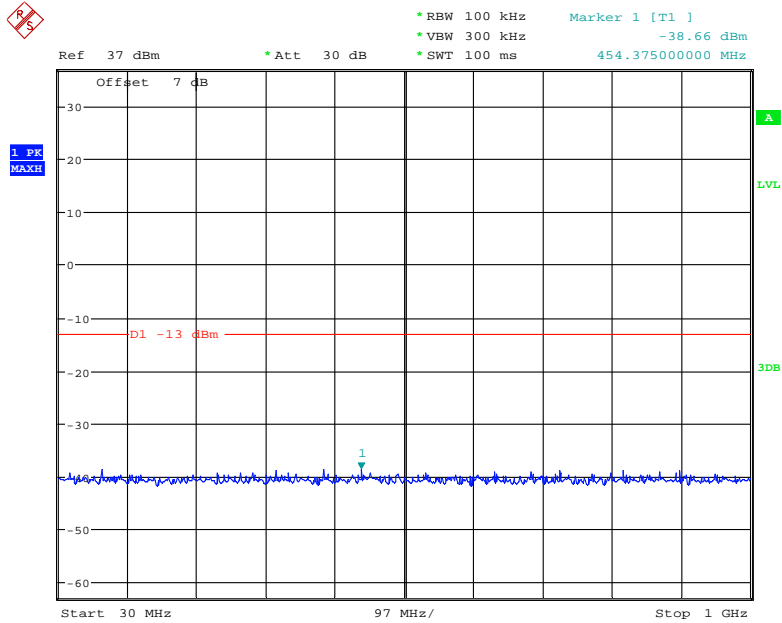

Date: 5.MAY.2021 17:42:11

### 1 GHz – 20 GHz (WCDMA Mode)

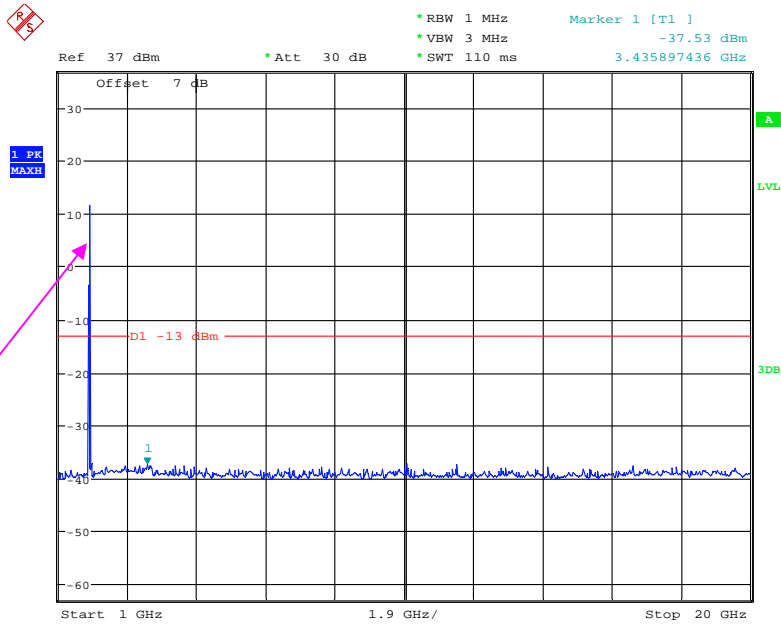

Date: 5.MAY.2021 17:46:20

### Middle Channel:

### 30 MHz – 1 GHz (GSM Mode)

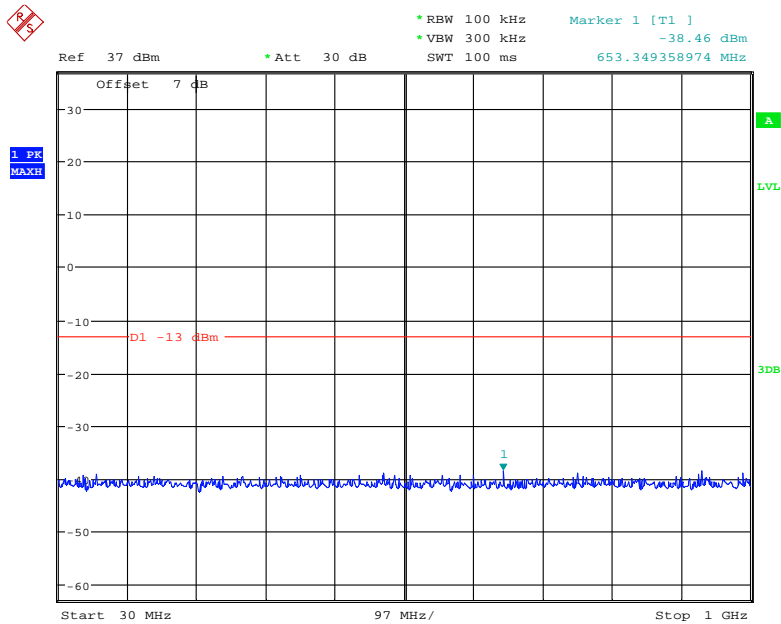

Date: 5.MAY.2021 10:41:38

### 1 GHz – 2 GHz (GSM Mode)

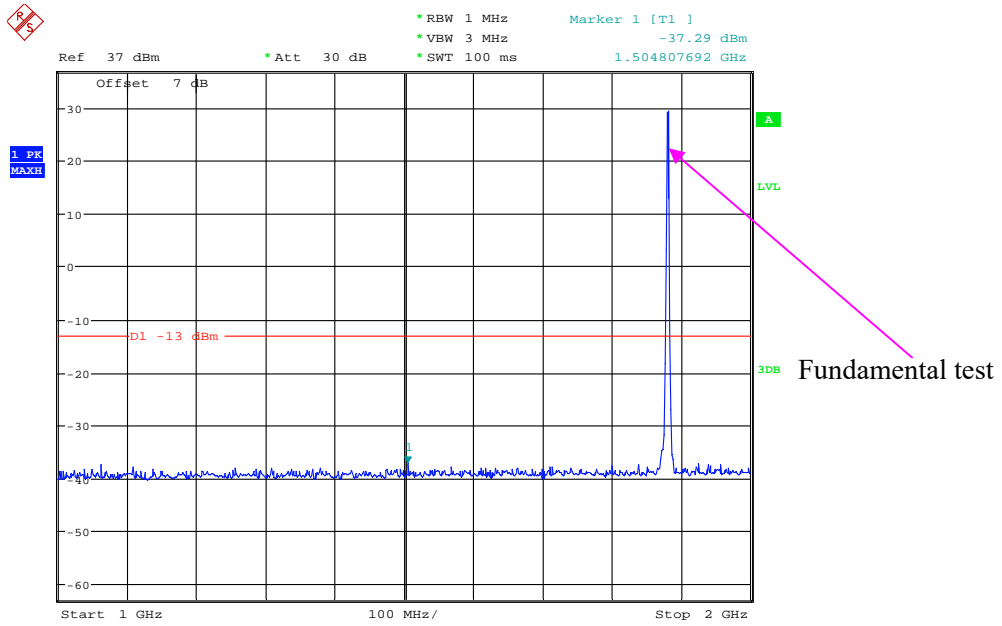

Date: 5.MAY.2021 10:43:52

### 2 GHz – 20 GHz (GSM Mode)

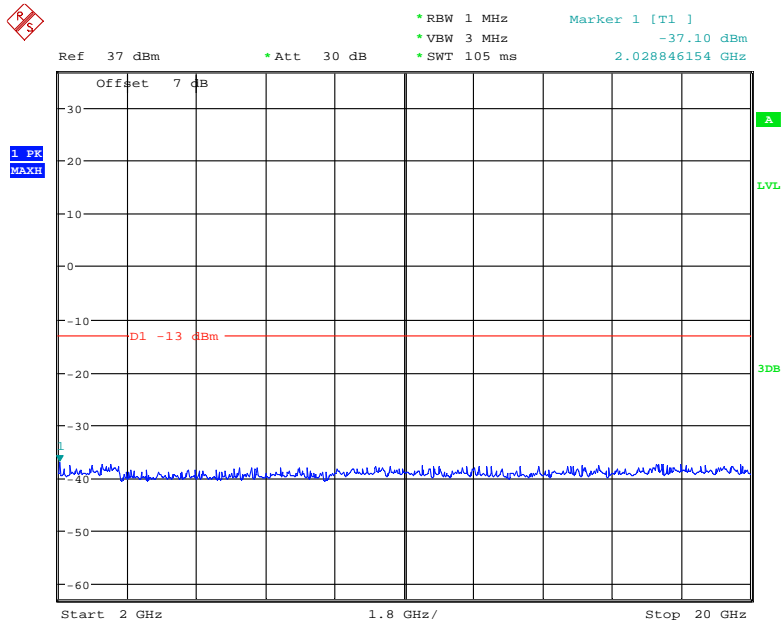

Date: 5.MAY.2021 10:45:50

### 30 MHz – 1 GHz (WCDMA Mode)

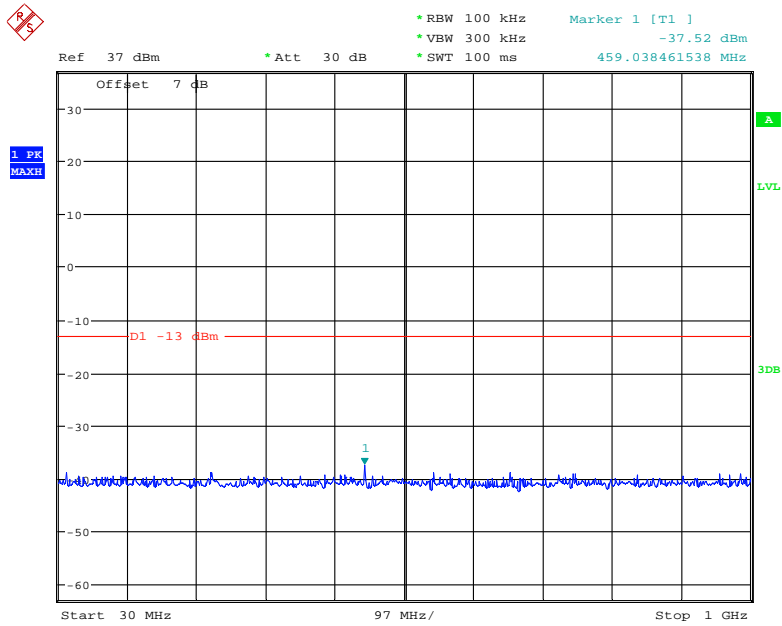

Date: 5.MAY.2021 17:43:01

### 1 GHz – 20 GHz (WCDMA Mode)

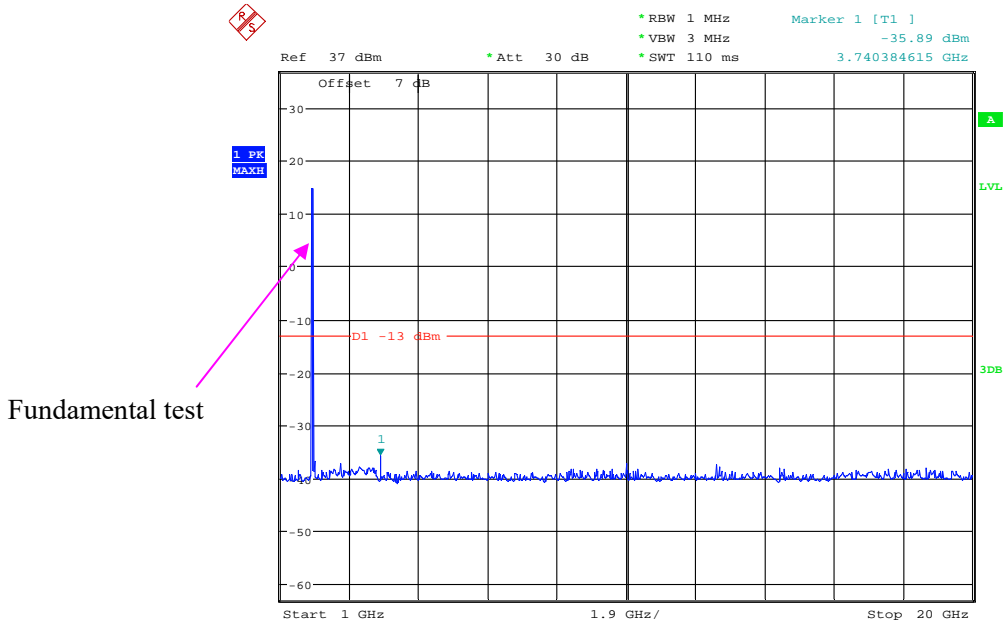

Date: 5.MAY.2021 17:45:36





### 2 GHz – 20 GHz (GSM Mode)

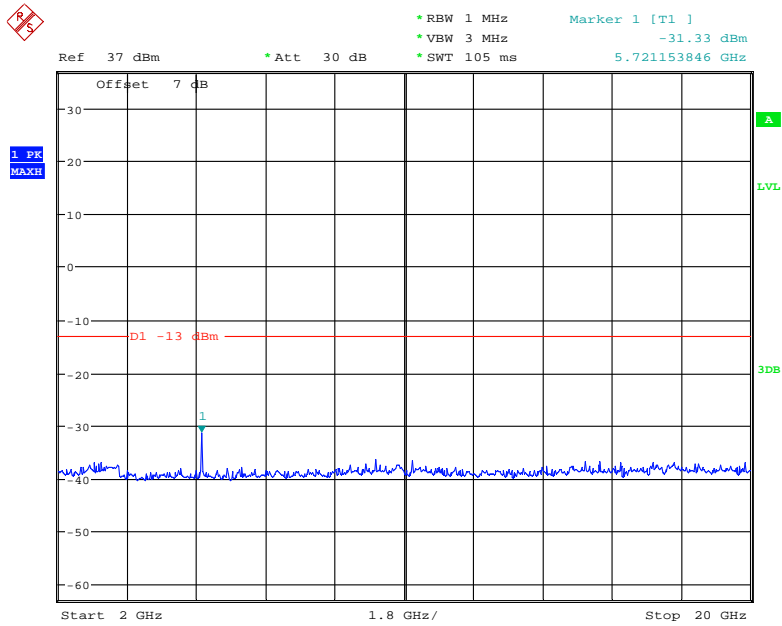

Date: 5.MAY.2021 10:45:10

### 30 MHz – 1 GHz (WCDMA Mode)

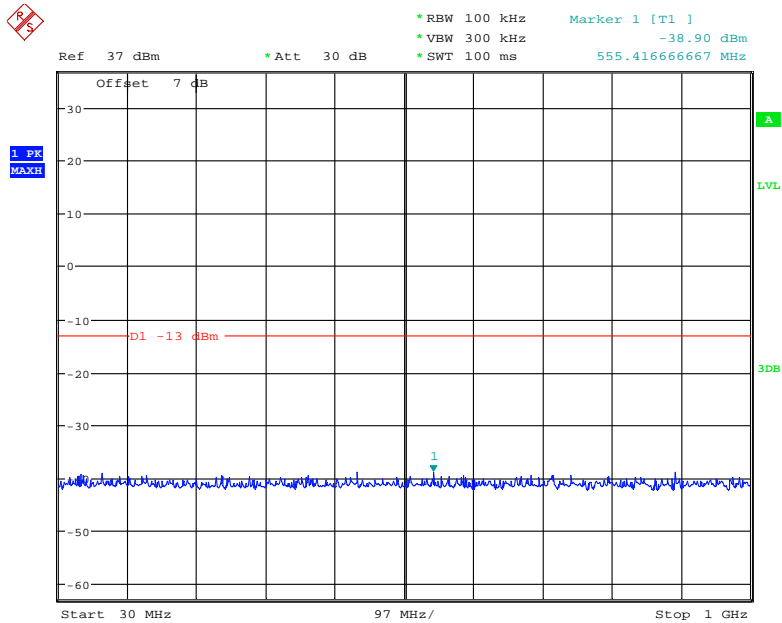

Date: 5.MAY.2021 17:44:12

### 1 GHz – 20 GHz (WCDMA Mode)

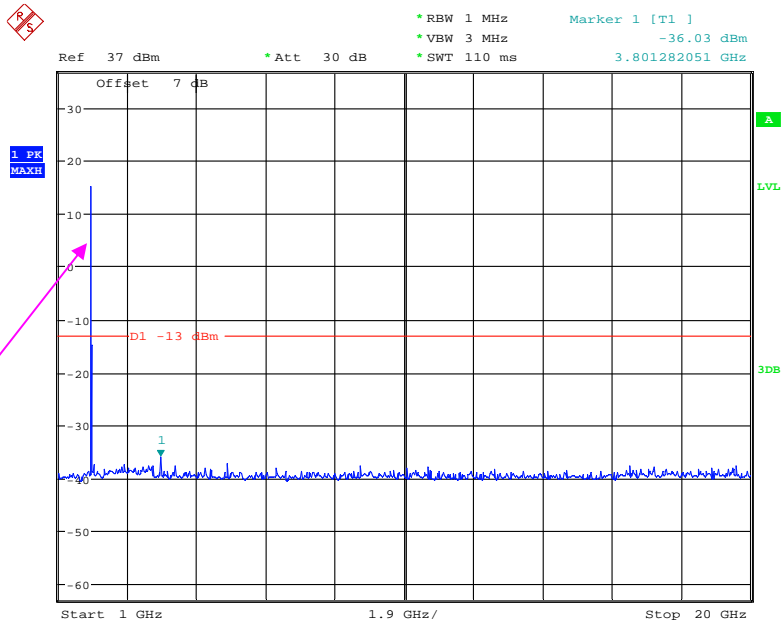

Fundamental test

Date: 5.MAY.2021 17:45:02

**AWS Band (Part 27)  
Low Channel:**

**30 MHz – 1 GHz (WCDMA Mode)**

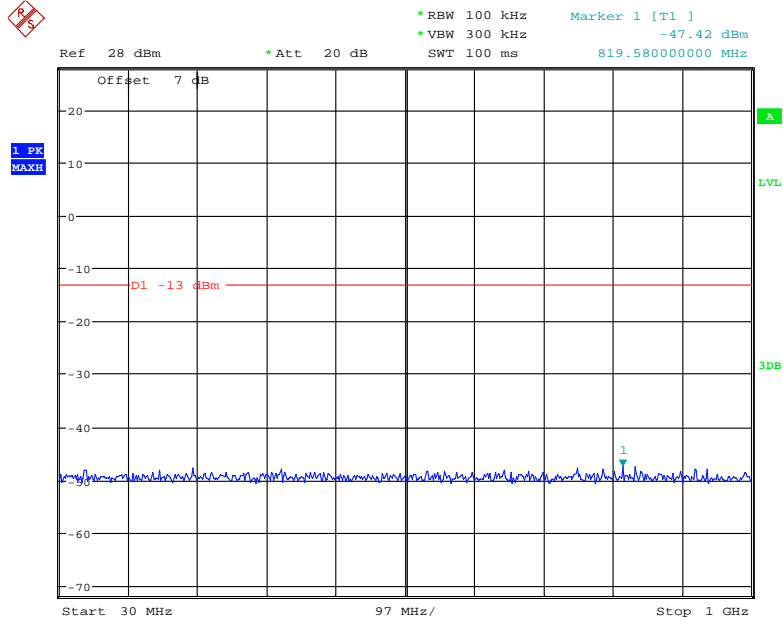

Date: 31.MAY.2021 18:12:48

**1 GHz – 20 GHz (WCDMA Mode)**

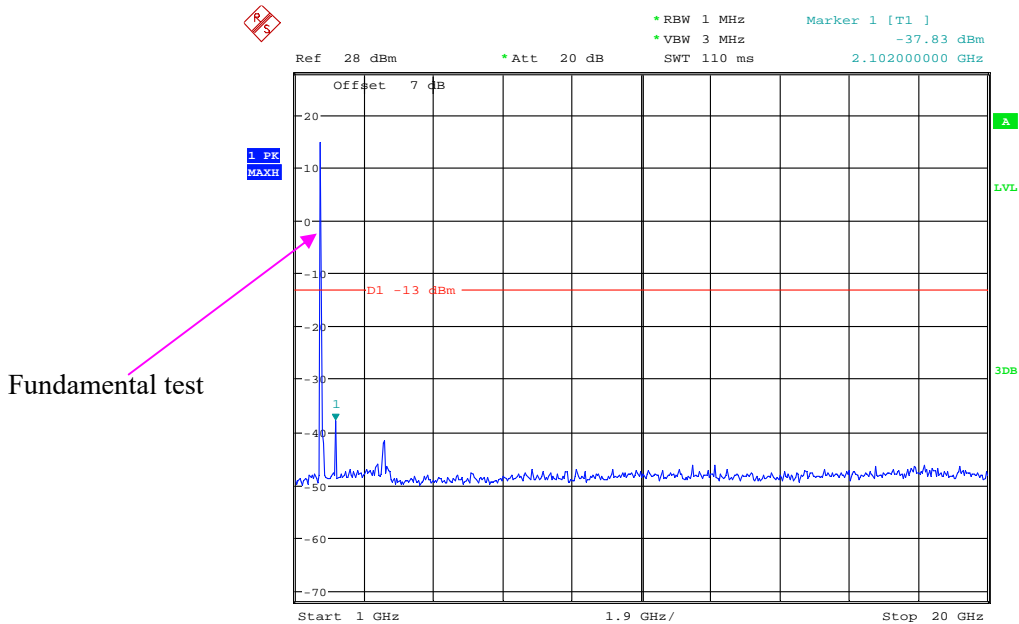

Date: 31.MAY.2021 18:16:15

Middle Channel

30 MHz – 1 GHz (WCDMA Mode)

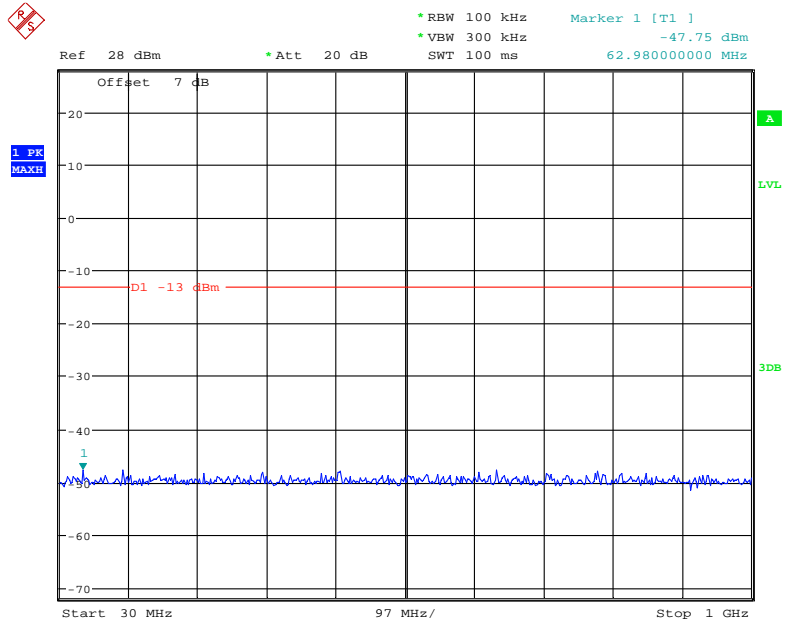

Date: 31.MAY.2021 18:13:38

1 GHz – 20 GHz (WCDMA Mode)

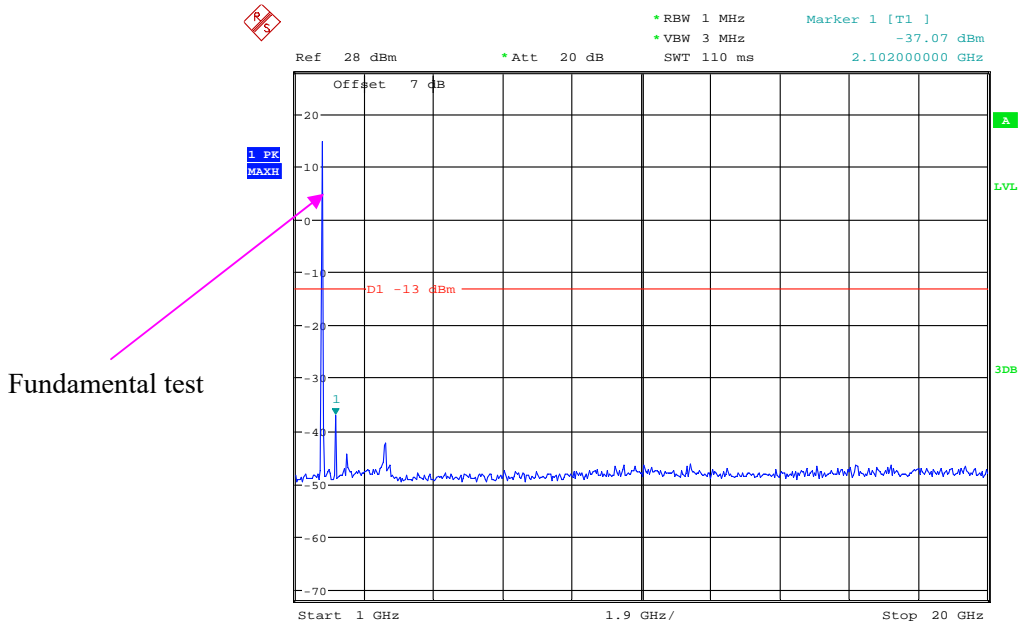

Date: 31.MAY.2021 18:15:49

High Channel:

30 MHz – 1 GHz (WCDMA Mode)

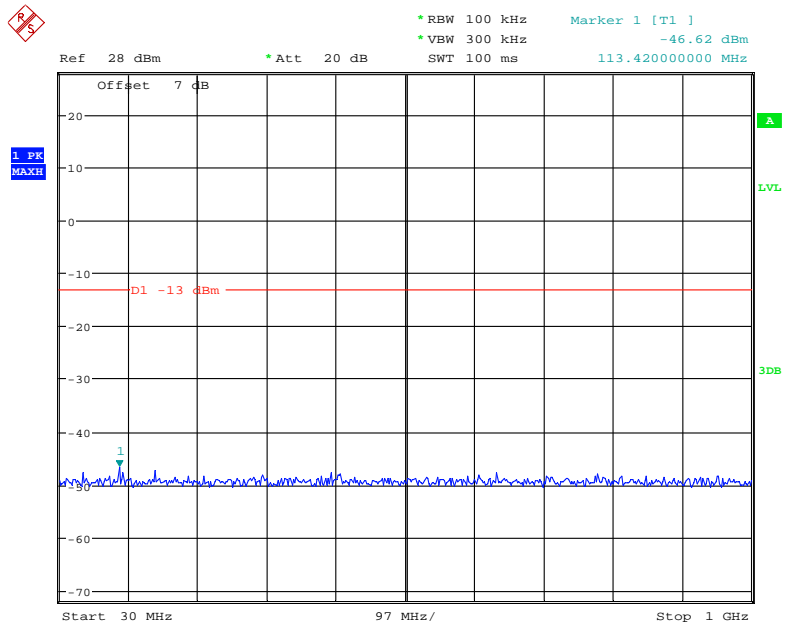

Date: 31.MAY.2021 18:13:50

1 GHz – 20 GHz (WCDMA Mode)

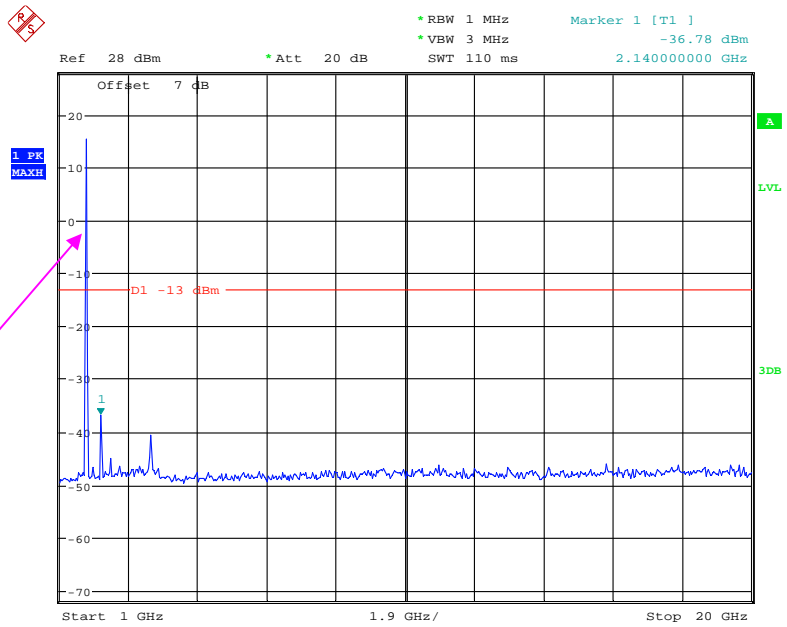

Fundamental test

Date: 31.MAY.2021 18:14:28

The test plots of LTE band please refer to the Appendix B.

---

**FCC § 2.1053; § 22.917 (a); § 24.238 (a); §27.53 SPURIOUS RADIATED EMISSIONS**

---

**Applicable Standard**

FCC § 2.1053, §22.917(a) and § 24.238(a) and § 27.53

**Test Procedure**

The transmitter was placed on a wooden turntable, and it was transmitting into a non-radiating load which was also placed on the turntable.

The measurement antenna was placed at a distance of 3 meters from the EUT. During the tests, the receiving antenna height and polarization as well as EUT azimuth were varied in order to identify the maximum level of emissions from the EUT. The test was performed by placing the EUT on 3-orthogonal axis.

The frequency range up to tenth harmonic of the fundamental frequency was investigated.

**Test Data****Environmental Conditions**

<b>Temperature:</b>	28~29.3 °C
<b>Relative Humidity:</b>	46~58 %
<b>ATM Pressure:</b>	101.0~101.1 kPa

*The testing was performed by Zero Yan on 2021-04-29 for below 1GHz, Alan He from 2021-05-01 to 2021-05-06 for above 1GHz.*

*EUT operation mode: Transmitting*

**30 MHz ~ 10 GHz:**

**Cellular Band (Part 22H)**

Frequency (MHz)	Receiver Reading (dBµV)	Turntable Angle Degree	Rx Antenna		Substituted			Absolute Level (dBm)	FCC Part 22H	
			Height (m)	Polar (H/V)	Level (dBm)	Cable Loss (dB)	Antenna Gain (dBd/dBi)		Limit (dBm)	Margin (dB)
GSM Mode										
Low channel										
965.3	31.23	217	1.4	H	-65.3	1.36	0.0	-66.66	-13	53.66
965.3	32.86	77	2.2	V	-61.2	1.36	0.0	-62.56	-13	49.56
1648.40	43.46	217	1.7	H	-64.6	1.40	8.70	-57.30	-13	44.30
1648.40	45.77	190	1.7	V	-62.1	1.40	8.70	-54.80	-13	41.80
2472.60	44.53	264	1.7	H	-58.8	2.60	10.20	-51.20	-13	38.20
2472.60	44.87	131	2.2	V	-57.9	2.60	10.20	-50.30	-13	37.30
3296.80	46.14	243	1.2	H	-54.8	1.50	11.70	-44.60	-13	31.60
3296.80	48.25	250	1.3	V	-52.7	1.50	11.70	-42.50	-13	29.50
Middle channel										
967.6	31.27	127	1.0	H	-65.2	1.36	0.0	-66.56	-13	53.56
967.6	32.88	77	2.1	V	-61.2	1.36	0.0	-62.56	-13	49.56
1673.20	55.77	130	1.7	H	-50.6	1.30	8.90	-43.00	-13	30.00
1673.20	53.94	236	1.7	V	-51.8	1.30	8.90	-44.20	-13	31.20
2509.80	49.57	74	1.6	H	-53.8	2.60	10.20	-46.20	-13	33.20
2509.80	47.99	156	1.3	V	-54.8	2.60	10.20	-47.20	-13	34.20
3346.40	46.19	182	2.0	H	-54.7	1.50	11.70	-44.50	-13	31.50
3346.40	44.85	69	2.0	V	-56.1	1.50	11.70	-45.90	-13	32.90
High channel										
965.8	31.21	48	1.6	H	-65.3	1.36	0.0	-66.66	-13	53.66
965.8	32.79	331	2.4	V	-61.3	1.36	0.0	-62.66	-13	49.66
1697.60	49.29	89	2.3	H	-57.0	1.30	8.90	-49.40	-13	36.40
1697.60	46.99	268	1.8	V	-58.7	1.30	8.90	-51.10	-13	38.10
2546.40	48.97	152	2.5	H	-54.4	2.60	10.20	-46.80	-13	33.80
2546.40	45.81	263	2.3	V	-56.9	2.60	10.20	-49.30	-13	36.30
3395.20	44.59	136	1.8	H	-56.6	1.40	11.80	-46.20	-13	33.20
3395.20	43.72	315	2.1	V	-57.3	1.40	11.80	-46.90	-13	33.90

Frequency (MHz)	Receiver Reading (dBµV)	Turntable Angle Degree	Rx Antenna		Substituted			Absolute Level (dBm)	FCC Part 22H	
			Height (m)	Polar (H/V)	Level (dBm)	Cable Loss (dB)	Antenna Gain (dBd/dBi)		Limit (dBm)	Margin (dB)
WCDMA Mode										
Low channel										
962.5	31.39	126	2.5	H	-65.1	1.36	0.0	-66.46	-13	53.46
962.5	32.88	263	1.5	V	-61.2	1.36	0.0	-62.56	-13	49.56
1652.80	42.54	264	2.2	H	-63.8	1.30	8.90	-56.20	-13	43.20
1652.80	43.27	25	1.4	V	-62.5	1.30	8.90	-54.90	-13	41.90
2479.20	43.35	46	2.2	H	-60.0	2.60	10.20	-52.40	-13	39.40
2479.20	43.84	121	2.1	V	-58.9	2.60	10.20	-51.30	-13	38.30
3305.60	42.83	300	1.1	H	-58.1	1.50	11.70	-47.90	-13	34.90
3305.60	42.76	56	2.0	V	-58.2	1.50	11.70	-48.00	-13	35.00
Middle channel										
962.6	31.45	260	1.3	H	-65.1	1.36	0.0	-66.46	-13	53.46
962.6	32.92	293	1.8	V	-61.1	1.36	0.0	-62.46	-13	49.46
1673.20	51.10	267	1.5	H	-55.2	1.30	8.90	-47.60	-13	34.60
1673.20	46.51	200	2.4	V	-59.2	1.30	8.90	-51.60	-13	38.60
2509.80	45.01	322	1.4	H	-58.3	2.60	10.20	-50.70	-13	37.70
2509.80	44.17	202	1.6	V	-58.6	2.60	10.20	-51.00	-13	38.00
3346.40	43.28	165	1.2	H	-57.6	1.50	11.70	-47.40	-13	34.40
3346.40	43.64	244	1.9	V	-57.3	1.50	11.70	-47.10	-13	34.10
High channel										
966.8	31.33	264	2.2	H	-65.2	1.36	0.0	-66.56	-13	53.56
966.8	32.83	227	1.8	V	-61.2	1.36	0.0	-62.56	-13	49.56
1693.20	45.86	237	2.0	H	-60.5	1.30	8.90	-52.90	-13	39.90
1693.20	46.12	335	2.1	V	-59.6	1.30	8.90	-52.00	-13	39.00
2539.80	42.86	16	1.3	H	-60.5	2.60	10.20	-52.90	-13	39.90
2539.80	43.29	199	1.4	V	-59.5	2.60	10.20	-51.90	-13	38.90
3386.40	43.21	255	2.5	H	-58.0	1.40	11.80	-47.60	-13	34.60
3386.40	43.13	74	1.9	V	-57.9	1.40	11.80	-47.50	-13	34.50



**30 MHz ~ 20 GHz:**

**PCS Band (Part 24E)**

Frequency (MHz)	Receiver Reading (dBµV)	Turntable Angle Degree	Rx Antenna		Substituted			Absolute Level (dBm)	FCC Part 24E	
			Height (m)	Polar (H/V)	Level (dBm)	Cable Loss (dB)	Antenna Gain (dBd/dBi)		Limit (dBm)	Margin (dB)
GSM Mode										
Low channel										
962.1	31.39	298	1.5	H	-65.1	1.36	0.0	-66.46	-13	53.46
962.1	32.82	332	1.3	V	-61.2	1.36	0.0	-62.56	-13	49.56
3700.40	43.10	266	1.5	H	-58.7	1.60	11.90	-48.40	-13	35.40
3700.40	43.66	357	1.3	V	-57.6	1.60	11.90	-47.30	-13	34.30
Middle channel										
963.2	31.36	18	2.1	H	-65.1	1.36	0.0	-66.46	-13	53.46
963.2	32.87	174	2.0	V	-61.2	1.36	0.0	-62.56	-13	49.56
3760.00	43.91	69	2.1	H	-58.1	1.50	11.80	-47.80	-13	34.80
3760.00	44.01	22	2.0	V	-57.6	1.50	11.80	-47.30	-13	34.30
High channel										
962.5	31.4	124	2.5	H	-65.1	1.36	0.0	-66.46	-13	53.46
962.5	32.77	146	1.7	V	-61.3	1.36	0.0	-62.66	-13	49.66
3819.60	43.53	296	2.3	H	-58.5	1.50	11.80	-48.20	-13	35.20
3819.60	43.77	177	2.2	V	-57.8	1.50	11.80	-47.50	-13	34.50
WCDMA Mode										
Low channel										
966.9	31.42	64	1.6	H	-65.1	1.36	0.0	-66.46	-13	53.46
966.9	32.89	64	2.5	V	-61.2	1.36	0.0	-62.56	-13	49.56
3704.80	43.25	26	1.6	H	-58.6	1.60	11.90	-48.30	-13	35.30
3704.80	43.12	66	1.8	V	-58.1	1.60	11.90	-47.80	-13	34.80
Middle channel										
964.2	31.36	293	1.4	H	-65.1	1.36	0.0	-66.46	-13	53.46
964.2	32.82	335	1.8	V	-61.2	1.36	0.0	-62.56	-13	49.56
3760.00	43.37	42	1.8	H	-58.7	1.50	11.80	-48.40	-13	35.40
3760.00	43.25	20	1.7	V	-58.3	1.50	11.80	-48.00	-13	35.00
High channel										
967.2	31.43	251	1.8	H	-65.1	1.36	0.0	-66.46	-13	53.46
967.2	32.86	84	1.5	V	-61.2	1.36	0.0	-62.56	-13	49.56
3815.20	43.55	273	2.1	H	-58.5	1.50	11.80	-48.20	-13	35.20
3815.20	43.37	171	2.3	V	-58.2	1.50	11.80	-47.90	-13	34.90

**30 MHz ~ 20 GHz:**

**AWS Band**

Frequency (MHz)	Receiver Reading (dBµV)	Turntable Angle Degree	Rx Antenna		Substituted			Absolute Level (dBm)	FCC Part 27	
			Height (m)	Polar (H/V)	Level (dBm)	Cable Loss (dB)	Antenna Gain (dBd/dBi)		Limit (dBm)	Margin (dB)
WCDMA Mode										
Low channel										
962.3	31.32	156	2.5	H	-65.2	1.36	0.0	-66.56	-13	53.56
962.3	32.77	217	1.8	V	-61.3	1.36	0.0	-62.66	-13	49.66
3424.80	43.46	35	1.2	H	-57.3	1.40	11.80	-46.90	-13	33.90
3424.80	43.12	197	1.7	V	-57.5	1.40	11.80	-47.10	-13	34.10
Middle channel										
961.6	31.37	288	1.4	H	-65.1	1.36	0.0	-66.46	-13	53.46
961.6	32.79	85	1.6	V	-61.3	1.36	0.0	-62.66	-13	49.66
3465.20	43.39	268	2.3	H	-57.4	1.50	12.00	-46.90	-13	33.90
3465.20	43.34	50	1.9	V	-58.2	1.50	12.00	-47.70	-13	34.70
High channel										
964.8	31.33	186	1.9	H	-65.2	1.36	0.0	-66.56	-13	53.56
964.8	32.84	309	1.2	V	-61.2	1.36	0.0	-62.56	-13	49.56
3505.20	43.62	316	1.7	H	-57.1	1.50	12.00	-46.60	-13	33.60
3505.20	43.65	213	1.3	V	-57.9	1.50	12.00	-47.40	-13	34.40

**LTE Band:** (Pre-scan with all the bandwidth, and worst case as below)

Frequency (MHz)	Receiver Reading (dBµV)	Turntable Angle Degree	Rx Antenna		Substituted			Absolute Level (dBm)	Limit (dBm)	Margin (dB)
			Height (m)	Polar (H/V)	Level (dBm)	Cable Loss (dB)	Antenna Gain (dBd/dBi)			
Band 2										
Test frequency range: 30 MHz ~ 20 GHz										
1.4MHz, Low channel										
961.6	31.56	181	1.7	H	-64.9	1.36	0.0	-66.26	-13	53.26
961.6	32.89	38	1.3	V	-61.2	1.36	0.0	-62.56	-13	49.56
3701.40	66.62	52	1.1	H	-35.2	1.60	11.90	-24.90	-13	11.90
3701.40	64.49	99	2.2	V	-36.7	1.60	11.90	-26.40	-13	13.40
5552.10	55.58	232	2.2	H	-44.1	1.70	12.40	-33.40	-13	20.40
5552.10	50.37	242	2.1	V	-49.0	1.70	12.40	-38.30	-13	25.30
1.4MHz, Middle channel										
961.3	31.46	257	2.4	H	-65.0	1.36	0.0	-66.36	-13	53.36
961.3	32.94	120	1.6	V	-61.1	1.36	0.0	-62.46	-13	49.46
3760.00	59.88	39	2.0	H	-42.2	1.50	11.80	-31.90	-13	18.90
3760.00	64.66	104	1.4	V	-36.9	1.50	11.80	-26.60	-13	13.60
5640.00	43.37	230	1.8	H	-56.3	1.70	12.40	-45.60	-13	32.60
5640.00	43.98	39	2.0	V	-55.4	1.70	12.40	-44.70	-13	31.70
1.4MHz, High channel										
969.4	31.41	139	2.2	H	-65.1	1.36	0.0	-66.46	-13	53.46
969.4	32.97	325	1.0	V	-61.1	1.36	0.0	-62.46	-13	49.46
3818.60	62.57	176	1.9	H	-39.5	1.50	11.80	-29.20	-13	16.20
3818.60	65.47	75	1.8	V	-36.1	1.50	11.80	-25.80	-13	12.80
5727.90	45.47	72	1.6	H	-54.4	1.60	12.10	-43.90	-13	30.90
5727.90	46.84	331	2.1	V	-52.4	1.60	12.10	-41.90	-13	28.90

Frequency (MHz)	Receiver Reading (dBμV)	Turntable Angle Degree	Rx Antenna		Substituted			Absolute Level (dBm)	Limit (dBm)	Margin (dB)
			Height (m)	Polar (H/V)	Level (dBm)	Cable Loss (dB)	Antenna Gain (dBd/dBi)			
Band 4										
Test frequency range:30 MHz ~ 20 GHz										
1.4MHz, Low channel										
963.9	31.49	227	1.7	H	-65.0	1.36	0.0	-66.36	-13	53.36
963.9	32.89	208	1.7	V	-61.2	1.36	0.0	-62.56	-13	49.56
3421.40	44.24	341	1.2	H	-56.6	1.40	11.80	-46.20	-13	33.20
3421.40	45.57	256	2.1	V	-55.0	1.40	11.80	-44.60	-13	31.60
5132.10	43.38	340	1.0	H	-56.6	1.60	12.10	-46.10	-13	33.10
5132.10	44.12	162	2.2	V	-55.9	1.60	12.10	-45.40	-13	32.40
1.4MHz, Middle channel										
968.6	31.55	167	2.3	H	-65.0	1.36	0.0	-66.36	-13	53.36
968.6	32.85	342	1.3	V	-61.2	1.36	0.0	-62.56	-13	49.56
3465.00	44.37	126	1.5	H	-56.4	1.50	12.00	-45.90	-13	32.90
3465.00	44.23	134	1.6	V	-57.3	1.50	12.00	-46.80	-13	33.80
5197.50	44.17	14	1.0	H	-55.9	1.60	12.10	-45.40	-13	32.40
5197.50	43.57	338	1.9	V	-56.0	1.60	12.10	-45.50	-13	32.50
1.4MHz, High channel										
969.7	31.51	270	1.4	H	-65.0	1.36	0.0	-66.36	-13	53.36
969.7	32.93	279	1.6	V	-61.1	1.36	0.0	-62.46	-13	49.46
3508.60	43.57	165	2.1	H	-57.2	1.50	12.00	-46.70	-13	33.70
3508.60	43.89	308	1.3	V	-57.6	1.50	12.00	-47.10	-13	34.10
5262.90	43.54	124	1.7	H	-56.2	1.60	12.20	-45.60	-13	32.60
5262.90	43.39	97	1.2	V	-55.8	1.60	12.20	-45.20	-13	32.20

Frequency (MHz)	Receiver Reading (dBμV)	Turntable Angle Degree	Rx Antenna		Substituted			Absolute Level (dBm)	Limit (dBm)	Margin (dB)
			Height (m)	Polar (H/V)	Level (dBm)	Cable Loss (dB)	Antenna Gain (dBd/dBi)			
Band 5										
Test frequency range:30 MHz ~ 10 GHz										
1.4MHz, Low channel										
966.8	31.43	317	2.1	H	-65.1	1.36	0.0	-66.46	-13	53.46
966.8	32.95	116	1.5	V	-61.1	1.36	0.0	-62.46	-13	49.46
1649.40	46.87	321	2.3	H	-61.2	1.40	8.70	-53.90	-13	40.90
1649.40	46.17	84	1.8	V	-61.7	1.40	8.70	-54.40	-13	41.40
2474.10	43.57	252	2.3	H	-59.8	2.60	10.20	-52.20	-13	39.20
2474.10	43.43	126	2.4	V	-59.3	2.60	10.20	-51.70	-13	38.70
3298.80	43.25	351	1.3	H	-57.6	1.50	11.70	-47.40	-13	34.40
3298.80	43.22	138	1.2	V	-57.7	1.50	11.70	-47.50	-13	34.50
1.4MHz, Middle channel										
964.7	31.49	139	1.2	H	-65.0	1.36	0.0	-66.36	-13	53.36
964.7	32.98	99	1.5	V	-61.1	1.36	0.0	-62.46	-13	49.46
1673.00	45.27	295	2.5	H	-61.1	1.30	8.90	-53.50	-13	40.50
1673.00	45.13	79	1.9	V	-60.6	1.30	8.90	-53.00	-13	40.00
2509.50	55.61	215	1.3	H	-47.7	2.60	10.20	-40.10	-13	27.10
2509.50	55.17	170	1.2	V	-47.6	2.60	10.20	-40.00	-13	27.00
3346.00	44.22	269	2.4	H	-56.7	1.50	11.70	-46.50	-13	33.50
3346.00	44.13	344	2.4	V	-56.8	1.50	11.70	-46.60	-13	33.60
1.4MHz, High channel										
963.2	31.45	309	2.2	H	-65.1	1.36	0.0	-66.46	-13	53.46
963.2	32.87	191	2.2	V	-61.2	1.36	0.0	-62.56	-13	49.56
1696.60	44.21	185	1.9	H	-62.1	1.30	8.90	-54.50	-13	41.50
1696.60	44.14	351	1.6	V	-61.6	1.30	8.90	-54.00	-13	41.00
2544.90	56.82	346	1.5	H	-46.5	2.60	10.20	-38.90	-13	25.90
2544.90	56.47	34	1.9	V	-46.3	2.60	10.20	-38.70	-13	25.70
3393.20	45.91	287	1.4	H	-55.3	1.40	11.80	-44.90	-13	31.90
3393.20	45.41	117	1.9	V	-55.6	1.40	11.80	-45.20	-13	32.20
Band 7										
Test frequency range: 30 MHz ~ 26.5 GHz										
5MHz, Low channel										
967.3	31.52	103	1.8	H	-65.0	1.36	0.0	-66.36	-25	41.36
967.3	32.89	147	1.7	V	-61.2	1.36	0.0	-62.56	-25	37.56
5005.00	43.78	150	1.7	H	-56.8	1.70	12.00	-46.50	-25	21.50
5005.00	43.51	1	2.4	V	-56.5	1.70	12.00	-46.20	-25	21.20
5MHz, Middle channel										
967.6	31.43	118	2.0	H	-65.1	1.36	0.0	-66.46	-25	41.46
961.6	32.83	13	2.5	V	-61.2	1.36	0.0	-62.56	-25	37.56
5070.00	43.25	180	1.1	H	-56.8	1.60	12.10	-46.30	-25	21.30
5070.00	43.20	210	2.1	V	-56.8	1.60	12.10	-46.30	-25	21.30
5MHz, High channel										
966.3	31.55	131	2.4	H	-65.0	1.36	0.0	-66.36	-25	41.36
966.3	32.89	271	2.0	V	-61.2	1.36	0.0	-62.56	-25	37.56
5135.00	43.55	104	1.3	H	-56.5	1.60	12.10	-46.00	-25	21.00
5135.00	43.92	336	1.8	V	-56.1	1.60	12.10	-45.60	-25	20.60

Frequency (MHz)	Receiver Reading (dBμV)	Turntable Angle Degree	Rx Antenna		Substituted			Absolute Level (dBm)	Limit (dBm)	Margin (dB)
			Height (m)	Polar (H/V)	Level (dBm)	Cable Loss (dB)	Antenna Gain (dBd/dBi)			
Band 17										
Test frequency range: 30 MHz ~ 10 GHz										
5MHz, Low channel										
962.4	31.54	250	2.5	H	-65.0	1.36	0.0	-66.36	-13	53.36
962.4	32.94	350	2.2	V	-61.1	1.36	0.0	-62.46	-13	49.46
1413.00	43.14	196	1.2	H	-65.0	1.60	7.90	-58.70	-13	45.70
1413.00	43.57	190	2.2	V	-64.9	1.60	7.90	-58.60	-13	45.60
2119.50	42.98	245	2.0	H	-58.1	1.30	9.70	-49.70	-13	36.70
2119.50	43.57	173	1.6	V	-58.4	1.30	9.70	-50.00	-13	37.00
2826.00	43.15	310	2.1	H	-60.8	1.80	10.50	-52.10	-13	39.10
2826.00	43.29	62	1.8	V	-60.3	1.80	10.50	-51.60	-13	38.60
3532.50	55.50	323	1.6	H	-45.4	1.50	12.00	-34.90	-13	21.90
3532.50	57.91	326	1.3	V	-43.7	1.50	12.00	-33.20	-13	20.20
5MHz, Middle channel										
965.7	31.52	110	2.0	H	-65.0	1.36	0.0	-66.36	-13	53.36
965.7	32.97	17	2.1	V	-61.1	1.36	0.0	-62.46	-13	49.46
1420.00	43.17	172	1.8	H	-65.0	1.60	7.90	-58.70	-13	45.70
1420.00	43.57	333	1.6	V	-64.9	1.60	7.90	-58.60	-13	45.60
2130.00	43.25	293	1.9	H	-57.9	1.30	9.70	-49.50	-13	36.50
2130.00	43.67	351	2.3	V	-58.3	1.30	9.70	-49.90	-13	36.90
2840.00	44.51	217	1.2	H	-59.4	1.80	10.50	-50.70	-13	37.70
2840.00	46.23	70	1.2	V	-57.4	1.80	10.50	-48.70	-13	35.70
3550.00	51.70	317	1.1	H	-50.0	1.50	12.10	-39.40	-13	26.40
3550.00	51.91	217	2.0	V	-49.3	1.50	12.10	-38.70	-13	25.70
5MHz, High channel										
963.1	31.44	286	1.6	H	-65.1	1.36	0.0	-66.46	-13	53.46
963.1	32.93	35	2.5	V	-61.1	1.36	0.0	-62.46	-13	49.46
1427.00	43.39	180	2.4	H	-64.8	1.60	7.90	-58.50	-13	45.50
1427.00	44.37	154	1.3	V	-64.1	1.60	7.90	-57.80	-13	44.80
2140.50	43.15	233	1.7	H	-58.0	1.30	9.70	-49.60	-13	36.60
2140.50	43.55	62	2.0	V	-58.4	1.30	9.70	-50.00	-13	37.00
2854.00	55.12	176	2.3	H	-49.6	1.70	10.70	-40.60	-13	27.60
2854.00	56.10	143	2.1	V	-48.6	1.70	10.70	-39.60	-13	26.60
3567.50	56.68	320	2.1	H	-45.0	1.50	12.10	-34.40	-13	21.40
3567.50	56.78	6	2.5	V	-44.4	1.50	12.10	-33.80	-13	20.80

Frequency (MHz)	Receiver Reading (dBµV)	Turntable Angle Degree	Rx Antenna		Substituted			Absolute Level (dBm)	Limit (dBm)	Margin (dB)
			Height (m)	Polar (H/V)	Level (dBm)	Cable Loss (dB)	Antenna Gain (dBd/dBi)			
Band 38										
Test frequency range: 30 MHz ~26.5GHz										
5MHz, Low channel										
962.6	31.58	30	1.6	H	-64.9	1.36	0.0	-66.26	-25	41.26
962.6	32.88	84	2.3	V	-61.2	1.36	0.0	-62.56	-25	37.56
5145.00	50.53	194	2.2	H	-49.5	1.60	12.10	-39.00	-25	14.00
5145.00	46.27	243	1.5	V	-53.7	1.60	12.10	-43.20	-25	18.20
7717.50	44.14	36	1.7	H	-53.4	2.10	10.50	-45.00	-25	20.00
7717.50	43.98	252	1.7	V	-53.3	2.10	10.50	-44.90	-25	19.90
5MHz, Middle channel										
969.8	31.48	35	1.3	H	-65.0	1.36	0.0	-66.36	-25	41.36
969.8	32.96	264	2.3	V	-61.1	1.36	0.0	-62.46	-25	37.46
5190.00	48.57	341	1.8	H	-51.5	1.60	12.10	-41.00	-25	16.00
5190.00	45.17	13	2.4	V	-54.4	1.60	12.10	-43.90	-25	18.90
7785.00	43.59	140	1.9	H	-52.7	2.00	10.50	-44.20	-25	19.20
7785.00	43.28	197	2.4	V	-52.9	2.00	10.50	-44.40	-25	19.40
5MHz, High channel										
960.5	31.44	23	2.1	H	-65.1	1.36	0.0	-66.46	-25	41.46
960.5	32.87	142	2.0	V	-61.2	1.36	0.0	-62.56	-25	37.56
5235.00	46.64	257	1.8	H	-53.5	1.60	12.10	-43.00	-25	18.00
5235.00	44.66	114	1.9	V	-55.0	1.60	12.10	-44.50	-25	19.50
7852.50	43.24	56	2.5	H	-53.0	2.00	10.50	-44.50	-25	19.50
7852.50	43.11	271	2.0	V	-53.1	2.00	10.50	-44.60	-25	19.60
Band 41										
Test frequency range: 30 MHz ~26.5GHz										
5MHz, Low channel										
965.6	31.59	245	1.8	H	-64.9	1.36	0.0	-66.26	-25	41.26
965.6	32.92	13	1.6	V	-61.1	1.36	0.0	-62.46	-25	37.46
5075.00	48.73	284	1.5	H	-51.3	1.60	12.10	-40.80	-25	15.80
5075.00	45.17	193	2.3	V	-54.8	1.60	12.10	-44.30	-25	19.30
7612.50	43.57	94	2.3	H	-53.9	2.10	10.50	-45.50	-25	20.50
7612.50	43.29	50	1.9	V	-54.0	2.10	10.50	-45.60	-25	20.60
5MHz, Middle channel										
967.6	31.47	166	1.8	H	-65.0	1.36	0.0	-66.36	-25	41.36
967.6	32.86	339	1.7	V	-61.2	1.36	0.0	-62.56	-25	37.56
5190.00	51.43	219	1.0	H	-48.7	1.60	12.10	-38.20	-25	13.20
5190.00	46.57	248	2.0	V	-53.0	1.60	12.10	-42.50	-25	17.50
7785.00	44.26	340	1.6	H	-52.0	2.00	10.50	-43.50	-25	18.50
7785.00	42.01	35	1.1	V	-54.2	2.00	10.50	-45.70	-25	20.70
5 MHz, High channel										
965.5	31.52	131	2.1	H	-65.0	1.36	0.0	-66.36	-25	41.36
965.5	32.84	48	1.1	V	-61.2	1.36	0.0	-62.56	-25	37.56
5305.00	57.61	119	1.8	H	-42.1	1.60	12.20	-31.50	-25	6.50
5305.00	60.10	187	1.9	V	-39.1	1.60	12.20	-28.50	-25	3.50
7957.50	35.89	213	1.1	H	-62.2	2.10	10.70	-53.60	-25	28.60
7957.50	36.14	200	1.0	V	-61.8	2.10	10.70	-53.20	-25	28.20

Frequency (MHz)	Receiver Reading (dBµV)	Turntable Angle Degree	Rx Antenna		Substituted			Absolute Level (dBm)	Limit (dBm)	Margin (dB)
			Height (m)	Polar (H/V)	Level (dBm)	Cable Loss (dB)	Antenna Gain (dBd/dBi)			
Band 66										
Test frequency range: 30 MHz ~ 20GHz										
1.4MHz, Low channel										
963.8	31.43	247	1.6	H	-65.1	1.36	0.0	-66.46	-13	53.46
963.8	32.89	323	2.4	V	-61.2	1.36	0.0	-62.56	-13	49.56
3421.40	43.81	233	2.4	H	-57.0	1.40	11.80	-46.60	-13	33.60
3421.40	43.76	167	2.1	V	-56.8	1.40	11.80	-46.40	-13	33.40
5132.10	44.5	303	2.2	H	-55.5	1.60	12.10	-45.00	-13	32.00
5132.10	43.57	345	1.5	V	-56.4	1.60	12.10	-45.90	-13	32.90
1.4MHz, Middle channel										
962.6	31.57	263	2.0	H	-64.9	1.36	0.0	-66.26	-13	53.26
962.6	32.87	72	2.3	V	-61.2	1.36	0.0	-62.56	-13	49.56
3490.00	43.41	190	1.0	H	-57.3	1.50	12.00	-46.80	-13	33.80
3490.00	43.37	53	1.7	V	-58.1	1.50	12.00	-47.60	-13	34.60
5235.00	43.51	81	2.3	H	-56.6	1.60	12.10	-46.10	-13	33.10
5235.00	43.23	285	2.0	V	-56.4	1.60	12.10	-45.90	-13	32.90
1.4MHz, High channel										
966.1	31.48	161	1.8	H	-65.0	1.36	0.0	-66.36	-13	53.36
966.1	32.97	238	2.4	V	-61.1	1.36	0.0	-62.46	-13	49.46
3558.60	43.40	199	2.0	H	-58.2	1.50	12.10	-47.60	-13	34.60
3558.60	43.23	115	2.3	V	-57.8	1.50	12.10	-47.20	-13	34.20
5337.90	43.57	254	2.4	H	-56.2	1.60	12.20	-45.60	-13	32.60
5337.90	43.24	71	1.4	V	-55.9	1.60	12.20	-45.30	-13	32.30

**Note:**

Absolute Level = Substituted Level - Cable loss + Antenna Gain

Margin = Limit- Absolute Level

dBd is for the ERP, dBi is for EIRP.



**FCC § 22.917 (a); § 24.238 (a); §27.53(c) (h)(m) - BAND EDGES**

**Applicable Standard**

According to § 22.917(a), the power of any emissions outside of the authorized operating frequency ranges must be attenuated below the transmitting power (P) by a factor of at least 43 + 10 log(P) dB.

According to §24.238(a), the power of any emissions outside of the authorized operating frequency ranges must be attenuated below the transmitting power (P) by a factor of at least 43 + 10 log(P) dB.

According to FCC §27.53 (c)(h)(m), the power of any emission outside of the authorized operating frequency ranges must be attenuated below the transmitting power (P) by a factor of at least 43 + 10 log(P) dB.

**Test Procedure**

The RF output of the transmitter was connected to the input of the spectrum analyzer through sufficient attenuation.

The center of the spectrum analyzer was set to block edge frequency

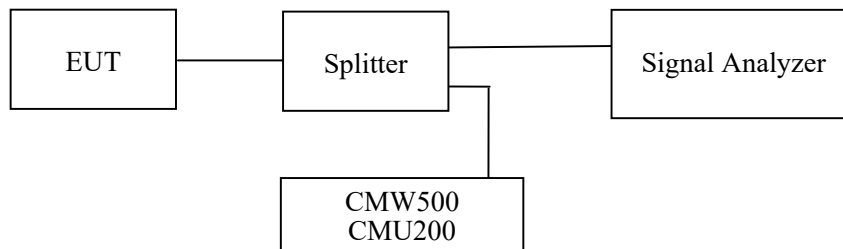

**Test Data**

**Environmental Conditions**

<b>Temperature:</b>	28.2~28.6 °C
<b>Relative Humidity:</b>	52~56 %
<b>ATM Pressure:</b>	100.9~101.0 kPa

*The testing was performed by Pedro Yun from 2021-05-01 to 2021-06-06.*

*EUT operation mode: Transmitting (Worst case)*

**Test Result: Pass**

*Please refer to the following plots.*

### Cellular Band, Left Band Edge for GSM (GMSK) Mode

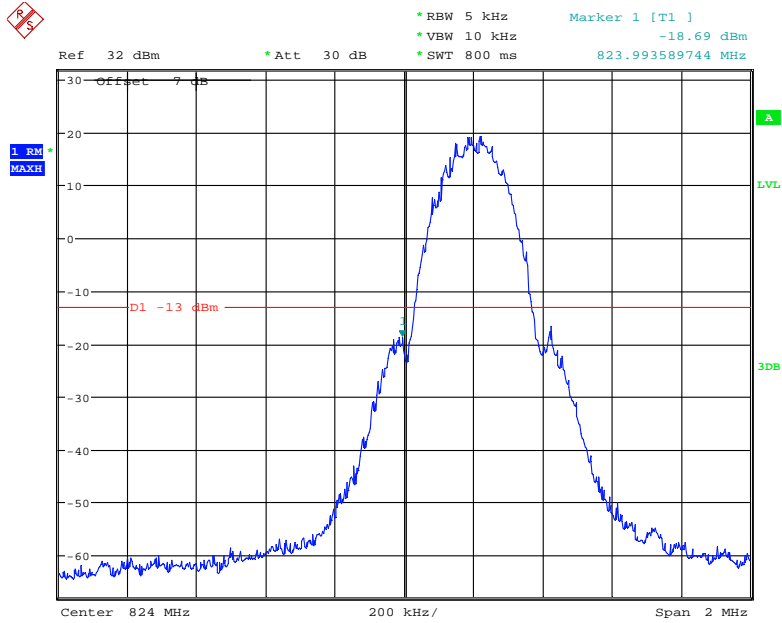

Date: 1.MAY.2021 21:32:35

### Cellular Band, Right Band Edge for GSM (GMSK) Mode

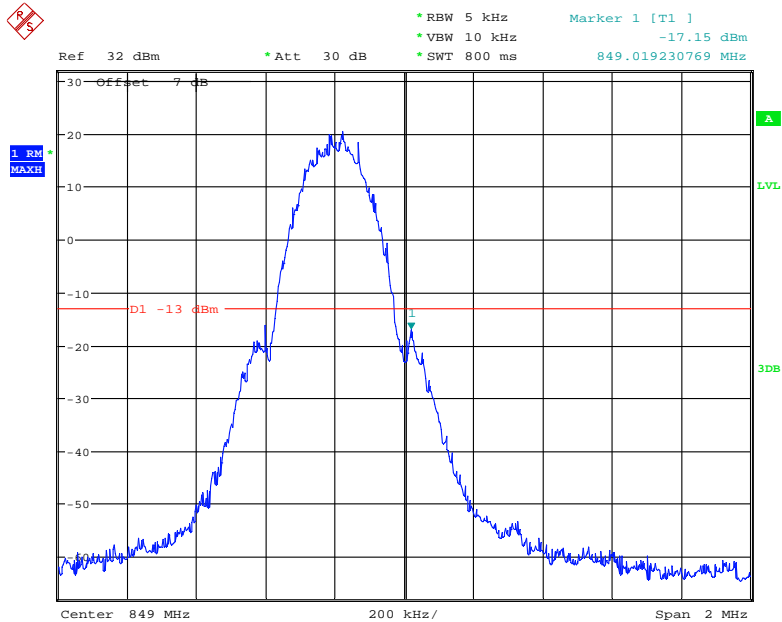

Date: 1.MAY.2021 21:33:40

### Cellular Band, Left Band Edge for EGPRS (GMSK) Mode

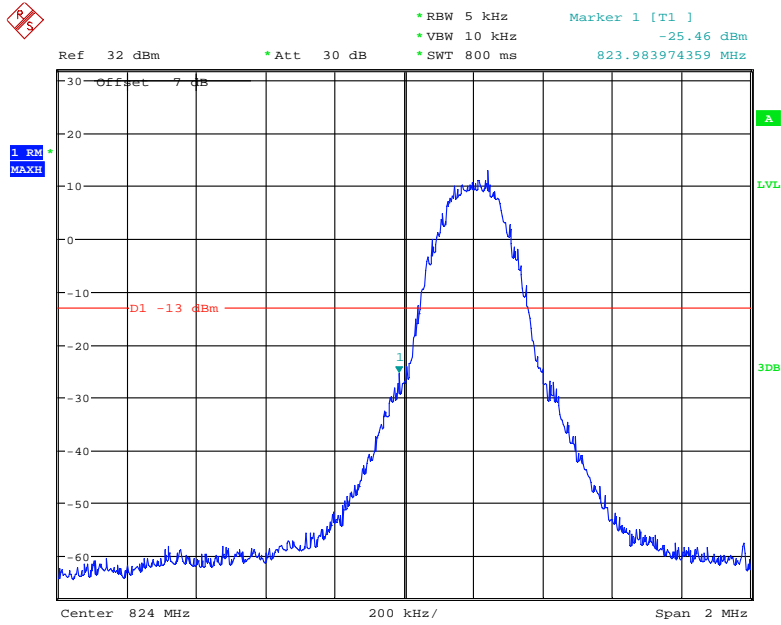

Date: 1.MAY.2021 21:55:45

### Cellular Band, Right Band Edge for EGPRS (GMSK) Mode

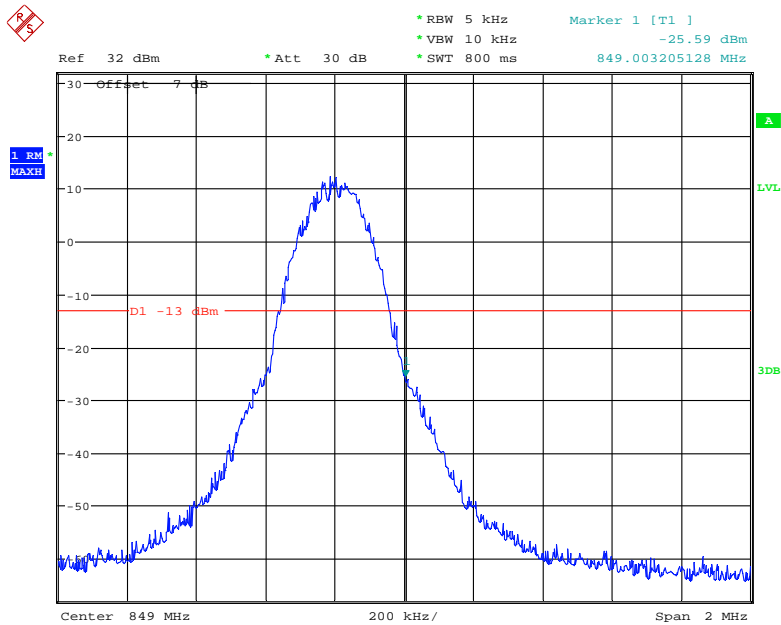

Date: 1.MAY.2021 21:56:48

### Cellular Band, Left Band Edge for WCDMA (BPSK) Mode

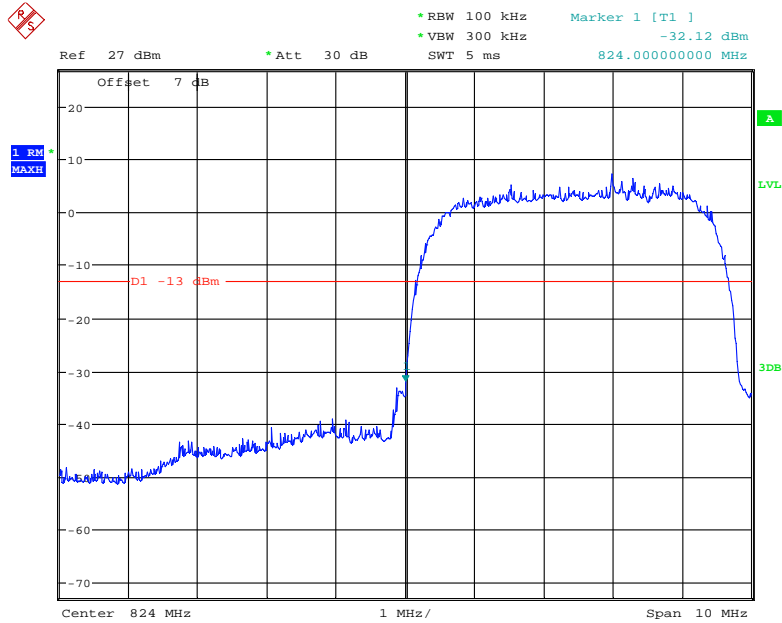

Date: 5.MAY.2021 16:37:13

### Cellular Band, Right Band Edge for WCDMA (BPSK) Mode

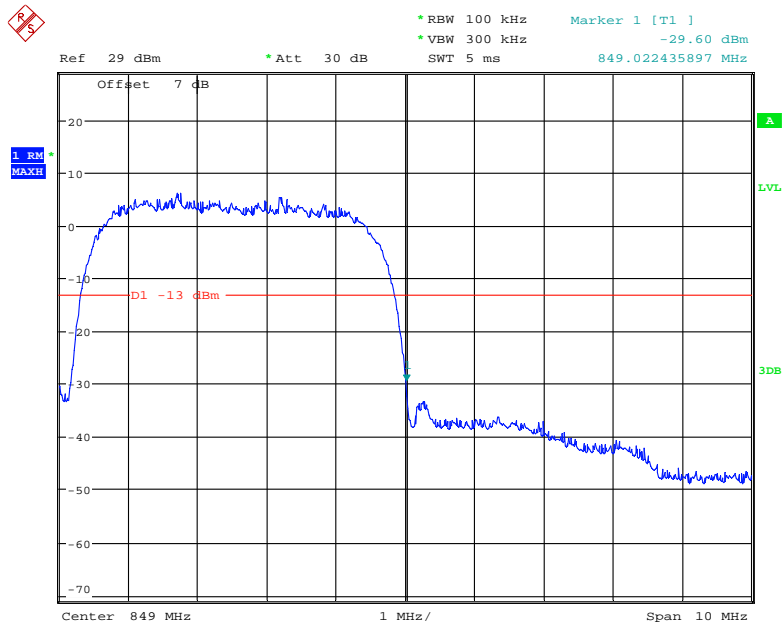

Date: 5.MAY.2021 17:20:54

### Cellular Band, Left Band Edge for HSDPA (16QAM) Mode

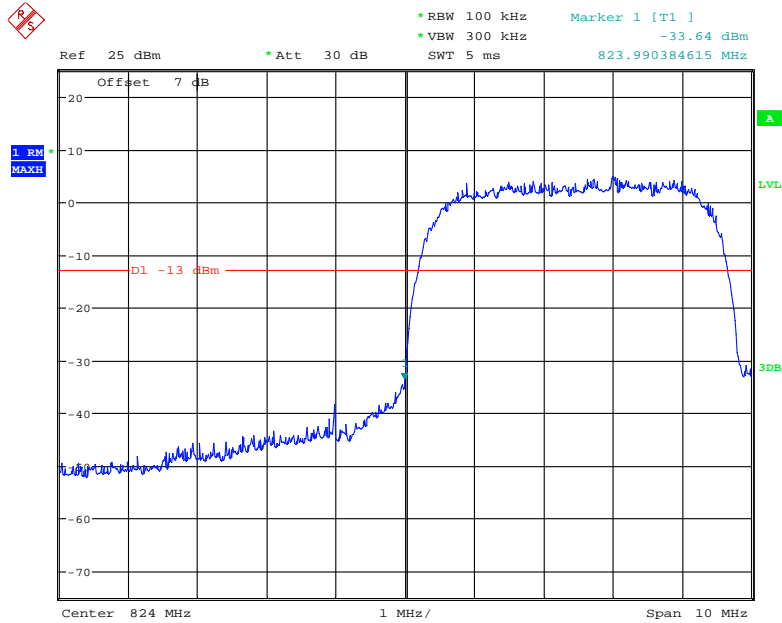

Date: 5.MAY.2021 17:59:10

### Cellular Band, Right Band Edge for HSDPA (16QAM) Mode

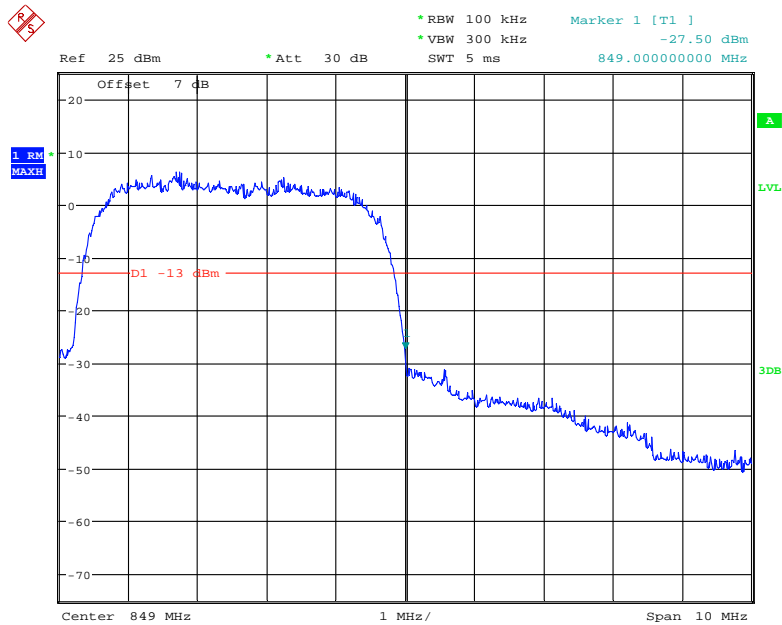

Date: 5.MAY.2021 18:00:42

### Cellular Band, Left Band Edge for HSUPA (BPSK) Mode

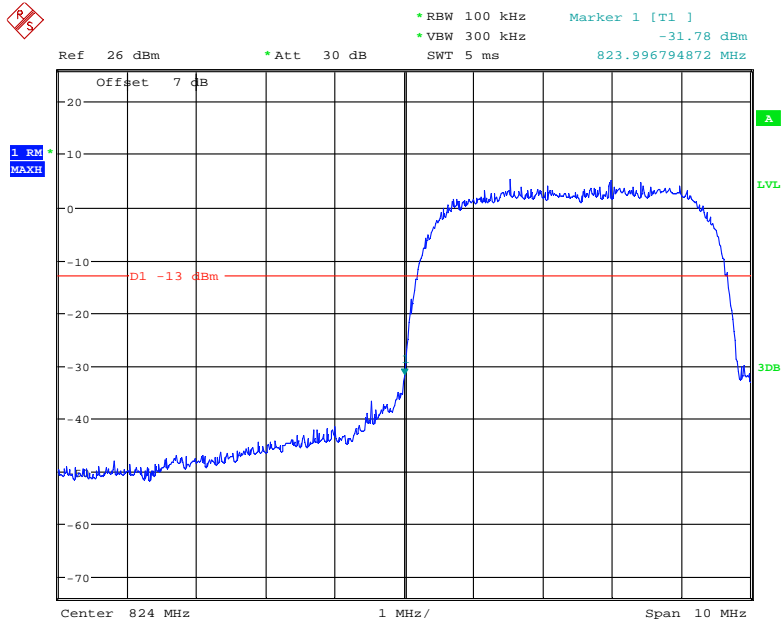

Date: 5.MAY.2021 18:52:39

### Cellular Band, Right Band Edge for HSUPA (BPSK) Mode

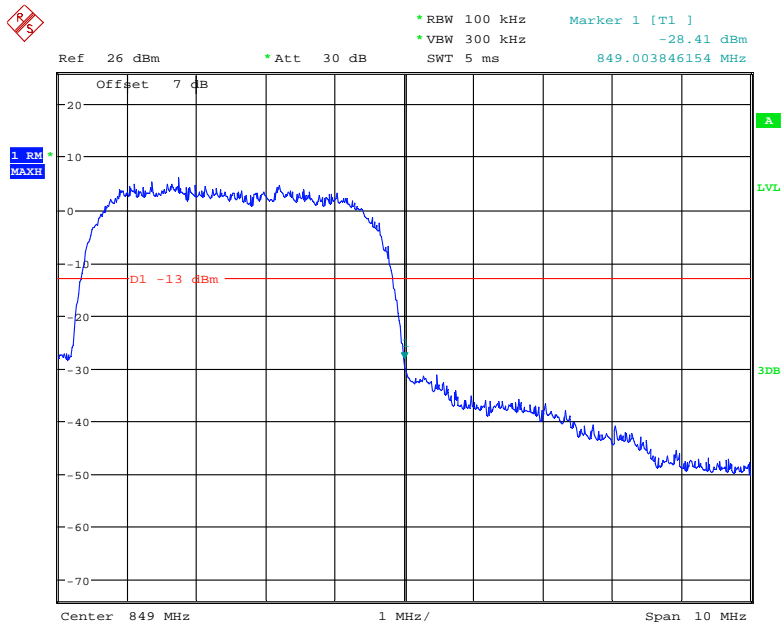

Date: 5.MAY.2021 18:51:45

### PCS Band, Left Band Edge for GSM (GMSK) Mode

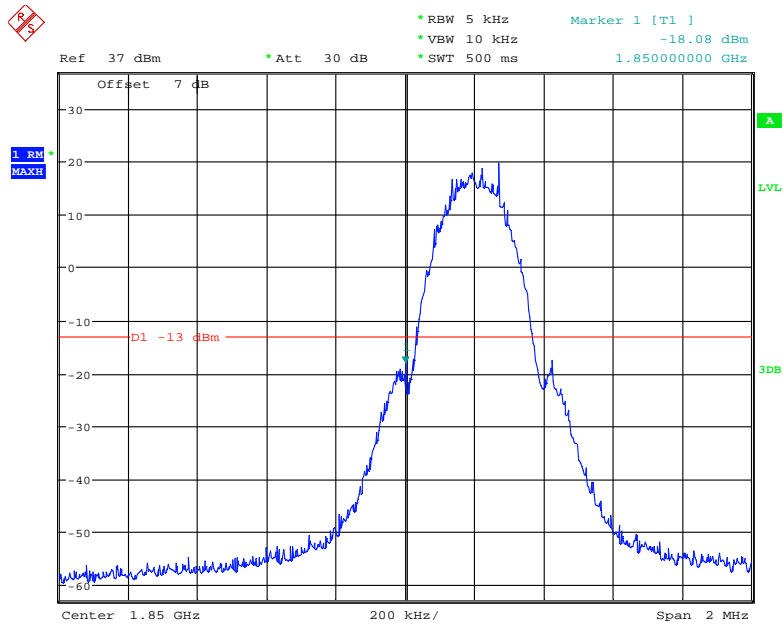

Date: 5.MAY.2021 10:06:09

### PCS Band, Right Band Edge for GSM (GMSK) Mode

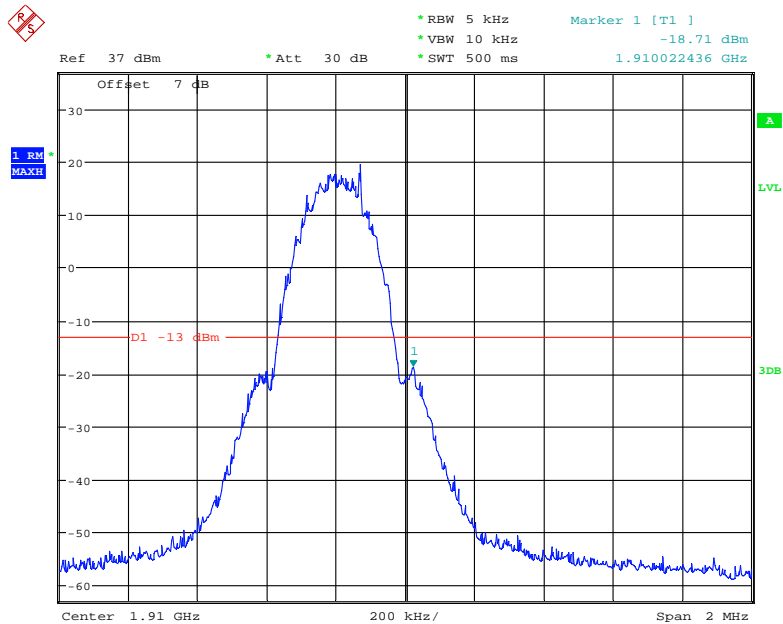

Date: 5.MAY.2021 10:08:52

### PCS Band, Left Band Edge for EGPRS (GMSK) Mode

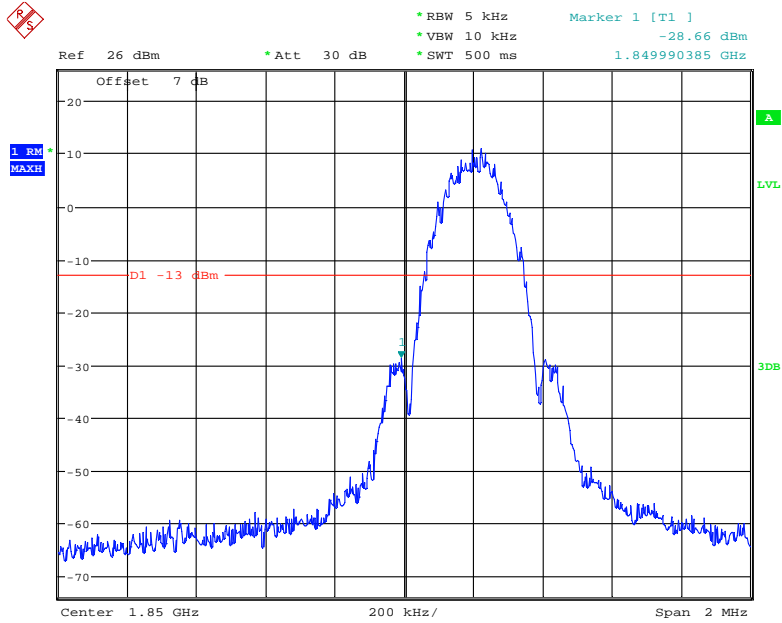

Date: 5.MAY.2021 10:19:34

### PCS Band, Right Band Edge for EGPRS (GMSK) Mode

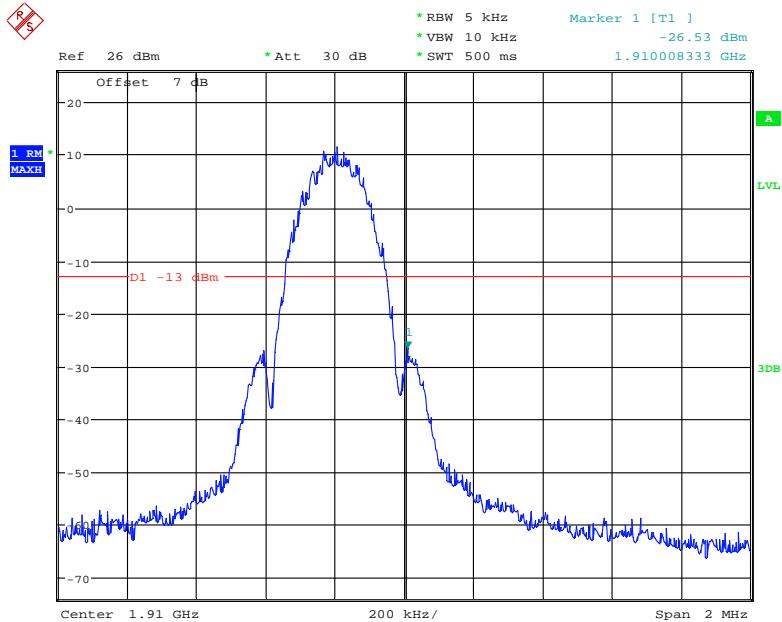

Date: 5.MAY.2021 10:20:52



### PCS Band, Left Band Edge for WCDMA (BPSK) Mode

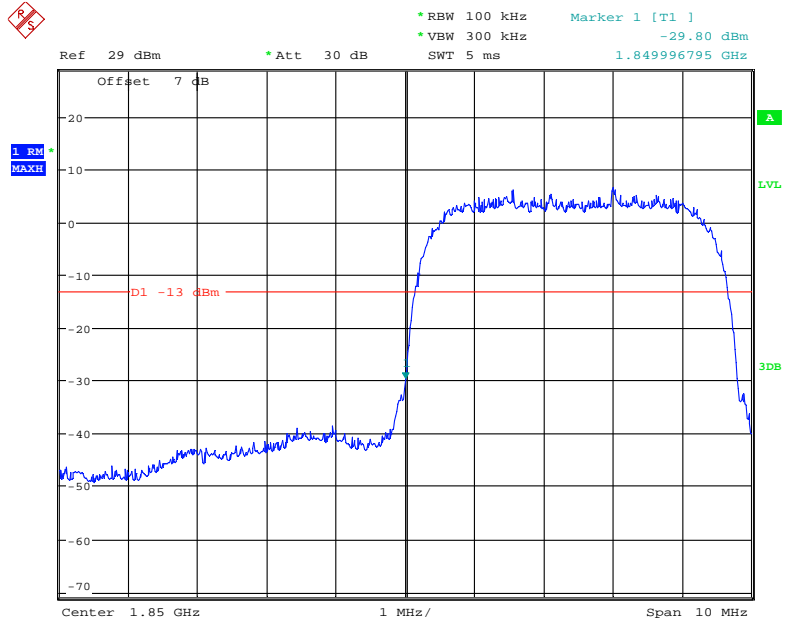

Date: 5.MAY.2021 17:15:44

### PCS Band, Right Band Edge for WCDMA (BPSK) Mode

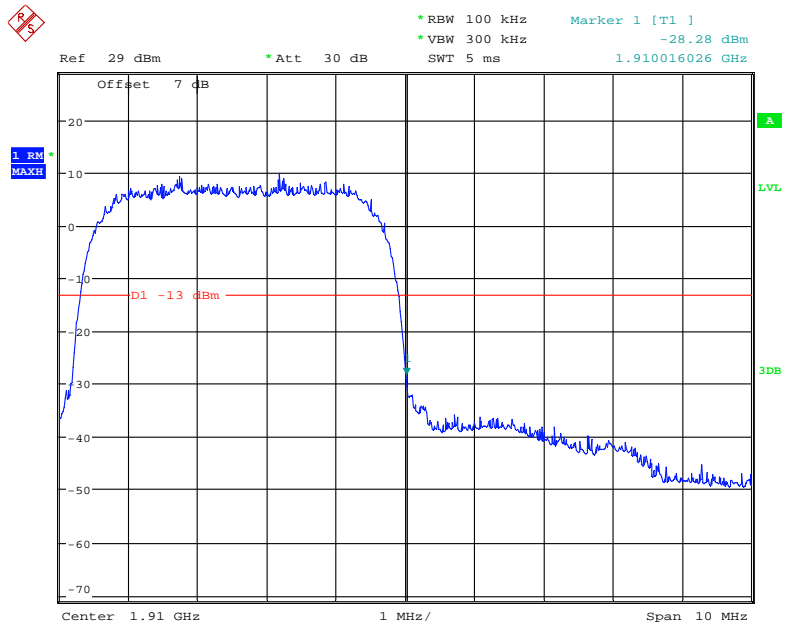

Date: 5.MAY.2021 17:14:46

### PCS Band, Left Band Edge for HSDPA (16QAM) Mode

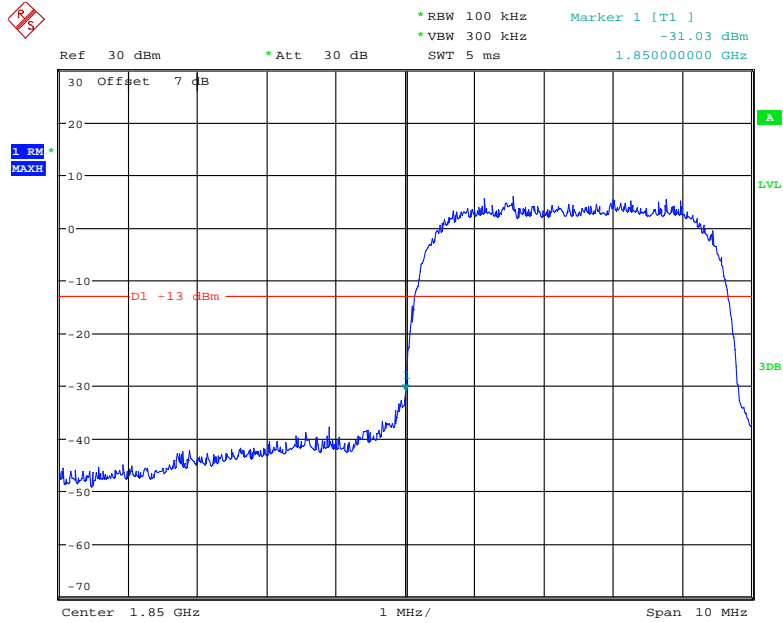

Date: 5.MAY.2021 17:50:31

### PCS Band, Right Band Edge for HSDPA (16QAM) Mode

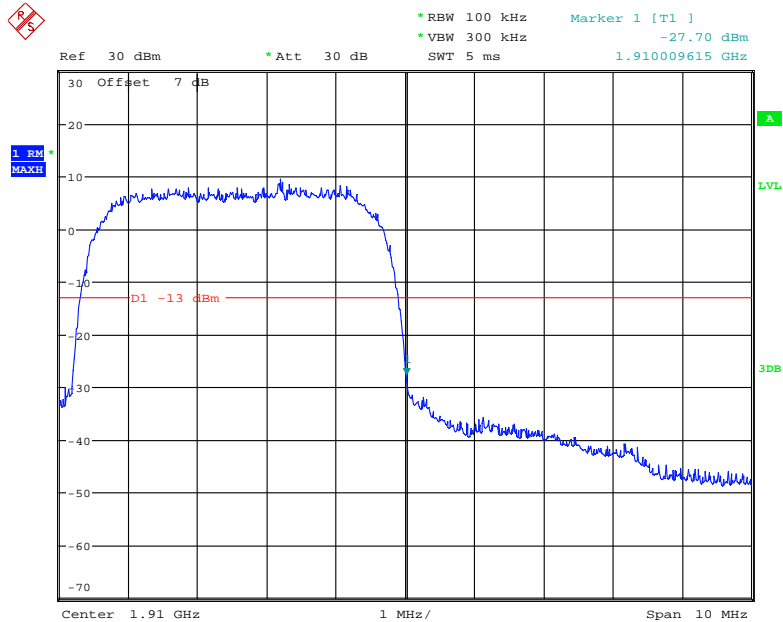

Date: 5.MAY.2021 17:52:14

### PCS Band, Left Band Edge for HSUPA (BPSK) Mode

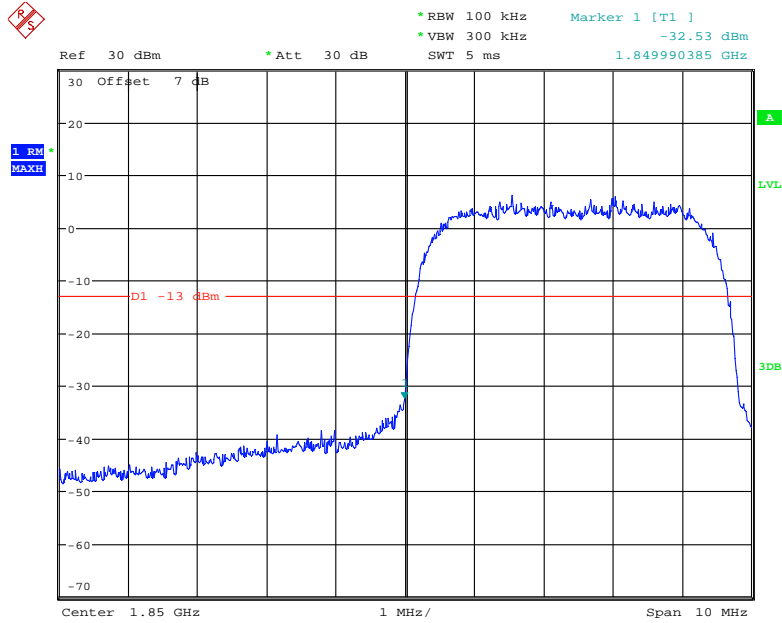

Date: 5.MAY.2021 18:57:03

### PCS Band, Right Band Edge for HSUPA (BPSK) Mode

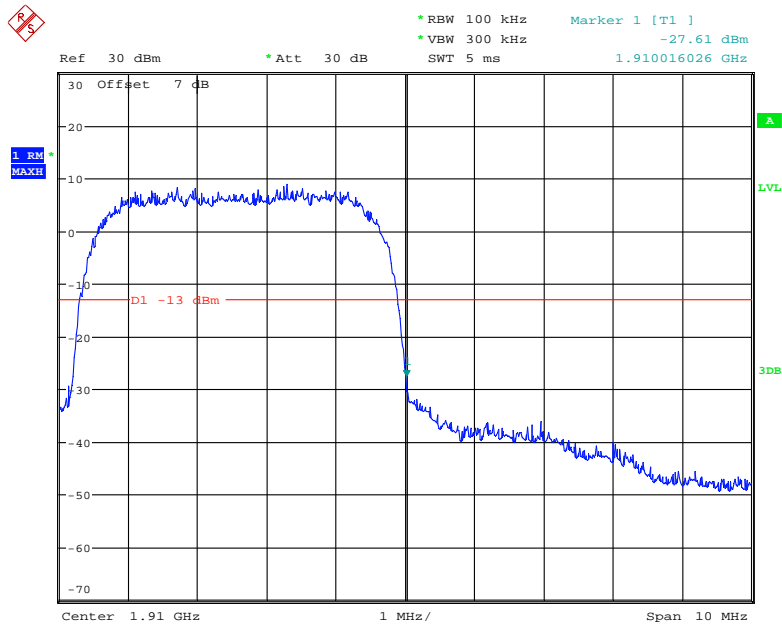

Date: 5.MAY.2021 18:55:36

### AWS Band, Left Band Edge for WCDMA (BPSK) Mode

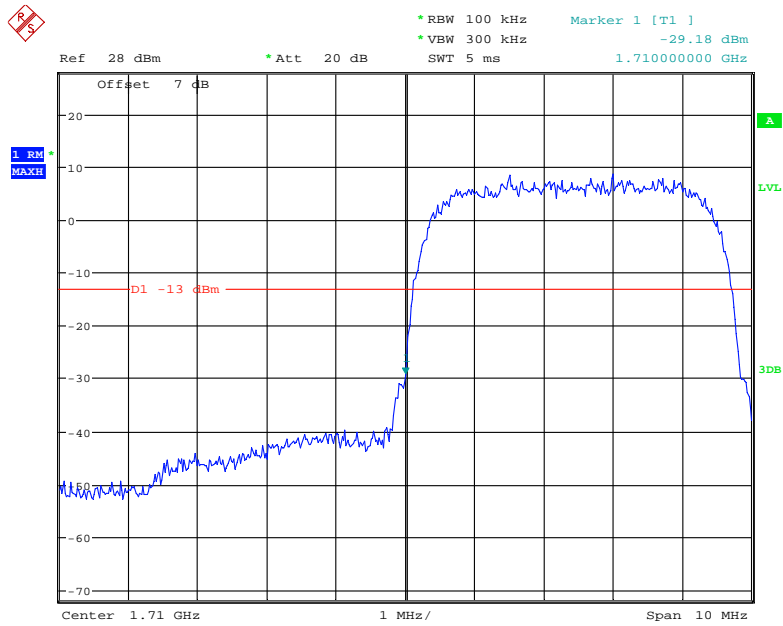

Date: 31.MAY.2021 18:11:34

### AWS Band, Right Band Edge for WCDMA (BPSK) Mode

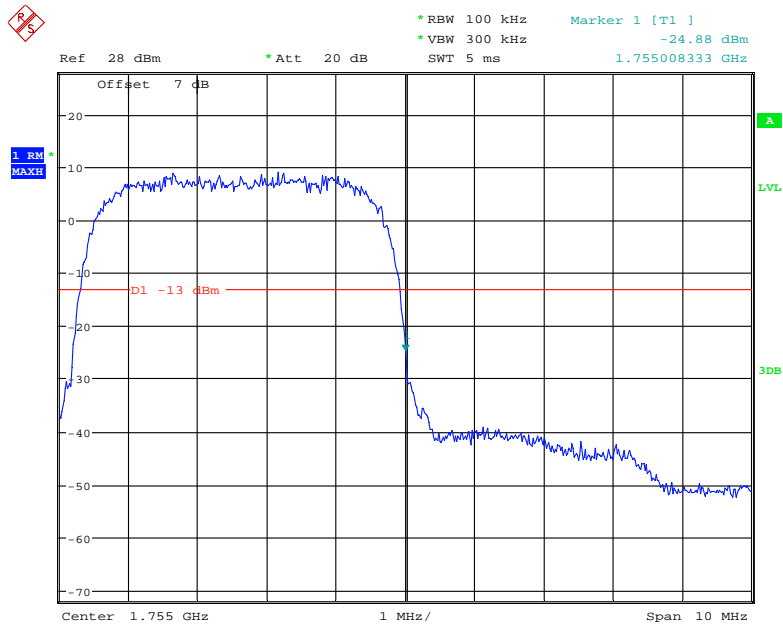

Date: 31.MAY.2021 18:10:35

### AWS Band, Left Band Edge for HSDPA (16QAM) Mode

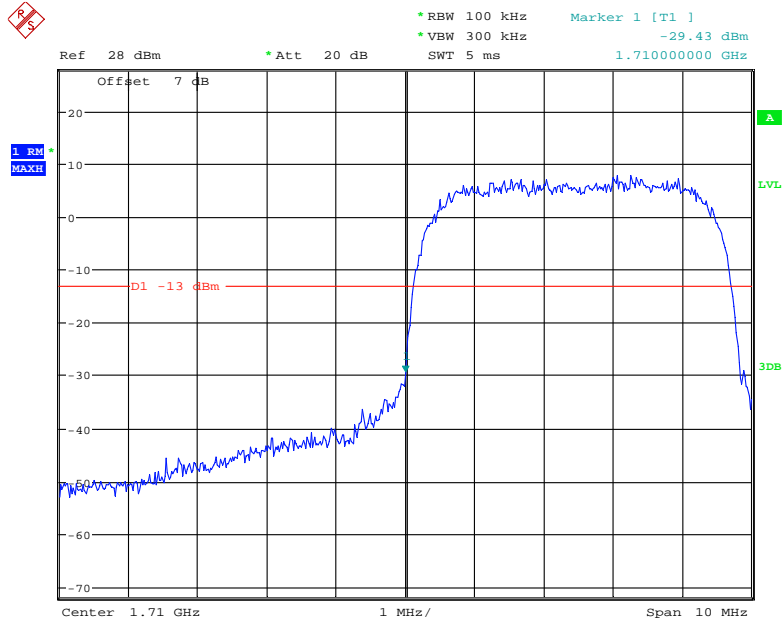

Date: 31.MAY.2021 18:24:15

### AWS Band, Right Band Edge for HSDPA (16QAM) Mode

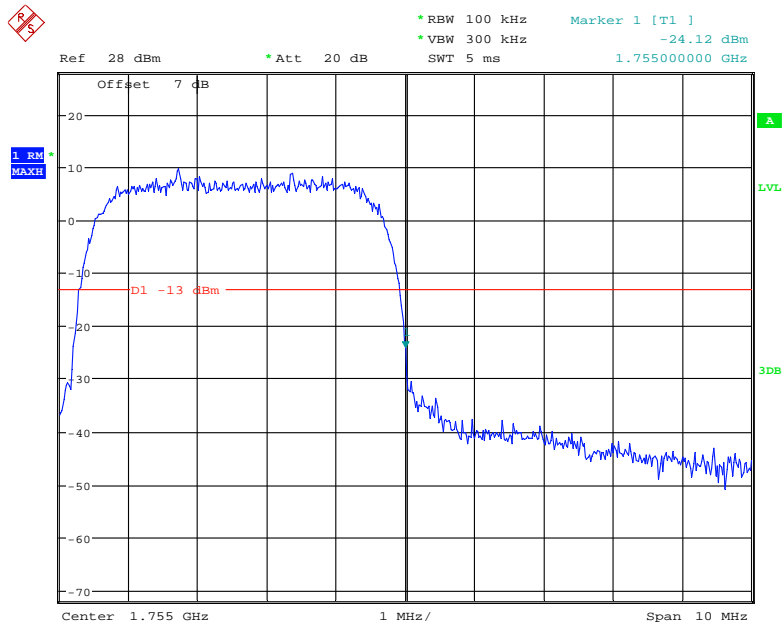

Date: 31.MAY.2021 18:23:18

**AWS Band, Left Band Edge for HSUPA (BPSK) Mode**

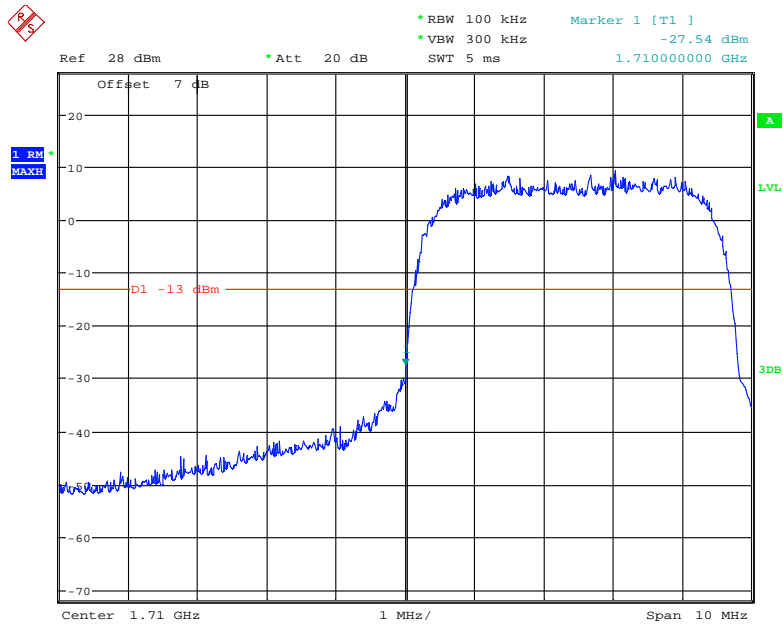

Date: 31.MAY.2021 18:38:42

**AWS Band, Right Band Edge for HSUPA (BPSK) Mode**

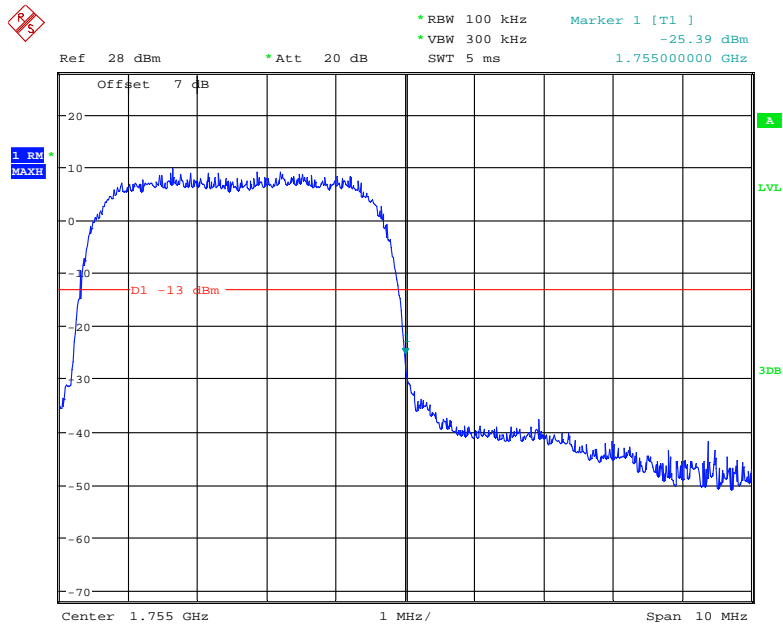

Date: 31.MAY.2021 18:40:04

The test plots of LTE bands please refer to the Appendix C.

**FCC § 2.1055; § 22.355; § 24.235; §27.54 - FREQUENCY STABILITY**

**Applicable Standard**

FCC § 2.1055, §22.355, §24.235 and & §27.54.

According to FCC §2.1055, the frequency stability shall be sufficient to ensure that the fundamental emissions stay within the authorized bands of operation.

According to §22.355, the carrier frequency of each transmitter in the Public Mobile Services must be maintained within the tolerances given in Table below:

Frequency Tolerance for Transmitters in the Public Mobile Services

Frequency Range (MHz)	Base, fixed (ppm)	Mobile ≤ 3 watts (ppm)	Mobile > 3 watts (ppm)
25 to 50	20.0	20.0	50.0
50 to 450	5.0	5.0	50.0
450 to 512	2.5	5.0	5.0
821 to 896	1.5	2.5	2.5
928 to 929.	5.0	N/A	N/A
929 to 960.	1.5	N/A	N/A
2110 to 2220	10.0	N/A	N/A

According to §24.235, the frequency stability shall be sufficient to ensure that the fundamental emissions stays within the authorized frequency block.

**Test Procedure**

Frequency Stability vs. Temperature: The equipment under test was connected to an external DC power supply and the RF output was connected to communication test set via feed-through attenuators. The EUT was placed inside the temperature chamber. The DC leads and RF output cable exited the chamber through an opening made for the purpose.

After the temperature stabilized for approximately 20 minutes, the frequency output was recorded from the communication test set.

Frequency Stability vs. Voltage: For hand carried, battery powered equipment; reduce primary supply voltage to the battery operating end point which shall be specified by the manufacturer.

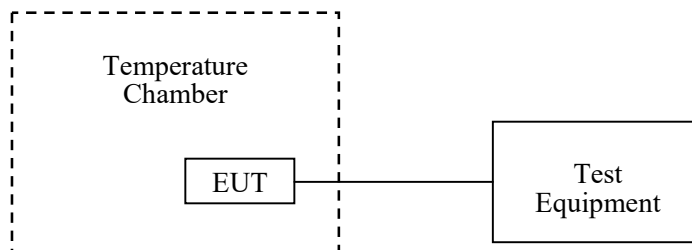

**Test Data**

**Environmental Conditions**

<b>Temperature:</b>	28.2~28.6 °C
<b>Relative Humidity:</b>	52~56 %
<b>ATM Pressure:</b>	100.9~101.0 kPa

*The testing was performed by Pedro Yun from 2021-05-05 to 2021-05-31.*

*EUT operation mode: Transmitting*

**Test Result: Pass**

*Please refer to the following tables.*

**Cellular Band (Part 22H)**

**GSM Mode**

<b>Middle Channel, <math>f_0=836.6\text{MHz}</math></b>				
<b>Temperature (°C)</b>	<b>Voltage Supplied (V<sub>DC</sub>)</b>	<b>Frequency Error (Hz)</b>	<b>Frequency Error (ppm)</b>	<b>Limit (ppm)</b>
-30	3.87	-5	-0.0060	2.5
-20		-4	-0.0048	2.5
-10		-2	-0.0024	2.5
0		-3	-0.0036	2.5
10		-4	-0.0048	2.5
20		-3	-0.0036	2.5
30		2	0.0024	2.5
40		3	0.0036	2.5
50		-4	-0.0048	2.5
20		3.45	3	0.0036
	4.4	-4	-0.0048	2.5



**EDGE Mode**

Middle Channel, $f_0 = 836.6\text{MHz}$				
Temperature (°C)	Voltage Supplied (V <sub>DC</sub> )	Frequency Error (Hz)	Frequency Error (ppm)	Limit (ppm)
-30	3.87	-3	-0.0036	2.5
-20		-5	-0.0060	2.5
-10		-7	-0.0084	2.5
0		-6	-0.0072	2.5
10		-8	-0.0096	2.5
20		-6	-0.0072	2.5
30		-5	-0.0060	2.5
40		-4	-0.0048	2.5
50		-2	-0.0024	2.5
20	3.45	-5	-0.0060	2.5
	4.4	-5	-0.0060	2.5

**WCDMA Mode**

Middle Channel, $f_0 = 836.6\text{MHz}$				
Temperature (°C)	Voltage Supplied (V <sub>DC</sub> )	Frequency Error (Hz)	Frequency Error (ppm)	Limit (ppm)
-30	3.87	5	0.0060	2.5
-20		4	0.0048	2.5
-10		7	0.0084	2.5
0		9	0.0108	2.5
10		8	0.0096	2.5
20		4	0.0048	2.5
30		6	0.0072	2.5
40		5	0.0060	2.5
50		3	0.0036	2.5
20	3.45	9	0.0108	2.5
	4.4	5	0.0060	2.5

**PCS Band (Part 24E)**

**GSM Mode**

Middle Channel, $f_0 = 1880.0$ MHz				
Temperature (°C)	Voltage Supplied (V <sub>DC</sub> )	Frequency Error (Hz)	Frequency Error (ppm)	Result
-30	3.87	4	0.0021	pass
-20		5	0.0027	pass
-10		7	0.0037	pass
0		3	0.0016	pass
10		2	0.0011	pass
20		4	0.0021	pass
30		5	0.0027	pass
40		7	0.0037	pass
50		3	0.0016	pass
20	3.45	4	0.0021	pass
	4.4	3	0.0016	pass

**EDGE Mode**

Middle Channel, $f_0 = 1880.0$ MHz				
Temperature (°C)	Voltage Supplied (V <sub>DC</sub> )	Frequency Error (Hz)	Frequency Error (ppm)	Result
-30	3.87	-6	-0.0072	pass
-20		-5	-0.0060	pass
-10		-4	-0.0048	pass
0		-7	-0.0084	pass
10		-5	-0.0060	pass
20		-2	-0.0024	pass
30		-3	-0.0036	pass
40		-5	-0.0060	pass
50		-2	-0.0024	pass
20	3.45	-6	-0.0072	pass
	4.4	-6	-0.0072	pass

**WCDMA Mode**

Middle Channel, $f_0 = 1880.0$ MHz				
Temperature (°C)	Voltage Supplied (V <sub>DC</sub> )	Frequency Error (Hz)	Frequency Error (ppm)	Result
-30	3.87	-2	-0.0011	pass
-20		-1	-0.0005	pass
-10		2	0.0011	pass
0		4	0.0021	pass
10		5	0.0027	pass
20		-2	-0.0011	pass
30		-2	-0.0011	pass
40		-4	-0.0021	pass
50		-5	-0.0027	pass
20		3.45	-2	-0.0011
	4.4	-3	-0.0016	pass

**AWS Band (Part 27)**

Temperature (°C)	Power Supplied (V <sub>DC</sub> )	F <sub>L</sub> (MHz)	F <sub>H</sub> (MHz)	F <sub>L</sub> Limit (MHz)	F <sub>H</sub> Limit (MHz)
-30	3.87	1710.0363	1754.5388	1710	1755
-20		1710.0321	1754.5379	1710	1755
-10		1710.0360	1754.5368	1710	1755
0		1710.0377	1754.5376	1710	1755
10		1710.0327	1754.5333	1710	1755
20		1710.0378	1754.5386	1710	1755
30		1710.0297	1754.5318	1710	1755
40		1710.0340	1754.5361	1710	1755
50		1710.0356	1754.5312	1710	1755
20		3.45	1710.0357	1754.5327	1710
	4.4	1710.0307	1754.5354	1710	1755

LTE:  
QPSK:

Band 2:

10.0 MHz Middle Channel, $f_0=1880\text{MHz}$				
Temperature (°C)	Voltage Supplied (V <sub>DC</sub> )	Frequency Error (Hz)	Frequency Error (ppm)	Result
-30	3.87	5.67	0.0030	pass
-20		-6.98	-0.0037	pass
-10		-6.10	-0.0032	pass
0		6.14	0.0033	pass
10		6.87	0.0037	pass
20		7.52	0.0040	pass
30		-6.42	-0.0034	pass
40		7.16	0.0038	pass
50		-8.59	-0.0046	pass
20		3.45	-7.12	-0.0038
	4.4	-8.01	-0.0043	pass

Band 4:

10 MHz Bandwidth					
Temperature (°C)	Power Supplied (V <sub>DC</sub> )	F <sub>L</sub> (MHz)	F <sub>H</sub> (MHz)	F <sub>L</sub> Limit (MHz)	F <sub>H</sub> Limit (MHz)
-30	3.87	1710.1396	1754.2662	1710	1755
-20		1710.1165	1754.2335	1710	1755
-10		1710.1275	1754.2286	1710	1755
0		1710.1395	1754.2869	1710	1755
10		1710.1452	1754.2578	1710	1755
20		1710.1378	1754.1948	1710	1755
30		1710.1395	1754.1616	1710	1755
40		1710.1475	1754.2112	1710	1755
50		1710.1379	1754.2551	1710	1755
20		3.45	1710.1426	1754.2227	1710
	4.4	1710.1442	1754.2828	1710	1755

**Band 5:**

10.0 MHz Middle Channel, $f_0=836.5\text{MHz}$				
Temperature (°C)	Voltage Supplied (V <sub>DC</sub> )	Frequency Error (Hz)	Frequency Error (ppm)	Limit (ppm)
-30	3.87	-5.35	-0.0064	2.5
-20		6.87	0.0082	2.5
-10		7.62	0.0091	2.5
0		-7.02	-0.0084	2.5
10		-6.13	-0.0073	2.5
20		-7.15	-0.0085	2.5
30		-5.75	-0.0069	2.5
40		6.44	0.0077	2.5
50		6.79	0.0081	2.5
20		3.45	8.78	0.0105
	4.4	8.86	0.0106	2.5

**Band 7:**

10 MHz Bandwidth					
Temperature (°C)	Power Supplied (V <sub>DC</sub> )	F <sub>L</sub> (MHz)	F <sub>H</sub> (MHz)	F <sub>L</sub> Limit (MHz)	F <sub>H</sub> Limit (MHz)
-30	3.87	2500.1581	2569.2498	2500	2570
-20		2500.1586	2569.2496	2500	2570
-10		2500.1529	2569.2563	2500	2570
0		2500.1510	2569.2515	2500	2570
10		2500.1589	2569.2592	2500	2570
20		2500.1553	2569.2589	2500	2570
30		2500.1521	2569.2462	2500	2570
40		2500.1458	2569.2565	2500	2570
50		2500.1413	2569.2599	2500	2570
20		3.45	2500.1415	2569.2556	2500
	4.4	2500.1431	2569.2452	2500	2570

**Band 17:**

10 MHz Bandwidth					
Temperature (°C)	Power Supplied (V <sub>DC</sub> )	F <sub>L</sub> (MHz)	F <sub>H</sub> (MHz)	F <sub>L</sub> Limit (MHz)	F <sub>H</sub> Limit (MHz)
-30	3.87	704.2688	715.5209	704	716
-20		704.2470	715.5213	704	716
-10		704.2569	715.5346	704	716
0		704.2676	715.5209	704	716
10		704.2782	715.5280	704	716
20		704.2579	715.5271	704	716
30		704.2542	715.5305	704	716
40		704.2480	715.5275	704	716
50		704.2532	715.5334	704	716
20	3.45	704.2584	715.5097	704	716
	4.4	704.2560	715.5195	704	716

**Band 38:**

10 MHz Bandwidth					
Temperature (°C)	Power Supplied (V <sub>DC</sub> )	F <sub>L</sub> (MHz)	F <sub>H</sub> (MHz)	F <sub>L</sub> Limit (MHz)	F <sub>H</sub> Limit (MHz)
-30	3.87	2570.2376	2618.9825	2570	2620
-20		2570.2315	2618.9835	2570	2620
-10		2570.2328	2618.9850	2570	2620
0		2570.2336	2618.9836	2570	2620
10		2570.2325	2618.9812	2570	2620
20		2570.2315	2618.9847	2570	2620
30		2570.2304	2618.9895	2570	2620
40		2570.2318	2618.9805	2570	2620
50		2570.2268	2618.9824	2570	2620
20	3.45	2570.2325	2618.9861	2570	2620
	4.4	2570.2398	2618.9844	2570	2620

**Band 41:**

10 MHz Bandwidth					
Temperature (°C)	Power Supplied (V <sub>DC</sub> )	F <sub>L</sub> (MHz)	F <sub>H</sub> (MHz)	F <sub>L</sub> Limit (MHz)	F <sub>H</sub> Limit (MHz)
-30	3.87	2535.2501	2654.0442	2535	2655
-20		2535.2541	2654.0595	2535	2655
-10		2535.2525	2654.0575	2535	2655
0		2535.2630	2654.0565	2535	2655
10		2535.2630	2654.0536	2535	2655
20		2535.2536	2654.0532	2535	2655
30		2535.2522	2654.0466	2535	2655
40		2535.2601	2654.0553	2535	2655
50		2535.2524	2654.0602	2535	2655
20	3.45	2535.2540	2654.0692	2535	2655
	4.4	2535.2574	2654.0654	2535	2655

Note: The applicant declared the operating frequency range is 2535-2655MHz.

**Band 66:**

10 MHz Bandwidth					
Temperature (°C)	Power Supplied (V <sub>DC</sub> )	F <sub>L</sub> (MHz)	F <sub>H</sub> (MHz)	F <sub>L</sub> Limit (MHz)	F <sub>H</sub> Limit (MHz)
-30	3.87	1710.1342	1779.0645	1710	1780
-20		1710.1315	1779.0681	1710	1780
-10		1710.1385	1779.0696	1710	1780
0		1710.1272	1779.0635	1710	1780
10		1710.1354	1779.0666	1710	1780
20		1710.1314	1779.0654	1710	1780
30		1710.1291	1779.0642	1710	1780
40		1710.1215	1779.0624	1710	1780
50		1710.1231	1779.0693	1710	1780
20		3.45	1710.1224	1779.0661	1710
	4.4	1710.1275	1779.0684	1710	1780

**16QAM:**

**Band 2:**

10.0 MHz Middle Channel, $f_0 = 1880\text{MHz}$				
Temperature (°C)	Voltage Supplied (V <sub>DC</sub> )	Frequency Error (Hz)	Frequency Error (ppm)	Result
-30	3.87	-8	-0.0043	pass
-20		-6	-0.0032	pass
-10		8	0.0043	pass
0		-5	-0.0027	pass
10		9	0.0048	pass
20		-4	-0.0021	pass
30		-6	-0.0032	pass
40		-5	-0.0027	pass
50		8	0.0043	pass
20		3.45	8	0.0043
	4.4	9	0.0048	pass

**Band 4:**

10 MHz Bandwidth					
Temperature (°C)	Power Supplied (V <sub>DC</sub> )	F <sub>L</sub> (MHz)	F <sub>H</sub> (MHz)	F <sub>L</sub> Limit (MHz)	F <sub>H</sub> Limit (MHz)
-30	3.87	1710.1584	1754.3641	1710	1755
-20		1710.1451	1754.3582	1710	1755
-10		1710.1572	1754.3642	1710	1755
0		1710.1521	1754.3581	1710	1755
10		1710.1454	1754.3575	1710	1755
20		1710.1412	1754.3688	1710	1755
30		1710.1454	1754.3497	1710	1755
40		1710.1421	1754.3456	1710	1755
50		1710.1484	1754.3675	1710	1755
20		3.45	1710.1475	1754.3598	1710
	4.4	1710.1482	1754.3668	1710	1755



**Band 5:**

10.0 MHz Middle Channel, $f_0=836.5\text{MHz}$				
Temperature (°C)	Voltage Supplied (V <sub>DC</sub> )	Frequency Error (Hz)	Frequency Error (ppm)	Limit (ppm)
-30	3.87	-3	-0.0036	2.5
-20		6	0.0072	2.5
-10		-9	-0.0108	2.5
0		-8	-0.0096	2.5
10		-9	-0.0108	2.5
20		-9	-0.0108	2.5
30		8	0.0096	2.5
40		6	0.0072	2.5
50		-5	-0.0060	2.5
20		3.45	8	0.0096
	4.4	-5	-0.0060	2.5

**Band 7:**

10 MHz Bandwidth					
Temperature (°C)	Power Supplied (V <sub>DC</sub> )	F <sub>L</sub> (MHz)	F <sub>H</sub> (MHz)	F <sub>L</sub> Limit (MHz)	F <sub>H</sub> Limit (MHz)
-30	3.87	2500.2523	2569.0536	2500	2570
-20		2500.2524	2569.0664	2500	2570
-10		2500.2502	2569.0586	2500	2570
0		2500.2596	2569.0683	2500	2570
10		2500.2577	2569.0615	2500	2570
20		2500.2455	2569.0575	2500	2570
30		2500.2575	2569.0525	2500	2570
40		2500.2442	2569.0535	2500	2570
50		2500.2415	2569.0699	2500	2570
20		3.45	2500.2535	2569.0526	2500
	4.4	2500.2442	2569.0482	2500	2570

**Band 17:**

10 MHz Bandwidth					
Temperature (°C)	Power Supplied (V <sub>DC</sub> )	F <sub>L</sub> (MHz)	F <sub>H</sub> (MHz)	F <sub>L</sub> Limit (MHz)	F <sub>H</sub> Limit (MHz)
-30	3.87	704.0688	715.5609	704	716
-20		704.0470	715.5613	704	716
-10		704.0469	715.5246	704	716
0		704.0376	715.5019	704	716
10		704.0482	715.4980	704	716
20		704.0579	715.5071	704	716
30		704.0542	715.5005	704	716
40		704.0380	715.5275	704	716
50		704.0332	715.5334	704	716
20	3.45	704.0584	715.4997	704	716
	4.4	704.0260	715.5195	704	716

**Band 38:**

10 MHz Bandwidth					
Temperature (°C)	Power Supplied (V <sub>DC</sub> )	F <sub>L</sub> (MHz)	F <sub>H</sub> (MHz)	F <sub>L</sub> Limit (MHz)	F <sub>H</sub> Limit (MHz)
-30	3.87	2570.5367	2619.0325	2570	2620
-20		2570.5311	2619.0335	2570	2620
-10		2570.5327	2619.0350	2570	2620
0		2570.5333	2619.0336	2570	2620
10		2570.5320	2619.0312	2570	2620
20		2570.5313	2619.0347	2570	2620
30		2570.5309	2619.0295	2570	2620
40		2570.5318	2619.0305	2570	2620
50		2570.5299	2619.0324	2570	2620
20	3.45	2570.5369	2619.0361	2570	2620
	4.4	2570.5332	2619.0344	2570	2620

**Band 41:**

10 MHz Bandwidth					
Temperature (°C)	Power Supplied (V <sub>DC</sub> )	F <sub>L</sub> (MHz)	F <sub>H</sub> (MHz)	F <sub>L</sub> Limit (MHz)	F <sub>H</sub> Limit (MHz)
-30	3.87	2535.2401	2654.0542	2535	2655
-20		2535.2541	2654.0595	2535	2655
-10		2535.2625	2654.0575	2535	2655
0		2535.2130	2654.0565	2535	2655
10		2535.2130	2654.0436	2535	2655
20		2535.2036	2654.0532	2535	2655
30		2535.2022	2654.0466	2535	2655
40		2535.2901	2654.0453	2535	2655
50		2535.2624	2654.0402	2535	2655
20	3.45	2535.2840	2654.0592	2535	2655
	4.4	2535.2274	2654.0554	2535	2655

Note: The applicant declared the operating frequency range is 2535-2655MHz.

**Band 66:**

10 MHz Bandwidth					
Temperature (°C)	Power Supplied (V <sub>DC</sub> )	F <sub>L</sub> (MHz)	F <sub>H</sub> (MHz)	F <sub>L</sub> Limit (MHz)	F <sub>H</sub> Limit (MHz)
-30	3.87	1710.1472	1779.0286	1710	1780
-20		1710.1416	1779.0252	1710	1780
-10		1710.1315	1779.0289	1710	1780
0		1710.1365	1779.0231	1710	1780
10		1710.1313	1779.0241	1710	1780
20		1710.1497	1779.0221	1710	1780
30		1710.1324	1779.0334	1710	1780
40		1710.1351	1779.0382	1710	1780
50		1710.1498	1779.0399	1710	1780
20	3.45	1710.1331	1779.0281	1710	1780
	4.4	1710.1324	1779.0216	1710	1780

\*\*\*\*\* END OF REPORT \*\*\*\*\*