



FCC ID

WIFI Test Report

Application Purpose : Original grant
Applicant Name: : TECNO MOBILE LIMITED
FCC ID : 2ADYY-PHANTOMZMINI
Equipment Type : Mobile Phone
Model Name : PHANTOM Z mini
Report Number : FCC15016722-5
Standard(S) : FCC Part 15 Subpart C
Date Of Receipt : January 16, 2015
Date Of Issue : January 29, 2015

Test By : 

(Neil Wong)

Reviewed By : 

(Robie Chen)

Authorized by : 

(Michal Ling)

Prepared by : **Shenzhen WST Testing Technology Co., Ltd.**
1F, No.9 Building, TGK Science & Technology Park Yangtian
Rd., NO.72 Bao'an Dist., Guangdong, China
(Registration Number: 939433)

REPORT REVISE RECORD

Report Version	Revise Time	Issued Date	Valid Version	Notes
V1.0	/	January 29, 2015	Valid	Original Report

Table of Contents	Page
1. GENERAL INFORMATION	5
2. TEST DESCRIPTION	7
2.1 MEASUREMENT UNCERTAINTY	7
2.2 DESCRIPTION OF TEST MODES	8
2.3 TABLE OF PARAMETERS OF TEXT SOFTWARE SETTING	9
2.4 CONFIGURATION OF SYSTEM UNDER TEST	9
2.5 DESCRIPTION OF SUPPORT UNITS (CONDUCTED MODE)	9
3. SUMMARY OF TEST RESULTS	10
4. MEASUREMENT INSTRUMENTS	11
5. EMC EMISSION TEST	12
5.1 CONDUCTED EMISSION MEASUREMENT	12
5.1.1 POWER LINE CONDUCTED EMISSION LIMITS	12
5.1.2 TEST PROCEDURE	13
5.1.3 DEVIATION FROM TEST STANDARD	13
5.1.4 TEST SETUP	13
5.1.5 EUT OPERATING CONDITIONS	13
5.1.6 TEST RESULTS	14
5.2 RADIATED EMISSION MEASUREMENT	16
5.2.1 RADIATED EMISSION LIMITS	16
5.2.2 TEST PROCEDURE	16
5.2.3 DEVIATION FROM TEST STANDARD	17
5.2.4 TEST SETUP	18
5.2.5 EUT OPERATING CONDITIONS	19
5.2.5.1 RESULTS (BELOW 30 MHZ)	20
5.2.5.2 TEST RESULTS (BETWEEN 30M – 1000 MHZ)	21
5.2.5.3 TEST RESULTS (1GHZ TO 25GHZ)	23
6. ANTENNA APPLICATION	29
7.0. 6DB BANDWIDTH MEASUREMENT	42
7.1 TEST SETUP	42
7.2 LIMITS OF 6DB BANDWIDTH MEASUREMENT	42
7.3 TEST PROCEDURE	42
8.0. MAXIMUM PEAK OUTPUT POWER	50
8.1 TEST SETUP	50
8.2 LIMITS OF MAXIMUM PEAK OUTPUT POWER	50
8.3 TEST PROCEDURE	50

Table of Contents	Page
9. POWER SPECTRAL DENSITY MEASUREMENT	57
9.1 TEST SETUP	57
9.2 LIMITS OF POWER SPECTRAL DENSITY MEASUREMENT	57
9.3 TEST PROCEDURE	57
9.4 TEST RESULT	58
10. OUT OF BAND MEASUREMENT	65
10.1 TEST SETUP FOR BAND EDGE	65
10.2 LIMITS OF OUT OF BAND EMISSIONS MEASUREMENT	65
10.4 TEST RESULT	65
11. EUT TEST PHOTO	72
12. PHOTOGRAPHS OF EUT	74

1. GENERAL INFORMATION

GENERAL DESCRIPTION OF EUT

Test Model	PHANTOM Z mini
Applicant	TECNO MOBILE LIMITED
Address	RMS 05-15, 13A/F., SOUTH TOWER, WORLD FINANCE CTR, HARBOUR CITY, KLN, HK.
Manufacturer	SHENZHEN SMARTTEL CO., LTD.
Address	6th Floor, Block 15, shatoujiao Free TRADE Zone, Shenyang Road, Yantian District, Shenzhen, Guangdong, P.R.China
Equipment Type	Mobile Phone
Brand Name	TECNO
Hardware version:	G870_MAIN_PCB_V1.1
Software version:	V1.1
Extreme Temp. Tolerance	-10°C to +50°C
Battery information:	Model: BL-24CT Voltage: 3.8V Capacity: 2420mAh
Adapter Information:	Model: A88-502000 Input: AC100-240 V, 50/60 Hz, 0.35A Output: DC 5V 2.0A
Operating Frequency	2412-2462MHz
Channels	11
Channel Spacing	5MHz
Modulation Type	CCK for IEEE 802.11b OFDM for IEEE 802.11g/n HT-20/n HT-40
Antenna Type:	Integral Antenna
Antenna gain:	1.55dBi
Data of receipt	January 16, 2015
Date of test	January 16, 2015 to January 29, 2015
Deviation	None
Condition of Test Sample	Normal

We hereby certify that:

All measurement facilities used to collect the measurement data are located at
1F, No.9 Building, TKG Science & Technology Park Yangtian Rd., NO.72 Bao'an Dist., GuangDong, China

The data evaluation, test procedures, and equipment configurations shown in this report were made in accordance with the procedures given in ANSI C 63.4:2009. The sample tested as described in this report is in compliance with the FCC Rules Part15 Subpart C.

The test results of this report relate only to the tested sample identified in this report.

2. TEST DESCRIPTION

2.1 MEASUREMENT UNCERTAINTY

The reported uncertainty of measurement $y \pm U$, where expanded uncertainty U is based on a standard uncertainty multiplied by a coverage factor of $k=2$, providing a level of confidence of approximately **95 %**.

No.	Item	Uncertainty
1	Conducted Emission Test	$\pm 3.2\text{dB}$
2	RF power, conducted	$\pm 0.16\text{dB}$
3	Spurious emissions, conducted	$\pm 0.21\text{dB}$
4	All emissions, radiated(<1G)	$\pm 4.7\text{dB}$
5	All emissions, radiated(>1G)	$\pm 4.7\text{dB}$
6	Temperature	$\pm 0.5^\circ\text{C}$
7	Humidity	$\pm 2\%$

2.2 DESCRIPTION OF TEST MODES

To investigate the maximum EMI emission characteristics generated from EUT, the test system was pre-scanning tested based on the consideration of following EUT operation mode or test configuration mode which possibly have effect on EMI emission level. Each of these EUT operation mode(s) or test configuration mode(s) mentioned above was evaluated respectively.

Pretest Mode	Description
Mode 1	802.11b
Mode 2	802.11g
Mode 3	802.11n20
Mode 4	802.11n40
Mode 5	Keep WIFI Transmitting

For Conducted Emission	
Final Test Mode	Description
Mode 5	Keep WIFI Transmitting

For Radiated Emission	
Final Test Mode	Description
Mode 1	802.11b
Mode 2	802.11g
Mode 3	802.11n20
Mode 4	802.11n40
Mode 5	Keep WIFI Transmitting

Note:

- (1) The measurements are performed at the highest, middle, lowest available channels.**
- (2) Record the worst case of each test item in this report.**
- (3) The EUT was programmed to be in continuously transmitting mode and the transmit duty cycle is not less than 98%**
- (4) Keep WIFI Transmitting is that the EUT was controlled by fixed-frequency software.**

2.3 TABLE OF PARAMETERS OF TEXT SOFTWARE SETTING

During testing channel & power controlling software provided by the customer was used to control the operating channel as well as the output power level. The RF output power selection is for the setting of RF output power expected by the customer and is going to be fixed on the firmware of the final end product power parameters of DSSS.

Test software Version	N/A
Test program	*#9646633#

Frequency(802.11b/g/n20)	2412 MHz	2437 MHz	2462 MHz
Frequency(802.11n40)	2422 MHz	2437 MHz	2452 MHz

2.4 CONFIGURATION OF SYSTEM UNDER TEST

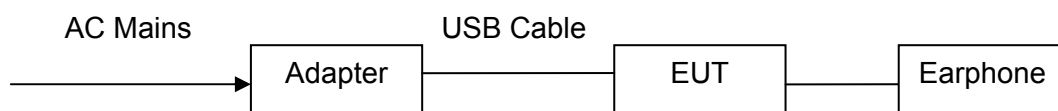

(EUT: Mobile Phone)

I/O Port of EUT			
I/O Port Type	Q'TY	Cable	Tested with
USB port	1	0.3m USB cable, unshielded	1
Earphone	1	1m	1

2.5 DESCRIPTION OF SUPPORT UNITS (CONDUCTED MODE)

The EUT has been tested as an independent unit together with other necessary accessories or support units. The following support units or accessories were used to form a representative test configuration during the tests.

Item	Equipment	Mfr/Brand	Model/Type No.	Series No.	Note
1	/	/	/	/	/

Note:

- (1) The support equipment was authorized by Declaration of Confirmation.
- (2) During test, the power level, channel, bandwidth and rate of WIFI transmitting are controlled by fixed-frequency software.

3. SUMMARY OF TEST RESULTS

Test procedures according to the technical standards:

FCC Part15 (15.247) , Subpart C			
Standard Section	Test Item	Judgment	Remark
15.107 & 15.207	Conducted Emission Test	PASS	Complies
15.247(a)(2) Limit	Spectrum bandwidth of a Orthogonal Frequency Division Multiplex System Limit: 6dB bandwidth>500kHz	PASS	Complies
15.247(b)	Maximum peak outputpower Limit: max. 30dBm	PASS	Complies
15.109,15.205 & 15.209	Transmitter Radiated Emission Limit: Table 15.209	PASS	Complies
15.247(e)	Power Spectral Density Limit: max. 8dBm	PASS	Complies
15.247(d)	Out of Band Emission and Restricted Band Radiation Limit: 20dB less than peak value of fundamental frequency Restricted band limit: Table 15.209	PASS	Complies

NOTE:

(1) "N/A" denotes test is not applicable in this test report.

4. MEASUREMENT INSTRUMENTS

NAME OF EQUIPMENT	MANUFACTURER	MODEL	SERIAL NUMBER	Calibration Date	Calibration Due.
EMI Test Receiver	R&S	ESCI	100005	08/19/2014	08/18/2015
ESPI Test Receiver	ROHDE&SCHWARZ	ESPI	101139	08/19/2014	08/18/2015
LISN	AFJ	LS16	16010222119	08/19/2014	08/18/2015
LISN(EUT)	Mestec	AN3016	04/10040	08/19/2014	08/18/2015
Universal Radio Communication Tester	R&S	CMU 200	1100.0008.02	08/19/2014	08/18/2015
Coaxial cable	Megalon	LMR400	N/A	08/12/2014	08/11/2015
GPIB cable	Megalon	GPIB	N/A	08/12/2014	08/11/2015
Spectrum Analyzer	R&S	FSU	100114	08/19/2014	08/18/2015
Pre Amplifier	H.P.	HP8447E	2945A02715	10/13/2014	10/12/2015
Pre-Amplifier	CDSI	PAP-1G18-38	--	10/13/2014	10/12/2015
Bi-log Antenna	SUNOL Sciences	JB3	A021907	09/13/2014	09/12/2015
9*6*6 Anechoic	--	--	--	08/21/2014	08/20/2015
Horn Antenna	COMPLIANCE ENGINEERING	CE18000	--	09/13/2014	09/12/2015
Horn Antenna	SCHWARZBECK	BBHA9120D	9120D-631	08/23/2014	08/22/2015
Cable	TIME MICROWAVE	LMR-400	N-TYPE04	04/25/2014	04/24/2015
System-Controller	CCS	N/A	N/A	N.C.R	N.C.R
Turn Table	CCS	N/A	N/A	N.C.R	N.C.R
Antenna Tower	CCS	N/A	N/A	N.C.R	N.C.R
RF cable	Murata	MXHQ87WA3000	-	08/21/2014	08/20/2015
Loop Antenna	EMCO	6502	00042960	08/22/2014	08/21/2015
Horn Antenna	SCHWARZBECK	BBHA 9170	1123	08/19/2014	08/18/2015
Power meter	Anritsu	ML2487A	6K00003613	08/23/2014	08/22/2015
Power sensor	Anritsu	MX248XD	--	08/19/2014	08/18/2015

5. EMC EMISSION TEST

5.1 CONDUCTED EMISSION MEASUREMENT

5.1.1 POWER LINE CONDUCTED EMISSION Limits (Frequency Range 150KHz-30MHz)

FREQUENCY (MHz)	Class A (dBuV)		Class B (dBuV)		Standard
	Quasi-peak	Average	Quasi-peak	Average	
0.15 -0.5	79.00	66.00	66 - 56 *	56 - 46 *	FCC
0.50 -5.0	73.00	60.00	56.00	46.00	FCC
5.0 -30.0	73.00	60.00	60.00	50.00	FCC

Note:

- (1) The tighter limit applies at the band edges.
- (2) The limit of " * " marked band means the limitation decreases linearly with the logarithm of the frequency in the range.

The following table is the setting of the receiver

Receiver Parameters	Setting
Attenuation	10 dB
Start Frequency	0.15 MHz
Stop Frequency	30 MHz
IF Bandwidth	9 kHz

5.1.2 TEST PROCEDURE

- The EUT was placed 0.4 meters from the horizontal ground plane with EUT being connected to the power mains through a line impedance stabilization network (LISN). All other support equipments powered from additional LISN(s). The LISN provide 50 Ohm/ 50uH of coupling impedance for the measuring instrument.
- Interconnecting cables that hang closer than 40 cm to the ground plane shall be folded back and forth in the center forming a bundle 30 to 40 cm long.
- I/O cables that are not connected to a peripheral shall be bundled in the center. The end of the cable may be terminated, if required, using the correct terminating impedance. The overall length shall not exceed 1 m.
- LISN at least 80 cm from nearest part of EUT chassis.
- For the actual test configuration, please refer to the related Item –EUT Test Photos.

5.1.3 DEVIATION FROM TEST STANDARD

No deviation

5.1.4 TEST SETUP

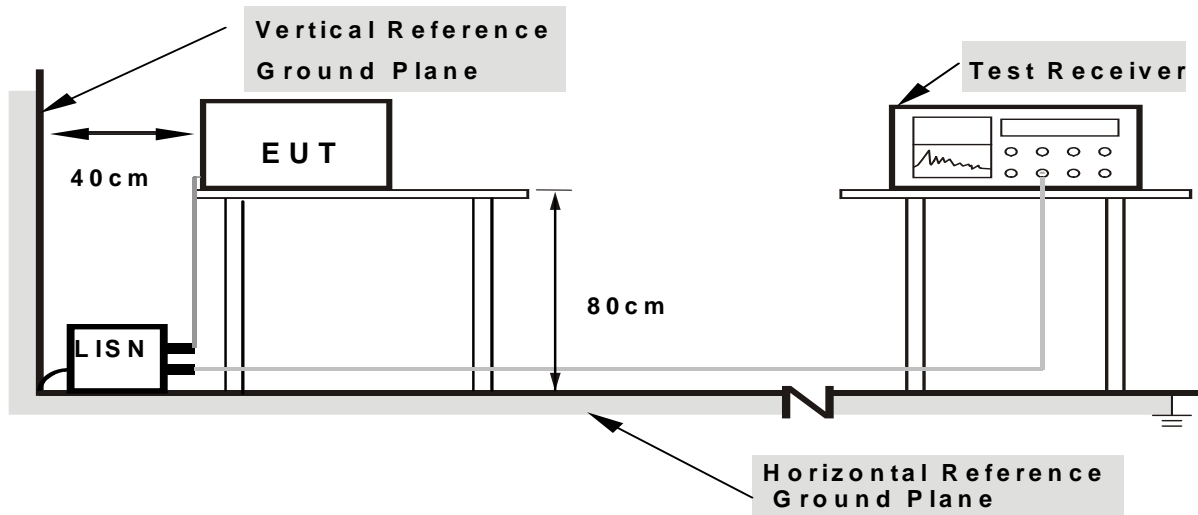

- Note:**
- Support units were connected to second LISN.
 - Both of LISNs (AMN) are 80 cm from EUT and at least 80 cm from other units and other metal planes

5.1.5 EUT OPERATING CONDITIONS

The EUT was configured for testing in a typical fashion (as a customer would normally use it). The EUT has been programmed to continuously transmit during test. This operating condition was tested and used to collect the included data.

5.1.6 TEST RESULTS

EUT	Mobile Phone	Model Name	PHANTOM Z mini
Temperature	26 °C	Relative Humidity	54%
Pressure	1010hPa	Phase	L
Test Date	January 23, 2015	Test Mode	Keep WIFI Transmitting
Voltage	120V/60Hz		

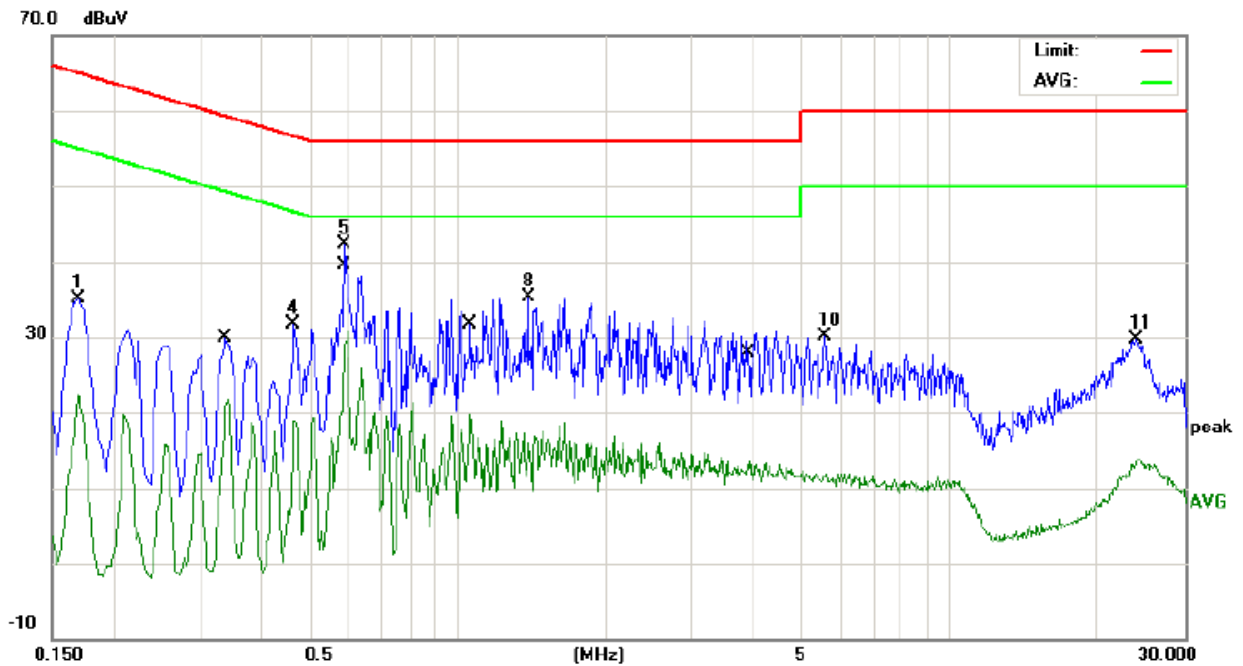

No.	Mk.	Freq. MHz	Reading Level dBuV	Correct Factor dB	Measure- ment dBuV	Limit dBuV	Over dB	Detector
1		0.1700	35.08	0.00	35.08	64.96	-29.88	peak
2		0.1700	22.35	0.00	22.35	54.96	-32.61	AVG
3		0.3420	21.69	0.00	21.69	49.15	-27.46	AVG
4		0.4660	31.78	0.00	31.78	56.58	-24.80	peak
5	*	0.5899	42.32	0.00	42.32	56.00	-13.68	peak
6		0.5980	30.72	0.00	30.72	46.00	-15.28	AVG
7		1.0620	19.67	0.00	19.67	46.00	-26.33	AVG
8		1.3900	35.23	0.00	35.23	56.00	-20.77	peak
9		3.9100	13.45	0.00	13.45	46.00	-32.55	AVG
10		5.5739	30.03	0.00	30.03	60.00	-29.97	peak
11		23.9900	29.64	0.00	29.64	60.00	-30.36	peak
12		24.0900	13.77	0.00	13.77	50.00	-36.23	AVG

Remark: All the modes have been investigated, and only worst mode is presented in this report.

EUT	Mobile Phone	Model Name	PHANTOM Z mini
Temperature	26 °C	Relative Humidity	54%
Pressure	1010hPa	Phase	N
Test Date	January 23, 2015	Test Mode	Keep WIFI Transmitting
Voltage	120V/60Hz		

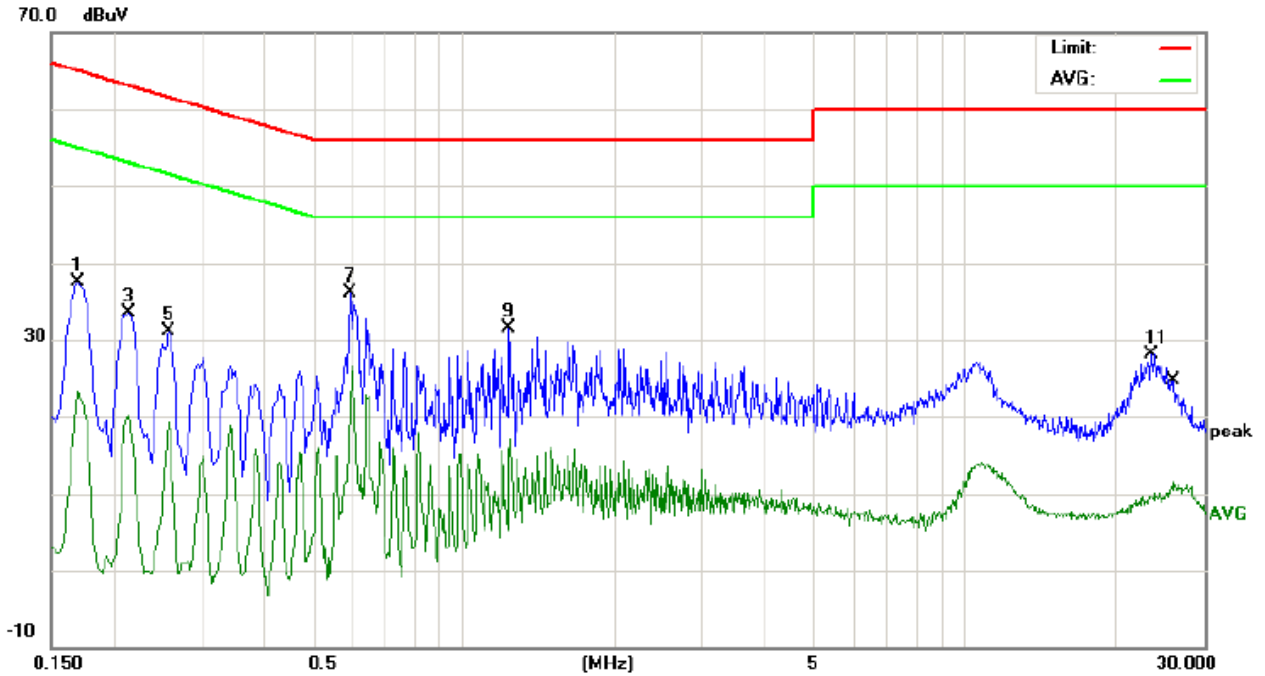

No.	Mk.	Freq. MHz	Reading Level dBuV	Correct Factor dB	Measure- ment dBuV	Limit dBuV	Over dB	Detector
1		0.1700	37.57	0.00	37.57	64.96	-27.39	peak
2		0.1700	23.26	0.00	23.26	54.96	-31.70	AVG
3		0.2140	33.41	0.00	33.41	63.04	-29.63	peak
4		0.2140	20.01	0.00	20.01	53.04	-33.03	AVG
5		0.2580	31.03	0.00	31.03	61.49	-30.46	peak
6		0.2580	19.33	0.00	19.33	51.49	-32.16	AVG
7		0.5940	36.13	0.00	36.13	56.00	-19.87	peak
8	*	0.5980	26.71	0.00	26.71	46.00	-19.29	AVG
9		1.2340	31.41	0.00	31.41	56.00	-24.59	peak
10		1.2380	17.11	0.00	17.11	46.00	-28.89	AVG
11		23.5180	28.19	0.00	28.19	60.00	-31.81	peak
12		26.0380	11.45	0.00	11.45	50.00	-38.55	AVG

Remark: All the modes have been investigated, and only worst mode is presented in this report.

5.2 RADIATED EMISSION MEASUREMENT

5.2.1 RADIATED EMISSION LIMITS (Frequency Range 9kHz-1000MHz)

20dBc in any 100 kHz bandwidth outside the operating frequency band. In case the emission fall within the restricted band specified on 15.205(a), then the 15.209(a) limit in the table below has to be followed.

Frequencies (MHz)	Field Strength (micorvolts/meter)	Measurement Distance (meters)
0.009~0.490	2400/F(KHz)	300
0.490~1.705	24000/F(KHz)	30
1.705~30.0	30	30
30~88	100	3
88~216	150	3
216~960	200	3
Above 960	500	3

LIMITS OF RADIATED EMISSION MEASUREMENT (Above 1000MHz)

FREQUENCY (MHz)	Limit (dBuV/m) (at 3M)	
	PEAK	AVERAGE
Above 1000	74	54

Notes:

- (1) The limit for radiated test was performed according to FCC PART 15C.
- (2) The tighter limit applies at the band edges.
- (3) Emission level (dBuV/m)=20log Emission level (uV/m).

Spectrum Parameter	Setting
Attenuation	Auto
Start Frequency	1000 MHz
Stop Frequency	10th carrier harmonic
RB / VB (emission in restricted band)	1 MHz / 1 MHz for Peak, 1 MHz / 10Hz for Average

Receiver Parameter	Setting
Attenuation	Auto
Start ~ Stop Frequency	9kHz~150kHz / RB 200Hz for QP
Start ~ Stop Frequency	150kHz~30MHz / RB 9kHz for QP
Start ~ Stop Frequency	30MHz~1000MHz / RB 120kHz for QP

5.2.2 TEST PROCEDURE

- a. The measuring distance of at 3 m shall be used for measurements at frequency up to 1GHz. For frequencies above 1GHz, any suitable measuring distance may be used.

- b. The EUT was placed on the top of a rotating table 0.8 meters above the ground at a 3 meter open area test site. The table was rotated 360 degrees to determine the position of the highest radiation.
- c. The height of the equipment or of the substitution antenna shall be 0.8 m; the height of the test antenna shall vary between 1 m to 4 m. Both horizontal and vertical polarizations of the antenna are set to make the measurement.
- d. The initial step in collecting conducted emission data is a spectrum analyzer peak detector mode pre-scanning the measurement frequency range. Significant peaks are then marked and then Quasi Peak detector mode re-measured.
- e. If the Peak Mode measured value compliance with and lower than Quasi Peak Mode Limit, the EUT shall be deemed to meet QP Limits and then no additional QP Mode measurement performed.
- f. For the actual test configuration, please refer to the related Item –EUT Test Photos.

Note:

Both horizontal and vertical antenna polarities were tested and performed pretest to three orthogonal axis. The worst case emissions were reported

5.2.3 DEVIATION FROM TEST STANDARD

No deviation

5.2.4 TEST SETUP

(A) Radiated Emission Test-Up Frequency Below 30MHz

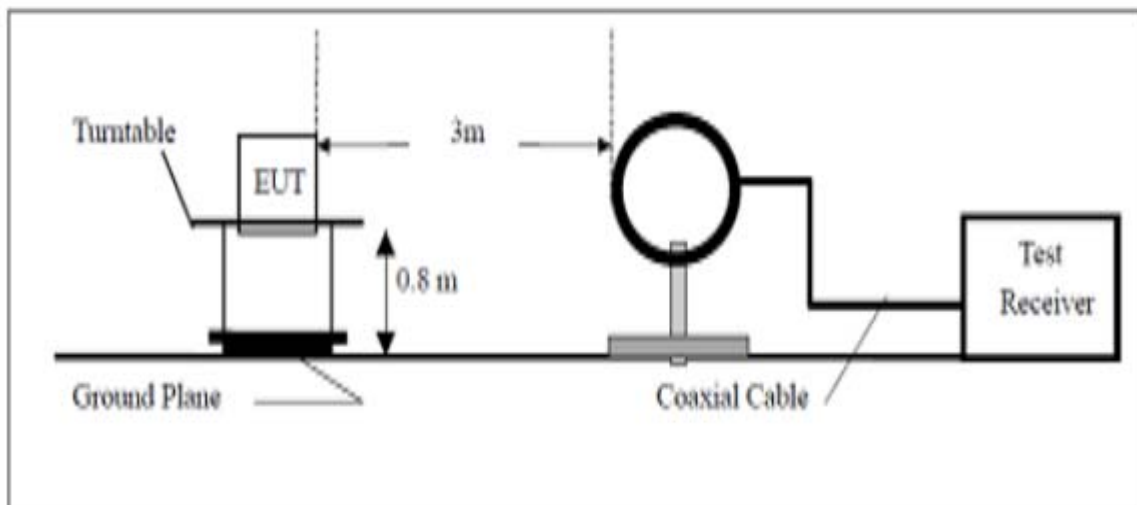

(B) Radiated Emission Test-Up Frequency 30MHz~1GHz

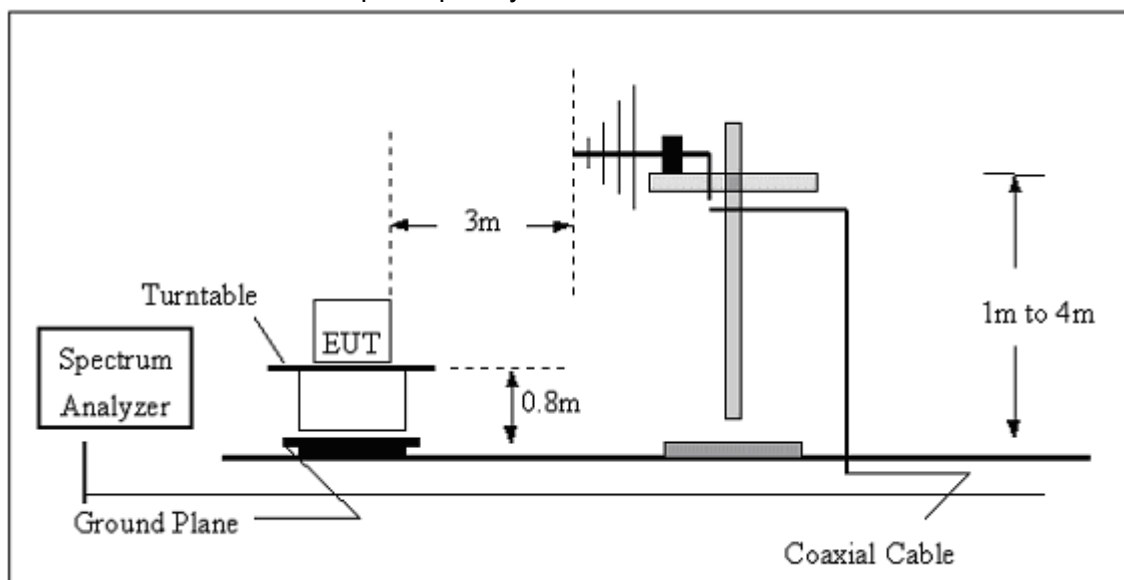

(C) Radiated Emission Test-Up Frequency Above 1GHz

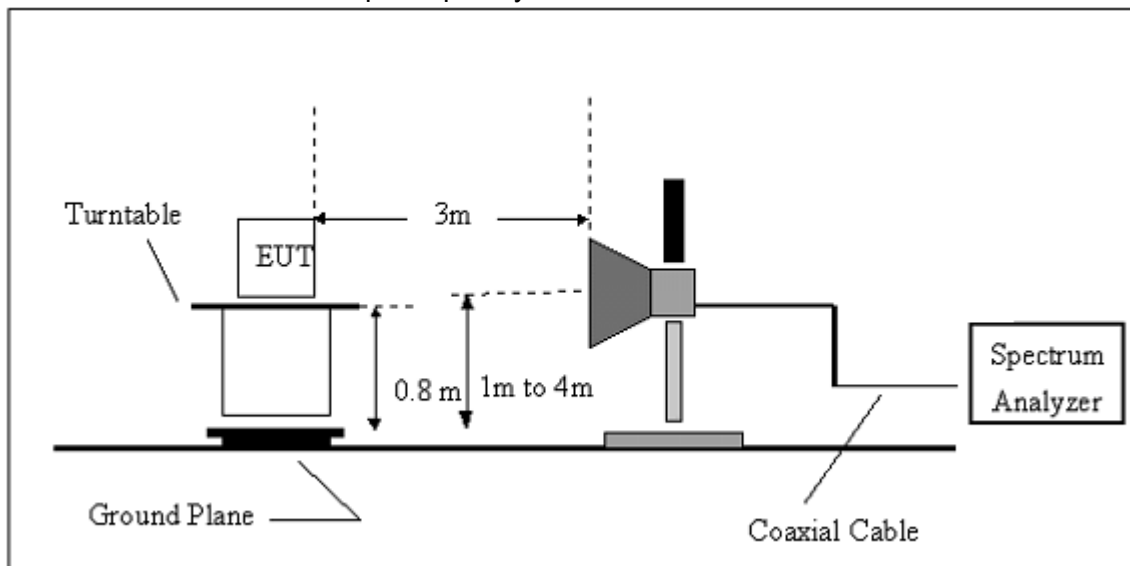
**5.2.5 EUT OPERATING CONDITIONS**

The EUT tested system was configured as the statements of 2.4 Unless otherwise a special operating condition is specified in the follows during the testing.

5.2.5.1 RESULTS (BELOW 30 MHZ)

EUT	Mobile Phone	Model Name	PHANTOM Z mini
Temperature	20 °C	Relative Humidity	48%
Pressure	1010 hPa	Polarization	---
Test Mode	Keep WIFI Transmitting	Test Date	January 24, 2015

Freq. (MHz)	Reading (dBuV/m)	Limit (dBuV/m)	Margin (dB)	State P/F
--	--	--	--	P
--	--	--	--	P

NOTE:

No result in this part for margin above 20dB.

Distance extrapolation factor = $20 \log(\text{specific distance}/\text{test distance})$ (dB);

Limit line = specific limits(dBuV) + distance extrapolation factor.

All the x/y/z orientation has been investigated, and only worst case is presented in this report.

5.2.5.2 TEST RESULTS (BETWEEN 30M – 1000 MHZ)

EUT	Mobile Phone	Model Name	PHANTOM Z mini
Temperature	20 °C	Relative Humidity	48%
Pressure	1010 hPa	Polarization :	Horizontal
Test Mode	Keep WIFI Transmitting	Test Date	January 24, 2015

70.0 dBuV/m

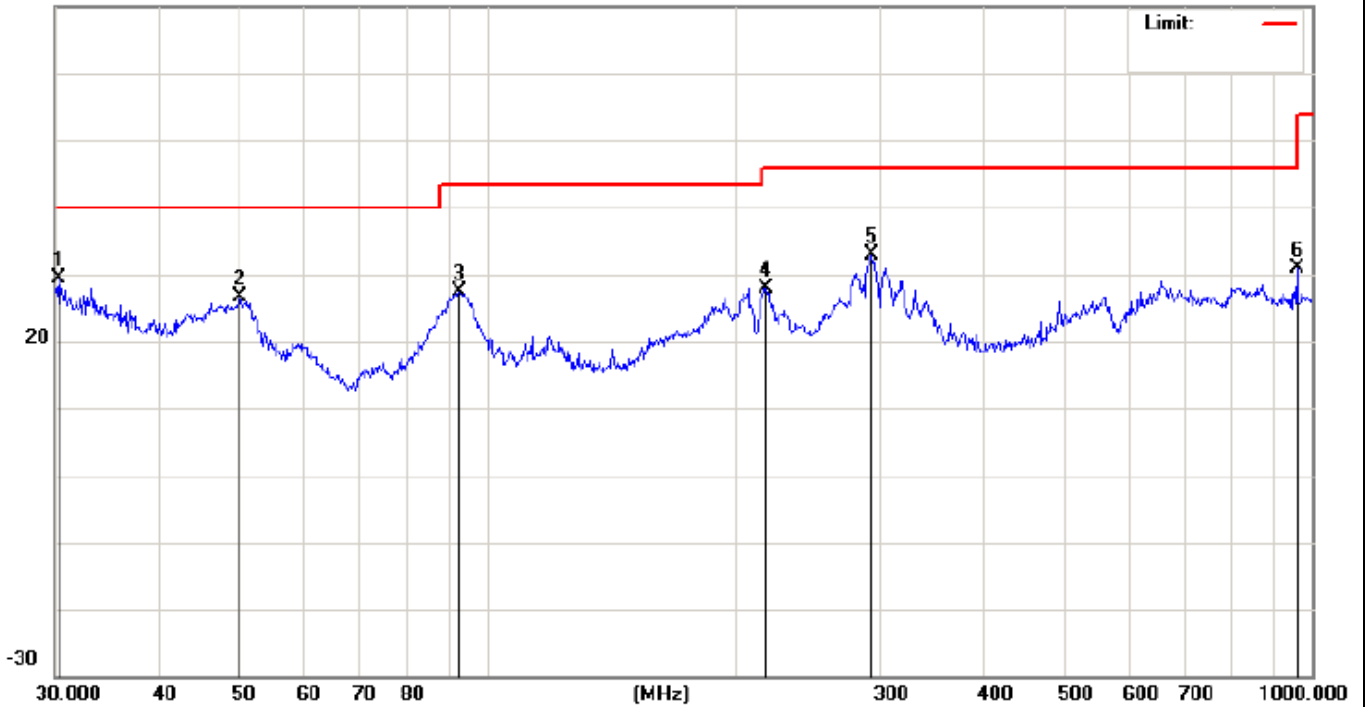

No.	Mk.	Freq. MHz	Reading Level dBuV	Correct Factor dB	Measure- ment dBuV/m	Limit dBuV/m	Over dB	Detector
1	*	30.3173	26.18	3.29	29.47	40.00	-10.53	peak
2		50.2324	33.83	-7.25	26.58	40.00	-13.42	peak
3		92.7871	37.51	-10.09	27.42	43.50	-16.08	peak
4		218.3085	34.28	-6.30	27.98	46.00	-18.02	peak
5		293.0842	36.11	-3.19	32.92	46.00	-13.08	peak
6		958.7943	27.28	3.55	30.83	46.00	-15.17	peak

Remark: All the modes have been investigated, and only worst mode is presented in this report.

EUT	Mobile Phone	Model Name	PHANTOM Z mini
Temperature	20 °C	Relative Humidity	48%
Pressure	1010 hPa	Polarization :	Vertical
Test Mode	Keep WIFI Transmitting	Test Date	January 24, 2015

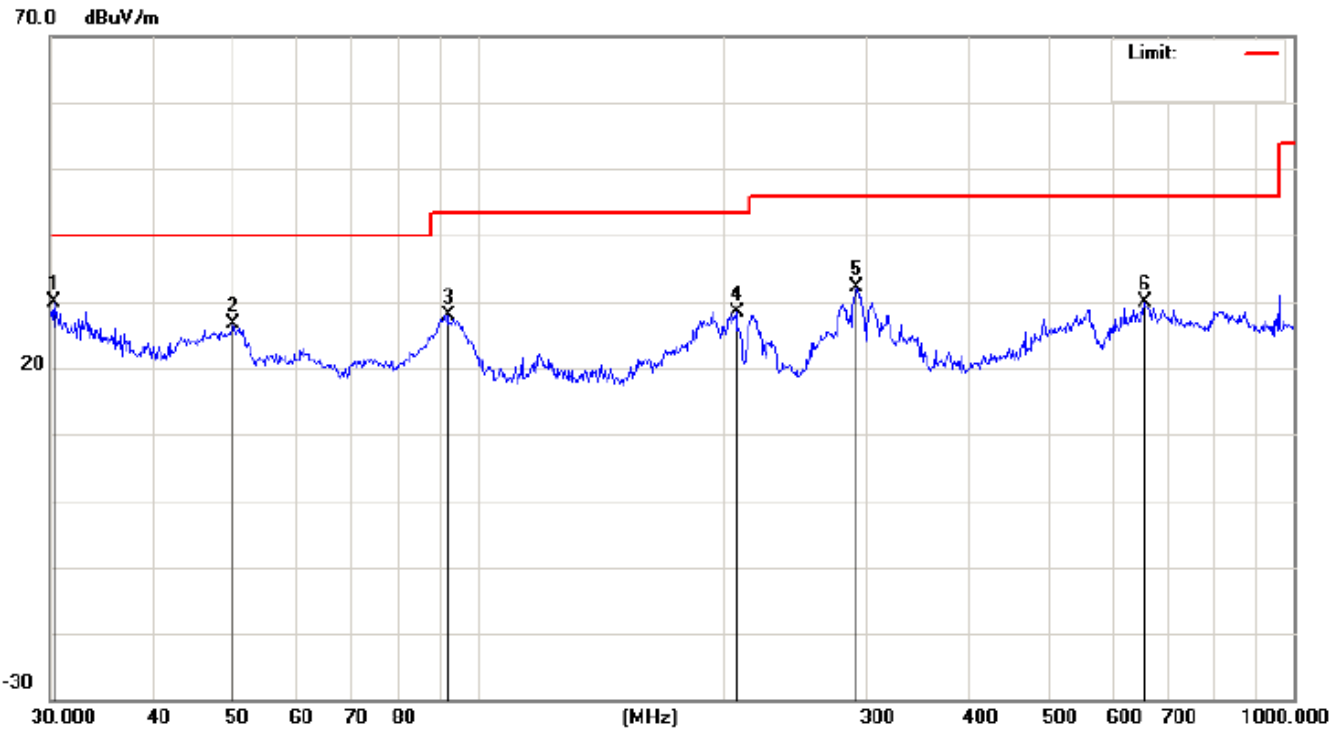

No.	Mk.	Freq. MHz	Reading Level dBuV	Correct Factor dB	Measure- ment dBuV/m	Limit dBuV/m	Over dB	Detector
1		30.0000	33.58	-3.47	30.11	40.00	-9.89	peak
2	*	54.8348	50.97	-18.39	32.58	40.00	-7.42	peak
3		91.8163	46.69	-14.49	32.20	43.50	-11.30	peak
4		163.1818	32.94	-4.95	27.99	43.50	-15.51	peak
5		295.1469	31.14	-3.94	27.20	46.00	-18.80	peak
6		979.1804	24.28	6.61	30.89	54.00	-23.11	peak

Remark: All the modes have been investigated, and only worst mode is presented in this report.

5.2.5.3 TEST RESULTS (1GHZ TO 25GHZ)

Note: *the worst case is 1Mbps(GFSK)mode as result in this part.*

EUT	Mobile Phone	Model Name	PHANTOM Z mini
Temperature	20 °C	Relative Humidity	48%
Pressure	1010 hPa	Test Mode	Mode 1 TX
Test Date	January 24, 2015	Frequency	2412MHz

Freq. (MHz)	Ant. Pol.	Emission Level(dBuV)		Limit 3m(dBuV/m)		Over(dB)	
		PK	AV	PK	AV	PK	AV
4824	V	60.69	39.09	74	54	-13.31	-14.91
7236	V	59.85	40.55	74	54	-14.15	-13.45
4824	H	58.80	39.17	74	54	-15.20	-14.83
7236	H	58.42	39.42	74	54	-15.58	-14.58

Remark:

All emissions not reported were more than 20dB below the specified limit or in the noise floor.
All the x/y/z orientation has been investigated, and only worst case is presented in this report.

EUT	Mobile Phone	Model Name	PHANTOM Z mini
Temperature	20 °C	Relative Humidity	48%
Pressure	1010 hPa	Test Mode	Mode 1 TX
Test Date	January 24, 2015	Frequency	2437MHz

Freq. (MHz)	Ant. Pol.	Emission Level(dBuV)		Limit 3m(dBuV/m)		Over(dB)	
		PK	AV	PK	AV	PK	AV
4874	V	58.41	40.22	74	54	-15.59	-13.78
7311	V	58.45	40.96	74	54	-15.55	-13.04
4874	H	59.87	39.00	74	54	-14.13	-15.00
7311	H	59.94	40.94	74	54	-14.06	-13.06

Remark:

All emissions not reported were more than 20dB below the specified limit or in the noise floor.
All the x/y/z orientation has been investigated, and only worst case is presented in this report.

EUT	Mobile Phone	Model Name	PHANTOM Z mini
Temperature	20 °C	Relative Humidity	48%
Pressure	1010 hPa	Test Mode	Mode 1 TX
Test Date	January 24, 2015	Frequency	2462MHz

Freq. (MHz)	Ant. Pol.	Emission Level(dBuV)		Limit 3m(dBuV/m)		Over(dB)	
		PK	AV	PK	AV	PK	AV
4924	V	58.86	39.08	74	54	-15.14	-14.92
7386	V	59.19	40.37	74	54	-14.81	-13.63
4924	H	58.23	40.39	74	54	-15.77	-13.61
7386	H	59.03	40.03	74	54	-14.97	-13.97

Remark:

All emissions not reported were more than 20dB below the specified limit or in the noise floor.
All the x/y/z orientation has been investigated, and only worst case is presented in this report.

EUT	Mobile Phone	Model Name	PHANTOM Z mini
Temperature	20 °C	Relative Humidity	48%
Pressure	1010 hPa	Test Mode	Mode2 TX
Test Date	January 24, 2015	Frequency	2412MHz

Freq. (MHz)	Ant. Pol.	Emission Level(dBuV)		Limit 3m(dBuV/m)		Over(dB)	
		PK	AV	PK	AV	PK	AV
4824	V	59.19	41.42	74	54	-14.81	-12.58
7236	V	59.99	40.38	74	54	-14.01	-13.62
4824	H	58.38	39.58	74	54	-15.62	-14.42
7236	H	58.67	39.67	74	54	-15.33	-14.33

Remark:

All emissions not reported were more than 20dB below the specified limit or in the noise floor.
All the x/y/z orientation has been investigated, and only worst case is presented in this report.

EUT	Mobile Phone	Model Name	PHANTOM Z mini
Temperature	20 °C	Relative Humidity	48%
Pressure	1010 hPa	Test Mode	Mode 2 TX
Test Date	January 24, 2015	Frequency	2437MHz

Freq. (MHz)	Ant.Pol.	Emission Level(dBuV)		Limit 3m(dBuV/m)		Over(dB)	
		PK	AV	PK	AV	PK	AV
4874	V	60.82	41.04	74	54	-13.18	-12.96
7311	V	58.92	40.27	74	54	-15.08	-13.73
4874	H	58.85	40.13	74	54	-15.15	-13.87
7311	H	59.14	40.14	74	54	-14.86	-13.86

Remark:

All emissions not reported were more than 20dB below the specified limit or in the noise floor.
All the x/y/z orientation has been investigated, and only worst case is presented in this report.

EUT	Mobile Phone	Model Name	PHANTOM Z mini
Temperature	20 °C	Relative Humidity	48%
Pressure	1010 hPa	Test Mode	Mode 2 TX
Test Date	January 24, 2015	Frequency	2462MHz

Freq. (MHz)	Ant.Pol.	Emission Level(dBuV)		Limit 3m(dBuV/m)		Over(dB)	
		PK	AV	PK	AV	PK	AV
4924	V	61.92	40.31	74	54	-12.08	-13.69
7386	V	58.60	39.70	74	54	-15.40	-14.30
4924	H	59.61	39.96	74	54	-14.39	-14.04
7386	H	58.64	39.64	74	54	-15.36	-14.36

Remark:

All emissions not reported were more than 20dB below the specified limit or in the noise floor.
All the x/y/z orientation has been investigated, and only worst case is presented in this report.

EUT	Mobile Phone	Model Name	PHANTOM Z mini
Temperature	20 °C	Relative Humidity	48%
Pressure	1010 hPa	Test Mode	Mode3 TX
Test Date	January 24, 2015	Frequency	2412MHz

Freq. (MHz)	Ant. Pol.	Emission Level(dBuV)		Limit 3m(dBuV/m)		Over(dB)	
		PK	AV	PK	AV	PK	AV
4824	V	58.57	41.65	74	54	-15.43	-12.35
7236	V	58.98	39.30	74	54	-15.02	-14.70
4824	H	59.98	40.45	74	54	-14.02	-13.55
7236	H	58.49	39.49	74	54	-15.51	-14.51

Remark:

All emissions not reported were more than 20dB below the specified limit or in the noise floor.
All the x/y/z orientation has been investigated, and only worst case is presented in this report.

EUT	Mobile Phone	Model Name	PHANTOM Z mini
Temperature	20 °C	Relative Humidity	48%
Pressure	1010 hPa	Test Mode	Mode 3 TX
Test Date	January 24, 2015	Frequency	2437MHz

Freq. (MHz)	Ant.Pol.	Emission Level(dBuV)		Limit 3m(dBuV/m)		Over(dB)	
		PK	AV	PK	AV	PK	AV
4874	V	60.00	41.47	74	54	-14.00	-12.53
7311	V	58.11	40.02	74	54	-15.89	-13.98
4874	H	58.46	40.59	74	54	-15.54	-13.41
7311	H	59.52	40.52	74	54	-14.48	-13.48

Remark:

All emissions not reported were more than 20dB below the specified limit or in the noise floor.
All the x/y/z orientation has been investigated, and only worst case is presented in this report.

EUT	Mobile Phone	Model Name	PHANTOM Z mini
Temperature	20 °C	Relative Humidity	48%
Pressure	1010 hPa	Test Mode	Mode 2 TX
Test Date	January 24, 2015	Frequency	2462MHz

Freq. (MHz)	Ant.Pol.	Emission Level(dBuV)		Limit 3m(dBuV/m)		Over(dB)	
		PK	AV	PK	AV	PK	AV
4924	V	58.28	40.01	74	54	-15.72	-13.99
7386	V	58.62	40.94	74	54	-15.38	-13.06
4924	H	59.97	39.74	74	54	-14.03	-14.26
7386	H	58.76	39.76	74	54	-15.24	-14.24

Remark:

All emissions not reported were more than 20dB below the specified limit or in the noise floor.
All the x/y/z orientation has been investigated, and only worst case is presented in this report.

EUT	Mobile Phone	Model Name	PHANTOM Z mini
Temperature	20 °C	Relative Humidity	48%
Pressure	1010 hPa	Test Mode	Mode4 TX
Test Date	January 24, 2015	Frequency	2422MHz

Freq. (MHz)	Ant. Pol.	Emission Level(dBuV)		Limit 3m(dBuV/m)		Over(dB)	
		PK	AV	PK	AV	PK	AV
4844	V	60.98	39.96	74	54	-13.02	-14.04
7266	V	58.46	40.90	74	54	-15.54	-13.10
4844	H	58.18	40.84	74	54	-15.82	-13.16
7266	H	58.25	39.25	74	54	-15.75	-14.75

Remark:

All emissions not reported were more than 20dB below the specified limit or in the noise floor.
All the x/y/z orientation has been investigated, and only worst case is presented in this report.

EUT	Mobile Phone	Model Name	PHANTOM Z mini
Temperature	20 °C	Relative Humidity	48%
Pressure	1010 hPa	Test Mode	Mode 4 TX
Test Date	January 24, 2015	Frequency	2437MHz

Freq. (MHz)	Ant.Pol.	Emission Level(dBuV)		Limit 3m(dBuV/m)		Over(dB)	
		PK	AV	PK	AV	PK	AV
4874	V	58.64	41.42	74	54	-15.36	-12.58
7311	V	59.02	39.70	74	54	-14.98	-14.30
4874	H	58.24	39.39	74	54	-15.76	-14.61
7311	H	58.77	39.77	74	54	-15.23	-14.23

Remark:

All emissions not reported were more than 20dB below the specified limit or in the noise floor.
All the x/y/z orientation has been investigated, and only worst case is presented in this report.

EUT	Mobile Phone	Model Name	PHANTOM Z mini
Temperature	20 °C	Relative Humidity	48%
Pressure	1010 hPa	Test Mode	Mode 4 TX
Test Date	January 24, 2015	Frequency	2452MHz

Freq. (MHz)	Ant.Pol.	Emission Level(dBuV)		Limit 3m(dBuV/m)		Over(dB)	
		PK	AV	PK	AV	PK	AV
4904	V	60.36	40.65	74	54	-13.64	-13.35
7356	V	58.01	40.00	74	54	-15.99	-14.00
4904	H	59.57	39.70	74	54	-14.43	-14.30
7356	H	59.14	40.14	74	54	-14.86	-13.86

Remark:

All emissions not reported were more than 20dB below the specified limit or in the noise floor.
All the x/y/z orientation has been investigated, and only worst case is presented in this report.

6. ANTENNA PORT CONDUCTED EMISSION

6.1 Antenna requirement

The EUT'S antenna is met the requirement of FCC part 15C section 15.203 and 15.247

FCC part 15C section 15.247 requirements: Systems operating in the 2412-2462MHz band that are used exclusively for fixed.

6.2 Test Procedure

1. The EUT was connected to spectrum analyzer with RF cable.
2. Keep wifi transmitting at low channel of 802.11b.
3. Set the start frequency=1GHz, stop frequency = 25GHz, RBW =1MHz, VBW =3MHz, allow the trace to stabilize, mark the max value, and mark a line which the value reduce 20dBm, mark the max value under the line.
4. Detector = Peak.
5. Trace mode = max hold.
6. Sweep point = 20001.
7. Hold the line, change the start frequency=30MHz, stop frequency=1GHz, RBW =100 kHz, VBW =300 kHz, mark the max value, and record.
8. Repeat all of the above steps until the middle channel, the high channel of 802.11b, 802.11g, 802.11n20 and 802.11n40 are done.
9. Record all the result.

6.3 Result

The antenna's gain is 1.55dBi and meets the requirement.

802.11b:

Antenna port conducted spurious emissions

Low channel

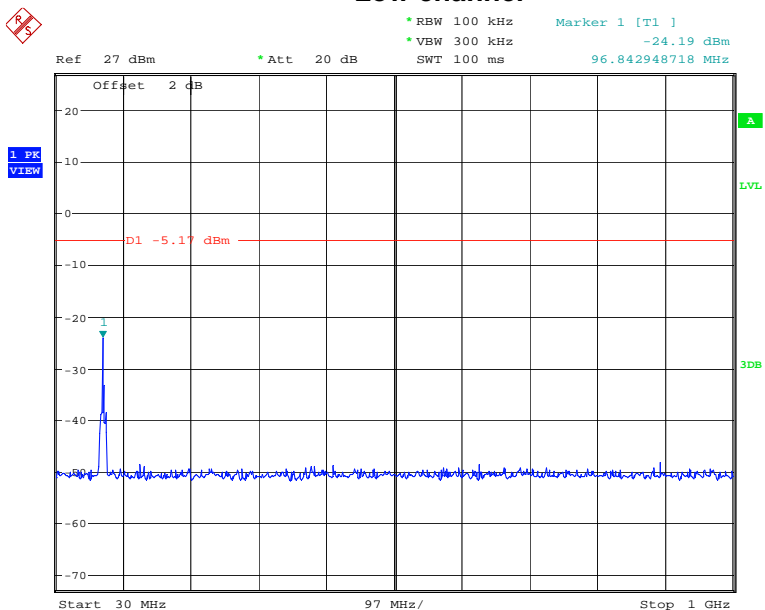

Sweep points = 20001

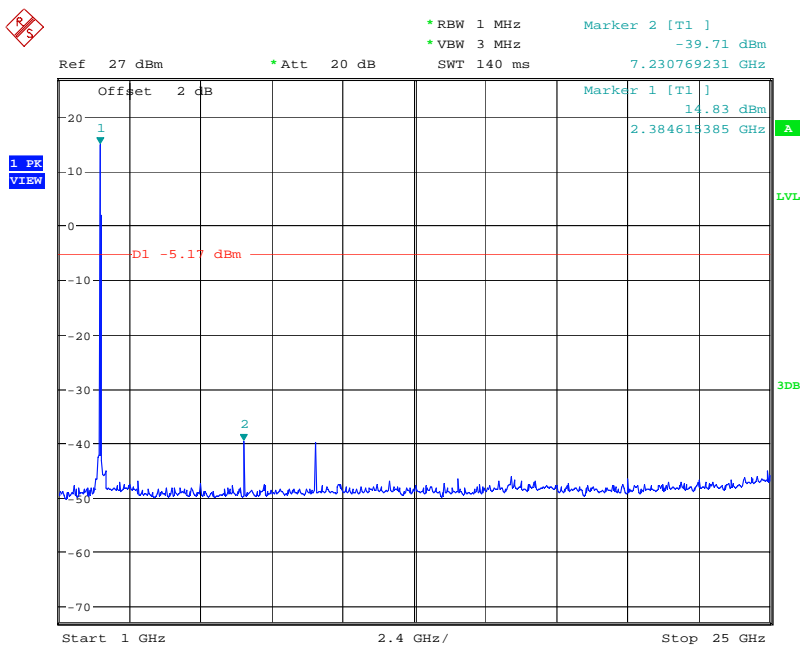

Sweep points = 20001

Middle channel

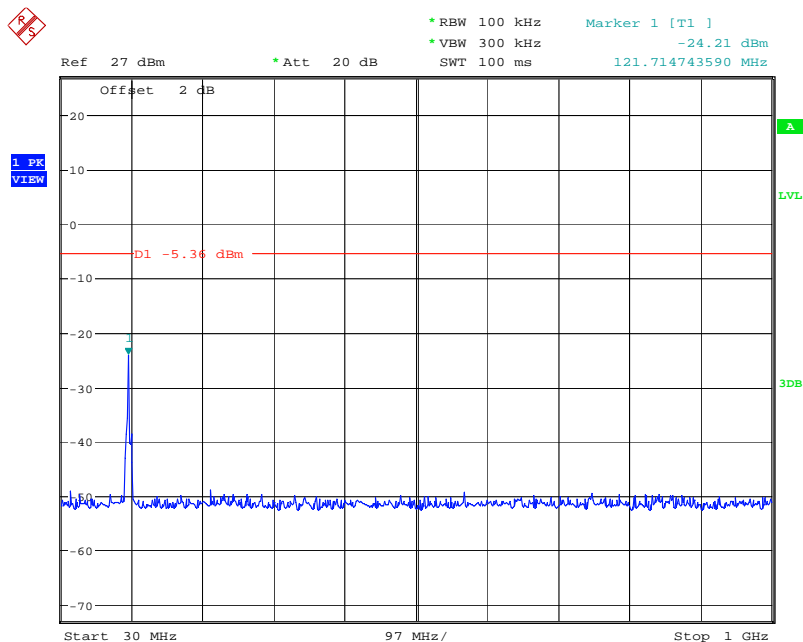

Sweep points = 20001

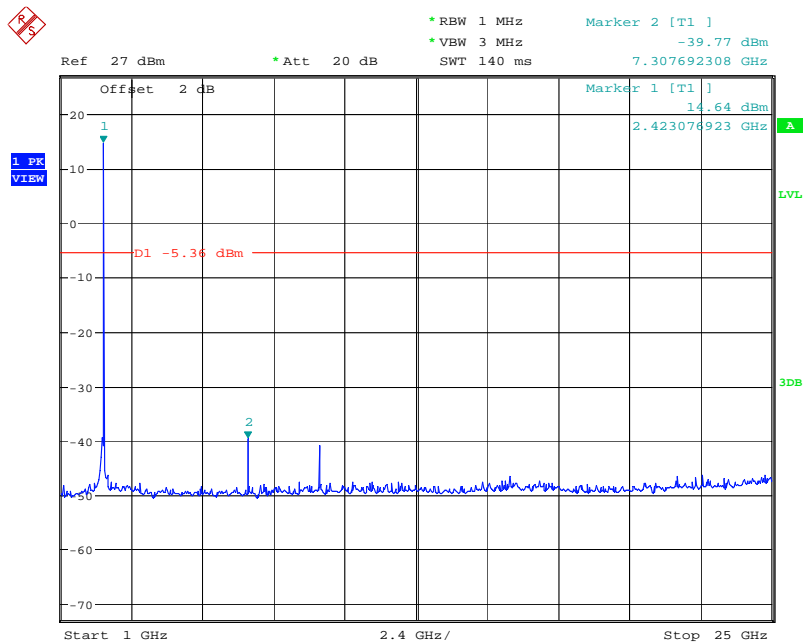

Sweep points = 20001

High channel

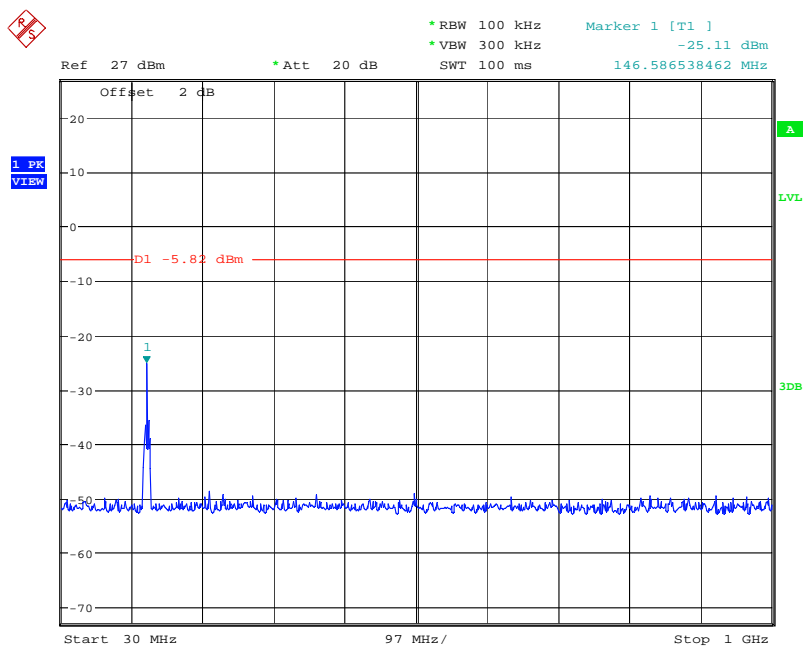

Sweep points = 20001

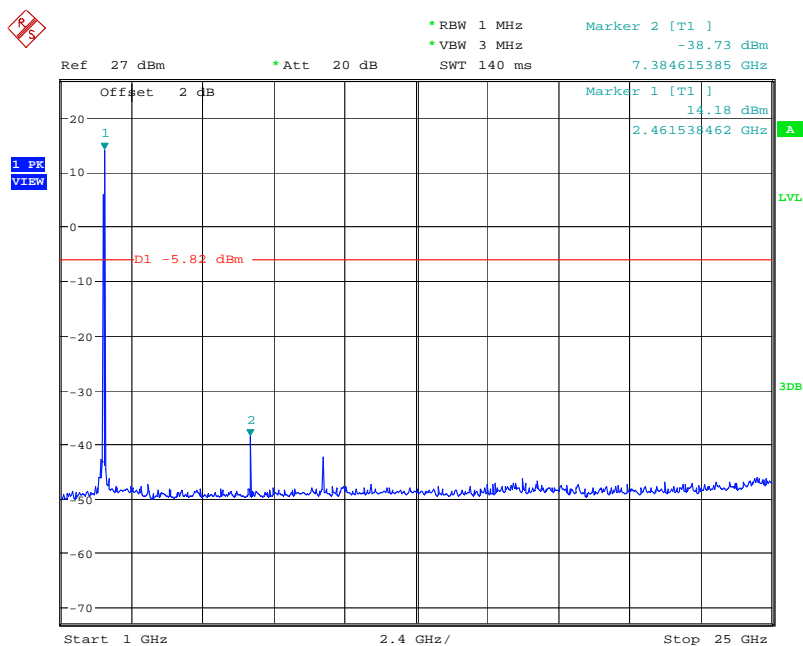

Sweep points = 20001

802.11g:

Low channel

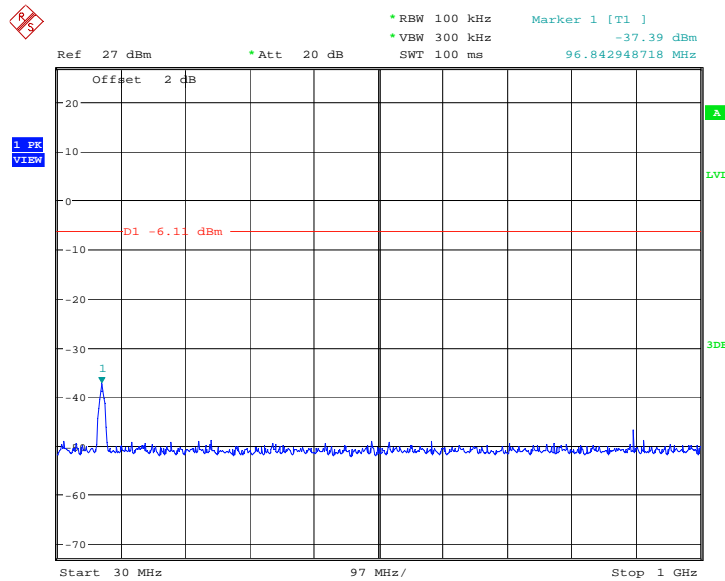

Sweep points = 20001

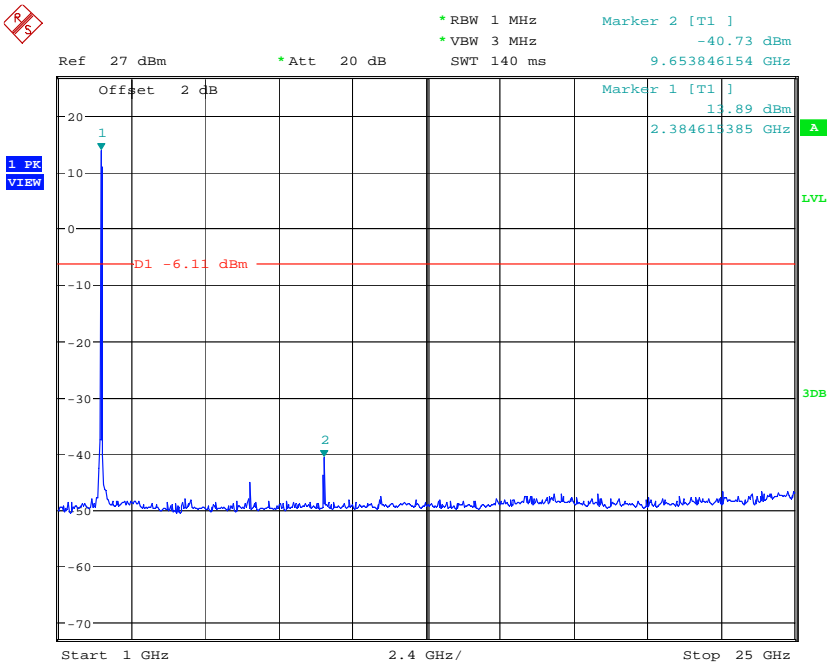

Sweep points = 20001

Middle channel

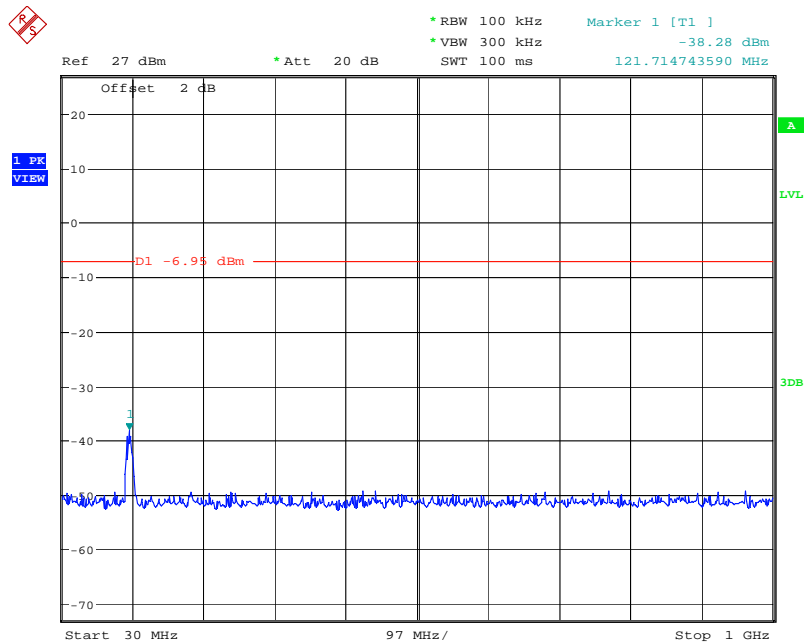

Sweep points = 20001

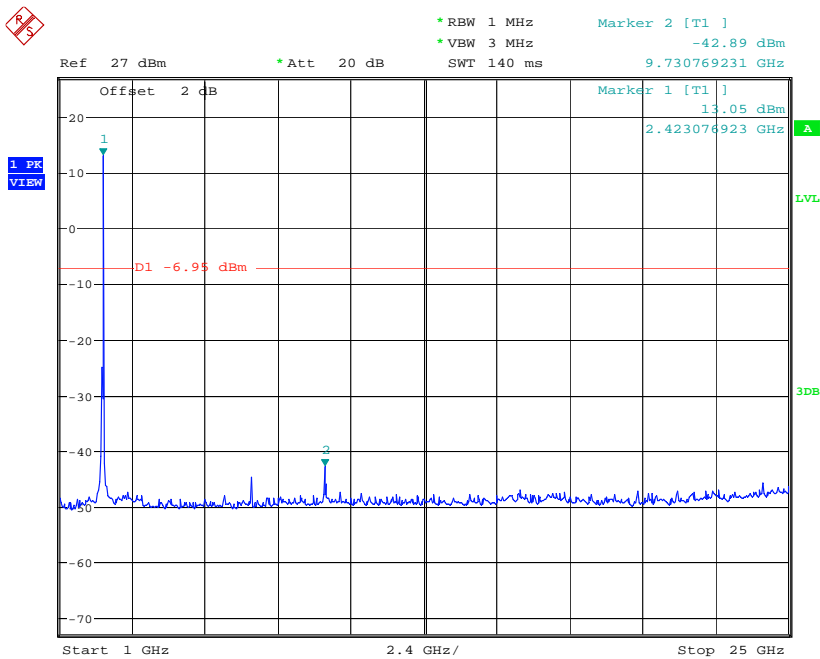

Sweep points = 20001

High channel

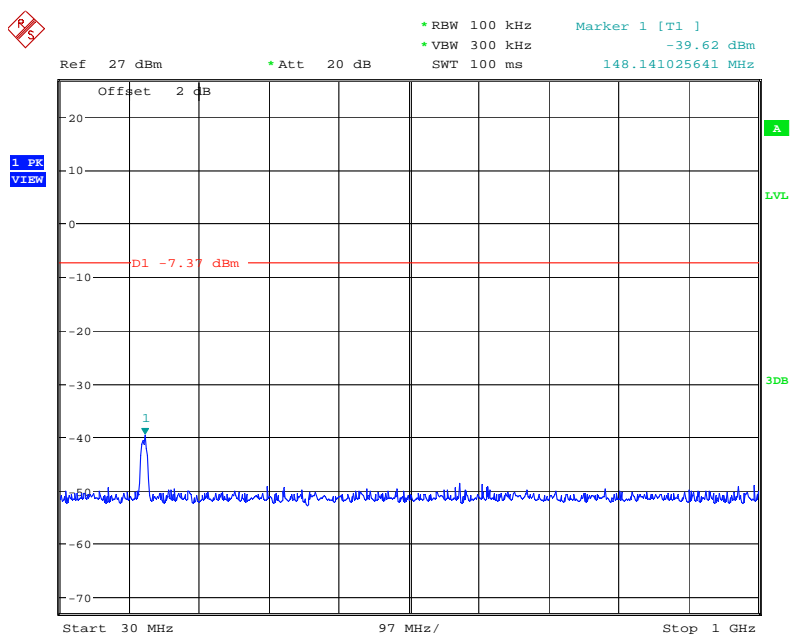

Sweep points = 20001

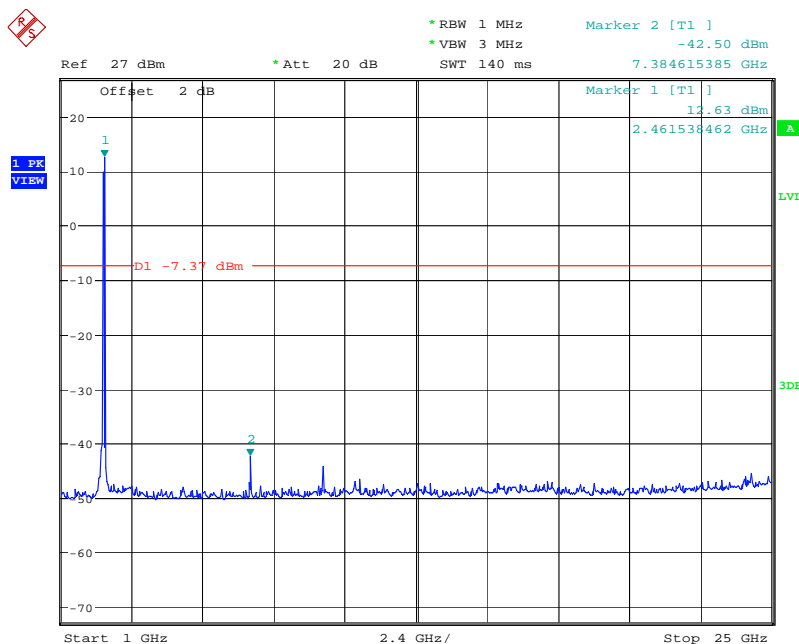

Sweep points = 20001

802.11n HT20:

Low channel

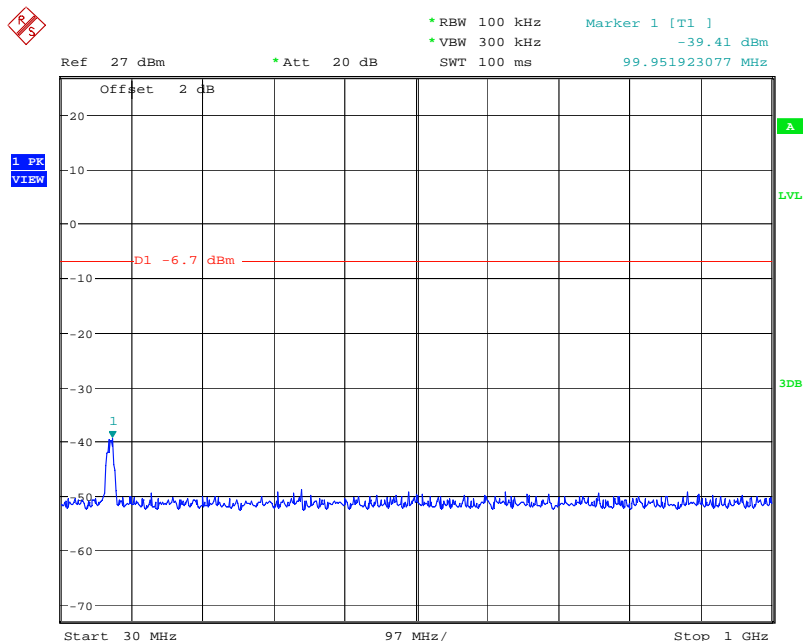

Sweep points = 20001

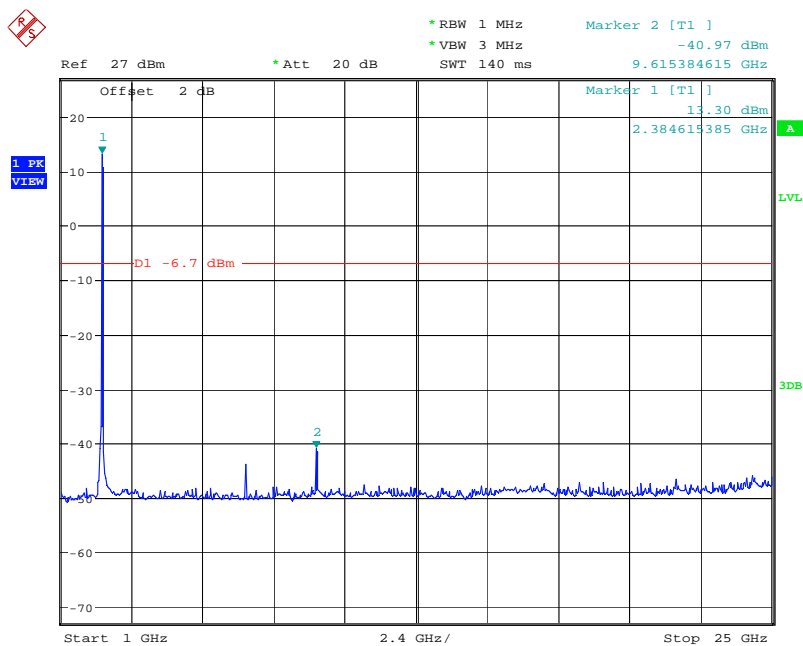

Sweep points = 20001

Middle channel

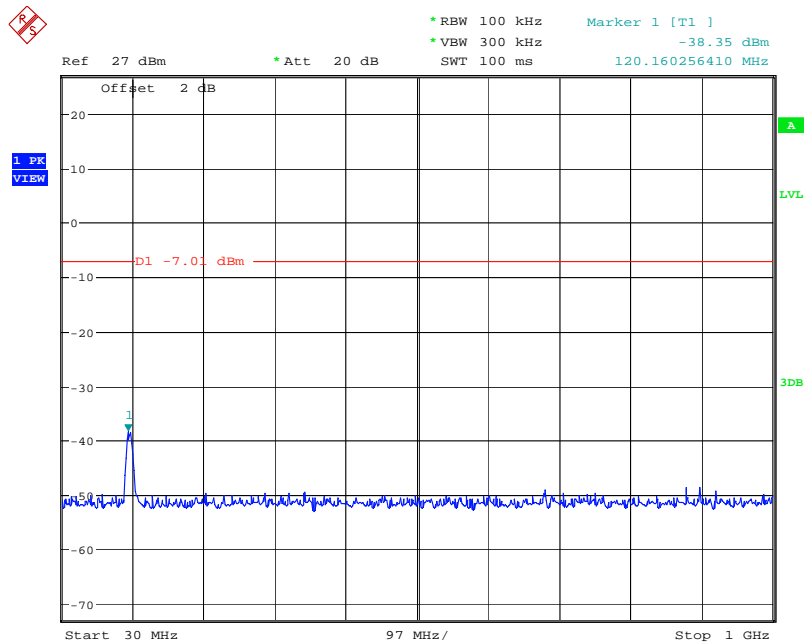

Sweep points = 20001

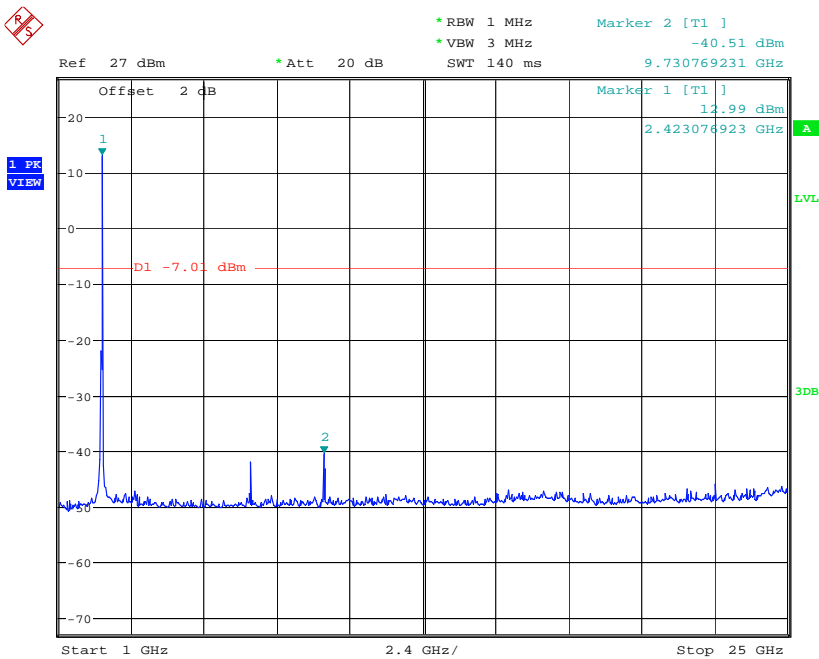

Sweep points = 20001

High channel

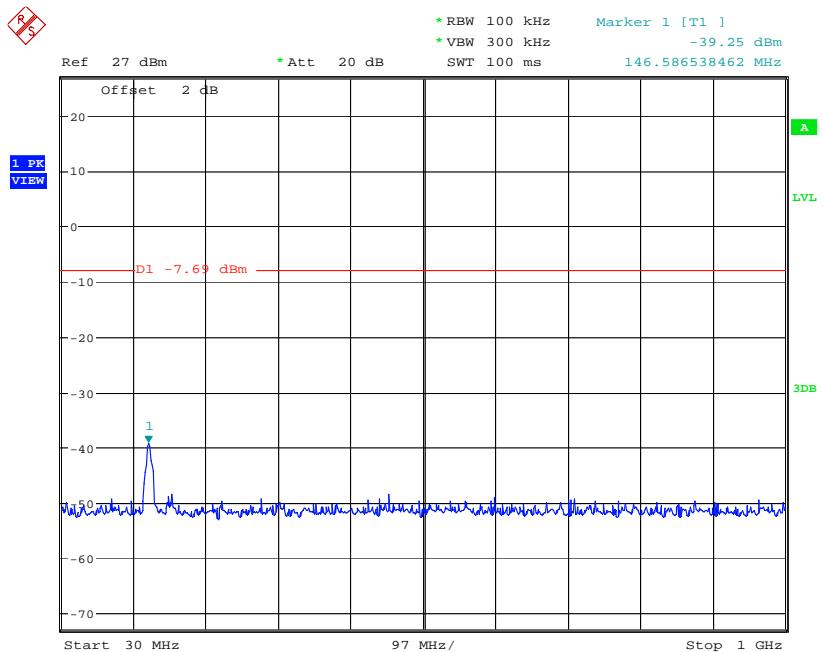

Sweep points = 20001

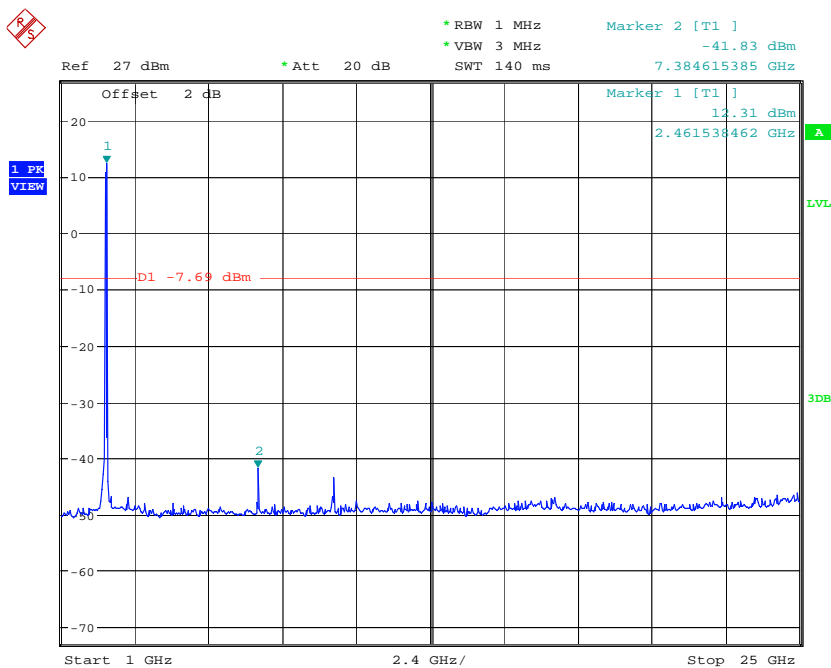

Sweep points = 20001

802.11n HT40:

Low channel

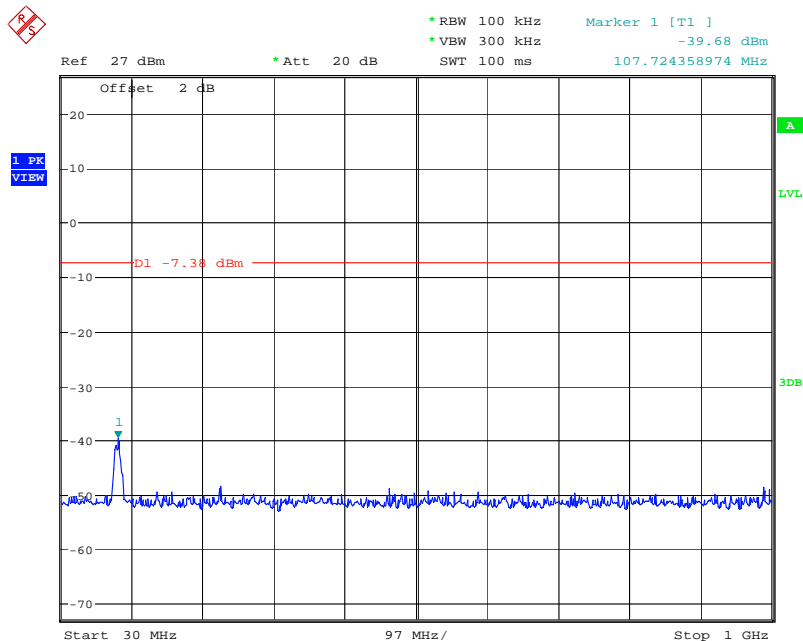

Sweep points = 20001

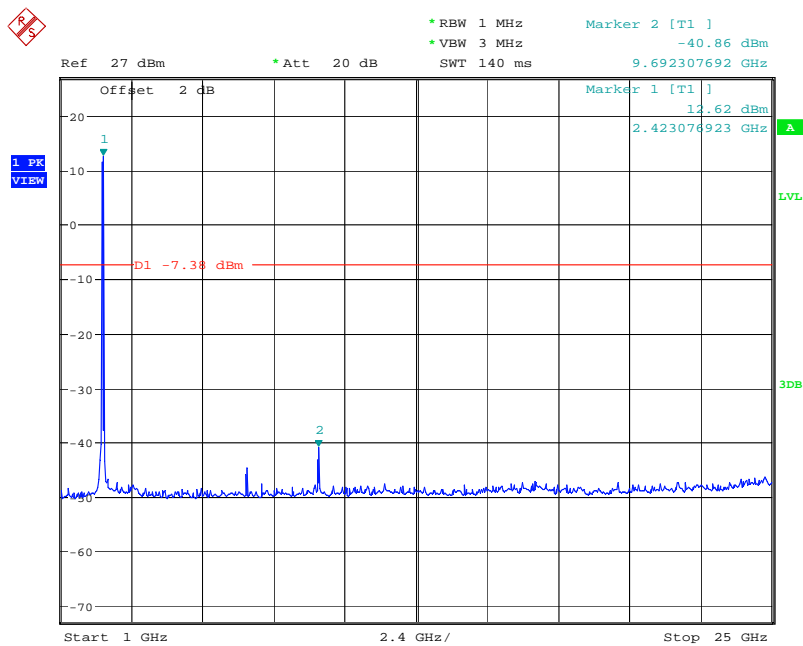

Sweep points = 20001

Middle channel

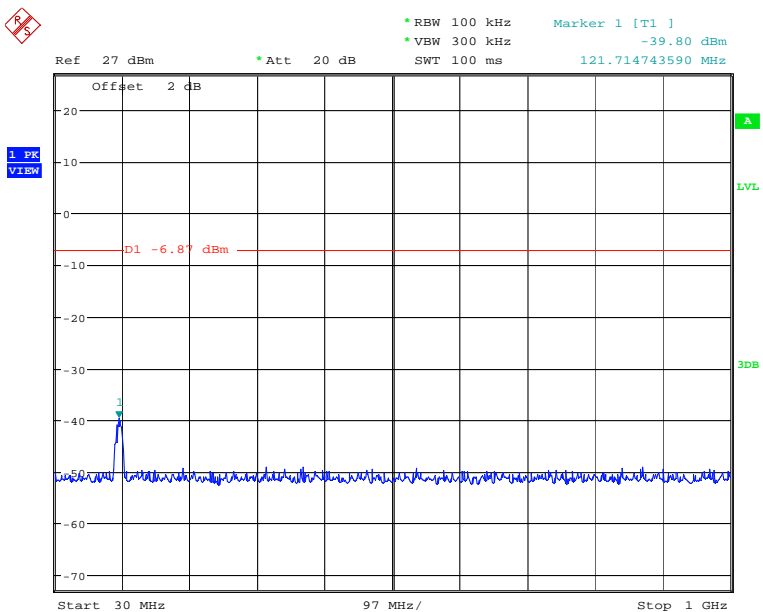

Sweep points = 20001

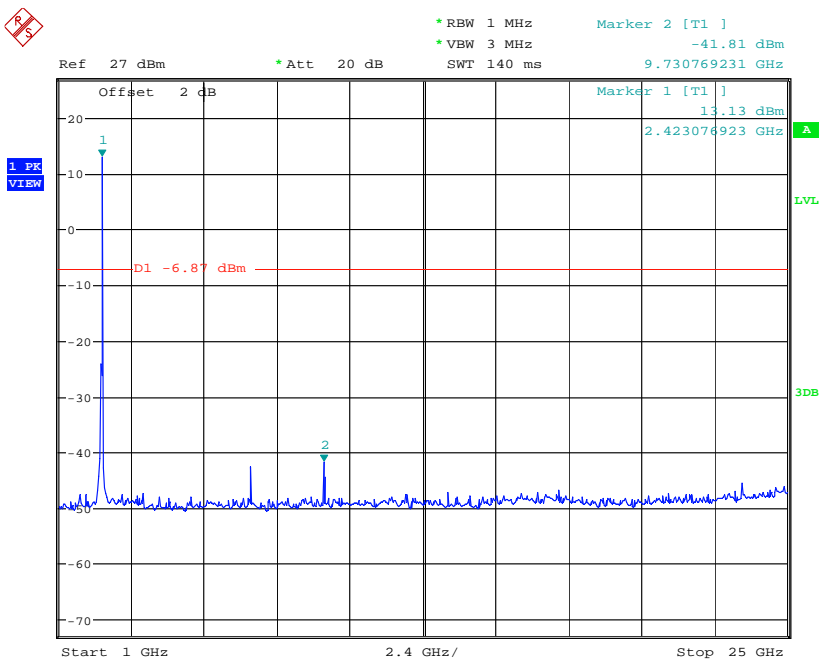

Sweep points = 20001

High channel

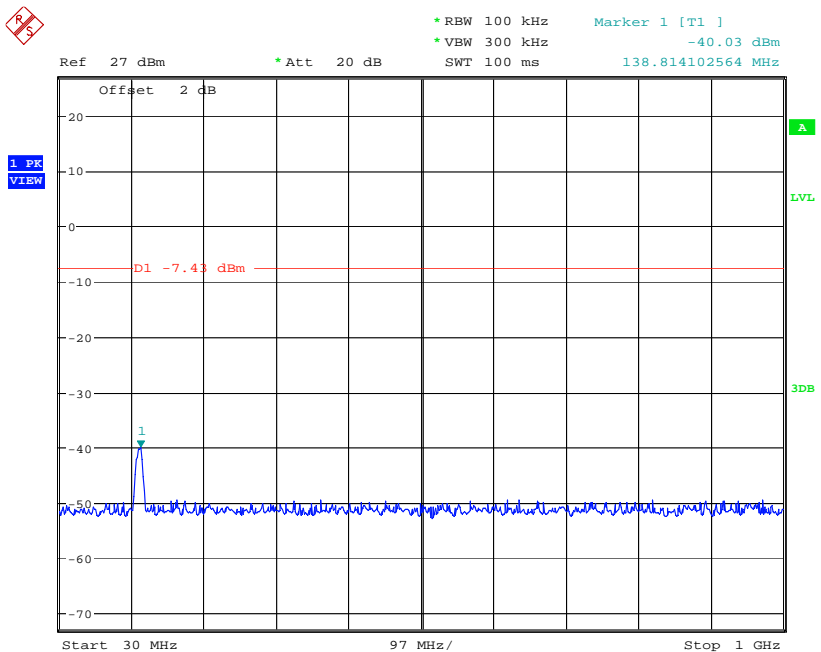

Sweep points = 20001

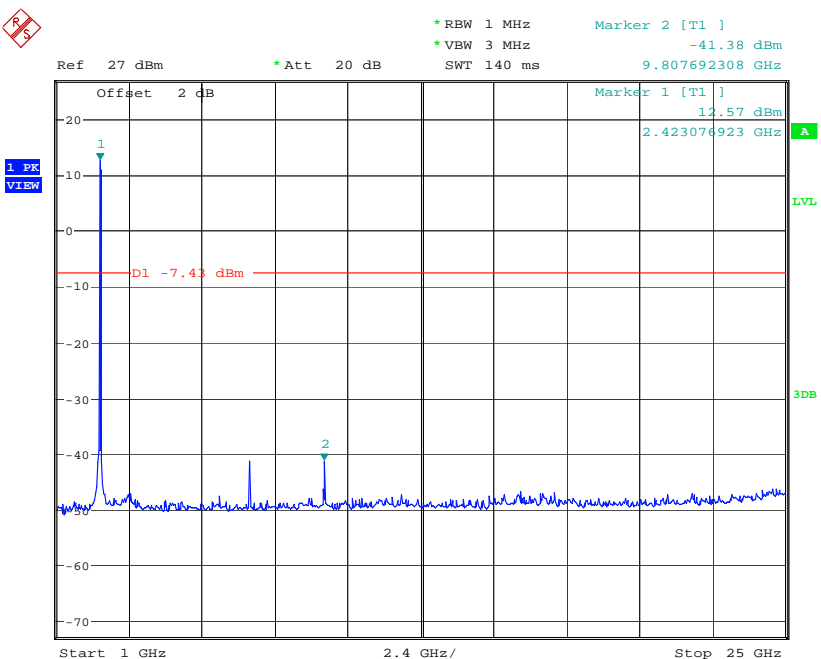

Sweep points = 20001

7.0. 6DB BANDWIDTH MEASUREMENT

7.1 TEST SETUP

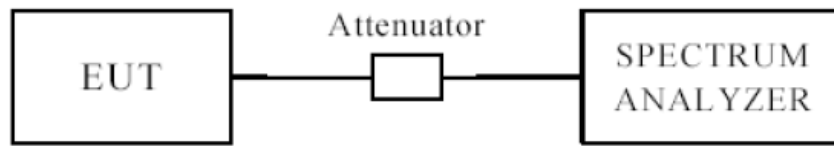

7.2 LIMITS OF 6DB BANDWIDTH MEASUREMENT

The minimum of 6dB Bandwidth Measurement is >500 kHz

7.3 TEST PROCEDURE

1. Set resolution bandwidth (RBW) = 100 kHz
2. Set the video bandwidth (VBW) $\geq 3 \times$ RBW.
3. Detector = Peak.
4. Trace mode = max hold.
5. Sweep = auto couple.
6. Allow the trace to stabilize.
7. Measure the maximum width of the emission that is constrained by the frequencies associated with the two outermost amplitude points (upper and lower) that are attenuated by 6 dB relative to the maximum level measured in the fundamental emission.

7.4 TEST RESULT

6dB Occupied Bandwidth

EUT		Mobile Phone		Model		PHANTOM Z mini	
Mode		802.11b		Humidity		56% RH	
Temperature		24 deg. C,					
Channel	Channel Frequency (MHz)	Data Transfer Rate (Mbps)	6 dB Bandwidth (kHz)	Minimum Limit (MHz)	Pass/ Fail		
1	2412	1	9166.7	0.5	Pass		
6	2437	1	9230.8	0.5	Pass		
11	2462	1	9359.0	0.5	Pass		

EUT		Mobile Phone		Model		PHANTOM Z mini	
Mode		802.11g		Humidity		56% RH	
Temperature		24 deg. C,					
Channel	Channel Frequency (MHz)	Data Transfer Rate (Mbps)	6 dB Bandwidth (kHz)	Minimum Limit (MHz)	Pass/ Fail		
1	2412	6	16474.4	0.5	Pass		
6	2437	6	16474.4	0.5	Pass		
11	2462	6	16282.1	0.5	Pass		

EUT		Mobile Phone		Model		PHANTOM Z mini	
Mode		802.11n20		Humidity		56% RH	
Temperature		24 deg. C,					
Channel	Channel Frequency (MHz)	Data Transfer Rate (Mbps)	6 dB Bandwidth (kHz)	Minimum Limit (MHz)	Pass/ Fail		
1	2412	6.5	17692.3	0.5	Pass		
6	2437	6.5	17692.3	0.5	Pass		
11	2462	6.5	17500.0	0.5	Pass		

EUT		Mobile Phone		Model		PHANTOM Z mini	
Mode		802.11n40		Humidity		56% RH	
Temperature		24 deg. C,					
Channel	Channel Frequency (MHz)	Data Transfer Rate (Mbps)	6 dB Bandwidth (kHz)	Minimum Limit (MHz)	Pass/ Fail		
3	2422	13.5	36250.0	0.5	Pass		
6	2437	13.5	36346.2	0.5	Pass		
9	2452	13.5	36250.0	0.5	Pass		

802.11b at 1Mbps of CH1

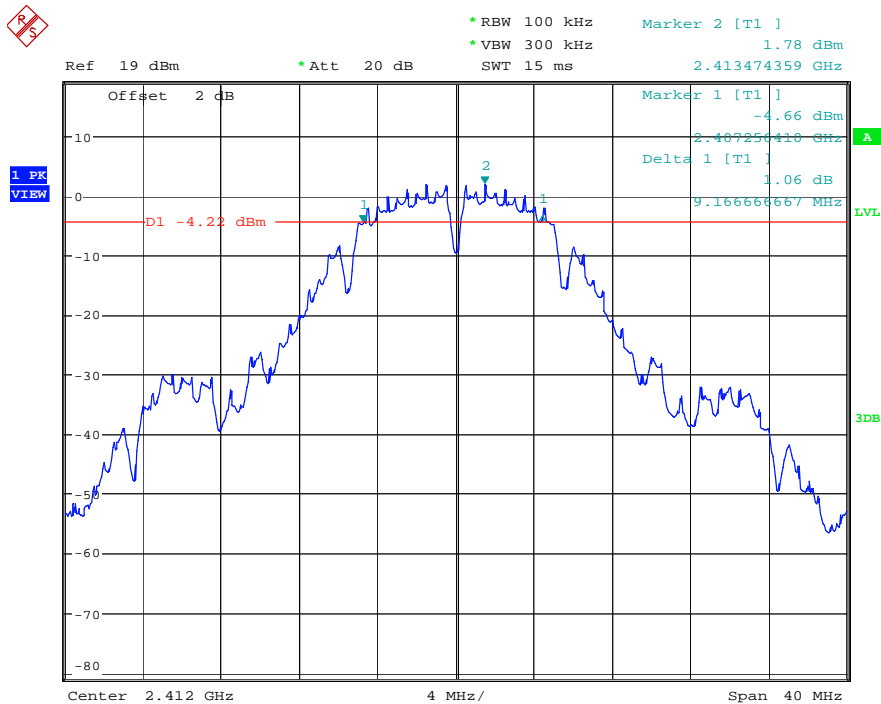

802.11b at 1Mbps of CH6

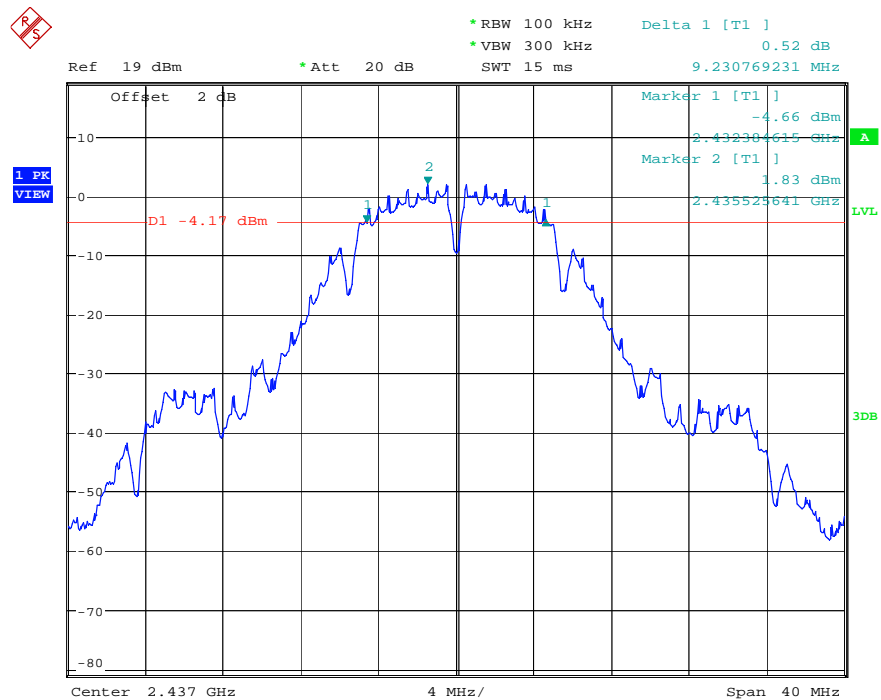

802.11b at 1Mbps of CH11

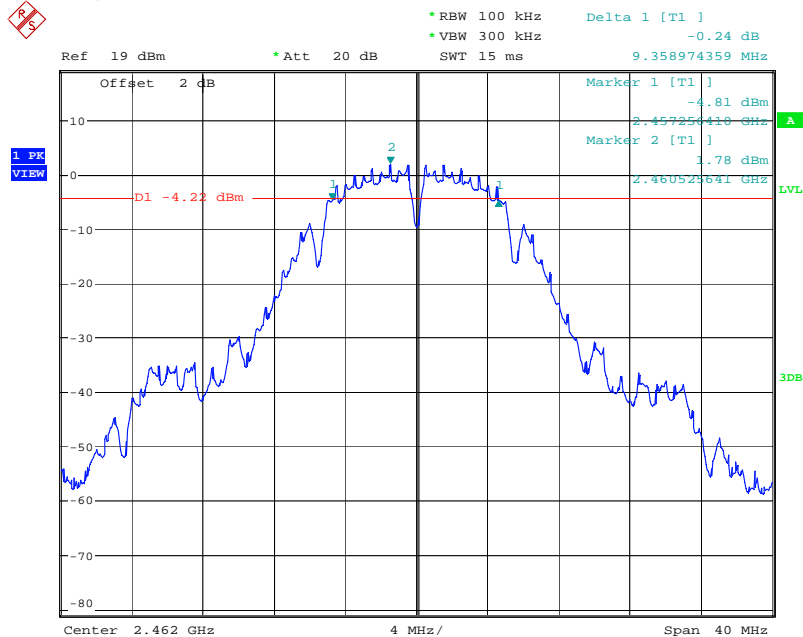

802.11g at 6Mbps of CH1

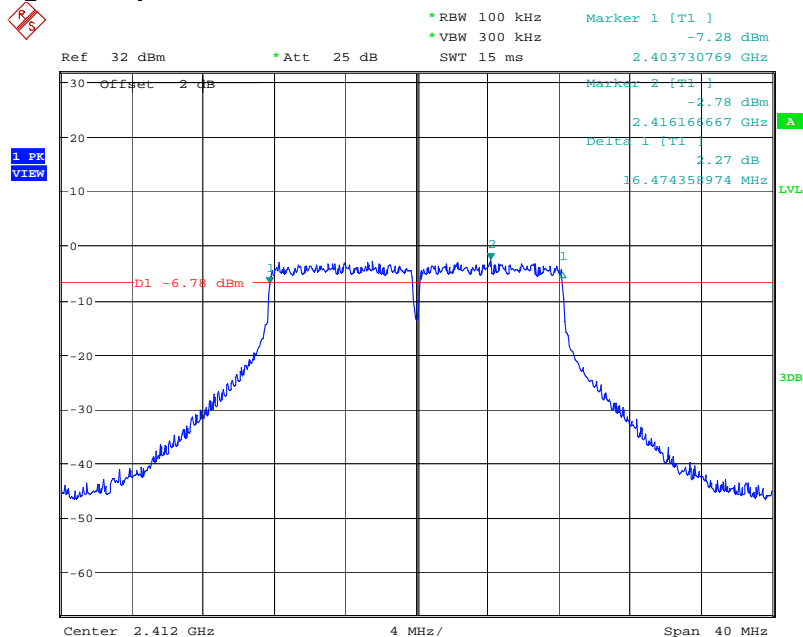

802.11g at 6Mbps of CH6

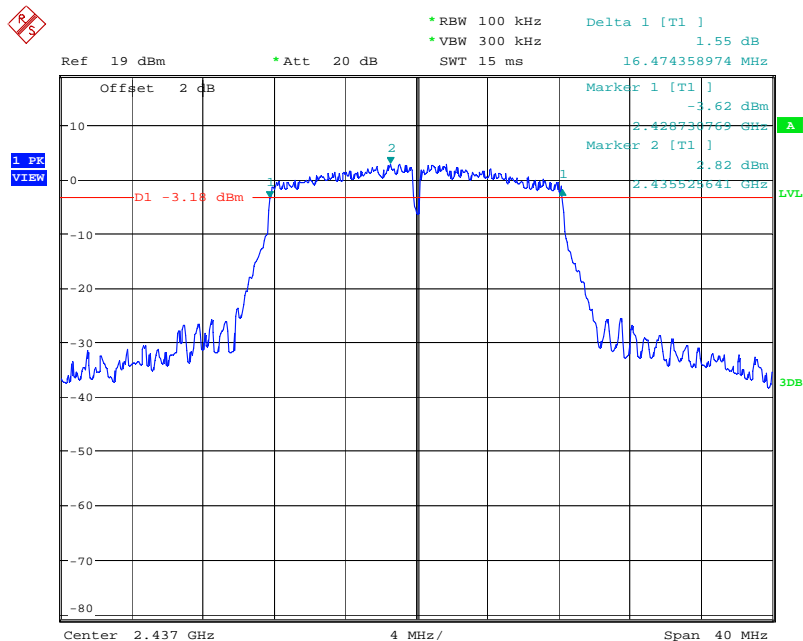

802.11g at 6Mbps of CH11

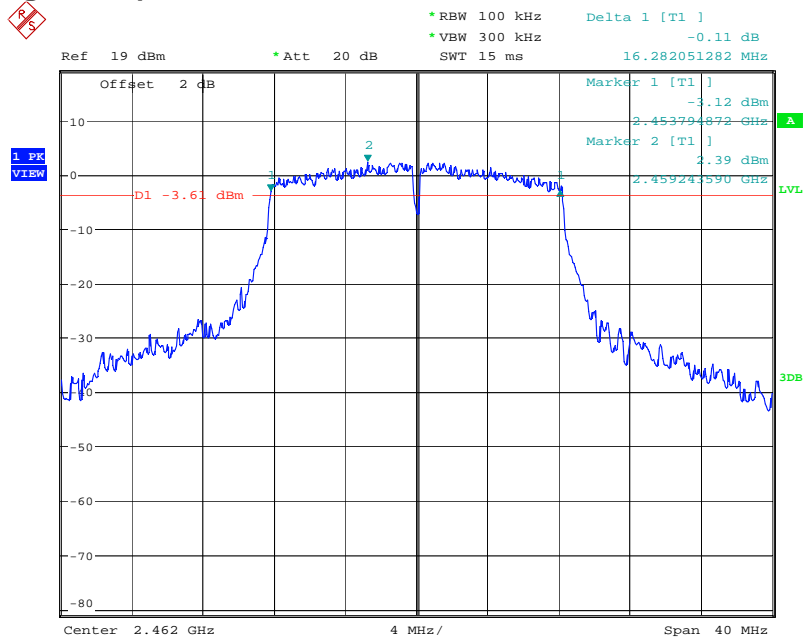

802.11n at HT20 of CH1

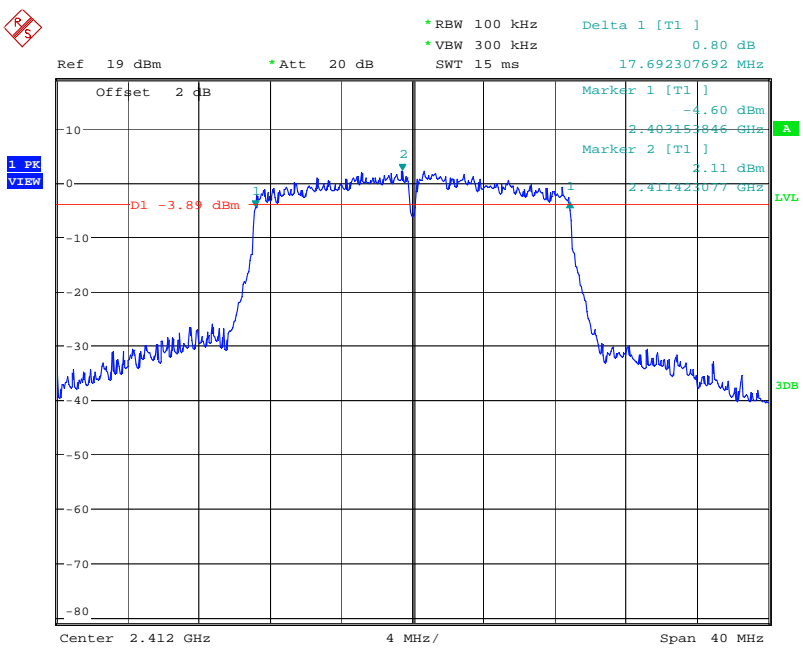

802.11n at HT20 of CH6

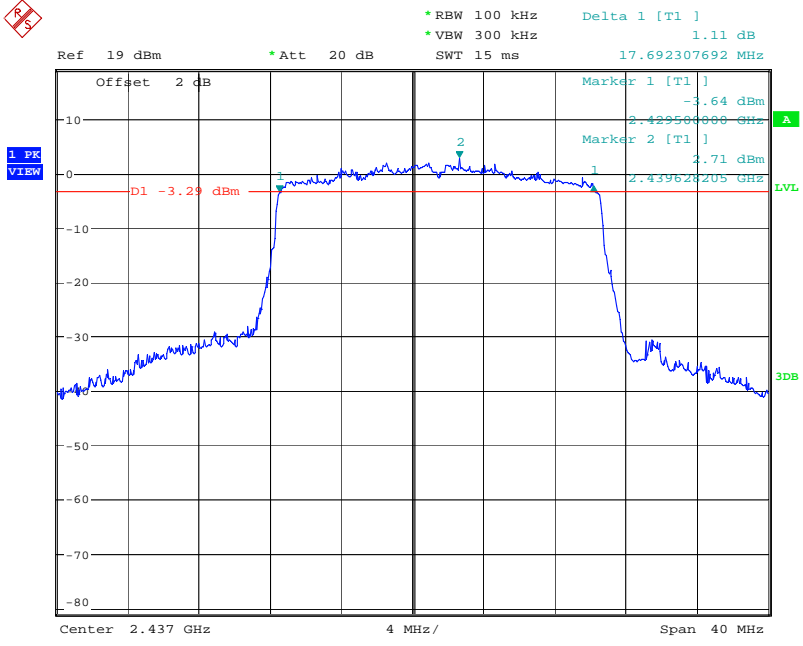

802.11n at HT20 of CH11

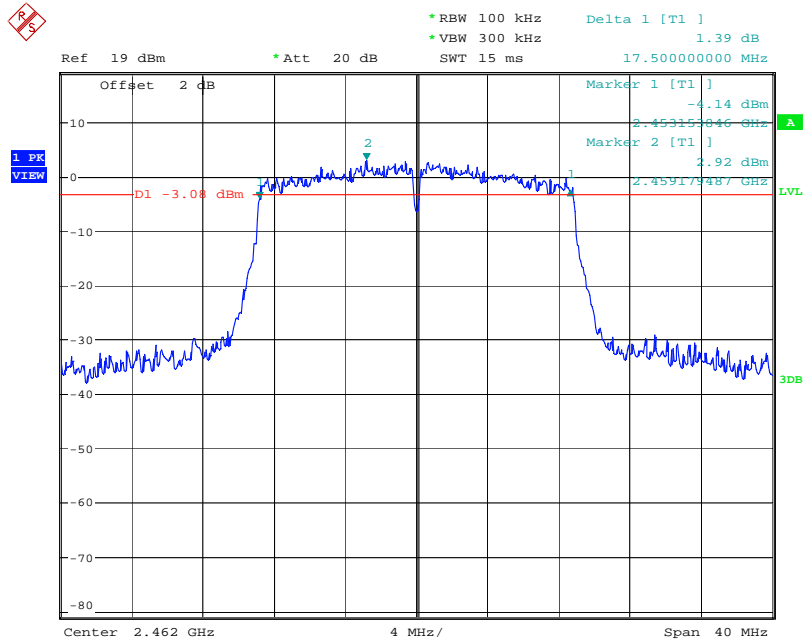

802.11n at HT40 of CH3

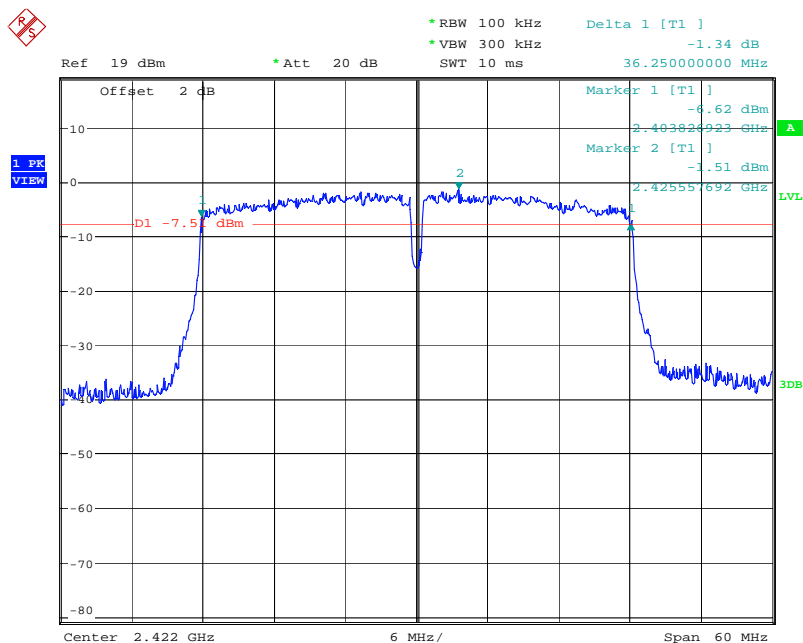

802.11n at HT40 of CH6

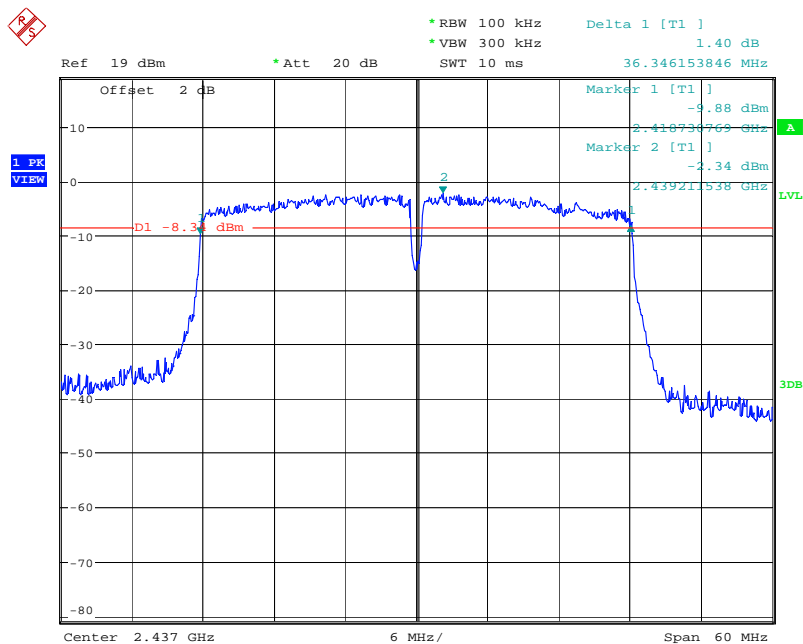

802.11n at HT40 of CH9

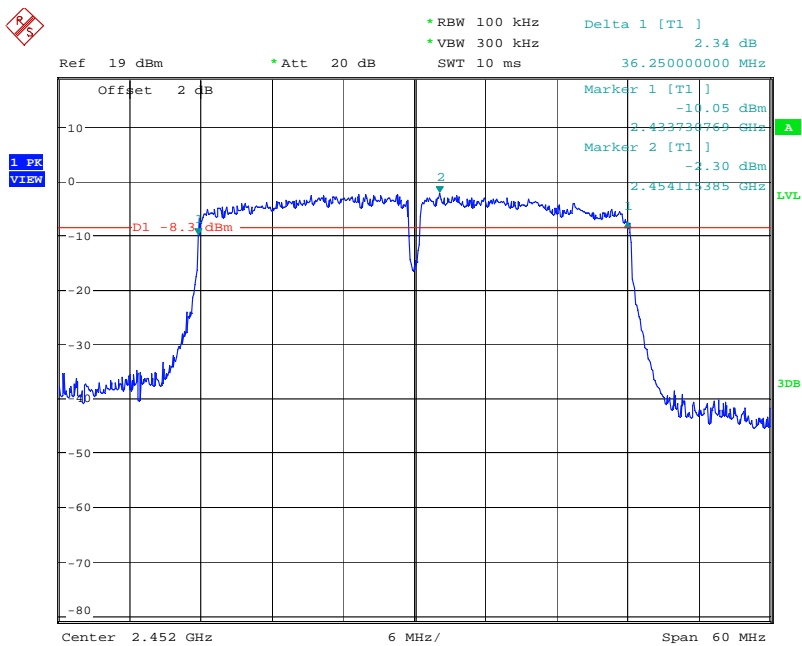

8.0. MAXIMUM PEAK OUTPUT POWER

8.1 TEST SETUP

Peak power

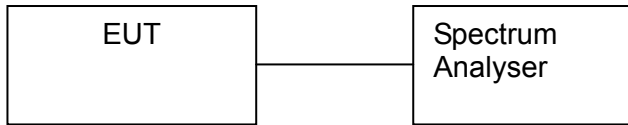

Average power

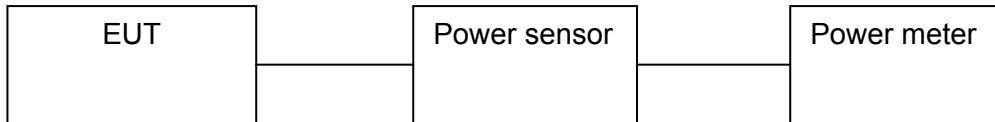

8.2 LIMITS OF MAXIMUM PEAK OUTPUT POWER

The Maximum Peak Output Power Measurement is 30dBm.

8.3 TEST PROCEDURE

The RF power output was measured with a Power meter connected to the RF Antenna connector measurement while EUT was operating in transmit mode at the appropriate centre frequency.

- a. The EUT was directly connected to the power meter and antenna output port as show in the block diagram by the power sensor. The sample with a program test port is used to test.
- b. Setting : RBW = 1MHz, VBW = 3MHz
 Span \geq approximately 2 times the bandwidth for 802.11b/g/n20, and 1.5 times for 802.11n40,
 centered on a low channel, middle channel and high channel
 Sweep = auto
 Detector function = peak
 Trace = max hold

Note: the peak power was measured.

8.4 TEST RESULTS

EUT	Mobile Phone	Model	PHANTOM Z mini	
Mode	802.11b	Humidity	56% RH	
Temperature	24 deg. C,			
Channel	Channel Frequency (MHz)	Peak Power Output (dBm)	Peak Power Limit (dBm)	Pass/ Fail
1	2412	18.06	30	Pass
6	2437	18.83	30	Pass
11	2462	18.13	30	Pass

Note: 1. At final test to get the worst-case emission at 1Mbps for CH1, CH6 and CH11

2. The result basic equation calculation as follow:

Peak Power Output = Peak Power Reading + Cable loss + Attenuator

3. The worse case was recorded

EUT		Mobile Phone		Model		PHANTOM Z mini	
Mode		802.11g		Humidity		56% RH	
Temperature		24 deg. C,					
Channel	Channel Frequency (MHz)	Peak Power Output (dBm)	Peak Power Limit (dBm)	Pass/ Fail			
1	2412	17.72	30	Pass			
6	2437	17.20	30	Pass			
11	2462	17.29	30	Pass			

Note: 1. At final test to get the worst-case emission at 6 Mbps for CH1, CH6 and CH11

2. The result basic equation calculation as follow:

Peak Power Output = Peak Power Reading + Cable loss + Attenuator

3. The worst case was recorded

EUT		Mobile Phone		Model		PHANTOM Z mini	
Mode		802.11n(HT20)		Humidity		56% RH	
Temperature		24 deg. C,					
Channel	Channel Frequency (MHz)	Peak Power Output (dBm)	Peak Power Limit (dBm)	Pass/ Fail			
1	2412	16.45	30	Pass			
6	2437	16.30	30	Pass			
11	2462	16.60	30	Pass			

Note: 1. At final test to get the worst-case emission at 6.5Mbps for CH1, CH6 and CH11

2. The result basic equation calculation as follow:

Peak Power Output = Peak Power Reading + Cable loss + Attenuator

3. The worst case was recorded

EUT		Mobile Phone		Model		PHANTOM Z mini	
Mode		802.11n (HT40)		Humidity		56% RH	
Temperature		24 deg. C,					
Channel	Channel Frequency (MHz)	Peak Power Output (dBm)	Peak Power Limit (dBm)	Pass/ Fail			
3	2422	15.44	30	Pass			
6	2437	15.33	30	Pass			
9	2452	16.15	30	Pass			

Note: 1. At final test to get the worst-case emission at 13.5Mbps for CH3, CH6 and CH9

2. The result basic equation calculation as follow:

Peak Power Output = Peak Power Reading + Cable loss + Attenuator

3. The worst case was recorded.

802.11b at 1Mbps of CH1

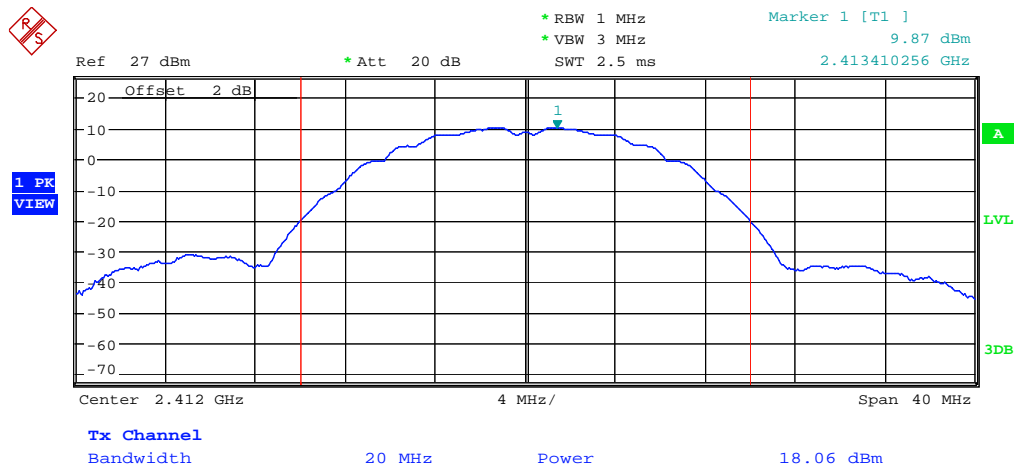

802.11b at 1Mbps of CH6

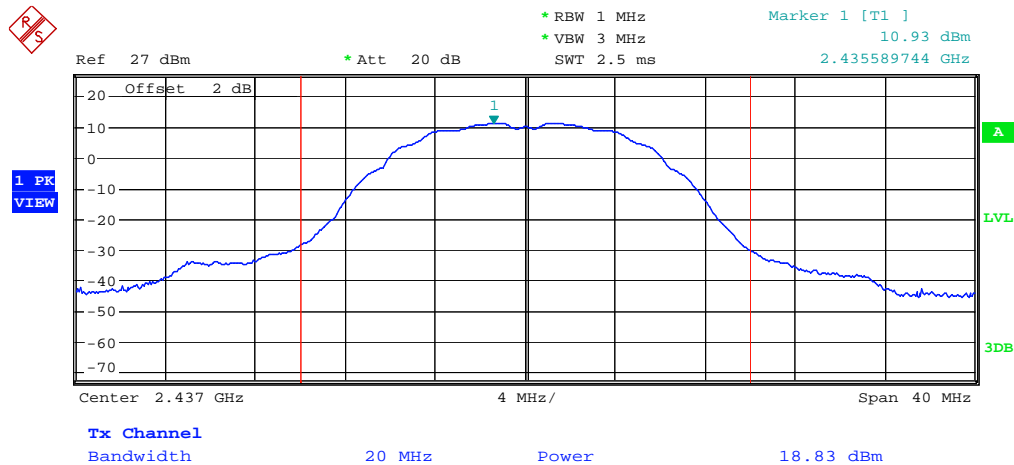

802.11b at 1Mbps of CH11

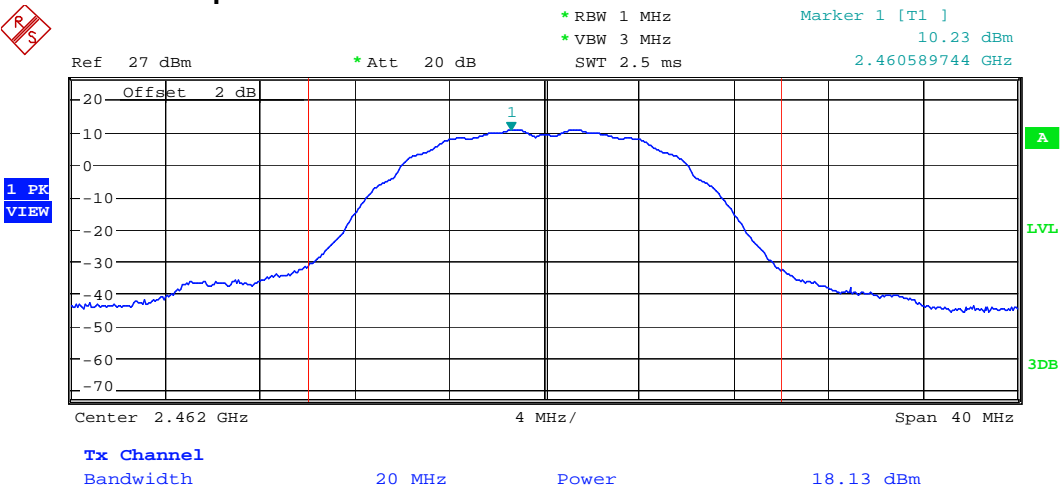

802.11g at 6Mbps of CH1

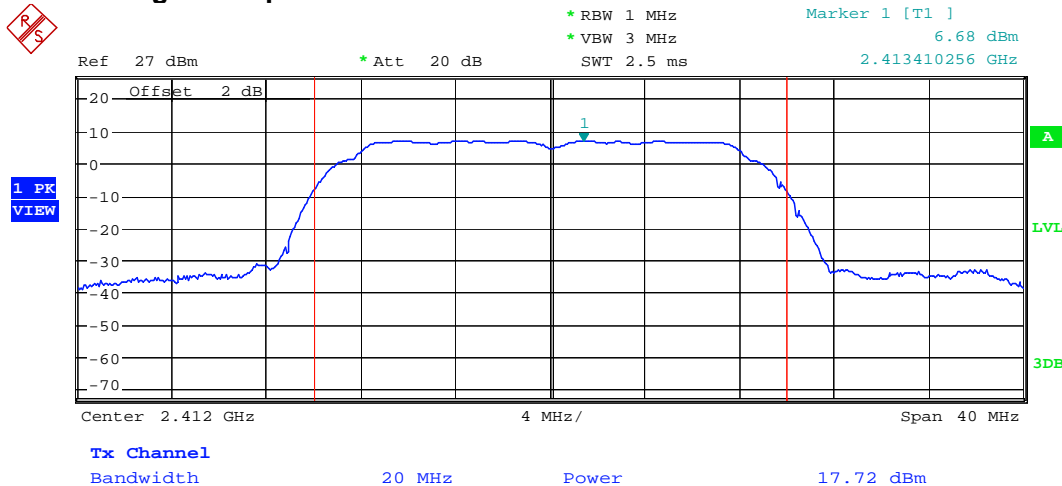

802.11g at 6Mbps of CH6

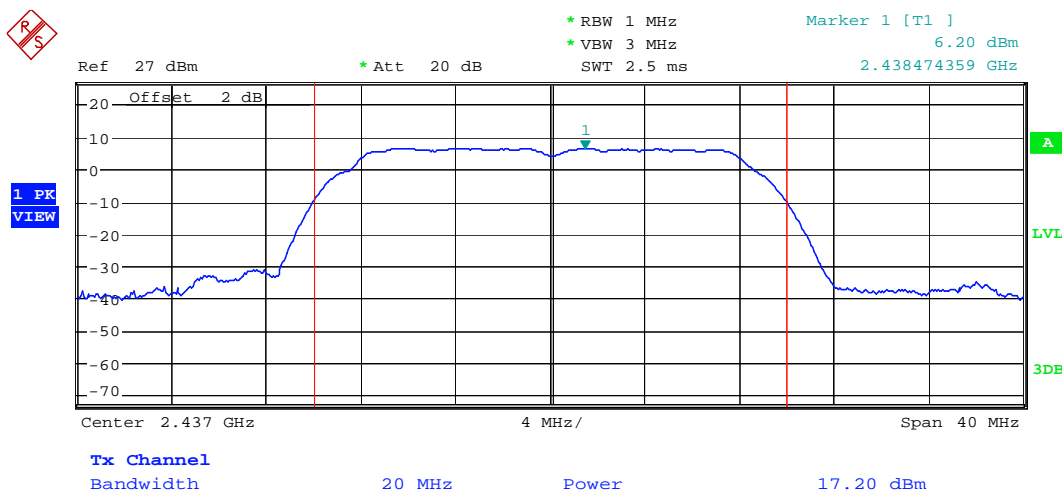

802.11g at 6Mbps of CH11

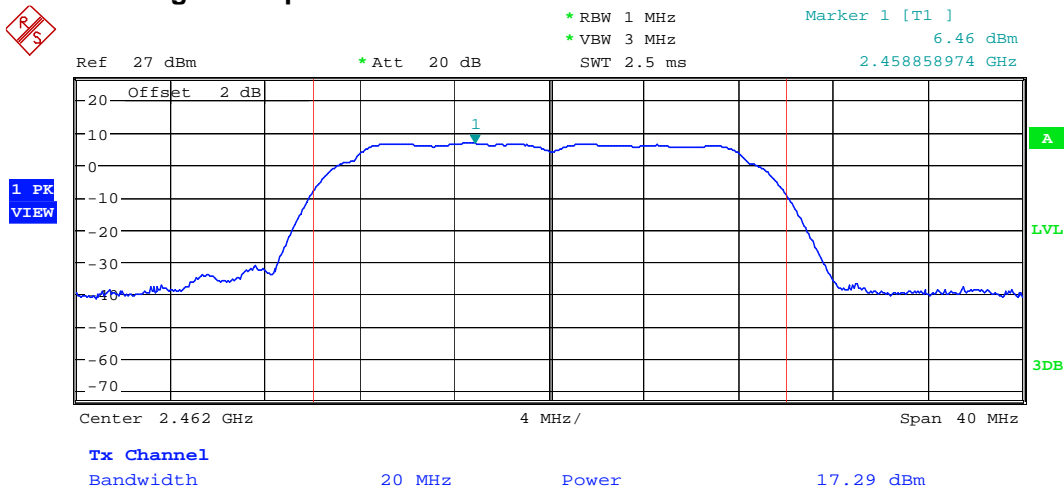

802.11n at HT20 of CH1



Ref 27 dBm * Att 20 dB * RBW 1 MHz Marker 1 [T1]
* VBW 3 MHz 5.15 dBm
SWT 2.5 ms 2.408794872 GHz

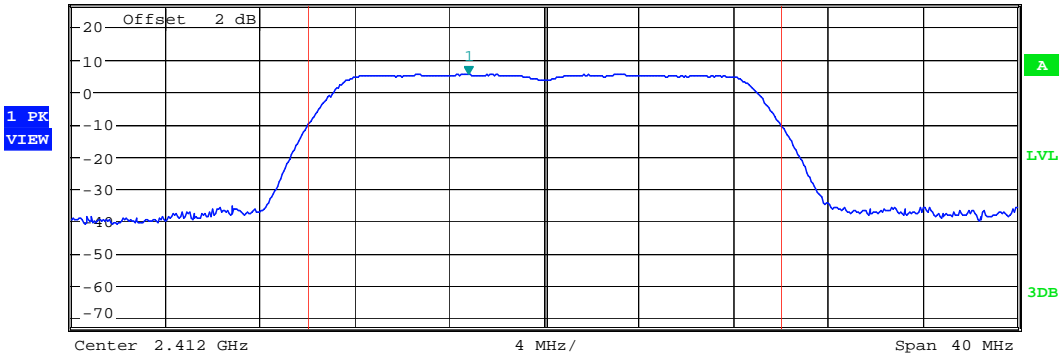

Tx Channel
Bandwidth 20 MHz Power 16.45 dBm

802.11n at HT20 of CH6



Ref 27 dBm * Att 20 dB * RBW 1 MHz Marker 1 [T1]
* VBW 3 MHz 4.99 dBm
SWT 2.5 ms 2.433794872 GHz

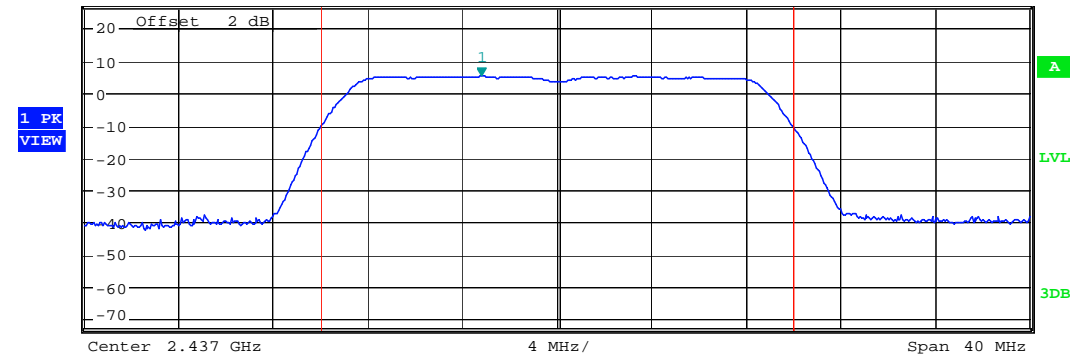

Tx Channel
Bandwidth 20 MHz Power 16.30 dBm

802.11n at HT20 of CH11



Ref 27 dBm * Att 20 dB * RBW 1 MHz Marker 1 [T1]
* VBW 3 MHz 5.44 dBm
SWT 2.5 ms 2.458858974 GHz

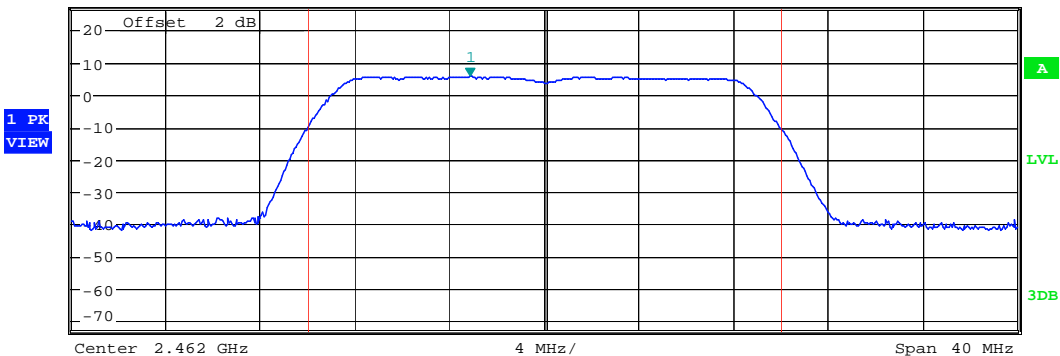

Tx Channel
Bandwidth 20 MHz Power 16.60 dBm

802.11n at HT40 of CH3



* RBW 1 MHz
* VBW 3 MHz
SWT 2.5 ms
Marker 1 [T1]
1.43 dBm
2.419788462 GHz

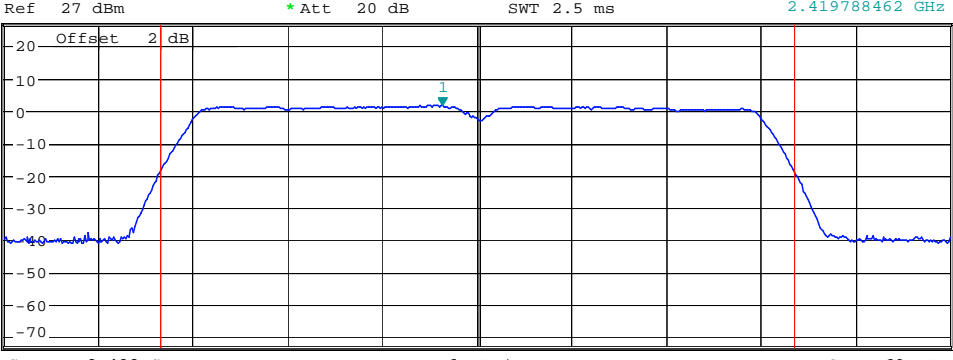

Tx Channel
Bandwidth 40 MHz Power 15.44 dBm

802.11n at HT40 of CH6



* RBW 1 MHz
* VBW 3 MHz
SWT 2.5 ms
Marker 1 [T1]
1.32 dBm
2.434596154 GHz

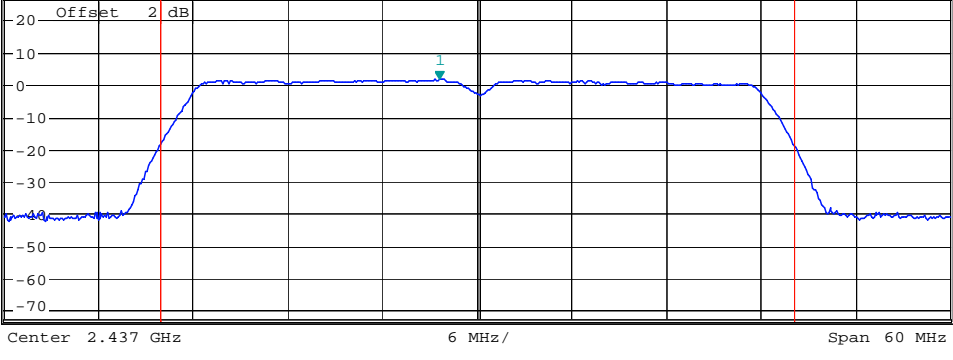

Tx Channel
Bandwidth 40 MHz Power 15.33 dBm

802.11n at HT40 of CH9



* RBW 1 MHz
* VBW 3 MHz
SWT 2.5 ms
Marker 1 [T1]
2.13 dBm
2.449692308 GHz

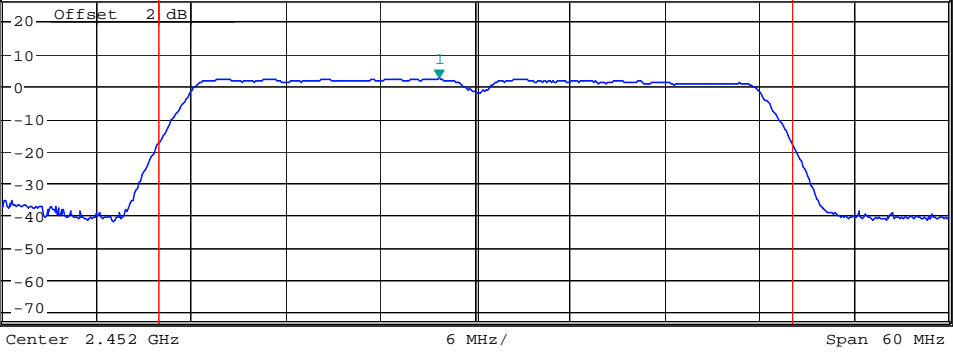

Tx Channel
Bandwidth 40 MHz Power 16.15 dBm

Average power:

Wi-Fi 2412-2462 MHz	Channel	Average Power (dBm) for Data Rates (Mbps)							
		1	2	5.5	11	/	/	/	/
802.11b	1	15.35	15.39	15.49	15.50	/	/	/	/
	6	15.57	15.60	15.58	15.60	/	/	/	/
	11	15.29	15.32	15.34	15.41	/	/	/	/
802.11g	Channel	6	9	12	18	24	36	48	54
	1	14.40	14.42	14.46	14.38	14.44	14.47	14.43	14.39
	6	14.21	14.23	14.50	14.46	14.43	14.40	14.41	14.38
	11	14.29	14.31	14.35	14.36	14.38	14.45	14.43	14.40
802.11n (20M)	Channel	6.5	13	19.5	26	39	52	58.5	65
	1	13.45	13.40	13.42	13.45	13.40	13.39	13.41	13.47
	6	13.30	13.38	13.40	13.41	13.43	13.40	13.42	13.38
	11	13.52	13.54	13.56	13.58	13.60	13.57	13.55	13.60
802.11n (40M)	Channel	MCS0	MCS1	MCS2	MCS3	MCS4	MCS5	MCS6	MCS7
	3	12.44	12.40	12.41	12.48	12.47	12.40	12.38	12.36
	6	12.33	12.35	12.37	12.40	12.43	12.45	12.41	12.40
	9	12.28	12.30	12.27	12.28	12.26	12.30	12.33	12.35

9. POWER SPECTRAL DENSITY MEASUREMENT

9.1 TEST SETUP

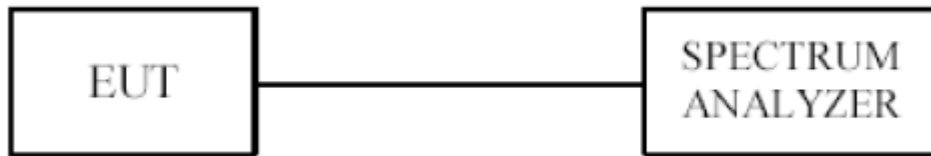

The sample with a test program port is used to test. The EUT test port and Spectrum Analyzer are connected by the RF Cable.

9.2 LIMITS OF POWER SPECTRAL DENSITY MEASUREMENT

The Maximum Power Spectral Density Measurement is 8dBm.

9.3 TEST PROCEDURE

1. Use this procedure when the maximum peak conducted output power in the fundamental emission is used to demonstrate compliance.
2. Set the RBW = 3 kHz.
3. Set the VBW = 10 kHz.
4. Set the span to 1.5 times the DTS channel bandwidth.
5. Detector = peak.
6. Sweep time = auto couple.
7. Trace mode = max hold.
8. Allow trace to fully stabilize.
9. Use the peak marker function to determine the maximum amplitude level.
10. If measured value exceeds limit, reduce RBW (no less than 3 kHz) and repeat.
11. The resulting peak PSD level must be ≤ 8 dBm.

9.4 TEST RESULT

EUT		Mobile Phone		Model		PHANTOM Z mini	
Mode		802.11b		Humidity		56% RH	
Temperature		24 deg. C,					
Channel	Channel Frequency (MHz)	Final RF Power Level in (dBm/3KHz)	Maximum Limit (dBm/3KHz)	Pass/ Fail			
1Mbps							
1	2412	-16.20	8	Pass			
6	2437	-16.73	8	Pass			
11	2462	-17.00	8	Pass			

EUT		Mobile Phone		Model		PHANTOM Z mini	
Mode		802.11g		Humidity		56% RH	
Temperature		24 deg. C,					
Channel	Channel Frequency (MHz)	Final RF Power Level in (dBm/3KHz)	Maximum Limit (dBm/3KHz)	Pass/ Fail			
6Mbps							
1	2412	-19.03	8	Pass			
6	2437	-19.90	8	Pass			
11	2462	-19.45	8	Pass			

EUT		Mobile Phone		Model		PHANTOM Z mini	
Mode		802.11n HT20		Humidity		56% RH	
Temperature		24 deg. C,					
Channel	Channel Frequency (MHz)	Final RF Power Level in (dBm/3KHz)	Maximum Limit (dBm/3KHz)	Pass/ Fail			
6.5Mbps							
1	2412	-18.69	8	Pass			
6	2437	-18.52	8	Pass			
11	2462	-18.95	8	Pass			

EUT		Mobile Phone		Model		PHANTOM Z mini	
Mode		802.11n HT40		Humidity		56% RH	
Temperature		24 deg. C,					
Channel	Channel Frequency (MHz)	Final RF Power Level in (dBm/3KHz)	Maximum Limit (dBm/3KHz)	Pass/ Fail			
13.5Mbps							
3	2422	-22.84	8	Pass			
6	2437	-22.86	8	Pass			
9	2452	-22.08	8	Pass			

Remark: All of the modes have been investigated, and only worst mode is presented in this report.

802.11b at 1Mbps of CH1

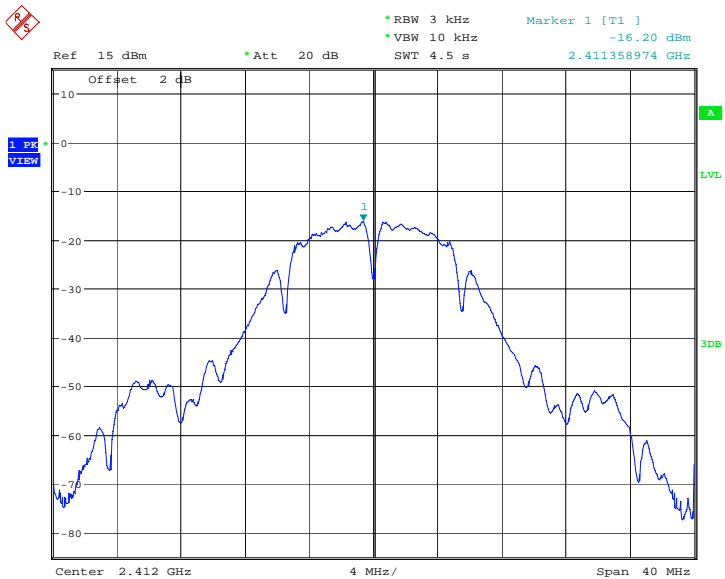

802.11b at 1Mbps at CH6

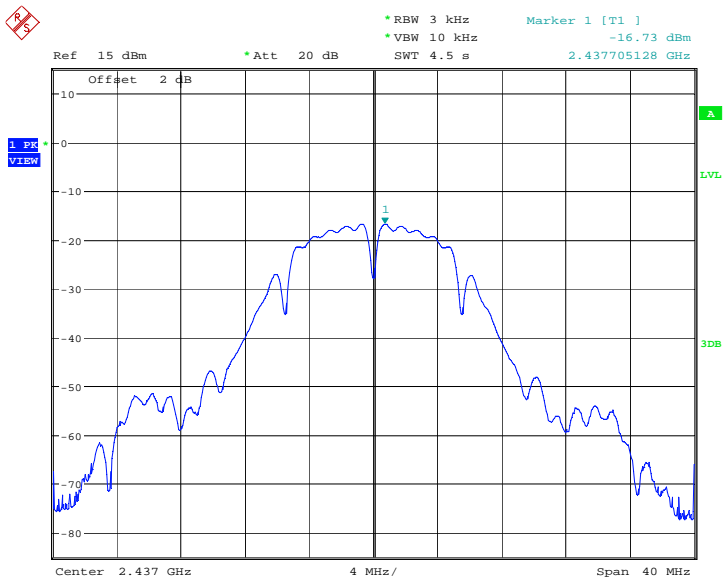

802.11b at 1Mbps of CH11

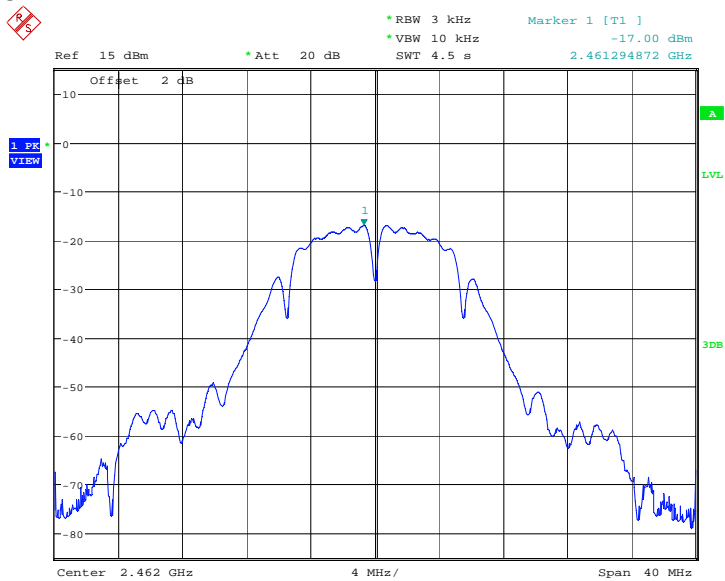

802.11g at 6Mbps of CH1

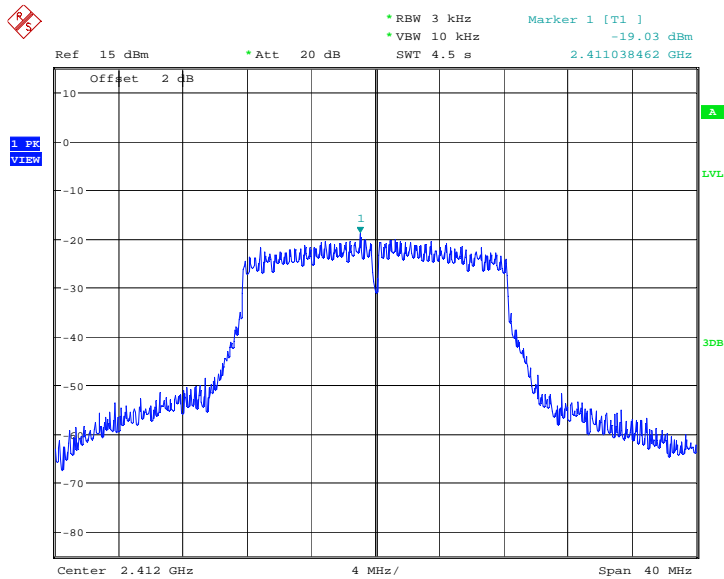

802.11g at 6Mbps of CH6

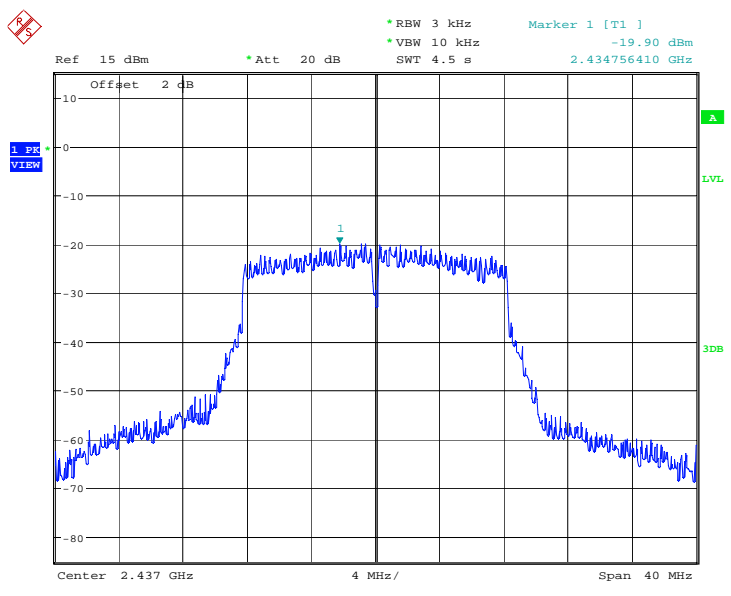

802.11g at 6Mbps of CH11

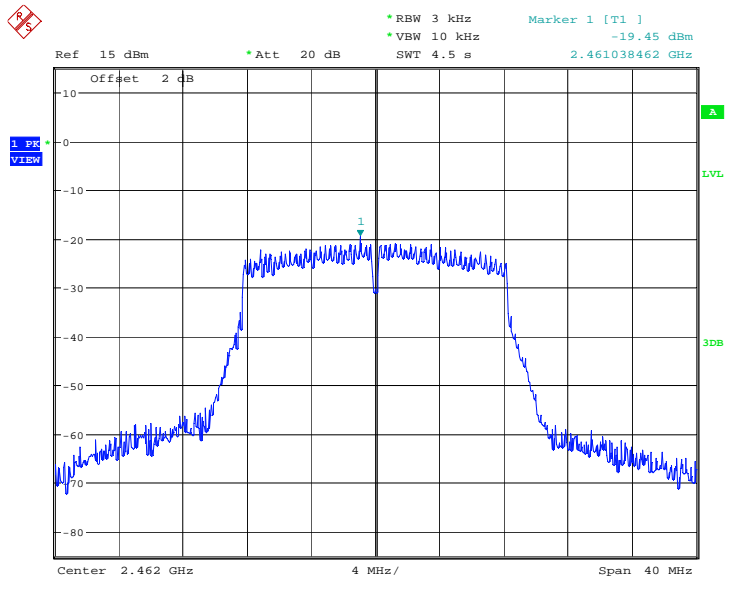

802.11n HT20 at 6.5Mbps of CH1

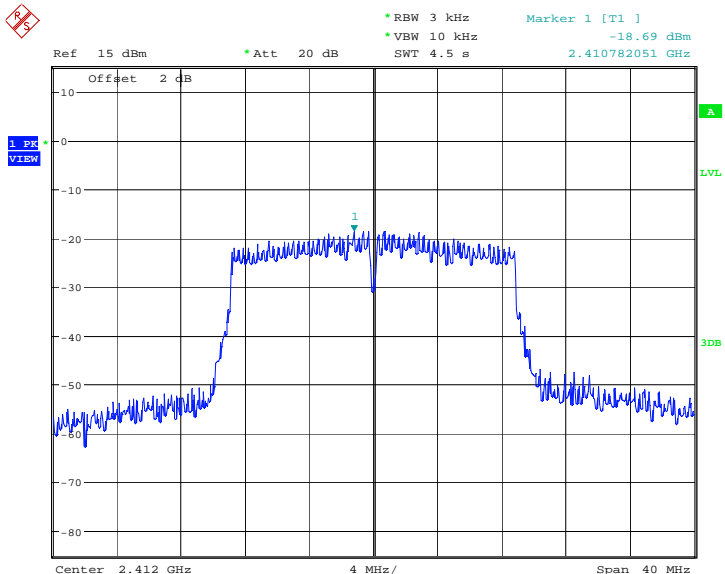

802.11n HT20 at 6.5Mbps of CH6

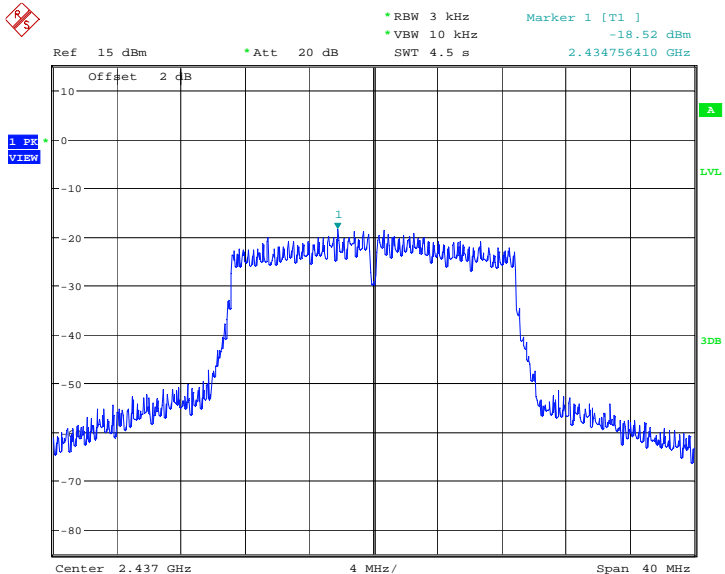

802.11n HT20 at 6.5Mbps of CH11

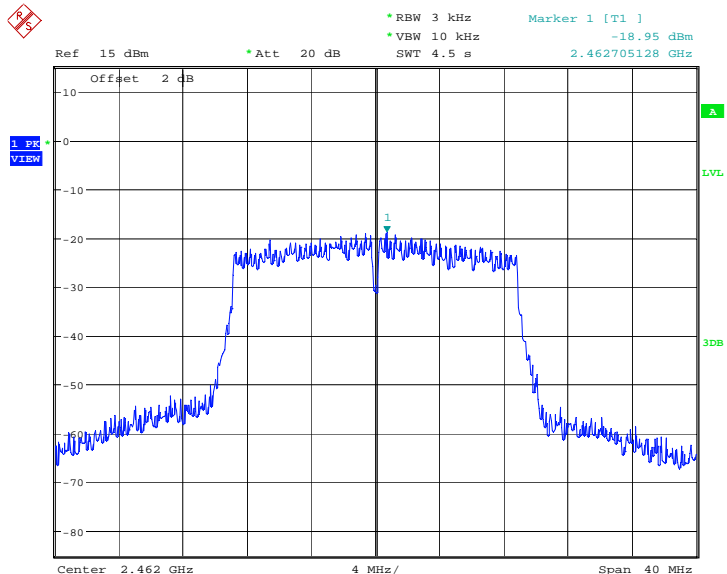

802.11n HT40 at 13.5Mbps of CH3

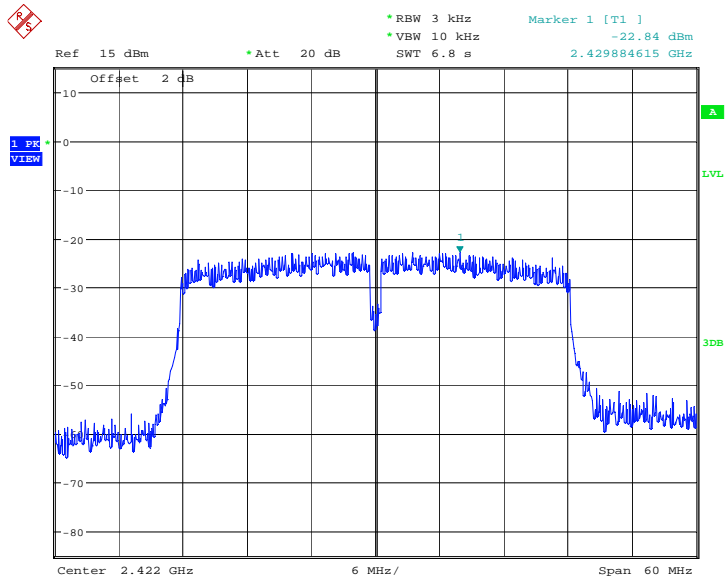

802.11n HT40 at 13.5Mbps of CH6

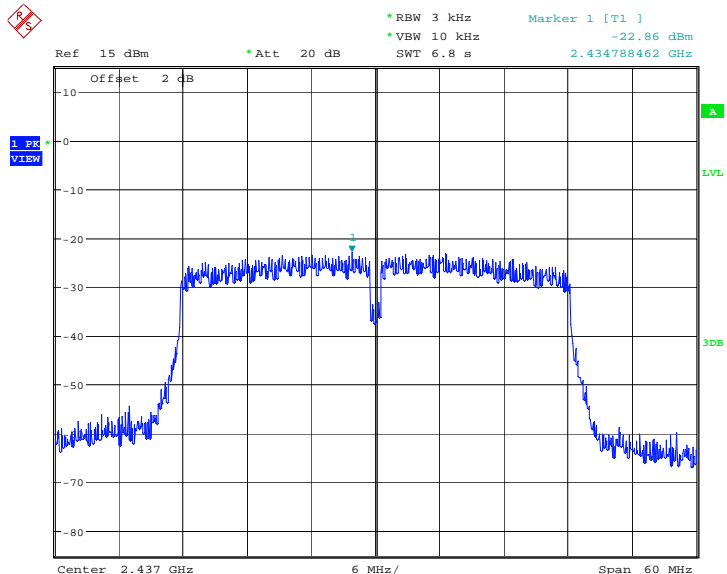

802.11n HT40 at 13.5Mbps of CH9

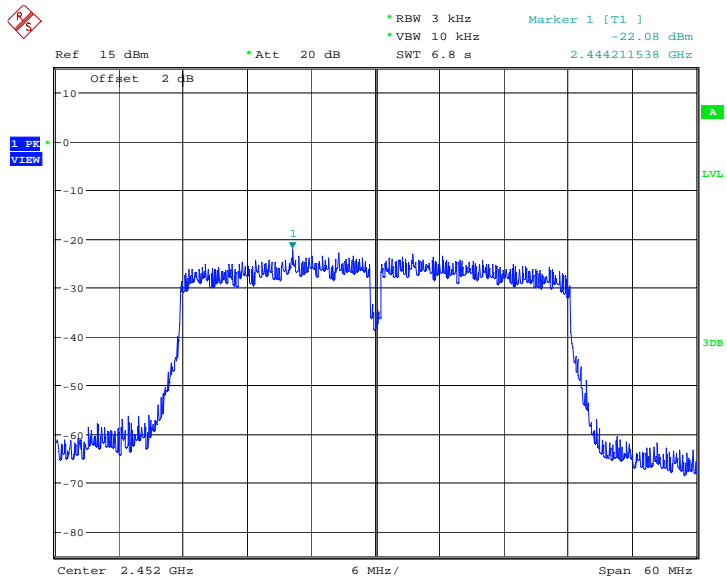

10. OUT OF BAND MEASUREMENT

10.1 TEST SETUP FOR BAND EDGE

The restricted band requirement based on radiated emission test; please see the clause 5.2 for the test setup

10.2 LIMITS OF OUT OF BAND EMISSIONS MEASUREMENT

1. Below –20dB of the highest emission level of operating band (in 100kHz Resolution Bandwidth).
2. Fall in the restricted bands listed in section 15.205. The maximum permitted average field strength is listed in section 15.209.

10.3 TEST PROCEDURE

- a. The measuring distance of at 3 m shall be used for measurements at frequency up to 1GHz. For frequencies above 1GHz, any suitable measuring distance may be used.
- b. The EUT was placed on the top of a rotating table 0.8 meters above the ground at a 3 meter open area test site. The table was rotated 360 degrees to determine the position of the highest radiation.
- c. The height of the equipment shall be 0.8 m; the height of the test antenna shall vary between 1 m to 4 m. Both horizontal and vertical polarizations of the antenna are set to make the measurement.
- d. If the Peak Mode measured value compliance with and lower than Quasi Peak Mode Limit, the EUT shall be deemed to meet QP Limits and then no additional QP Mode measurement performed.
- e. For the actual test configuration, please refer to the related Item –EUT Test Photos.

Note:

Both horizontal and vertical antenna polarities were tested and performed pretest to three orthogonal axis. The worst case emissions were reported

10.4 TEST RESULT

Please see next pages

Note: This is a handheld device. The radiated emissions should be tested under 3-axes position (Lying, Stand), After pre-test. It was found that the worse radiated emission was get at the lying position.

Radiated measurement:**802.11b**

Indicated		result (PK/AV)	Antenna Polar (H/V)	Correction Factor			FCC Part 15.247		
Frequency (MHz)	Receiver Reading (dB μ V/m)			Ant. Factor (dB/m)	Cable Loss (dB)	Pre-Amp. Gain (dB)	Cord. Amp. (dB μ V/m)	Limit (dB μ V/m)	Margin (dB)
Low Channel (2412MHz)									
2390	37.60	AV	V	30.3	4.1	33.1	38.90	54	15.10
2390	40.92	AV	H	30.3	4.1	33.1	42.22	54	11.78
2390	56.57	PK	V	30.3	4.1	33.1	57.87	74	16.13
2390	57.78	PK	H	30.3	4.1	33.1	59.08	74	14.92
High Channel (2462MHz)									
2483.5	32.27	AV	V	31	4.4	32.7	34.97	54	19.03
2483.5	33.46	AV	H	31	4.4	32.7	36.16	54	17.84
2483.5	59.09	PK	V	31	4.4	32.7	61.79	74	12.21
2483.5	57.21	PK	H	31	4.4	32.7	59.91	74	14.09

802.11g

Indicated		result (PK/AV)	Antenna Polar (H/V)	Correction Factor			FCC Part 15.247		
Frequency (MHz)	Receiver Reading (dB μ V/m)			Ant. Factor (dB/m)	Cable Loss (dB)	Pre-Amp. Gain (dB)	Cord. Amp. (dB μ V/m)	Limit (dB μ V/m)	Margin (dB)
Low Channel (2412MHz)									
2390	41.20	AV	V	30.3	4.1	33.1	42.50	54	11.50
2390	40.49	AV	H	30.3	4.1	33.1	41.79	54	12.21
2390	55.26	PK	V	30.3	4.1	33.1	56.56	74	17.44
2390	54.08	PK	H	30.3	4.1	33.1	55.38	74	18.62
High Channel (2462MHz)									
2483.5	34.32	AV	V	31	4.4	32.7	37.02	54	16.98
2483.5	33.89	AV	H	31	4.4	32.7	36.59	54	17.41
2483.5	59.85	PK	V	31	4.4	32.7	62.55	74	11.45
2483.5	56.80	PK	H	31	4.4	32.7	59.50	74	14.50

Note: The BAND EDGE RESTRICTED BANDS emission is too low at least 20dB to the Fundamental.

802.11n HT20

Indicated		result (PK/AV)	Antenna Polar (H/V)	Correction Factor			FCC Part 15.247		
Frequency (MHz)	Receiver Reading (dB μ V/m)			Ant. Factor (dB/m)	Cable Loss (dB)	Pre-Amp. Gain (dB)	Cord. Amp. (dB μ V/m)	Limit (dB μ V/m)	Margin (dB)
Low Channel (2412MHz)									
2390	49.51	AV	V	30.3	4.1	33.1	50.81	54	3.19
2390	38.14	AV	H	30.3	4.1	33.1	39.44	54	14.56
2390	56.78	PK	V	30.3	4.1	33.1	58.08	74	15.92
2390	53.11	PK	H	30.3	4.1	33.1	54.41	74	19.59
High Channel (2462MHz)									
2483.5	32.93	AV	V	31	4.4	32.7	35.63	54	18.37
2483.5	34.91	AV	H	31	4.4	32.7	37.61	54	16.39
2483.5	59.66	PK	V	31	4.4	32.7	62.36	74	11.64
2483.5	57.65	PK	H	31	4.4	32.7	60.35	74	13.65

802.11n HT40

Indicated		result (PK/AV)	Antenna Polar (H/V)	Correction Factor			FCC Part 15.247		
Frequency (MHz)	Receiver Reading (dB μ V/m)			Ant. Factor (dB/m)	Cable Loss (dB)	Pre-Amp. Gain (dB)	Cord. Amp. (dB μ V/m)	Limit (dB μ V/m)	Margin (dB)
Low Channel (2422MHz)									
2390	49.27	AV	V	30.3	4.1	33.1	50.57	54	3.43
2390	39.23	AV	H	30.3	4.1	33.1	40.53	54	13.47
2390	60.54	PK	V	30.3	4.1	33.1	61.84	74	12.16
2390	57.79	PK	H	30.3	4.1	33.1	59.09	74	14.91
High Channel (2452MHz)									
2483.5	36.76	AV	V	31	4.4	32.7	39.46	54	14.54
2483.5	37.95	AV	H	31	4.4	32.7	40.65	54	13.35
2483.5	56.67	PK	V	31	4.4	32.7	59.37	74	14.63
2483.5	59.54	PK	H	31	4.4	32.7	62.24	74	11.76

Note: The BAND EDGE RESTRICTED BANDS emission is too low at least 20dB to the Fundamental.

802.11b:

Low channel

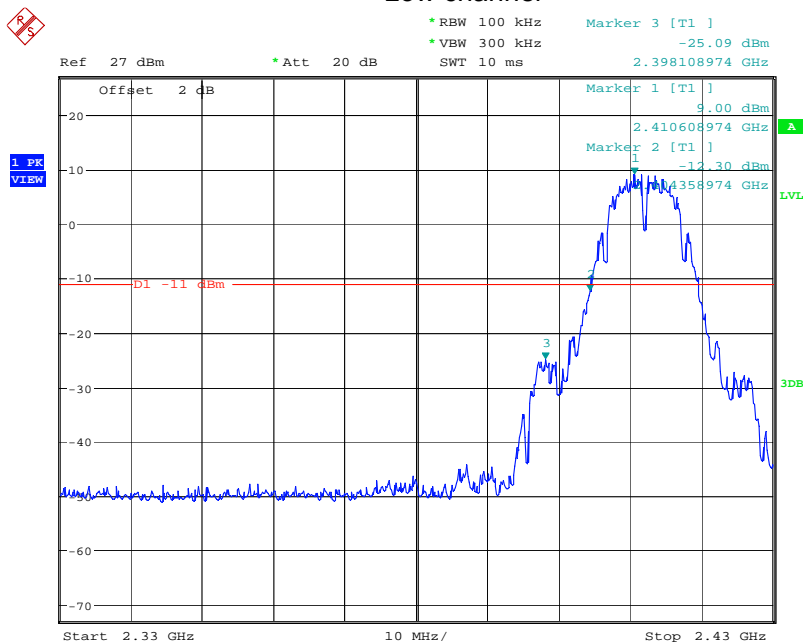

High channel

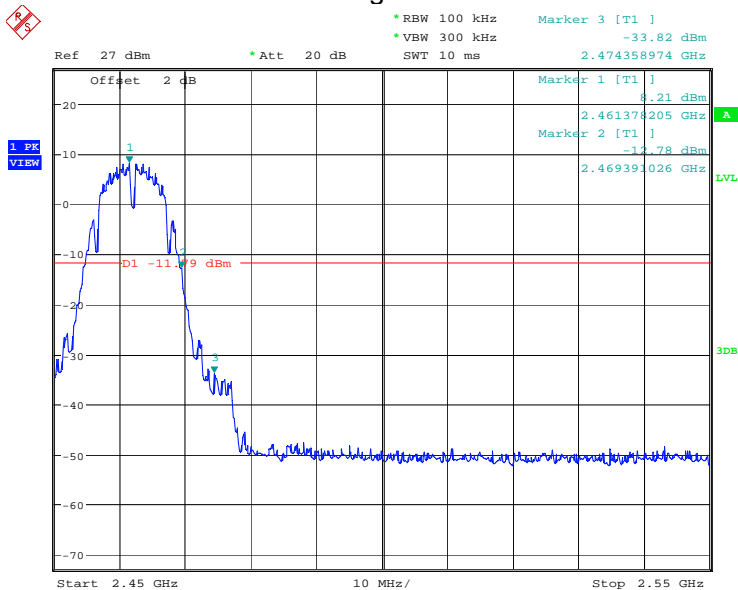

802.11g:

Low channel

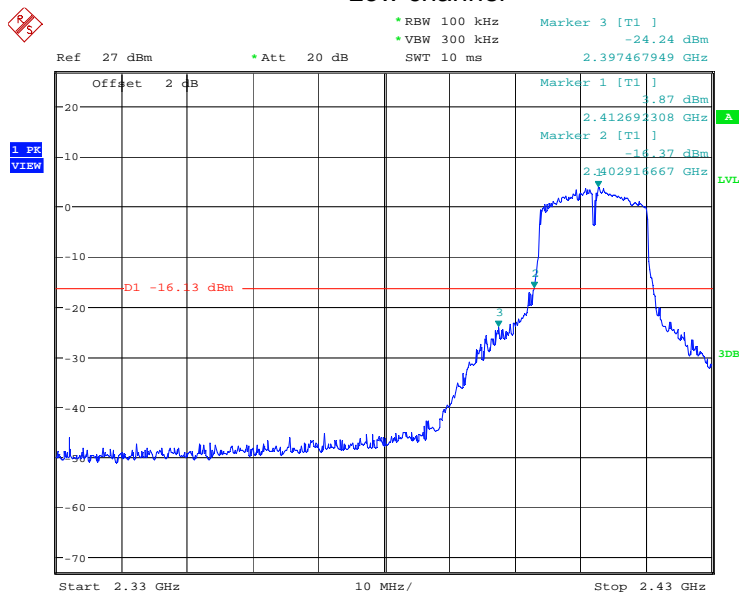

High channel

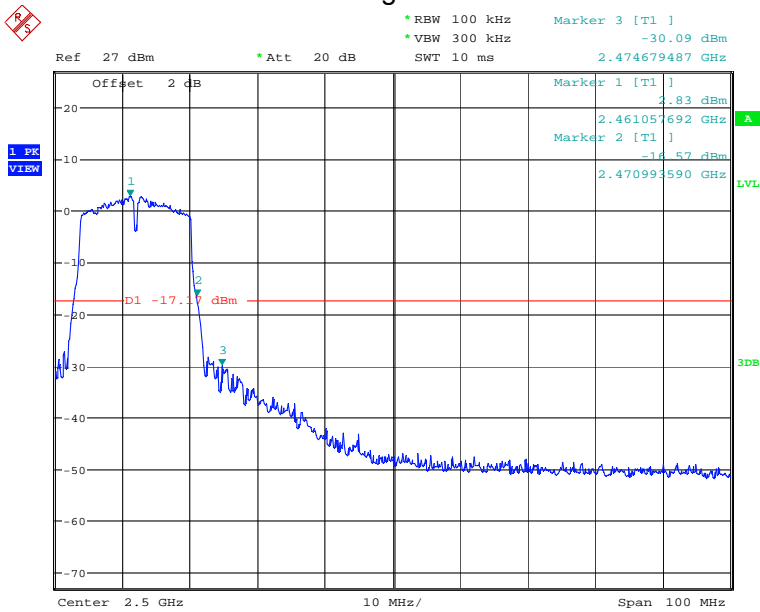

802.11n HT20:

Low channel

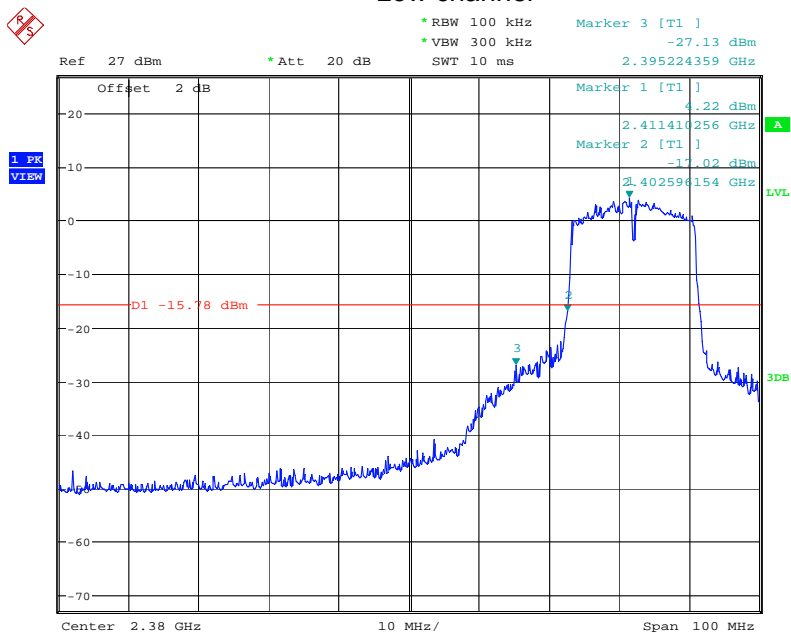

High channel

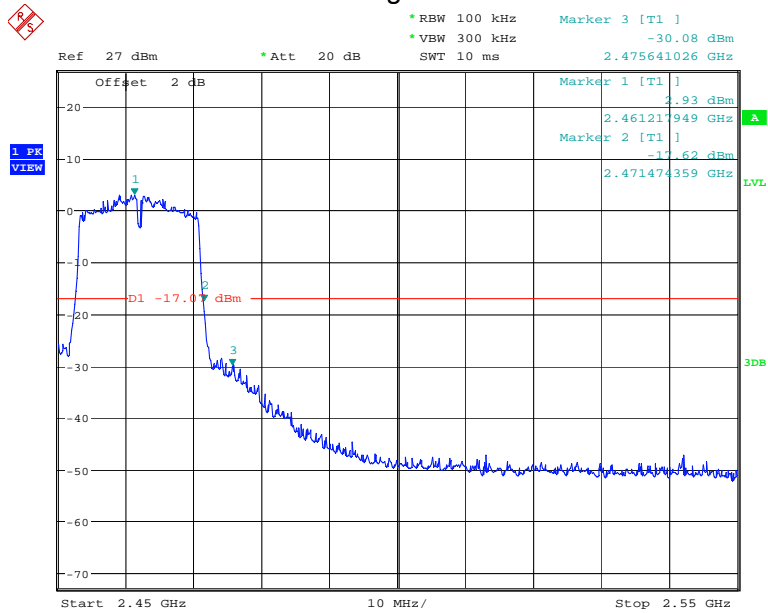

802.11n HT40:

Low channel

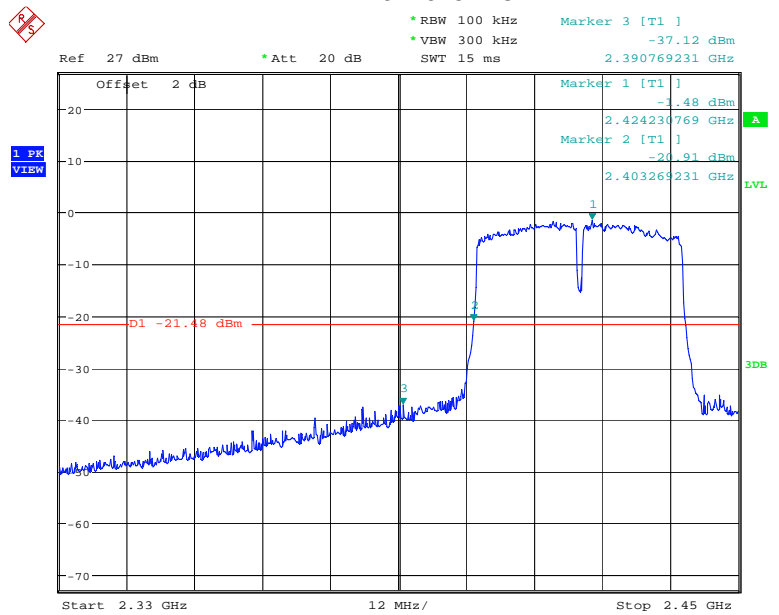

High channel

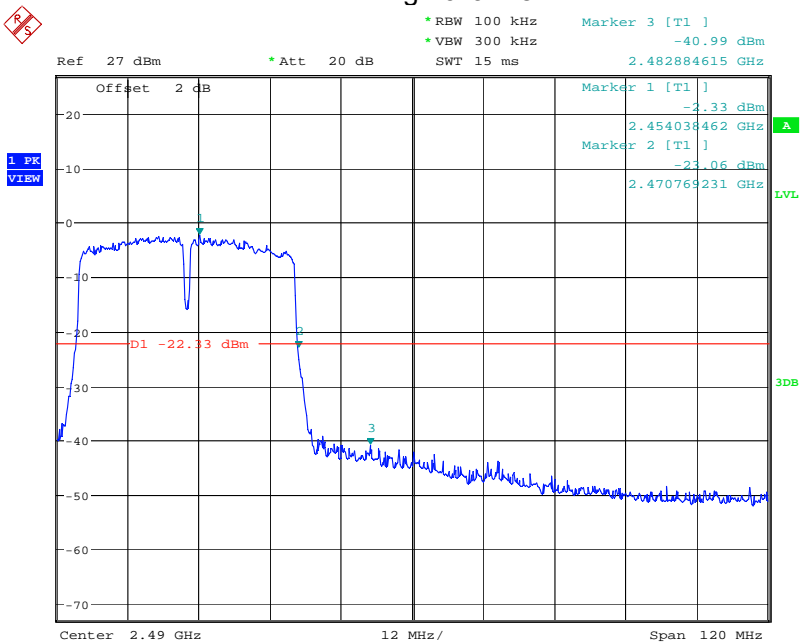

11. EUT TEST PHOTO

CONDUCTED EMISSION TEST



RADIATED EMISSION TEST

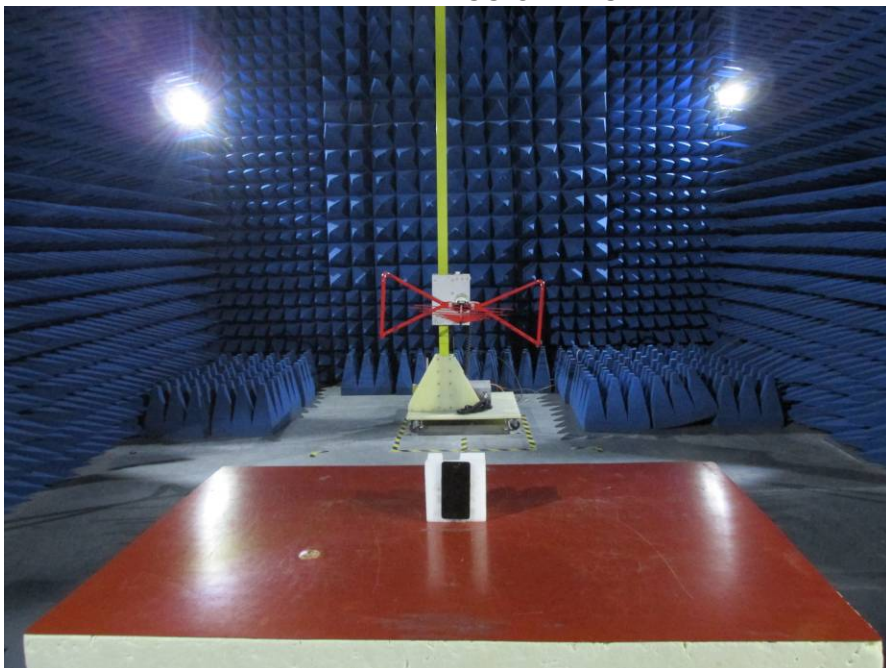

RADIATED EMISSION TEST

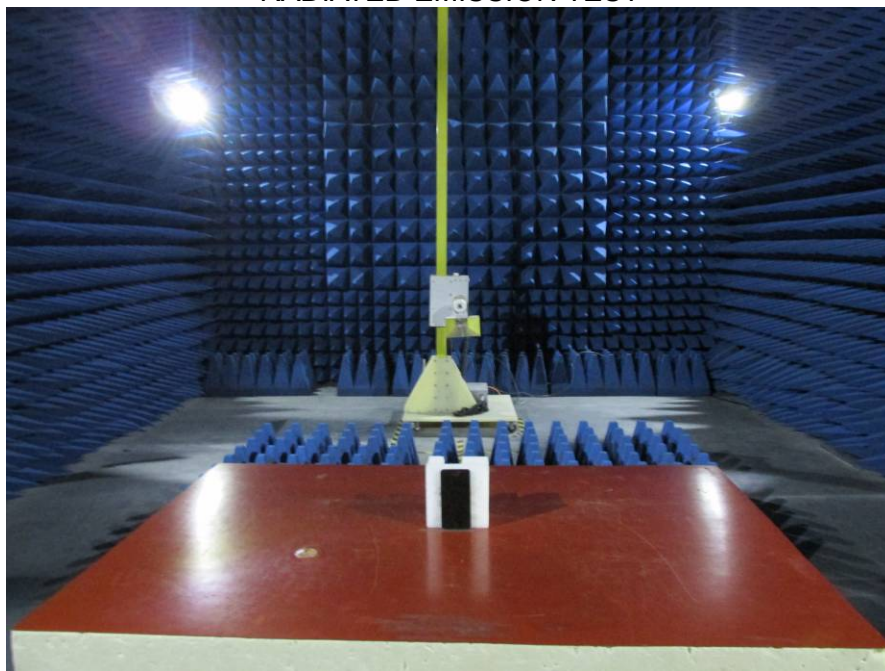

12. PHOTOGRAPHS OF EUT

Appearance photograph of EUT



Appearance photograph of EUT

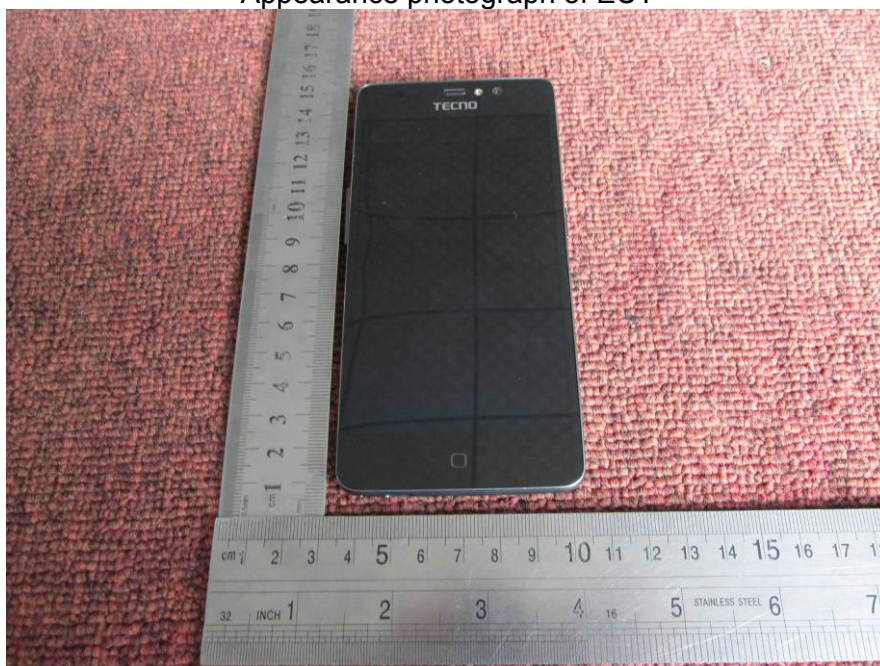

Appearance photograph of EUT



Appearance photograph of EUT



Appearance photograph of EUT



Appearance photograph of EUT



Appearance photograph of EUT

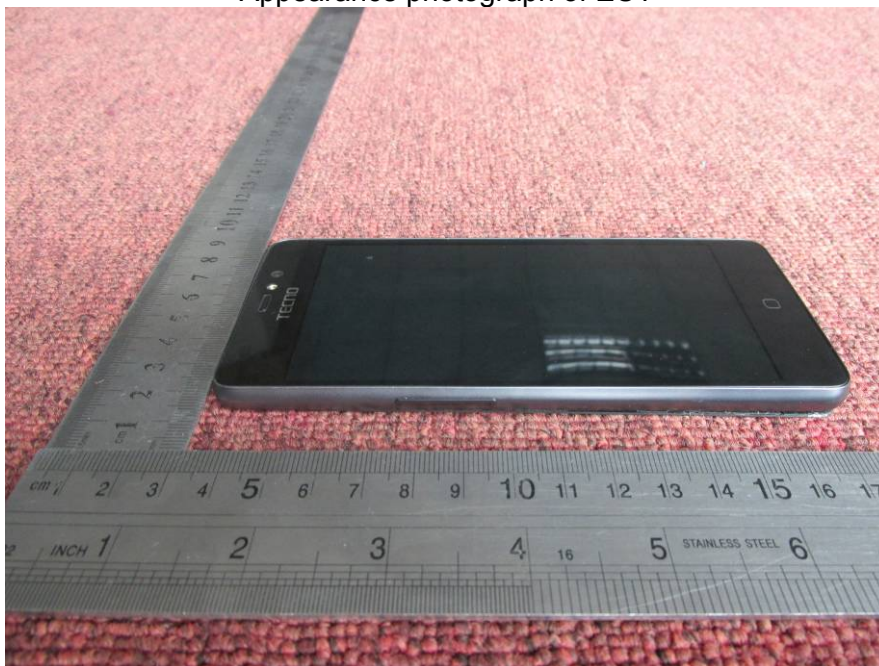

Appearance photograph of EUT



Appearance photograph of EUT



Internal photograph of EUT

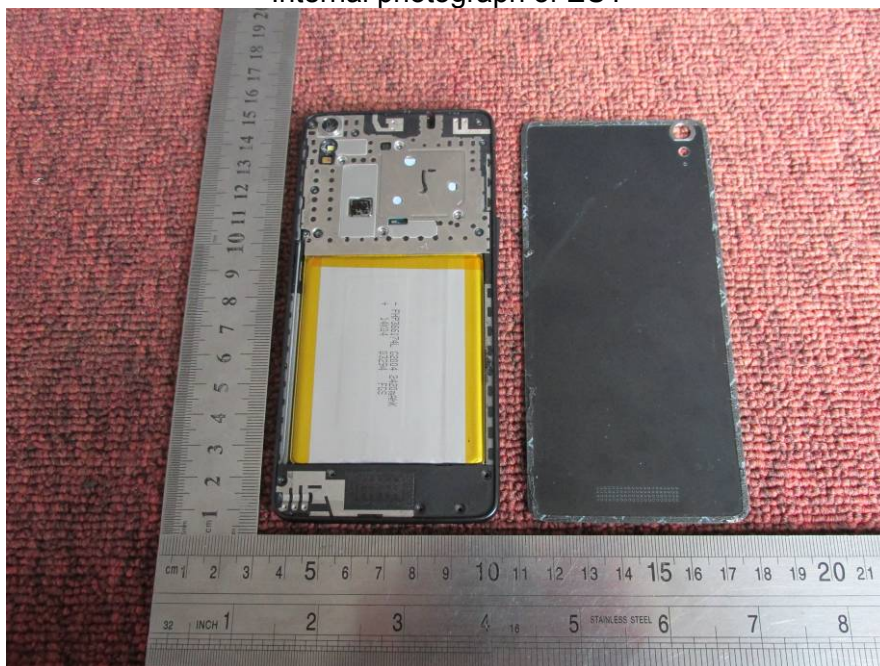

Internal photograph of EUT

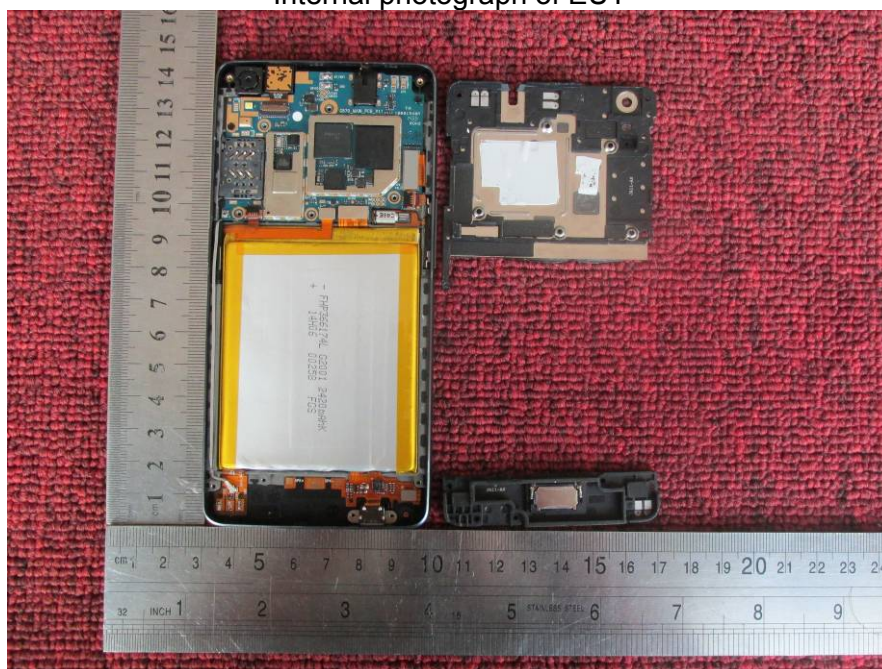

Internal photograph of EUT

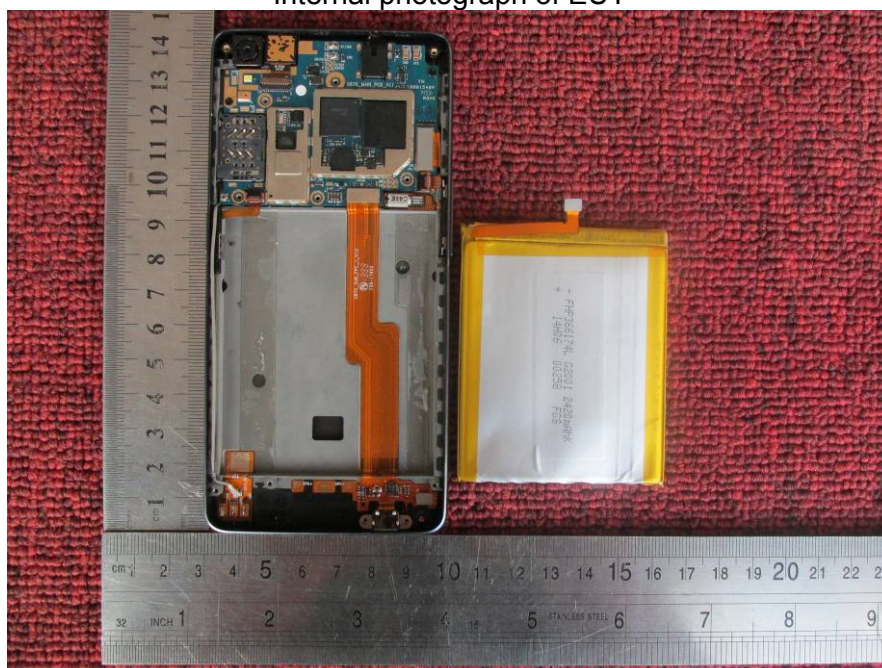

Internal photograph of EUT



Internal photograph of EUT



Internal photograph of EUT

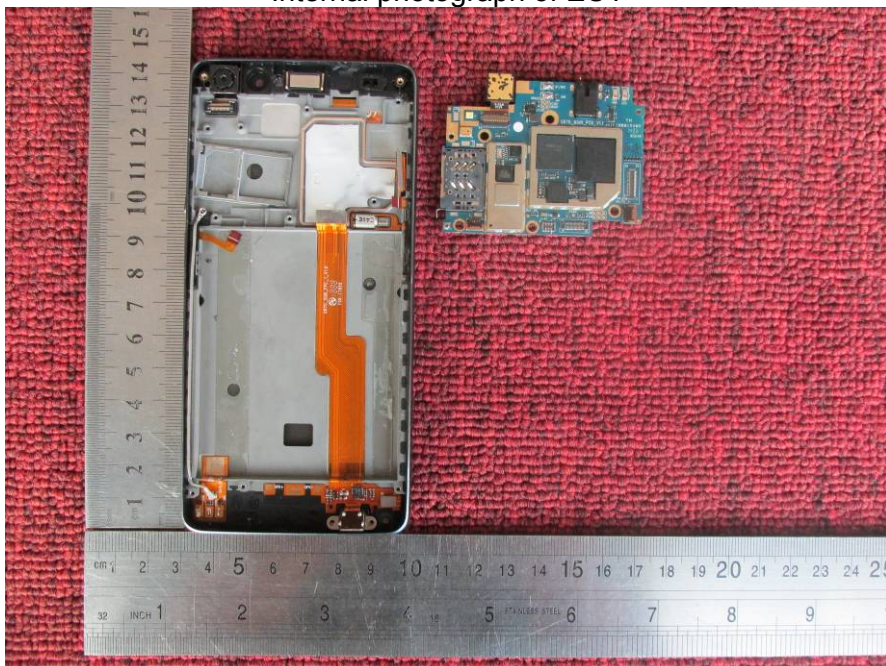

Internal photograph of EUT

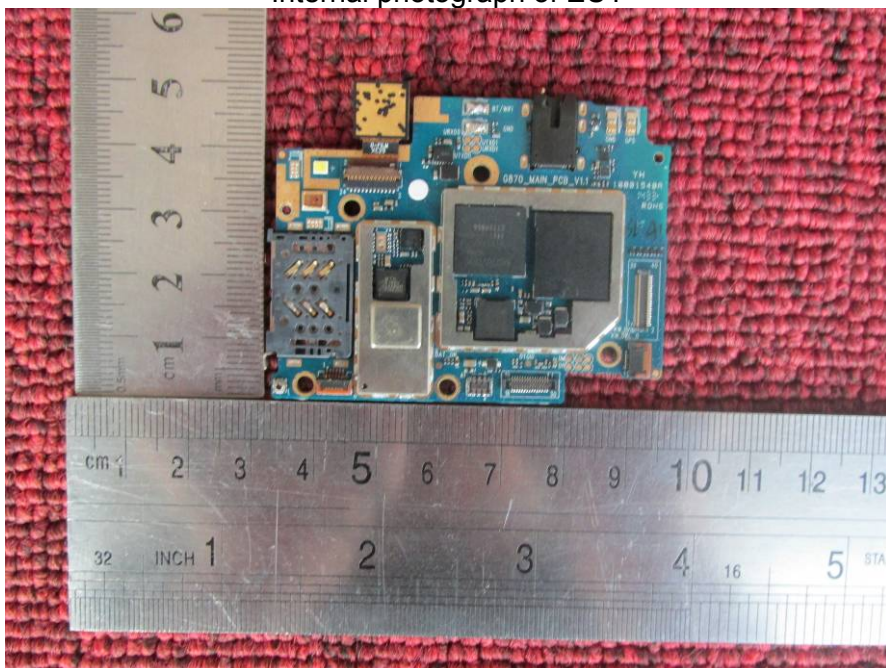

Internal photograph of EUT

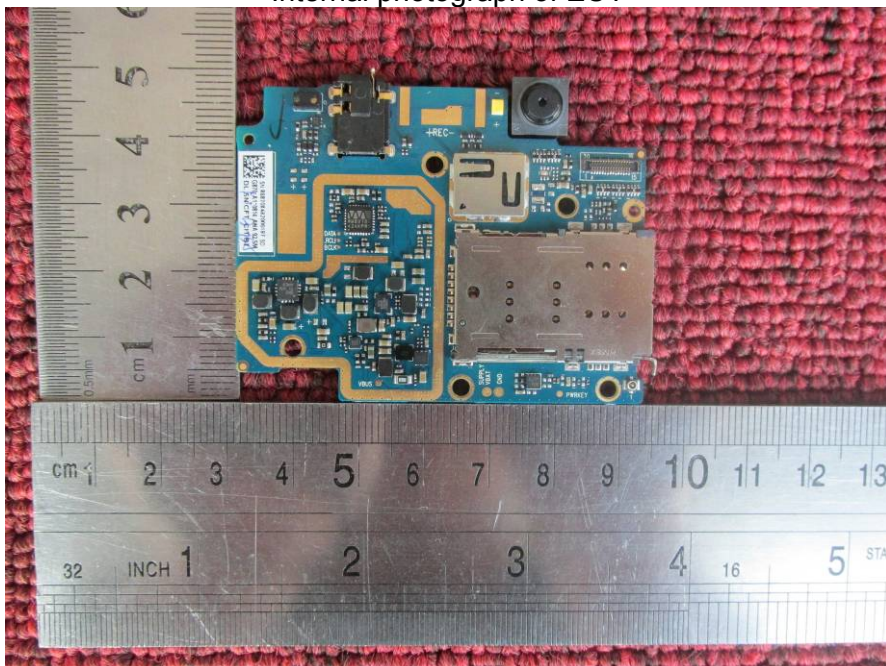

Internal photograph of EUT

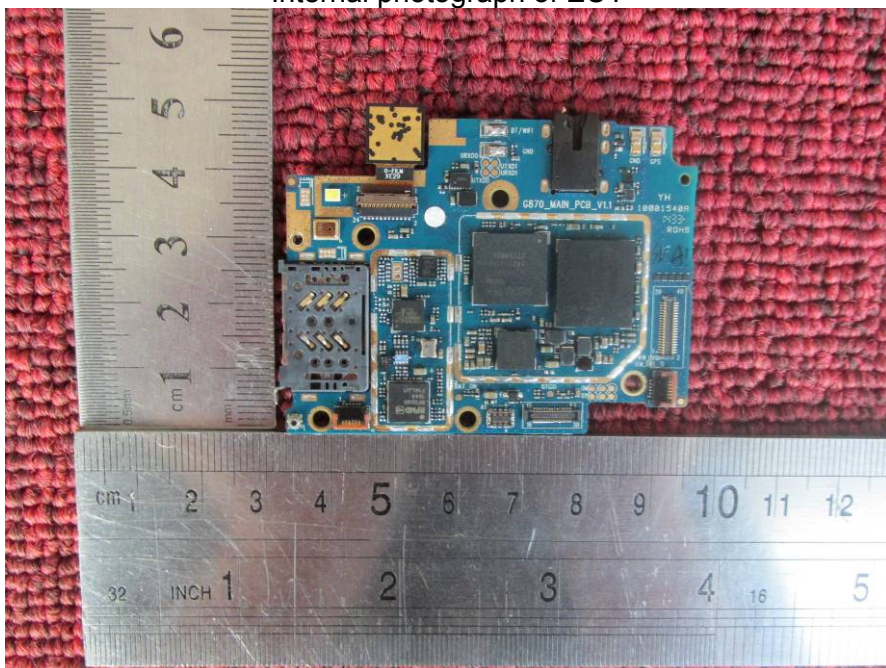

—END OF REPORT—