



BT Test Report

Application Purpose : Original grant
Applicant Name: : TECNO MOBILE LIMITED
FCC ID : 2ADYY-PHANTOMZMINI
Equipment Type : Mobile Phone
Model Name : PHANTOM Z mini
Report Number : FCC15016722-4
Standard(S) : FCC Part 15 Subpart C
Date Of Receipt : January 16, 2015
Date Of Issue : January 29, 2015

Test By : 

(Neil Wong)

Reviewed By : 

(Robie Chen)

Authorized by : 

(Michal Ling)

Prepared by : **Shenzhen WST Testing Technology Co., Ltd.**
1F, No.9 Building, TGK Science & Technology Park Yangtian
Rd., NO.72 Bao'an Dist., GuangDong, China
(Registration Number: 939433)

REPORT REVISE RECORD

Report Version	Revise Time	Issued Date	Valid Version	Notes
V1.0		January 29, 2015	Valid	Original Report

1. GENERAL DESCRIPTION OF EUT	错误! 未定义书签。
2. TEST DESCRIPTION	7
2.1 MEASUREMENT UNCERTAINTY	7
2.2 DESCRIPTION OF TEST MODES.....	8
2.3 TABLE OF PARAMETERS OF TEXT SOFTWARE SETTING.....	9
2.4 CONFIGURATION OF SYSTEM UNDER TEST	9
2.5 DESCRIPTION OF SUPPORT UNITS (CONDUCTED MODE)	10
3. SUMMARY OF TEST RESULTS	11
4. MEASUREMENT INSTRUMENTS	12
§15.203 - ANTENNA REQUIREMENT	13
STANDARD APPLICABLE	13
ANTENNA CONNECTOR CONSTRUCTION	13
§15.207 - CONDUCTED EMISSIONS	14
APPLICABLE STANDARD	14
TEST PROCEDURE.....	14
TEST CONDITIONS	14
PLOT(S) OF TEST DATA	14
§15.209, §15.205, §15.247(D) - SPURIOUS EMISSIONS	17
TEST EQUIPMENT.....	17
TEST PROCEDURE.....	17
ENVIRONMENTAL CONDITIONS	17
RADIATED TEST SETUP	17
RADIATED EMISSION LIMIT.....	19
§15.247(A) (2) – 6DB BANDWIDTH TESTING	25
TEST EQUIPMENT.....	25
TEST PROCEDURE.....	25
ENVIRONMENTAL CONDITIONS	25
APPLICABLE STANDARD	25
TEST RESULT: PASS.	26
§15.247(B) (3) - MAXIMUM PEAK OUTPUT POWER	28
TEST EQUIPMENT.....	28
TEST PROCEDURE.....	28

ENVIRONMENTAL CONDITIONS	28
APPLICABLE STANDARD	28
TEST RESULT	29
§15.247(D) – 100 KHZ BANDWIDTH OF FREQUENCY BAND EDGE	31
TEST EQUIPMENT	31
TEST PROCEDURE	31
ENVIRONMENTAL CONDITIONS	31
APPLICABLE STANDARD	31
TEST RESULT	31
§15.247(E) -MAXIMUM CONDUCTED POWER SPECTRAL DENSITY	33
TEST EQUIPMENT	33
TEST PROCEDURE	33
ENVIRONMENTAL CONDITIONS	33
APPLICABLE STANDARD	33
TEST RESULT	34
PHOTOGRAPHS OF THE TEST CONFIGURATION	36
PHOTOGRAPHS OF EUT	38

1. GENERAL INFORMATION

Test Model	PHANTOM Z mini
Applicant	TECNO MOBILE LIMITED
Address	RMS 05-15, 13A/F., SOUTH TOWER, WORLD FINANCE CTR, HARBOUR CITY, KLN, HK.
Manufacturer	SHENZHEN SMARTTEL CO., LTD.
Address	6th Floor, Block 15, shatoujiao Free TRADE Zone, Shenyang Road, Yantian District, Shenzhen, Guangdong, P.R.China
Equipment Type	Mobile Phone
Brand Name	TECNO
Hardware version:	G870_MAIN_PCB_V1.1
Software version:	V1.1
Extreme Temp. Tolerance	-10°C to +50°C
Battery information:	Model: BL-24CT Voltage: 3.8V Capacity: 2420mAh
Adapter Information:	Model: A88-502000 Input: AC100-240 V, 50/60 Hz, 0.35A Output: DC 5V 2.0A
Operating Frequency	2402-2480MHz
Channels	40
Channel Spacing	1MHz
Modulation Type	GFSK
Version	4.0
Antenna Type:	Integral Antenna
Antenna gain:	1.55dBi
Data of receipt	January 16, 2015
Date of test	January 16, 2015 to January 29, 2015
Deviation	None
Condition of Test Sample	Normal

We hereby certify that:

All measurement facilities used to collect the measurement data are located at
1F, No.9 Building, TGK Science & Technology Park Yangtian Rd., NO.72 Bao'an Dist., Guangdong,
China

The data evaluation, test procedures, and equipment configurations shown in this report were made
in accordance with the procedures given in ANSI C 63.4:2009. The sample tested as described in
this report is in compliance with the FCC Rules Part 15 Subpart C.

The test results of this report relate only to the tested sample identified in this report.

2. TEST DESCRIPTION

2.1 MEASUREMENT UNCERTAINTY

The reported uncertainty of measurement $y \pm U$, where expanded uncertainty U is based on a standard uncertainty multiplied by a coverage factor of $k=2$, providing a level of confidence of approximately **95 %**.

No.	Item	Uncertainty
1	Conducted Emission Test	$\pm 3.2\text{dB}$
2	RF power, conducted	$\pm 0.16\text{dB}$
3	Spurious emissions, conducted	$\pm 0.21\text{dB}$
4	All emissions, radiated(<1G)	$\pm 4.7\text{dB}$
5	All emissions, radiated(>1G)	$\pm 4.7\text{dB}$
6	Temperature	$\pm 0.5^\circ\text{C}$
7	Humidity	$\pm 2\%$

2.2 DESCRIPTION OF TEST MODES

To investigate the maximum EMI emission characteristics generated from EUT, the test system was pre-scanning tested based on the consideration of following EUT operation mode or test configuration mode which possibly have effect on EMI emission level. Each of these EUT operation mode(s) or test configuration mode(s) mentioned above was evaluated respectively.

Pretest Mode	Description
Mode 1	CH00
Mode 2	CH20
Mode 3	CH39
Mode 4	Normal Hopping

For Radiated Emission	
Final Test Mode	Description
Mode 1	CH00
Mode 2	CH20
Mode 3	CH39

Note:

- (1) The measurements are performed at the highest, middle, lowest available channels.**
- (2) Record the worst case of each test item in this report.**

2.3 Table of Parameters of Text Software Setting

During testing channel & power controlling software provided by the customer was used to control the operating channel as well as the output power level. The RF output power selection is for the setting of RF output power expected by the customer and is going to be fixed on the firmware of the final end product power parameters of FHSS

Test software Version	N/A
Test program	*#9646633#

Frequency	2402 MHz	2440 MHz	2480 MHz
Parameters(1Mbps)	DEF	DEF	DEF

2.4 CONFIGURATION OF SYSTEM UNDER TEST

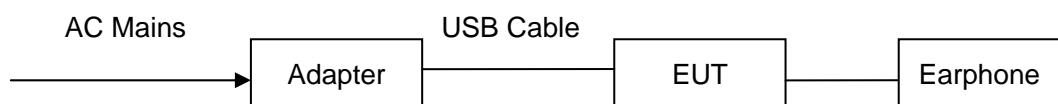

(EUT: Mobile Phone)

I/O Port of EUT			
I/O Port Type	Q'TY	Cable	Tested with
USB port	1	0.3m USB cable, unshielded	1
Earphone	1	1m	1

2.5 DESCRIPTION OF SUPPORT UNITS (CONDUCTED MODE)

The EUT has been tested as an independent unit together with other necessary accessories or support units. The following support units or accessories were used to form a representative test configuration during the tests.

Item	Equipment	Mfr/Brand	Model/Type No.	Series No.	Note
1	/	/	/	/	/

Note:

- (1) The support equipment was authorized by Declaration of Confirmation.
- (2) For detachable type I/O cable should be specified the length in cm in 『Length』 column.
- (3) “YES” is means “shielded” “with core”; “NO” is means “unshielded” “without core”.

3. SUMMARY OF TEST RESULTS

Test procedures according to the technical standards:

FCC Part15 (15.247) , Subpart C			
Standard Section	Test Item	Judgment	Remark
15.203	Antenna Requirement	PASS	
15.207	Conducted Emission	PASS	
15.209, 15.205, 15.247(d)	Spurious Emission	PASS	
15.247(a) (2)	6dB Bandwidth Testing	PASS	
15.247(b) (3)	Maximum Peak Output Power	PASS	
15.247(d)	100 KHz Bandwidth of Frequency Band Edge	PASS	
15.247(e)	Maximum Conducted Power Spectral Density	PASS	

NOTE:

(1) "N/A" denotes test is not applicable in this test report.

4. MEASUREMENT INSTRUMENTS

NAME OF EQUIPMENT	MANUFACTURER	MODEL	SERIAL NUMBER	Calibration Date	Calibration Due.
EMI Test Receiver	R&S	ESCI	100005	08/19/2014	08/18/2015
ESPI Test Receiver	ROHDE&SCHWARZ	ESPI	101139	08/19/2014	08/18/2015
LISN	AFJ	LS16	16010222119	08/19/2014	08/18/2015
LISN(EUT)	Mestec	AN3016	04/10040	08/19/2014	08/18/2015
Universal Radio Communication Tester	R&S	CMU 200	1100.0008.02	08/19/2014	08/18/2015
Coaxial cable	Megalon	LMR400	N/A	08/12/2014	08/11/2015
GPIB cable	Megalon	GPIB	N/A	08/12/2014	08/11/2015
Spectrum Analyzer	R&S	FSU	100114	08/19/2014	08/18/2015
Pre Amplifier	H.P.	HP8447E	2945A02715	10/13/2014	10/12/2015
Pre-Amplifier	CDSI	PAP-1G18-38	--	10/13/2014	10/12/2015
Bi-log Antenna	SUNOL Sciences	JB3	A021907	09/13/2014	09/12/2015
9*6*6 Anechoic	--	--	--	08/21/2014	08/20/2015
Horn Antenna	COMPLIANCE ENGINEERING	CE18000	--	09/13/2014	09/12/2015
Horn Antenna	SCHWARZBECK	BBHA9120D	9120D-631	08/23/2014	08/22/2015
Cable	TIME MICROWAVE	LMR-400	N-TYPE04	04/25/2014	04/24/2015
System-Controller	CCS	N/A	N/A	N.C.R	N.C.R
Turn Table	CCS	N/A	N/A	N.C.R	N.C.R
Antenna Tower	CCS	N/A	N/A	N.C.R	N.C.R
RF cable	Murata	MXHQ87WA3000	-	08/21/2014	08/20/2015
Loop Antenna	EMCO	6502	00042960	08/22/2014	08/21/2015
Horn Antenna	SCHWARZBECK	BBHA 9170	1123	08/19/2014	08/18/2015
Power meter	Anritsu	ML2487A	6K00003613	08/23/2014	08/22/2015
Power sensor	Anritsu	MX248XD	--	08/19/2014	08/18/2015

§15.203 - ANTENNA REQUIREMENT

Standard Applicable

According to § 15.203, an intentional radiator shall be designed to ensure that no antenna other than that furnished by the responsible party shall be used with the device. The use of a permanently attached antenna or of an antenna that uses a unique coupling to the intentional radiator shall be considered sufficient to comply with the provisions of this section. The manufacturer may design the unit so that a broken antenna can be replaced by the user, but the user of a standard antenna jack or electrical connector is prohibited. The structure and application of the EUT were analyzed to determine compliance with section §15.203 of the rules. §15.203 state that the subject device must meet the following criteria:

- a. Antenna must be permanently attached to the unit.
- b. Antenna must use a unique type of connector to attach to the EUT.

Unit must be professionally installed, and installer shall be responsible for verifying that the correct antenna is employed with the unit.

And according to FCC 47 CFR section 15.247 (b), if the transmitting antennas of directional gain greater than 6dBi are used, the power shall be reduced by the amount in dB that the directional gain of the antenna exceeds 6 dBi.

Antenna Connector Construction

The EUT's antenna integrated on PCB, The antenna's gain is 1.55 dBi and meets the requirement.

§15.207 - CONDUCTED EMISSIONS

Applicable Standard

The specification used was with the FCC Part 15.207 limits.

Test Procedure

During the conducted emission test, the EUT was connected to the outlet of the LISN.

Maximizing procedure was performed on the six (6) highest emissions of the EUT.

All data was recorded in the Quasi-peak and average detection mode.

Test Result

PASS

Test Mode: Normal Operating

Test Conditions

Temperature:	26 °C
Relative Humidity:	60%
ATM Pressure:	100.0kPa
Voltage	120V/60Hz

Plot(s) of Test Data

Plot(s) of Test Data is presented hereinafter as reference.

Phase: Live

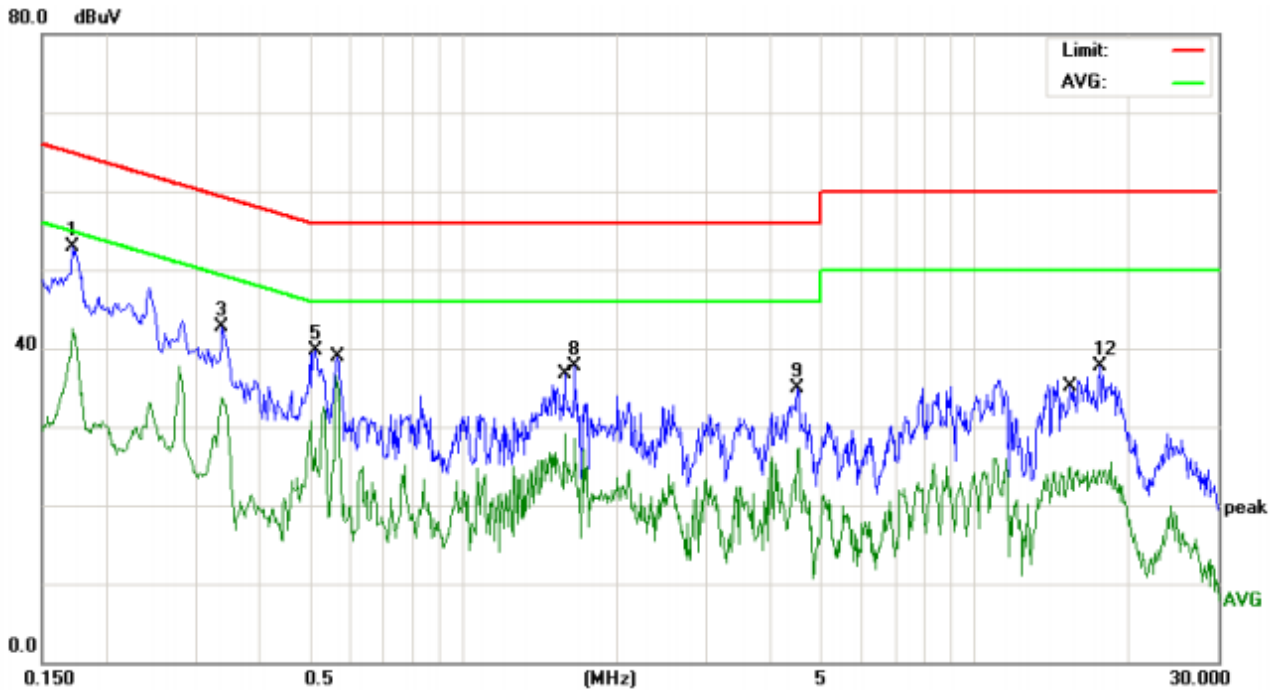

No.	Mk.	Freq. MHz	Reading Level dBuV	Correct Factor dB	Measure- ment dBuV	Limit dBuV	Over dB	Detector
1		0.1720	42.54	10.38	52.92	64.86	-11.94	peak
2		0.1720	32.15	10.38	42.53	54.86	-12.33	AVG
3		0.3379	32.19	10.59	42.78	59.25	-16.47	peak
4		0.3379	23.11	10.59	33.70	49.25	-15.55	AVG
5		0.5140	29.27	10.44	39.71	56.00	-16.29	peak
6	*	0.5660	25.94	10.60	36.54	46.00	-9.46	AVG
7		1.5780	18.54	10.59	29.13	46.00	-16.87	AVG
8		1.6540	27.19	10.59	37.78	56.00	-18.22	peak
9		4.5059	24.28	10.67	34.95	56.00	-21.05	peak
10		4.5419	16.64	10.68	27.32	46.00	-18.68	AVG
11		15.4579	14.46	10.39	24.85	50.00	-25.15	AVG
12		17.6097	27.23	10.38	37.61	60.00	-22.39	peak

Remark: All of the Tx modes have been investigated, and only worst mode is presented in this report.

Phase: Neutral

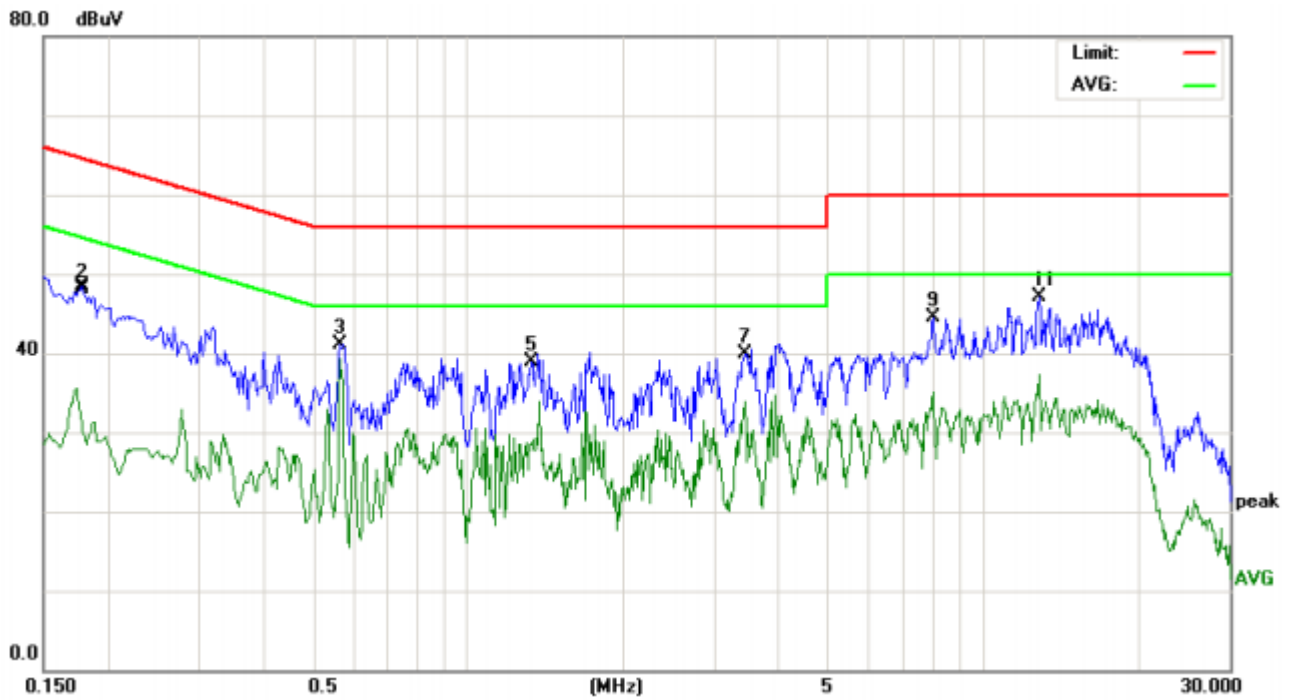

No.	Mk.	Freq. MHz	Reading Level dBuV	Correct Factor dB	Measure- ment dBuV	Limit dBuV	Over dB	Detector
1		0.1768	21.87	10.37	32.24	54.63	-22.39	AVG
2		0.1785	37.66	10.36	48.02	64.55	-16.53	peak
3		0.5660	30.46	10.60	41.06	56.00	-14.94	peak
4	*	0.5660	28.71	10.60	39.31	46.00	-6.69	AVG
5		1.3300	28.39	10.58	38.97	56.00	-17.03	peak
6		1.3340	18.46	10.58	29.04	46.00	-16.96	AVG
7		3.4380	29.28	10.64	39.92	56.00	-16.08	peak
8		3.4380	23.23	10.64	33.87	46.00	-12.13	AVG
9		8.0059	33.90	10.52	44.42	60.00	-15.58	peak
10		8.0059	24.65	10.52	35.17	50.00	-14.83	AVG
11		12.8258	36.76	10.39	47.15	60.00	-12.85	peak
12		12.8258	26.97	10.39	37.36	50.00	-12.64	AVG

Remark: All of the Tx modes have been investigated, and only worst mode is presented in this report.

§15.209, §15.205, §15.247(d) - SPURIOUS EMISSIONS

Test Equipment

Please refer to section 4 this report.

Test Procedure

The out of band emission tests were performed in the 3-meter chamber test site, using the setup accordance with the ANSI C63.4-2009. The specification used was the FCC Part Subpart C limits.

- a. The measuring distance of at 3 m shall be used for measurements at frequency up to 1GHz. For frequencies above 1GHz, any suitable measuring distance may be used.
- b. The EUT was placed on the top of a rotating table 0.8 meters above the ground at a 3 meter open area test site. The table was rotated 360 degrees to determine the position of the highest radiation.
- c. The height of the equipment or of the substitution antenna shall be 0.8 m; the height of the test antenna shall vary between 1 m to 4 m. Both horizontal and vertical polarizations of the antenna are set to make the measurement.
- d. The initial step in collecting conducted emission data is a spectrum analyzer peak detector mode pre-scanning the measurement frequency range. Significant peaks are then marked and then Quasi Peak detector mode re-measured.
- e. If the Peak Mode measured value compliance with and lower than Quasi Peak Mode Limit, the EUT shall be deemed to meet QP Limits and then no additional QP Mode measurement performed.
- f. For the actual test configuration, please refer to the related Item –EUT Test Photos.

Note:

Environmental Conditions

Temperature:	26 °C
Relative Humidity:	55%
ATM Pressure:	100.0kPa

Radiated Test Setup

The system was investigated from 9 KHz to 25 GHz.

During the radiated emission test, the EMI test receiver & Spectrum Analyzer Setup were set with the following configurations:

Frequency Range	RBW	Video B/W	Detector
9KHz-30MHz	9kHz	30 kHz	QP
30 MHz – 1000 MHz	100 kHz	300 kHz	QP
1000 MHz – 25 GHz	1 MHz	3 MHz	PK

1000 MHz – 25 GHz

1 MHz

10 Hz

Ave

(A) Radiated Emission Test-Up Frequency Below 30MHz

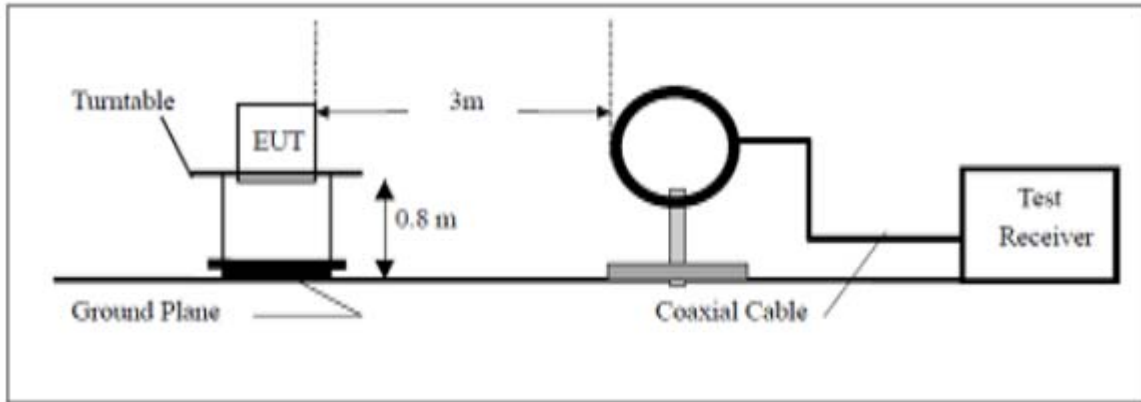

(B) Radiated Emission Test-Up Frequency 30MHz~1GHz

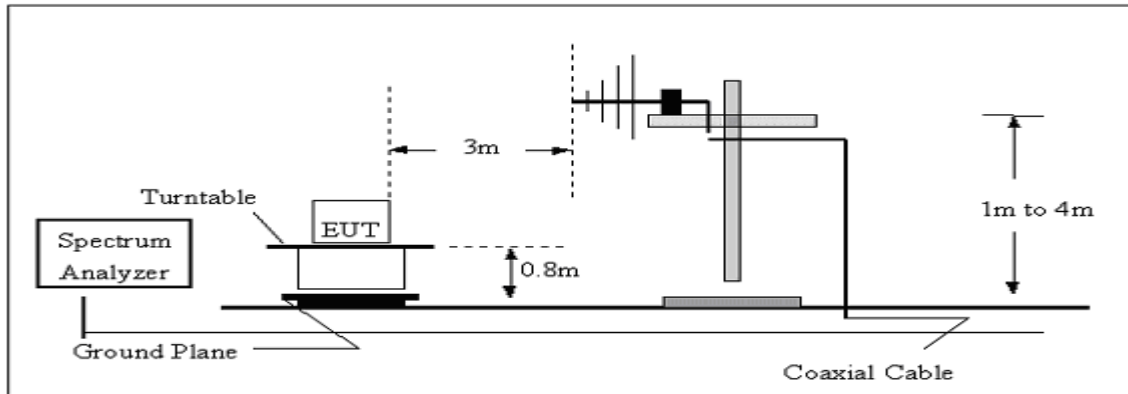

(C) Radiated Emission Test-Up Frequency Above 1GHz

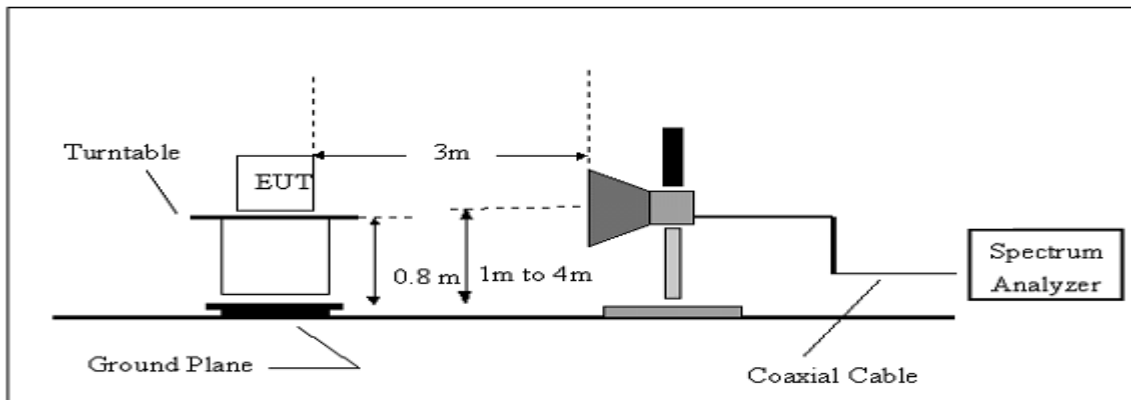

For the accrual test configuration, please refer to the related items-photos of Testing.

Radiated Emission Limit

Applicable Standard

FCC §15.247 (d); §15.209; §15.205;

Radiated Emission Test Result

Test Mode: Transmitting

Frequency (MHz)	Field strength (microvolts/meter)	Measurement distance (meters)
0.009–0.490	2400/F(kHz)	300
0.490–1.705	24000/F(kHz)	30
1.705–30.0	30	30
30–88	100**	3
88–216	150**	3
216–960	200**	3
Above 960	500	3

Note:

Both horizontal and vertical antenna polarities were tested and performed pretest to three orthogonal axis. The worst case emissions were reported

Test result:

From 9KHz to 30MHz

NOTE: 9KHz-30MHz the measurements were greater than 20dB below the limit

From 30MHz to 1GHz

Horizontal:

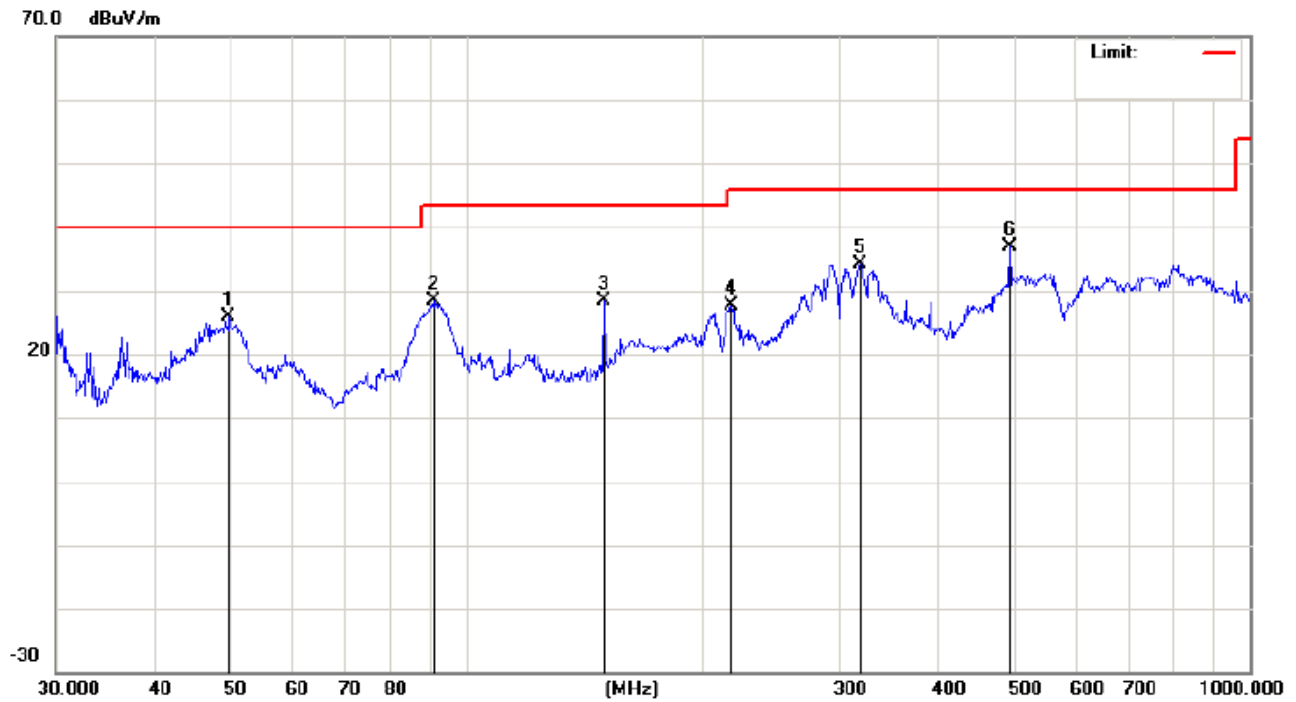

No.	Mk.	Freq. MHz	Reading Level dBuV	Correct Factor dB	Measure- ment dBuV/m	Limit dBuV/m	Over dB	Detector
1		49.8813	32.58	-6.72	25.86	40.00	-14.14	peak
2		91.1744	38.74	-10.27	28.47	43.50	-15.03	peak
3		150.0107	34.82	-6.45	28.37	43.50	-15.13	peak
4		218.3085	33.92	-6.30	27.62	46.00	-18.38	peak
5		318.8170	36.45	-2.43	34.02	46.00	-11.98	peak
6	*	494.1983	37.26	-0.34	36.92	46.00	-9.08	peak

Remark: All of the Tx modes have been investigated, and only worst mode is presented in this report.

Vertical:

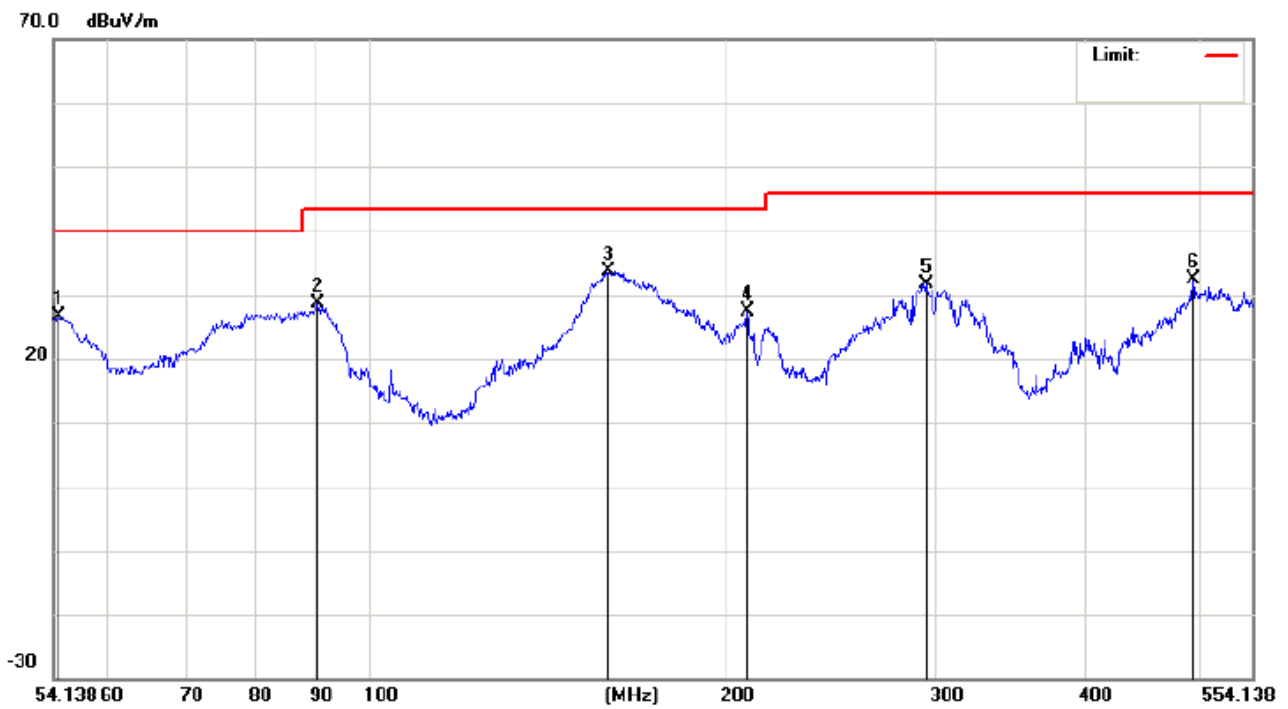

No.	Mk.	Freq. MHz	Reading Level dBuV	Correct Factor dB	Measure- ment dBuV/m	Limit dBuV/m	Over dB	Detector
1	*	30.3170	26.68	3.29	29.97	40.00	-10.03	peak
2		50.2324	33.83	-7.25	26.58	40.00	-13.42	peak
3		92.1388	38.04	-10.16	27.88	43.50	-15.62	peak
4		207.8498	35.42	-6.98	28.44	43.50	-15.06	peak
5		292.0581	35.32	-3.07	32.25	46.00	-13.75	peak
6		656.5298	24.31	5.49	29.80	46.00	-16.20	peak

Remark: All of the Tx modes have been investigated, and only worst mode is presented in this report.

From 1GHz to 25GHz:

Operation Mode:	Channel 0	Test Date :	January 24, 2015
Frequency Range:	Above 1GHz	Temperature :	28°C
Test Result:	PASS	Humidity :	65 %
Measured Distance:	3m	Test By:	Neil Wong

Freq. (MHz)	Ant.Pol.	Emission Level(dBuV)		Limit 3m(dBuV/m)		Over(dB)	
	H/V	PK	AV	PK	AV	PK	AV
4804.68	V	60.89	39.29	74	54	-13.11	-14.71
7206.91	V	59.19	39.80	74	54	-14.81	-14.20
9608.51	V	58.82	40.27	74	54	-15.18	-13.73
4804.68	H	58.40	39.40	74	54	-15.60	-14.60
7206.95	H	60.89	39.29	74	54	-13.11	-14.71

All emissions not reported were more than 20dB below the specified limit or in the noise floor.

- Note:** (1) All Readings are Peak Value and AV.
(2) Emission Level= Reading Level+ Probe Factor +Cable Loss.
(3) Data of measurement within this frequency range shown "--" in the table above means the reading of emissions are attenuated more than 20dB below the permissible limits or the field strength is too small to be measured.

Operation Mode: Channel 20 Test Date : January 24, 2015
 Frequency Range: Above 1GHz Temperature : 28°C
 Test Result: PASS Humidity : 65 %
 Measured Distance: 3m Test By: Neil Wong

Freq. (MHz)	Ant.Pol.	Emission Level(dBuV)		Limit 3m(dBuV/m)		Over(dB)	
	H/V	PK	AV	PK	AV	PK	AV
4884.61	V	58.98	41.86	74	54	-15.02	-12.14
7326.53	V	59.37	39.36	74	54	-14.63	-14.64
4884.87	H	59.56	39.26	74	54	-14.44	-14.74
7326.59	H	59.99	40.99	74	54	-14.01	-13.01
9768.27	H	58.98	41.86	74	54	-15.02	-12.14

All emissions not reported were more than 20dB below the specified limit or in the noise floor.

- Note:**
- (1) All Readings are Peak Value and AV.
 - (2) Emission Level= Reading Level+Probe Factor +Cable Loss.
 - (3) Data of measurement within this frequency range shown "--" in the table above means the reading of emissions are attenuated more than 20dB below the permissible limits or the field strength is too small to be measured.

Operation Mode: Channel 39 Test Date : January 24, 2015
 Frequency Range: Above 1GHz Temperature : 28°C
 Test Result: PASS Humidity : 65 %
 Measured Distance: 3m Test By: Neil Wong

Freq. (MHz)	Ant.Pol. H/V	Emission Level(dBuV)		Limit 3m(dBuV/m)		Over(dB)	
		PK	AV	PK	AV	PK	AV
4960.74	V	60.92	40.98	74	54	-13.08	-13.02
7440.96	V	58.92	39.08	74	54	-15.08	-14.92
9920.67	V	59.46	39.80	74	54	-14.54	-14.20
4960.59	H	58.38	39.38	74	54	-15.62	-14.62
7440.63	H	60.92	40.98	74	54	-13.08	-13.02

All emissions not reported were more than 20dB below the specified limit or in the noise floor.

- Note:**
- (1) All Readings are Peak Value and AV.
 - (2) Emission Level= Reading Level+Probe Factor +Cable Loss.
 - (3) Data of measurement within this frequency range shown "--" in the table above means the reading of emissions are attenuated more than 20dB below the permissible limits or the field strength is too small to be measured.

§15.247(a) (2) – 6dB BANDWIDTH TESTING

Test Equipment

Please refer to Section 4 this report.

Test Procedure

1. Set EUT in the transmitting mode.
2. Remove the antenna from the EUT and then connect a low loss RF cable from the antenna port to the spectrum analyzer.
3. Set the spectrum analyzer as RBW=100KHz, VBW \geq RBW, Span=3MHz, Sweep=auto.
4. Mark the peak frequency and -6dB(upper and lower)frequency.
5. Repeat until all the rest channels are investigated.

Note : The EUT was tested according to KDB 558074 for compliance to FCC 47CFR 15.247 requirements.

Environmental Conditions

Temperature:	26 °C
Relative Humidity:	55%
ATM Pressure:	100.0kPa

Applicable Standard

Systems using digital modulation techniques may operate in the 902–928 MHz, 2400–2483.5 MHz, and 5725–5850 MHz bands. The minimum 6 dB bandwidth shall be at least 500 kHz.

Test Result: Pass.

Please refer to the following tables

Channel Frequency (MHz)	Data Rate (Mbps)	6dB Bandwidth (kHz)	Limit (kHz)	Ref. Plot
2402	1	711.54	>500	PLOT 1
2440	1	701.92	>500	PLOT 2
2480	1	697.12	>500	PLOT 3

Low Channel

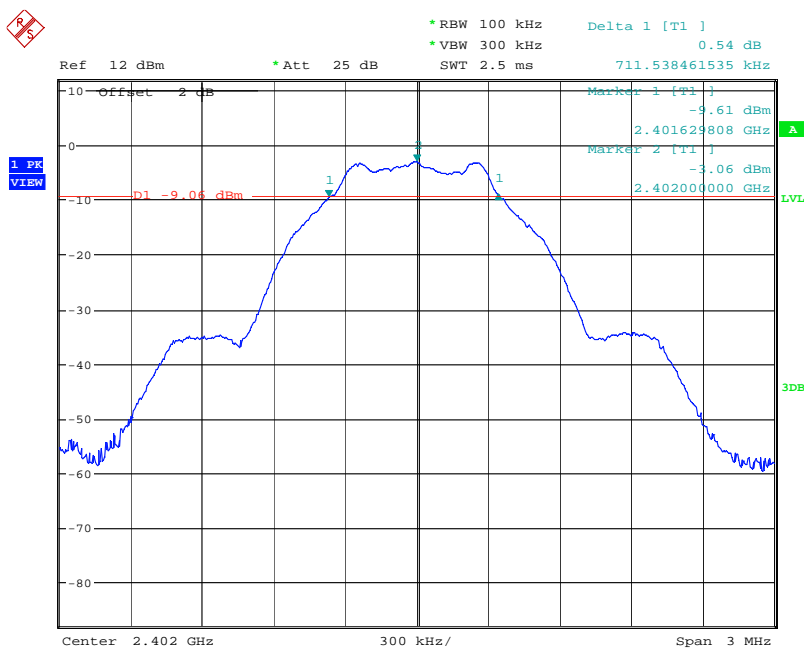

Middle channel

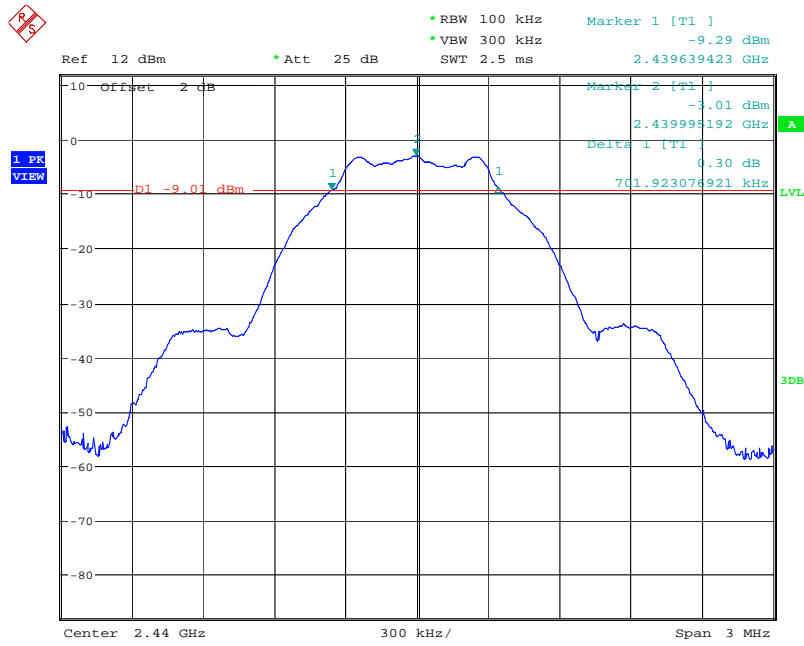

High Channel

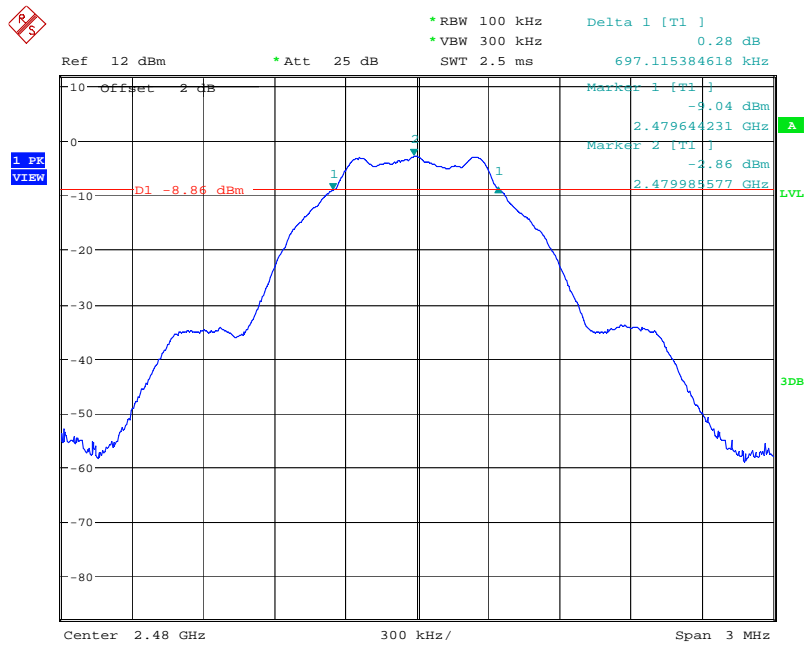

§15.247(b) (3) - MAXIMUM PEAK OUTPUT POWER

Test Equipment

Please refer to Section 4 this report.

Test Procedure

1. The EUT was directly connected to the spectrum analyzer and antenna output port as show in the block diagram below,
2. Set the EUT Work on the top, the middle and the bottom operation frequency individually.
3. Set the RBW =1MHz, VBW \cong 3RBW, span \cong 1.5*6dbbandwith.
Sweep time = auto couple, Detector = peak, Trace mode = max hold.
4. Record the maximum power from the spectrum analyzer.
5. The maximum peak power shall be less 1 Watt (30dBm).

Note : The EUT was tested according to KDB 558074 for compliance to FCC 47CFR 15.247 requirements.

Environmental Conditions

Temperature:	26 °C
Relative Humidity:	55%
ATM Pressure:	100.0kPa

Applicable Standard

According to §15.247(b) (3), for systems using digital modulation in the 902–928 MHz, 2400–2483.5 MHz, and 5725–5850 MHz bands: 1 Watt. As an alternative to a peak power measurement, compliance with the one Watt limit can be based on a measurement of the maximum conducted output power. Maximum Conducted Output Power is defined as the total transmit power delivered to all antennas and antenna elements averaged across all symbols in the signaling alphabet when the transmitter is operating at its maximum power control level. Power must be summed across all antennas and antenna elements. The average must not include any time intervals during which the transmitter is off or is transmitting at a reduced power level. If multiple modes of operation are possible (e.g., alternative modulation methods), the maximum conducted output power is the highest total transmit power occurring in any mode.

Test Result

Channel	Frequency (MHz)	Data Rate (Mbps)	Conducted Power (dBm)	Limit (dBm)
Low	2402	1	-2.04	30
Middle	2440	1	-1.93	30
High	2480	1	-1.71	30

Low channel

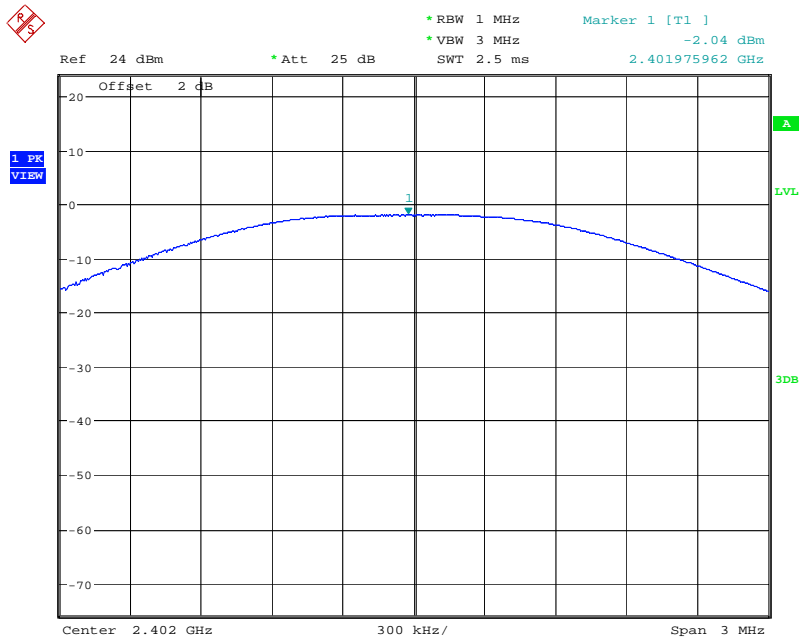

Middle channel

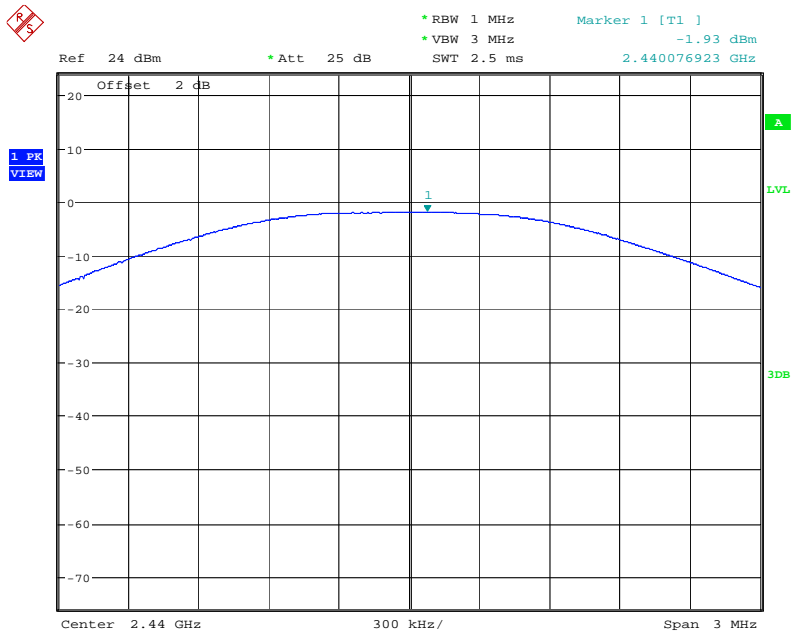

High channel

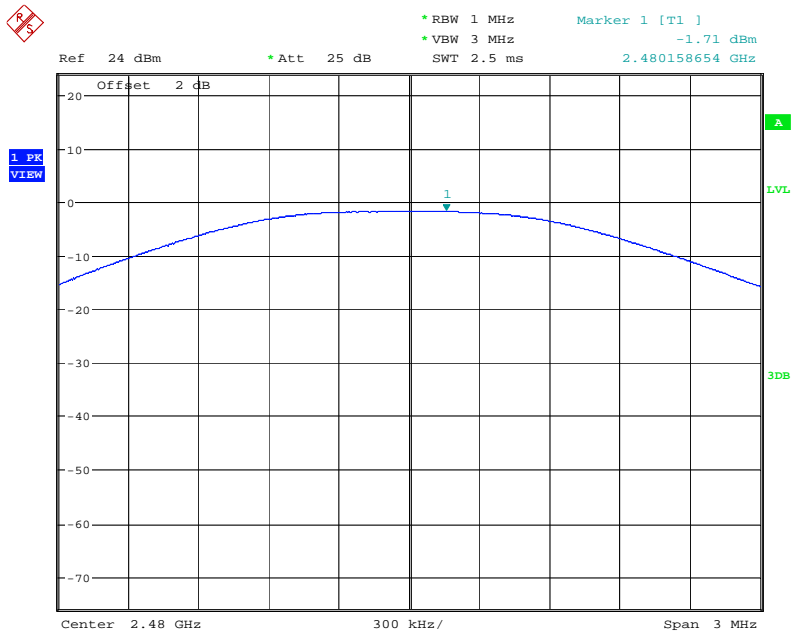

§15.247(d) – 100 kHz BANDWIDTH OF FREQUENCY BAND EDGE

Test Equipment

Please refer to Section 4 this report.

Test Procedure

The out of band emission tests were performed in the 3-meter chamber test site, using the setup accordance with the ANSI C63.4-2009. The specification used was the FCC Part Subpart C limits.

Environmental Conditions

Temperature:	26 °C
Relative Humidity:	55%
ATM Pressure:	100.0kPa

Applicable Standard

In any 100 kHz bandwidth outside the frequency band in which the spread spectrum or digitally modulated intentional radiator is operating, the radio frequency power that is produced by the intentional radiator shall be at least 20 dB below that in the 100 kHz bandwidth within the band that contains the highest level of the desired power, based on either an RF conducted or a radiated measurement, provided the transmitter demonstrates compliance with the peak conducted power limits. If the transmitter complies with the conducted power limits based on the use of RMS averaging over a time interval, as permitted under paragraph (b)(3) of this section, the attenuation required under this paragraph shall be 30 dB instead of 20 dB. Attenuation below the general limits specified in §15.209(a) is not required. In addition, radiated emissions which fall in the restricted bands, as defined in §15.205(a), must also comply with the radiated emission limits specified in §15.209(a) (see §15.205(c)).

Test Result

PASS

Radiated measurement:

Indicated		result (PK/AV)	Table Angle Degree	Antenna		Correction Factor			FCC Part 15.247		
Frequency (MHz)	Receiver Reading (dB μ V/m)			Height (m)	Polar (H/V)	Ant. Factor (dB/m)	Cable Loss (dB)	Pre-Amp. Gain (dB)	Cord. Amp. (dB μ V/m)	Limit (dB μ V/m)	Margin (dB)
Low Channel (2402MHz)											
2390	40.01	AV	90	2	V	30.3	4.1	33.1	41.31	54	12.69
2390	40.94	AV	237	1.5	H	30.3	4.1	33.1	42.24	54	11.76
2390	62.45	PK	60	1.5	V	30.3	4.1	33.1	63.75	74	10.25
2390	60.84	PK	156	2	H	30.3	4.1	33.1	62.14	74	11.86
High Channel (2480MHz)											
2483.5	41.05	AV	277	2	V	31	4.4	32.7	43.75	54	10.25
2483.5	40.85	AV	180	1.5	H	31	4.4	32.7	43.55	54	10.45
2483.5	62.98	PK	320	1	V	31	4.4	32.7	65.68	74	8.32
2483.5	60.40	PK	280	2	H	31	4.4	32.7	63.10	74	10.90

§15.247(e) -MAXIMUM CONDUCTED POWER SPECTRAL DENSITY

Test Equipment

Please refer to Section 4 this report.

Test Procedure

- 1, This procedure shall be used if maximum peak conducted output power was used to demonstrate compliance, and is optional if the maximum conducted (average) output power was used to demonstrate compliance.
- 2, Set analyzer center frequency to DTS channel center frequency.
- 3, Set the RBW to:3 kHz \cong RBW \cong 100 kHz, Set the VBW \cong 3 RBW, Detector = peak. Sweep time = auto couple
- 4, Trace mode = max hold, Allow trace to fully stabilize.

Note : The EUT was tested according to KDB 558074 for compliance to FCC 47CFR 15.247 requirements.

Environmental Conditions

Temperature:	25 °C
Relative Humidity:	55%
ATM Pressure:	100.0kPa

Applicable Standard

For digitally modulated systems, the power spectral density conducted from the intentional radiator to the antenna shall not be greater than 8 dBm in any 3 kHz band during any time interval of continuous transmission. This power spectral density shall be determined in accordance with the provisions of paragraph (b) of this section. The same method of determining the conducted output power shall be used to determine the power spectral density.

Test Result

PASS

Channel Frequency (MHz)	Data Rate (Mbps)	PSD (dBm/3kHz)	Limit (dBm/3kHz)	RESULT
2402	1	-17.72	8	Compliant
2440	1	-17.77	8	Compliant
2480	1	-17.50	8	Compliant

Low Channel

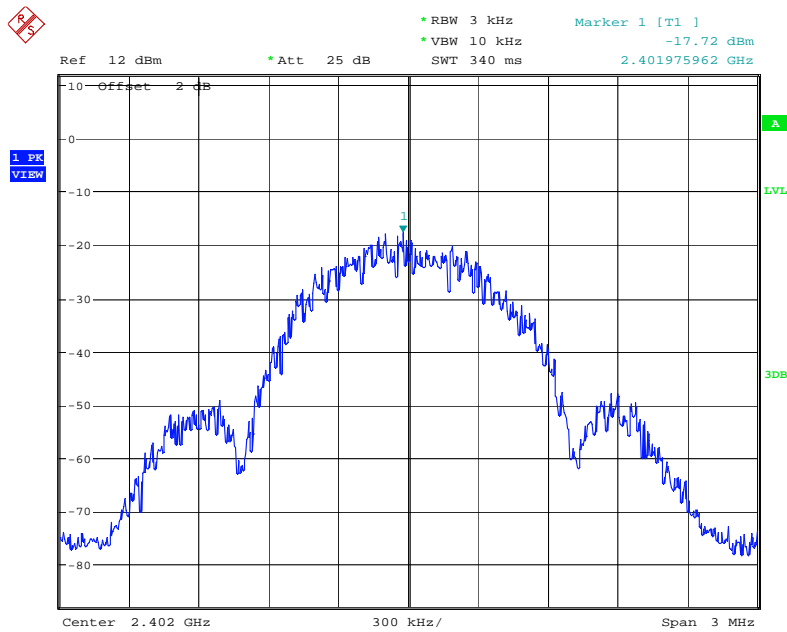

Middle Channel

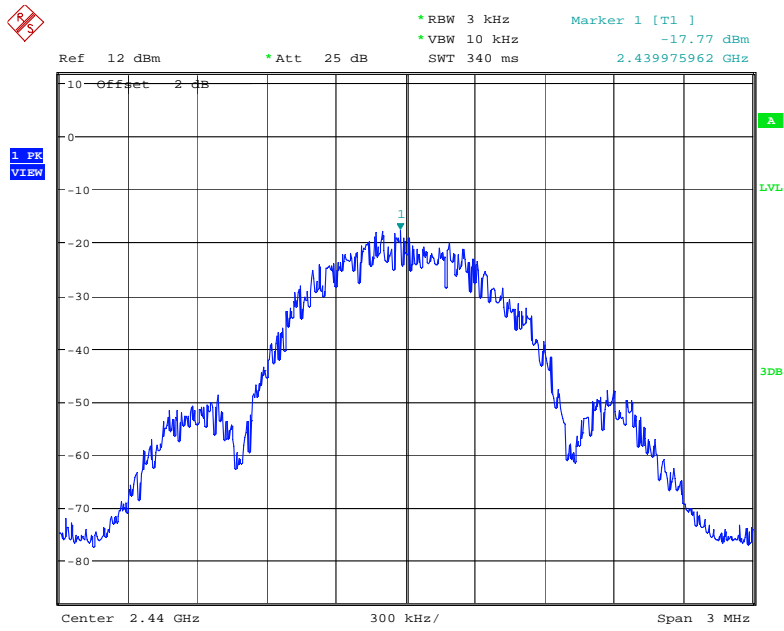

High Channel

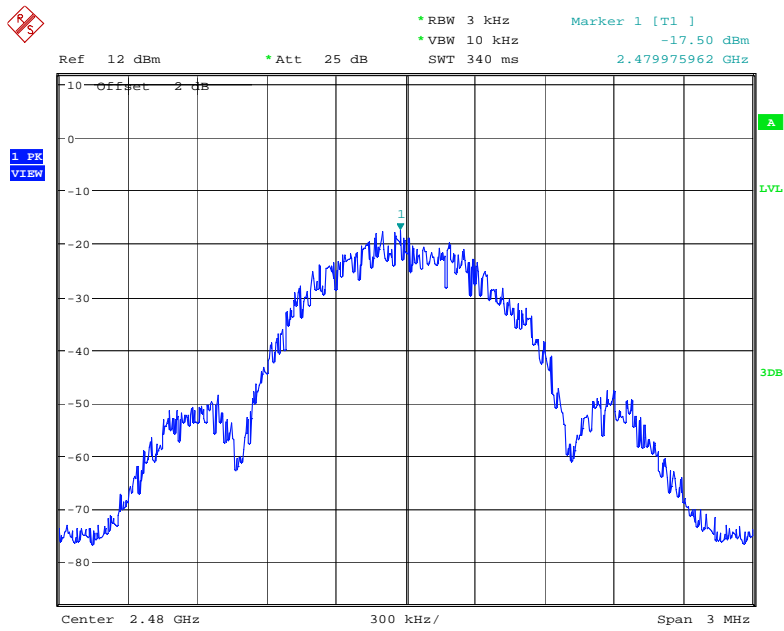

PHOTOGRAPHS OF THE TEST CONFIGURATION

CONDUCTED EMISSION TEST



RADIATED EMISSION TEST

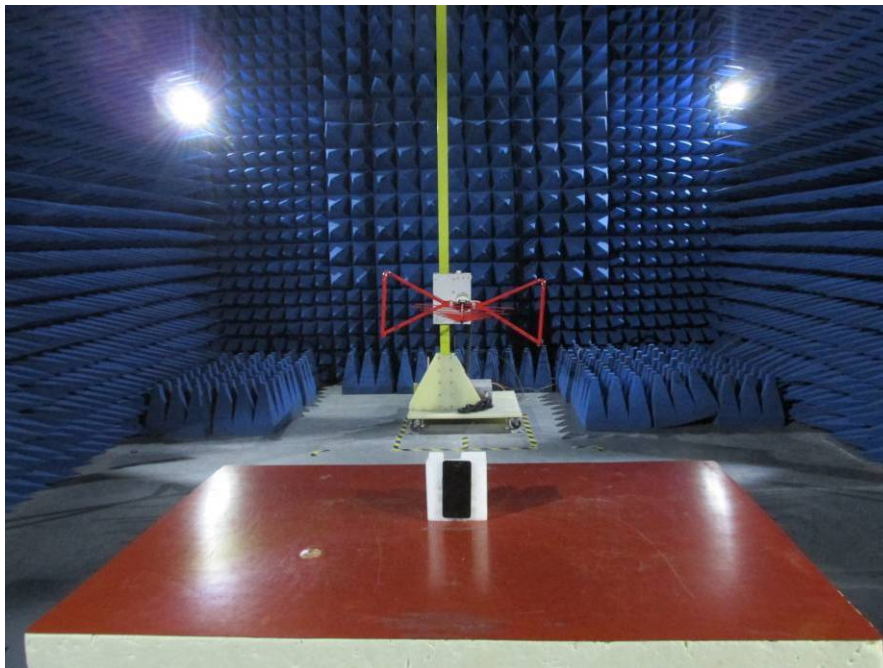

RADIATED EMISSION TEST

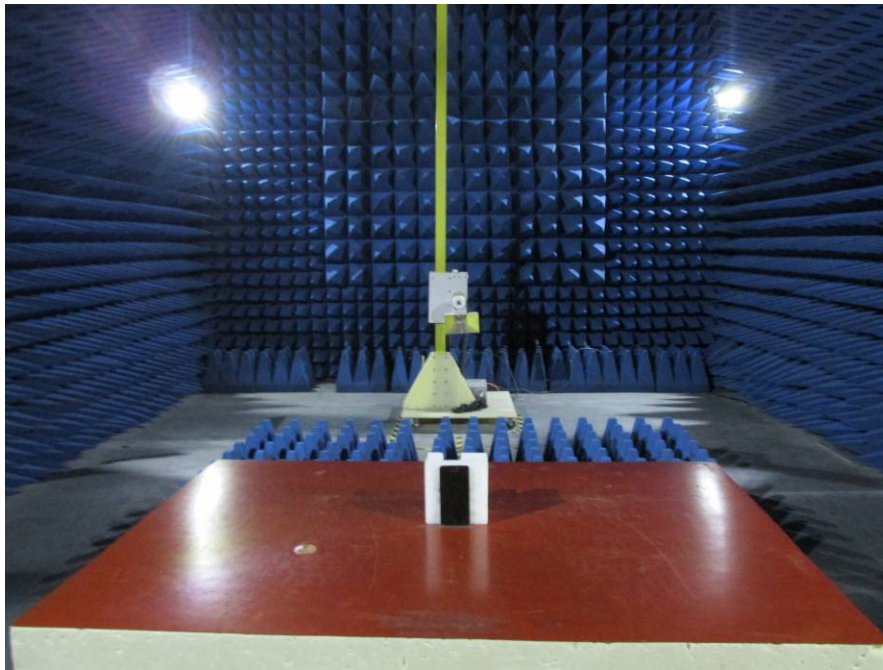

PHOTOGRAPHS OF EUT

Appearance photograph of EUT



Appearance photograph of EUT

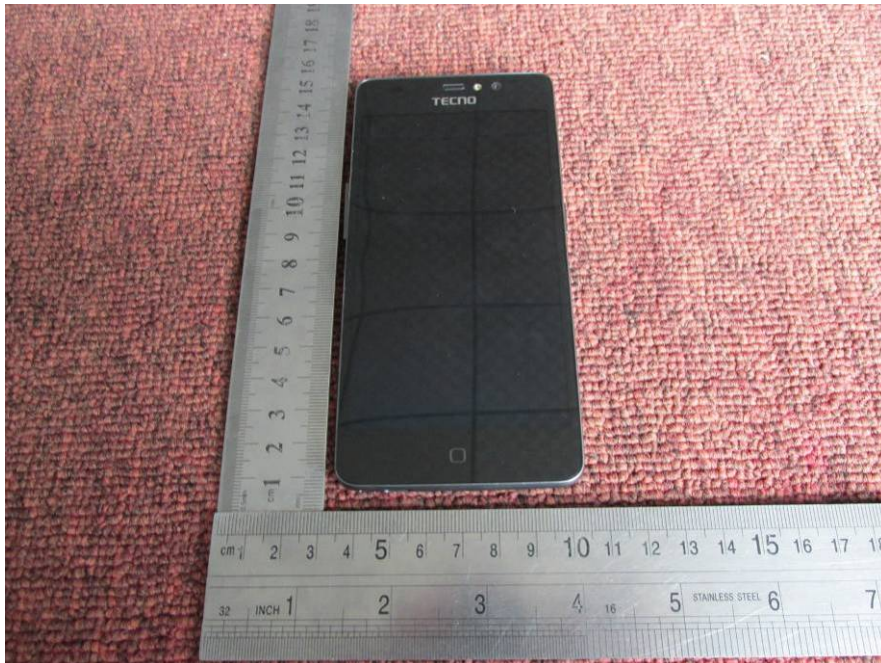

Appearance photograph of EUT



Appearance photograph of EUT



Appearance photograph of EUT

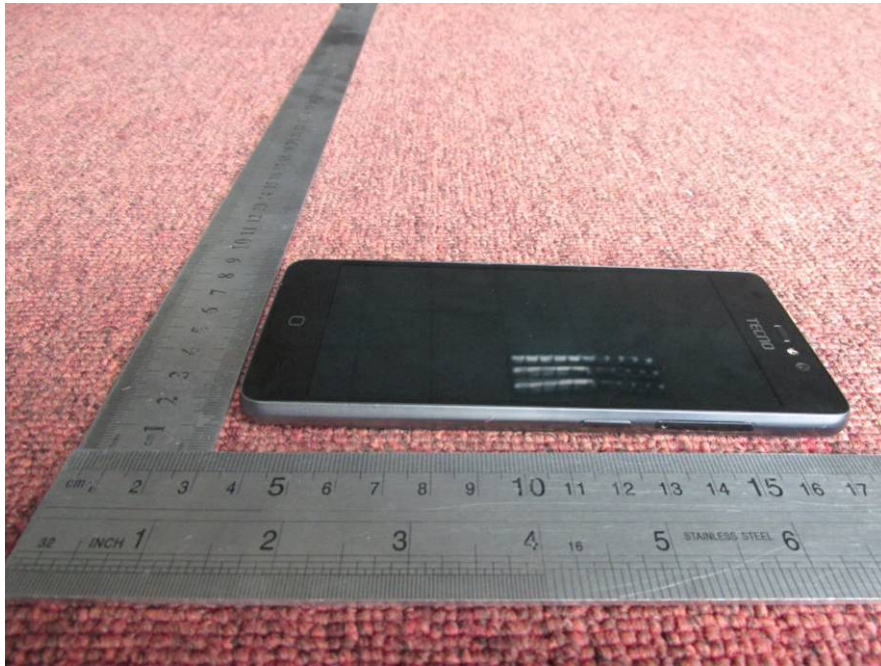

Appearance photograph of EUT



Appearance photograph of EUT



Appearance photograph of EUT



Appearance photograph of EUT



Internal photograph of EUT

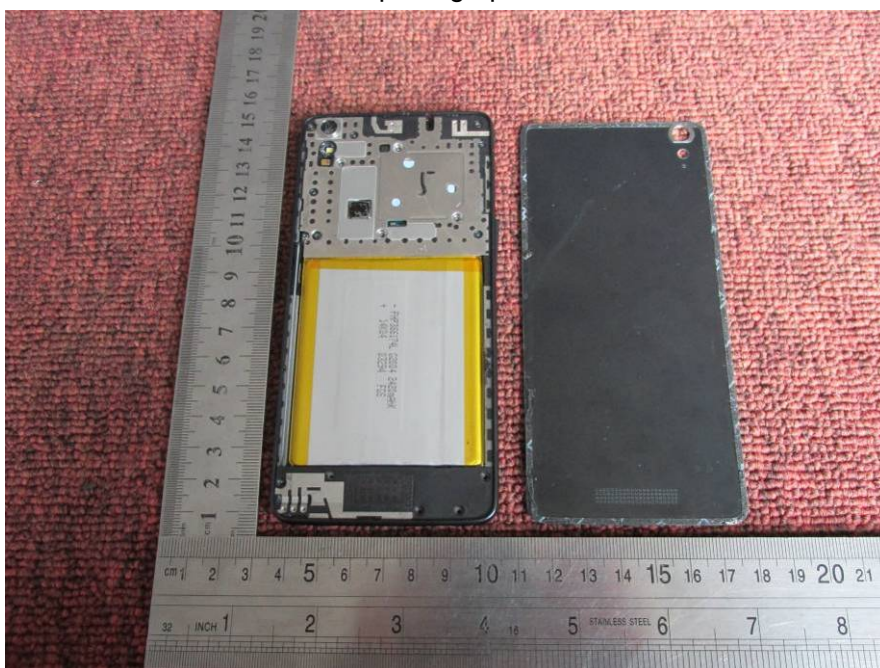

Internal photograph of EUT

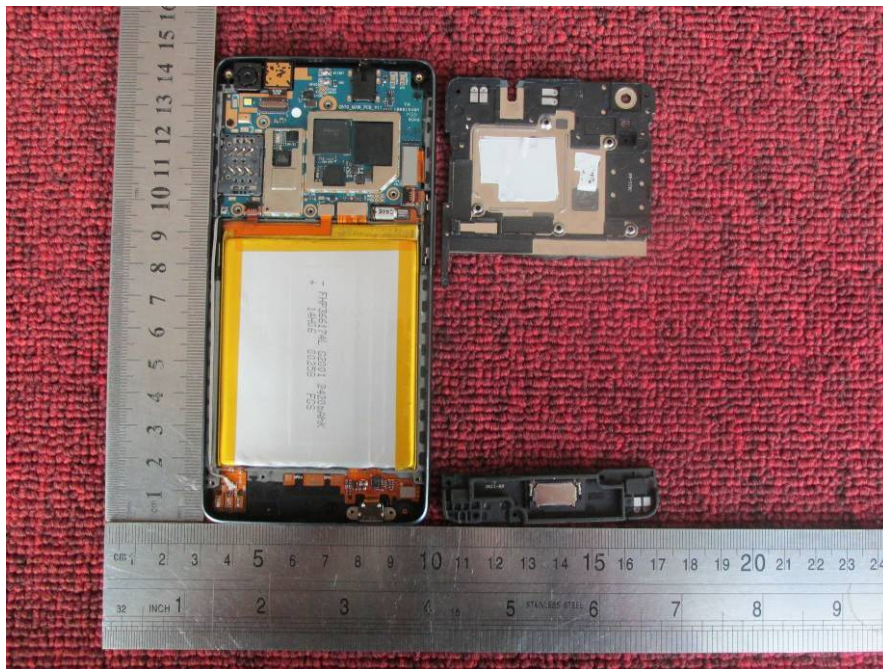

Internal photograph of EUT

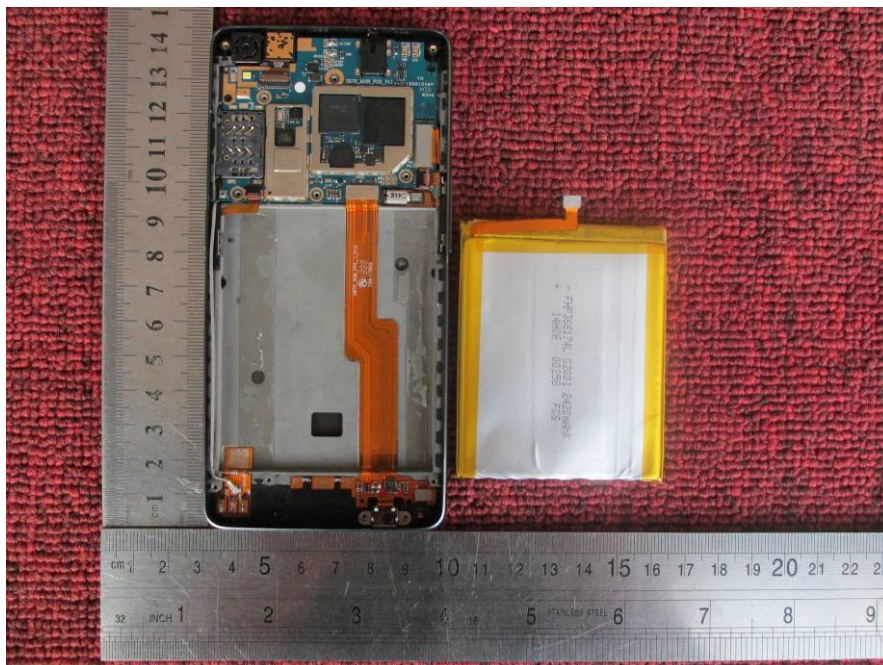

Internal photograph of EUT



Internal photograph of EUT



Internal photograph of EUT

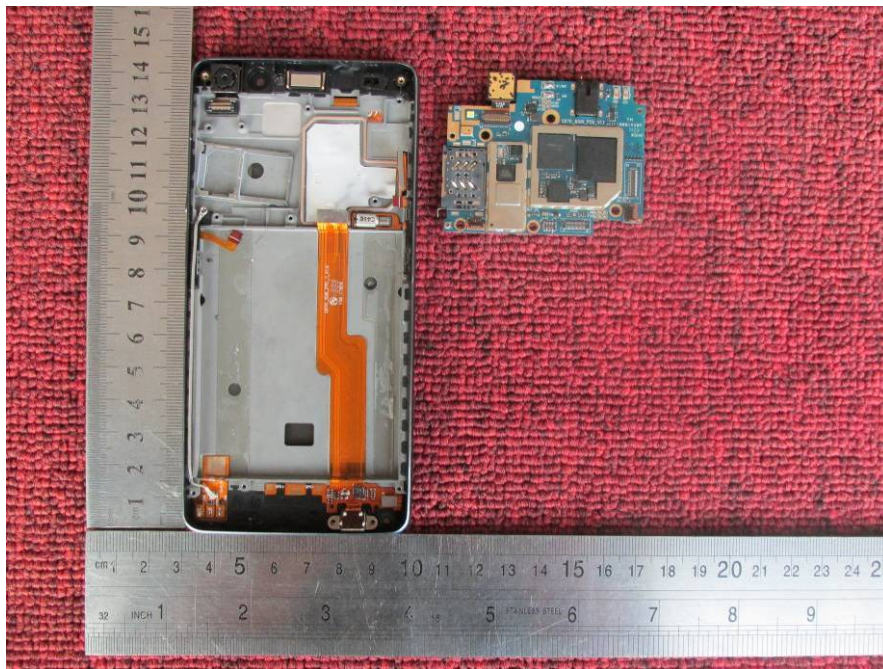

Internal photograph of EUT

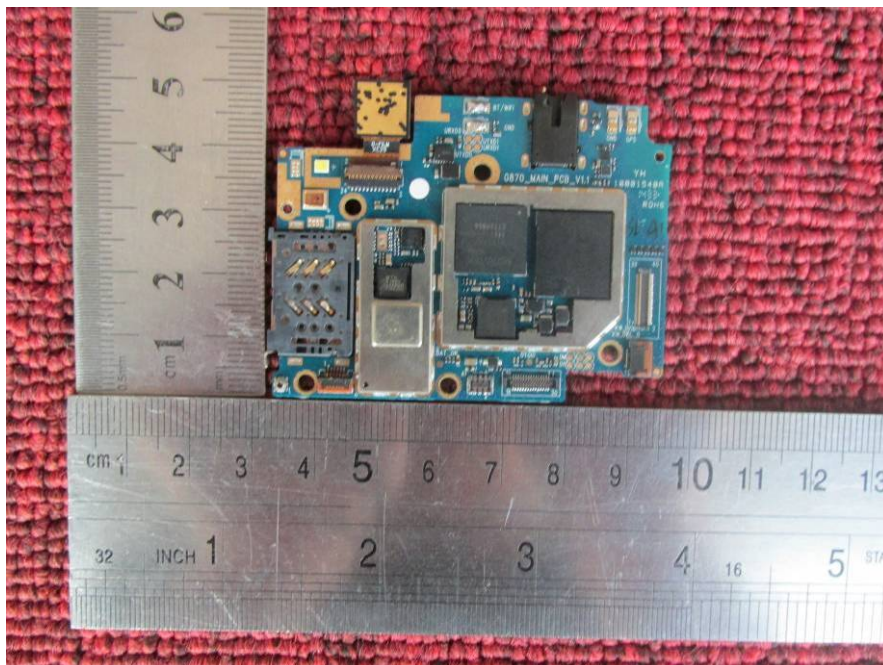

Internal photograph of EUT

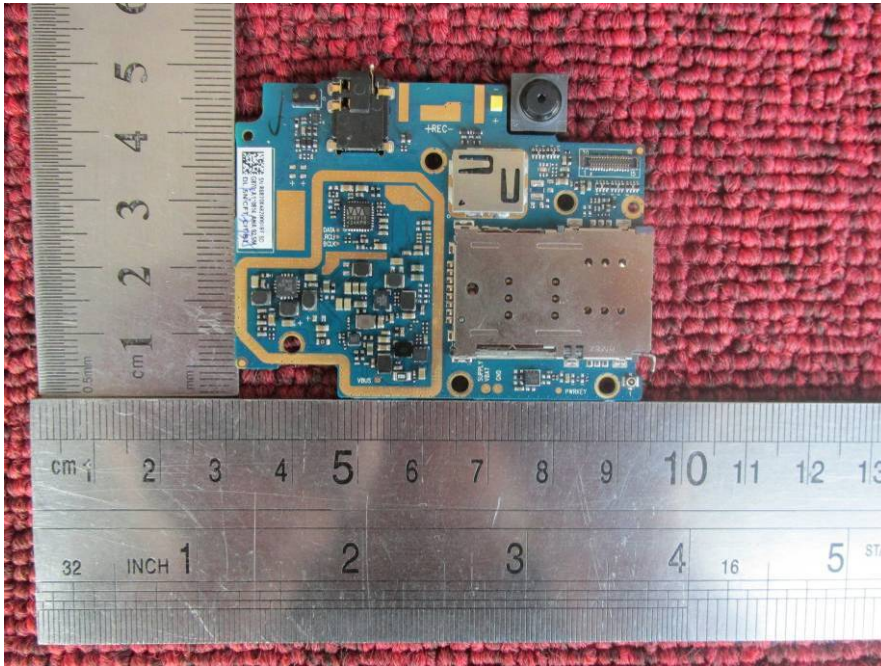

Internal photograph of EUT

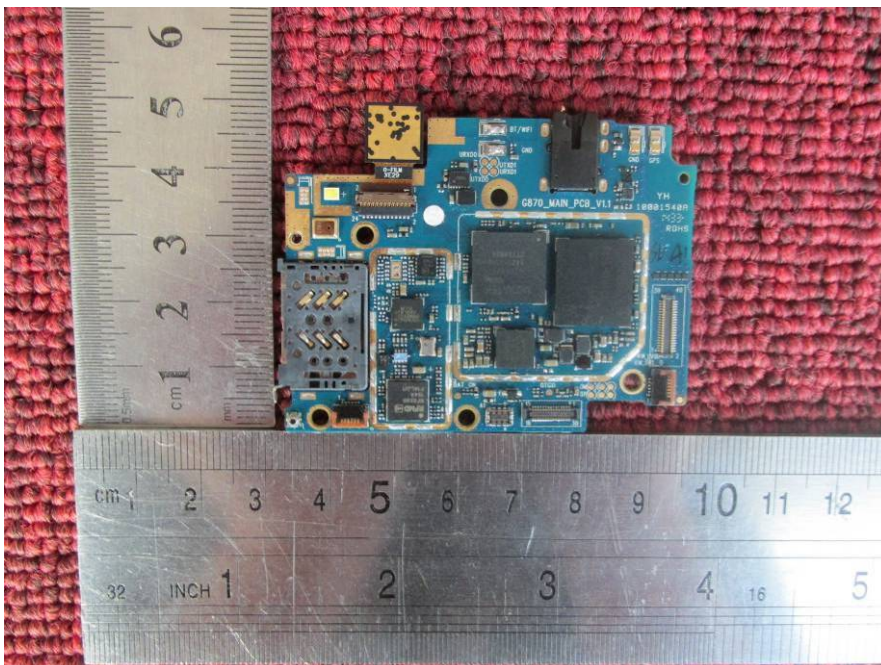

—END OF REPORT—