



FCC Report

Application Purpose : Original grant
Applicant Name: : TECNO MOBILE LIMITED
FCC ID : 2ADYY-N2
Equipment Type : Mobile phone
Model Name : N2
Report Number : FCC16073807-5
Standard(S) : FCC Part 15 Subpart B
Date Of Receipt : July 14, 2016
Date Of Issue : August 03, 2016

Test By : 

(Daisy Qin)

Reviewed By : 

(Sol Qin)

Authorized by : 

(Michal Ling)

Prepared by : **QTC Certification & Testing Co., Ltd.**
2nd Floor, BI Building, Fengyeyuan Industrial Plant,, Liuxian
2st. Road, Xin'an Street, Bao'an District,, Shenzhen, 518000
Registration Number: 588523

REPORT REVISE RECORD

Report Version	Revise Time	Issued Date	Valid Version	Notes
V1.0	/	August 03, 2016	Valid	Original Report
V1.1	August 23, 2016	August 03, 2016	Valid	Original Report

Table of Contents	Page
1. GENERAL INFORMATION	4
2. TEST DESCRIPTION	6
2.1 MEASUREMENT UNCERTAINTY	6
2.2 DESCRIPTION OF TEST MODES	7
2.3 CONFIGURATION OF SYSTEM UNDER TEST	8
2.4 DESCRIPTION OF SUPPORT UNITS (CONDUCTED MODE)	8
3. SUMMARY OF TEST RESULTS	10
4. MEASUREMENT INSTRUMENTS	11
5. EMC EMISSION TEST	12
5.1 CONDUCTED EMISSION MEASUREMENT	12
5.1.1 POWER LINE CONDUCTED EMISSION LIMITS	12
5.1.2 TEST PROCEDURE	13
5.1.3 DEVIATION FROM TEST STANDARD	13
5.1.4 TEST SETUP	13
5.1.5 EUT OPERATING CONDITIONS	13
5.1.6 TEST RESULTS	14
5.2 RADIATED EMISSION MEASUREMENT	20
5.2.1 RADIATED EMISSION LIMITS	20
5.2.2 TEST PROCEDURE	21
5.2.3 DEVIATION FROM TEST STANDARD	21
5.2.4 TEST SETUP	22
5.2.5 EUT OPERATING CONDITIONS	22
5.2.5.1 TEST RESULTS (BETWEEN 30M – 1000 MHZ)	23
5.2.5.2 TEST RESULTS(1GHZ TO 6GHZ)	29
12. EUT TEST PHOTO	32
13. PHOTOGRAPHS OF EUT	34

1. GENERAL INFORMATION

Test Model	N2
Applicant	TECNO MOBILE LIMITED
Address	ROOMS 05-15, 13A/F., SOUTH TOWER,WORLD FINANCE CENTRE, HARBOUR CITY, 17 CANTON ROAD, TSIM SHA TSUI, KOWLOON, HONG KONG
Manufacturer	SHENZHEN TECNO TECHNOLOGY CO.,LTD.
Address	1-4th Floor,3rd Building,Pacific Industrial Park,No.2088,Shenyan Road,Yantian District,Shenzhen,Guangdong,China
Equipment Type	Mobile phone
Brand Name	TECNO
Hardware	D2030-TECNO-M-CO-E1-V0.1.2-S0712
Software	V1.1
Battery information:	Li-ion Battery : BL-F32040A Voltage: 3.8V Capacity: 1800mAh Limited Charge Voltage: 4.35V
Adapter Information:	Adapter: A31-500500 Input: AC 100-240V 50/60Hz 0.2A Output: DC 5V 500mA
Data of receipt	July 14, 2016
Date of test	July 14, 2016 to July 24, 2016
Deviation	None
Condition of Test Sample	Normal

We hereby certify that:

All measurement facilities used to collect the measurement data are located at
2nd Floor,BI Building,Fengyeyuan Industrial Plant., Liuxian 2st. Road, Xin'an Street, Bao'an
District.,Shenzhen,518000

The data evaluation, test procedures, and equipment configurations shown in this report were made in
accordance with the procedures given in ANSI C 63.4:2014. The sample tested as described in this report
is in compliance with the FCC Rules Part15 Subpart B.

The test results of this report relate only to the tested sample identified in this report.

2. TEST DESCRIPTION

2.1 MEASUREMENT UNCERTAINTY

The reported uncertainty of measurement $y \pm U$, where expanded uncertainty U is based on a standard uncertainty multiplied by a coverage factor of $k=2$, providing a level of confidence of approximately **95** %.

No.	Item	Uncertainty
1	Conducted Emission Test	$\pm 3.2\text{dB}$
2	RF power, conducted	$\pm 0.16\text{dB}$
3	Spurious emissions, conducted	$\pm 0.21\text{dB}$
4	All emissions, radiated(<1G)	$\pm 4.7\text{dB}$
5	All emissions, radiated(>1G)	$\pm 4.7\text{dB}$
6	Temperature	$\pm 0.5^\circ\text{C}$
7	Humidity	$\pm 2\%$

2.2 DESCRIPTION OF TEST MODES

To investigate the maximum EMI emission characteristics generates from EUT, the test system was pre-scanning tested base on the consideration of following EUT operation mode or test configuration mode which possible have effect on EMI emission level. Each of these EUT operation mode(s) or test configuration mode(s) mentioned above was evaluated respectively.

Pretest Mode	Description
Mode 1	Video Recording
Model 2	Video Playing
Mode 3	Exchange data with computer

For Conducted Emission	
Final Test Mode	Test with Keyboard and Mouse
Mode 1	Video Recording
Model 2	Video Playing
Mode 3	Exchange data with computer

For Radiated Emission	
Final Test Mode	Test with Keyboard and Mouse
Mode 1	Video Recording
Model 2	Video Playing
Mode 3	Exchange data with computer

2.3 CONFIGURATION OF SYSTEM UNDER TEST

Mode 1&2:

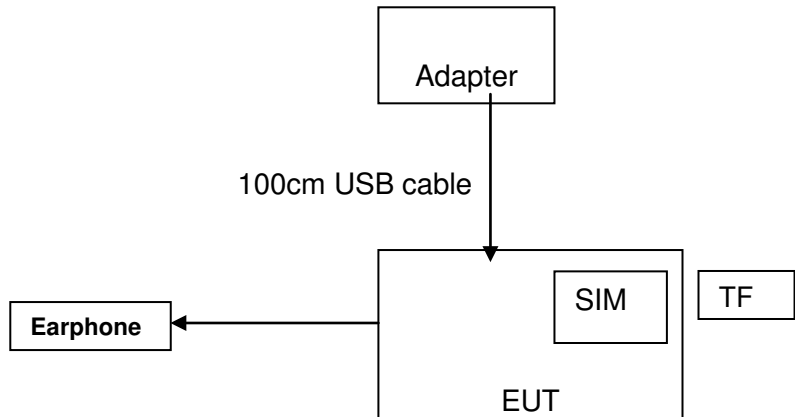

(EUT: Mobile phone)

Mode 3:

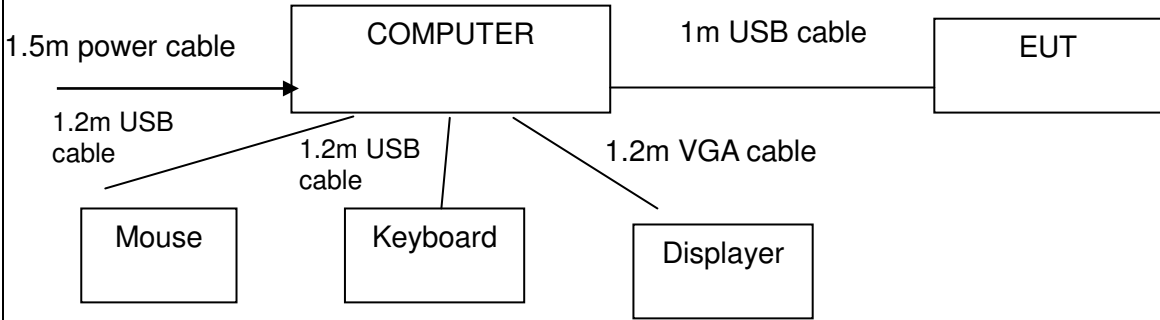

(EUT: Mobile phone)

I/O Port of EUT			
I/O Port Type	Q'TY	Cable	Tested with
Power	1	1m USB cable, unshielded	1
Earphone	1	1m USB cable, unshielded	1

2.4 DESCRIPTION OF SUPPORT UNITS (CONDUCTED MODE)

The EUT has been tested as an independent unit together with other necessary accessories or support units. The following support units or accessories were used to form a representative test configuration during the tests.

Item	Equipment	Mfr/Brand	Model/Type No.	Series No.	Note
1	Adapater	/	XY-AP120200	/	/
2	Keyboard	HP	SK-2880	435302-AA-	/
3	Mouse	DELL	MS111-1	/	/

Note:

- (1) The support equipment was authorized by Declaration of Confirmation.
- (2) For detachable type I/O cable should be specified the length in cm in 『Length』 column.

3. SUMMARY OF TEST RESULTS

Test procedures according to the technical standards:

FCC Part15 , Subpart B			
Standard Section	Test Item	Judgment	Remark
15.107	CONDUCTED EMISSION	PASS	
15.109	RADIATED EMISSION	PASS	

NOTE:

(1) "N/A" denotes test is not applicable in this test report.

4. MEASUREMENT INSTRUMENTS

Kind of Equipment	Manufacturer	Type No.	Serial No.	Last Calibrated	Calibrated until
ESCI Test Receiver	R&S	ESCI	100005	08/19/2015	08/18/2016
LISN	AFJ	LS16	16010222119	08/19/2015	08/18/2016
LISN(EUT)	Mestec	AN3016	04/10040	08/19/2015	08/18/2016
pre-amplifier	CDSI	PAP-1G18-38	--	08/19/2015	08/18/2016
System Controller	CT	SC100	-	08/19/2015	08/18/2016
Bi-log Antenna	Chase	CBL6111C	2576	08/19/2015	08/18/2016
Spectrum analyzer	R&S	FSU26	200409	08/19/2015	08/18/2016
Horn Antenna	SCHWARZBECK	9120D	1141	08/19/2015	08/18/2016
Bi-log Antenna	SCHWABEBECK	VULB9163	9163/340	08/19/2015	08/18/2016
Pre Amplifier	H.P.	HP8447E	2945A02715	10/13/2015	10/12/2016
9*6*6 Anechoic	--	--	--	08/21/2015	08/20/2016

5. EMC EMISSION TEST

5.1 CONDUCTED EMISSION MEASUREMENT

5.1.1 POWER LINE CONDUCTED EMISSION Limits (Frequency Range 150KHz-30MHz)

FREQUENCY (MHz)	Class A (dBuV)		Class B (dBuV)		Standard
	Quasi-peak	Average	Quasi-peak	Average	
0.15 -0.5	79.00	66.00	66 - 56 *	56 - 46 *	FCC
0.50 -5.0	73.00	60.00	56.00	46.00	FCC
5.0 -30.0	73.00	60.00	60.00	50.00	FCC

Note:

- (1) The tighter limit applies at the band edges.
- (2) The limit of " * " marked band means the limitation decreases linearly with the logarithm of the frequency in the range.

The following table is the setting of the receiver

Receiver Parameters	Setting
Attenuation	10 dB
Start Frequency	0.15 MHz
Stop Frequency	30 MHz
IF Bandwidth	9 kHz

5.1.2 TEST PROCEDURE

- The EUT was placed 0.4 meters from the horizontal ground plane with EUT being connected to the power mains through a line impedance stabilization network (LISN). All other support equipments powered from additional LISN(s). The LISN provide 50 Ohm/ 50uH of coupling impedance for the measuring instrument.
- Interconnecting cables that hang closer than 40 cm to the ground plane shall be folded back and forth in the center forming a bundle 30 to 40 cm long.
- I/O cables that are not connected to a peripheral shall be bundled in the center. The end of the cable may be terminated, if required, using the correct terminating impedance. The overall length shall not exceed 1 m.
- LISN at least 80 cm from nearest part of EUT chassis.
- For the actual test configuration, please refer to the related Item –EUT Test Photos.

5.1.3 DEVIATION FROM TEST STANDARD

No deviation

5.1.4 TEST SETUP

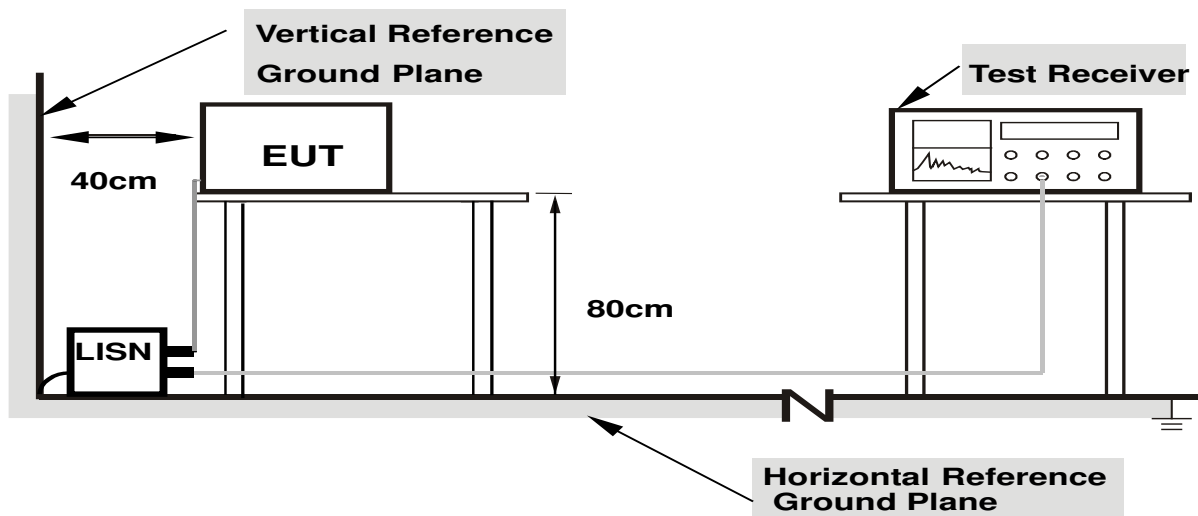

- Note: 1.Support units were connected to second LISN.
2.Both of LISNs (AMN) are 80 cm from EUT and at least 80 from other units and other metal planes**

5.1.5 EUT OPERATING CONDITIONS

The EUT was configured for testing in a typical fashion (as a customer would normally use it). The EUT has been programmed to continuously transmit during test. This operating condition was tested and used to collect the included data.

5.1.6 TEST RESULTS

EUT	Mobile phone	Model Name	N2
Temperature	26 °C	Relative Humidity	54%
Pressure	1010hPa	Phase	L
Test Date	July 15, 2016	Test Mode	Mode 1

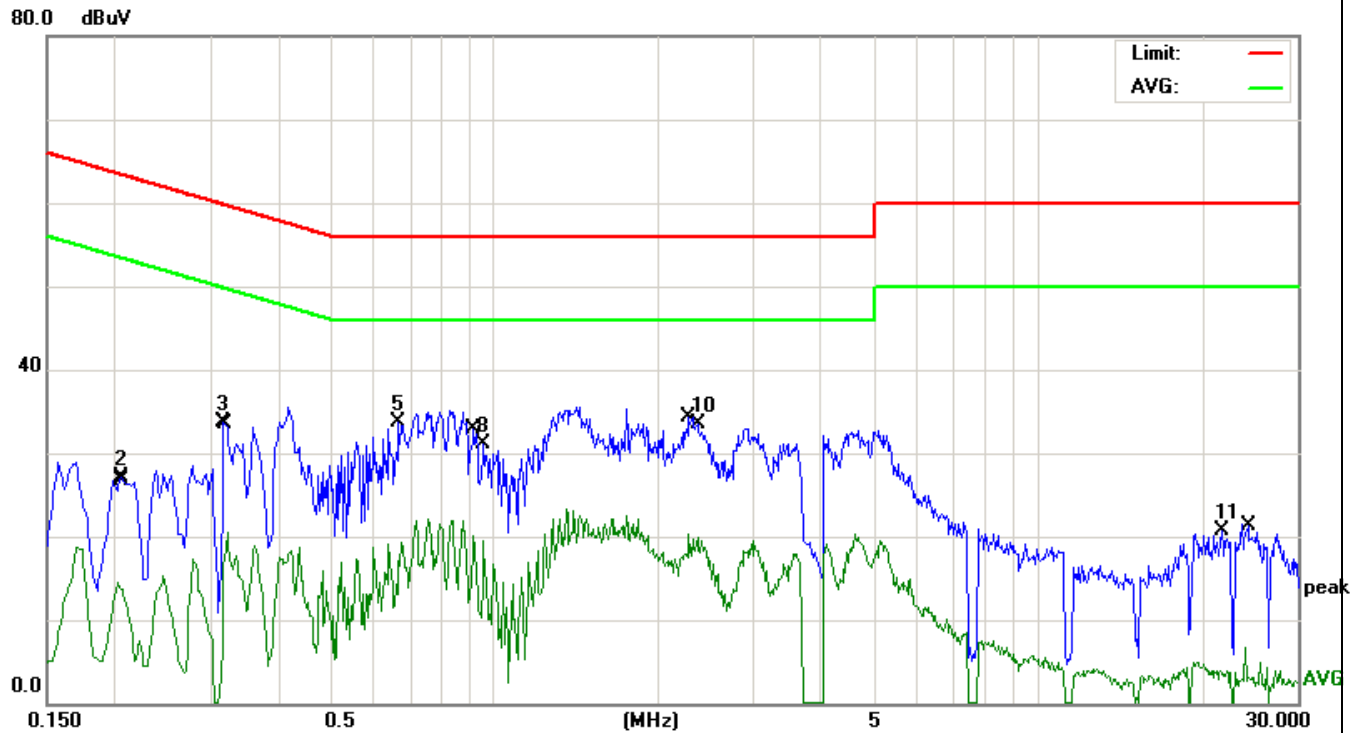

No.	Mk.	Freq. MHz	Reading Level dBuV	Correct Factor dB	Measure- ment dBuV	Limit dBuV	Over dB	Detector
1		0.2020	4.16	10.43	14.59	53.52	-38.93	AVG
2		0.2060	16.74	10.43	27.17	63.36	-36.19	peak
3		0.3180	23.37	10.42	33.79	59.76	-25.97	peak
4		0.3220	10.01	10.42	20.43	49.65	-29.22	AVG
5	*	0.6660	23.39	10.38	33.77	56.00	-22.23	peak
6		0.6740	9.02	10.38	19.40	46.00	-26.60	AVG
7		0.9140	9.66	10.35	20.01	46.00	-25.99	AVG
8		0.9580	20.75	10.34	31.09	56.00	-24.91	peak
9		2.2820	10.02	10.28	20.30	46.00	-25.70	AVG
10		2.3620	23.31	10.28	33.59	56.00	-22.41	peak
11		21.8100	10.50	10.11	20.61	60.00	-39.39	peak
12		24.0340	-3.32	10.10	6.78	50.00	-43.22	AVG

EUT	Mobile phone	Model Name	N2
Temperature	26 °C	Relative Humidity	54%
Pressure	1010hPa	Phase	N
Test Date	July 15, 2016	Test Mode	Mode 1

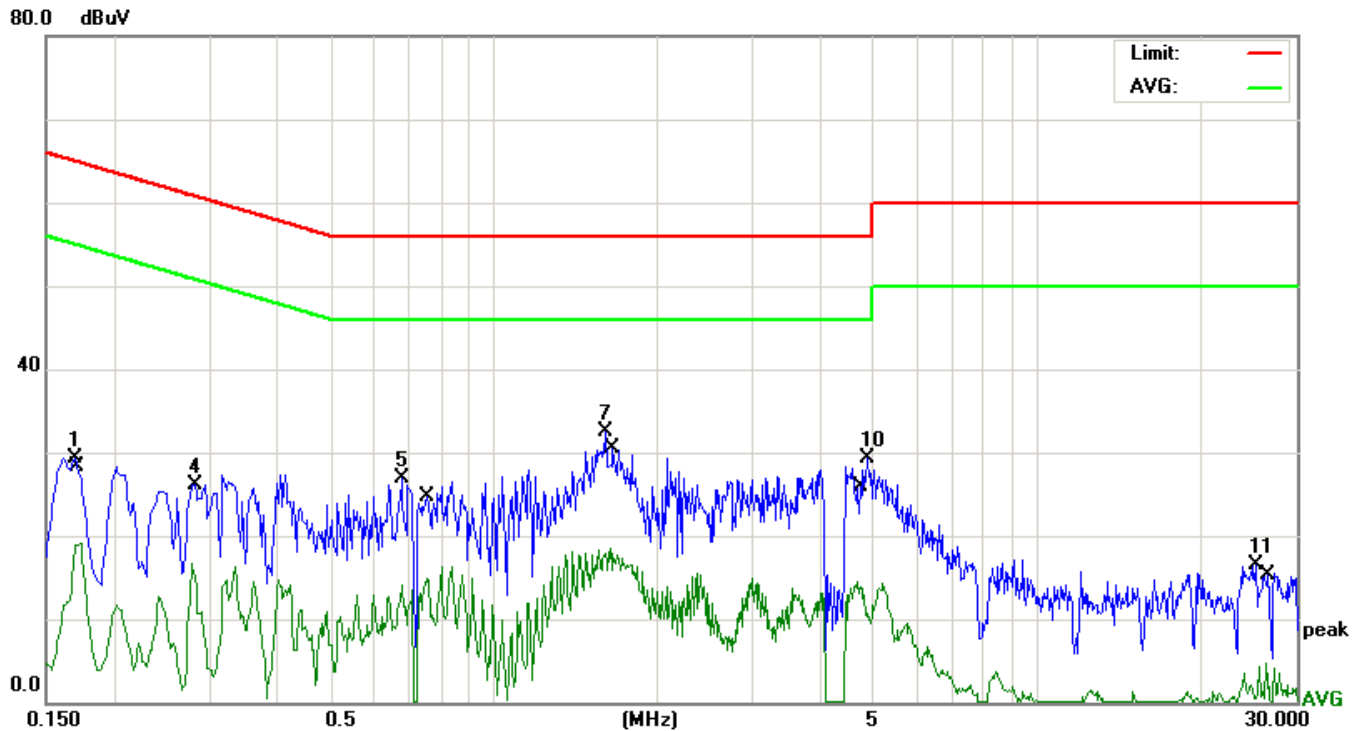

No.	Mk.	Freq. MHz	Reading Level dBuV	Correct Factor dB	Measure- ment dBuV	Limit dBuV	Over dB	Detector
1		0.1700	18.92	10.44	29.36	64.96	-35.60	peak
2		0.1740	8.64	10.44	19.08	54.76	-35.68	AVG
3		0.2779	6.18	10.43	16.61	50.88	-34.27	AVG
4		0.2819	15.69	10.42	26.11	60.76	-34.65	peak
5		0.6780	16.45	10.38	26.83	56.00	-29.17	peak
6		0.7539	4.47	10.37	14.84	46.00	-31.16	AVG
7	*	1.6060	22.12	10.31	32.43	56.00	-23.57	peak
8		1.6420	8.12	10.31	18.43	46.00	-27.57	AVG
9		4.6779	4.22	10.24	14.46	46.00	-31.54	AVG
10		4.8500	19.06	10.23	29.29	56.00	-26.71	peak
11		25.2020	6.49	10.10	16.59	60.00	-43.41	peak
12		26.3260	-5.47	10.10	4.63	50.00	-45.37	AVG

EUT	Mobile phone	Model Name	N2
Temperature	26 °C	Relative Humidity	54%
Pressure	1010hPa	Phase	L
Test Date	July 15, 2016	Test Mode	Mode 2

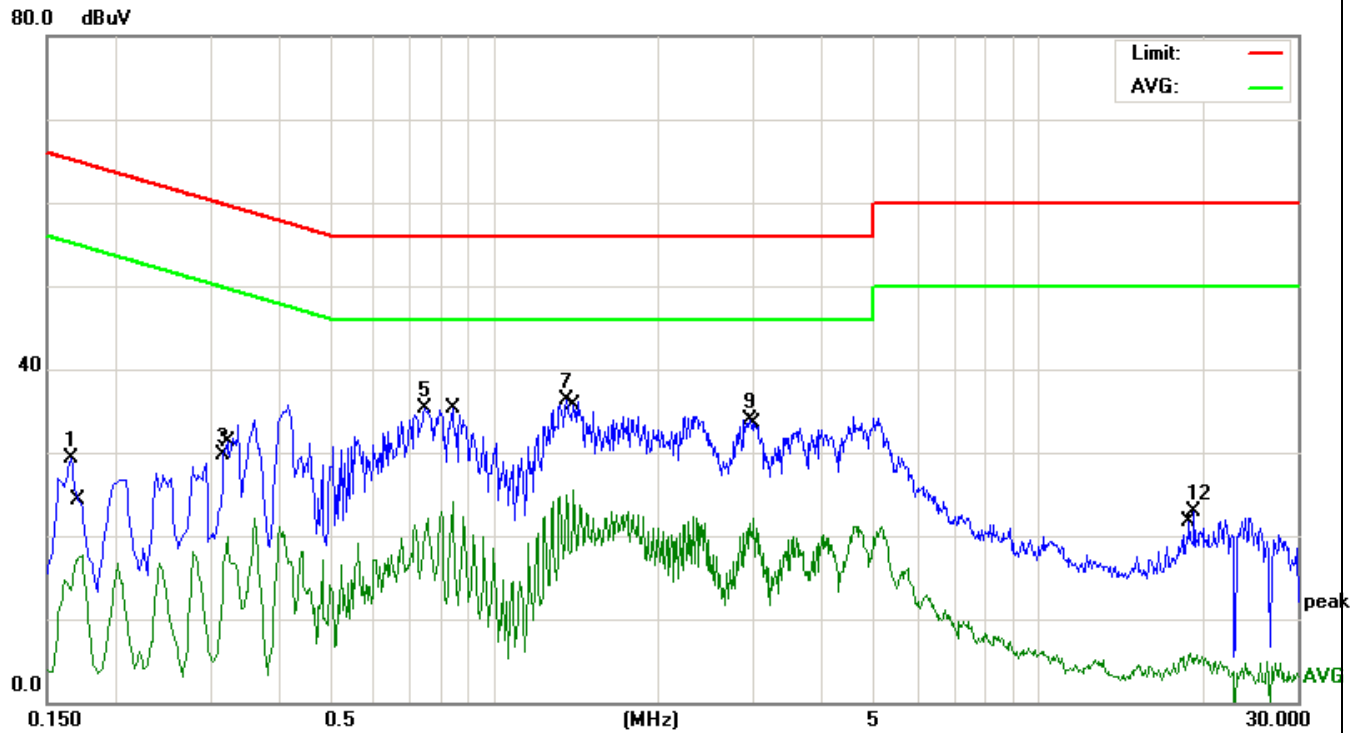

No.	Mk.	Freq. MHz	Reading Level dBuV	Correct Factor dB	Measure- ment dBuV	Limit dBuV	Over dB	Detector
1		0.1660	18.93	10.44	29.37	65.15	-35.78	peak
2		0.1740	7.20	10.44	17.64	54.76	-37.12	AVG
3		0.3180	19.24	10.42	29.66	59.76	-30.10	peak
4		0.3220	9.39	10.42	19.81	49.65	-29.84	AVG
5		0.7460	24.85	10.37	35.22	56.00	-20.78	peak
6		0.8380	13.71	10.36	24.07	46.00	-21.93	AVG
7	*	1.3580	26.02	10.32	36.34	56.00	-19.66	peak
8		1.3980	15.23	10.32	25.55	46.00	-20.45	AVG
9		2.9580	23.64	10.27	33.91	56.00	-22.09	peak
10		2.9980	11.84	10.27	22.11	46.00	-23.89	AVG
11		19.0340	-4.15	10.13	5.98	50.00	-44.02	AVG
12		19.3980	12.70	10.12	22.82	60.00	-37.18	peak

EUT	Mobile phone	Model Name	N2
Temperature	26 °C	Relative Humidity	54%
Pressure	1010hPa	Phase	N
Test Date	July 15, 2016	Test Mode	Mode 2

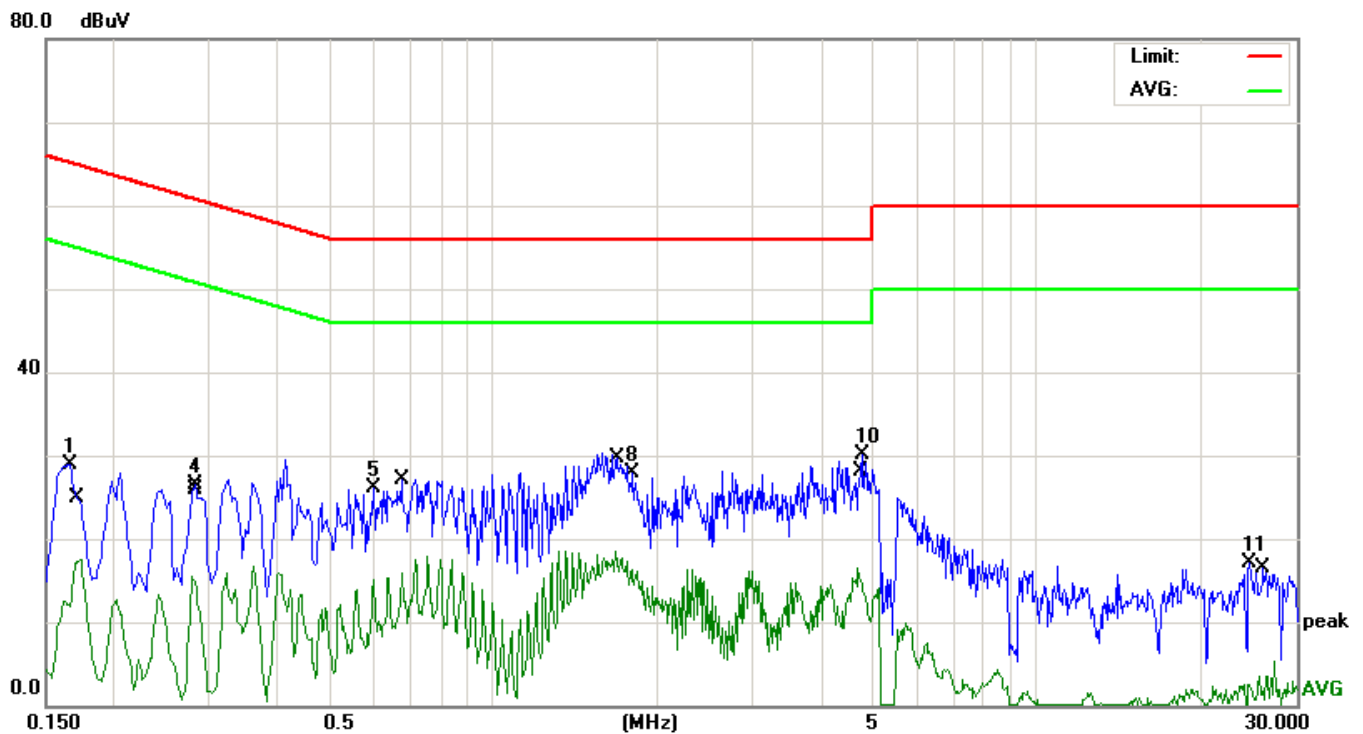

No.	Mk.	Freq. MHz	Reading Level dBuV	Correct Factor dB	Measure- ment dBuV	Limit dBuV	Over dB	Detector
1		0.1660	18.43	10.44	28.87	65.15	-36.28	peak
2		0.1740	7.05	10.44	17.49	54.76	-37.27	AVG
3		0.2779	5.02	10.43	15.45	50.88	-35.43	AVG
4		0.2819	16.02	10.42	26.44	60.76	-34.32	peak
5		0.6020	15.70	10.39	26.09	56.00	-29.91	peak
6		0.6820	5.44	10.38	15.82	46.00	-30.18	AVG
7		1.6780	8.09	10.31	18.40	46.00	-27.60	AVG
8		1.8020	17.56	10.30	27.86	56.00	-28.14	peak
9		4.6779	6.24	10.24	16.48	46.00	-29.52	AVG
10	*	4.7540	19.85	10.23	30.08	56.00	-25.92	peak
11		24.5419	7.02	10.10	17.12	60.00	-42.88	peak
12		26.3260	-6.53	10.10	3.57	50.00	-46.43	AVG

EUT	Mobile phone	Model Name	N2
Temperature	26 °C	Relative Humidity	54%
Pressure	1010hPa	Phase	L
Test Date	July 015, 2016	Test Mode	Mode 3

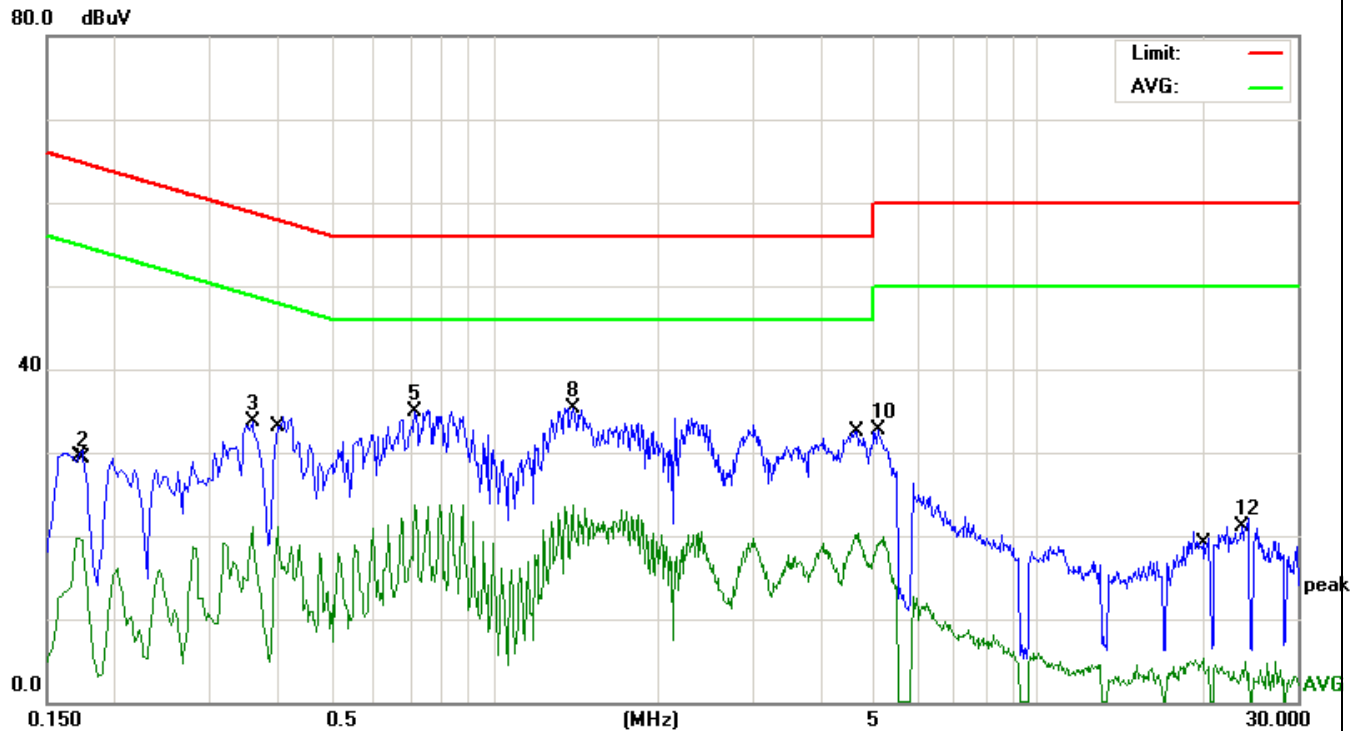

No.	Mk.	Freq. MHz	Reading Level dBuV	Correct Factor dB	Measure- ment dBuV	Limit dBuV	Over dB	Detector
1		0.1700	9.32	10.44	19.76	54.96	-35.20	AVG
2		0.1749	18.87	10.44	29.31	64.72	-35.41	peak
3		0.3580	23.31	10.42	33.73	58.77	-25.04	peak
4		0.3980	10.66	10.41	21.07	47.89	-26.82	AVG
5		0.7140	24.50	10.37	34.87	56.00	-21.13	peak
6		0.7140	13.27	10.37	23.64	46.00	-22.36	AVG
7		1.3940	13.30	10.32	23.62	46.00	-22.38	AVG
8	*	1.3980	25.07	10.32	35.39	56.00	-20.61	peak
9		4.6779	10.10	10.24	20.34	46.00	-25.66	AVG
10		5.0820	22.49	10.23	32.72	60.00	-27.28	peak
11		20.1180	-4.72	10.12	5.40	50.00	-44.60	AVG
12		23.6700	11.03	10.11	21.14	60.00	-38.86	peak

EUT	Mobile phone	Model Name	N2
Temperature	26 °C	Relative Humidity	54%
Pressure	1010hPa	Phase	N
Test Date	July 15, 2016	Test Mode	Mode 3

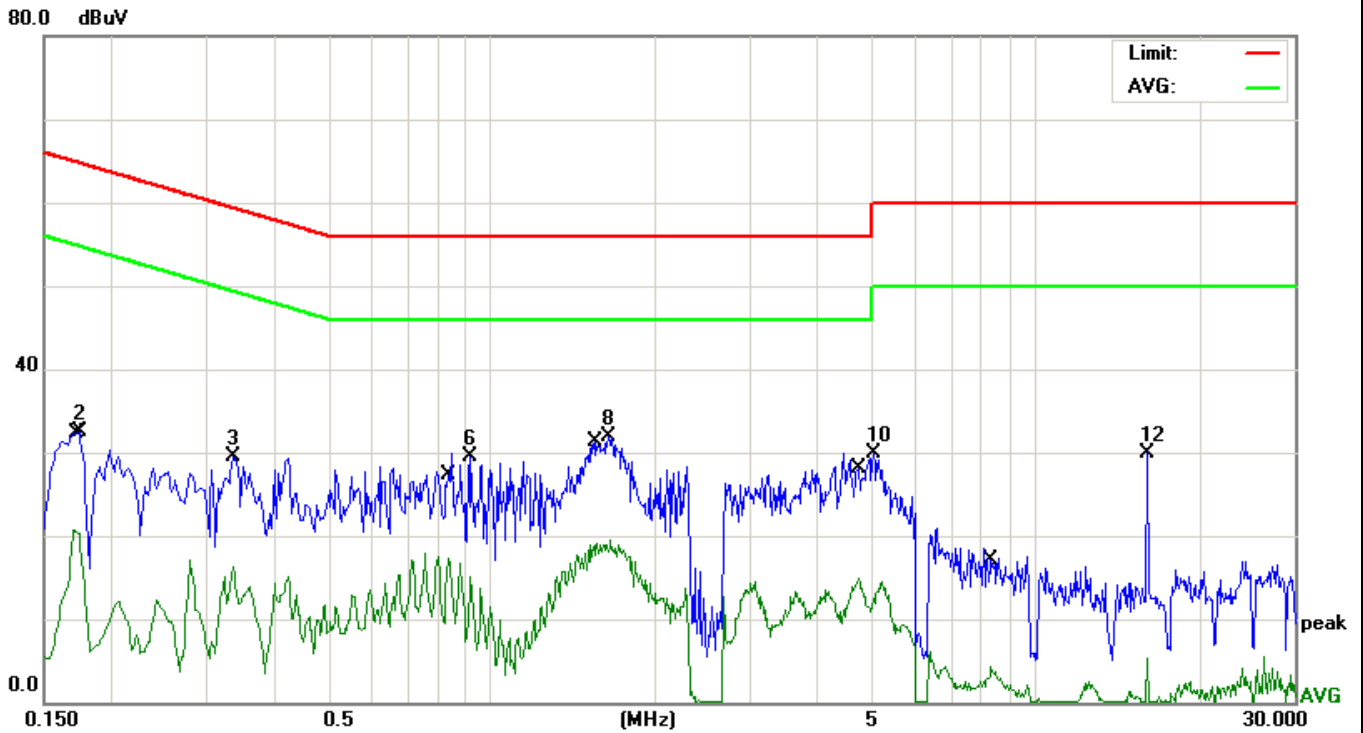

No.	Mk.	Freq. MHz	Reading Level dBuV	Correct Factor dB	Measure- ment dBuV	Limit dBuV	Over dB	Detector
1		0.1700	10.27	10.44	20.71	54.96	-34.25	AVG
2		0.1740	21.97	10.44	32.41	64.76	-32.35	peak
3		0.3339	19.02	10.42	29.44	59.35	-29.91	peak
4		0.3339	5.84	10.42	16.26	49.35	-33.09	AVG
5		0.8340	7.03	10.36	17.39	46.00	-28.61	AVG
6		0.9140	19.07	10.35	29.42	56.00	-26.58	peak
7		1.5620	8.85	10.31	19.16	46.00	-26.84	AVG
8	*	1.6380	21.66	10.31	31.97	56.00	-24.03	peak
9		4.7220	4.66	10.24	14.90	46.00	-31.10	AVG
10		5.0540	19.74	10.23	29.97	60.00	-30.03	peak
11		8.3260	-6.57	10.20	3.63	50.00	-46.37	AVG
12		16.0660	19.80	10.14	29.94	60.00	-30.06	peak

5.2 RADIATED EMISSION MEASUREMENT

5.2.1 RADIATED EMISSION LIMITS (Frequency Range 9kHz-1000MHz)

20dBc in any 100 kHz bandwidth outside the operating frequency band. In case the emission fall within the restricted band specified on 15.205(a), then the 15.209(a) limit in the table below has to be followed.

Frequencies (MHz)	Field Strength (micorvolts/meter)	Measurement Distance (meters)
0.009~0.490	2400/F(KHz)	300
0.490~1.705	24000/F(KHz)	30
1.705~30.0	30	30
30~88	100	3
88~216	150	3
216~960	200	3
Above 960	500	3

LIMITS OF RADIATED EMISSION MEASUREMENT (Above 1000MHz)

FREQUENCY (MHz)	Limit (dBuV/m) (at 3M)	
	PEAK	AVERAGE
Above 1000	74	54

Notes:

- (1) The limit for radiated test was performed according to FCC PART 15C.
- (2) The tighter limit applies at the band edges.
- (3) Emission level (dBuV/m)=20log Emission level (uV/m).

Spectrum Parameter	Setting
Attenuation	Auto
Start Frequency	1000 MHz
Stop Frequency	10th carrier harmonic
RB / VB (emission in restricted band)	1 MHz / 1 MHz for Peak, 1 MHz / 10Hz for Average

Receiver Parameter	Setting
Attenuation	Auto
Start ~ Stop Frequency	9kHz~150kHz / RB 200Hz for QP
Start ~ Stop Frequency	150kHz~30MHz / RB 9kHz for QP
Start ~ Stop Frequency	30MHz~1000MHz / RB 120kHz for QP

5.2.2 TEST PROCEDURE

- a. The measuring distance of at 3 m shall be used for measurements at frequency up to 1GHz. For frequencies above 1GHz, any suitable measuring distance may be used.
- b. The EUT was placed on the top of a rotating table 0.8 meters above the ground at a 3 meter open area test site. The table was rotated 360 degrees to determine the position of the highest radiation.
- c. The height of the equipment or of the substitution antenna shall be 0.8 m; the height of the test antenna shall vary between 1 m to 4 m. Both horizontal and vertical polarizations of the antenna are set to make the measurement.
- d. The initial step in collecting conducted emission data is a spectrum analyzer peak detector mode pre-scanning the measurement frequency range. Significant peaks are then marked and then Quasi Peak detector mode re-measured.
- e. If the Peak Mode measured value compliance with and lower than Quasi Peak Mode Limit, the EUT shall be deemed to meet QP Limits and then no additional QP Mode measurement performed.
- f. For the actual test configuration, please refer to the related Item –EUT Test Photos.

Note:

Both horizontal and vertical antenna polarities were tested and performed pretest to three orthogonal axis. The worst case emissions were reported

5.2.3 DEVIATION FROM TEST STANDARD

No deviation

5.2.4 TEST SETUP

(A) Radiated Emission Test-Up Frequency 30MHz~1GHz

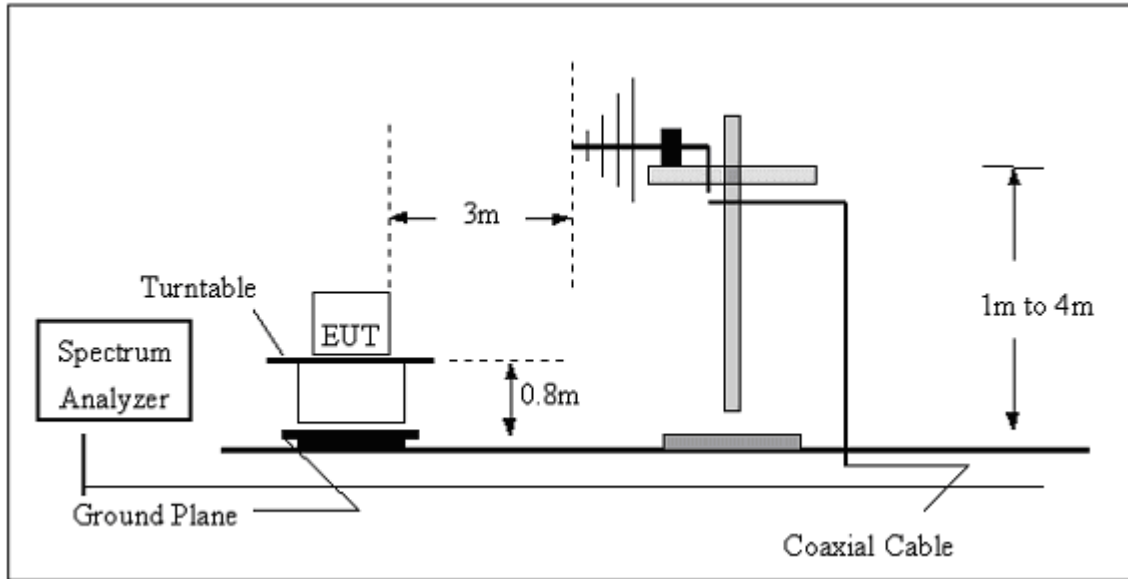

(B) Radiated Emission Test-Up Frequency Above 1GHz

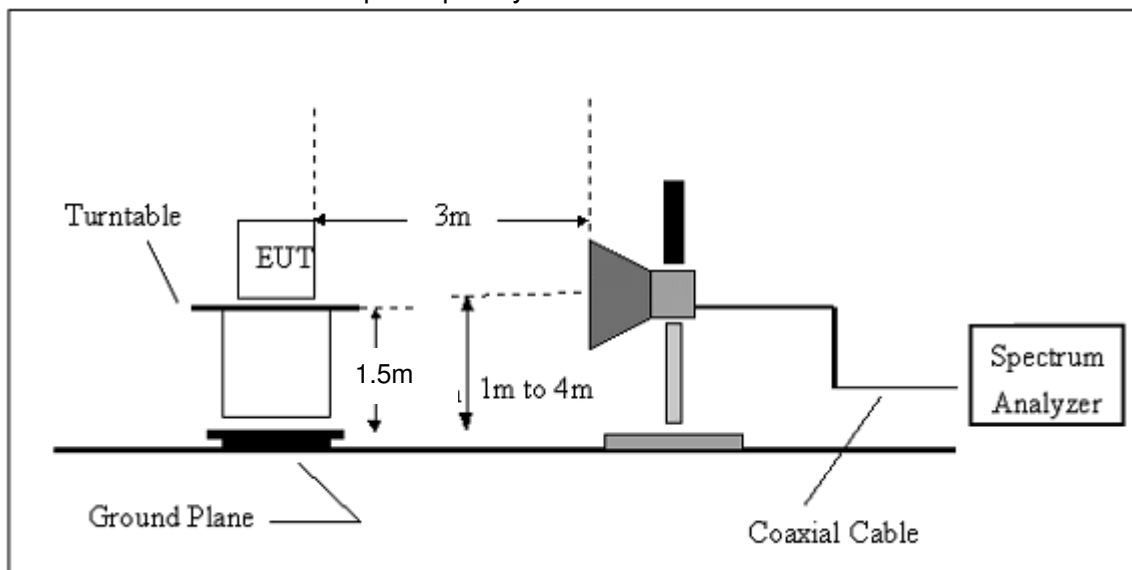

5.2.5 EUT OPERATING CONDITIONS

The EUT tested system was configured as the statements of 2.4 Unless otherwise a special operating condition is specified in the follows during the testing.

5.2.5.1 TEST RESULTS (BETWEEN 30M – 1000 MHZ)

EUT	Mobile phone	Model Name	N2
Temperature	20 °C	Relative Humidity	48%
Pressure	1010 hPa	Polarization :	Horizontal
Test Mode	Mode 1	Test Date	July 15, 2016

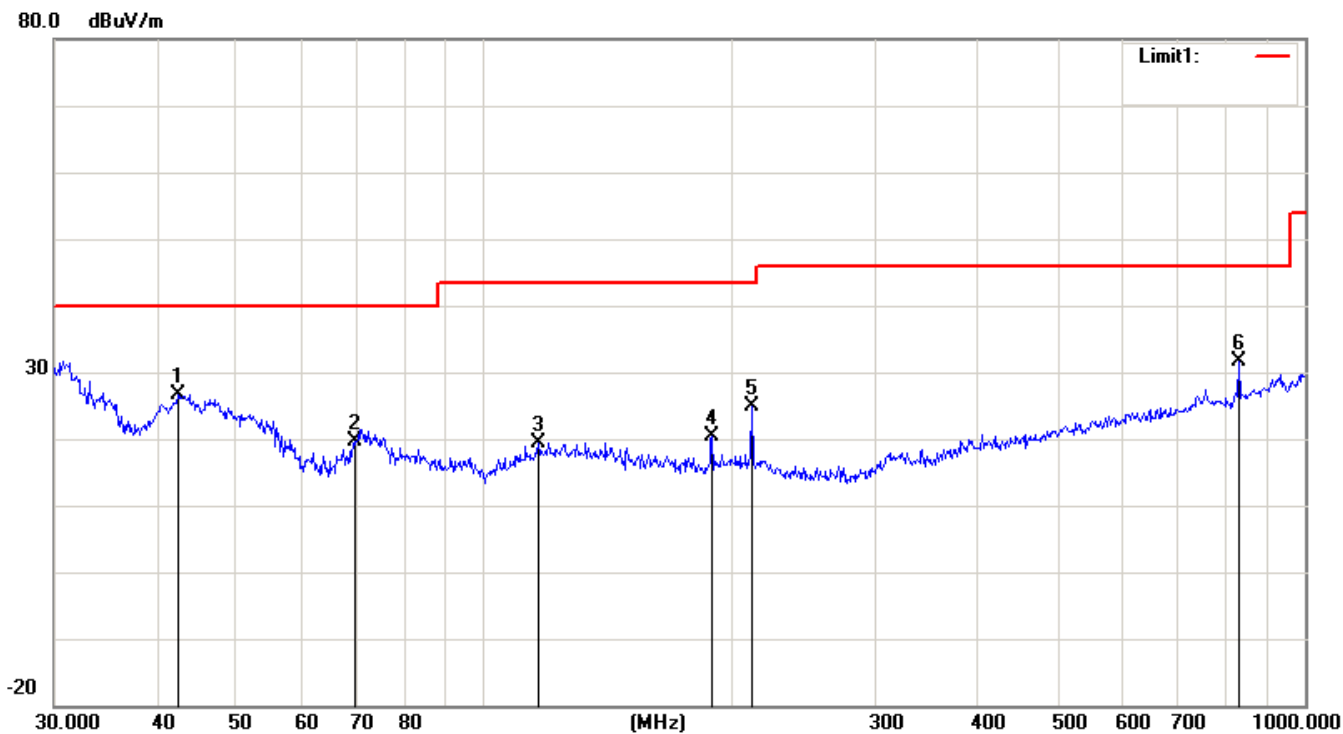

No.	Mk.	Freq. MHz	Reading Level dBuV	Correct Factor dB	Measure- ment dBuV/m	Limit dBuV/m	Over dB	Detector
1	*	42.4508	31.70	-5.08	26.62	40.00	-13.38	peak
2		69.6005	27.43	-7.89	19.54	40.00	-20.46	peak
3		116.5401	22.10	-2.64	19.46	43.50	-24.04	peak
4		189.7385	25.65	-5.28	20.37	43.50	-23.13	peak
5		212.2695	30.24	-5.26	24.98	43.50	-18.52	peak
6		830.4002	26.41	5.20	31.61	46.00	-14.39	peak

EUT	Mobile phone	Model Name	N2
Temperature	20 °C	Relative Humidity	48%
Pressure	1010 hPa	Polarization :	Vertical
Test Mode	Mode 1	Test Date	July 15, 2016

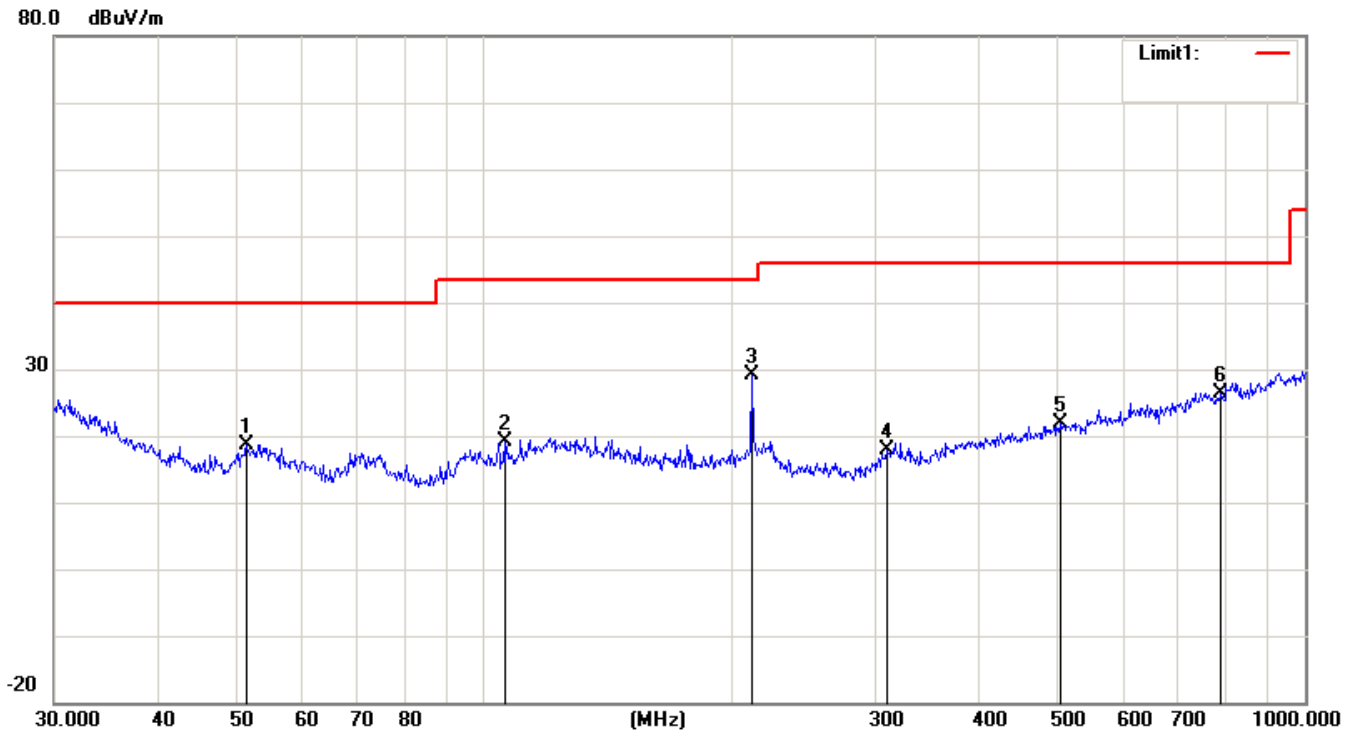

No.	Mk.	Freq. MHz	Reading Level dBuV	Correct Factor dB	Measure- ment dBuV/m	Limit dBuV/m	Over dB	Detector
1		51.4807	27.90	-9.16	18.74	40.00	-21.26	peak
2		106.0126	23.84	-4.68	19.16	43.50	-24.34	peak
3	*	212.2695	34.37	-5.26	29.11	43.50	-14.39	peak
4		309.9977	22.24	-4.32	17.92	46.00	-28.08	peak
5		502.9395	22.72	-0.95	21.77	46.00	-24.23	peak
6		790.6188	22.37	4.06	26.43	46.00	-19.57	peak

EUT	Mobile phone	Model Name	N2
Temperature	20 °C	Relative Humidity	48%
Pressure	1010 hPa	Polarization :	Horizontal
Test Mode	Mode 2	Test Date	July 15, 2016

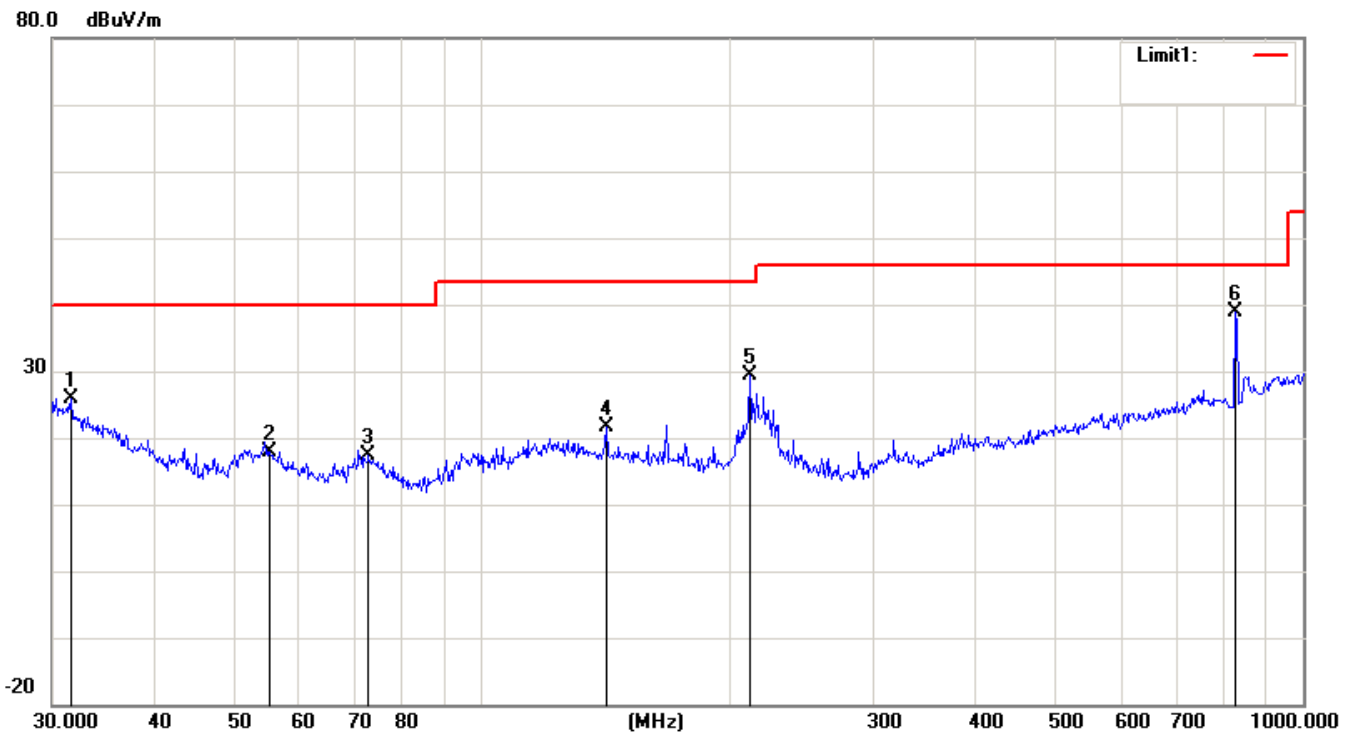

No.	Mk.	Freq. MHz	Reading Level dBuV	Correct Factor dB	Measure- ment dBuV/m	Limit dBuV/m	Over dB	Detector
1		31.6202	23.36	2.40	25.76	40.00	-14.24	peak
2		55.2207	27.47	-9.50	17.97	40.00	-22.03	peak
3		72.8466	25.00	-7.65	17.35	40.00	-22.65	peak
4		141.8262	24.88	-3.19	21.69	43.50	-21.81	peak
5		212.2695	34.76	-5.26	29.50	43.50	-14.00	peak
6	*	827.4934	33.60	5.18	38.78	46.00	-7.22	peak

EUT	Mobile phone	Model Name	N2
Temperature	20 °C	Relative Humidity	48%
Pressure	1010 hPa	Polarization :	Vertical
Test Mode	Mode 2	Test Date	July 15, 2016

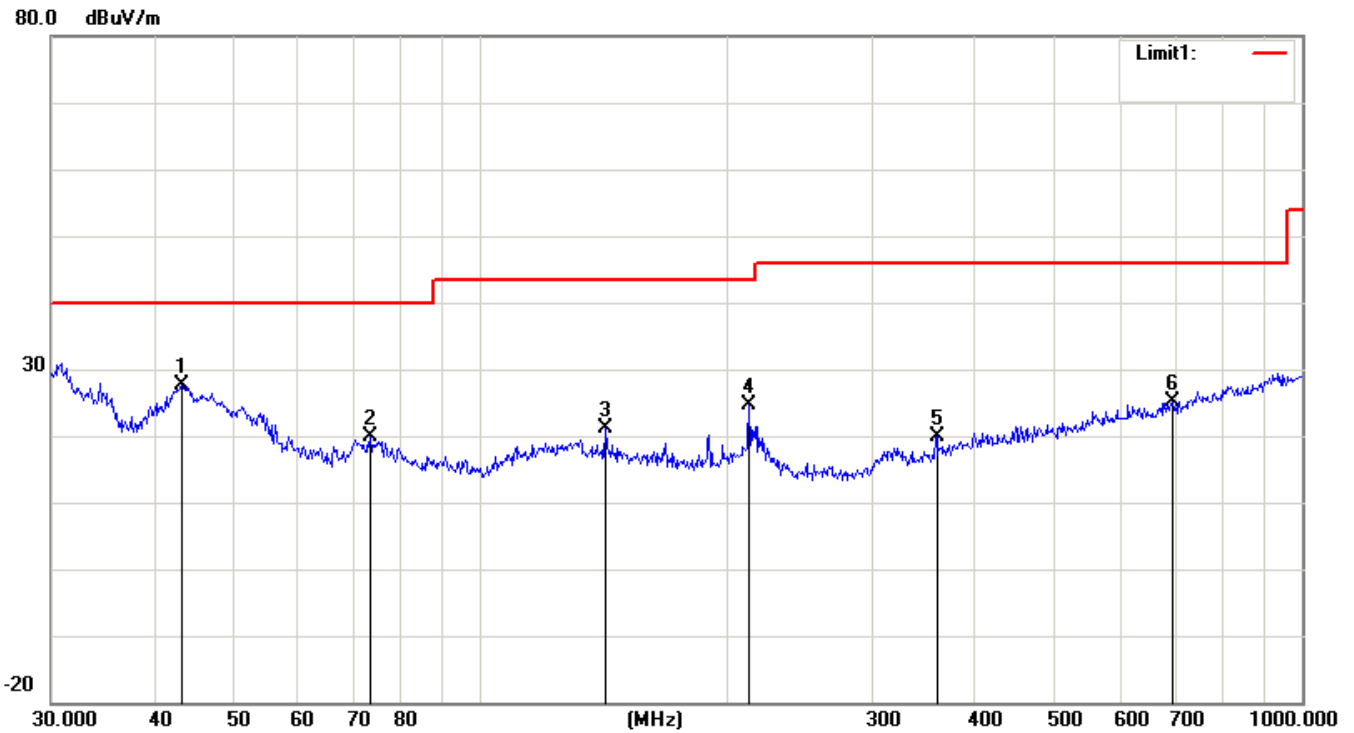

No.	Mk.	Freq. MHz	Reading Level dBuV	Correct Factor dB	Measure- ment dBuV/m	Limit dBuV/m	Over dB	Detector
1	*	43.3534	33.25	-5.66	27.59	40.00	-12.41	peak
2		73.3593	27.51	-7.63	19.88	40.00	-20.12	peak
3		141.8262	24.36	-3.19	21.17	43.50	-22.33	peak
4		212.2695	29.77	-5.26	24.51	43.50	-18.99	peak
5		359.1860	23.89	-3.94	19.95	46.00	-26.05	peak
6		696.8567	22.96	2.26	25.22	46.00	-20.78	peak

EUT	Mobile phone	Model Name	N2
Temperature	20 °C	Relative Humidity	48%
Pressure	1010 hPa	Polarization :	Horizontal
Test Mode	Mode 3	Test Date	July 15, 2016

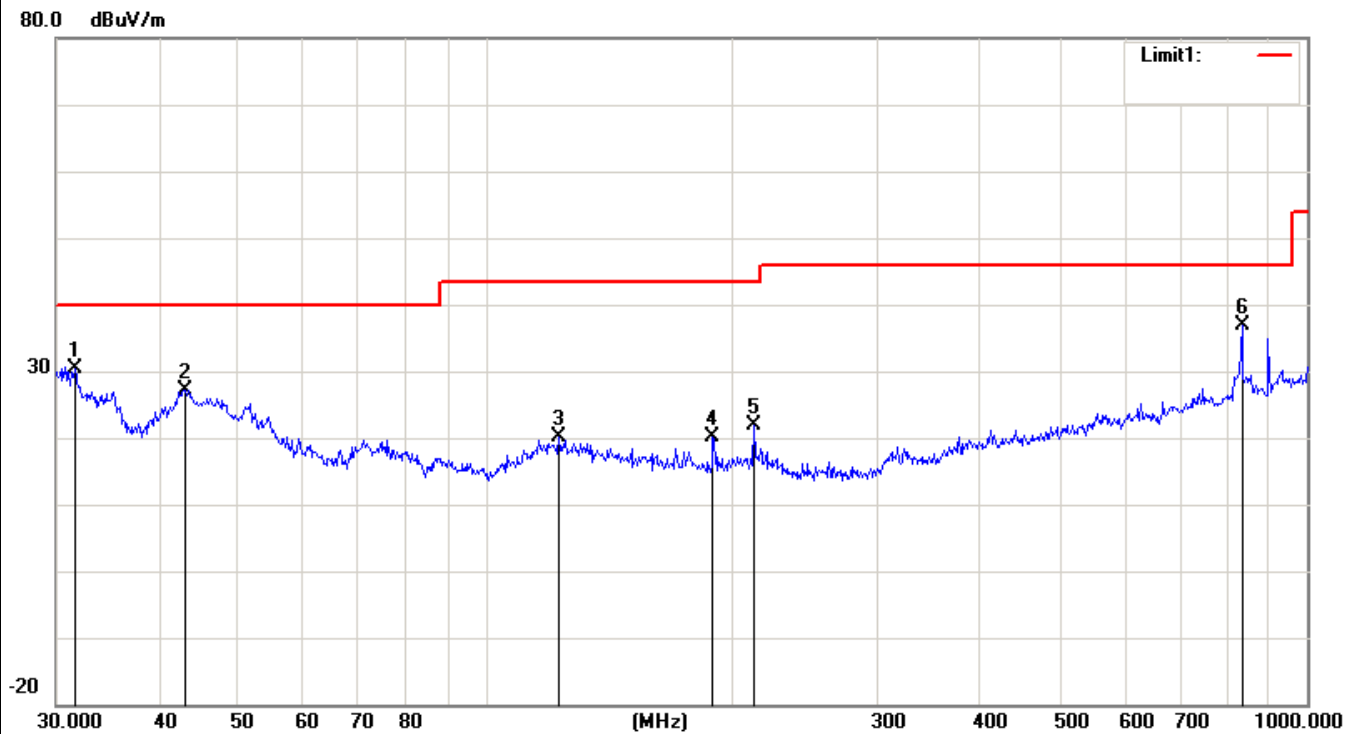

No.	Mk.	Freq. MHz	Reading Level dBuV	Correct Factor dB	Measure- ment dBuV/m	Limit dBuV/m	Over dB	Detector
1		31.6202	28.00	2.40	30.40	40.00	-9.60	peak
2		43.0505	32.62	-5.46	27.16	40.00	-12.84	peak
3		122.8340	22.25	-2.22	20.03	43.50	-23.47	peak
4		189.0743	25.37	-5.28	20.09	43.50	-23.41	peak
5		212.2695	27.23	-5.26	21.97	43.50	-21.53	peak
6	*	833.3171	31.74	5.11	36.85	46.00	-9.15	peak

EUT	Mobile phone	Model Name	N2
Temperature	20 °C	Relative Humidity	48%
Pressure	1010 hPa	Polarization :	Vertical
Test Mode	Mode 3	Test Date	July 15, 2016

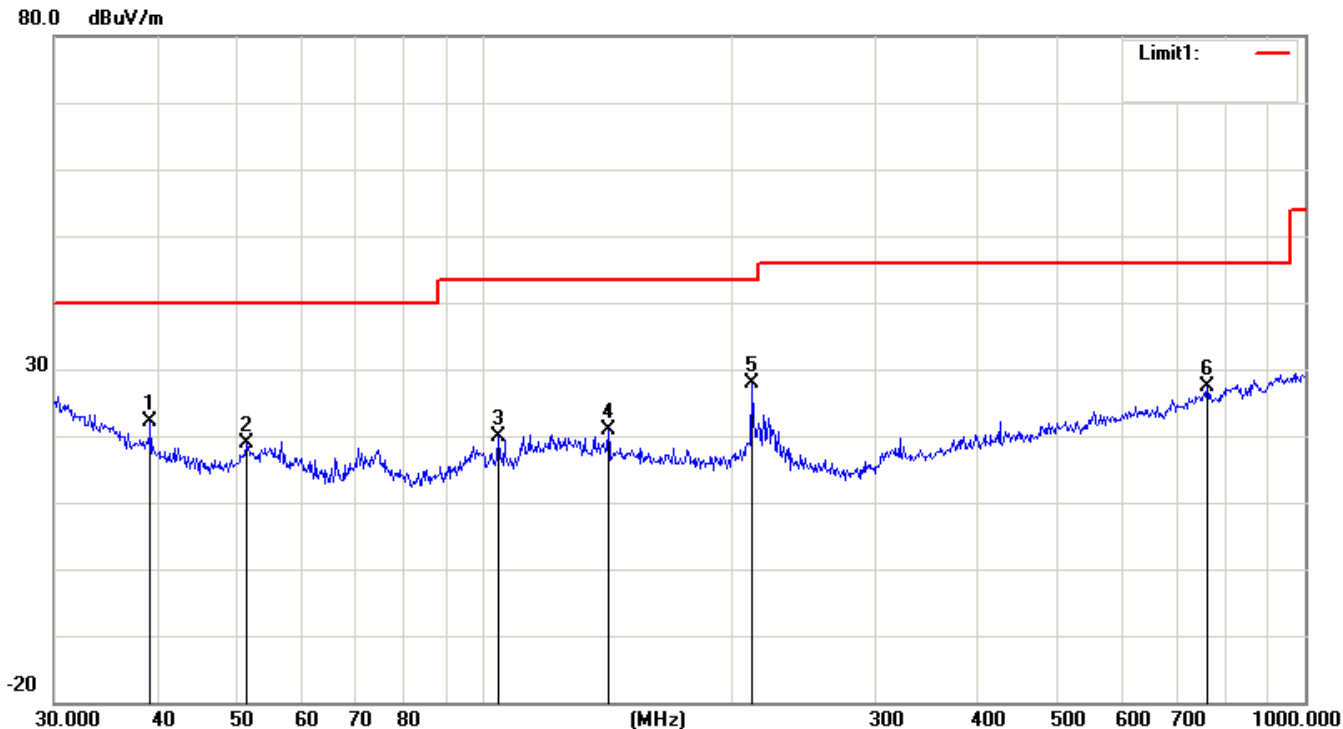

No.	Mk.	Freq. MHz	Reading Level dBuV	Correct Factor dB	Measure- ment dBuV/m	Limit dBuV/m	Over dB	Detector
1		39.2991	25.06	-2.99	22.07	40.00	-17.93	peak
2		51.4807	28.02	-9.16	18.86	40.00	-21.14	peak
3		104.1701	25.17	-5.18	19.99	43.50	-23.51	peak
4		141.8262	24.13	-3.19	20.94	43.50	-22.56	peak
5	*	212.2695	33.11	-5.26	27.85	43.50	-15.65	peak
6		760.7036	23.71	3.56	27.27	46.00	-18.73	peak

5.2.5.2 TEST RESULTS(1GHZ TO 6GHZ)

EUT	Mobile phone	Model Name	N2
Temperature	20 °C	Relative Humidity	48%
Pressure	1010 hPa	Test Mode	Mode 1
Test Date	July 15, 2016		

Freq. (MHz)	Ant. Pol.	Emission Level(dBuV)		Limit 3m(dBuV/m)		Over(dB)	
		PK	AV	PK	AV	PK	AV
1632.45	V	59.10	39.29	74	54	-14.90	-14.71
2829.27	V	58.71	39.20	74	54	-15.29	-14.80
1684.52	H	58.72	39.16	74	54	-15.28	-14.84
2831.6	H	58.90	39.90	74	54	-15.10	-14.10

Remark:

All emissions not reported were more than 20dB below the specified limit or in the noise floor.

Factor = Antenna Factor + Cable Loss – Pre-amplifier.

All the x/y/z orientation has been investigated, and only worst case is presented in this report.

EUT	Mobile phone	Model Name	N2
Temperature	20 °C	Relative Humidity	48%
Pressure	1010 hPa	Test Mode	Mode 2
Test Date	June 01, 2016		

Freq. (MHz)	Ant. Pol.	Emission Level(dBuV)		Limit 3m(dBuV/m)		Over(dB)	
		PK	AV	PK	AV	PK	AV
1583.35	V	60.60	41.73	74	54	-13.40	-12.27
2641.52	V	58.29	40.86	74	54	-15.71	-13.14
1628.42	H	58.99	39.34	74	54	-15.01	-14.66
2810.39	H	59.68	40.68	74	54	-14.32	-13.32

Remark:

All emissions not reported were more than 20dB below the specified limit or in the noise floor.

Factor = Antenna Factor + Cable Loss – Pre-amplifier.

All the x/y/z orientation has been investigated, and only worst case is presented in this report.

EUT	Mobile phone	Model Name	N2
Temperature	20 °C	Relative Humidity	48%
Pressure	1010 hPa	Test Mode	Mode 3
Test Date	June 01, 2016		

Freq. (MHz)	Ant. Pol.	Emission Level(dBuV)		Limit 3m(dBuV/m)		Over(dB)	
		PK	AV	PK	AV	PK	AV
1577.35	V	60.66	39.76	74	54	-13.34	-14.24
2652.38	V	58.13	39.20	74	54	-15.87	-14.80
1699.33	H	58.56	39.44	74	54	-15.44	-14.56
2739.42	H	58.50	39.50	74	54	-15.50	-14.50

Remark:

All emissions not reported were more than 20dB below the specified limit or in the noise floor.

Factor = Antenna Factor + Cable Loss – Pre-amplifier.

All the x/y/z orientation has been investigated, and only worst case is presented in this report.

6. EUT TEST PHOTO

CONDUCTED EMISSION TEST

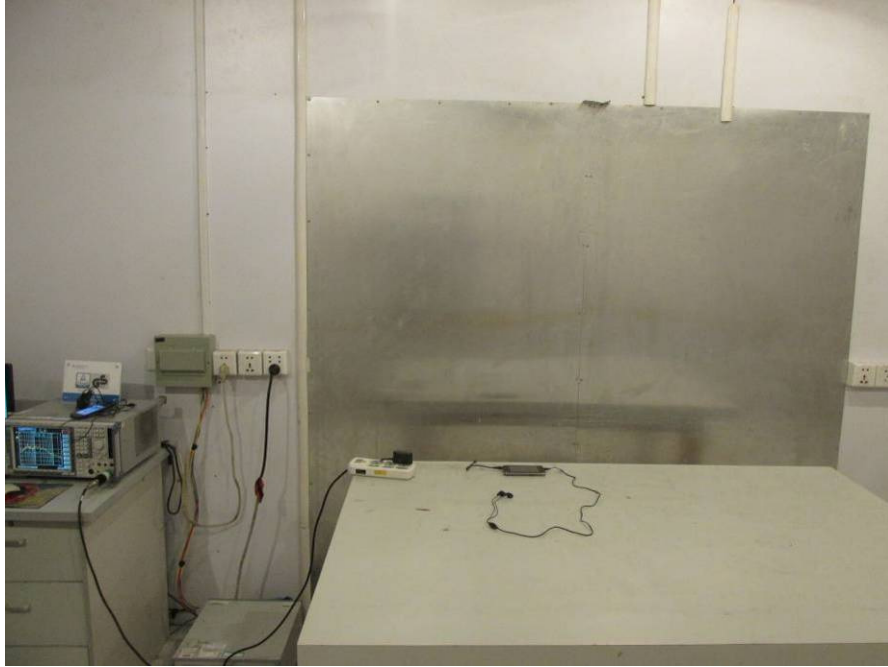

RADIATED EMISSION TEST

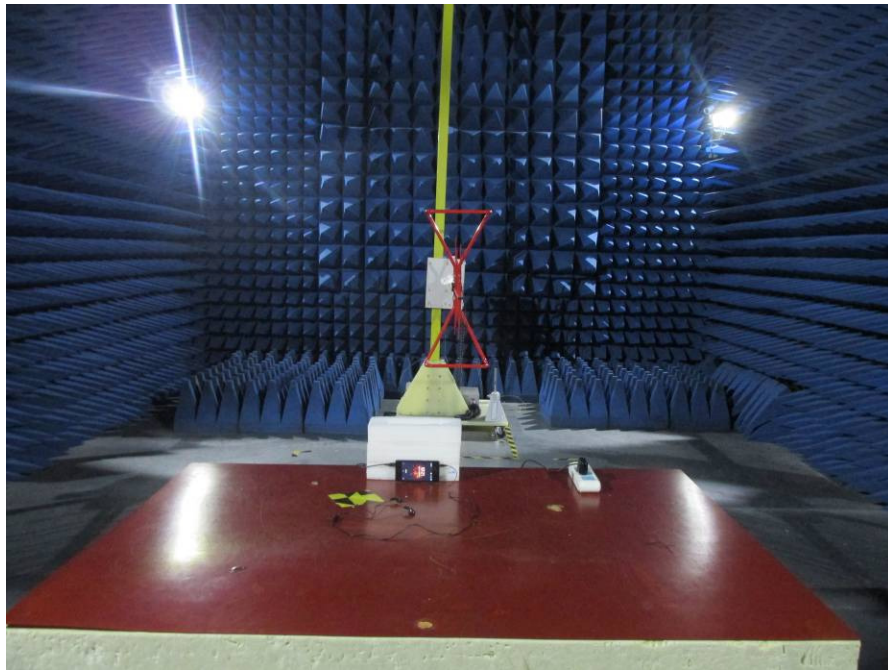

RADIATED EMISSION TEST



7. PHOTOGRAPHS OF EUT

Appearance photograph of EUT



Appearance photograph of EUT



Appearance photograph of EUT



Appearance photograph of EUT



Appearance photograph of EUT



Appearance photograph of EUT



Appearance photograph of EUT



Appearance photograph of EUT



Appearance photograph of EUT



Internal photograph of EUT



Internal photograph of EUT



Internal photograph of EUT



Internal photograph of EUT



Internal photograph of EUT



Internal photograph of EUT



Internal photograph of EUT

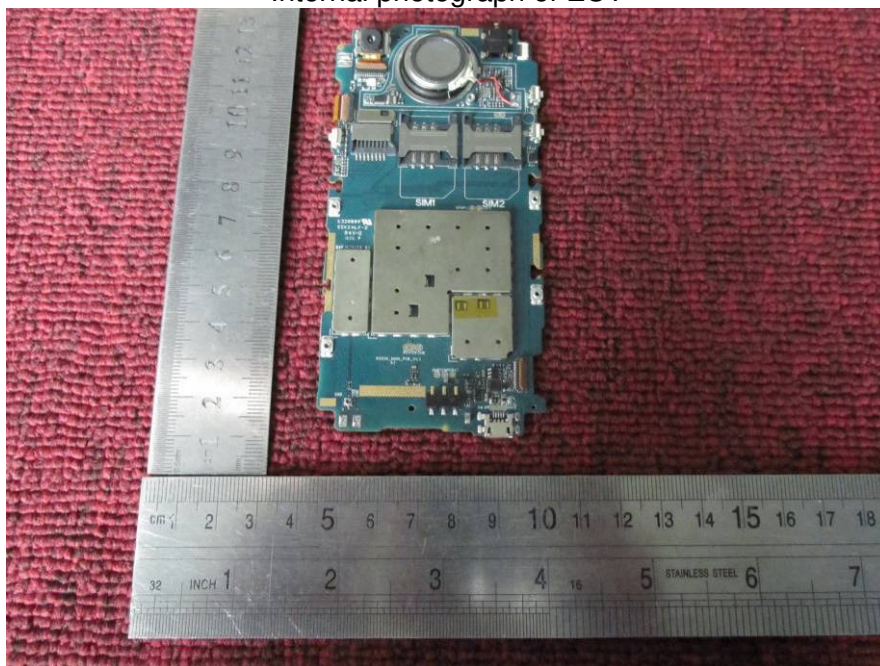

Internal photograph of EUT

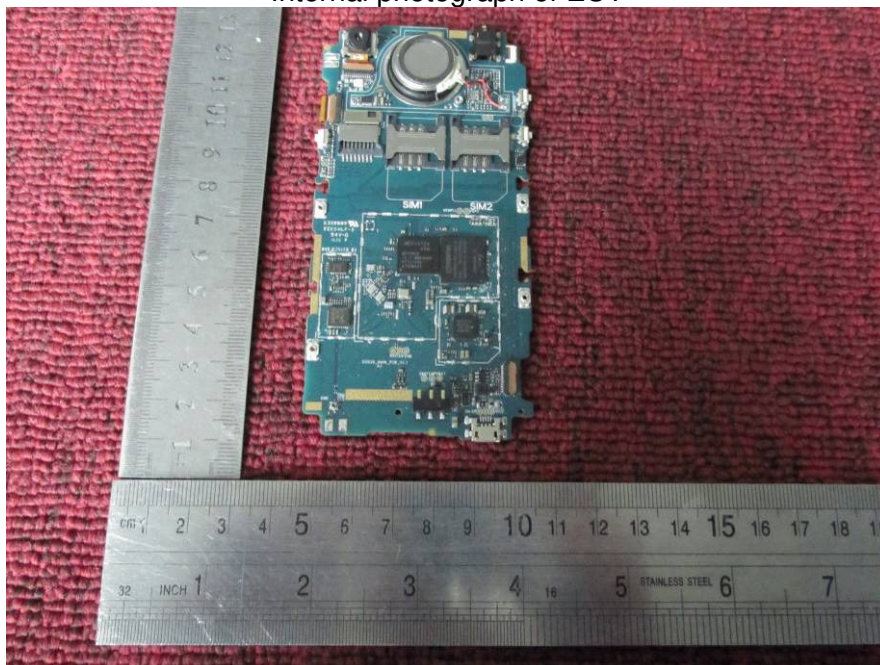

Internal photograph of EUT

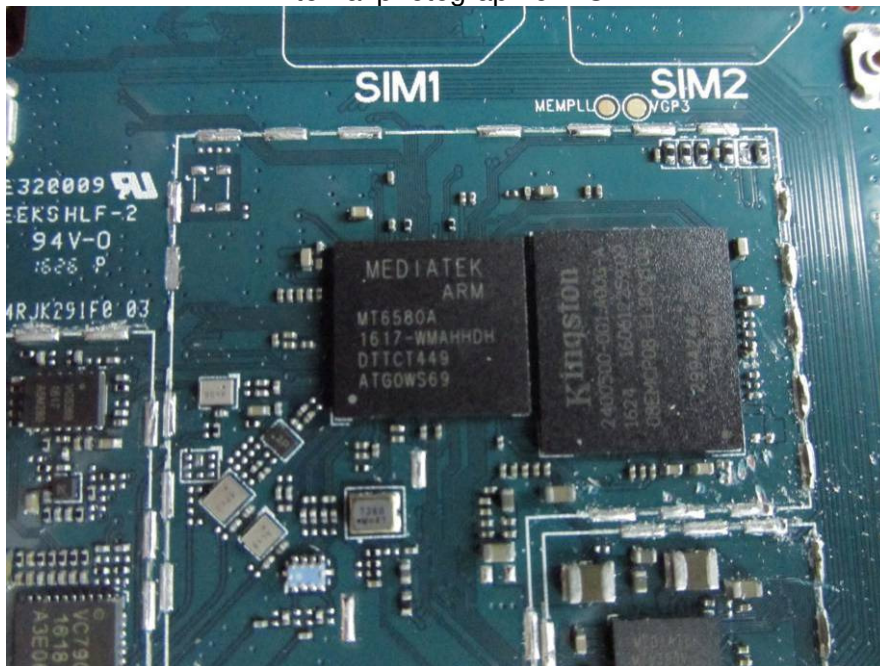

Internal photograph of EUT

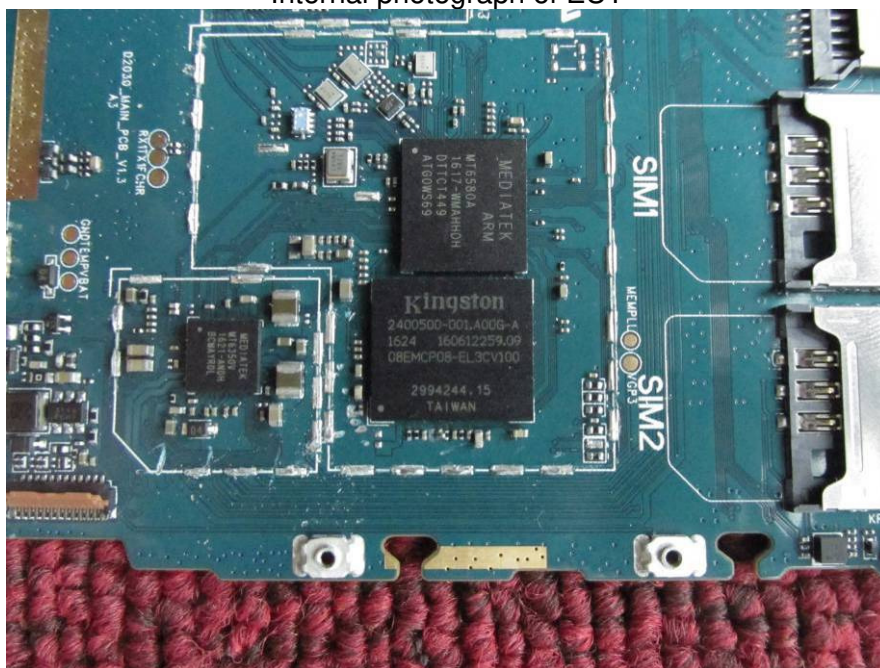

Internal photograph of EUT

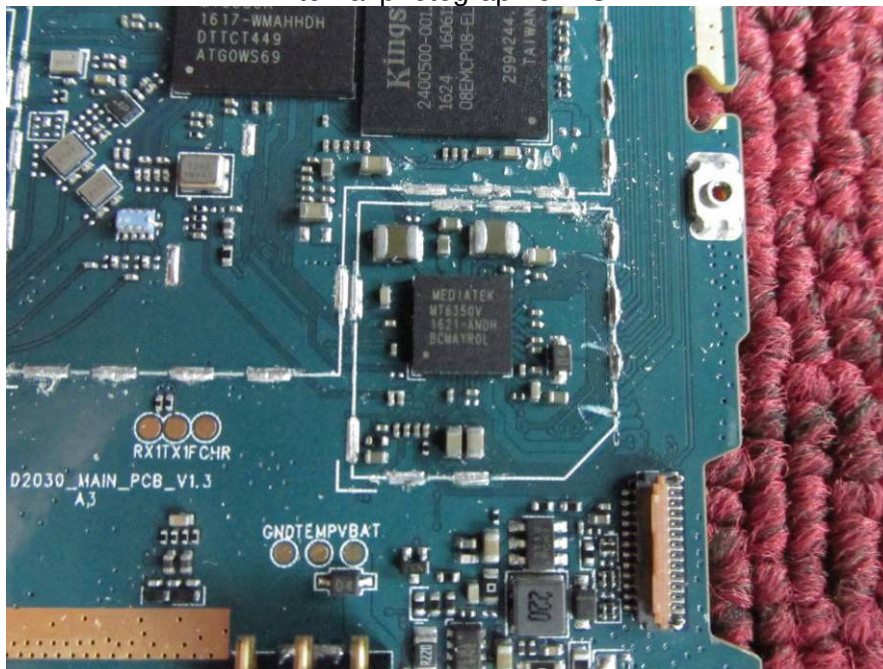

Internal photograph of EUT

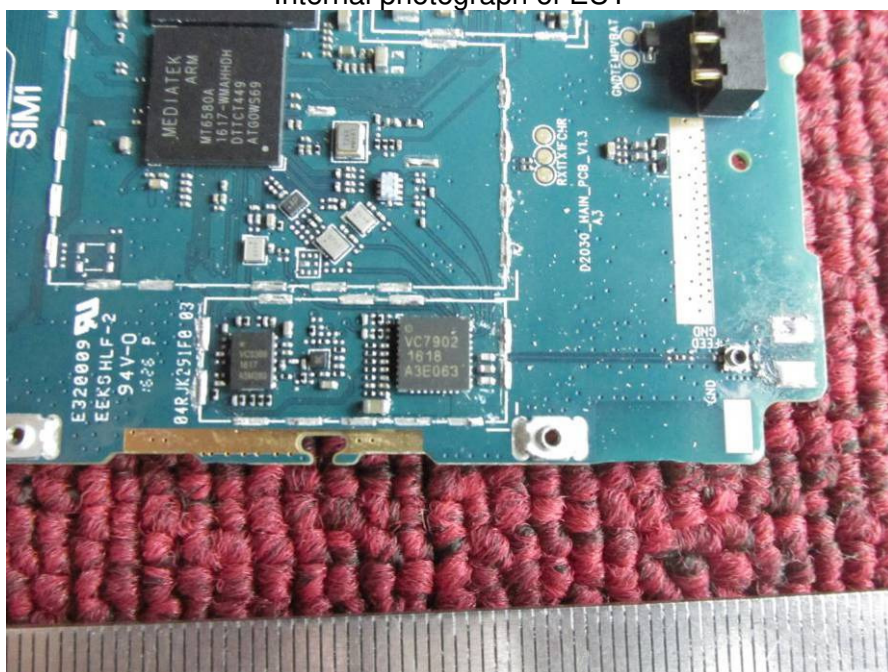

Internal photograph of EUT



Internal photograph of EUT

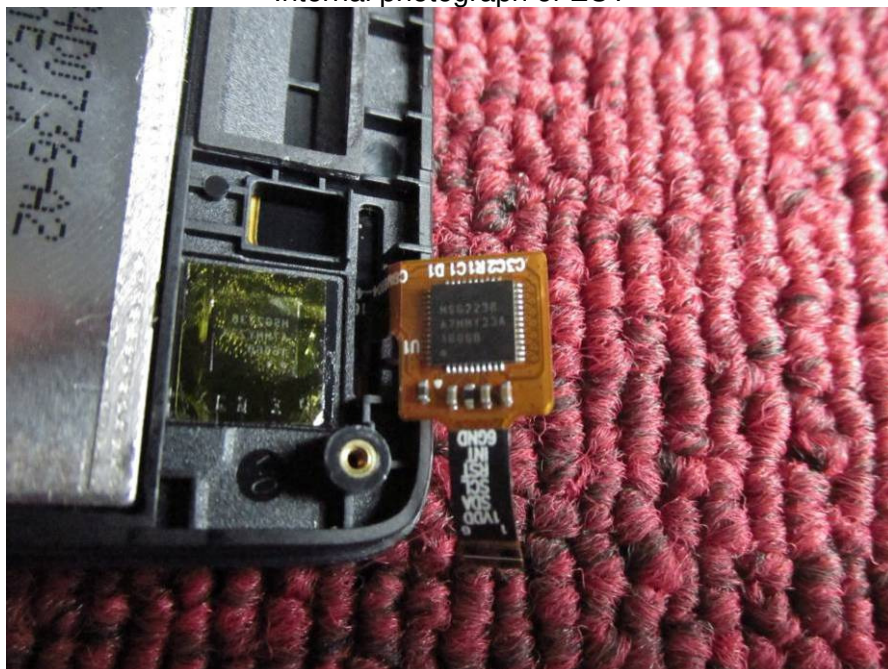

---END OF REPORT---