

FCC RF Test Report

(BLE)

Applicant: TECNO MOBILE LIMITED

Address of Applicant: FLAT N 16/F BLOCK B UNIVERSAL INDUSTRIAL CENTRE
19-25 SHAN MEI STREET FOTAN NT HONGKONG

Equipment Under Test (EUT)

Product Name: Mobile Phone

Model No.: LH8n

Trade Mark: TECNO

FCC ID: 2ADYY-LH8N

Applicable Standards: FCC CFR Title 47 Part 15C (§15.247)

Date of Sample Receipt: 20 Apr., 2023

Date of Test: 21 Apr., to 31 May, 2023

Date of Report Issued: 01 Jun., 2023

Test Result: PASS

Tested by: Lucas Ding **Date:** 01 Jun., 2023
Test Engineer

Reviewed by: Jane **Date:** 01 Jun., 2023
Project Engineer

Approved by: Zhang **Date:** 01 Jun., 2023
Manager

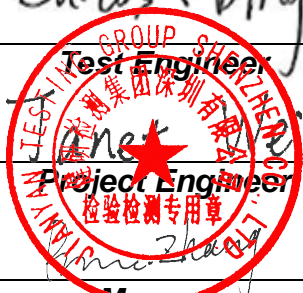

This equipment has been shown to be capable of compliance with the applicable technical standards as indicated in the measurement report and was tested in accordance with the measurement procedures specified in above the application standard version. Test results reported herein relate only to the item(s) tested.

This document cannot be reproduced except in full, without prior written approval of the Company. Any unauthorized alteration, forgery or falsification of the content or appearance of this document is unlawful and offenders may be prosecuted to the fullest extent of the law. Unless otherwise stated the results shown in this test report refer only to the sample(s) tested and such sample(s) are retained for 90 days only.

1 Version

Version No.	Date	Description
00	01 Jun., 2023	Original

2 Contents

	Page
Cover Page	1
1 Version	2
2 Contents	3
3 General Information	4
3.1 Client Information	4
3.2 General Description of E.U.T.	4
3.3 Test Mode and Test Environment	5
3.4 Description of Test Auxiliary Equipment	5
3.5 Measurement Uncertainty	5
3.6 Additions to, Deviations, or Exclusions from the Method	5
3.7 Laboratory Facility	5
3.8 Laboratory Location	5
3.9 Test Instruments List	6
4 Measurement Setup and Procedure	7
4.1 Test Channel	7
4.2 Test Setup	7
4.3 Test Procedure	9
5 Test Results	10
5.1 Summary	10
5.1.1 Clause and Data Summary	10
5.1.2 Test Limit	11
5.2 Antenna requirement	12
5.3 AC Power Line Conducted Emission	13
5.4 Emissions in Restricted Frequency Bands	15
5.5 Emissions in Non-restricted Frequency Bands	47

3 General Information

3.1 Client Information

Applicant:	TECNO MOBILE LIMITED
Address:	FLAT N 16/F BLOCK B UNIVERSAL INDUSTRIAL CENTRE 19-25 SHAN MEI STREET FOTAN NT HONGKONG
Manufacturer:	TECNO MOBILE LIMITED
Address:	FLAT N 16/F BLOCK B UNIVERSAL INDUSTRIAL CENTRE 19-25 SHAN MEI STREET FOTAN NT HONGKONG
Factory:	SHENZHEN TECNO TECHNOLOGY CO., LTD.
Address:	101, Building 24, Waijing Industrial Park, Fumin Community, Fucheng Street, Longhua District, Shenzhen City, P.R.China

3.2 General Description of E.U.T.

Product Name:	Mobile Phone
Model No.:	LH8n
Operation Frequency:	2402 MHz - 2480 MHz
Channel Numbers:	40
Channel Separation:	2MHz
Modulation Technology:	GFSK
Data Speed:	1 Mbps (LE 1M PHY), 2 Mbps (LE 2M PHY), 125 kbps (LE Coded PHY, S=8), 500 kbps (LE Coded PHY, S=2)
Antenna Type:	Internal Antenna
Antenna Gain:	ANT6: -2.2dBi (declare by applicant) ANT7: -3.7dBi (declare by applicant)
Antenna transmit mode:	SISO (2TX, 2RX)
Power Supply:	Rechargeable Li-ion Polymer Battery DC3.87V, 4900mAh
AC Adapter:	Model: U680TSA Input: AC100-240V, 50/60Hz, 2.0A Output: DC 5.0V, 2.0A or 11.0V, 6.2A or 4.0V-21.0V, 3.25A 68.0W MAX
Test Sample Condition:	The test samples were provided in good working order with no visible defects.

3.3 Test Mode and Test Environment

Test Mode:	
Transmitting mode	Keep the EUT in continuous transmitting with modulation
Remark:	
<ol style="list-style-type: none"> For AC power line conducted emission and radiated spurious emission (below 1GHz), pre-scan all data speed, found 1 Mbps (LE 1M PHY) was worse case mode. The report only reflects the test data of worst mode. Channel Low, Mid and High for each type band with rated data rate were chosen for full testing. The field strength of spurious radiation emission was measured as EUT stand-up position (H mode) and lie down position (E1, E2 mode) for these modes. Just the worst case position (H mode) shown in report. 	
Operating Environment:	
Temperature:	15°C ~ 35°C
Humidity:	20 % ~ 75 % RH
Atmospheric Pressure:	1008 mbar

3.4 Description of Test Auxiliary Equipment

The EUT has been tested as an independent unit.

3.5 Measurement Uncertainty

Parameter	Expanded Uncertainty (Confidence of 95%(U = 2Uc(y)))
Conducted Emission for LISN (9kHz ~ 10MHz)	1.9 dB
Conducted Emission for LISN (10MHz ~ 30MHz)	2.6 dB
Radiated Emission (30MHz ~ 1GHz) (3m SAC)	3.8 dB
Radiated Emission (1GHz ~ 18GHz) (3m SAC)	3.6 dB
Radiated Emission (18GHz ~ 40GHz) (3m SAC)	5.34 dB

Note: All the measurement uncertainty value were shown with a coverage k=2 to indicate 95% level of confidence. The measurement data show herein meets or exceeds the CISPR measurement uncertainty values specified in CISPR 16-4-2 and can be compared directly to specified limit to determine compliance.

3.6 Additions to, Deviations, or Exclusions from the Method

No

3.7 Laboratory Facility

The test facility is recognized, certified, or accredited by the following organizations:

- **FCC - Designation No.: CN1211**
JianYan Testing Group Shenzhen Co., Ltd. has been accredited as a testing laboratory by FCC(Federal Communications Commission). The test firm Registration No. is 727551.
- **ISED – CAB identifier.: CN0021**
The 3m Semi-anechoic chamber and 10m Semi-anechoic chamber of JianYan Testing Group Shenzhen Co., Ltd. has been Registered by Certification and Engineering Bureau of Industry Canada for radio equipment testing with Registration No.: 10106A-1.
- **CNAS - Registration No.: CNAS L15527**
JianYan Testing Group Shenzhen Co., Ltd. is accredited to ISO/IEC 17025:2017 General Requirements for the Competence of Testing and Calibration laboratories for the competence of testing. The Registration No. is CNAS L15527.
- **A2LA - Registration No.: 4346.01**
This laboratory is accredited in accordance with the recognized International Standard ISO/IEC 17025:2017 General requirements for the competence of testing and calibration laboratories. The test scope can be found as below link: <https://portal.a2la.org/scopepdf/4346-01.pdf>

3.8 Laboratory Location

JianYan Testing Group Shenzhen Co., Ltd.
 Address: No.101, Building 8, Innovation Wisdom Port, No.155 Hongtian Road, Huangpu Community, Xinqiao Street, Bao'an District, Shenzhen, Guangdong, People's Republic of China.
 Tel: +86-755-23118282, Fax: +86-755-23116366
 Email: info-JYTee@lets.com, Website: <http://jyt.lets.com>

3.9 Test Instruments List

Radiated Emission(3m SAC):					
Test Equipment	Manufacturer	Model No.	Manage No.	Cal. Date (mm-dd-yy)	Cal. Due date (mm-dd-yy)
3m SAC	ETS	9m*6m*6m	WXJ001-1	04-14-2021	04-13-2024
Loop Antenna	Schwarzbeck	FMZB 1519 B	WXJ002-4	02-09-2023	02-08-2024
BiConiLog Antenna	Schwarzbeck	VULB9163	WXJ002	02-09-2023	02-08-2024
Horn Antenna	Schwarzbeck	BBHA9120D	WXJ002-2	02-09-2023	02-08-2024
Horn Antenna	Schwarzbeck	BBHA9170	WXJ002-5	01-09-2023	01-08-2024
Pre-amplifier (30MHz ~ 1GHz)	Schwarzbeck	BBV9743B	WXJ001-2	01-10-2023	01-09-2024
Pre-amplifier (1GHz ~ 18GHz)	SKET	LNPA_0118G-50	WXJ001-3	01-10-2023	01-09-2024
Pre-amplifier (18GHz ~ 40GHz)	RF System	TRLA-180400G45B	WXJ002-7	01-11-2023	01-10-2024
EMI Test Receiver	Rohde & Schwarz	ESRP7	WXJ003-1	01-11-2023	01-10-2024
Spectrum Analyzer	Rohde & Schwarz	FSP 30	WXJ004	01-10-2023	01-09-2024
Spectrum Analyzer	KEYSIGHT	N9010B	WXJ004-2	10-17-2022	10-16-2023
Coaxial Cable (30MHz ~ 1GHz)	JYTSZ	JYT3M-1G-NN-8M	WXG001-4	01-18-2023	01-17-2024
Coaxial Cable (1GHz ~ 18GHz)	JYTSZ	JYT3M-18G-NN-8M	WXG001-5	01-18-2023	01-17-2024
Coaxial Cable (18GHz ~ 40GHz)	JYTSZ	JYT3M-40G-SS-8M	WXG001-7	01-18-2023	01-17-2024
Band Reject Filter Group	Tonscend	JS0806-F	WXJ089	N/A	
Test Software	Tonscend	TS+	Version: 3.0.0.1		

Conducted Emission:					
Test Equipment	Manufacturer	Model No.	Manage No.	Cal. Date (mm-dd-yy)	Cal. Due date (mm-dd-yy)
EMI Test Receiver	Rohde & Schwarz	ESR3	WXJ003-2	07-12-2022	07-11-2023
LISN	Schwarzbeck	NSLK 8127	QCJ001-13	01-10-2023	01-09-2024
LISN	Rohde & Schwarz	ESH3-Z5	WXJ005-1	01-11-2023	01-10-2024
LISN Coaxial Cable (9kHz ~ 30MHz)	JYTSZ	JYTCE-1G-NN-2M	WXG003-1	02-22-2023	02-21-2024
RF Switch	TOP PRECISION	RSU0301	WXG003	N/A	
Test Software	AUDIX	E3	Version: 6.110919b		

Conducted Method:					
Test Equipment	Manufacturer	Model No.	Manage No.	Cal. Date (mm-dd-yy)	Cal. Due date (mm-dd-yy)
Spectrum Analyzer	Keysight	N9010B	WXJ004-3	10-17-2022	10-16-2023
Temperature Humidity Chamber	ZHONG ZHI	CZ-A-80D	WXJ032-3	01-09-2023	01-08-2025
Power Detector Box	MWRFTTEST	MW100-PSB	WXJ007-4	10-17-2022	10-16-2023
DC Power Supply	Keysight	E3642A	WXJ025-2	N/A	
RF Control Unit	MWRFTTEST	MW100-RFCB	WXG006	N/A	
Test Software	MWRFTTEST	MTS 8310	Version: 2.0.0.0		

4 Measurement Setup and Procedure

4.1 Test Channel

According to ANSI C63.10-2013 chapter 5.6.1 Table 4 requirement, select lowest channel, middle channel, and highest channel in the frequency range in which device operates for testing. The detailed frequency points are as follows:

Lowest channel		Middle channel		Highest channel	
Channel No.	Frequency (MHz)	Channel No.	Frequency (MHz)	Channel No.	Frequency (MHz)
0	2402	20	2442	39	2480

4.2 Test Setup

1) Conducted emission measurement:

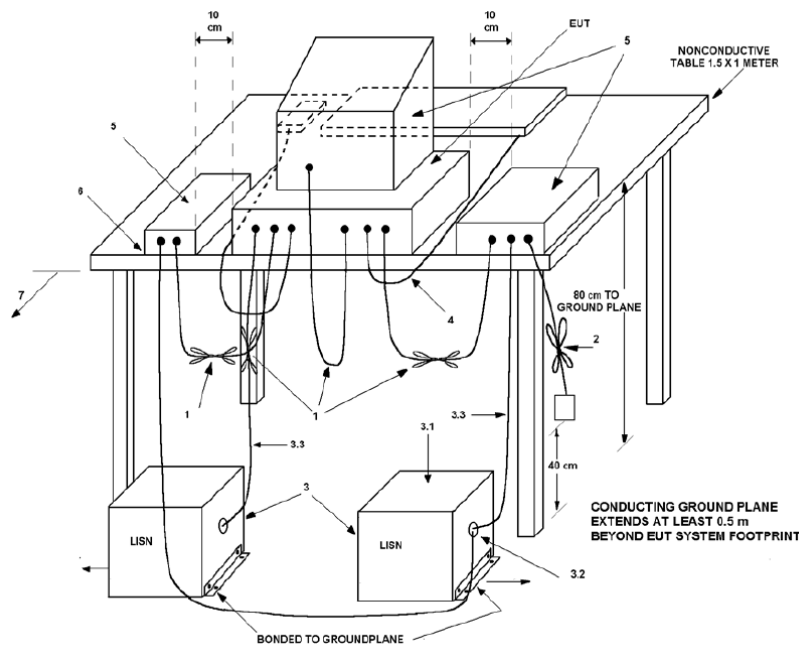

Note: The detailed descriptions please refer to Figure 8 of ANSI C63.4:2014.

2) Radiated emission measurement:

Below 1GHz (3m SAC)

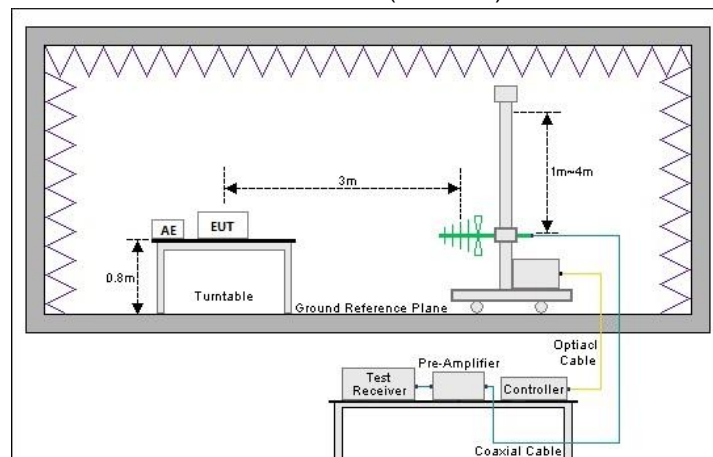

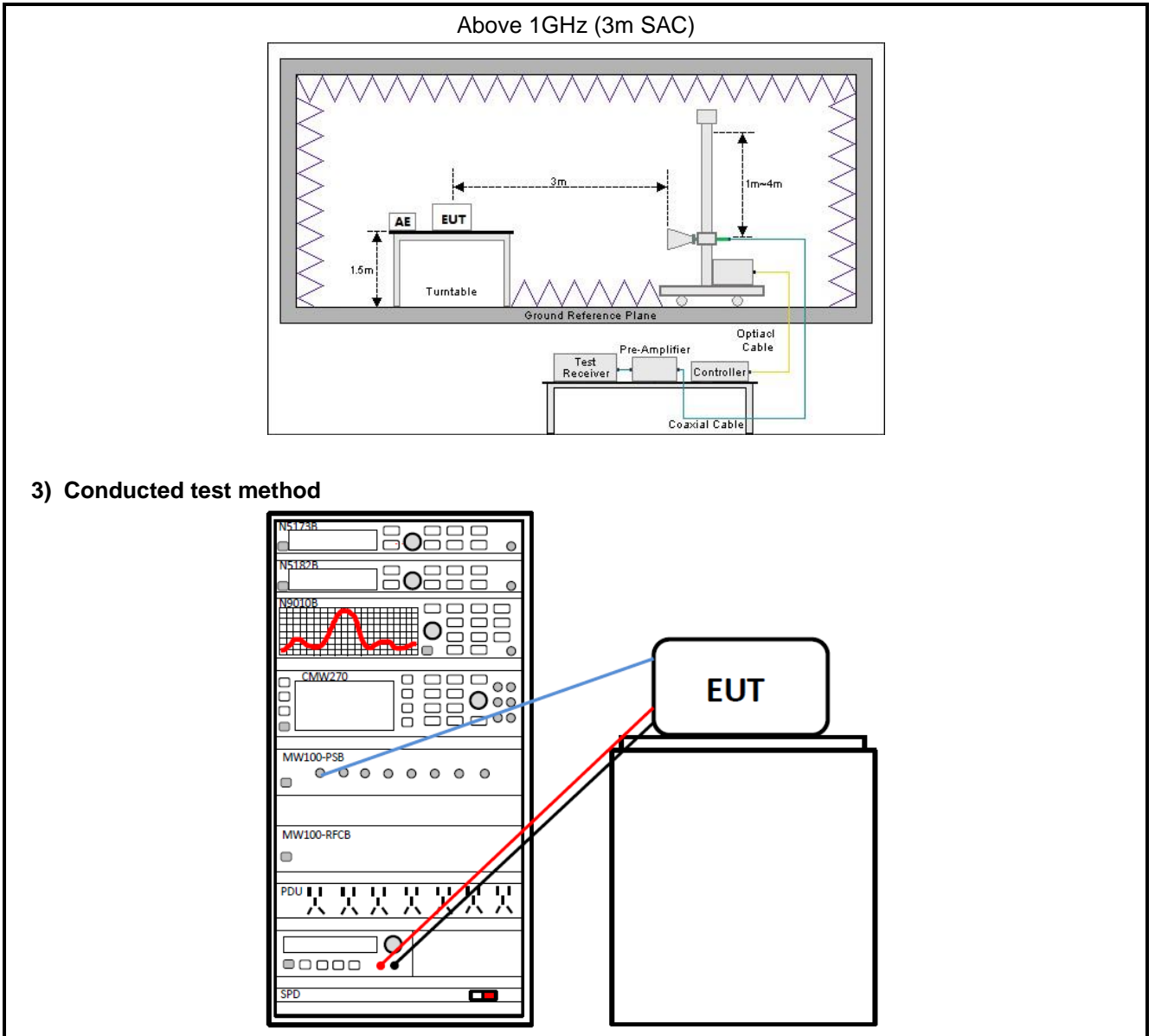

4.3 Test Procedure

Test method	Test step
Conducted emission	<ol style="list-style-type: none"> The E.U.T and simulators are connected to the main power through a line impedance stabilization network (L.I.S.N.). This provides a 50ohm/50uH coupling impedance for the measuring equipment. The peripheral devices are also connected to the main power through a LISN that provides a 50ohm/50uH coupling impedance with 50ohm termination. (Please refer to the block diagram of the test setup and photographs). Both sides of A.C. line are checked for maximum conducted interference. In order to find the maximum emission, the relative positions of equipment and all of the interface cables must be changed according to ANSI C63.10 on conducted measurement.
Radiated emission	<p>For below 1GHz:</p> <ol style="list-style-type: none"> The EUT was placed on the tabletop of a rotating table 0.8 m the ground at a 3 m semi anechoic chamber. The measurement distance from the EUT to the receiving antenna is 3 m. EUT works in each mode of operation that needs to be tested , and having the EUT continuously working, respectively on 3 axis (X, Y & Z) and considered typical configuration to obtain worst position. The highest signal levels relative to the limit shall be determined by rotating the EUT from 0° to 360° and with varying the measurement antenna height between 1 m and 4 m in vertical and horizontal polarizations. Open the test software to control the test antenna and test turntable. Perform the test, save the test results, and export the test data. <p>For above 1GHz:</p> <ol style="list-style-type: none"> The EUT was placed on the tabletop of a rotating table 1.5 m the ground at a 3 m fully anechoic room. The measurement distance from the EUT to the receiving antenna is 3 m. EUT works in each mode of operation that needs to be tested , and having the EUT continuously working, respectively on 3 axis (X, Y & Z) and considered typical configuration to obtain worst position. The highest signal levels relative to the limit shall be determined by rotating the EUT from 0° to 360° and with varying the measurement antenna height between 1 m and 4 m in vertical and horizontal polarizations. Open the test software to control the test antenna and test turntable. Perform the test, save the test results, and export the test data.
Conducted test method	<ol style="list-style-type: none"> The BLE antenna port of EUT was connected to the test port of the test system through an RF cable. The EUT is keeping in continuous transmission mode and tested in all modulation modes. Open the test software, prepare a test plan, and control the system through the software. After the test is completed, the test report is exported through the test software.

5 Test Results

5.1 Summary

5.1.1 Clause and Data Summary

Test items	Standard clause	Test data	Result
Antenna Requirement	15.203 15.247 (b)(4)	See Section 5.2	Pass
AC Power Line Conducted Emission	15.207	See Section 5.3	Pass
Conducted Output Power	15.247 (b)(3)	Appendix A – BLE 1M PHY ANT6 Appendix A – BLE 1M PHY ANT7 Appendix B – BLE 2M PHY ANT6 Appendix B – BLE 2M PHY ANT7 Appendix C – BLE Coded PHY, S=2 ANT6 Appendix C – BLE Coded PHY, S=2 ANT7 Appendix D – BLE Coded PHY, S=8 ANT6 Appendix D – BLE Coded PHY, S=8 ANT7	Pass
6dB Emission Bandwidth 99% Occupied Bandwidth	15.247 (a)(2)		Pass
Power Spectral Density	15.247 (e)		Pass
Band-edge Emission Conduction Spurious Emission	15.247 (d)		Pass
Emissions in Restricted Frequency Bands	15.205 15.247 (d)	See Section 5.4	Pass
Emissions in Non-restricted Frequency Bands	15.209 15.247(d)	See Section 5.5	Pass
Remark: 1. Pass: The EUT complies with the essential requirements in the standard. 2. N/A: Not Applicable. 3. The cable insertion loss used by “RF Output Power” and other conduction measurement items is 0.5dB (provided by the customer).			
Test Method:	ANSI C63.10-2013 KDB 558074 D01 15.247 Meas Guidance v05r02		

5.1.2 Test Limit

Test items	Limit																														
AC Power Line Conducted Emission	<table border="1"> <thead> <tr> <th rowspan="2">Frequency (MHz)</th> <th colspan="2">Limit (dBμV)</th> </tr> <tr> <th>Quasi-Peak</th> <th>Average</th> </tr> </thead> <tbody> <tr> <td>0.15 – 0.5</td> <td>66 to 56 <small>Note 1</small></td> <td>56 to 46 <small>Note 1</small></td> </tr> <tr> <td>0.5 – 5</td> <td>56</td> <td>46</td> </tr> <tr> <td>5 – 30</td> <td>60</td> <td>50</td> </tr> </tbody> </table> <p>Note 1: The limit level in dBμV decreases linearly with the logarithm of frequency. Note 2: The more stringent limit applies at transition frequencies.</p>	Frequency (MHz)	Limit (dB μ V)		Quasi-Peak	Average	0.15 – 0.5	66 to 56 <small>Note 1</small>	56 to 46 <small>Note 1</small>	0.5 – 5	56	46	5 – 30	60	50																
Frequency (MHz)	Limit (dB μ V)																														
	Quasi-Peak	Average																													
0.15 – 0.5	66 to 56 <small>Note 1</small>	56 to 46 <small>Note 1</small>																													
0.5 – 5	56	46																													
5 – 30	60	50																													
Conducted Output Power	For systems using digital modulation in the 902-928 MHz, 2400-2483.5 MHz, and 5725-5850 MHz bands: 1 Watt.																														
6dB Emission Bandwidth	The minimum 6 dB bandwidth shall be at least 500 kHz.																														
99% Occupied Bandwidth	N/A																														
Power Spectral Density	For digitally modulated systems, the power spectral density conducted from the intentional radiator to the antenna shall not be greater than 8 dBm in any 3 kHz band during any time interval of continuous transmission.																														
Band-edge Emission Conduction Spurious Emission	In any 100 kHz bandwidth outside the frequency band in which the spread spectrum or digitally modulated intentional radiator is operating, the radio frequency power that is produced by the intentional radiator shall be at least 20 dB below that in the 100 kHz bandwidth within the band that contains the highest level of the desired power, based on either an RF conducted or a radiated measurement, provided the transmitter demonstrates compliance with the peak conducted power limits. If the transmitter complies with the conducted power limits based on the use of RMS averaging over a time interval, as permitted under paragraph (b)(3) of this section, the attenuation required under this paragraph shall be 30 dB instead of 20 dB. Attenuation below the general limits specified in §15.209(a) is not required. In addition, radiated emissions which fall in the restricted bands, as defined in §15.205(a), must also comply with the radiated emission limits specified in §15.209(a) (see §15.205(c)).																														
Emissions in Restricted Frequency Bands Emissions in Non-restricted Frequency Bands	<table border="1"> <thead> <tr> <th rowspan="2">Frequency (MHz)</th> <th colspan="2">Limit (dBμV/m)</th> <th rowspan="2">Detector</th> </tr> <tr> <th>@ 3m</th> <th>@ 10m</th> </tr> </thead> <tbody> <tr> <td>30 – 88</td> <td>40.0</td> <td>30.0</td> <td>Quasi-peak</td> </tr> <tr> <td>88 – 216</td> <td>43.5</td> <td>33.5</td> <td>Quasi-peak</td> </tr> <tr> <td>216 – 960</td> <td>46.0</td> <td>36.0</td> <td>Quasi-peak</td> </tr> <tr> <td>960 – 1000</td> <td>54.0</td> <td>44.0</td> <td>Quasi-peak</td> </tr> </tbody> </table> <p>Note: The more stringent limit applies at transition frequencies.</p> <table border="1"> <thead> <tr> <th rowspan="2">Frequency</th> <th colspan="2">Limit (dBμV/m) @ 3m</th> </tr> <tr> <th>Average</th> <th>Peake</th> </tr> </thead> <tbody> <tr> <td>Above 1 GHz</td> <td>54.0</td> <td>74.0</td> </tr> </tbody> </table> <p>Note: The measurement bandwidth shall be 1 MHz or greater.</p>	Frequency (MHz)	Limit (dB μ V/m)		Detector	@ 3m	@ 10m	30 – 88	40.0	30.0	Quasi-peak	88 – 216	43.5	33.5	Quasi-peak	216 – 960	46.0	36.0	Quasi-peak	960 – 1000	54.0	44.0	Quasi-peak	Frequency	Limit (dB μ V/m) @ 3m		Average	Peake	Above 1 GHz	54.0	74.0
Frequency (MHz)	Limit (dB μ V/m)		Detector																												
	@ 3m	@ 10m																													
30 – 88	40.0	30.0	Quasi-peak																												
88 – 216	43.5	33.5	Quasi-peak																												
216 – 960	46.0	36.0	Quasi-peak																												
960 – 1000	54.0	44.0	Quasi-peak																												
Frequency	Limit (dB μ V/m) @ 3m																														
	Average	Peake																													
Above 1 GHz	54.0	74.0																													

5.2 Antenna requirement

Standard requirement:	FCC Part 15 C Section 15.203 /247(b)(4)
<p>15.203 requirement: An intentional radiator shall be designed to ensure that no antenna other than that furnished by the responsible party shall be used with the device. The use of a permanently attached antenna or of an antenna that uses a unique coupling to the intentional radiator, the manufacturer may design the unit so that a broken antenna can be replaced by the user, but the use of a standard antenna jack or electrical connector is prohibited.</p> <p>15.247(b) (4) requirement: (4) The conducted output power limit specified in paragraph (b) of this section is based on the use of antennas with directional gains that do not exceed 6 dBi. Except as shown in paragraph (c) of this section, if transmitting antennas of directional gain greater than 6 dBi are used, the conducted output power from the intentional radiator shall be reduced below the stated values in paragraphs (b)(1), (b)(2), and (b)(3) of this section, as appropriate, by the amount in dB that the directional gain of the antenna exceeds 6 dBi.</p>	
E.U.T Antenna:	
The BLE antenna is an Internal antenna which cannot replace by end-user, the best case gain of the antenna 6 is -2.2 dBi and the antenna 7 is -3.7 dBi. See product internal photos for details.	

5.3 AC Power Line Conducted Emission

Product name:	Mobile Phone	Product model:	LH8n
Test by:	Lucas	Test mode:	BLE Tx (LE 1M PHY)
Test frequency:	150 kHz ~ 30 MHz	Phase:	Line
Test voltage:	AC 120 V/60 Hz		

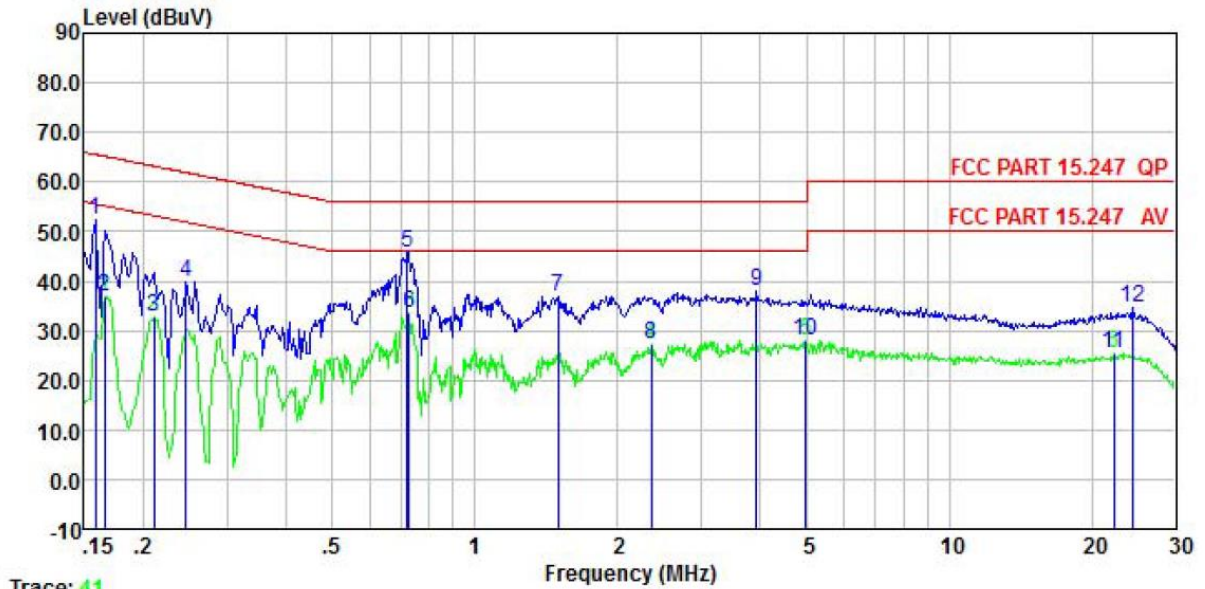

	Freq	Read Level	LISN Factor	Aux2 Factor	Cable Loss	Level	Limit Line	Over Limit	Remark
	MHz	dBuV	dB	dB	dB	dBuV	dBuV	dB	
1	0.158	41.79	0.04	10.50	0.01	52.34	65.56	-13.22	QP
2	0.166	26.36	0.04	10.50	0.01	36.91	55.16	-18.25	Average
3	0.211	22.10	0.05	10.50	0.03	32.68	53.18	-20.50	Average
4	0.246	29.24	0.06	10.50	0.01	39.81	61.91	-22.10	QP
5	0.720	35.15	0.07	10.50	0.03	45.75	56.00	-10.25	QP
6	0.727	23.11	0.07	10.50	0.03	33.71	46.00	-12.29	Average
7	1.495	26.32	0.08	10.50	0.14	37.04	56.00	-18.96	QP
8	2.358	16.62	0.08	10.50	0.15	27.35	46.00	-18.65	Average
9	3.922	27.30	0.11	10.50	0.08	37.99	56.00	-18.01	QP
10	4.978	17.48	0.12	10.50	0.09	28.19	46.00	-17.81	Average
11	22.298	14.55	0.36	10.50	0.16	25.57	50.00	-24.43	Average
12	24.271	23.56	0.37	10.50	0.18	34.61	60.00	-25.39	QP

Remark:

1. Level = Read level + LISN Factor + Cable Loss.

Product name:	Mobile Phone	Product model:	LH8n
Test by:	Lucas	Test mode:	BLE Tx (LE 1M PHY)
Test frequency:	150 kHz ~ 30 MHz	Phase:	Neutral
Test voltage:	AC 120 V/60 Hz		

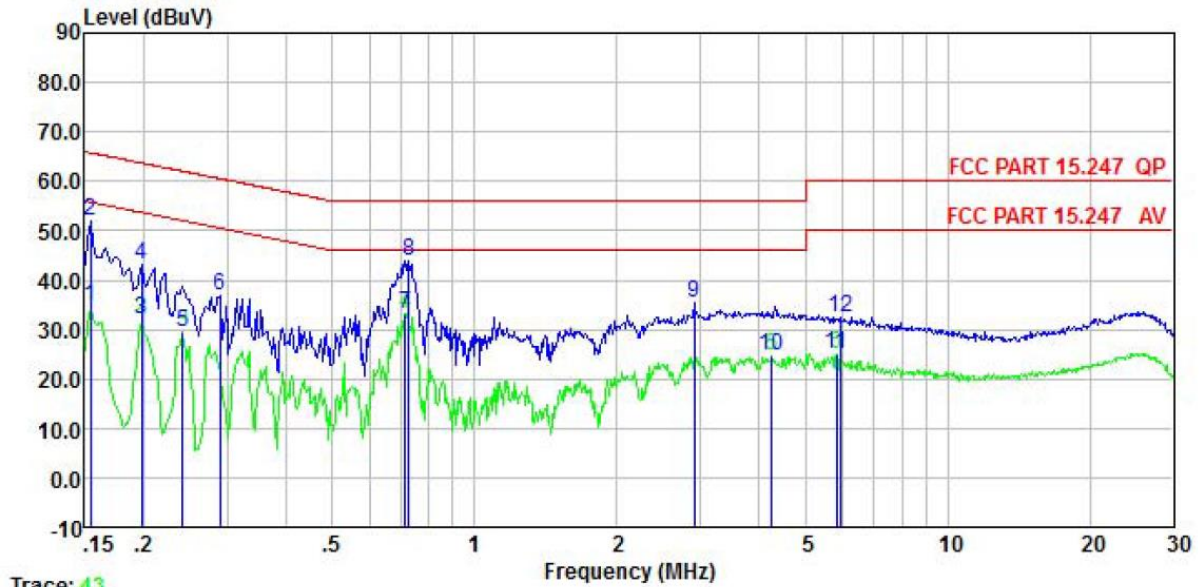

	Freq	Read Level	LISN Factor	Aux2 Factor	Cable Loss	Level	Limit Line	Over Limit	Remark
	MHz	dBuV	dB	dB	dB	dBuV	dBuV	dB	
1	0.154	24.05	0.06	10.50	0.01	34.62	55.78	-21.16	Average
2	0.154	41.37	0.06	10.50	0.01	51.94	65.78	-13.84	QP
3	0.198	21.36	0.05	10.50	0.04	31.95	53.71	-21.76	Average
4	0.198	32.41	0.05	10.50	0.04	43.00	63.71	-20.71	QP
5	0.242	18.80	0.05	10.50	0.01	29.36	52.04	-22.68	Average
6	0.289	26.38	0.05	10.50	0.03	36.96	60.54	-23.58	QP
7	0.712	22.75	0.06	10.50	0.03	33.34	46.00	-12.66	Average
8	0.727	33.29	0.06	10.50	0.03	43.88	56.00	-12.12	QP
9	2.915	24.63	0.09	10.50	0.08	35.30	56.00	-20.70	QP
10	4.247	13.85	0.10	10.50	0.08	24.53	46.00	-21.47	Average
11	5.836	14.29	0.13	10.50	0.09	25.01	50.00	-24.99	Average
12	5.929	21.74	0.13	10.50	0.09	32.46	60.00	-27.54	QP

Remark:

1. Level = Read level + LISN Factor + Cable Loss.

5.4 Emissions in Restricted Frequency Bands

ANT6:

Product Name:	Mobile Phone	Product Model:	LH8n
Test By:	Lucas	Test mode:	BLE Tx (LE 1M PHY)
Test Channel:	Lowest channel	Polarization:	Vertical
Test Voltage:	DC 3.87V		

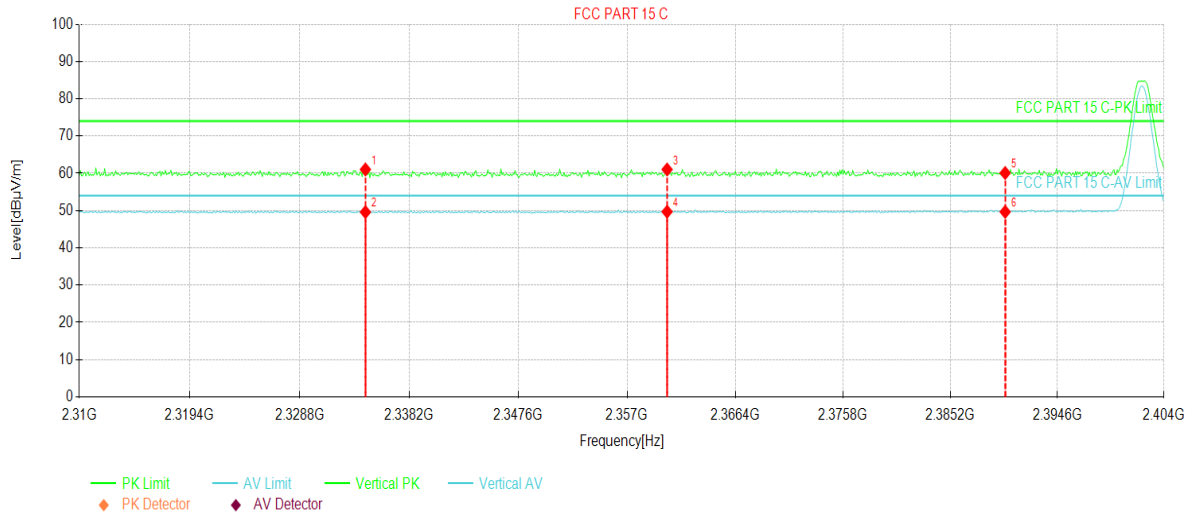

Suspected Data List

NO.	Freq. [MHz]	Reading [dBµV/m]	Level [dBµV/m]	Factor [dB]	Limit [dBµV/m]	Margin [dB]	Trace	Polarity
1	2334.44	25.22	61.03	35.81	74.00	12.97	PK	Vertical
2	2334.44	13.78	49.59	35.81	54.00	4.41	AV	Vertical
3	2360.47	25.03	61.02	35.99	74.00	12.98	PK	Vertical
4	2360.47	13.71	49.70	35.99	54.00	4.30	AV	Vertical
5	2390.00	23.80	60.08	36.28	74.00	13.92	PK	Vertical
6	2390.00	13.38	49.66	36.28	54.00	4.34	AV	Vertical

Remark:

1. Level = Reading + Factor(Antenna Factor + Cable Loss – Preamplifier Factor).

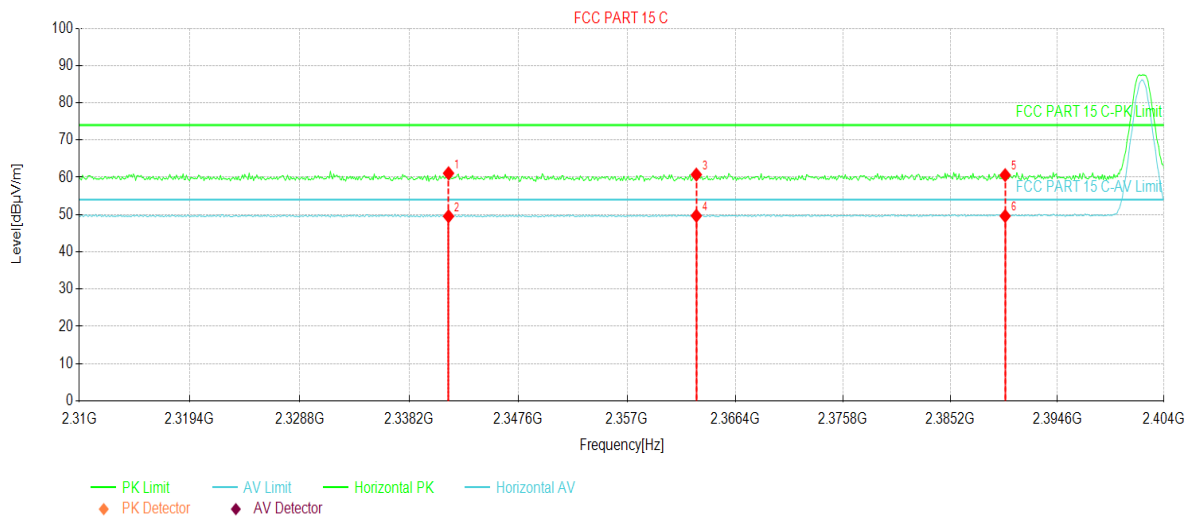
Product Name:	Mobile Phone	Product Model:	LH8n
Test By:	Lucas	Test mode:	BLE Tx (LE 1M PHY)
Test Channel:	Lowest channel	Polarization:	Horizontal
Test Voltage:	DC 3.87V		



Suspected Data List								
NO.	Freq. [MHz]	Reading [dBµV/m]	Level [dBµV/m]	Factor [dB]	Limit [dBµV/m]	Margin [dB]	Trace	Polarity
1	2341.58	25.23	61.08	35.85	74.00	12.92	PK	Horizontal
2	2341.58	13.69	49.54	35.85	54.00	4.46	AV	Horizontal
3	2363.01	24.71	60.73	36.02	74.00	13.27	PK	Horizontal
4	2363.01	13.66	49.68	36.02	54.00	4.32	AV	Horizontal
5	2390.00	24.31	60.59	36.28	74.00	13.41	PK	Horizontal
6	2390.00	13.33	49.61	36.28	54.00	4.39	AV	Horizontal

Remark:

1. Level = Reading + Factor(Antenna Factor + Cable Loss – Pre-amplifier Factor).

Product Name:	Mobile Phone	Product Model:	LH8n
Test By:	Lucas	Test mode:	BLE Tx (LE 1M PHY)
Test Channel:	Highest channel	Polarization:	Vertical
Test Voltage:	DC 3.87V		

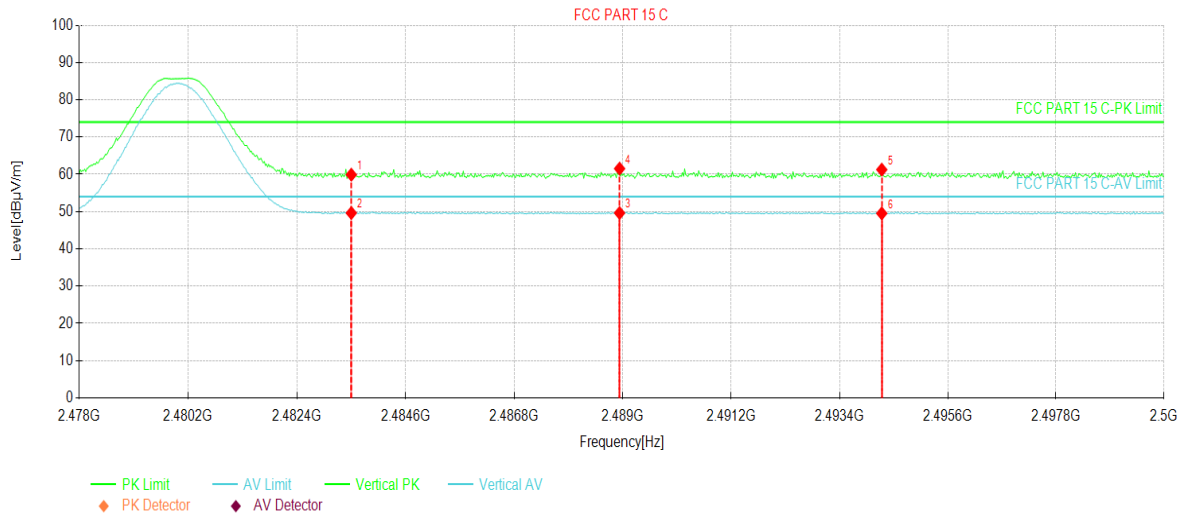

Suspected Data List								
NO.	Freq. [MHz]	Reading [dBµV/m]	Level [dBµV/m]	Factor [dB]	Limit [dBµV/m]	Margin [dB]	Trace	Polarity
1	2483.50	23.56	59.90	36.34	74.00	14.10	PK	Vertical
2	2483.50	13.28	49.62	36.34	54.00	4.38	AV	Vertical
3	2488.93	13.30	49.62	36.32	54.00	4.38	AV	Vertical
4	2488.93	25.20	61.52	36.32	74.00	12.48	PK	Vertical
5	2494.25	24.95	61.25	36.30	74.00	12.75	PK	Vertical
6	2494.25	13.21	49.51	36.30	54.00	4.49	AV	Vertical

Remark:

1. Level = Reading + Factor(Antenna Factor + Cable Loss – Pre-amplifier Factor).

Product Name:	Mobile Phone	Product Model:	LH8n
Test By:	Lucas	Test mode:	BLE Tx (LE 1M PHY)
Test Channel:	Highest channel	Polarization:	Horizontal
Test Voltage:	DC 3.87V		

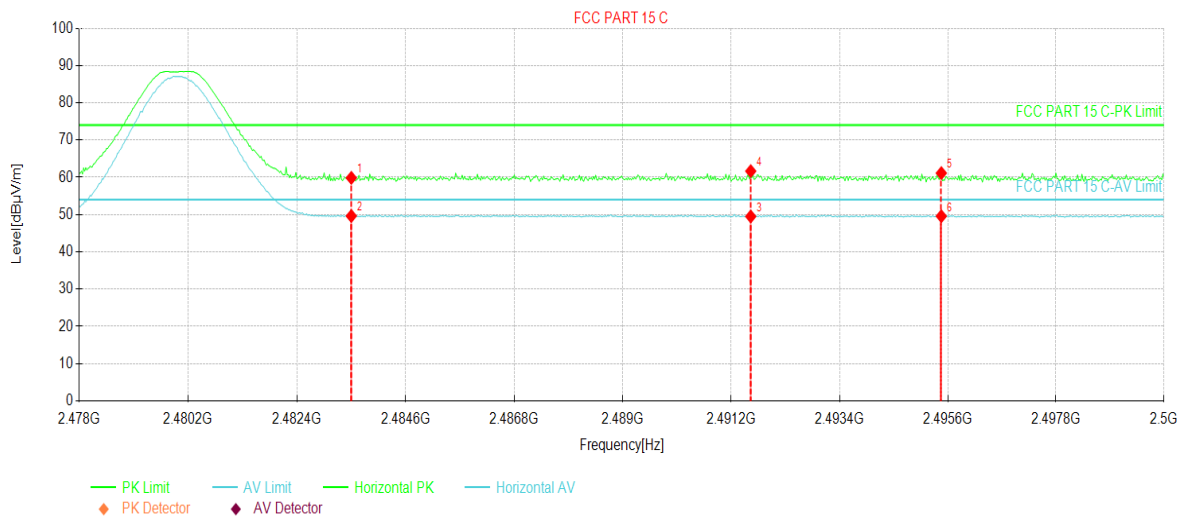

Suspected Data List								
NO.	Freq. [MHz]	Reading [dBµV/m]	Level [dBµV/m]	Factor [dB]	Limit [dBµV/m]	Margin [dB]	Trace	Polarity
1	2483.50	23.51	59.85	36.34	74.00	14.15	PK	Horizontal
2	2483.50	13.28	49.62	36.34	54.00	4.38	AV	Horizontal
3	2491.59	13.18	49.49	36.31	54.00	4.51	AV	Horizontal
4	2491.59	25.34	61.65	36.31	74.00	12.35	PK	Horizontal
5	2495.46	24.82	61.12	36.30	74.00	12.88	PK	Horizontal
6	2495.46	13.26	49.56	36.30	54.00	4.44	AV	Horizontal

Remark:

1. Level = Reading + Factor(Antenna Factor + Cable Loss – Pre-amplifier Factor).

Product Name:	Mobile Phone	Product Model:	LH8n
Test By:	Lucas	Test mode:	BLE Tx (LE 2M PHY)
Test Channel:	Lowest channel	Polarization:	Vertical
Test Voltage:	DC 3.87V		

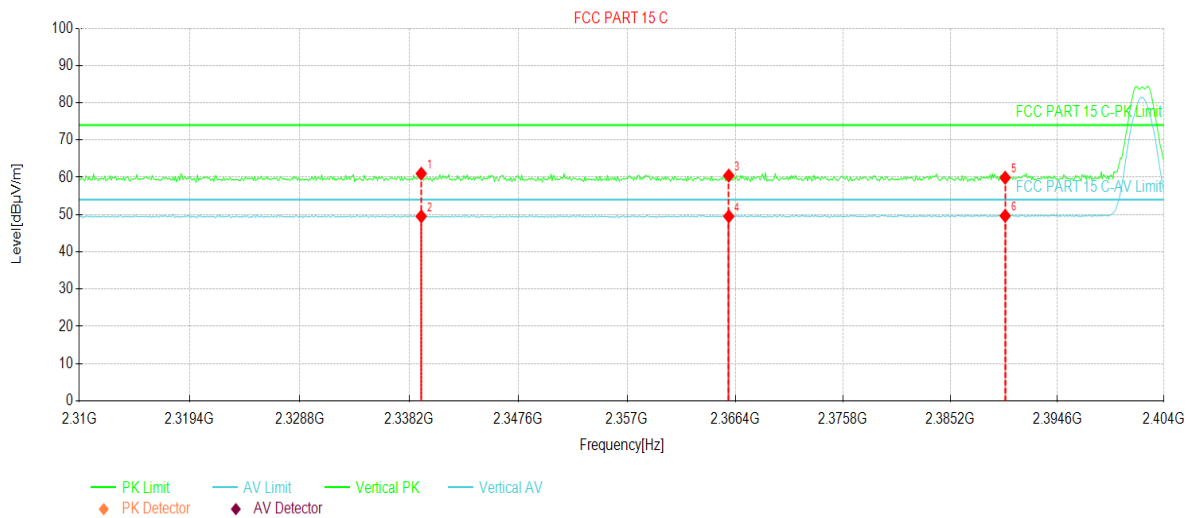

Suspected Data List								
NO.	Freq. [MHz]	Reading [dBµV/m]	Level [dBµV/m]	Factor [dB]	Limit [dBµV/m]	Margin [dB]	Trace	Polarity
1	2339.23	25.15	60.99	35.84	74.00	13.01	PK	Vertical
2	2339.23	13.68	49.52	35.84	54.00	4.48	AV	Vertical
3	2365.83	24.41	60.46	36.05	74.00	13.54	PK	Vertical
4	2365.83	13.47	49.52	36.05	54.00	4.48	AV	Vertical
5	2390.00	23.61	59.89	36.28	74.00	14.11	PK	Vertical
6	2390.00	13.37	49.65	36.28	54.00	4.35	AV	Vertical

Remark:

1. Level = Reading + Factor(Antenna Factor + Cable Loss – Preamplifier Factor).

Product Name:	Mobile Phone	Product Model:	LH8n
Test By:	Lucas	Test mode:	BLE Tx (LE 2M PHY)
Test Channel:	Lowest channel	Polarization:	Horizontal
Test Voltage:	DC 3.87V		

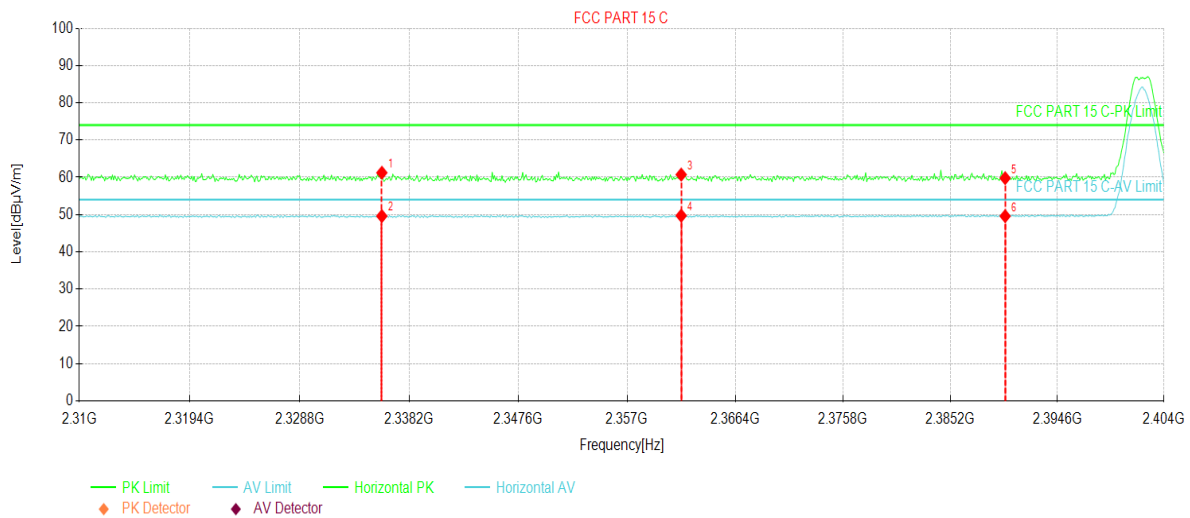

Suspected Data List								
NO.	Freq. [MHz]	Reading [dBµV/m]	Level [dBµV/m]	Factor [dB]	Limit [dBµV/m]	Margin [dB]	Trace	Polarity
1	2335.85	25.40	61.22	35.82	74.00	12.78	PK	Horizontal
2	2335.85	13.77	49.59	35.82	54.00	4.41	AV	Horizontal
3	2361.70	24.71	60.72	36.01	74.00	13.28	PK	Horizontal
4	2361.70	13.69	49.70	36.01	54.00	4.30	AV	Horizontal
5	2390.00	23.49	59.77	36.28	74.00	14.23	PK	Horizontal
6	2390.00	13.29	49.57	36.28	54.00	4.43	AV	Horizontal

Remark:

1. Level = Reading + Factor(Antenna Factor + Cable Loss – Preamplifier Factor).

Product Name:	Mobile Phone	Product Model:	LH8n
Test By:	Lucas	Test mode:	BLE Tx (LE 2M PHY)
Test Channel:	Highest channel	Polarization:	Vertical
Test Voltage:	DC 3.87V		

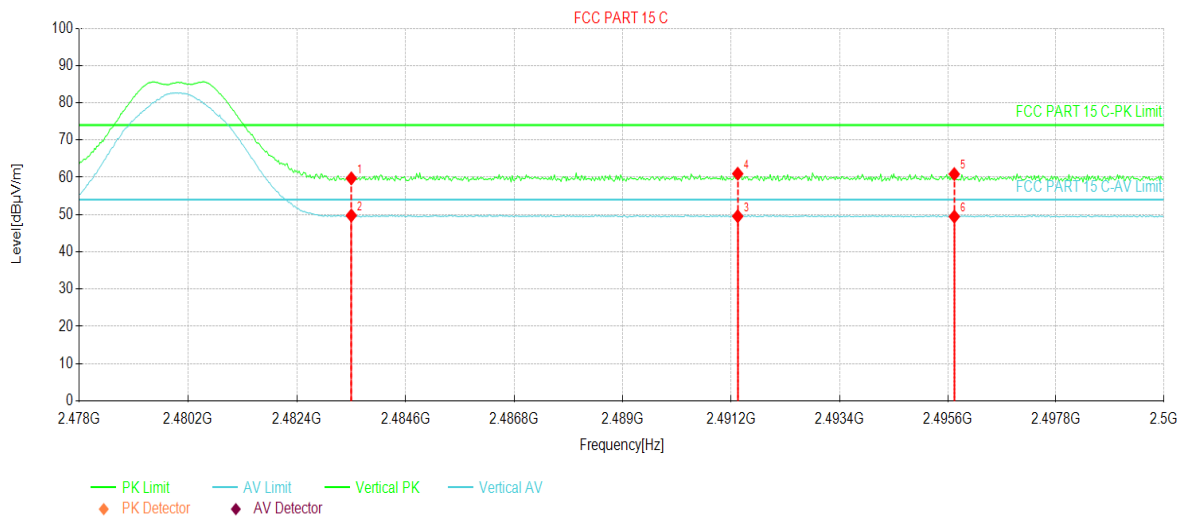

Suspected Data List								
NO.	Freq. [MHz]	Reading [dBµV/m]	Level [dBµV/m]	Factor [dB]	Limit [dBµV/m]	Margin [dB]	Trace	Polarity
1	2483.50	23.37	59.71	36.34	74.00	14.29	PK	Vertical
2	2483.50	13.41	49.75	36.34	54.00	4.25	AV	Vertical
3	2491.33	13.23	49.54	36.31	54.00	4.46	AV	Vertical
4	2491.33	24.65	60.96	36.31	74.00	13.04	PK	Vertical
5	2495.73	24.56	60.86	36.30	74.00	13.14	PK	Vertical
6	2495.73	13.16	49.46	36.30	54.00	4.54	AV	Vertical

Remark:

1. Level = Reading + Factor(Antenna Factor + Cable Loss – Pre-amplifier Factor).

Product Name:	Mobile Phone	Product Model:	LH8n
Test By:	Lucas	Test mode:	BLE Tx (LE 2M PHY)
Test Channel:	Highest channel	Polarization:	Horizontal
Test Voltage:	DC 3.87V		

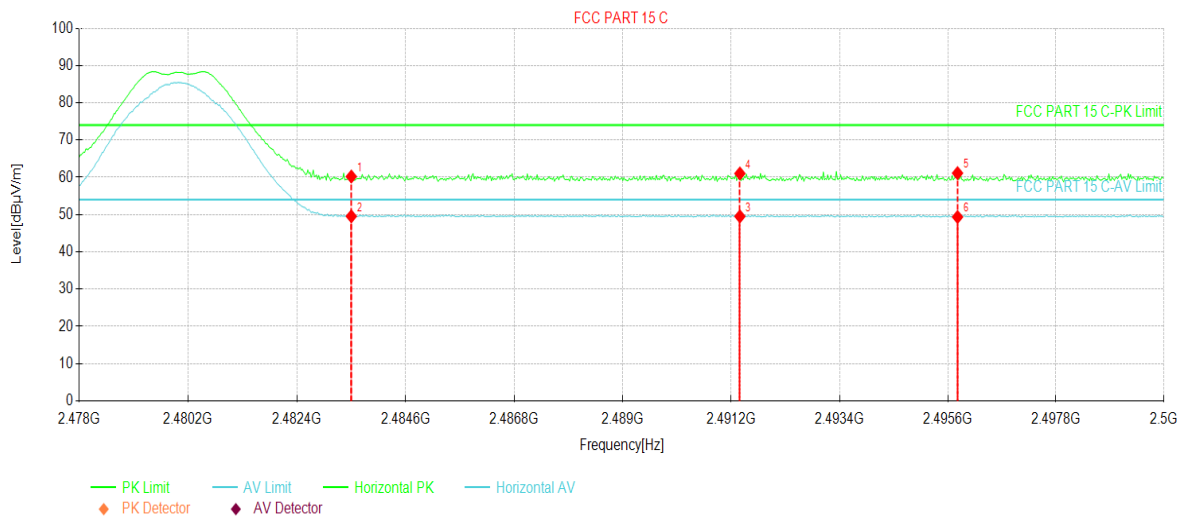

Suspected Data List								
NO.	Freq. [MHz]	Reading [dBµV/m]	Level [dBµV/m]	Factor [dB]	Limit [dBµV/m]	Margin [dB]	Trace	Polarity
1	2483.50	23.86	60.20	36.34	74.00	13.80	PK	Horizontal
2	2483.50	13.19	49.53	36.34	54.00	4.47	AV	Horizontal
3	2491.37	13.20	49.51	36.31	54.00	4.49	AV	Horizontal
4	2491.37	24.71	61.02	36.31	74.00	12.98	PK	Horizontal
5	2495.79	24.82	61.12	36.30	74.00	12.88	PK	Horizontal
6	2495.79	13.04	49.34	36.30	54.00	4.66	AV	Horizontal

Remark:

1. Level = Reading + Factor(Antenna Factor + Cable Loss – Pre-amplifier Factor).

Product Name:	Mobile Phone	Product Model:	LH8n
Test By:	Lucas	Test mode:	BLE Tx (LE Coded PHY, S=2)
Test Channel:	Lowest channel	Polarization:	Vertical
Test Voltage:	DC 3.87V		

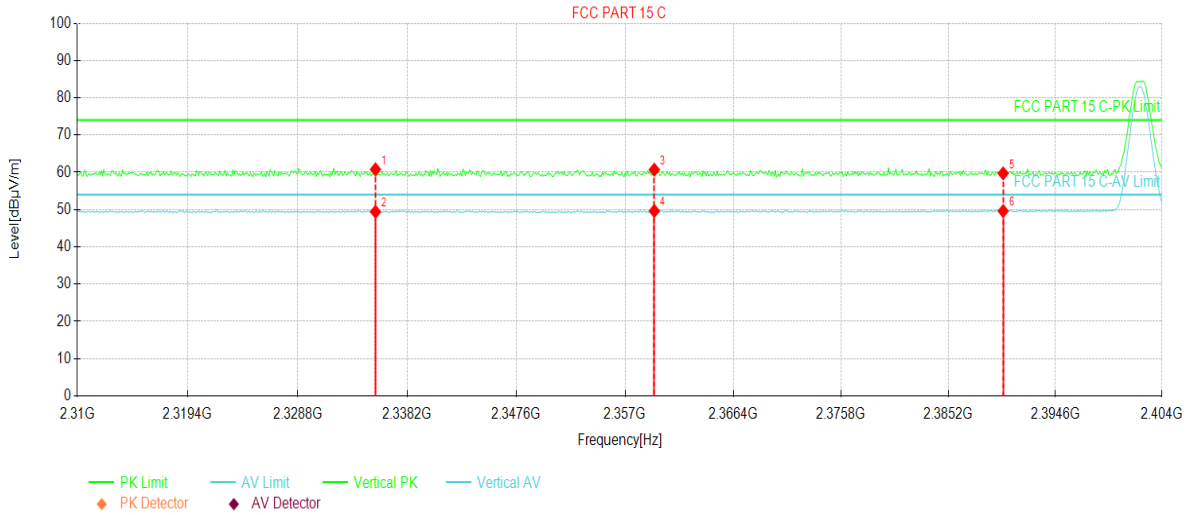

Suspected Data List								
NO.	Freq. [MHz]	Reading [dBµV/m]	Level [dBµV/m]	Factor [dB]	Limit [dBµV/m]	Margin [dB]	Trace	Polarity
1	2335.47	24.97	60.79	35.82	74.00	13.21	PK	Vertical
2	2335.47	13.58	49.40	35.82	54.00	4.60	AV	Vertical
3	2359.53	24.71	60.70	35.99	74.00	13.30	PK	Vertical
4	2359.53	13.63	49.62	35.99	54.00	4.38	AV	Vertical
5	2390.00	23.44	59.72	36.28	74.00	14.28	PK	Vertical
6	2390.00	13.33	49.61	36.28	54.00	4.39	AV	Vertical

Remark:

1. Level = Reading + Factor(Antenna Factor + Cable Loss – Preamplifier Factor).

Product Name:	Mobile Phone	Product Model:	LH8n
Test By:	Lucas	Test mode:	BLE Tx (LE Coded PHY, S=2)
Test Channel:	Lowest channel	Polarization:	Horizontal
Test Voltage:	DC 3.87V		

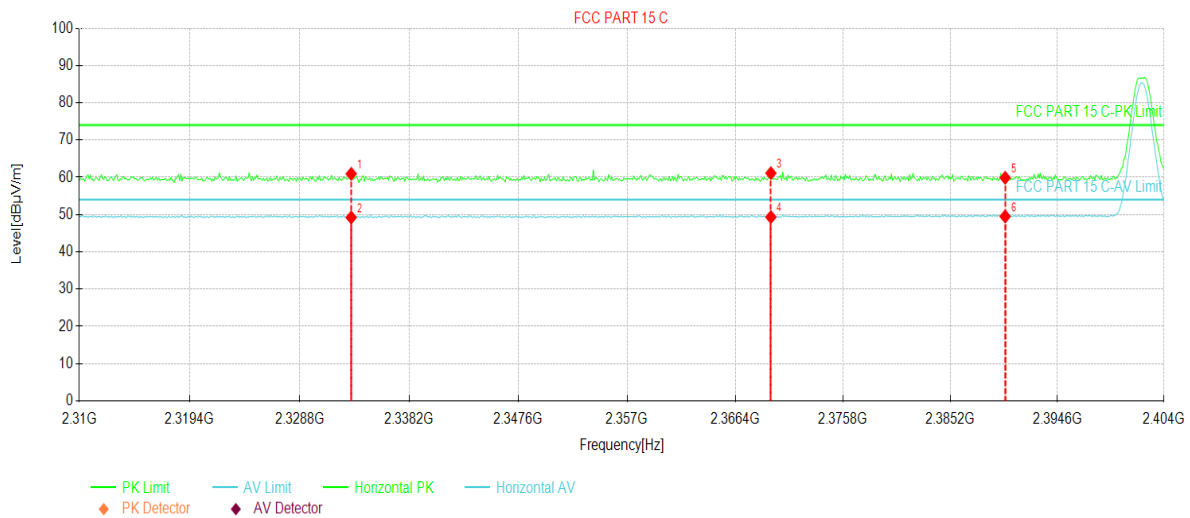

Suspected Data List								
NO.	Freq. [MHz]	Reading [dBµV/m]	Level [dBµV/m]	Factor [dB]	Limit [dBµV/m]	Margin [dB]	Trace	Polarity
1	2333.21	25.12	60.92	35.80	74.00	13.08	PK	Horizontal
2	2333.21	13.42	49.22	35.80	54.00	4.78	AV	Horizontal
3	2369.50	25.04	61.12	36.08	74.00	12.88	PK	Horizontal
4	2369.50	13.25	49.33	36.08	54.00	4.67	AV	Horizontal
5	2390.00	23.59	59.87	36.28	74.00	14.13	PK	Horizontal
6	2390.00	13.21	49.49	36.28	54.00	4.51	AV	Horizontal

Remark:

1. Level = Reading + Factor(Antenna Factor + Cable Loss – Preamplifier Factor).

Product Name:	Mobile Phone	Product Model:	LH8n
Test By:	Lucas	Test mode:	BLE Tx (LE Coded PHY, S=2)
Test Channel:	Highest channel	Polarization:	Vertical
Test Voltage:	DC 3.87V		

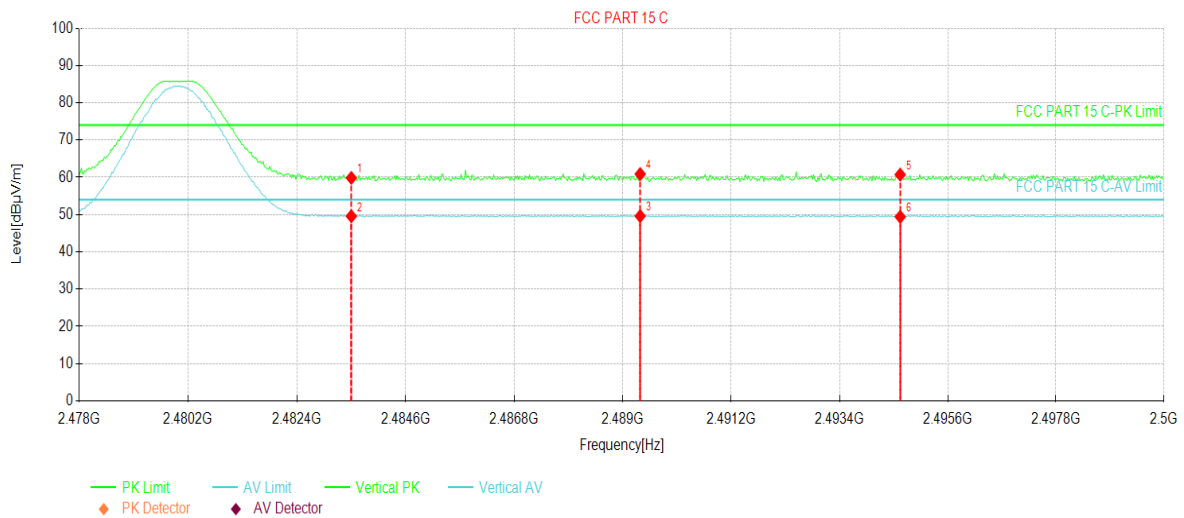

Suspected Data List								
NO.	Freq. [MHz]	Reading [dBµV/m]	Level [dBµV/m]	Factor [dB]	Limit [dBµV/m]	Margin [dB]	Trace	Polarity
1	2483.50	23.49	59.83	36.34	74.00	14.17	PK	Vertical
2	2483.50	13.23	49.57	36.34	54.00	4.43	AV	Vertical
3	2489.35	13.28	49.60	36.32	54.00	4.40	AV	Vertical
4	2489.35	24.55	60.87	36.32	74.00	13.13	PK	Vertical
5	2494.63	24.42	60.72	36.30	74.00	13.28	PK	Vertical
6	2494.63	13.09	49.39	36.30	54.00	4.61	AV	Vertical

Remark:

1. Level = Reading + Factor(Antenna Factor + Cable Loss – Pre-amplifier Factor).

Product Name:	Mobile Phone	Product Model:	LH8n
Test By:	Lucas	Test mode:	BLE Tx (LE Coded PHY, S=2)
Test Channel:	Highest channel	Polarization:	Horizontal
Test Voltage:	DC 3.87V		

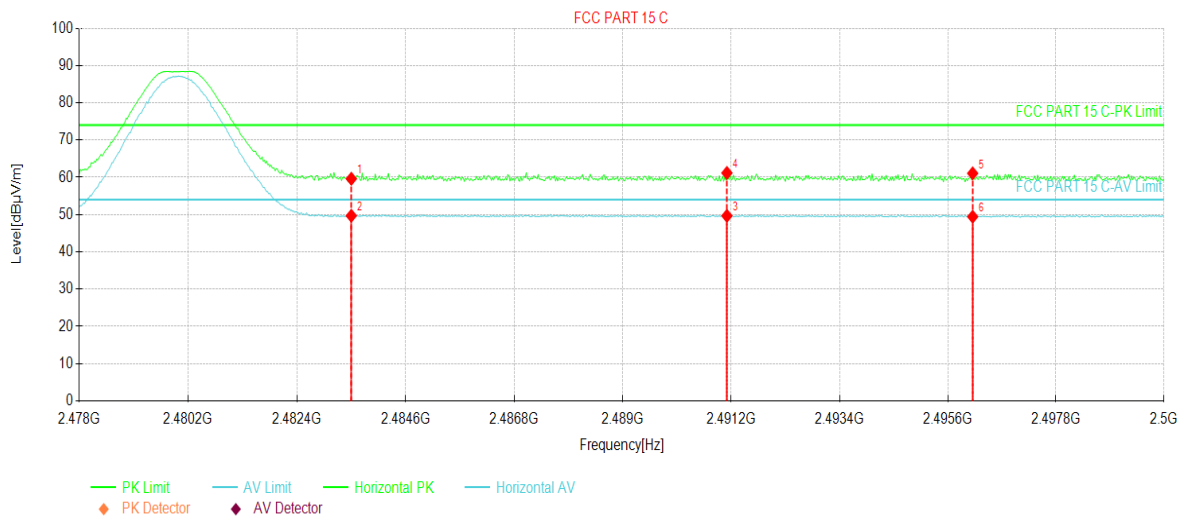

Suspected Data List								
NO.	Freq. [MHz]	Reading [dBµV/m]	Level [dBµV/m]	Factor [dB]	Limit [dBµV/m]	Margin [dB]	Trace	Polarity
1	2483.50	23.27	59.61	36.34	74.00	14.39	PK	Horizontal
2	2483.50	13.34	49.68	36.34	54.00	4.32	AV	Horizontal
3	2491.11	13.35	49.66	36.31	54.00	4.34	AV	Horizontal
4	2491.11	24.85	61.16	36.31	74.00	12.84	PK	Horizontal
5	2496.10	24.77	61.07	36.30	74.00	12.93	PK	Horizontal
6	2496.10	13.13	49.43	36.30	54.00	4.57	AV	Horizontal

Remark:

1. Level = Reading + Factor(Antenna Factor + Cable Loss – Pre-amplifier Factor).

Product Name:	Mobile Phone	Product Model:	LH8n
Test By:	Lucas	Test mode:	BLE Tx (LE Coded PHY, S=8)
Test Channel:	Lowest channel	Polarization:	Vertical
Test Voltage:	DC 3.87V		

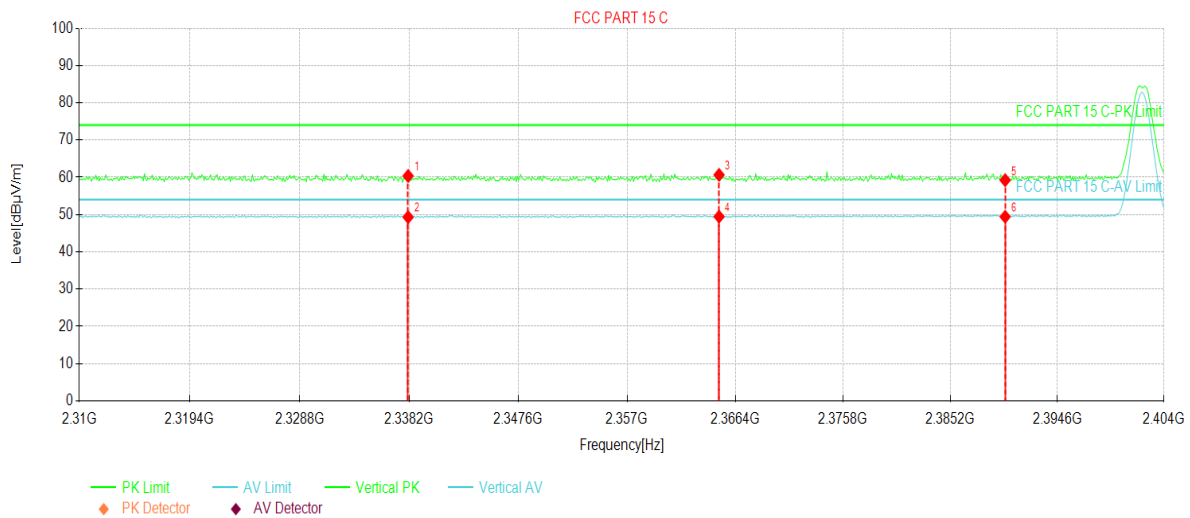

Suspected Data List								
NO.	Freq. [MHz]	Reading [dBµV/m]	Level [dBµV/m]	Factor [dB]	Limit [dBµV/m]	Margin [dB]	Trace	Polarity
1	2338.10	24.54	60.37	35.83	74.00	13.63	PK	Vertical
2	2338.10	13.49	49.32	35.83	54.00	4.68	AV	Vertical
3	2364.99	24.62	60.66	36.04	74.00	13.34	PK	Vertical
4	2364.99	13.41	49.45	36.04	54.00	4.55	AV	Vertical
5	2390.00	22.95	59.23	36.28	74.00	14.77	PK	Vertical
6	2390.00	13.13	49.41	36.28	54.00	4.59	AV	Vertical

Remark:

1. Level = Reading + Factor(Antenna Factor + Cable Loss – Preamplifier Factor).

Product Name:	Mobile Phone	Product Model:	LH8n
Test By:	Lucas	Test mode:	BLE Tx (LE Coded PHY, S=8)
Test Channel:	Lowest channel	Polarization:	Horizontal
Test Voltage:	DC 3.87V		

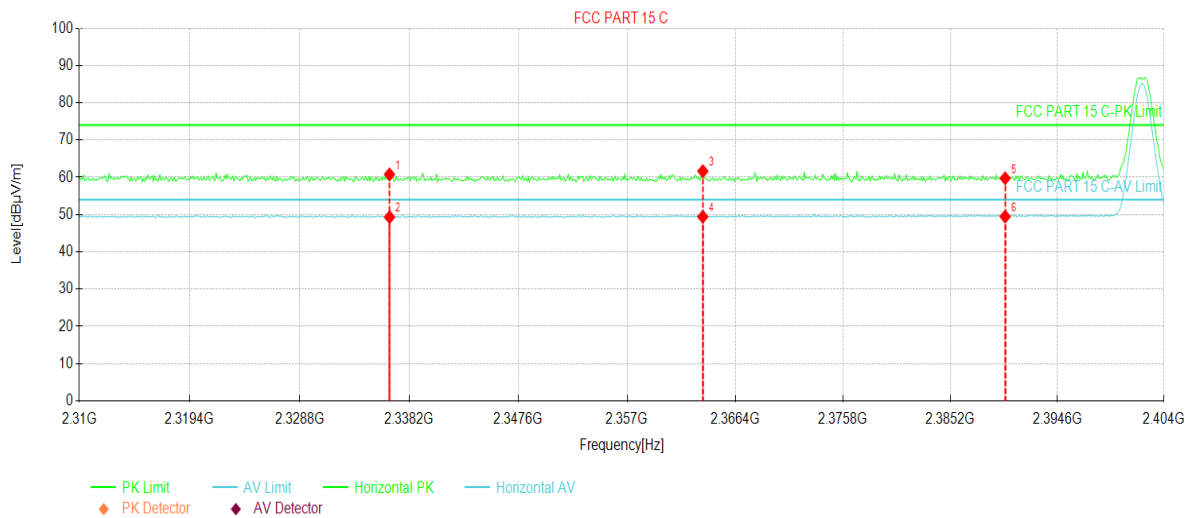

Suspected Data List								
NO.	Freq. [MHz]	Reading [dBµV/m]	Level [dBµV/m]	Factor [dB]	Limit [dBµV/m]	Margin [dB]	Trace	Polarity
1	2336.50	24.95	60.77	35.82	74.00	13.23	PK	Horizontal
2	2336.50	13.50	49.32	35.82	54.00	4.68	AV	Horizontal
3	2363.58	25.63	61.65	36.02	74.00	12.35	PK	Horizontal
4	2363.58	13.39	49.41	36.02	54.00	4.59	AV	Horizontal
5	2390.00	23.46	59.74	36.28	74.00	14.26	PK	Horizontal
6	2390.00	13.18	49.46	36.28	54.00	4.54	AV	Horizontal

Remark:

1. Level = Reading + Factor(Antenna Factor + Cable Loss – Pre-amplifier Factor).

Product Name:	Mobile Phone	Product Model:	LH8n
Test By:	Lucas	Test mode:	BLE Tx (LE Coded PHY, S=8)
Test Channel:	Highest channel	Polarization:	Vertical
Test Voltage:	DC 3.87V		

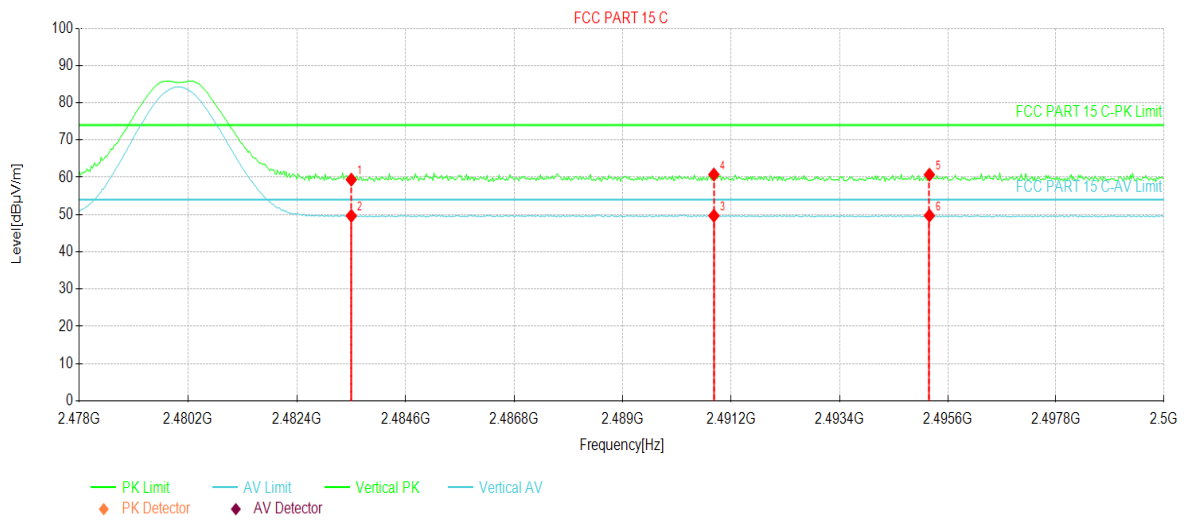

Suspected Data List								
NO.	Freq. [MHz]	Reading [dBµV/m]	Level [dBµV/m]	Factor [dB]	Limit [dBµV/m]	Margin [dB]	Trace	Polarity
1	2483.50	23.03	59.37	36.34	74.00	14.63	PK	Vertical
2	2483.50	13.32	49.66	36.34	54.00	4.34	AV	Vertical
3	2490.84	13.37	49.69	36.32	54.00	4.31	AV	Vertical
4	2490.84	24.41	60.73	36.32	74.00	13.27	PK	Vertical
5	2495.22	24.40	60.70	36.30	74.00	13.30	PK	Vertical
6	2495.22	13.42	49.72	36.30	54.00	4.28	AV	Vertical

Remark:

1. Level = Reading + Factor(Antenna Factor + Cable Loss – Preamplifier Factor).

Product Name:	Mobile Phone	Product Model:	LH8n
Test By:	Lucas	Test mode:	BLE Tx (LE Coded PHY, S=8)
Test Channel:	Highest channel	Polarization:	Horizontal
Test Voltage:	DC 3.87V		

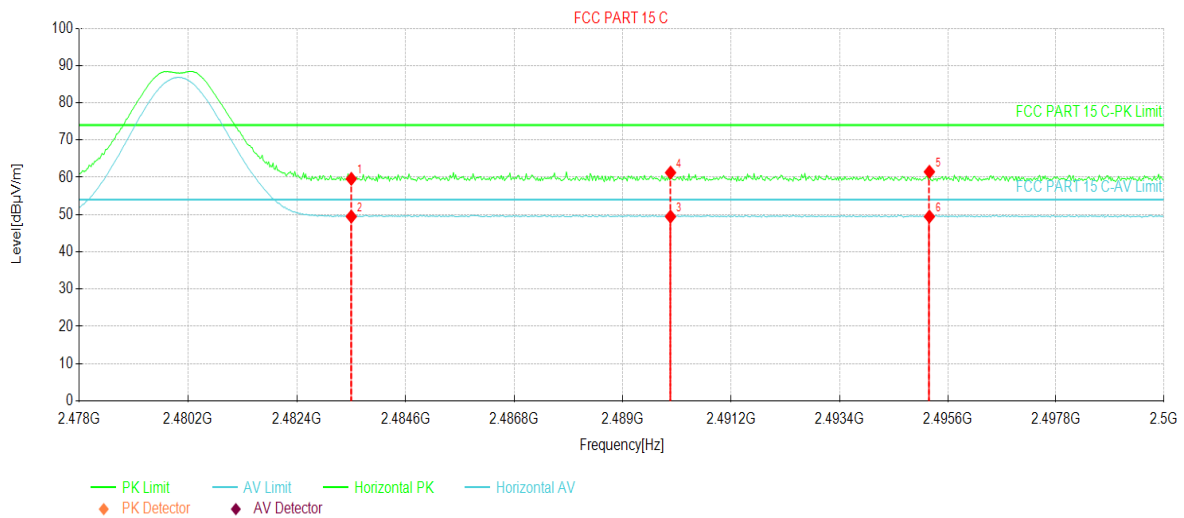

Suspected Data List								
NO.	Freq. [MHz]	Reading [dBµV/m]	Level [dBµV/m]	Factor [dB]	Limit [dBµV/m]	Margin [dB]	Trace	Polarity
1	2483.50	23.25	59.59	36.34	74.00	14.41	PK	Horizontal
2	2483.50	13.13	49.47	36.34	54.00	4.53	AV	Horizontal
3	2489.96	13.14	49.46	36.32	54.00	4.54	AV	Horizontal
4	2489.96	24.93	61.25	36.32	74.00	12.75	PK	Horizontal
5	2495.22	25.17	61.47	36.30	74.00	12.53	PK	Horizontal
6	2495.22	13.16	49.46	36.30	54.00	4.54	AV	Horizontal

Remark:

1. Level = Reading + Factor(Antenna Factor + Cable Loss – Pre-amplifier Factor).

ANT7:

Product Name:	Mobile Phone	Product Model:	LH8n
Test By:	Lucas	Test mode:	BLE Tx (LE 1M PHY)
Test Channel:	Lowest channel	Polarization:	Vertical
Test Voltage:	DC 3.87V		

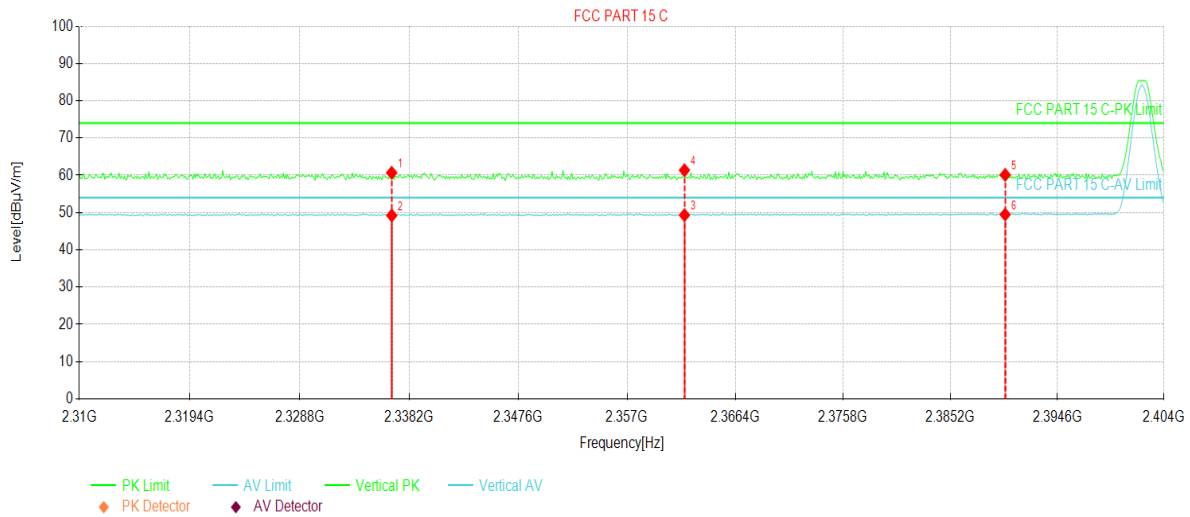

Suspected Data List								
NO.	Freq. [MHz]	Reading [dBµV/m]	Level [dBµV/m]	Factor [dB]	Limit [dBµV/m]	Margin [dB]	Trace	Polarity
1	2336.69	24.85	60.67	35.82	74.00	13.33	PK	Vertical
2	2336.69	13.40	49.22	35.82	54.00	4.78	AV	Vertical
3	2361.98	13.31	49.32	36.01	54.00	4.68	AV	Vertical
4	2361.98	25.37	61.38	36.01	74.00	12.62	PK	Vertical
5	2390.00	23.84	60.12	36.28	74.00	13.88	PK	Vertical
6	2390.00	13.19	49.47	36.28	54.00	4.53	AV	Vertical

Remark:

1. Level = Reading + Factor(Antenna Factor + Cable Loss – Pre-amplifier Factor).

Product Name:	Mobile Phone	Product Model:	LH8n
Test By:	Lucas	Test mode:	BLE Tx (LE 1M PHY)
Test Channel:	Lowest channel	Polarization:	Horizontal
Test Voltage:	DC 3.87V		

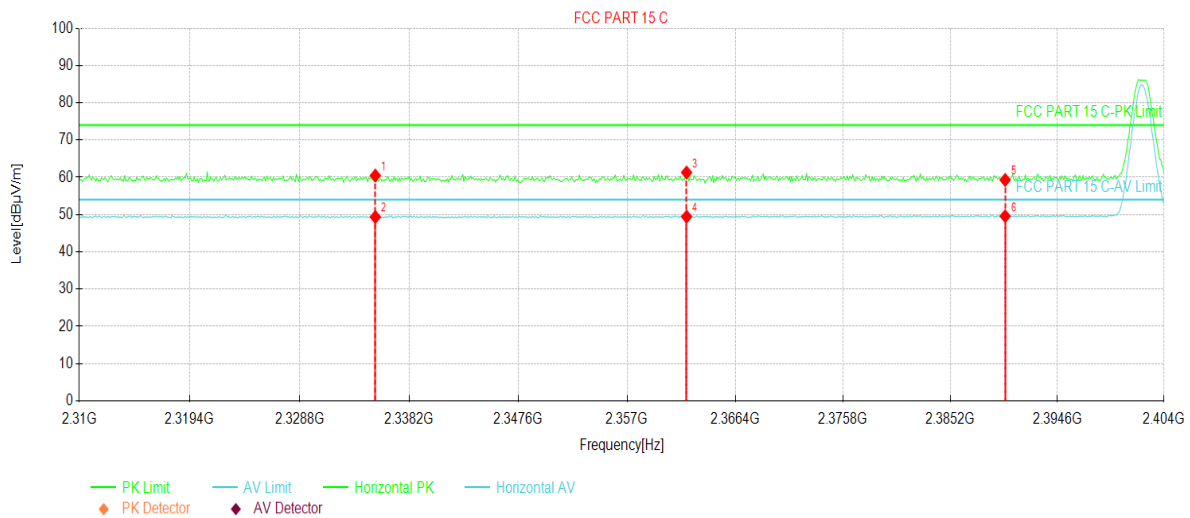

Suspected Data List								
NO.	Freq. [MHz]	Reading [dBµV/m]	Level [dBµV/m]	Factor [dB]	Limit [dBµV/m]	Margin [dB]	Trace	Polarity
1	2335.28	24.65	60.46	35.81	74.00	13.54	PK	Horizontal
2	2335.28	13.53	49.34	35.81	54.00	4.66	AV	Horizontal
3	2362.17	25.28	61.29	36.01	74.00	12.71	PK	Horizontal
4	2362.17	13.43	49.44	36.01	54.00	4.56	AV	Horizontal
5	2390.00	23.02	59.30	36.28	74.00	14.70	PK	Horizontal
6	2390.00	13.29	49.57	36.28	54.00	4.43	AV	Horizontal

Remark:

1. Level = Reading + Factor(Antenna Factor + Cable Loss – Preamplifier Factor).

Product Name:	Mobile Phone	Product Model:	LH8n
Test By:	Lucas	Test mode:	BLE Tx (LE 1M PHY)
Test Channel:	Highest channel	Polarization:	Vertical
Test Voltage:	DC 3.87V		

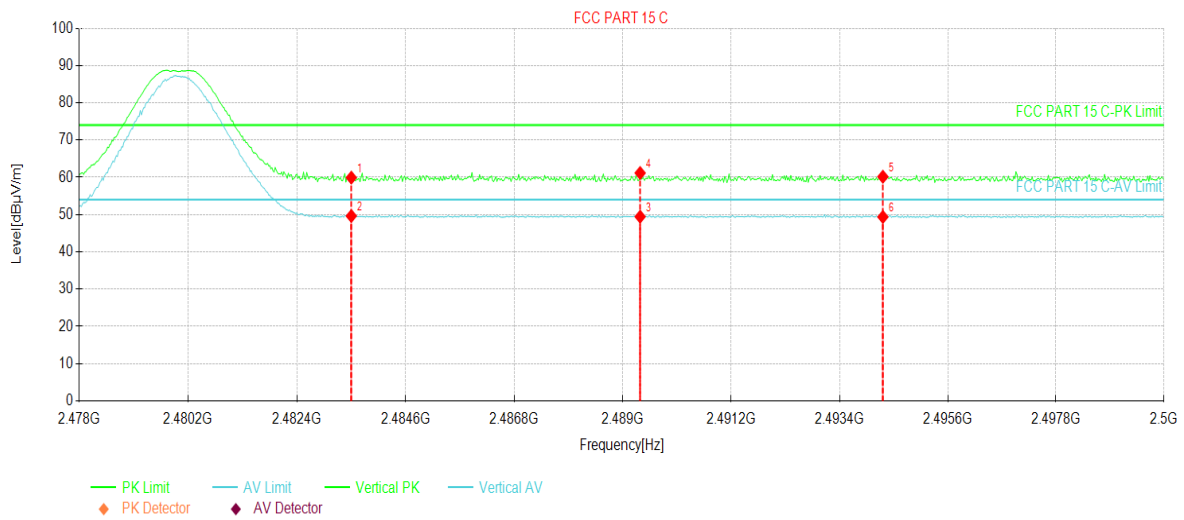

Suspected Data List								
NO.	Freq. [MHz]	Reading [dBµV/m]	Level [dBµV/m]	Factor [dB]	Limit [dBµV/m]	Margin [dB]	Trace	Polarity
1	2483.50	23.57	59.91	36.34	74.00	14.09	PK	Vertical
2	2483.50	13.28	49.62	36.34	54.00	4.38	AV	Vertical
3	2489.35	13.12	49.44	36.32	54.00	4.56	AV	Vertical
4	2489.35	24.83	61.15	36.32	74.00	12.85	PK	Vertical
5	2494.28	23.85	60.15	36.30	74.00	13.85	PK	Vertical
6	2494.28	13.06	49.36	36.30	54.00	4.64	AV	Vertical

Remark:

1. Level = Reading + Factor(Antenna Factor + Cable Loss – Pre-amplifier Factor).

Product Name:	Mobile Phone	Product Model:	LH8n
Test By:	Lucas	Test mode:	BLE Tx (LE 1M PHY)
Test Channel:	Highest channel	Polarization:	Horizontal
Test Voltage:	DC 3.87V		

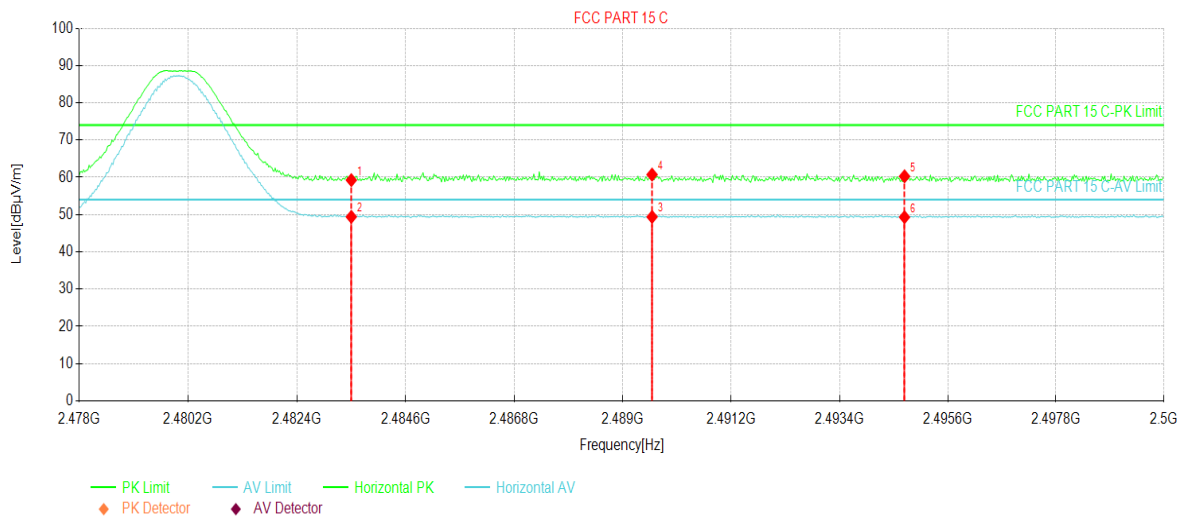

Suspected Data List								
NO.	Freq. [MHz]	Reading [dBµV/m]	Level [dBµV/m]	Factor [dB]	Limit [dBµV/m]	Margin [dB]	Trace	Polarity
1	2483.50	22.90	59.24	36.34	74.00	14.76	PK	Horizontal
2	2483.50	13.05	49.39	36.34	54.00	4.61	AV	Horizontal
3	2489.59	13.05	49.37	36.32	54.00	4.63	AV	Horizontal
4	2489.59	24.40	60.72	36.32	74.00	13.28	PK	Horizontal
5	2494.72	23.96	60.26	36.30	74.00	13.74	PK	Horizontal
6	2494.72	13.00	49.30	36.30	54.00	4.70	AV	Horizontal

Remark:

1. Level = Reading + Factor(Antenna Factor + Cable Loss – Pre-amplifier Factor).

Product Name:	Mobile Phone	Product Model:	LH8n
Test By:	Lucas	Test mode:	BLE Tx (LE 2M PHY)
Test Channel:	Lowest channel	Polarization:	Vertical
Test Voltage:	DC 3.87V		

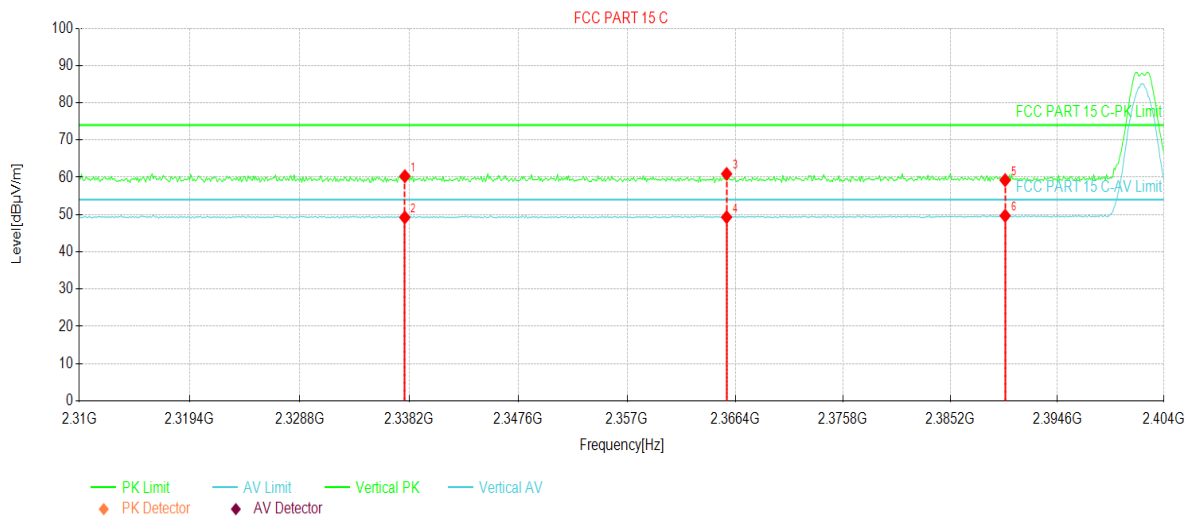

Suspected Data List								
NO.	Freq. [MHz]	Reading [dBµV/m]	Level [dBµV/m]	Factor [dB]	Limit [dBµV/m]	Margin [dB]	Trace	Polarity
1	2337.82	24.46	60.29	35.83	74.00	13.71	PK	Vertical
2	2337.82	13.40	49.23	35.83	54.00	4.77	AV	Vertical
3	2365.64	24.88	60.92	36.04	74.00	13.08	PK	Vertical
4	2365.64	13.27	49.31	36.04	54.00	4.69	AV	Vertical
5	2390.00	22.96	59.24	36.28	74.00	14.76	PK	Vertical
6	2390.00	13.40	49.68	36.28	54.00	4.32	AV	Vertical

Remark:

1. Level = Reading + Factor(Antenna Factor + Cable Loss – Pre-amplifier Factor).

Product Name:	Mobile Phone	Product Model:	LH8n
Test By:	Lucas	Test mode:	BLE Tx (LE 2M PHY)
Test Channel:	Lowest channel	Polarization:	Horizontal
Test Voltage:	DC 3.87V		

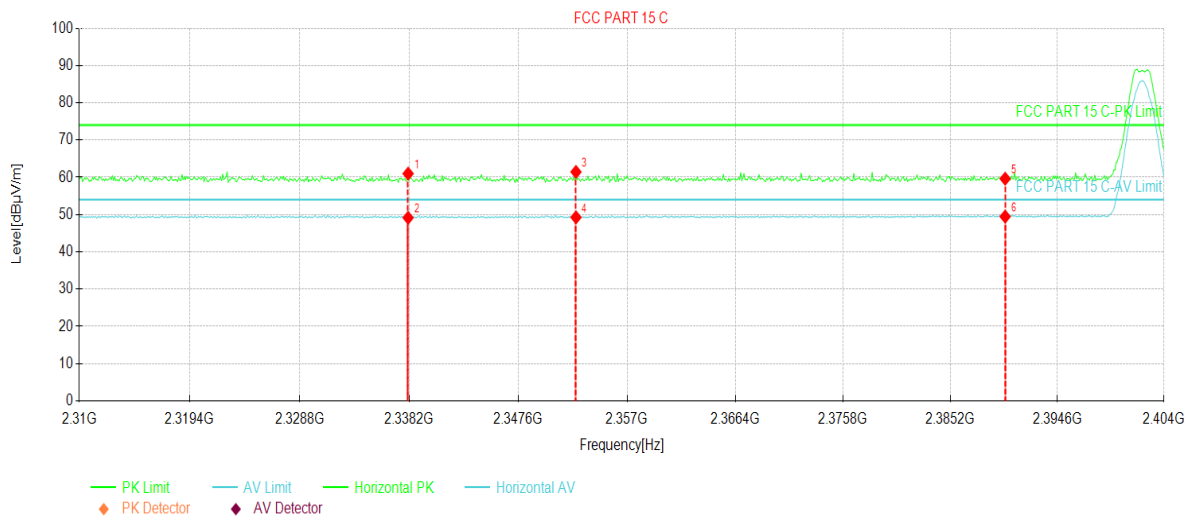

Suspected Data List								
NO.	Freq. [MHz]	Reading [dBµV/m]	Level [dBµV/m]	Factor [dB]	Limit [dBµV/m]	Margin [dB]	Trace	Polarity
1	2338.10	25.16	60.99	35.83	74.00	13.01	PK	Horizontal
2	2338.10	13.31	49.14	35.83	54.00	4.86	AV	Horizontal
3	2352.58	25.53	61.45	35.92	74.00	12.55	PK	Horizontal
4	2352.58	13.34	49.26	35.92	54.00	4.74	AV	Horizontal
5	2390.00	23.34	59.62	36.28	74.00	14.38	PK	Horizontal
6	2390.00	13.18	49.46	36.28	54.00	4.54	AV	Horizontal

Remark:

1. Level = Reading + Factor(Antenna Factor + Cable Loss – Preamplifier Factor).

Product Name:	Mobile Phone	Product Model:	LH8n
Test By:	Lucas	Test mode:	BLE Tx (LE 2M PHY)
Test Channel:	Highest channel	Polarization:	Vertical
Test Voltage:	DC 3.87V		

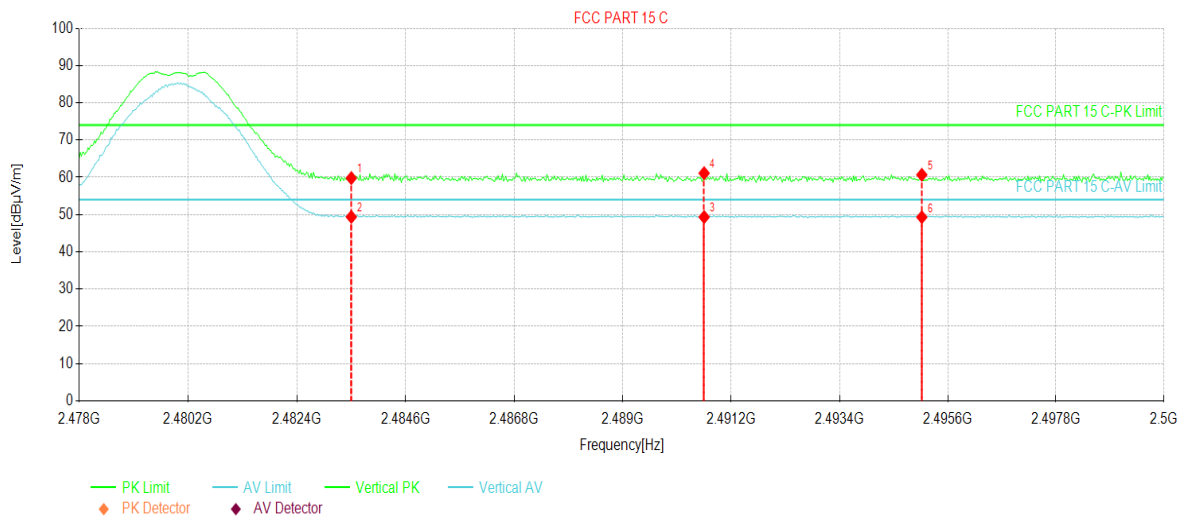

Suspected Data List								
NO.	Freq. [MHz]	Reading [dBµV/m]	Level [dBµV/m]	Factor [dB]	Limit [dBµV/m]	Margin [dB]	Trace	Polarity
1	2483.50	23.44	59.78	36.34	74.00	14.22	PK	Vertical
2	2483.50	13.03	49.37	36.34	54.00	4.63	AV	Vertical
3	2490.65	13.01	49.33	36.32	54.00	4.67	AV	Vertical
4	2490.65	24.77	61.09	36.32	74.00	12.91	PK	Vertical
5	2495.07	24.37	60.67	36.30	74.00	13.33	PK	Vertical
6	2495.07	13.00	49.30	36.30	54.00	4.70	AV	Vertical

Remark:

1. Level = Reading + Factor(Antenna Factor + Cable Loss – Preamplifier Factor).

Product Name:	Mobile Phone	Product Model:	LH8n
Test By:	Lucas	Test mode:	BLE Tx (LE 2M PHY)
Test Channel:	Highest channel	Polarization:	Horizontal
Test Voltage:	DC 3.87V		

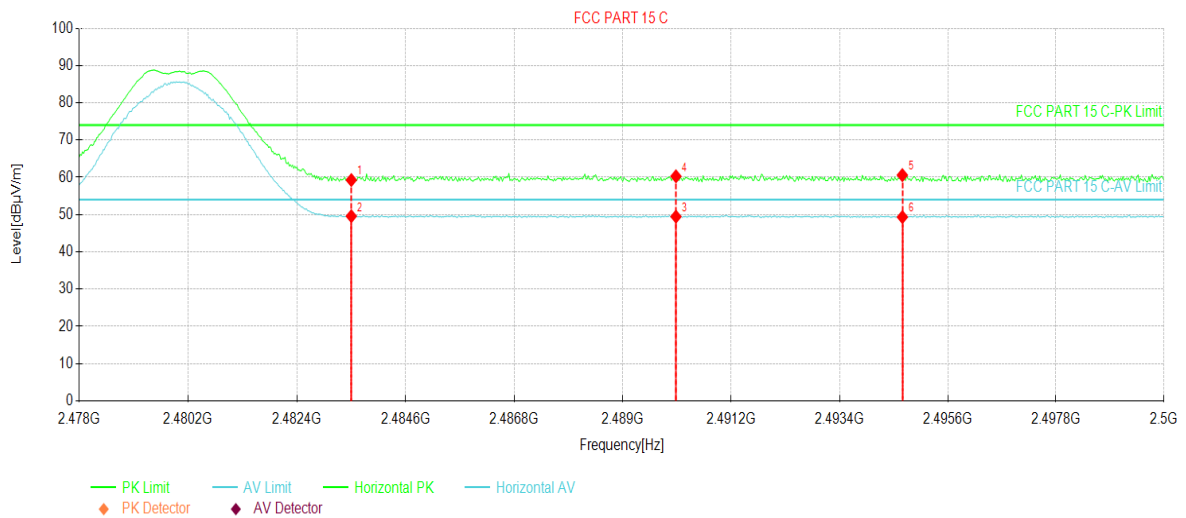

Suspected Data List								
NO.	Freq. [MHz]	Reading [dBµV/m]	Level [dBµV/m]	Factor [dB]	Limit [dBµV/m]	Margin [dB]	Trace	Polarity
1	2483.50	22.92	59.26	36.34	74.00	14.74	PK	Horizontal
2	2483.50	13.22	49.56	36.34	54.00	4.44	AV	Horizontal
3	2490.07	13.13	49.45	36.32	54.00	4.55	AV	Horizontal
4	2490.07	23.95	60.27	36.32	74.00	13.73	PK	Horizontal
5	2494.67	24.29	60.59	36.30	74.00	13.41	PK	Horizontal
6	2494.67	13.03	49.33	36.30	54.00	4.67	AV	Horizontal

Remark:

1. Level = Reading + Factor(Antenna Factor + Cable Loss – Pre-amplifier Factor).

Product Name:	Mobile Phone	Product Model:	LH8n
Test By:	Lucas	Test mode:	BLE Tx (LE Coded PHY, S=2)
Test Channel:	Lowest channel	Polarization:	Vertical
Test Voltage:	DC 3.87V		

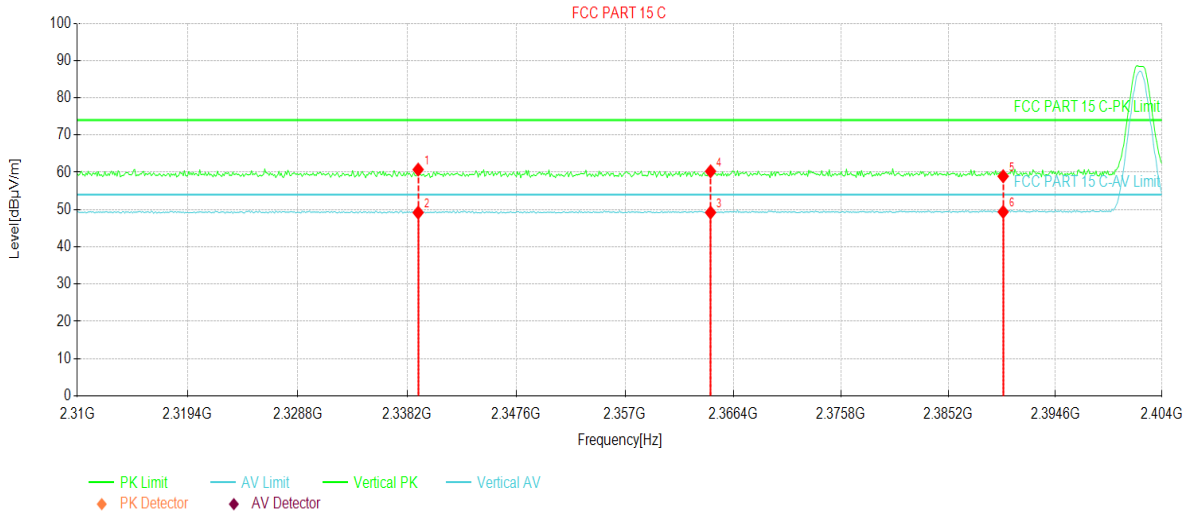

Suspected Data List								
NO.	Freq. [MHz]	Reading [dBµV/m]	Level [dBµV/m]	Factor [dB]	Limit [dBµV/m]	Margin [dB]	Trace	Polarity
1	2339.14	24.89	60.73	35.84	74.00	13.27	PK	Vertical
2	2339.14	13.35	49.19	35.84	54.00	4.81	AV	Vertical
3	2364.42	13.17	49.20	36.03	54.00	4.80	AV	Vertical
4	2364.42	24.23	60.26	36.03	74.00	13.74	PK	Vertical
5	2390.00	22.66	58.94	36.28	74.00	15.06	PK	Vertical
6	2390.00	13.10	49.38	36.28	54.00	4.62	AV	Vertical

Remark:

1. Level = Reading + Factor(Antenna Factor + Cable Loss – Preamplifier Factor).

Product Name:	Mobile Phone	Product Model:	LH8n
Test By:	Lucas	Test mode:	BLE Tx (LE Coded PHY, S=2)
Test Channel:	Lowest channel	Polarization:	Horizontal
Test Voltage:	DC 3.87V		

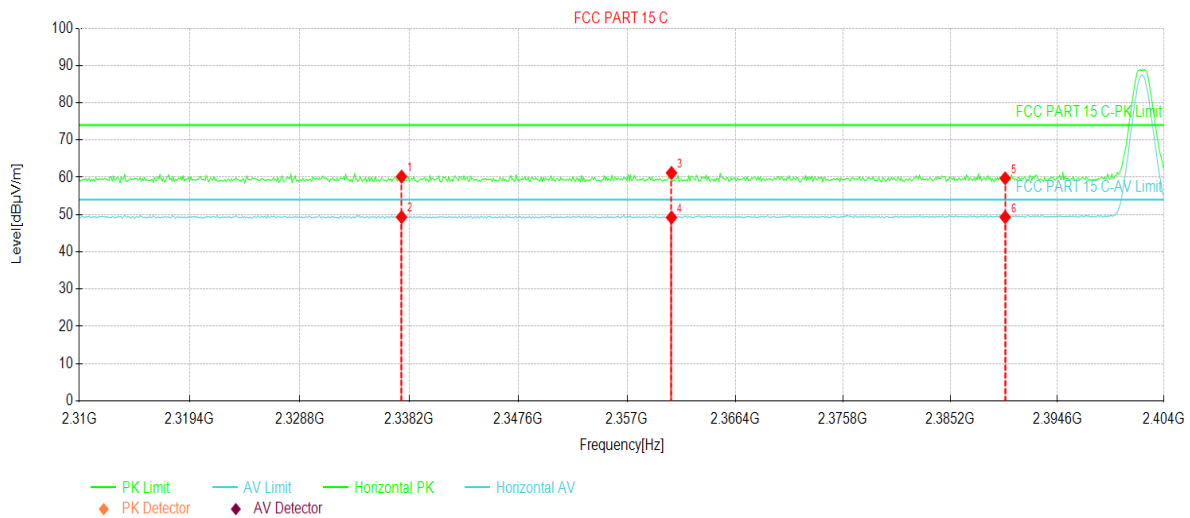

Suspected Data List								
NO.	Freq. [MHz]	Reading [dBµV/m]	Level [dBµV/m]	Factor [dB]	Limit [dBµV/m]	Margin [dB]	Trace	Polarity
1	2337.54	24.35	60.18	35.83	74.00	13.82	PK	Horizontal
2	2337.54	13.50	49.33	35.83	54.00	4.67	AV	Horizontal
3	2360.85	25.18	61.18	36.00	74.00	12.82	PK	Horizontal
4	2360.85	13.21	49.21	36.00	54.00	4.79	AV	Horizontal
5	2390.00	23.46	59.74	36.28	74.00	14.26	PK	Horizontal
6	2390.00	13.01	49.29	36.28	54.00	4.71	AV	Horizontal

Remark:

1. Level = Reading + Factor(Antenna Factor + Cable Loss – Pre-amplifier Factor).

Product Name:	Mobile Phone	Product Model:	LH8n
Test By:	Lucas	Test mode:	BLE Tx (LE Coded PHY, S=2)
Test Channel:	Highest channel	Polarization:	Vertical
Test Voltage:	DC 3.87V		

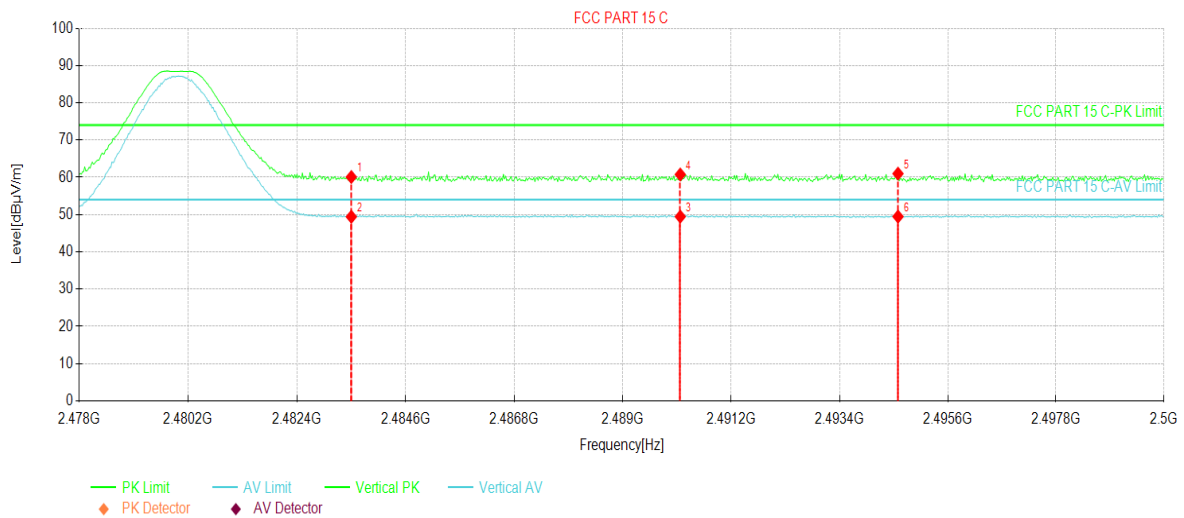

Suspected Data List								
NO.	Freq. [MHz]	Reading [dBµV/m]	Level [dBµV/m]	Factor [dB]	Limit [dBµV/m]	Margin [dB]	Trace	Polarity
1	2483.50	23.74	60.08	36.34	74.00	13.92	PK	Vertical
2	2483.50	13.07	49.41	36.34	54.00	4.59	AV	Vertical
3	2490.16	13.13	49.45	36.32	54.00	4.55	AV	Vertical
4	2490.16	24.42	60.74	36.32	74.00	13.26	PK	Vertical
5	2494.58	24.68	60.98	36.30	74.00	13.02	PK	Vertical
6	2494.58	13.16	49.46	36.30	54.00	4.54	AV	Vertical

Remark:

1. Level = Reading + Factor(Antenna Factor + Cable Loss – Pre-amplifier Factor).

Product Name:	Mobile Phone	Product Model:	LH8n
Test By:	Lucas	Test mode:	BLE Tx (LE Coded PHY, S=2)
Test Channel:	Highest channel	Polarization:	Horizontal
Test Voltage:	DC 3.87V		

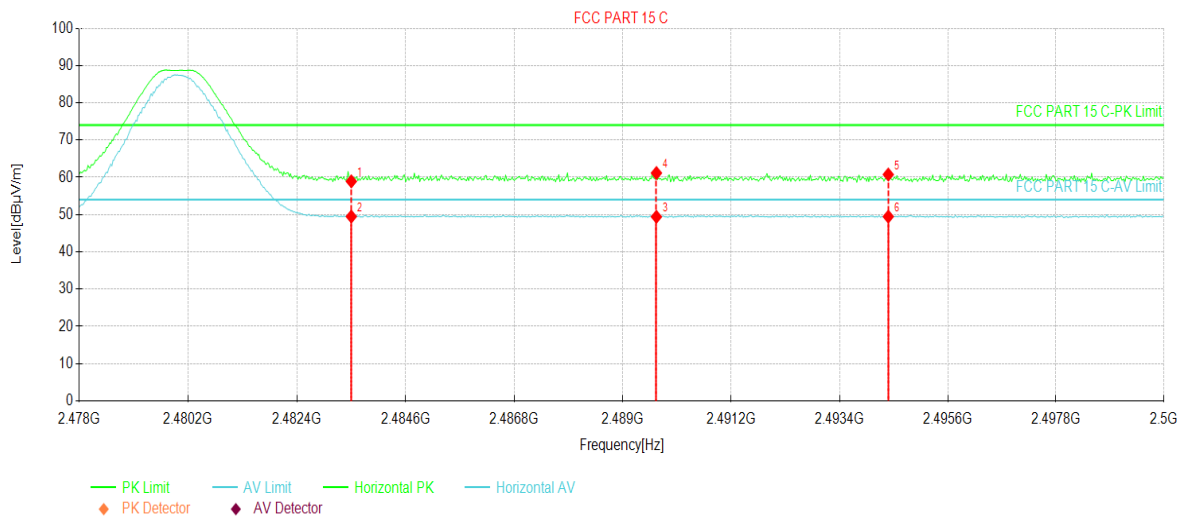

Suspected Data List								
NO.	Freq. [MHz]	Reading [dBµV/m]	Level [dBµV/m]	Factor [dB]	Limit [dBµV/m]	Margin [dB]	Trace	Polarity
1	2483.50	22.57	58.91	36.34	74.00	15.09	PK	Horizontal
2	2483.50	13.13	49.47	36.34	54.00	4.53	AV	Horizontal
3	2489.68	13.08	49.40	36.32	54.00	4.60	AV	Horizontal
4	2489.68	24.83	61.15	36.32	74.00	12.85	PK	Horizontal
5	2494.39	24.45	60.75	36.30	74.00	13.25	PK	Horizontal
6	2494.39	13.15	49.45	36.30	54.00	4.55	AV	Horizontal

Remark:

1. Level = Reading + Factor(Antenna Factor + Cable Loss – Pre-amplifier Factor).

Product Name:	Mobile Phone	Product Model:	LH8n
Test By:	Lucas	Test mode:	BLE Tx (LE Coded PHY, S=8)
Test Channel:	Lowest channel	Polarization:	Vertical
Test Voltage:	DC 3.87V		

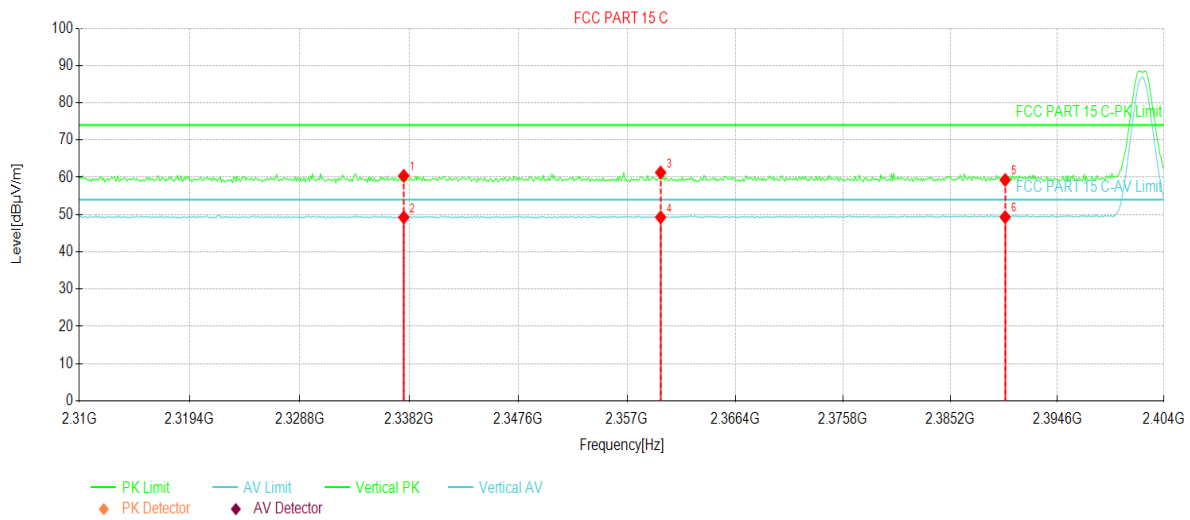

Suspected Data List								
NO.	Freq. [MHz]	Reading [dBµV/m]	Level [dBµV/m]	Factor [dB]	Limit [dBµV/m]	Margin [dB]	Trace	Polarity
1	2337.73	24.56	60.39	35.83	74.00	13.61	PK	Vertical
2	2337.73	13.41	49.24	35.83	54.00	4.76	AV	Vertical
3	2359.91	25.29	61.28	35.99	74.00	12.72	PK	Vertical
4	2359.91	13.27	49.26	35.99	54.00	4.74	AV	Vertical
5	2390.00	23.00	59.28	36.28	74.00	14.72	PK	Vertical
6	2390.00	13.04	49.32	36.28	54.00	4.68	AV	Vertical

Remark:

1. Level = Reading + Factor(Antenna Factor + Cable Loss – Pre-amplifier Factor).

Product Name:	Mobile Phone	Product Model:	LH8n
Test By:	Lucas	Test mode:	BLE Tx (LE Coded PHY, S=8)
Test Channel:	Lowest channel	Polarization:	Horizontal
Test Voltage:	DC 3.87V		

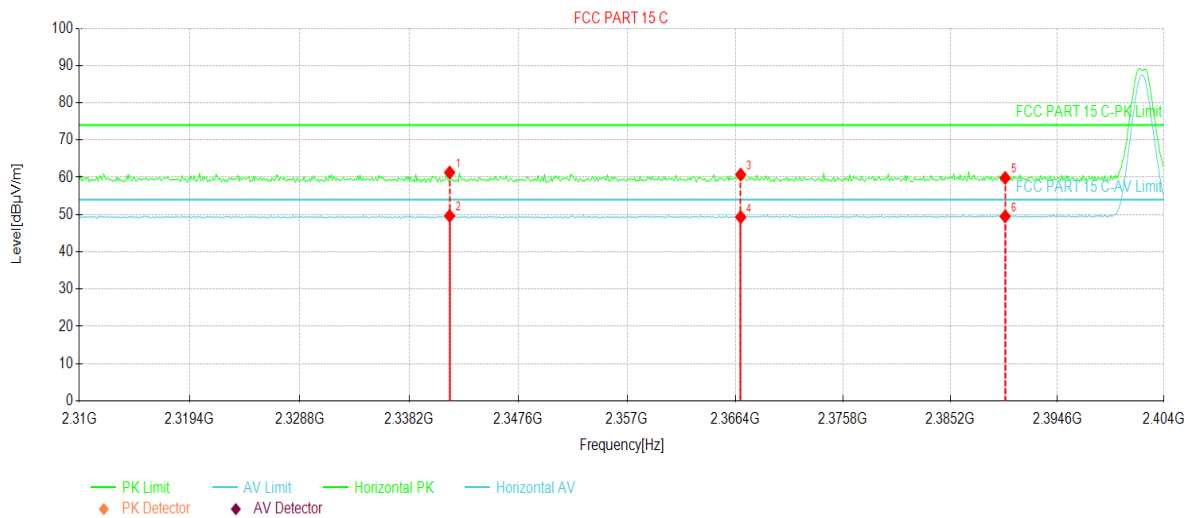

Suspected Data List								
NO.	Freq. [MHz]	Reading [dBµV/m]	Level [dBµV/m]	Factor [dB]	Limit [dBµV/m]	Margin [dB]	Trace	Polarity
1	2341.67	25.45	61.30	35.85	74.00	12.70	PK	Horizontal
2	2341.67	13.80	49.65	35.85	54.00	4.35	AV	Horizontal
3	2366.87	24.66	60.72	36.06	74.00	13.28	PK	Horizontal
4	2366.87	13.25	49.31	36.06	54.00	4.69	AV	Horizontal
5	2390.00	23.55	59.83	36.28	74.00	14.17	PK	Horizontal
6	2390.00	13.22	49.50	36.28	54.00	4.50	AV	Horizontal

Remark:

1. Level = Reading + Factor(Antenna Factor + Cable Loss – Preamplifier Factor).

Product Name:	Mobile Phone	Product Model:	LH8n
Test By:	Lucas	Test mode:	BLE Tx (LE Coded PHY, S=8)
Test Channel:	Highest channel	Polarization:	Vertical
Test Voltage:	DC 3.87V		

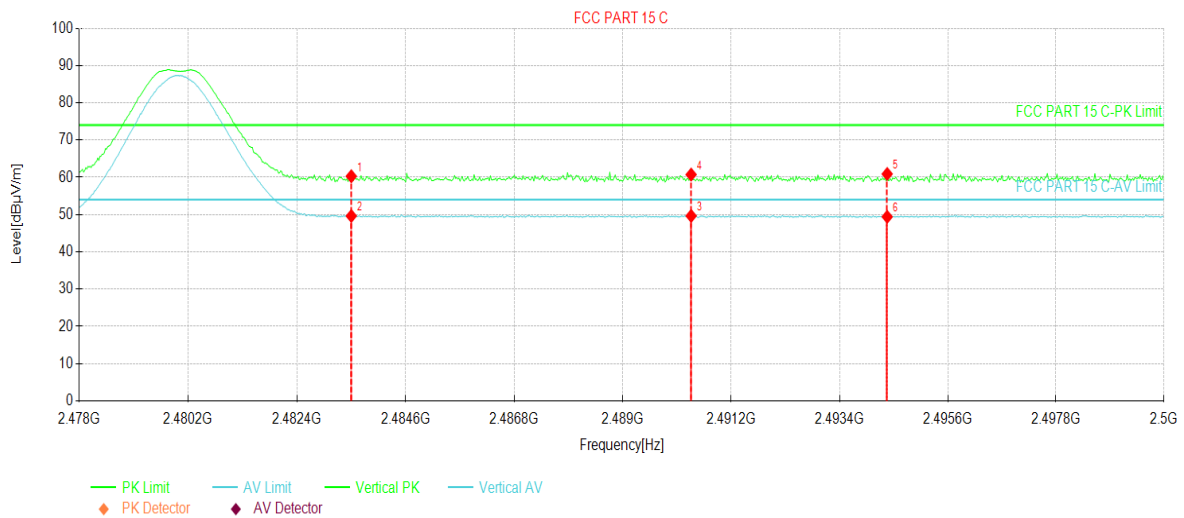

Suspected Data List								
NO.	Freq. [MHz]	Reading [dBµV/m]	Level [dBµV/m]	Factor [dB]	Limit [dBµV/m]	Margin [dB]	Trace	Polarity
1	2483.50	23.94	60.28	36.34	74.00	13.72	PK	Vertical
2	2483.50	13.28	49.62	36.34	54.00	4.38	AV	Vertical
3	2490.38	13.32	49.64	36.32	54.00	4.36	AV	Vertical
4	2490.38	24.41	60.73	36.32	74.00	13.27	PK	Vertical
5	2494.36	24.59	60.89	36.30	74.00	13.11	PK	Vertical
6	2494.36	13.10	49.40	36.30	54.00	4.60	AV	Vertical

Remark:

1. Level = Reading + Factor(Antenna Factor + Cable Loss – Pre-amplifier Factor).

Product Name:	Mobile Phone	Product Model:	LH8n
Test By:	Lucas	Test mode:	BLE Tx (LE Coded PHY, S=8)
Test Channel:	Highest channel	Polarization:	Horizontal
Test Voltage:	DC 3.87V		

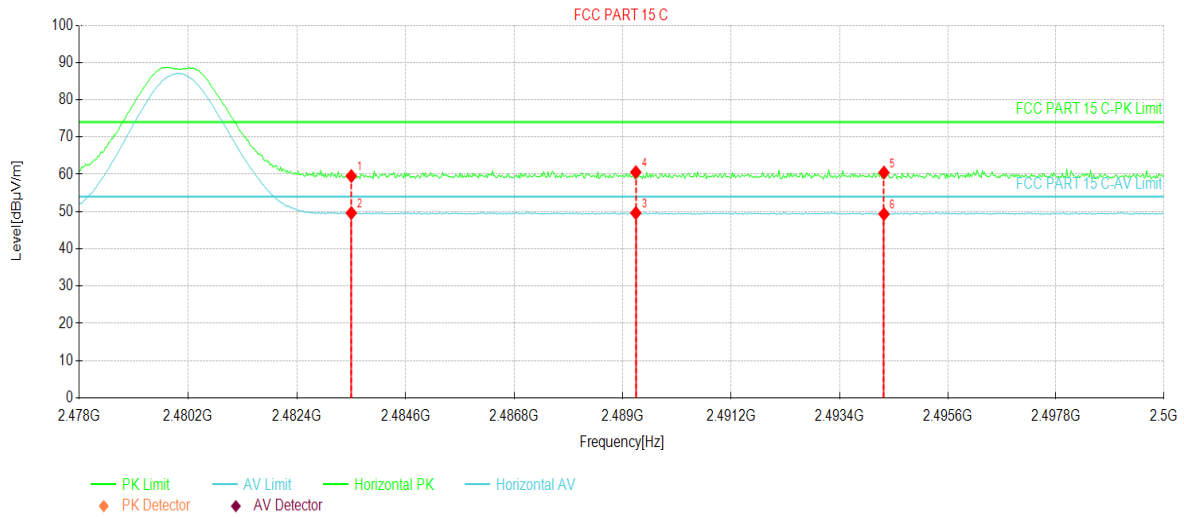

Suspected Data List								
NO.	Freq. [MHz]	Reading [dBµV/m]	Level [dBµV/m]	Factor [dB]	Limit [dBµV/m]	Margin [dB]	Trace	Polarity
1	2483.50	23.20	59.54	36.34	74.00	14.46	PK	Horizontal
2	2483.50	13.27	49.61	36.34	54.00	4.39	AV	Horizontal
3	2489.26	13.30	49.62	36.32	54.00	4.38	AV	Horizontal
4	2489.26	24.24	60.56	36.32	74.00	13.44	PK	Horizontal
5	2494.30	24.16	60.46	36.30	74.00	13.54	PK	Horizontal
6	2494.30	13.03	49.33	36.30	54.00	4.67	AV	Horizontal

Remark:

1. Level = Reading + Factor(Antenna Factor + Cable Loss – Pre-amplifier Factor).

5.5 Emissions in Non-restricted Frequency Bands

Below 1GHz:

Product Name:	Mobile Phone	Product Model:	LH8n
Test By:	Lucas	Test mode:	BLE Tx (LE 1M PHY)
Test Frequency:	30 MHz ~ 1 GHz	Polarization:	Vertical
Test Voltage:	DC 3.87V		

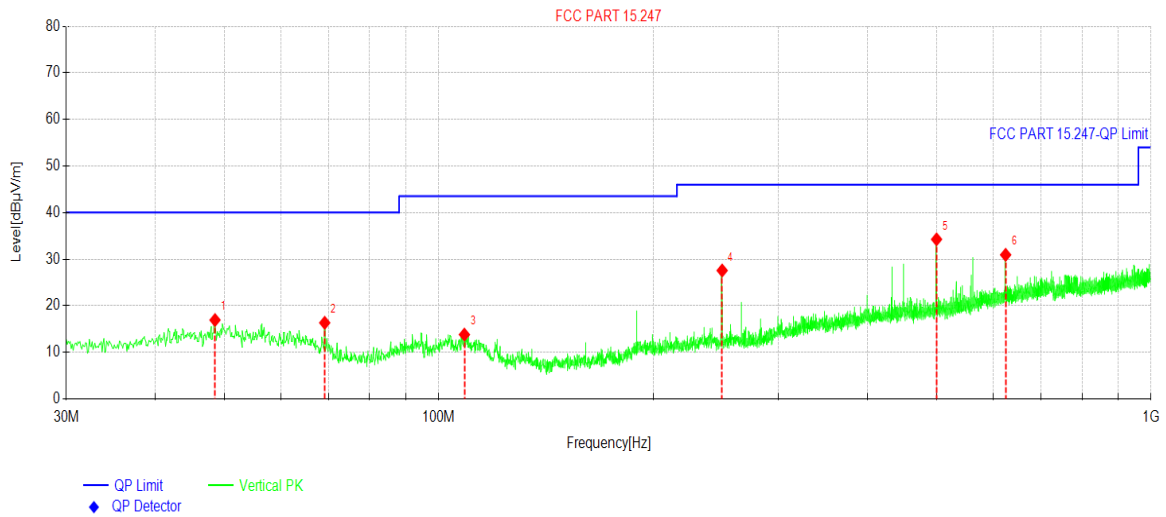

Suspected Data List

NO.	Freq. [MHz]	Reading[dBµV/m]	Level [dBµV/m]	Factor [dB]	Limit [dBµV/m]	Margin [dB]	Trace	Polarity
1	48.5289	29.61	16.93	-12.68	40.00	23.07	PK	Vertical
2	69.1919	33.08	16.33	-16.75	40.00	23.67	PK	Vertical
3	108.674	28.54	13.80	-14.74	43.50	29.70	PK	Vertical
4	250.018	41.05	27.56	-13.49	46.00	18.44	PK	Vertical
5	500.012	43.21	34.25	-8.96	46.00	11.75	PK	Vertical
6	625.057	37.14	30.93	-6.21	46.00	15.07	PK	Vertical

Remark:

1. Level = Reading + Factor(Antenna Factor + Cable Loss – Preamplifier Factor).

Product Name:	Mobile Phone	Product Model:	LH8n
Test By:	Lucas	Test mode:	BLE Tx (LE 1M PHY)
Test Frequency:	30 MHz ~ 1 GHz	Polarization:	Horizontal
Test Voltage:	DC 3.87V		

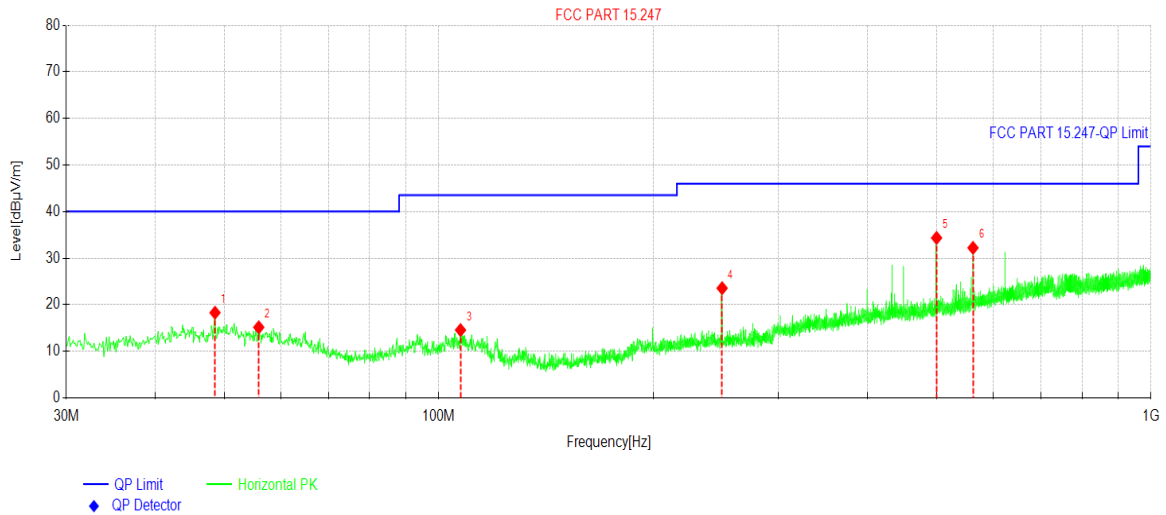

Suspected Data List								
NO.	Freq. [MHz]	Reading[dBµV/m]	Level [dBµV/m]	Factor [dB]	Limit [dBµV/m]	Margin [dB]	Trace	Polarity
1	48.5289	30.97	18.29	-12.68	40.00	21.71	PK	Horizontal
2	55.9016	28.24	15.15	-13.09	40.00	24.85	PK	Horizontal
3	107.316	29.10	14.56	-14.54	43.50	28.94	PK	Horizontal
4	250.018	37.04	23.55	-13.49	46.00	22.45	PK	Horizontal
5	500.012	43.31	34.35	-8.96	46.00	11.65	PK	Horizontal
6	562.486	40.03	32.20	-7.83	46.00	13.80	PK	Horizontal

Remark:

1. Level = Reading + Factor(Antenna Factor + Cable Loss – Preamplifier Factor).

Above 1GHz:

ANT6:

BLE Tx (LE 1M PHY)						
Test channel: Lowest channel						
Detector: Peak Value						
Frequency (MHz)	Read Level (dBμV)	Factor (dB)	Level (dBμV/m)	Limit (dBμV/m)	Margin (dB)	Polarization
4804.00	57.27	-9.08	48.19	74.00	25.81	Vertical
4804.00	56.50	-9.08	47.42	74.00	26.58	Horizontal
Detector: Average Value						
Frequency (MHz)	Read Level (dBμV)	Factor (dB)	Level (dBμV/m)	Limit (dBμV/m)	Margin (dB)	Polarization
4804.00	48.16	-9.08	39.08	54.00	14.92	Vertical
4804.00	48.43	-9.08	39.35	54.00	14.65	Horizontal
Test channel: Middle channel						
Detector: Peak Value						
Frequency (MHz)	Read Level (dBμV)	Factor (dB)	Level (dBμV/m)	Limit (dBμV/m)	Margin (dB)	Polarization
4884.00	57.13	-8.59	48.54	74.00	25.46	Vertical
4884.00	56.40	-8.59	47.81	74.00	26.19	Horizontal
Detector: Average Value						
Frequency (MHz)	Read Level (dBμV)	Factor (dB)	Level (dBμV/m)	Limit (dBμV/m)	Margin (dB)	Polarization
4884.00	48.50	-8.59	39.91	54.00	14.09	Vertical
4884.00	48.75	-8.59	40.16	54.00	13.84	Horizontal
Test channel: Highest channel						
Detector: Peak Value						
Frequency (MHz)	Read Level (dBμV)	Factor (dB)	Level (dBμV/m)	Limit (dBμV/m)	Margin (dB)	Polarization
4960.00	57.14	-8.03	49.11	74.00	24.89	Vertical
4960.00	56.06	-8.03	48.03	74.00	25.97	Horizontal
Detector: Average Value						
Frequency (MHz)	Read Level (dBμV)	Factor (dB)	Level (dBμV/m)	Limit (dBμV/m)	Margin (dB)	Polarization
4960.00	48.37	-8.03	40.34	54.00	13.66	Vertical
4960.00	48.70	-8.03	40.67	54.00	13.33	Horizontal
Remark:						
1. Level = Reading + Factor.						
2. Test Frequency up to 25GHz, and the emission levels of other frequencies are lower than the limit 20dB, not show in test report.						

BLE Tx (LE 2M PHY)						
Test channel: Lowest channel						
Detector: Peak Value						
Frequency (MHz)	Read Level (dBμV)	Factor (dB)	Level (dBμV/m)	Limit (dBμV/m)	Margin (dB)	Polarization
4804.00	56.87	-9.08	47.79	74.00	26.21	Vertical
4804.00	56.24	-9.08	47.16	74.00	26.84	Horizontal
Detector: Average Value						
Frequency (MHz)	Read Level (dBμV)	Factor (dB)	Level (dBμV/m)	Limit (dBμV/m)	Margin (dB)	Polarization
4804.00	48.12	-9.08	39.04	54.00	14.96	Vertical
4804.00	48.25	-9.08	39.17	54.00	14.83	Horizontal
Test channel: Middle channel						
Detector: Peak Value						
Frequency (MHz)	Read Level (dBμV)	Factor (dB)	Level (dBμV/m)	Limit (dBμV/m)	Margin (dB)	Polarization
4884.00	57.59	-8.59	49.00	74.00	25.00	Vertical
4884.00	56.39	-8.59	47.80	74.00	26.20	Horizontal
Detector: Average Value						
Frequency (MHz)	Read Level (dBμV)	Factor (dB)	Level (dBμV/m)	Limit (dBμV/m)	Margin (dB)	Polarization
4884.00	47.94	-8.59	39.35	54.00	14.65	Vertical
4884.00	48.08	-8.59	39.49	54.00	14.51	Horizontal
Test channel: Highest channel						
Detector: Peak Value						
Frequency (MHz)	Read Level (dBμV)	Factor (dB)	Level (dBμV/m)	Limit (dBμV/m)	Margin (dB)	Polarization
4960.00	56.83	-8.03	48.80	74.00	25.20	Vertical
4960.00	56.78	-8.03	48.75	74.00	25.25	Horizontal
Detector: Average Value						
Frequency (MHz)	Read Level (dBμV)	Factor (dB)	Level (dBμV/m)	Limit (dBμV/m)	Margin (dB)	Polarization
4960.00	48.64	-8.03	40.61	54.00	13.39	Vertical
4960.00	48.12	-8.03	40.09	54.00	13.91	Horizontal
Remark:						
1. <i>Level = Reading + Factor.</i>						
2. <i>Test Frequency up to 25GHz, and the emission levels of other frequencies are lower than the limit 20dB, not show in test report.</i>						

BEL Tx (LE Coded PHY, S=2)						
Test channel: Lowest channel						
Detector: Peak Value						
Frequency (MHz)	Read Level (dBμV)	Factor (dB)	Level (dBμV/m)	Limit (dBμV/m)	Margin (dB)	Polarization
4804.00	57.16	-9.08	48.08	74.00	25.92	Vertical
4804.00	56.55	-9.08	47.47	74.00	26.53	Horizontal
Detector: Average Value						
Frequency (MHz)	Read Level (dBμV)	Factor (dB)	Level (dBμV/m)	Limit (dBμV/m)	Margin (dB)	Polarization
4804.00	47.81	-9.08	38.73	54.00	15.27	Vertical
4804.00	48.30	-9.08	39.22	54.00	14.78	Horizontal
Test channel: Middle channel						
Detector: Peak Value						
Frequency (MHz)	Read Level (dBμV)	Factor (dB)	Level (dBμV/m)	Limit (dBμV/m)	Margin (dB)	Polarization
4884.00	56.83	-8.59	48.24	74.00	25.76	Vertical
4884.00	56.11	-8.59	47.52	74.00	26.48	Horizontal
Detector: Average Value						
Frequency (MHz)	Read Level (dBμV)	Factor (dB)	Level (dBμV/m)	Limit (dBμV/m)	Margin (dB)	Polarization
4884.00	48.34	-8.59	39.75	54.00	14.25	Vertical
4884.00	48.15	-8.59	39.56	54.00	14.44	Horizontal
Test channel: Highest channel						
Detector: Peak Value						
Frequency (MHz)	Read Level (dBμV)	Factor (dB)	Level (dBμV/m)	Limit (dBμV/m)	Margin (dB)	Polarization
4960.00	56.77	-8.03	48.74	74.00	25.26	Vertical
4960.00	56.24	-8.03	48.21	74.00	25.79	Horizontal
Detector: Average Value						
Frequency (MHz)	Read Level (dBμV)	Factor (dB)	Level (dBμV/m)	Limit (dBμV/m)	Margin (dB)	Polarization
4960.00	47.93	-8.03	39.90	54.00	14.10	Vertical
4960.00	48.02	-8.03	39.99	54.00	14.01	Horizontal
Remark:						
1. Level = Reading + Factor.						
2. Test Frequency up to 25GHz, and the emission levels of other frequencies are lower than the limit 20dB, not show in test report.						

BEL Tx (LE Coded PHY, S=8)						
Test channel: Lowest channel						
Detector: Peak Value						
Frequency (MHz)	Read Level (dBμV)	Factor (dB)	Level (dBμV/m)	Limit (dBμV/m)	Margin (dB)	Polarization
4804.00	57.11	-9.08	48.03	74.00	25.97	Vertical
4804.00	56.76	-9.08	47.68	74.00	26.32	Horizontal
Detector: Average Value						
Frequency (MHz)	Read Level (dBμV)	Factor (dB)	Level (dBμV/m)	Limit (dBμV/m)	Margin (dB)	Polarization
4804.00	48.49	-9.08	39.41	54.00	14.59	Vertical
4804.00	48.91	-9.08	39.83	54.00	14.17	Horizontal
Test channel: Middle channel						
Detector: Peak Value						
Frequency (MHz)	Read Level (dBμV)	Factor (dB)	Level (dBμV/m)	Limit (dBμV/m)	Margin (dB)	Polarization
4884.00	57.74	-8.59	49.15	74.00	24.85	Vertical
4884.00	56.75	-8.59	48.16	74.00	25.84	Horizontal
Detector: Average Value						
Frequency (MHz)	Read Level (dBμV)	Factor (dB)	Level (dBμV/m)	Limit (dBμV/m)	Margin (dB)	Polarization
4884.00	47.96	-8.59	39.37	54.00	14.63	Vertical
4884.00	48.40	-8.59	39.81	54.00	14.19	Horizontal
Test channel: Highest channel						
Detector: Peak Value						
Frequency (MHz)	Read Level (dBμV)	Factor (dB)	Level (dBμV/m)	Limit (dBμV/m)	Margin (dB)	Polarization
4960.00	57.48	-8.03	49.45	74.00	24.55	Vertical
4960.00	56.68	-8.03	48.65	74.00	25.35	Horizontal
Detector: Average Value						
Frequency (MHz)	Read Level (dBμV)	Factor (dB)	Level (dBμV/m)	Limit (dBμV/m)	Margin (dB)	Polarization
4960.00	48.38	-8.03	40.35	54.00	13.65	Vertical
4960.00	48.61	-8.03	40.58	54.00	13.42	Horizontal
Remark:						
1. Level = Reading + Factor.						
2. Test Frequency up to 25GHz, and the emission levels of other frequencies are lower than the limit 20dB, not show in test report.						

ANT7:

BLE Tx (LE 1M PHY)						
Test channel: Lowest channel						
Detector: Peak Value						
Frequency (MHz)	Read Level (dBμV)	Factor (dB)	Level (dBμV/m)	Limit (dBμV/m)	Margin (dB)	Polarization
4804.00	56.85	-9.08	47.77	74.00	26.23	Vertical
4804.00	55.52	-9.08	46.44	74.00	27.56	Horizontal
Detector: Average Value						
Frequency (MHz)	Read Level (dBμV)	Factor (dB)	Level (dBμV/m)	Limit (dBμV/m)	Margin (dB)	Polarization
4804.00	47.73	-9.08	38.65	54.00	15.35	Vertical
4804.00	48.99	-9.08	39.91	54.00	14.09	Horizontal
Test channel: Middle channel						
Detector: Peak Value						
Frequency (MHz)	Read Level (dBμV)	Factor (dB)	Level (dBμV/m)	Limit (dBμV/m)	Margin (dB)	Polarization
4884.00	57.31	-8.59	48.72	74.00	25.28	Vertical
4884.00	55.07	-8.59	46.48	74.00	27.52	Horizontal
Detector: Average Value						
Frequency (MHz)	Read Level (dBμV)	Factor (dB)	Level (dBμV/m)	Limit (dBμV/m)	Margin (dB)	Polarization
4884.00	47.50	-8.59	38.91	54.00	15.09	Vertical
4884.00	48.60	-8.59	40.01	54.00	13.99	Horizontal
Test channel: Highest channel						
Detector: Peak Value						
Frequency (MHz)	Read Level (dBμV)	Factor (dB)	Level (dBμV/m)	Limit (dBμV/m)	Margin (dB)	Polarization
4960.00	56.86	-8.03	48.83	74.00	25.17	Vertical
4960.00	55.25	-8.03	47.22	74.00	26.78	Horizontal
Detector: Average Value						
Frequency (MHz)	Read Level (dBμV)	Factor (dB)	Level (dBμV/m)	Limit (dBμV/m)	Margin (dB)	Polarization
4960.00	47.71	-8.03	39.68	54.00	14.32	Vertical
4960.00	48.81	-8.03	40.78	54.00	13.22	Horizontal
Remark:						
1. Level = Reading + Factor.						
2. Test Frequency up to 25GHz, and the emission levels of other frequencies are lower than the limit 20dB, not show in test report.						

BLE Tx (LE 2M PHY)						
Test channel: Lowest channel						
Detector: Peak Value						
Frequency (MHz)	Read Level (dBμV)	Factor (dB)	Level (dBμV/m)	Limit (dBμV/m)	Margin (dB)	Polarization
4804.00	57.05	-9.08	47.97	74.00	26.03	Vertical
4804.00	55.10	-9.08	46.02	74.00	27.98	Horizontal
Detector: Average Value						
Frequency (MHz)	Read Level (dBμV)	Factor (dB)	Level (dBμV/m)	Limit (dBμV/m)	Margin (dB)	Polarization
4804.00	48.11	-9.08	39.03	54.00	14.97	Vertical
4804.00	49.40	-9.08	40.32	54.00	13.68	Horizontal
Test channel: Middle channel						
Detector: Peak Value						
Frequency (MHz)	Read Level (dBμV)	Factor (dB)	Level (dBμV/m)	Limit (dBμV/m)	Margin (dB)	Polarization
4884.00	57.19	-8.59	48.60	74.00	25.40	Vertical
4884.00	55.04	-8.59	46.45	74.00	27.55	Horizontal
Detector: Average Value						
Frequency (MHz)	Read Level (dBμV)	Factor (dB)	Level (dBμV/m)	Limit (dBμV/m)	Margin (dB)	Polarization
4884.00	47.69	-8.59	39.10	54.00	14.90	Vertical
4884.00	49.42	-8.59	40.83	54.00	13.17	Horizontal
Test channel: Highest channel						
Detector: Peak Value						
Frequency (MHz)	Read Level (dBμV)	Factor (dB)	Level (dBμV/m)	Limit (dBμV/m)	Margin (dB)	Polarization
4960.00	56.56	-8.03	48.53	74.00	25.47	Vertical
4960.00	55.09	-8.03	47.06	74.00	26.94	Horizontal
Detector: Average Value						
Frequency (MHz)	Read Level (dBμV)	Factor (dB)	Level (dBμV/m)	Limit (dBμV/m)	Margin (dB)	Polarization
4960.00	47.46	-8.03	39.43	54.00	14.57	Vertical
4960.00	48.50	-8.03	40.47	54.00	13.53	Horizontal
Remark:						
1. Level = Reading + Factor.						
2. Test Frequency up to 25GHz, and the emission levels of other frequencies are lower than the limit 20dB, not show in test report.						

BEL Tx (LE Coded PHY, S=2)						
Test channel: Lowest channel						
Detector: Peak Value						
Frequency (MHz)	Read Level (dBμV)	Factor (dB)	Level (dBμV/m)	Limit (dBμV/m)	Margin (dB)	Polarization
4804.00	57.26	-9.08	48.18	74.00	25.82	Vertical
4804.00	55.25	-9.08	46.17	74.00	27.83	Horizontal
Detector: Average Value						
Frequency (MHz)	Read Level (dBμV)	Factor (dB)	Level (dBμV/m)	Limit (dBμV/m)	Margin (dB)	Polarization
4804.00	47.67	-9.08	38.59	54.00	15.41	Vertical
4804.00	48.56	-9.08	39.48	54.00	14.52	Horizontal
Test channel: Middle channel						
Detector: Peak Value						
Frequency (MHz)	Read Level (dBμV)	Factor (dB)	Level (dBμV/m)	Limit (dBμV/m)	Margin (dB)	Polarization
4884.00	57.31	-8.59	48.72	74.00	25.28	Vertical
4884.00	55.95	-8.59	47.36	74.00	26.64	Horizontal
Detector: Average Value						
Frequency (MHz)	Read Level (dBμV)	Factor (dB)	Level (dBμV/m)	Limit (dBμV/m)	Margin (dB)	Polarization
4884.00	47.79	-8.59	39.20	54.00	14.80	Vertical
4884.00	48.86	-8.59	40.27	54.00	13.73	Horizontal
Test channel: Highest channel						
Detector: Peak Value						
Frequency (MHz)	Read Level (dBμV)	Factor (dB)	Level (dBμV/m)	Limit (dBμV/m)	Margin (dB)	Polarization
4960.00	56.62	-8.03	48.59	74.00	25.41	Vertical
4960.00	55.22	-8.03	47.19	74.00	26.81	Horizontal
Detector: Average Value						
Frequency (MHz)	Read Level (dBμV)	Factor (dB)	Level (dBμV/m)	Limit (dBμV/m)	Margin (dB)	Polarization
4960.00	47.29	-8.03	39.26	54.00	14.74	Vertical
4960.00	49.22	-8.03	41.19	54.00	12.81	Horizontal
Remark:						
1. Level = Reading + Factor.						
2. Test Frequency up to 25GHz, and the emission levels of other frequencies are lower than the limit 20dB, not show in test report.						

BEL Tx (LE Coded PHY, S=8)						
Test channel: Lowest channel						
Detector: Peak Value						
Frequency (MHz)	Read Level (dBμV)	Factor (dB)	Level (dBμV/m)	Limit (dBμV/m)	Margin (dB)	Polarization
4804.00	56.61	-9.08	47.53	74.00	26.47	Vertical
4804.00	55.07	-9.08	45.99	74.00	28.01	Horizontal
Detector: Average Value						
Frequency (MHz)	Read Level (dBμV)	Factor (dB)	Level (dBμV/m)	Limit (dBμV/m)	Margin (dB)	Polarization
4804.00	47.67	-9.08	38.59	54.00	15.41	Vertical
4804.00	48.84	-9.08	39.76	54.00	14.24	Horizontal
Test channel: Middle channel						
Detector: Peak Value						
Frequency (MHz)	Read Level (dBμV)	Factor (dB)	Level (dBμV/m)	Limit (dBμV/m)	Margin (dB)	Polarization
4884.00	57.01	-8.59	48.42	74.00	25.58	Vertical
4884.00	55.12	-8.59	46.53	74.00	27.47	Horizontal
Detector: Average Value						
Frequency (MHz)	Read Level (dBμV)	Factor (dB)	Level (dBμV/m)	Limit (dBμV/m)	Margin (dB)	Polarization
4884.00	47.74	-8.59	39.15	54.00	14.85	Vertical
4884.00	48.99	-8.59	40.40	54.00	13.60	Horizontal
Test channel: Highest channel						
Detector: Peak Value						
Frequency (MHz)	Read Level (dBμV)	Factor (dB)	Level (dBμV/m)	Limit (dBμV/m)	Margin (dB)	Polarization
4960.00	56.59	-8.03	48.56	74.00	25.44	Vertical
4960.00	55.65	-8.03	47.62	74.00	26.38	Horizontal
Detector: Average Value						
Frequency (MHz)	Read Level (dBμV)	Factor (dB)	Level (dBμV/m)	Limit (dBμV/m)	Margin (dB)	Polarization
4960.00	47.76	-8.03	39.73	54.00	14.27	Vertical
4960.00	48.80	-8.03	40.77	54.00	13.23	Horizontal
Remark:						
1. Level = Reading + Factor.						
2. Test Frequency up to 25GHz, and the emission levels of other frequencies are lower than the limit 20dB, not show in test report.						

-----End of report-----