



中认信通

CHINA CERTIFICATION ICT CO., LTD (DONGGUAN)



SAR TEST REPORT

Applicant: TECNO MOBILE LIMITED

Address: FLAT N 16/F BLOCK B UNIVERSAL INDUSTRIAL CENTRE 19-25
SHAN MEI STREET FOTAN NT HONGKONG

FCC ID: 2ADYY-KL8S

Product Name: Mobile Phone

Standard(s): 47 CFR Part 2(2.1093)

The above device has been tested and found compliant with the requirement of the relative standards by China Certification ICT Co., Ltd (Dongguan)

Report Number: 2403U82760E-20

Date Of Issue: 2024/08/09

Reviewed By: Ken Zong *Ken Zong*

Title: SAR Engineer

Approved By: Karl Gong *Karl Gong*

Title: SAR Engineer

Test Laboratory: China Certification ICT Co., Ltd (Dongguan)

No. 113, Pingkang Road, Dalang Town, Dongguan, Guangdong, China
Tel: +86-769-82016888

SAR TEST RESULTSSUMMARY

Operation Frequency Bands	Highest Reported 1g SAR (W/kg)		Limits (W/kg)	
	Head SAR	Body SAR (Gap 10mm)		
GSM 850	0.74	0.28	1.6	
PCS 1900	0.62	0.27		
WCDMA Band 2	0.06	0.57		
WCDMA Band 4	0.42	0.15		
WCDMA Band 5	0.78	0.17		
LTE Band 2	0.06	0.78		
LTE Band 5	0.32	0.22		
LTE Band 7	0.42	0.65		
LTE Band 12&17	0.34	0.10		
LTE Band 13	0.41	0.13		
LTE Band 41&38	0.56	0.36		
LTE Band 66&4	0.37	0.36		
WLAN 2.4G	0.25	0.11		
WLAN 5.6G	0.47	0.26		
Maximum Simultaneous Transmission SAR				
Items	Head SAR	Body SAR (Gap 10mm)		Hotspot (Gap 10mm)
Sum SAR(W/kg)	1.44	1.4	1.4	1.6
SPLSR	NA	NA	NA	0.04
EUT Received Date:	2024/06/18			
Tested Date:	2024/07/11~2024/07/22			
Tested Result:	Pass			

Note: The test data of LTE Band 42/5G NR and LTE Carrier Aggregation, please refer to FCC ID: 2ADYY-KL8S, SAR report of 2401U82760E-SA, issued by Bay Area Compliance Laboratories Corp. (Shenzhen) on 2024/08/09.

Test Facility

The Test site used by China Certification ICT Co., Ltd (Dongguan) to collect test data is located on the No. 113, Pingkang Road, Dalang Town, Dongguan, Guangdong, China.

The lab has been recognized as the FCC accredited lab under the KDB 974614 D01 and is listed in the FCC Public Access Link (PAL) database, FCC Registration No. : 442868, the FCC Designation No. : CN1314.

Declarations

China Certification ICT Co., Ltd (Dongguan) is not responsible for the authenticity of any test data provided by the applicant. Data included from the applicant that may affect test results are marked with a triangle symbol “▲”. Customer model name, addresses, names, trademarks etc. are not considered data.

Unless otherwise stated the results shown in this test report refer only to the sample(s) tested.

This report cannot be reproduced except in full, without prior written approval of the Company.

This report is valid only with a valid digital signature. The digital signature may be available only under the Adobe software above version 7.0.

This report may contain data that are not covered by the accreditation scope and shall be marked with an asterisk “★”.

CONTENTS

DOCUMENT REVISION HISTORY	6
1. GENERAL INFORMATION	7
1.1 PRODUCT DESCRIPTION FOR DEVICE UNDER TEST (EUT)	7
1.2 TEST SPECIFICATION, METHODS AND PROCEDURES	9
1.3 SAR LIMITS.....	10
1.4 FACILITIES.....	11
2. SAR MEASUREMENT SYSTEM.....	12
3. EQUIPMENT LIST AND CALIBRATION	19
3.1 EQUIPMENTS LIST & CALIBRATION INFORMATION	19
4. SAR MEASUREMENT SYSTEM VERIFICATION	20
4.1 LIQUID VERIFICATION	20
4.2 SYSTEM ACCURACY VERIFICATION	27
4.3 SAR SYSTEM VALIDATION DATA.....	29
5. EUT TEST STRATEGY AND METHODOLOGY	42
5.1 TEST POSITIONS FOR DEVICE OPERATING NEXT TO A PERSON’S EAR	42
5.2 CHEEK/TOUCH POSITION.....	43
5.3 EAR/TILT POSITION.....	43
5.4 TEST POSITIONS FOR BODY-WORN AND OTHER CONFIGURATIONS	44
5.5 TEST DISTANCE FOR SAR EVALUATION.....	45
5.6 SAR EVALUATION PROCEDURE	46
6. CONDUCTED OUTPUT POWER MEASUREMENT	47
6.1 TEST PROCEDURE	47
6.2 DESCRIPTION OF TEST CONFIGURATION.....	48
6.3 MAXIMUM TARGET OUTPUT POWER.....	53
6.4 TEST RESULTS:	55
7. Standalone SAR test exclusion considerations.....	80
7.1 ANTENNA DISTANCE TOEDGE	80
7.2 STANDALONE SAR TEST EXCLUSION CONSIDERATIONS.....	81
7.3 STANDALONE SAR ESTIMATION:	82
7.4 SAR TEST EXCLUSION FOR THE EUT EDGE CONSIDERATIONS RESULT	83
8. SAR MEASUREMENT RESULTS	84

8.1 SAR TEST DATA84

9. Measurement Variability 119

10. DUT HOLDER PERTURBATIONS 120

11. SAR SIMULTANEOUS TRANSMISSION DESCRIPTION 121

11. SAR Plots 129

APPENDIX A MEASUREMENT UNCERTAINTY 130

APPENDIX B EUT TEST POSITION PHOTOS 131

APPENDIX C CALIBRATION CERTIFICATES 132

DOCUMENT REVISION HISTORY

Revision Number	Report Number	Description of Revision	Date of Revision
1.0	2403U82760E-20	Original Report	2024/08/09

1. GENERAL INFORMATION

1.1 Product Description for device under Test (EUT)

EUT Name:	Mobile Phone
EUT Model:	KL8s
Device Type:	Portable
Exposure Category:	Population / Uncontrolled
Antenna Type(s):	Internal Antenna
Body-Worn Accessories:	None
Proximity Sensor:	None
Carrier Aggregation:	Support
Operation modes:	GSM Voice, GPRS/EDGE Data, WCDMA(R99 (Voice+Data), HSUPA/HSDPA), FDD-LTE, TDD-LTE, 5G NR, LTE Carrier Aggregation, WLAN, Bluetooth, NFC
Uplink Intra CA Bands:	CA_5B; CA_7C; CA_38C; CA_41C; CA_66C;
Uplink Inter CA Bands:	CA_B7A-B5A, CA_B2A-B7A, CA_B2A-B4A, CA_B4A-B5A, CA_B4A-B17A, CA_B4A-B7A
Frequency Band:	GSM 850: 824-849 MHz(TX); 869-894 MHz(RX) PCS 1900: 1850-1910 MHz(TX); 1930-1990 MHz(RX) WCDMA Band 2: 1850-1910 MHz(TX); 1930-1990 MHz(RX) WCDMA Band 4: 1710-1755MHz(TX) ; 2110-2155 MHz(RX) WCDMA Band 5: 824-849 MHz(TX); 869-894 MHz(RX) LTE Band 2: 1850-1910 MHz(TX); 1930-1990 MHz(RX) LTE Band 4: 1710-1755MHz(TX) ; 2110-2155 MHz(RX) LTE Band 5: 824-849 MHz(TX); 869-894 MHz(RX) LTE Band 7: 2500-2570 MHz(TX); 2620-2690 MHz(RX) LTE Band 12: 699-716 MHz(TX); 729-746 MHz(RX) LTE Band 13: 777-787 MHz(TX); 746-756 MHz(RX) LTE Band 17: 704-716 MHz(TX); 734-746 MHz(RX) LTE Band 38: 2570-2620 MHz(TX/RX) LTE Band 41: 2496-2690 MHz(TX/RX) LTE Band 66: 1710-1780 MHz(TX) ; 2110-2180 MHz(RX) 5G NR n5: 824-849 MHz(TX); 869-894 MHz(RX) 5G NR n7: 2500-2570 MHz(TX); 2620-2690 MHz(RX) 5G NR n12: 699-716 MHz(TX); 729-746 MHz(RX) 5G NR n38: 2570-2620 MHz(TX/RX) 5G NR n41: 2496-2690 MHz(TX/RX) 5G NR n66: 1710-1780 MHz(TX) ; 2110-2180 MHz(RX) 5G NR n77 Lower: 3450-3550 MHz(TX/RX) 5G NR n77 Middle: 3550-3700 MHz(TX/RX) 5G NR n77 Upper: 3700-3980 MHz(TX/RX) 5G NR n78 Lower: 3450-3550 MHz(TX/RX) 5G NR n78 Middle: 3550-3700 MHz(TX/RX) 5G NR n78 Upper:3700-3800 MHz(TX/RX) WLAN 2.4G: 2412-2462 MHz/2422-2452 MHz(TX/RX) WLAN 5.2G: 5150 -5250 MHz(TX/RX) WLAN 5.3G: 5250 -5350 MHz(TX/RX) WLAN 5.6G: 5470 -5725MHz(TX/RX) WLAN 5.8G: 5725-5850 MHz(TX/RX) Bluetooth(BDR/EDR): 2402-2480MHz(TX/RX) BLE_1M: 2402-2480MHz(TX/RX) BLE_2M: 2404-2478MHz(TX/RX) NFC:13.56MHz
Conducted RF Power:	GSM 850: 30.97dBm; PCS 1900: 26.52dBm WCDMA Band 2: 22.98dBm;WCDMA Band 4: 16.58dBm

	WCDMA Band 5: 23.18dBm LTE Band 2: 19.19dBm; LTE Band 4: 16.92dBm LTE Band 5:19.93dBm;LTE Band 7: 16.11dBm LTE Band 12:25.24dBm; LTE Band 13: 23.78dBm LTE Band 17: 25.1dBm; LTE Band 38:18.32dBm LTE Band 41:18.24dBm; LTE Band 66:16.94dBm WLAN 2.4G Chain 0: 11.36dBm; WLAN 2.4G Chain 1: 14.41dBm WLAN 5.2G: 7.19dBm; WLAN 5.3G: 7.02dBm WLAN 5.6G: 7.93dBm; WLAN 5.8G: 7.38dBm Bluetooth(BDR/EDR) Chain 0: 2.34dBm BLE Chain 0: -4.19dBm Bluetooth(BDR/EDR) Chain 1: 2.36dBm BLE Chain 1: -4.72dBm
Dimensions (L*W*H):	165mm (L) *76mm (W) *8mm (H)
Rated Input Voltage:	DC3.87V from Rechargeable Battery
Serial Number:	2NHZ-1
Normal Operation:	Head and Body

Note: The test data of LTE Band 42/5G NR and LTE Carrier Aggregation, please refer to FCC ID: 2ADYY-KL8S, SAR report of 2401U82760E-SA, issued by Bay Area Compliance Laboratories Corp. (Shenzhen) on 2024/08/09.

1.2 Test Specification, Methods and Procedures

The tests documented in this report were performed in accordance with FCC 47 CFR § 2.1093, IEEE 1528-2013, the following FCC Published RF exposure KDB procedures:

KDB 447498 D01 General RF Exposure Guidance v06
KDB 648474 D04 Handset SAR v01r03
KDB865664 D01 SAR Measurement 100 MHz to 6 GHz v01r04
KDB865664 D02 RF Exposure Reporting v01r02
KDB941225 D01 3G SAR Procedures v03r01
KDB 941225 D05 SAR for LTE Devices v02r05
KDB941225 D06 Hotspot Mode v02r01
KDB 248227 D01 802.11 Wi-Fi SAR v02r02

TCB Workshop April 2019:RF Exposure Procedures

1.3 SAR Limits**FCC Limit**

EXPOSURE LIMITS	SAR (W/kg)	
	(General Population / Uncontrolled Exposure Environment)	(Occupational / Controlled Exposure Environment)
Spatial Average (averaged over the whole body)	0.08	0.4
Spatial Peak (averaged over any 1 g of tissue)	1.60	8.0
Spatial Peak (hands/wrists/feet/ankles averaged over 10 g)	4.0	20.0

Population/Uncontrolled Environments are defined as locations where there is the exposure of individual who have no knowledge or control of their exposure.

Occupational/Controlled Environments are defined as locations where there is exposure that maybe incurred by people who are aware of the potential for exposure (i.e. as a result of employment or occupation).

General Population/Uncontrolled environments Spatial Peak limit 1.6W/kg for 1g SAR applied to the EUT.

1.4 FACILITIES

The Test site used by China Certification ICT Co., Ltd (Dongguan) to collect test data is located on the No. 113, Pingkang Road, Dalang Town, Dongguan,Guangdong, China.

The test sites and measurement facilities used to collect data are located at:

<input checked="" type="checkbox"/> SAR Lab 1	<input type="checkbox"/> SAR Lab 2
---	------------------------------------

2. SAR MEASUREMENTSYSTEM

These measurements were performed with the automated near-field scanning system DASY5 from Schmid& Partner Engineering AG (SPEAG) which is the Fifth generation of the system shown in the figure hereinafter:



DASY5 System Description

The DASY5 system for performing compliance tests consists of the following items:

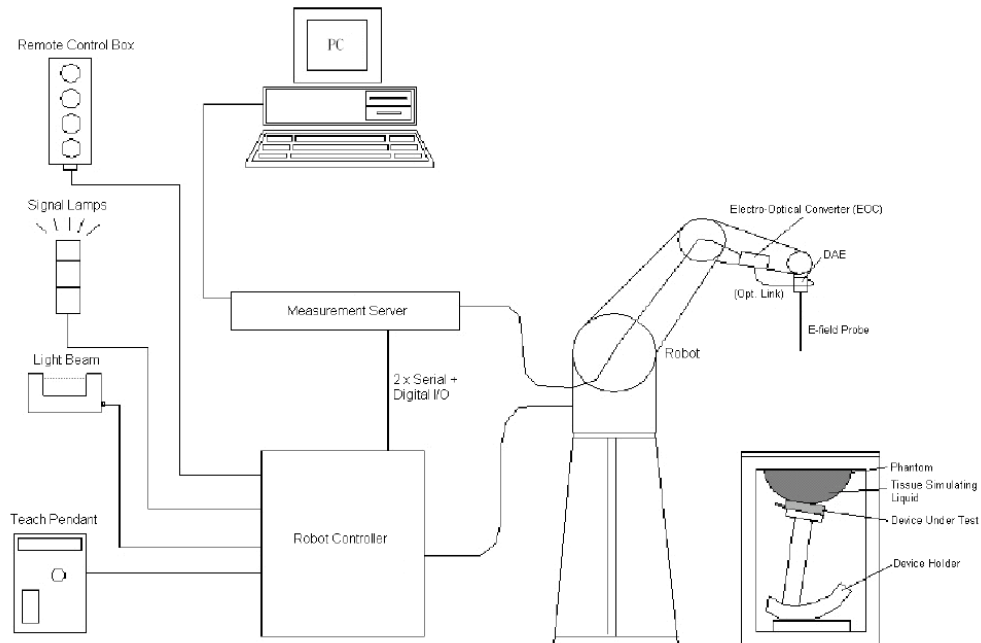

- A standard high precision 6-axis robot with controller, teach pendant and software. An arm extension for accommodating the data acquisition electronics (DAE).
- An isotropic field probe optimized and calibrated for the targeted measurement.
- A data acquisition electronics (DAE) which performs the signal application, signal multiplexing, AD-conversion, offset measurements, mechanical surface detection, collision detection, etc. The unit is battery powered with standard or rechargeable batteries. The signal is optically transmitted to the EOC.
- The Electro-optical converter (EOC) performs the conversion from optical to electrical signals for the digital communication to the DAE. To use optical surface detection, a special version of the EOC is required. The EOC signal is transmitted to the measurement server.
- The function of the measurement server is to perform the time critical tasks such as signal filtering, control of the robot operation and fast movement interrupts.
- The Light Beam used is for probe alignment. This improves the (absolute) accuracy of the probe positioning.
- A computer running Win7 professional operating system and the DASY52 software.
- Remote control and teach pendant as well as additional circuitry for robot safety such as warning lamps, etc.
- The phantom, the device holder and other accessories according to the targeted measurement.

DASY5 Measurement Server

The DASY5 measurement server is based on a PC/104 CPU board with a 400MHz Intel ULVCeleron, 128MB chip-disk and 128MB RAM. The necessary circuits for communication with the DAE4 (or DAE3) electronics box, as well as the 16 bit AD-converter system for optical detection and digital I/O interface are contained on the DASY5 I/O board, which is directly connected to the PC/104 bus of the CPU board.



The measurement server performs all real-time data evaluation of field measurements and surface detection, controls robot movements and handles safety operation. The PC operating system cannot interfere with these time critical processes. All connections are supervised by a watchdog, and disconnection of any of the cables to the measurement server will automatically disarm the robot and disable all program-controlled robot movements. Furthermore, the measurement server is equipped with an expansion port which is reserved for future applications. Please note that this expansion port does not have a standardized point out, and therefore only devices provided by SPEAG can be connected. Devices from any other supplier could seriously damage the measurement server.

Data Acquisition Electronics

The data acquisition electronics (DAE4) consist of a highly sensitive electrometer-grade preamplifier with auto-zeroing, a channel and gain-switching multiplexer, a fast 16 bit AD-converter and a command decoder with a control logic unit. Transmission to the measurement server is accomplished through an optical downlink for data and status information, as well as an optical uplink for commands and the clock.

The mechanical probe mounting device includes two different sensor systems for frontal and sideways probe contacts. They are used for mechanical surface detection and probe collision detection.

The input impedance of both the DAE4 as well as of the DAE3 box is 200M Ω ; the inputs are symmetrical and floating. Common mode rejection is above 80 dB.

EX3DV4 E-Field Probes

Frequency	4 MHz - 10 GHz Linearity: ± 0.2 dB (30 MHz to 10 GHz)
Directivity	± 0.1 dB in TSL (rotation around probe axis) ± 0.3 dB in TSL (rotation normal to probe axis)
Dynamic Range	10 μ W/g to > 100 mW/g Linearity: ± 0.2 dB (noise: typically < 1 μ W/g)
Dimensions	Overall length: 337 mm (Tip: 20 mm) Tip diameter: 2.5 mm (Body: 12 mm) Typical distance from probe tip to dipole centers: 1 mm
Application	High precision dosimetric measurements in any exposure scenario (e.g., very strong gradient fields); the only probe that enables compliance testing for frequencies up to 6 GHz with precision of better 30%.
Compatibility	DASY3, DASY4, DASY52, DASY6, DASY8 SAR, EASY6, EASY4/MRI

Calibration Frequency Points for EX3DV4 E-Field Probes SN: 7329 Calibrated: 2024/3/27

Calibration Frequency Point(MHz)	Frequency Range(MHz)		Conversion Factor		
	From	To	X	Y	Z
750 Head	650	810	8.79	10.07	9.05
900 Head	810	1000	8.42	9.50	8.93
1750 Head	1650	1810	7.56	8.56	7.71
1900 Head	1810	2000	7.37	8.32	7.54
2300 Head	2200	2399	7.21	8.13	7.41
2450 Head	2399	2500	7.05	7.92	7.22
2600 Head	2500	2700	6.91	7.77	7.08
5250 Head	5140	5360	4.96	5.61	5.16
5600 Head	5490	5675	4.38	4.98	4.56
5750 Head	5675	5860	4.54	5.16	4.70

SAM Twin Phantom

The SAM twin phantom is a fiberglass shell phantom with 2mm shell thickness (except the ear region, where shell thickness increases to 6 mm). The phantom has three measurement areas:

- _ Left Head
- _ Right Head
- _ Flat phantom

The phantom table for the DASY systems based on the robots have the size of 100 x 50 x 85 cm (L x W x H). For easy dislocation these tables have fork lift cut outs at the bottom.

The bottom plate contains three pairs of bolts for locking the device holder. The device holder positions are adjusted to the standard measurement positions in the three sections. Only one device holder is necessary if two phantoms are used (e.g., for different liquids)



A white cover is provided to cover the phantom during off-periods to prevent water evaporation and changes in the liquid parameters. Free space scans of devices on top of this phantom cover are possible. Three reference marks are provided on the phantom counter. These reference marks are used to teach the absolute phantom position relative to the robot.

Robots

The DASY5 system uses the high precision industrial robot. The robot offers the same features important for our application:

- High precision (repeatability 0.02mm)
- High reliability (industrial design)
- Low maintenance costs (virtually maintenance free due to direct drive gears; no belt drives)
- Jerk-free straight movements (brushless synchrony motors; no stepper motors)
- Low ELF interference (motor control fields shielded via the closed metallic construction shields)

The above mentioned robots are controlled by the Staubli CS8c robot controllers. All information regarding the use and maintenance of the robot arm and the robot controller is contained on the CDs delivered along with the robot. Paper manuals are available upon request direct from Staubli.

SAR Scan Procedures

Step 1: Power Reference Measurement

The Power Reference Measurement and Power Drift Measurements are for monitoring the power drift of the device under test in the batch process. The minimum distance of probe sensors to surface determines the closest measurement point to phantom surface. The minimum distance of probe sensors to surface is 1.4 mm. This distance cannot be smaller than the distance of sensor calibration points to probe tip as defined in the probe properties.

Step 2: Area Scans

Area scans are defined prior to the measurement process being executed with a user defined variable spacing between each measurement point (integral) allowing low uncertainty measurements to be conducted. Scans defined for FCC applications utilize a 15mm² step integral, with 1.5mm interpolation used to locate the peak SAR area used for zoom scan assessments.

Where the system identifies multiple SAR peaks (which are within 25% of peak value) the system will provide the user with the option of assessing each peak location individually for zoom scan averaging.

Area Scan Parameters extracted from KDB 865664 D01 SAR Measurement 100 MHz to 6 GHz

	≤ 3 GHz	> 3 GHz
Maximum distance from closest measurement point (geometric center of probe sensors) to phantom surface	5 mm ± 1 mm	$\frac{1}{2} \cdot \delta \cdot \ln(2)$ mm ± 0.5 mm
Maximum probe angle from probe axis to phantom surface normal at the measurement location	30° ± 1°	20° ± 1°
Maximum area scan spatial resolution: Δx_{Area} , Δy_{Area}	≤ 2 GHz: ≤ 15 mm 2 – 3 GHz: ≤ 12 mm	3 – 4 GHz: ≤ 12 mm 4 – 6 GHz: ≤ 10 mm
	When the x or y dimension of the test device, in the measurement plane orientation, is smaller than the above, the measurement resolution must be ≤ the corresponding x or y dimension of the test device with at least one measurement point on the test device.	

Step 3: Zoom Scan (Cube Scan Averaging)

The averaging zoom scan volume utilized in the DASY5 software is in the shape of a cube and the side dimension of a 1 g or 10 g mass is dependent on the density of the liquid representing the simulated tissue. A density of 1000 kg/m³ is used to represent the head and body tissue density and not the phantom liquid density, in order to be consistent with the definition of the liquid dielectric properties, i.e. the side length of the 1 g cube is 5mm, with the side length of the 10g cube is 21.5mm.

Zoom Scan Parameters extracted from KDB 865664 D01 SAR Measurement 100 MHz to 6 GHz

			≤ 3 GHz	> 3 GHz
Maximum zoom scan spatial resolution: Δx_{Zoom} , Δy_{Zoom}			≤ 2 GHz: ≤ 8 mm 2 – 3 GHz: ≤ 5 mm*	3 – 4 GHz: ≤ 5 mm* 4 – 6 GHz: ≤ 4 mm*
Maximum zoom scan spatial resolution, normal to phantom surface	uniform grid: $\Delta z_{Zoom}(n)$		≤ 5 mm	3 – 4 GHz: ≤ 4 mm 4 – 5 GHz: ≤ 3 mm 5 – 6 GHz: ≤ 2 mm
	graded grid	$\Delta z_{Zoom}(1)$: between 1 st two points closest to phantom surface	≤ 4 mm	3 – 4 GHz: ≤ 3 mm 4 – 5 GHz: ≤ 2.5 mm 5 – 6 GHz: ≤ 2 mm
		$\Delta z_{Zoom}(n>1)$: between subsequent points	≤ 1.5 · $\Delta z_{Zoom}(n-1)$ mm	
Minimum zoom scan volume	x, y, z	≥ 30 mm	3 – 4 GHz: ≥ 28 mm 4 – 5 GHz: ≥ 25 mm 5 – 6 GHz: ≥ 22 mm	
Note: δ is the penetration depth of a plane-wave at normal incidence to the tissue medium; see IEEE Std 1528-2013 for details. * When zoom scan is required and the <i>reported</i> SAR from the <i>area scan based 1-g SAR estimation</i> procedures of KDB Publication 447498 is ≤ 1.4 W/kg, ≤ 8 mm, ≤ 7 mm and ≤ 5 mm zoom scan resolution may be applied, respectively, for 2 GHz to 3 GHz, 3 GHz to 4 GHz and 4 GHz to 6 GHz.				

Step 4: Power Drift Measurement

The Power Drift Measurement measures the field at the same location as the most recent power reference measurement within the same procedure, and with the same settings. The Power Drift Measurement gives the field difference in dB from the reading conducted within the last Power Reference Measurement. This allows a user to monitor the power drift of the device under test within a batch process. The measurement procedure is the same as Step 1.

When the cube intersects with the surface of the phantom, it is oriented so that 3 vertices touch the surface of the shell or the center of a face is tangent to the surface. The face of the cube closest to the surface is modified in order to conform to the tangent surface.

The zoom scan integer steps can be user defined so as to reduce uncertainty, but normal practice for typical test applications (including FCC) utilize a physical step of 7 x 7 x 7 (5mmx5mmx5mm) providing a volume of 30 mm in the X & Y & Z axis.

Tissue Dielectric Parameters for Head and Body Phantoms

The head tissue dielectric parameters recommended by the IEEE 1528-2013

Recommended Tissue Dielectric Parameters for Head liquid

Table 3—Target dielectric properties of head tissue-equivalent material in the 300 MHz to 6000 MHz frequency range

Frequency (MHz)	Relative permittivity (ϵ_r)	Conductivity (σ) (S/m)
300	45.3	0.87
450	43.5	0.87
750	41.9	0.89
835	41.5	0.90
900	41.5	0.97
1450	40.5	1.20
1500	40.4	1.23
1640	40.2	1.31
1750	40.1	1.37
1800	40.0	1.40
1900	40.0	1.40
2000	40.0	1.40
2100	39.8	1.49
2300	39.5	1.67
2450	39.2	1.80
2600	39.0	1.96
3000	38.5	2.40
3500	37.9	2.91
4000	37.4	3.43
4500	36.8	3.94
5000	36.2	4.45
5200	36.0	4.66
5400	35.8	4.86
5600	35.5	5.07
5800	35.3	5.27
6000	35.1	5.48

NOTE—For convenience, permittivity and conductivity values at some frequencies that are not part of the original data from Drossos et al. [B60] or the extension to 5800 MHz are provided (i.e., the values shown in italics). These values were linearly interpolated between the values in this table that are immediately above and below these values, except the values at 6000 MHz that were linearly extrapolated from the values at 3000 MHz and 5800 MHz.

3. EQUIPMENT LIST AND CALIBRATION

3.1 Equipments List & Calibration Information

Equipment	Model	S/N	Calibration Date	Calibration Due Date
DASY5 Test Software	DASY52.10	N/A	NCR	NCR
DASY5 Measurement Server	DASY5 4.5.12	1567	NCR	NCR
Data Acquisition Electronics	DAE4	1354	2023/11/17	2024/11/16
E-Field Probe	EX3DV4	7329	2024/3/27	2025/3/26
Mounting Device	MD4HHTV5	BJPCTC0152	NCR	NCR
Twin SAM	Twin SAM V5.0	1412	NCR	NCR
Dipole, 750 MHz	D750V3	1230	2023/3/24	2026/3/23
Dipole, 900 MHz	D900V2	1d217	2023/3/24	2026/3/23
Dipole, 1750 MHz	D1750V2	1200	2023/3/27	2026/3/26
Dipole, 1900 MHz	D1900V2	5d251	2023/3/27	2026/3/26
Dipole, 2450 MHz	D2450V2	1102	2023/3/27	2026/3/26
Dipole, 2600 MHz	D2600V2	1206	2023/3/27	2026/3/26
Dipole, 5GHz	D5GHzV2	1245	2023/8/23	2026/8/22
Simulated Tissue Liquid Head(500-9500 MHz)	HBBL600-10000V6	220420-2	Each Time	/
Network Analyzer	8753B	2828A00170	2023/10/17	2024/10/16
Dielectric assessment kit	1319	SM DAK 040 CA	NCR	NCR
MXG Vector Signal Generator	N5182B	MY51350144	2024/4/1	2025/3/31
Power Meter	ML2495A	1106009	2023/8/4	2024/8/3
Pulse Power Sensor	MA2411A	10780	2023/8/4	2024/8/3
Power Amplifier	ZHL-5W-202-S+	416402204	NCR	NCR
Power Amplifier	ZVE-6W-83+	637202210	NCR	NCR
Directional Coupler	441493	520Z	NCR	NCR
Attenuator	20dB, 100W	LN749	NCR	NCR
Attenuator	6dB, 150W	2754	NCR	NCR
Thermometer	DTM3000	3892	2024/4/1	2025/3/31
Thermohygrometer	HTC-1	N/A	2024/4/1	2025/3/31
Radio Communication Analyzer	MT8820C	6201181458	2024/4/1	2025/3/31
Spectrum Analyzer	FSU26	100147	2024/4/1	2025/3/31

4. SAR MEASUREMENT SYSTEM VERIFICATION

4.1 Liquid Verification

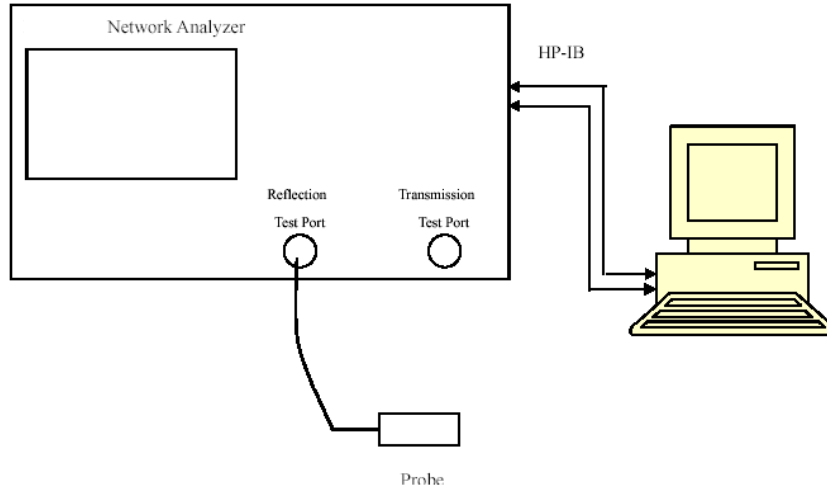

Liquid Verification Setup Block Diagram

Liquid Verification Results

Frequency (MHz)	LiquidType	Liquid Parameter		Target Value		Delta (%)		Tolerance (%)
		ϵ_r	σ (S/m)	ϵ_r	σ (S/m)	$\Delta\epsilon_r$	$\Delta\sigma$	
700	Simulated Tissue Liquid Head	43.097	0.853	42.17	0.89	2.2	-4.16	± 5
710	Simulated Tissue Liquid Head	42.913	0.857	42.11	0.89	1.91	-3.71	± 5
720	Simulated Tissue Liquid Head	42.794	0.862	42.06	0.89	1.75	-3.15	± 5
730	Simulated Tissue Liquid Head	42.568	0.869	42.01	0.89	1.33	-2.36	± 5
740	Simulated Tissue Liquid Head	42.471	0.875	41.95	0.89	1.24	-1.69	± 5
750	Simulated Tissue Liquid Head	42.347	0.882	41.9	0.89	1.07	-0.9	± 5

*Liquid Verification above was performed on 2024/07/16.

Frequency (MHz)	LiquidType	Liquid Parameter		Target Value		Delta (%)		Tolerance (%)
		ϵ_r	σ (S/m)	ϵ_r	σ (S/m)	$\Delta\epsilon_r$	$\Delta\sigma$	
750	Simulated Tissue Liquid Head	42.849	0.869	41.9	0.89	2.26	-2.36	± 5
760	Simulated Tissue Liquid Head	42.724	0.876	41.85	0.89	2.09	-1.57	± 5
770	Simulated Tissue Liquid Head	42.595	0.885	41.81	0.89	1.88	-0.56	± 5
780	Simulated Tissue Liquid Head	42.358	0.896	41.76	0.89	1.43	0.67	± 5
790	Simulated Tissue Liquid Head	42.219	0.901	41.71	0.89	1.22	1.24	± 5
800	Simulated Tissue Liquid Head	41.981	0.908	41.66	0.9	0.77	0.89	± 5

*Liquid Verification above was performed on 2024/07/17.

Frequency (MHz)	LiquidType	Liquid Parameter		Target Value		Delta (%)		Tolerance (%)
		ϵ_r	σ (S/m)	ϵ_r	σ (S/m)	$\Delta\epsilon_r$	$\Delta\sigma$	
810	Simulated Tissue Liquid Head	42.421	0.878	41.62	0.9	1.92	-2.44	± 5
820	Simulated Tissue Liquid Head	42.344	0.889	41.57	0.9	1.86	-1.22	± 5
830	Simulated Tissue Liquid Head	42.325	0.894	41.52	0.9	1.94	-0.67	± 5
840	Simulated Tissue Liquid Head	42.122	0.904	41.5	0.91	1.5	-0.66	± 5
850	Simulated Tissue Liquid Head	41.939	0.912	41.5	0.92	1.06	-0.87	± 5
860	Simulated Tissue Liquid Head	41.879	0.917	41.5	0.93	0.91	-1.4	± 5
870	Simulated Tissue Liquid Head	41.659	0.926	41.5	0.94	0.38	-1.49	± 5
880	Simulated Tissue Liquid Head	41.475	0.923	41.5	0.95	-0.06	-2.84	± 5
890	Simulated Tissue Liquid Head	41.316	0.973	41.5	0.96	-0.44	1.35	± 5
900	Simulated Tissue Liquid Head	41.291	0.981	41.5	0.97	-0.5	1.13	± 5

*Liquid Verification above was performed on 2024/07/15.

Frequency (MHz)	LiquidType	Liquid Parameter		Target Value		Delta (%)		Tolerance (%)
		ϵ_r	σ (S/m)	ϵ_r	σ (S/m)	$\Delta\epsilon_r$	$\Delta\sigma$	
810	Simulated Tissue Liquid Head	42.214	0.872	41.62	0.9	1.43	-3.11	± 5
820	Simulated Tissue Liquid Head	42.034	0.899	41.57	0.9	1.12	-0.11	± 5
830	Simulated Tissue Liquid Head	41.996	0.889	41.52	0.9	1.15	-1.22	± 5
840	Simulated Tissue Liquid Head	41.854	0.911	41.5	0.91	0.85	0.11	± 5
850	Simulated Tissue Liquid Head	41.784	0.883	41.5	0.92	0.68	-4.02	± 5
860	Simulated Tissue Liquid Head	41.546	0.908	41.5	0.93	0.11	-2.37	± 5
870	Simulated Tissue Liquid Head	41.389	0.922	41.5	0.94	-0.27	-1.91	± 5
880	Simulated Tissue Liquid Head	41.303	0.953	41.5	0.95	-0.47	0.32	± 5
890	Simulated Tissue Liquid Head	41.184	0.947	41.5	0.96	-0.76	-1.35	± 5
900	Simulated Tissue Liquid Head	41.156	0.976	41.5	0.97	-0.83	0.62	± 5

*Liquid Verification above was performed on 2024/07/18.

Frequency (MHz)	LiquidType	Liquid Parameter		Target Value		Delta (%)		Tolerance (%)
		ϵ_r	σ (S/m)	ϵ_r	σ (S/m)	$\Delta\epsilon_r$	$\Delta\sigma$ (S/m)	
1700	Simulated Tissue Liquid Head	40.789	1.319	40.15	1.34	1.59	-1.57	±5
1710	Simulated Tissue Liquid Head	40.767	1.325	40.14	1.35	1.56	-1.85	±5
1720	Simulated Tissue Liquid Head	40.732	1.346	40.13	1.35	1.5	-0.3	±5
1730	Simulated Tissue Liquid Head	40.654	1.353	40.12	1.36	1.33	-0.51	±5
1740	Simulated Tissue Liquid Head	40.601	1.358	40.11	1.36	1.22	-0.15	±5
1750	Simulated Tissue Liquid Head	40.543	1.361	40.1	1.37	1.1	-0.66	±5
1760	Simulated Tissue Liquid Head	40.404	1.372	40.08	1.38	0.81	-0.58	±5
1770	Simulated Tissue Liquid Head	40.129	1.378	40.06	1.38	0.17	-0.14	±5
1780	Simulated Tissue Liquid Head	40.046	1.403	40.04	1.39	0.01	0.94	±5
1790	Simulated Tissue Liquid Head	39.749	1.409	40.02	1.39	-0.68	1.37	±5
1800	Simulated Tissue Liquid Head	39.577	1.424	40	1.4	-1.06	1.71	±5

*Liquid Verification above was performed on 2024/07/19.

Frequency (MHz)	LiquidType	Liquid Parameter		Target Value		Delta (%)		Tolerance (%)
		ϵ_r	σ (S/m)	ϵ_r	σ (S/m)	$\Delta\epsilon_r$	$\Delta\sigma$ (S/m)	
1700	Simulated Tissue Liquid Head	40.979	1.328	40.15	1.34	2.06	-0.9	±5
1710	Simulated Tissue Liquid Head	40.865	1.332	40.14	1.35	1.81	-1.33	±5
1720	Simulated Tissue Liquid Head	40.794	1.337	40.13	1.35	1.65	-0.96	±5
1730	Simulated Tissue Liquid Head	40.707	1.347	40.12	1.36	1.46	-0.96	±5
1740	Simulated Tissue Liquid Head	40.498	1.356	40.11	1.36	0.97	-0.29	±5
1750	Simulated Tissue Liquid Head	40.48	1.367	40.1	1.37	0.95	-0.22	±5
1760	Simulated Tissue Liquid Head	40.223	1.374	40.08	1.38	0.36	-0.43	±5
1770	Simulated Tissue Liquid Head	40.014	1.379	40.06	1.38	-0.11	-0.07	±5
1780	Simulated Tissue Liquid Head	39.917	1.386	40.04	1.39	-0.31	-0.29	±5
1790	Simulated Tissue Liquid Head	39.827	1.397	40.02	1.39	-0.48	0.5	±5
1800	Simulated Tissue Liquid Head	39.725	1.406	40	1.4	-0.69	0.43	±5

*Liquid Verification above was performed on 2024/07/20.

Frequency (MHz)	LiquidType	Liquid Parameter		Target Value		Delta (%)		Tolerance (%)
		ϵ_r	σ (S/m)	ϵ_r	σ (S/m)	$\Delta\epsilon_r$	$\Delta\sigma$ (S/m)	
1850	Simulated Tissue Liquid Head	40.268	1.356	40	1.4	0.67	-3.14	± 5
1860	Simulated Tissue Liquid Head	39.929	1.362	40	1.4	-0.18	-2.71	± 5
1870	Simulated Tissue Liquid Head	39.873	1.378	40	1.4	-0.32	-1.57	± 5
1880	Simulated Tissue Liquid Head	39.658	1.393	40	1.4	-0.86	-0.5	± 5
1890	Simulated Tissue Liquid Head	39.611	1.397	40	1.4	-0.97	-0.21	± 5
1900	Simulated Tissue Liquid Head	39.535	1.408	40	1.4	-1.16	0.57	± 5
1910	Simulated Tissue Liquid Head	39.523	1.414	40	1.4	-1.19	1	± 5
1920	Simulated Tissue Liquid Head	39.245	1.417	40	1.4	-1.89	1.21	± 5
1930	Simulated Tissue Liquid Head	39.133	1.438	40	1.4	-2.17	2.71	± 5
1940	Simulated Tissue Liquid Head	39.133	1.449	40	1.4	-2.17	3.5	± 5
1950	Simulated Tissue Liquid Head	39.076	1.452	40	1.4	-2.31	3.71	± 5

*Liquid Verification above was performed on 2024/07/21.

Frequency (MHz)	LiquidType	Liquid Parameter		Target Value		Delta (%)		Tolerance (%)
		ϵ_r	σ (S/m)	ϵ_r	σ (S/m)	$\Delta\epsilon_r$	$\Delta\sigma$ (S/m)	
1850	Simulated Tissue Liquid Head	40.078	1.377	40	1.4	0.2	-1.64	± 5
1860	Simulated Tissue Liquid Head	39.847	1.379	40	1.4	-0.38	-1.5	± 5
1870	Simulated Tissue Liquid Head	39.729	1.395	40	1.4	-0.68	-0.36	± 5
1880	Simulated Tissue Liquid Head	39.727	1.403	40	1.4	-0.68	0.21	± 5
1890	Simulated Tissue Liquid Head	39.563	1.408	40	1.4	-1.09	0.57	± 5
1900	Simulated Tissue Liquid Head	39.387	1.412	40	1.4	-1.53	0.86	± 5
1910	Simulated Tissue Liquid Head	39.323	1.417	40	1.4	-1.69	1.21	± 5
1920	Simulated Tissue Liquid Head	39.309	1.424	40	1.4	-1.73	1.71	± 5
1930	Simulated Tissue Liquid Head	39.284	1.431	40	1.4	-1.79	2.21	± 5
1940	Simulated Tissue Liquid Head	39.026	1.438	40	1.4	-2.43	2.71	± 5
1950	Simulated Tissue Liquid Head	39.009	1.446	40	1.4	-2.48	3.29	± 5

*Liquid Verification above was performed on 2024/07/22.

Frequency (MHz)	LiquidType	Liquid Parameter		Target Value		Delta (%)		Tolerance (%)
		ϵ_r	σ (S/m)	ϵ_r	σ (S/m)	$\Delta\epsilon_r$	$\Delta\sigma$ (S/m)	
2400	Simulated Tissue Liquid Head	39.497	1.739	39.3	1.76	0.5	-1.19	±5
2410	Simulated Tissue Liquid Head	39.438	1.765	39.28	1.77	0.4	-0.28	±5
2420	Simulated Tissue Liquid Head	39.371	1.781	39.26	1.77	0.28	0.62	±5
2430	Simulated Tissue Liquid Head	39.332	1.784	39.24	1.78	0.23	0.22	±5
2440	Simulated Tissue Liquid Head	39.28	1.791	39.22	1.79	0.15	0.06	±5
2450	Simulated Tissue Liquid Head	38.884	1.799	39.2	1.8	-0.81	-0.06	±5
2460	Simulated Tissue Liquid Head	38.694	1.822	39.19	1.81	-1.27	0.66	±5
2470	Simulated Tissue Liquid Head	38.599	1.834	39.17	1.82	-1.46	0.77	±5
2480	Simulated Tissue Liquid Head	38.557	1.845	39.16	1.83	-1.54	0.82	±5
2490	Simulated Tissue Liquid Head	38.501	1.854	39.15	1.84	-1.66	0.76	±5
2500	Simulated Tissue Liquid Head	38.435	1.873	39.13	1.85	-1.78	1.24	±5

*Liquid Verification above was performed on 2024/07/11.

Frequency (MHz)	LiquidType	Liquid Parameter		Target Value		Delta (%)		Tolerance (%)
		ϵ_r	σ (S/m)	ϵ_r	σ (S/m)	$\Delta\epsilon_r$	$\Delta\sigma$ (S/m)	
2500	Simulated Tissue Liquid Head	38.823	1.855	39.13	1.85	-0.78	0.27	±5
2510	Simulated Tissue Liquid Head	38.722	1.858	39.12	1.86	-1.02	-0.11	±5
2520	Simulated Tissue Liquid Head	38.703	1.867	39.11	1.87	-1.04	-0.16	±5
2530	Simulated Tissue Liquid Head	38.656	1.872	39.09	1.89	-1.11	-0.95	±5
2540	Simulated Tissue Liquid Head	38.655	1.901	39.08	1.9	-1.09	0.05	±5
2550	Simulated Tissue Liquid Head	38.583	1.903	39.07	1.91	-1.25	-0.37	±5
2560	Simulated Tissue Liquid Head	38.36	1.906	39.05	1.92	-1.77	-0.73	±5
2570	Simulated Tissue Liquid Head	38.289	1.907	39.04	1.93	-1.92	-1.19	±5
2580	Simulated Tissue Liquid Head	38.258	1.915	39.03	1.94	-1.98	-1.29	±5
2590	Simulated Tissue Liquid Head	38.235	1.945	39.01	1.95	-1.99	-0.26	±5
2600	Simulated Tissue Liquid Head	38.109	1.951	39	1.96	-2.28	-0.46	±5
2610	Simulated Tissue Liquid Head	38.186	1.961	38.99	1.97	-2.06	-0.46	±5
2620	Simulated Tissue Liquid Head	37.921	1.976	38.98	1.98	-2.72	-0.2	±5
2630	Simulated Tissue Liquid Head	37.876	1.999	38.96	1.99	-2.78	0.45	±5
2640	Simulated Tissue Liquid Head	37.829	2.026	38.95	2	-2.88	1.3	±5
2650	Simulated Tissue Liquid Head	37.764	2.053	38.94	2.02	-3.02	1.63	±5

*Liquid Verification above was performed on 2024/07/12.

Frequency (MHz)	LiquidType	Liquid Parameter		Target Value		Delta (%)		Tolerance (%)
		ϵ_r	σ (S/m)	ϵ_r	σ (S/m)	$\Delta\epsilon_r$	$\Delta\sigma$ (S/m)	
2500	Simulated Tissue Liquid Head	39.207	1.861	39.13	1.85	0.2	0.59	±5
2510	Simulated Tissue Liquid Head	39.031	1.873	39.12	1.86	-0.23	0.7	±5
2520	Simulated Tissue Liquid Head	39.022	1.88	39.11	1.87	-0.23	0.53	±5
2530	Simulated Tissue Liquid Head	38.869	1.893	39.09	1.89	-0.57	0.16	±5
2540	Simulated Tissue Liquid Head	38.861	1.901	39.08	1.9	-0.56	0.05	±5
2550	Simulated Tissue Liquid Head	38.829	1.901	39.07	1.91	-0.62	-0.47	±5
2560	Simulated Tissue Liquid Head	38.645	1.909	39.05	1.92	-1.04	-0.57	±5
2570	Simulated Tissue Liquid Head	38.498	1.918	39.04	1.93	-1.39	-0.62	±5
2580	Simulated Tissue Liquid Head	38.463	1.919	39.03	1.94	-1.45	-1.08	±5
2590	Simulated Tissue Liquid Head	38.448	1.935	39.01	1.95	-1.44	-0.77	±5
2600	Simulated Tissue Liquid Head	38.434	1.955	39	1.96	-1.45	-0.26	±5
2610	Simulated Tissue Liquid Head	38.422	1.967	38.99	1.97	-1.46	-0.15	±5
2620	Simulated Tissue Liquid Head	38.303	1.972	38.98	1.98	-1.74	-0.4	±5
2630	Simulated Tissue Liquid Head	38.163	1.993	38.96	1.99	-2.05	0.15	±5
2640	Simulated Tissue Liquid Head	38.066	2.043	38.95	2	-2.27	2.15	±5
2650	Simulated Tissue Liquid Head	38.051	2.074	38.94	2.02	-2.28	2.67	±5

*Liquid Verification above was performed on 2024/07/13.

Frequency (MHz)	LiquidType	Liquid Parameter		Target Value		Delta (%)		Tolerance (%)
		ϵ_r	σ (S/m)	ϵ_r	σ (S/m)	$\Delta\epsilon_r$	$\Delta\sigma$ (S/m)	
2500	Simulated Tissue Liquid Head	39.441	1.821	39.13	1.85	0.79	-1.57	±5
2510	Simulated Tissue Liquid Head	39.266	1.847	39.12	1.86	0.37	-0.7	±5
2520	Simulated Tissue Liquid Head	39.23	1.861	39.11	1.87	0.31	-0.48	±5
2530	Simulated Tissue Liquid Head	39.118	1.901	39.09	1.89	0.07	0.58	±5
2540	Simulated Tissue Liquid Head	39.048	1.908	39.08	1.9	-0.08	0.42	±5
2550	Simulated Tissue Liquid Head	38.983	1.914	39.07	1.91	-0.22	0.21	±5
2560	Simulated Tissue Liquid Head	38.966	1.939	39.05	1.92	-0.22	0.99	±5
2570	Simulated Tissue Liquid Head	38.789	1.941	39.04	1.93	-0.64	0.57	±5
2580	Simulated Tissue Liquid Head	38.626	1.954	39.03	1.94	-1.04	0.72	±5
2590	Simulated Tissue Liquid Head	38.614	1.958	39.01	1.95	-1.02	0.41	±5
2600	Simulated Tissue Liquid Head	38.607	1.967	39	1.96	-1.01	0.36	±5
2610	Simulated Tissue Liquid Head	38.436	1.974	38.99	1.97	-1.42	0.2	±5
2620	Simulated Tissue Liquid Head	38.377	1.985	38.98	1.98	-1.55	0.25	±5
2630	Simulated Tissue Liquid Head	38.197	2.005	38.96	1.99	-1.96	0.75	±5
2640	Simulated Tissue Liquid Head	37.829	2.033	38.95	2	-2.88	1.65	±5
2650	Simulated Tissue Liquid Head	37.821	2.057	38.94	2.02	-2.87	1.83	±5

*Liquid Verification above was performed on 2024/07/14.

Frequency (MHz)	LiquidType	Liquid Parameter		Target Value		Delta (%)		Tolerance (%)
		ϵ_r	σ (S/m)	ϵ_r	σ (S/m)	$\Delta\epsilon_r$	$\Delta\sigma$ (S/m)	
5500	Simulated Tissue Liquid Head	36.187	4.899	35.65	4.97	1.51	-1.43	±5
5510	Simulated Tissue Liquid Head	36.178	4.917	35.64	4.98	1.51	-1.27	±5
5520	Simulated Tissue Liquid Head	36.16	4.918	35.62	4.99	1.52	-1.44	±5
5530	Simulated Tissue Liquid Head	36.101	4.934	35.61	5	1.38	-1.32	±5
5540	Simulated Tissue Liquid Head	35.983	4.957	35.59	5.01	1.1	-1.06	±5
5550	Simulated Tissue Liquid Head	35.969	4.972	35.58	5.02	1.09	-0.96	±5
5560	Simulated Tissue Liquid Head	35.924	4.997	35.56	5.03	1.02	-0.66	±5
5570	Simulated Tissue Liquid Head	35.788	5.004	35.55	5.04	0.67	-0.71	±5
5580	Simulated Tissue Liquid Head	35.695	5.034	35.53	5.05	0.46	-0.32	±5
5590	Simulated Tissue Liquid Head	35.607	5.041	35.52	5.06	0.24	-0.38	±5
5600	Simulated Tissue Liquid Head	35.588	5.051	35.5	5.07	0.25	-0.37	±5
5610	Simulated Tissue Liquid Head	35.476	5.053	35.49	5.08	-0.04	-0.53	±5
5620	Simulated Tissue Liquid Head	35.419	5.11	35.48	5.09	-0.17	0.39	±5
5630	Simulated Tissue Liquid Head	35.406	5.173	35.47	5.1	-0.18	1.43	±5
5640	Simulated Tissue Liquid Head	35.326	5.207	35.46	5.11	-0.38	1.9	±5
5650	Simulated Tissue Liquid Head	35.312	5.215	35.45	5.12	-0.39	1.86	±5

*Liquid Verification above was performed on 2024/07/11.

4.2 System Accuracy Verification

Prior to the assessment, the system validation kit was used to test whether the system was operating within its specifications of $\pm 10\%$. The validation results are tabulated below. And also the corresponding SAR plot is attached as well in the SAR plots files.

The spacing distances in the **System Verification Setup Block Diagram** is given by the following:

- a) $s = 15 \text{ mm} \pm 0,2 \text{ mm}$ for $300 \text{ MHz} \leq f \leq 1\ 000 \text{ MHz}$;
- b) $s = 10 \text{ mm} \pm 0,2 \text{ mm}$ for $1\ 000 \text{ MHz} < f \leq 3\ 000 \text{ MHz}$;
- c) $s = 10 \text{ mm} \pm 0,2 \text{ mm}$ for $3\ 000 \text{ MHz} < f \leq 6\ 000 \text{ MHz}$.

System Verification Setup Block Diagram

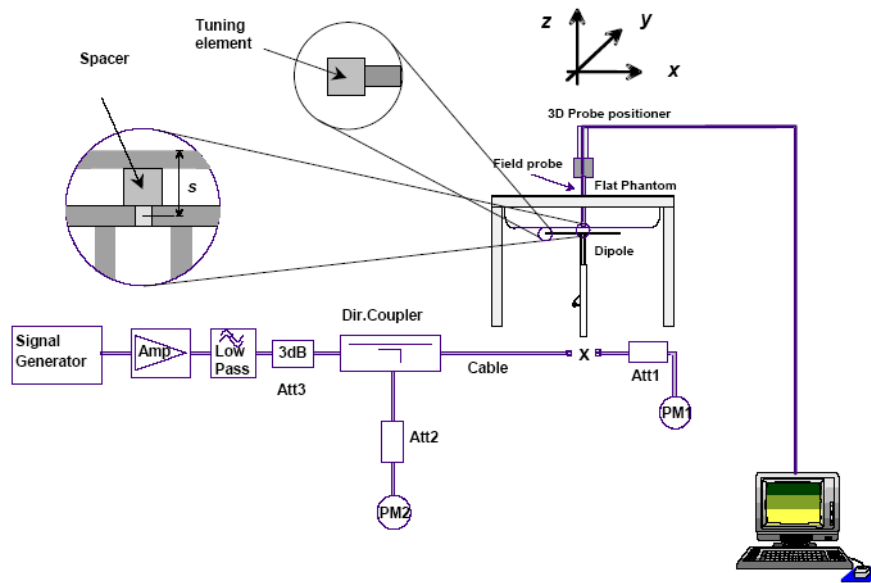

System Accuracy Check Results

Date	Frequency Band	Liquid Type	Input Power (mW)	Measured SAR (W/kg)	Normalized to 1W (W/kg)	Target Value (W/kg)	Delta (%)	Tolerance (%)
2024/07/16	750	Simulated Tissue Liquid Head	100	1g 0.823	8.23	8.49	-3.06	± 10
2024/07/17	750	Simulated Tissue Liquid Head	100	1g 0.836	8.36	8.49	-1.53	± 10
2024/07/15	900	Simulated Tissue Liquid Head	100	1g 1.03	10.3	10.9	-5.5	± 10
2024/07/18	900	Simulated Tissue Liquid Head	100	1g 1.01	10.1	10.9	-7.34	± 10
2024/07/19	1750	Simulated Tissue Liquid Head	100	1g 3.69	36.9	35.8	3.07	± 10
2024/07/20	1750	Simulated Tissue Liquid Head	100	1g 3.72	37.2	35.8	3.91	± 10
2024/07/21	1900	Simulated Tissue Liquid Head	100	1g 3.93	39.3	38.9	1.03	± 10
2024/07/22	1900	Simulated Tissue Liquid Head	100	1g 4.05	40.5	38.9	4.11	± 10
2024/07/11	2450	Simulated Tissue Liquid Head	100	1g 5.21	52.1	50.9	2.36	± 10
2024/07/12	2600	Simulated Tissue Liquid Head	100	1g 5.74	57.4	56	2.5	± 10

2024/07/13	2600	Simulated Tissue Liquid Head	100	1g	5.65	56.5	56	0.89	±10
2024/07/14	2600	Simulated Tissue Liquid Head	100	1g	5.77	57.7	56	3.04	±10
2024/07/11	5600	Simulated Tissue Liquid Head	100	1g	8.31	83.1	81	2.59	±10

*The SAR values above are normalized to 1 Watt forward power.

4.3 SAR SYSTEM VALIDATION DATA

System Performance 750 MHz Head was performed on 2024/7/16

DUT: D750V3; Type: 750 MHz; Serial: 1230

Communication System: CW; Frequency: 750 MHz; Duty Cycle: 1:1
Medium parameters used: $f = 750$ MHz; $\sigma = 0.882$ S/m; $\epsilon_r = 42.347$; $\rho = 1000$ kg/m³
Phantom section: Flat Section

DASY5 Configuration:

- Probe: EX3DV4 - SN7329; ConvF(8.79, 10.07, 9.05)@ 750 MHz; Calibrated: 2024/3/27
- Sensor-Surface: 1.4mm (Mechanical Surface Detection)
- Electronics: DAE4 Sn1354; Calibrated: 2023/11/17
- Phantom: Twin SAM; Type: Twin SAM V5.0; Serial: TP:1412
- Measurement SW: DASY52, Version 52.10 (2); SEMCAD X Version 14.6.12 (7470)

Area Scan (7x15x1): Measurement grid: dx=15mm, dy=15mm
Maximum value of SAR (measured) = 1.16 W/kg

Zoom Scan (5x5x7)/Cube 0: Measurement grid: dx=8mm, dy=8mm, dz=5mm
Reference Value = 30.96 V/m; Power Drift = 0.03 dB
Peak SAR (extrapolated) = 1.36 W/kg
SAR(1 g) = 0.823 W/kg; SAR(10 g) = 0.534 W/kg
Maximum value of SAR (measured) = 1.07 W/kg

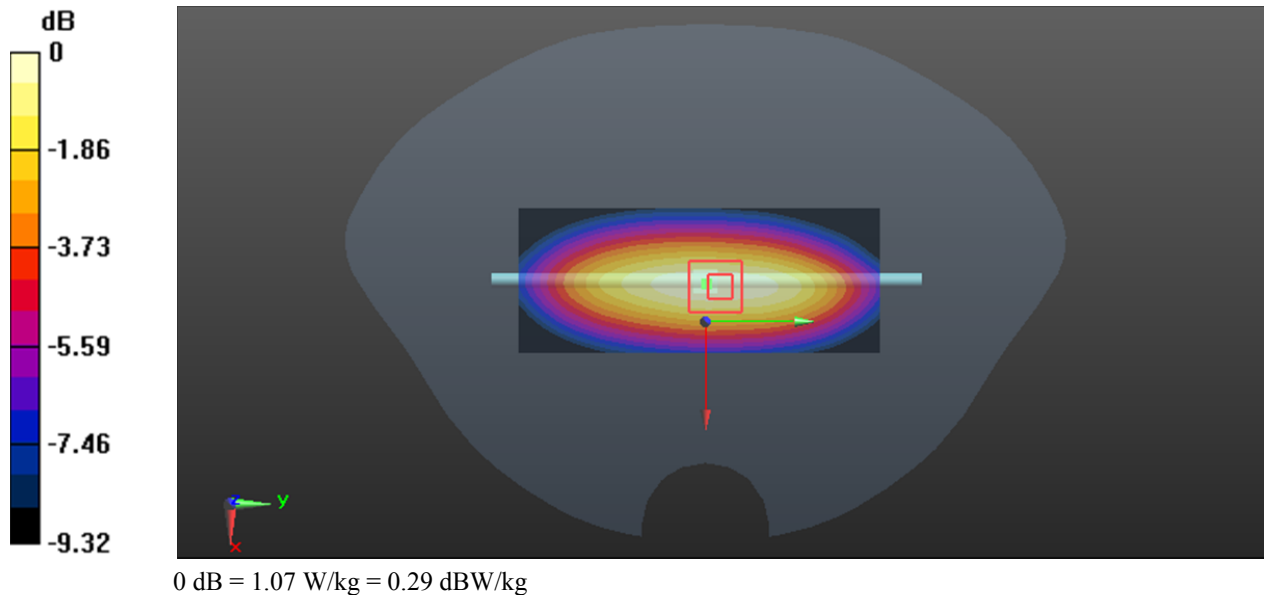

System Performance 750 MHz Head was performed on 2024/7/17**DUT: D750V3; Type: 750 MHz; Serial: 1230**

Communication System: CW; Frequency: 750 MHz; Duty Cycle: 1:1
Medium parameters used: $f = 750$ MHz; $\sigma = 0.869$ S/m; $\epsilon_r = 42.849$; $\rho = 1000$ kg/m³
Phantom section: Flat Section

DASY5 Configuration:

- Probe: EX3DV4 - SN7329; ConvF(8.79, 10.07, 9.05)@ 750 MHz; Calibrated: 2024/3/27
- Sensor-Surface: 1.4mm (Mechanical Surface Detection)
- Electronics: DAE4 Sn1354; Calibrated: 2023/11/17
- Phantom: Twin SAM; Type: Twin SAM V5.0; Serial: TP:1412
- Measurement SW: DASY52, Version 52.10 (2); SEMCAD X Version 14.6.12 (7470)

Area Scan (7x12x1): Measurement grid: dx=15mm, dy=15mm
Maximum value of SAR (measured) = 1.06 W/kg

Zoom Scan (5x5x7)/Cube 0: Measurement grid: dx=8mm, dy=8mm, dz=5mm
Reference Value = 31.76 V/m; Power Drift = -0.04 dB
Peak SAR (extrapolated) = 1.26 W/kg
SAR(1 g) = 0.836 W/kg; SAR(10 g) = 0.553 W/kg
Maximum value of SAR (measured) = 1.09 W/kg

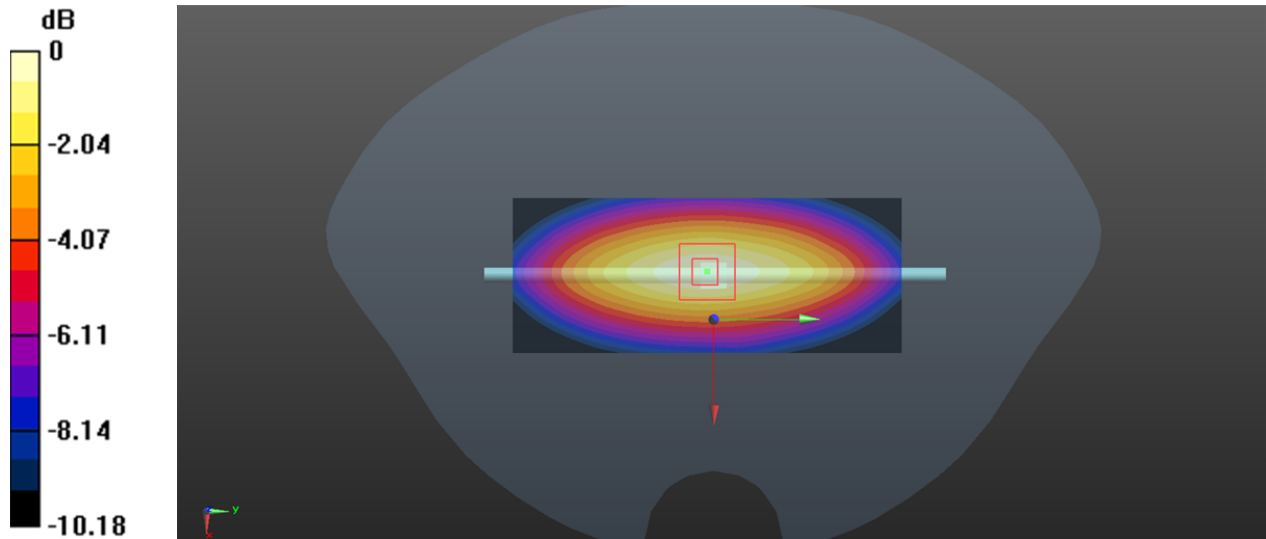

0 dB = 1.09 W/kg = 0.37 dBW/kg

System Performance 900 MHz Head was performed on 2024/7/15**DUT: D900V2; Type: 900 MHz; Serial: 1d217**

Communication System: CW; Frequency: 900 MHz; Duty Cycle: 1:1
Medium parameters used: $f = 900$ MHz; $\sigma = 0.981$ S/m; $\epsilon_r = 41.291$; $\rho = 1000$ kg/m³
Phantom section: Flat Section

DASY5 Configuration:

- Probe: EX3DV4 - SN7329; ConvF(8.42, 9.5, 8.93) @ 900 MHz; Calibrated: 2024/3/27
- Sensor-Surface: 1.4mm (Mechanical Surface Detection)
- Electronics: DAE4 Sn1354; Calibrated: 2023/11/17
- Phantom: Twin SAM; Type: Twin SAM V5.0; Serial: TP:1412
- Measurement SW: DASY52, Version 52.10 (2); SEMCAD X Version 14.6.12 (7470)

Area Scan (5x13x1): Measurement grid: dx=15mm, dy=15mm
Maximum value of SAR (measured) = 1.32 W/kg

Zoom Scan (5x5x7)/Cube 0: Measurement grid: dx=8mm, dy=8mm, dz=5mm
Reference Value = 41.17 V/m; Power Drift = -0.16dB
Peak SAR (extrapolated) = 1.56 W/kg
SAR(1 g) = 1.03 W/kg; SAR(10 g) = 0.687 W/kg
Maximum value of SAR (measured) = 1.29 W/kg

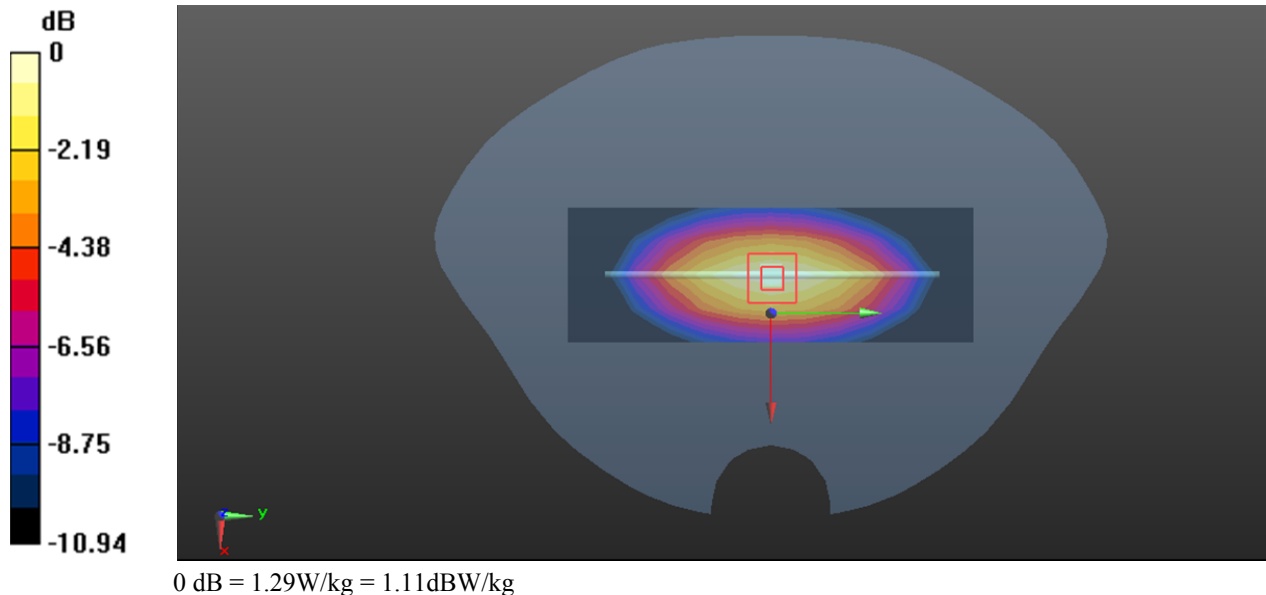

System Performance 900 MHz Head was performed on 2024/7/18**DUT: D900V2; Type: 900 MHz; Serial: 1d217**

Communication System: CW; Frequency: 900 MHz; Duty Cycle: 1:1
Medium parameters used: $f = 900$ MHz; $\sigma = 0.976$ S/m; $\epsilon_r = 41.156$; $\rho = 1000$ kg/m³
Phantom section: Flat Section

DASY5 Configuration:

- Probe: EX3DV4 - SN7329; ConvF(8.42, 9.5, 8.93)@ 900 MHz; Calibrated: 2024/3/27
- Sensor-Surface: 1.4mm (Mechanical Surface Detection)
- Electronics: DAE4 Sn1354; Calibrated: 2023/11/17
- Phantom: Twin SAM; Type: Twin SAM V5.0; Serial: TP:1412
- Measurement SW: DASY52, Version 52.10 (2); SEMCAD X Version 14.6.12 (7470)

Area Scan (6x13x1): Measurement grid: dx=15mm, dy=15mm
Maximum value of SAR (measured) = 1.24 W/kg

Zoom Scan (5x5x7)/Cube 0: Measurement grid: dx=8mm, dy=8mm, dz=5mm
Reference Value = 40.32 V/m; Power Drift = 0.12 dB
Peak SAR (extrapolated) = 1.52 W/kg
SAR(1 g) = 1.01 W/kg; SAR(10 g) = 0.684 W/kg
Maximum value of SAR (measured) = 1.27 W/kg

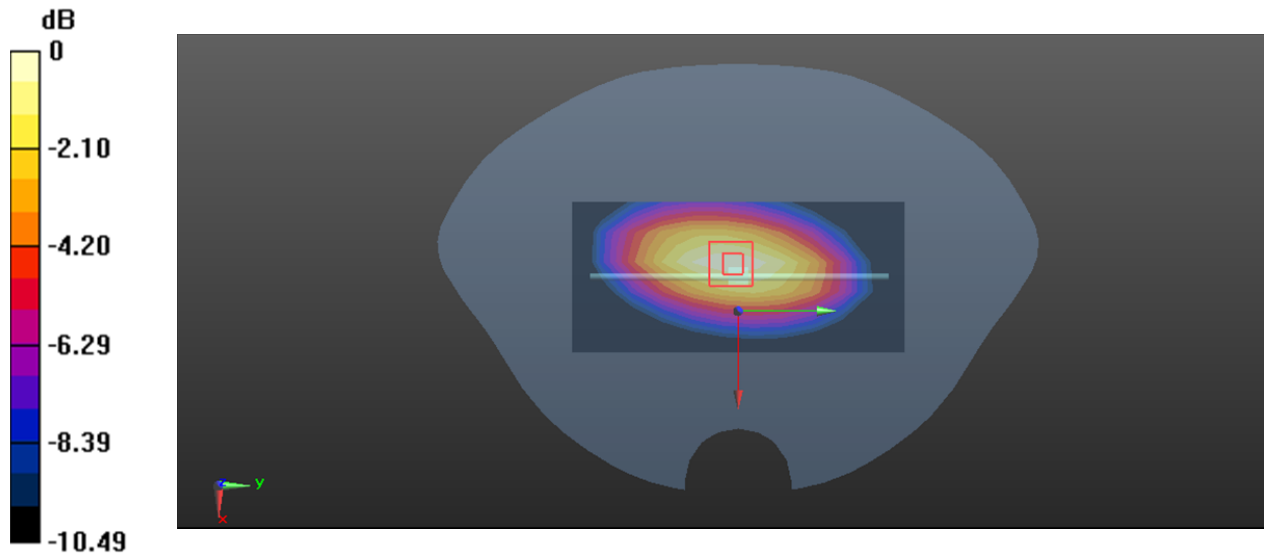

System Performance 1750MHz Head was performed on 2024/7/19**DUT: D1750V2; Type: 1750 MHz; Serial: 1200**

Communication System: CW; Frequency: 1750 MHz; Duty Cycle: 1:1
Medium parameters used: $f = 1750$ MHz; $\sigma = 1.361$ S/m; $\epsilon_r = 40.543$; $\rho = 1000$ kg/m³
Phantom section: Flat Section

DASY5 Configuration:

- Probe: EX3DV4 - SN7329; ConvF(7.56, 8.56, 7.71)@ 1750 MHz; Calibrated: 2024/3/27
- Sensor-Surface: 1.4mm (Mechanical Surface Detection)
- Electronics: DAE4 Sn1354; Calibrated: 2023/11/17
- Phantom: Twin SAM; Type: Twin SAM V5.0; Serial: TP:1412
- Measurement SW: DASY52, Version 52.10 (2); SEMCAD X Version 14.6.12 (7470)

Area Scan (5x7x1): Measurement grid: dx=15mm, dy=15mm
Maximum value of SAR (measured) = 5.84 W/kg

Zoom Scan (5x5x7)/Cube 0: Measurement grid: dx=8mm, dy=8mm, dz=5mm
Reference Value = 64.01 V/m; Power Drift = -0.05 dB
Peak SAR (extrapolated) = 7.02 W/kg
SAR(1 g) = 3.69 W/kg; SAR(10 g) = 1.94 W/kg
Maximum value of SAR (measured) = 5.94 W/kg

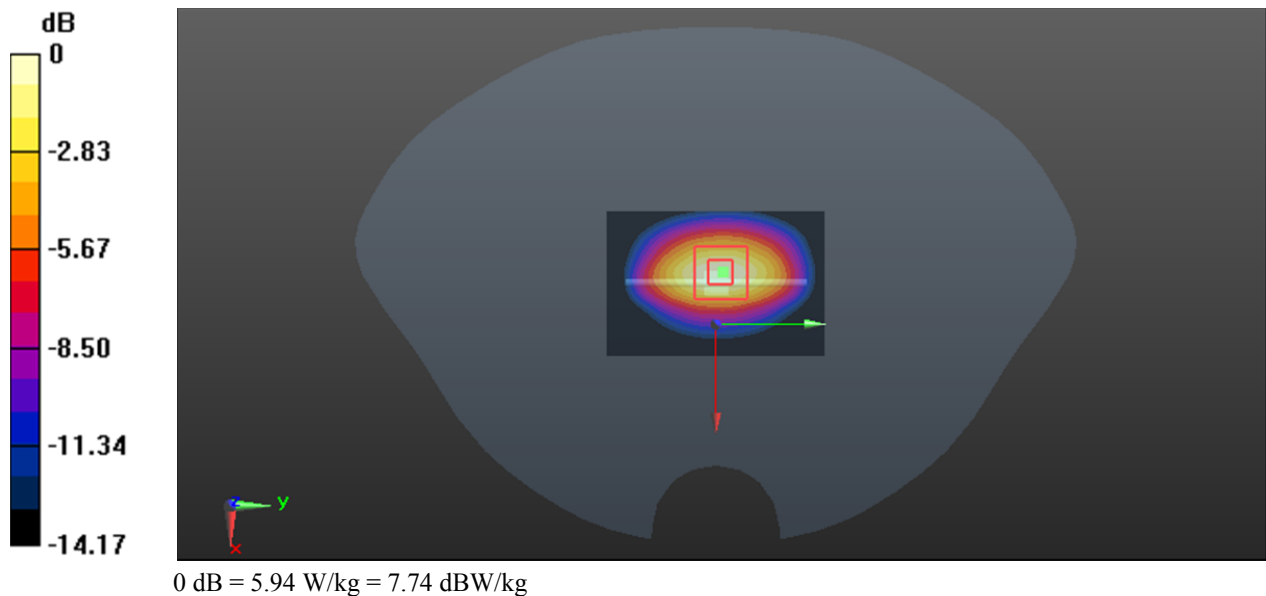

System Performance 1750MHz Head was performed on 2024/7/20**DUT: D1750V2; Type: 1750 MHz; Serial: 1200**

Communication System: CW; Frequency: 1750 MHz; Duty Cycle: 1:1
Medium parameters used: $f = 1750$ MHz; $\sigma = 1.367$ S/m; $\epsilon_r = 40.48$; $\rho = 1000$ kg/m³
Phantom section: Flat Section

DASY5 Configuration:

- Probe: EX3DV4 - SN7329; ConvF(7.56, 8.56, 7.71)@ 1750 MHz; Calibrated: 2024/3/27
- Sensor-Surface: 1.4mm (Mechanical Surface Detection)
- Electronics: DAE4 Sn1354; Calibrated: 2023/11/17
- Phantom: Twin SAM; Type: Twin SAM V5.0; Serial: TP:1412
- Measurement SW: DASY52, Version 52.10 (2); SEMCAD X Version 14.6.12 (7470)

Area Scan (5x6x1): Measurement grid: dx=15mm, dy=15mm
Maximum value of SAR (measured) = 6.16 W/kg

Zoom Scan (5x5x7)/Cube 0: Measurement grid: dx=8mm, dy=8mm, dz=5mm
Reference Value = 66.45 V/m; Power Drift = 0.11 dB
Peak SAR (extrapolated) = 7.14 W/kg
SAR(1 g) = 3.72 W/kg; SAR(10 g) = 1.97 W/kg
Maximum value of SAR (measured) = 5.92 W/kg

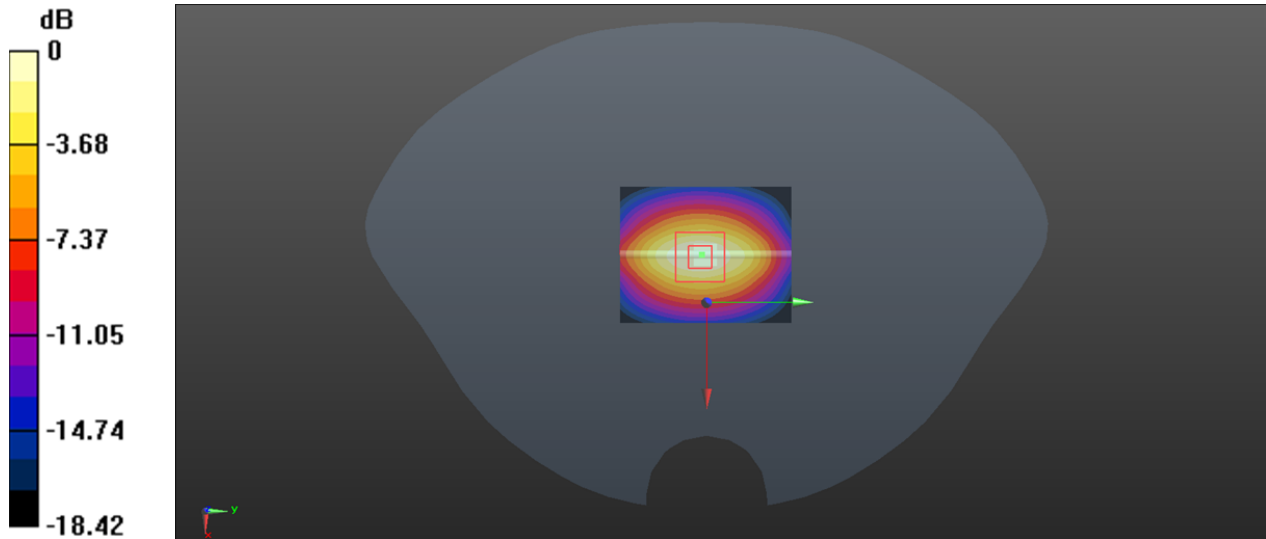

0 dB = 5.92 W/kg = 7.72 dBW/kg

System Performance 1900MHz Head was performed on 2024/7/21**DUT: D1900V2; Type: 1900 MHz; Serial: 5d251**

Communication System: CW; Frequency: 1900 MHz; Duty Cycle: 1:1
Medium parameters used: $f = 1900$ MHz; $\sigma = 1.408$ S/m; $\epsilon_r = 39.535$; $\rho = 1000$ kg/m³
Phantom section: Flat Section

DASY5 Configuration:

- Probe: EX3DV4 - SN7329; ConvF(7.37, 8.32, 7.54)@ 1900 MHz; Calibrated: 2024/3/27
- Sensor-Surface: 1.4mm (Mechanical Surface Detection)
- Electronics: DAE4 Sn1354; Calibrated: 2023/11/17
- Phantom: Twin SAM; Type: Twin SAM V5.0; Serial: TP:1412
- Measurement SW: DASY52, Version 52.10 (2); SEMCAD X Version 14.6.12 (7470)

Area Scan (5x7x1): Measurement grid: dx=15mm, dy=15mm
Maximum value of SAR (measured) = 6.16 W/kg

Zoom Scan (5x5x7)/Cube 0: Measurement grid: dx=8mm, dy=8mm, dz=5mm
Reference Value = 63.75 V/m; Power Drift = -0.07 dB
Peak SAR (extrapolated) = 7.36 W/kg
SAR(1 g) = 3.93 W/kg; SAR(10 g) = 2.07 W/kg
Maximum value of SAR (measured) = 6.06 W/kg

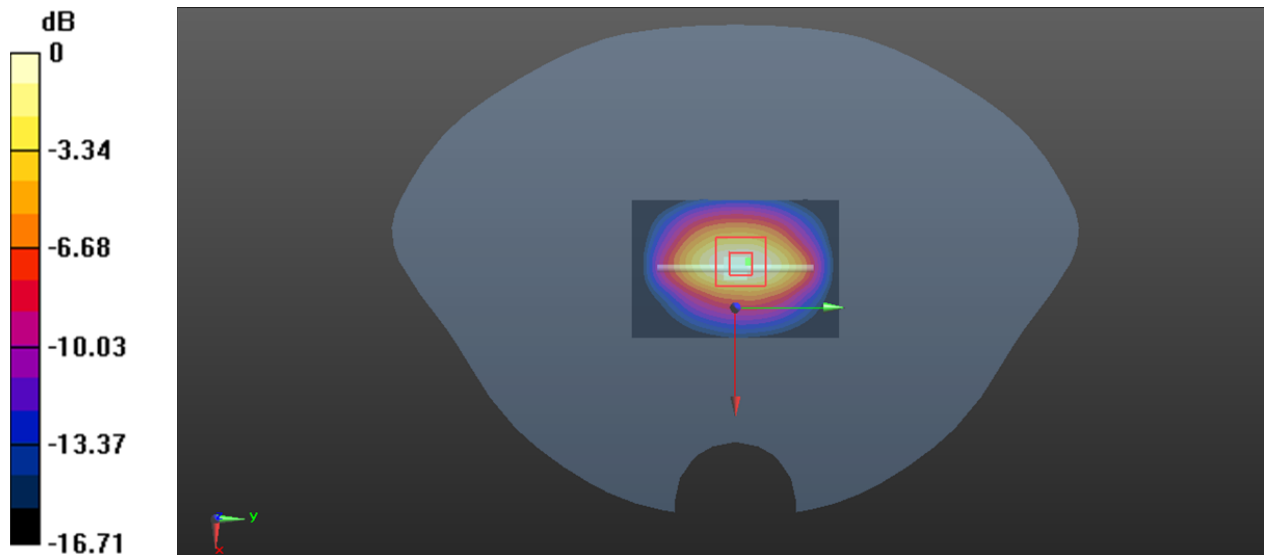

0 dB = 6.06 W/kg = 7.82 dBW/kg

System Performance 1900MHz Head was performed on 2024/7/22**DUT: D1900V2; Type: 1900 MHz; Serial: 5d251**

Communication System: CW; Frequency: 1900 MHz; Duty Cycle: 1:1
Medium parameters used: $f = 1900$ MHz; $\sigma = 1.412$ S/m; $\epsilon_r = 39.387$; $\rho = 1000$ kg/m³
Phantom section: Flat Section

DASY5 Configuration:

- Probe: EX3DV4 - SN7329; ConvF(7.37, 8.32, 7.54)@ 1900 MHz; Calibrated: 2024/3/27
- Sensor-Surface: 1.4mm (Mechanical Surface Detection)
- Electronics: DAE4 Sn1354; Calibrated: 2023/11/17
- Phantom: Twin SAM; Type: Twin SAM V5.0; Serial: TP:1412
- Measurement SW: DASY52, Version 52.10 (2); SEMCAD X Version 14.6.12 (7470)

Area Scan (5x6x1): Measurement grid: dx=15mm, dy=15mm
Maximum value of SAR (measured) = 6.84 W/kg

Zoom Scan (5x5x7)/Cube 0: Measurement grid: dx=8mm, dy=8mm, dz=5mm
Reference Value = 65.72 V/m; Power Drift = 0.05 dB
Peak SAR (extrapolated) = 8.08 W/kg
SAR(1 g) = 4.05 W/kg; SAR(10 g) = 2.12 W/kg
Maximum value of SAR (measured) = 6.57 W/kg

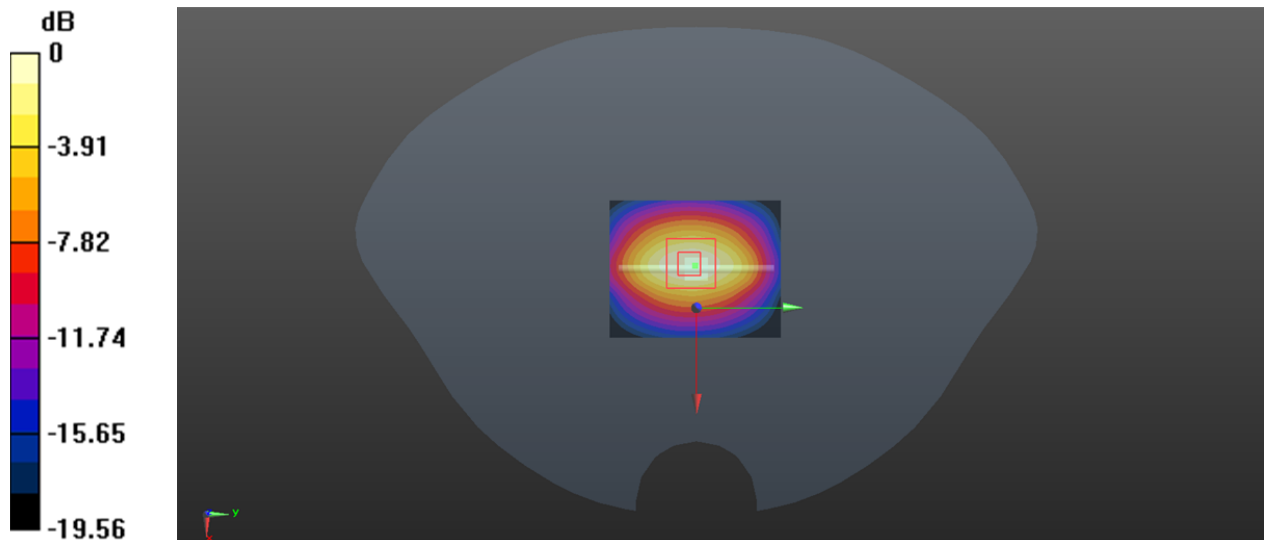

0 dB = 6.57 W/kg = 8.18 dBW/kg

System Performance 2450MHz Head was performed on 2024/7/11**DUT: D2450V2; Type: 2450 MHz; Serial: 1102**

Communication System: CW; Frequency: 2450 MHz; Duty Cycle: 1:1
Medium parameters used: $f = 2450$ MHz; $\sigma = 1.799$ S/m; $\epsilon_r = 38.884$; $\rho = 1000$ kg/m³
Phantom section: Flat Section

DASY5 Configuration:

- Probe: EX3DV4 - SN7329; ConvF(7.05, 7.92, 7.22) @ 2450 MHz; Calibrated: 2024/3/27
- Sensor-Surface: 1.4mm (Mechanical Surface Detection)
- Electronics: DAE4 Sn1354; Calibrated: 2023/11/17
- Phantom: Twin SAM; Type: Twin SAM V5.0; Serial: TP:1412
- Measurement SW: DASY52, Version 52.10 (2); SEMCAD X Version 14.6.12 (7470)

Area Scan (6x6x1): Measurement grid: dx=12mm, dy=12mm
Maximum value of SAR (measured) = 9.51 W/kg

Zoom Scan (7x7x7)/Cube 0: Measurement grid: dx=5mm, dy=5mm, dz=5mm
Reference Value = 55.99 V/m; Power Drift = -0.04 dB
Peak SAR (extrapolated) = 11.3 W/kg
SAR(1 g) = 5.21 W/kg; SAR(10 g) = 2.39 W/kg
Maximum value of SAR (measured) = 8.83 W/kg

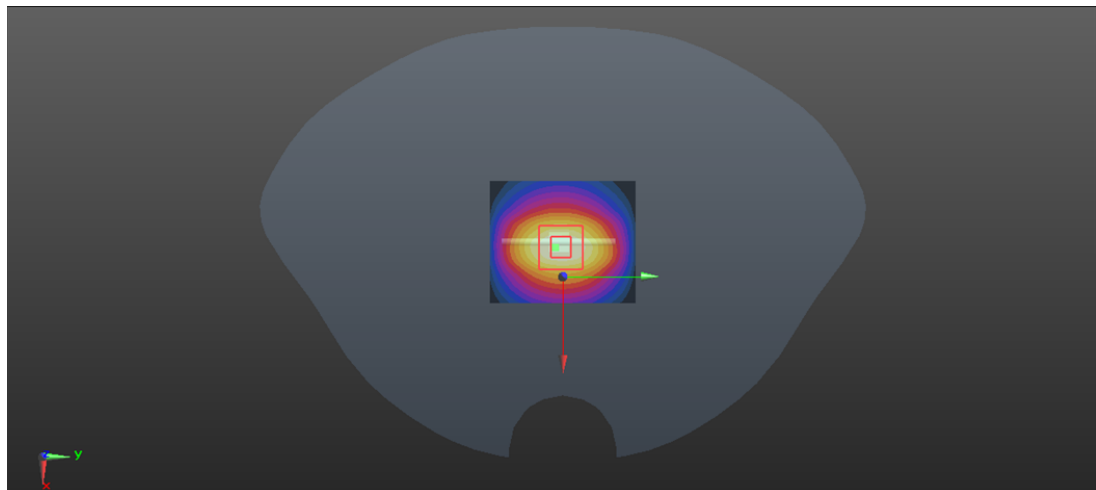
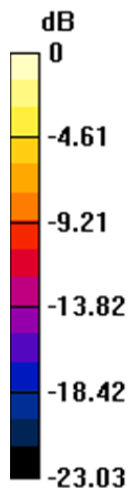

0 dB = 8.83 W/kg = 9.46 dBW/kg

System Performance 2600MHzHead was performed on 2024/7/12**DUT: D2600V2; Type: 2600 MHz; Serial: 1206**

Communication System: CW; Frequency: 2600 MHz; Duty Cycle: 1:1
Medium parameters used: $f = 2600$ MHz; $\sigma = 1.951$ S/m; $\epsilon_r = 38.109$; $\rho = 1000$ kg/m³
Phantom section: Flat Section

DASY5 Configuration:

- Probe: EX3DV4 - SN7329; ConvF(6.91, 7.77, 7.08) @ 2600 MHz; Calibrated: 2024/3/27
- Sensor-Surface: 1.4mm (Mechanical Surface Detection)
- Electronics: DAE4 Sn1354; Calibrated: 2023/11/17
- Phantom: Twin SAM; Type: Twin SAM V5.0; Serial: TP:1412
- Measurement SW: DASY52, Version 52.10 (2); SEMCAD X Version 14.6.12 (7470)

Area Scan (6x8x1): Measurement grid: dx=12 mm, dy=12mm
Maximum value of SAR (measured) = 11.1 W/kg

Zoom Scan (7x7x7)/Cube 0: Measurement grid: dx=5mm, dy=5mm, dz=5mm
Reference Value = 64.06 V/m; Power Drift = -0.18 dB
Peak SAR (extrapolated) = 12.8 W/kg
SAR(1 g) = 5.74 W/kg; SAR(10 g) = 2.62 W/kg
Maximum value of SAR (measured) = 9.25 W/kg

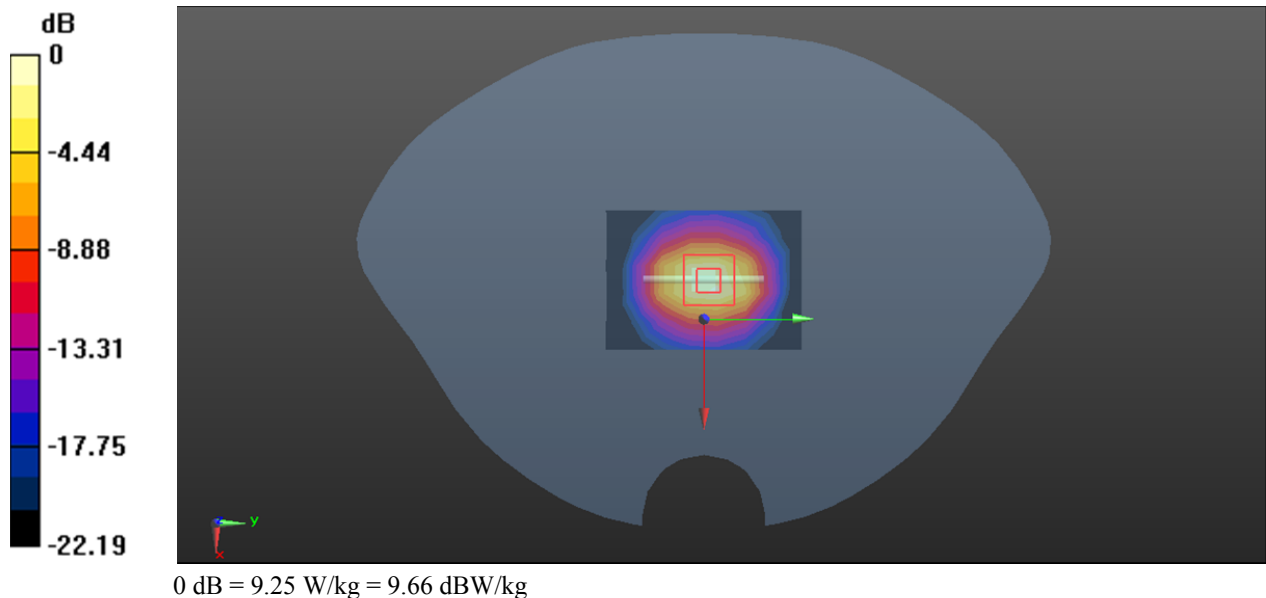

System Performance 2600MHz Head was performed on 2024/7/13**DUT: D2600V2; Type: 2600 MHz; Serial: 1206**

Communication System: CW; Frequency: 2600 MHz; Duty Cycle: 1:1
Medium parameters used: $f = 2600$ MHz; $\sigma = 1.955$ S/m; $\epsilon_r = 38.434$; $\rho = 1000$ kg/m³
Phantom section: Flat Section

DASY5 Configuration:

- Probe: EX3DV4 - SN7329; ConvF(6.91, 7.77, 7.08) @ 2600 MHz; Calibrated: 2024/3/27
- Sensor-Surface: 1.4mm (Mechanical Surface Detection)
- Electronics: DAE4 Sn1354; Calibrated: 2023/11/17
- Phantom: Twin SAM; Type: Twin SAM V5.0; Serial: TP:1412
- Measurement SW: DASY52, Version 52.10 (2); SEMCAD X Version 14.6.12 (7470)

Area Scan (6x6x1): Measurement grid: dx=12 mm, dy=12mm
Maximum value of SAR (measured) = 8.56 W/kg

Zoom Scan (7x7x7)/Cube 0: Measurement grid: dx=5mm, dy=5mm, dz=5mm
Reference Value = 59.71 V/m; Power Drift = 0.14 dB
Peak SAR (extrapolated) = 10.4 W/kg
SAR(1 g) = 5.65 W/kg; SAR(10 g) = 2.51 W/kg
Maximum value of SAR (measured) = 8.12 W/kg

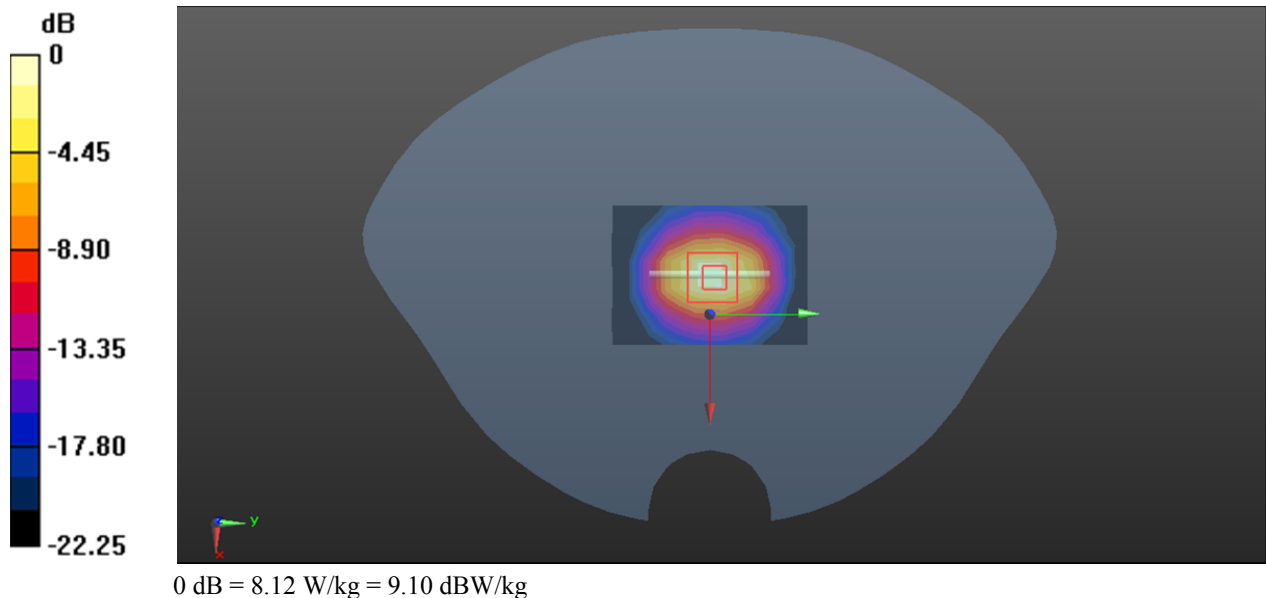

System Performance 2600MHz Head was performed on 2024/7/14**DUT: D2600V2; Type: 2600 MHz; Serial: 1206**

Communication System: CW; Frequency: 2600 MHz; Duty Cycle: 1:1
Medium parameters used: $f = 2600$ MHz; $\sigma = 1.967$ S/m; $\epsilon_r = 38.607$; $\rho = 1000$ kg/m³
Phantom section: Flat Section

DASY5 Configuration:

- Probe: EX3DV4 - SN7329; ConvF(6.91, 7.77, 7.08) @ 2600 MHz; Calibrated: 2024/3/27
- Sensor-Surface: 1.4mm (Mechanical Surface Detection)
- Electronics: DAE4 Sn1354; Calibrated: 2023/11/17
- Phantom: Twin SAM; Type: Twin SAM V5.0; Serial: TP:1412
- Measurement SW: DASY52, Version 52.10 (2); SEMCAD X Version 14.6.12 (7470)

Area Scan (6x8x1): Measurement grid: dx=12 mm, dy=12mm
Maximum value of SAR (measured) = 8.42 W/kg

Zoom Scan (7x7x7)/Cube 0: Measurement grid: dx=5mm, dy=5mm, dz=5mm
Reference Value = 67.24 V/m; Power Drift = -0.18 dB
Peak SAR (extrapolated) = 12.3 W/kg
SAR(1 g) = 5.77 W/kg; SAR(10 g) = 2.64 W/kg
Maximum value of SAR (measured) = 9.67 W/kg

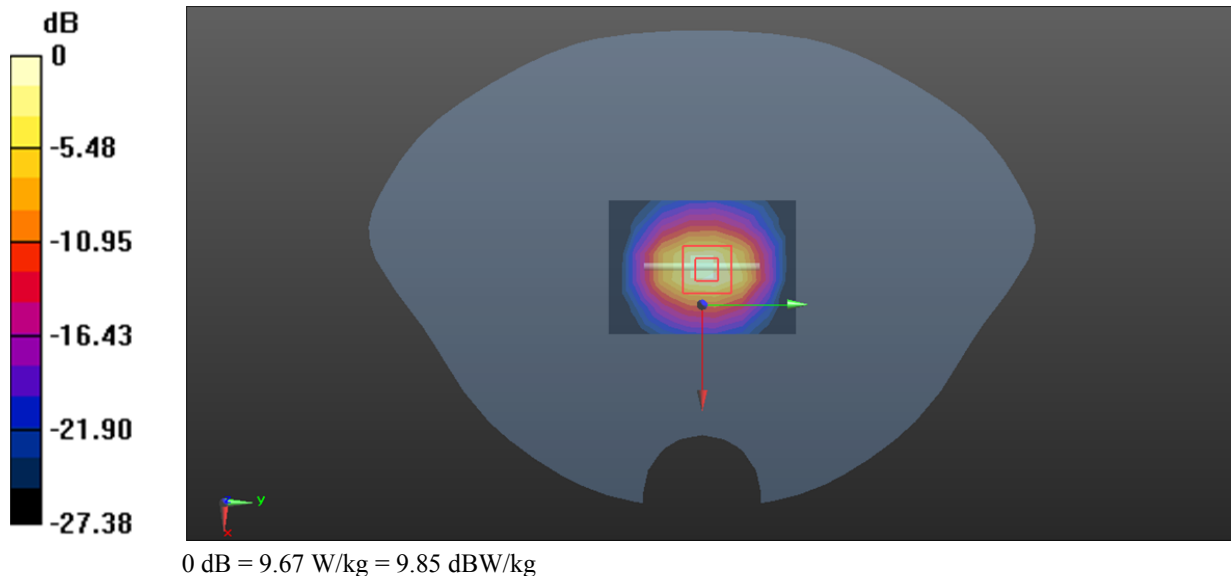

System Performance 5600MHz Head was performed on 2024/7/11**DUT: D5GHzV2; Type: 5600MHz; Serial: SN:1245**

Communication System: UID 0, CW (0); Frequency: 5600 MHz; Duty Cycle: 1:1
Medium parameters used: $f = 5600$ MHz; $\sigma = 5.051$ S/m; $\epsilon_r = 35.588$; $\rho = 1000$ kg/m³
Phantom section: Flat Section

DASY5 Configuration:

- Probe: EX3DV4 - SN7329; ConvF(4.38, 4.98, 4.56) @ 5600 MHz; Calibrated: 2024/3/27
- Sensor-Surface: 1.4mm (Mechanical Surface Detection)
- Electronics: DAE4 Sn1354; Calibrated: 2023/11/17
- Phantom: Twin SAM; Type: Twin SAM V5.0; Serial: TP:1412
- Measurement SW: DASY52, Version 52.10 (2); SEMCAD X Version 14.6.12 (7470)

Area Scan (5x6x1): Measurement grid: dx=10mm, dy=10mm
Maximum value of SAR (measured) = 17.2 W/kg

Zoom Scan (8x8x12)/Cube 0: Measurement grid: dx=4mm, dy=4mm, dz=2mm
Reference Value = 42.74 V/m; Power Drift = -0.04 dB
Peak SAR (extrapolated) = 38.6 W/kg
SAR(1 g) = 8.31 W/kg; SAR(10 g) = 2.36 W/kg
Maximum value of SAR (measured) = 21.9 W/kg

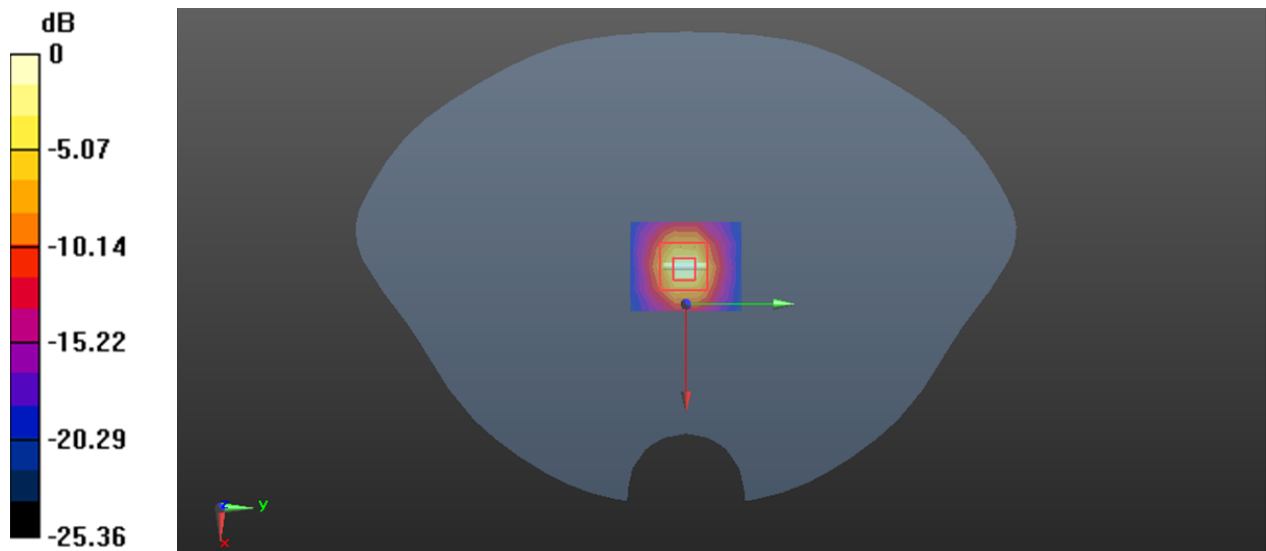

0 dB = 21.9 W/kg = 13.40 dBW/kg

5. EUT TEST STRATEGY AND METHODOLOGY

5.1 Test Positions for Device Operating Next to a Person's Ear

This category includes most wireless handsets with fixed, retractable or internal antennas located toward the top half of the device, with or without a foldout, sliding or similar keypad cover. The handset should have its earpiece located within the upper ¼ of the device, either along the centerline or off-centered, as perceived by its users. This type of handset should be positioned in a normal operating position with the “test device reference point” located along the “vertical centerline” on the front of the device aligned to the “ear reference point”. The “test device reference point” should be located at the same level as the center of the earpiece region. The “vertical centerline” should bisect the front surface of the handset at its top and bottom edges. A “ear reference point” is located on the outer surface of the head phantom on each ear spacer. It is located 1.5 cm above the center of the ear canal entrance in the “phantom reference plane” defined by the three lines joining the center of each “ear reference point” (left and right) and the tip of the mouth.

A handset should be initially positioned with the earpiece region pressed against the ear spacer of a head phantom. For the SCC-34/SC-2 head phantom, the device should be positioned parallel to the “N-F” line defined along the base of the ear spacer that contains the “ear reference point”. For interim head phantoms, the device should be positioned parallel to the cheek for maximum RF energy coupling. The “test device reference point” is aligned to the “ear reference point” on the head phantom and the “vertical centerline” is aligned to the “phantom reference plane”. This is called the “initial ear position”. While maintaining these three alignments, the body of the handset is gradually adjusted to each of the following positions for evaluating SAR:

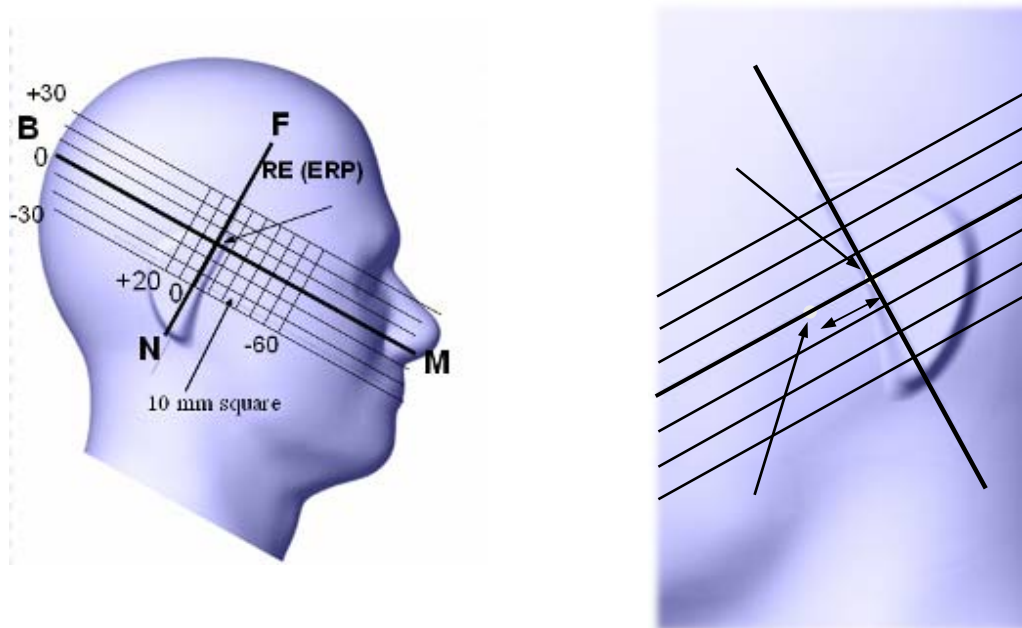

5.2 Cheek/Touch Position

The device is brought toward the mouth of the head phantom by pivoting against the “ear reference point” or along the “N-F” line for the SCC-34/SC-2 head phantom.

This test position is established:

When any point on the display, keypad or mouthpiece portions of the handset is in contact with the phantom.

(or) When any portion of a foldout, sliding or similar keypad cover opened to its intended self-adjusting normal use position is in contact with the cheek or mouth of the phantom.

For existing head phantoms – when the handset loses contact with the phantom at the pivoting point, rotation should continue until the device touches the cheek of the phantom or breaks its last contact from the ear spacer.

Cheek /Touch Position

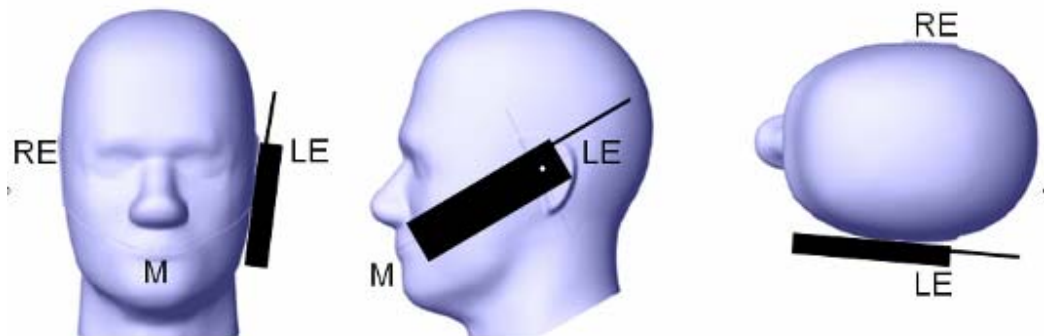

5.3 Ear/Tilt Position

With the handset aligned in the “Cheek/Touch Position”:

1) If the earpiece of the handset is not in full contact with the phantom’s ear spacer (in the “Cheek/Touch position”) and the peak SAR location for the “Cheek/Touch” position is located at the ear spacer region or corresponds to the earpiece region of the handset, the device should be returned to the “initial ear position” by rotating it away from the mouth until the earpiece is in full contact with the ear spacer.

2) (otherwise) The handset should be moved (translated) away from the cheek perpendicular to the line passes through both “ear reference points” (note: one of these ear reference points may not physically exist on a split head model) for approximate 2-3 cm. While it is in this position, the device handset is tilted away from the mouth with respect to the “test device reference point” until the inside angle between the vertical centerline on the front surface of the phone and the horizontal line passing through the ear reference point is by 15° to 80° . After the tilt, it is then moved (translated) back toward the head perpendicular to the line passes through both “ear reference points” until the device touches the phantom or the ear spacer. If the antenna touches the head first, the positioning process should be repeated with a tilt angle less than 15° so that the device and its antenna would touch the phantom simultaneously. This test position may require a device holder or positioner to achieve the translation and tilting with acceptable positioning repeatability.

If a device is also designed to transmit with its keypad cover closed for operating in the head position, such positions should also be considered in the SAR evaluation. The device should be tested on the left and

right side of the head phantom in the “Cheek/Touch” and “Ear/Tilt” positions. When applicable, each configuration should be tested with the antenna in its fully extended and fully retracted positions. These test configurations should be tested at the high, middle and low frequency channels of each operating mode; for example, AMPS, CDMA, and TDMA. If the SAR measured at the middle channel for each test configuration (left, right, Cheek/Touch, Tilt/Ear, extended and retracted) is at least 2.0 dB lower than the SAR limit, testing at the high and low channels is optional for such test configuration(s). If the transmission band of the test device is less than 10 MHz, testing at the high and low frequency channels is optional.

Ear /Tilt 15° Position

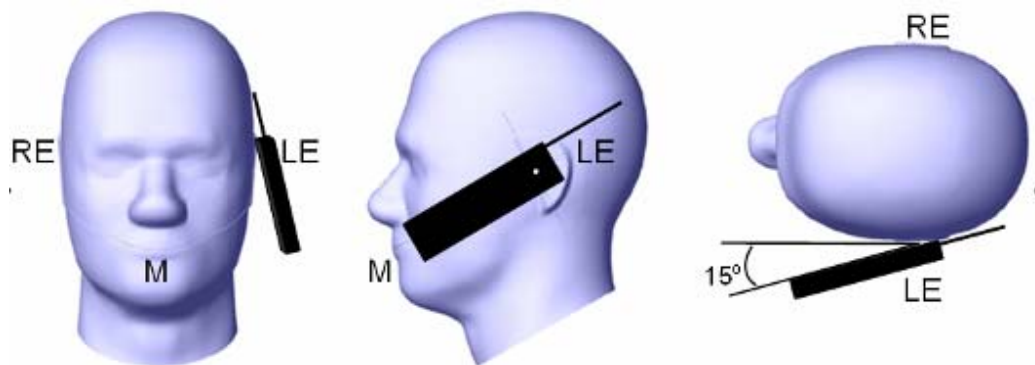

5.4 Test positions for body-worn and other configurations

Body-worn operating configurations should be tested with the belt-clips and holsters attached to the device and positioned against a flat phantom in normal use configurations. Devices with a headset output should be tested with a headset connected to the device. When multiple accessories that do not contain metallic components are supplied with the device, the device may be tested with only the accessory that dictates the closest spacing to the body. When multiple accessories that contain metallic components are supplied with the device, the device must be tested with each accessory that contains a unique metallic component. If multiple accessories share an identical metallic component (e.g., the same metallic belt-clip used with different holsters with no other metallic components), only the accessory that dictates the closest spacing to the body must be tested.

Body-worn accessories may not always be supplied or available as options for some devices that are intended to be authorized for body-worn use. A separation distance of 1.5 cm between the back of the device and a flat phantom is recommended for testing body-worn SAR compliance under such circumstances. Other separation distances may be used, but they should not exceed 2.5 cm. In these cases, the device may use body-worn accessories that provide a separation distance greater than that tested for the device provided however that the accessory contains no metallic components.

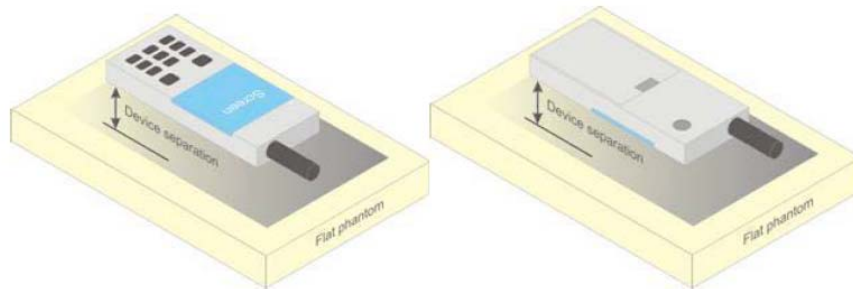

Figure 5 – Test positions for body-worn devices

5.5 Test Distance for SAR Evaluation

In this case the EUT(Equipment Under Test) is set 10mm away from the phantom, the test distance is 10mm.

5.6 SAR Evaluation Procedure

The evaluation was performed with the following procedure:

Step 1: Measurement of the SAR value at a fixed location above the ear point or central position was used as a reference value for assessing the power drop. The SAR at this point is measured at the start of the test and then again at the end of the testing.

Step 2: The SAR distribution at the exposed side of the head was measured at a distance of 4 mm from the inner surface of the shell. The area covered the entire dimension of the head or radiating structures of the EUT, the horizontal grid spacing was 15 mm x 15 mm, and the SAR distribution was determined by integrated grid of 1.5mm x 1.5mm. Based on these data, the area of the maximum absorption was determined by spline interpolation. The first Area Scan covers the entire dimension of the EUT to ensure that the hotspot was correctly identified.

Step 3: Around this point, a volume of 30 mm x 30 mm x 30 mm was assessed by measuring 7x 7 x 7 points. On the basis of this data set, the spatial peak SAR value was evaluated under the following procedure:

1) The data at the surface were extrapolated, since the center of the dipoles is 1.2 mm away from the tip of the probe and the distance between the surface and the lowest measuring point is 1.3 mm. The extrapolation was based on a least square algorithm. A polynomial of the fourth order was calculated through the points in z-axes. This polynomial was then used to evaluate the points between the surface and the probe tip.

2) The maximum Measured value was searched with a straightforward algorithm. Around this maximum the SAR values averaged over the spatial volumes (1 g or 10 g) were computed by the 3D-Spline interpolation algorithm. The 3D-Spline is composed of three one dimensional splines with the "Not a knot"-condition (in x, y and z-directions). The volume was integrated with the trapezoidal-algorithm. One thousand points (10 x 10 x 10) were Measured to calculate the averages.

All neighboring volumes were evaluated until no neighboring volume with a higher average value was found.

Step 4: Re-measurement of the SAR value at the same location as in Step 1. If the value changed by more than 5%, the evaluation was repeated.

6. CONDUCTED OUTPUT POWER MEASUREMENT

6.1 Test Procedure

The RF output of the transmitter was connected to the input of the Wireless Communication Test Set through Connector.

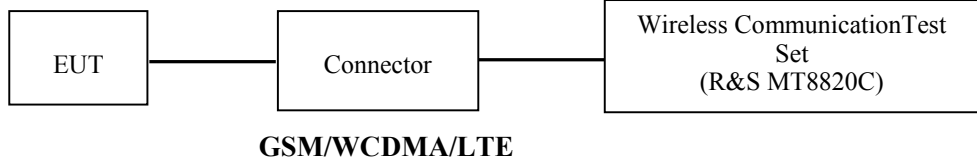

The RF output of the transmitter was connected to the input port of the Pulse Power Sensor through Connector.

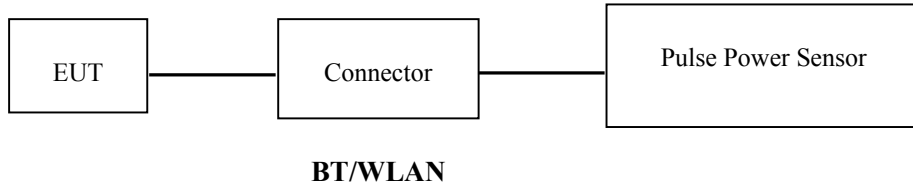

6.2 Description of Test Configuration

EUT Operation Condition:

EUT Operation Mode:	The system was configured for testing in each operation mode.
Equipment Modifications:	No
EUT Exercise Software:	No
<p>The maximum power was configured per 3GPP Standard for each operation modes as below setting:</p> <p>GSM/GPRS/EGPRS</p> <p>Function: Menu select > GSM Mobile Station > GSM 850/1900 Press Connection control to choose the different menus Press RESET > choose all the reset all settings Connection Press Signal Off to turn off the signal and change settings Network Support > GSM + GPRS or GSM + EGSM Main Service > Packet Data Service selection > Test Mode A – Auto Slot Config. off MS Signal Press Slot Config Bottom on the right twice to select and change the number of time slots and power setting</p> <ul style="list-style-type: none"> > Slot configuration > Uplink/Gamma > 33 dBm for GPRS 850 > 30 dBm for GPRS 1900 > 27 dBm for EGPRS 850 > 26 dBm for EGPRS 1900 <p>BS Signal Enter the same channel number for TCH channel (test channel) and BCCH channel Frequency Offset > + 0 Hz Mode > BCCH and TCH</p> <p>BCCH Level > -85 dBm (May need to adjust if link is not stable) BCCH Channel > choose desire test channel [Enter the same channel number for TCH channel (test channel) and BCCH channel]</p> <p>Channel Type > Off P0 > 4 dB Slot Config> Unchanged (if already set under MS signal) TCH > choose desired test channel Hopping > Off Main Timeslot > 3 Network Coding Scheme > CS4 (GPRS) and MCS5 (EGPRS)</p> <p>Bit Stream > 2E9-1 PSR Bit Stream AF/RF Enter appropriate offsets for Ext. Att. Output and Ext. Att. Input Connection Press Sign</p>	

WCDMA-Release 99

The following tests were conducted according to the test requirements outlines in section 5.2 of the 3GPP TS34.121-1 specification. The EUT has a nominal maximum output power of 24dBm (+1.7/-3.7).

WCDMA General Settings	Loopback Mode	Test Mode 1
	Rel99 RMC	12.2kbps RMC
	Power Control Algorithm	Algorithm2
	β / β_d	8/15

WCDMA HSDPA

The following tests were conducted according to the test requirements outlines in section 5.2 of the 3GPP TS34.121-1 specification.

	Mode	HSDPA	HSDPA	HSDPA	HSDPA
	Subset	1	2	3	4
WCDMA General Set ings	Loopback Mode	Test Mode 1			
	Rel99 RMC	12.2kbps RMC			
	HSDPA FRC	H-Set1			
	Power Control Algorithm	Algorithm2			
	β_c	2/15	12/15	15/15	15/15
	β_d	1 /15	15/15	8/15	4/15
	β_d (SF)	64			
	β_c/β_d	2/15	12/15	15/8	15/4
	β_{hs}	4/15	24/15	30/15	30/15
	MPR(dB)	0	0	0.5	0.5
HSDPA Specific Settings	DACK	8			
	DNAK	8			
	DCQI	8			
	Ack-Nack repetition factor	3			
	CQI Feedback	4ms			
	CQI Repetition Factor	2			
	$A_{hs}=\beta_{hs}/\beta_c$	30/15			

WCDMA HSUPA

The following tests were conducted according to the test requirements outlines in section 5.2 of the 3GPP TS34.121-1 specification.

	Mode	HSUPA	HSUPA	HSUPA	HSUPA	HSUPA
	Subset	1	2		4	5
WCDMA General Settings	Loopback Mode	Test Mode 1				
	Rel99 RMC	12.2kbps RMC				
	HSDPA FRC	H-Set1				
	HSUPA Test	HSUPA Loopback				
	Power Control Algorithm	Algorithm2				
	β_c	11/15	6/15	15/15	2/15	15/15
	β_d	15/15	15/15	9/15	15/15	0
	β_{ec}	209/225	12/15	30 15	2/15	5/15
	β_c/β_d	11/15	6/15	15/9	2/15	-
	β_{hs}	22/15	12/15	30/15	4/15	5/15
	CM(dB)	1.0	3.0	2.0	3.0	1.0
MPR(dB)	0	2	1	2	0	
HSDPA Specific Settings	DACK	8				
	DNAK	8				
	DCQI	8				
	Ack-Nack repetition factor	3				
	CQI Feedback	4ms				
	CQI Repetition Factor	2				
	$A_{hs}=\beta_{hs}/\beta_c$	30/15				
HSUPA Specific Settings	DE-DPCCH	6	8	8	5	7
	DHARQ	0	0	0	0	0
	AG Index	20	12	15	17	21
	ETFCI	75	67	92	71	81
	Associated Max UL Data Rate k ps	242.1	174.9	482.8	205.8	308.9
	Reference E_FCIs	E-TFCI 11 E E-TFCI PO 4 E-TFCI 67 E-TFCI PO 18 E-TFCI 71 E-TFCI PO23 E-TFCI 75 E-TFCI PO26 E-TFCI 81 E-TFCI PO 27	E-TFCI 11 E-TFCI PO4 E-TFCI 92 E-TFCI PO 18	E-TFCI 11 E-TFCI PO 4 E-TFCI 67 E-TFCI PO 18 E-TFCI 71 E-TFCI PO23 E-TFCI 75 E-TFCI PO26 E-TFCI 81 E-TFCI PO 27	E-TFCI 11 E E-TFCI PO 4 E-TFCI 67 E-TFCI PO 18 E-TFCI 71 E-TFCI PO23 E-TFCI 75 E-TFCI PO26 E-TFCI 81 E-TFCI PO 27	

LTE (FDD):

The following tests were conducted according to the test requirements in 3GPP TS36.101

The following tests were conducted according to the test requirements outlined in section 6.2 of the 3GPP TS36.101 specification.

UE Power Class: 3 (23 +/- 2dBm). The allowed Maximum Power Reduction (MPR) for the maximum output power due to higher order modulation and transmit bandwidth configuration (resource blocks) is specified in Table 6.2.3-1 of the 3GPP TS36.101.

Table 6.2.3-1: Maximum Power Reduction (MPR) for Power Class 3

Modulation	Channel bandwidth / Transmission bandwidth (RB)						MPR (dB)
	1.4 MHz	3.0 MHz	5 MHz	10 MHz	15 MHz	20 MHz	
QPSK	> 5	> 4	> 8	> 12	> 16	> 18	≤ 1
16 QAM	≤ 5	≤ 4	≤ 8	≤ 12	≤ 16	≤ 18	≤ 1
64 QAM	> 5	> 4	> 8	> 12	> 16	> 18	≤ 2

The allowed A-MPR values specified below in Table 6.2.4.-1 of 3GPP TS36.101 are in addition to the allowed MPR requirements. All the measurements below were performed with A-MPR disabled, by using Network Signalling Value of "NS_01".

Table 6.2.4-1: Additional Maximum Power Reduction (A-MPR)

Network Signalling value	Requirements (sub-clause)	E-UTRA Band	Channel bandwidth (MHz)	Resources Blocks (N_{RB})	A-MPR (dB)
NS_01	6.6.2.1.1	Table 5.5-1	1.4, 3, 5, 10, 15, 20	Table 5.6-1	NA
NS_03	6.6.2.2.1	2, 4, 10, 23, 25, 35, 36	3	>5	≤ 1
			5	>6	≤ 1
			10	>6	≤ 1
			15	>8	≤ 1
			20	>10	≤ 1
NS_04	6.6.2.2.2	41	5	>6	≤ 1
			10, 15, 20	See Table 6.2.4-4	
NS_05	6.6.3.3.1	1	10,15,20	≥ 50	≤ 1
NS_06	6.6.2.2.3	12, 13, 14, 17	1.4, 3, 5, 10	Table 5.6-1	n/a
NS_07	6.6.2.2.3	13	10	Table 6.2.4-2	Table 6.2.4-2
	6.6.3.3.2				
NS_08	6.6.3.3.3	19	10, 15	> 44	≤ 3
NS_09	6.6.3.3.4	21	10, 15	> 40	≤ 1
				> 55	≤ 2
NS_10		20	15, 20	Table 6.2.4-3	Table 6.2.4-3
NS_11	6.6.2.2.1	23 ¹	1.4, 3, 5, 10	Table 6.2.4-5	Table 6.2.4-5
..					
NS_32	-	-	-	-	-

Note 1: Applies to the lower block of Band 23, i.e. a carrier placed in the 2000-2010 MHz region.

TDD-LTE

P TS 36.211 section 4.2 for Type 2 Frame Structure and Table 4.2-2 for uplink-downlink configurations and Table 4.2-1 for Special subframe configurations.

Table 4.2-1: Configuration of special subframe (lengths of DwPTS/GP/UpPTS).

Special subframe configuration	Normal cyclic prefix in downlink			Extended cyclic prefix in downlink		
	DwPTS	UpPTS		DwPTS	UpPTS	
		Normal cyclic prefix in uplink	Extended cyclic prefix in uplink		Normal cyclic prefix in uplink	Extended cyclic prefix in uplink
0	$6592 \cdot T_s$	$2192 \cdot T_s$	$2560 \cdot T_s$	$7680 \cdot T_s$	$2192 \cdot T_s$	$2560 \cdot T_s$
1	$19760 \cdot T_s$			$20480 \cdot T_s$		
2	$21952 \cdot T_s$			$23040 \cdot T_s$		
3	$24144 \cdot T_s$			$25600 \cdot T_s$		
4	$26336 \cdot T_s$			$7680 \cdot T_s$		
5	$6592 \cdot T_s$	$4384 \cdot T_s$	$5120 \cdot T_s$	$20480 \cdot T_s$	$4384 \cdot T_s$	$5120 \cdot T_s$
6	$19760 \cdot T_s$			$23040 \cdot T_s$		
7	$21952 \cdot T_s$			$12800 \cdot T_s$		
8	$24144 \cdot T_s$			-		
9	$13168 \cdot T_s$			-		

Table 4.2-2: Uplink-downlink configurations.

Uplink-downlink configuration	Downlink-to-Uplink Switch-point periodicity	Subframe number									
		0	1	2	3	4	5	6	7	8	9
0	5 ms	D	S	U	U	U	D	S	U	U	U
1	5 ms	D	S	U	U	D	D	S	U	U	D
2	5 ms	D	S	U	D	D	D	S	U	D	D
3	10 ms	D	S	U	U	D	D	D	D	D	D
4	10 ms	D	S	U	U	D	D	D	D	D	D
5	10 ms	D	S	U	D	D	D	D	D	D	D
6	5 ms	D	S	U	U	U	D	S	U	U	D

Calculated Duty Cycle

Uplink-Downlink Configuration	Downlink-to-Uplink Switch-point Periodicity	Subframe Number										Calculated Duty Cycle (%)
		0	1	2	3	4	5	6	7	8	9	
0	5 ms	D	S	U	U	U	D	S	U	U	U	63.33
1	5 ms	D	S	U	U	D	D	S	U	U	D	43.33
2	5 ms	D	S	U	D	D	D	S	U	D	D	23.33
3	10 ms	D	S	U	U	U	D	D	D	D	D	31.67
4	10 ms	D	S	U	U	D	D	D	D	D	D	21.67
5	10 ms	D	S	U	D	D	D	D	D	D	D	11.67
6	5 ms	D	S	U	U	U	D	S	U	U	D	53.33

We used configuration 0 for LTE Band 41&38 SAR test, that is 63.33%(1:1.58)for duty cycle.

6.3 Maximum Target Output Power

Max Target Power(dBm)			
Mode/Band	Channel		
	Low	Middle	High
GSM 850	31.1	31.1	31.1
GPRS 1 TX Slot	30.9	30.9	30.9
GPRS 2 TX Slot	30.9	30.9	30.9
GPRS 3 TX Slot	29.6	29.6	29.6
GPRS 4 TX Slot	28.4	28.4	28.4
EDGE 1 TX Slot	27	27	27
EDGE 2 TX Slot	25.9	25.9	25.9
EDGE 3 TX Slot	23.8	23.8	23.8
EDGE 4 TX Slot	22.4	22.4	22.4
PCS 1900	26.5	26.5	26.5
GPRS 1 TX Slot	26.6	26.6	26.6
GPRS 2 TX Slot	26.3	26.3	26.3
GPRS 3 TX Slot	25.8	25.8	25.8
GPRS 4 TX Slot	25.3	25.3	25.3
EDGE 1 TX Slot	25.8	25.8	25.8
EDGE 2 TX Slot	24.7	24.7	24.7
EDGE 3 TX Slot	22.4	22.4	22.4
EDGE 4 TX Slot	21.1	21.1	21.1
WCDMA Band 2	23.1	23.1	23.1
HSDPA	23.1	23.1	23.1
HSUPA	23	23	23
WCDMA Band 4	16.7	16.7	16.7
HSDPA	16.6	16.6	16.6
HSUPA	16.6	16.6	16.6
WCDMA Band 5	23.3	23.3	23.3
HSDPA	23.2	23.2	23.2
HSUPA	23.3	23.3	23.3
LTE Band 2	19.3	19.3	19.3
LTE Band 4	17	17	17
LTE Band 5	20	20	20
LTE Band 7	16.2	16.2	16.2
LTE Band 12	25.3	25.3	25.3
LTE Band 13	23.9	23.9	23.9
LTE Band 17	25.3	25.3	25.3
LTE Band 38	18.4	18.4	18.4
LTE Band 41	18.4	18.4	18.4
LTE Band 66	17	17	17

Mode/Band	Max Target Power(dBm)		
	Channel		
	Low	Middle	High
WLAN 2.4G(802.11b)Chain 0	11.5	11.5	11.5
WLAN 2.4G(802.11g) Chain 0	10.8	10.8	10.8
WLAN 2.4G(802.11n ht20) Chain 0	10.8	10.8	10.8
WLAN 2.4G(802.11b)Chain 1	14.5	14.5	14.5
WLAN 2.4G(802.11g) Chain 1	12.5	12.5	12.5
WLAN 2.4G(802.11n ht20) Chain 1	13.5	13.5	13.5
WLAN5.2G(802.11a)	7.5	7.5	7.5
WLAN5.2G(802.11n ht20)	7	7	7
WLAN5.2G(802.11n ht40)	7	7	7
WLAN5.2G(802.11ac vht80)	6	6	6
WLAN5.3G(802.11a)	7.5	7.5	7.5
WLAN5.3G(802.11n ht20)	7	7	7
WLAN5.3G(802.11n ht40)	6.5	6.5	6.5
WLAN5.3G(802.11ac vht80)	6.5	6.5	6.5
WLAN5.6G(802.11a)	8.2	8.2	8.2
WLAN5.6G(802.11n ht20)	7.5	7.5	7.5
WLAN5.6G(802.11n ht40)	7.5	7.5	7.5
WLAN5.6G(802.11ac vht80)	7.5	7.5	7.5
WLAN5.8G(802.11a)	7.5	7.5	7.5
WLAN5.8G(802.11n ht20)	7	7	7
WLAN5.8G(802.11n ht40)	7	7	7
WLAN5.8G(802.11ac vht80)	6.5	6.5	6.5
Bluetooth BDR Chain 0	2.5	2.5	2.5
Bluetooth EDR Chain 0	2.0	2.0	2.0
BLE 1M Chain 0	-4.0	-4.0	-4.0
BLE 2M Chain 0	-4.0	-4.0	-4.0
Bluetooth BDR Chain 1	2.5	2.5	2.5
Bluetooth EDR Chain 1	2.0	2.0	2.0
BLE 1M Chain 1	-4.5	-4.5	-4.5
BLE 2M Chain 1	-4.5	-4.5	-4.5

Note: The Maximum Target Power for LTE bands corresponds to their maximum power in QPSK modes with maximum bandwidth.

6.4 Test Results:**GSM:**

Band	Channel No.	Frequency (MHz)	RF Output Power (dBm)
GSM 850	128	824.2	30.72
	190	836.6	30.81
	251	848.8	30.97
PCS 1900	512	1850.2	26.25
	661	1880	26.28
	810	1909.8	26.43

GPRS:

Band	Channel No.	Frequency (MHz)	RF Output Power (dBm)			
			1 slot	2 slots	3 slots	4 slots
GSM 850	128	824.2	30.66	30.50	29.32	28.17
	190	836.6	30.76	30.67	29.46	28.22
	251	848.8	30.71	30.77	29.45	28.27
PCS 1900	512	1850.2	26.31	26.04	25.61	25.18
	661	1880	26.30	26.11	25.49	25.17
	810	1909.8	26.52	26.22	25.65	25.09

EGPRS:

Band	Channel No.	Frequency (MHz)	RF Output Power (dBm)			
			1 slot	2 slots	3 slots	4 slots
GSM 850	128	824.2	26.92	25.80	23.72	22.32
	190	836.6	26.53	25.47	23.34	22.22
	251	848.8	26.45	25.34	23.22	21.98
PCS 1900	512	1850.2	25.74	24.64	22.30	20.97
	661	1880	25.35	24.25	22.16	20.73
	810	1909.8	25.19	24.19	21.90	20.52

For SAR, the time based average power is relevant, the difference in between depends on the duty cycle of the TDMA signal.

Number of Time slot	1	2	3	4
Duty Cycle	1:8	1:4	1:2.66	1:2
Time based Ave. power compared to slotted Ave. power	-9 dB	-6 dB	-4.25 dB	-3 dB
Crest Factor	8	4	2.66	2

The time based average power for GPRS

Band	Channel No.	Frequency (MHz)	Time based average Power (dBm)			
			1 slot	2 slot	3 slots	4 slots
GSM 850	128	824.2	21.66	24.5	25.07	25.17
	190	836.6	21.76	24.67	25.21	25.22
	251	848.8	21.71	24.77	25.2	25.27
PCS 1900	512	1850.2	17.31	20.04	21.36	22.18
	661	1880	17.3	20.11	21.24	22.17
	810	1909.8	17.52	20.22	21.4	22.09

The time based average power for EGPRS

Band	Channel No.	Frequency (MHz)	Time based average Power (dBm)			
			1 slot	2 slot	3 slots	4 slots
GSM 850	128	824.2	17.92	19.8	19.47	19.32
	190	836.6	17.53	19.47	19.09	19.22
	251	848.8	17.45	19.34	18.97	18.98
PCS 1900	512	1850.2	16.74	18.64	18.05	17.97
	661	1880	16.35	18.25	17.91	17.73
	810	1909.8	16.19	18.19	17.65	17.52

Note:

1. Radio Communication Analyzer (MT8820C) was used for the measurement of GSM peak and average output power for active timeslots.
2. For GSM voice, 1 timeslot has been activated with power level 5 (850 MHz band) and 0 (1900 MHz band).
3. For GPRS, 1, 2, 3 and 4 timeslots has been activated separately with power level 3(850 MHz band) and 3(1900 MHz band).

WCDMA:**WCDMA Band 2:**

Test Mode	Conducted Average Output Power(dBm)		
	Lowest Channel	Middle Channel	Highest Channel
WCDMA R99	22.85	22.86	22.98
HSDPA Subtest 1	22.80	22.94	22.93
HSDPA Subtest 2	22.55	22.88	22.91
HSDPA Subtest 3	22.75	22.85	22.84
HSDPA Subtest 4	22.70	22.76	22.96
HSUPA Subtest 1	22.78	22.81	22.95
HSUPA Subtest 2	22.49	22.72	22.84
HSUPA Subtest 3	22.77	22.78	22.71
HSUPA Subtest 4	22.63	22.90	22.85
HSUPA Subtest 5	22.77	22.78	22.83

WCDMA Band 4:

Test Mode	Conducted Average Output Power(dBm)		
	Lowest Channel	Middle Channel	Highest Channel
WCDMA R99	16.37	16.58	16.49
HSDPA Subtest 1	16.29	16.49	16.51
HSDPA Subtest 2	16.22	16.24	16.23
HSDPA Subtest 3	16.22	16.44	16.33
HSDPA Subtest 4	16.30	16.41	16.41
HSUPA Subtest 1	16.36	16.40	16.46
HSUPA Subtest 2	16.23	16.26	16.50
HSUPA Subtest 3	16.43	16.34	16.53
HSUPA Subtest 4	16.19	16.42	16.32
HSUPA Subtest 5	16.36	16.43	16.43

WCDMA Band 5:

Test Mode	Conducted Average Output Power(dBm)		
	Lowest Channel	Middle Channel	Highest Channel
WCDMA R99	23.04	23.14	23.18
HSDPA Subtest 1	23.01	23.06	23.12
HSDPA Subtest 2	22.99	23.09	23.06
HSDPA Subtest 3	23.01	22.88	23.09
HSDPA Subtest 4	22.77	22.95	22.96
HSUPA Subtest 1	23.01	23.09	23.17
HSUPA Subtest 2	23.16	23.03	23.13
HSUPA Subtest 3	23.13	22.98	23.16
HSUPA Subtest 4	23.00	22.93	23.09
HSUPA Subtest 5	22.88	23.14	23.07

Note:

1. The default test configuration is to measure SAR with an established radio link between the EUT and a communication test set using a 12.2 kbps RMC (reference measurement Channel) Configured in Test Loop Model 1.
2. KDB 941225 D01-Body SAR is not required for HSDPA/HSUPA when the maximum average output of each RF channel is less than $\frac{1}{4}$ dB higher than measured 12.2kbps RMC or the maximum SAR for 12.2kbps RMC is < 75% of SAR limit.

LTE Band 2:

Test Bandwidth	Test Modulation	Resource Block & RB offset	Target MPR	Meas MPR	Low Channel (dBm)	Middle Channel (dBm)	High Channel (dBm)
1.4M	QPSK	RB1#0	0	0	18.71	18.4	18.49
		RB1#3	0	0	18.71	18.26	18.45
		RB1#5	0	0	18.65	18.46	18.53
		RB3#0	1	1	18.74	18.39	18.33
		RB3#3	1	1	18.73	18.42	18.36
		RB6#0	1	1	17.81	17.52	17.39
	16-QAM	RB1#0	1	1	17.52	17.18	17.62
		RB1#3	1	1	17.56	17.22	17.6
		RB1#5	2	2	17.68	17.2	17.72
		RB3#0	2	2	18.02	17.53	17.53
		RB3#3	2	2	17.96	17.58	17.63
		RB6#0	2	2	16.96	16.47	16.14
3M	QPSK	RB1#0	0	0	18.44	18.91	19.13
		RB1#8	0	0	18.43	18.84	19.18
		RB1#14	0	0	18.41	18.89	19.19
		RB6#0	1	1	17.55	17.96	18.02
		RB6#9	1	1	17.6	18.08	18.08
		RB15#0	1	1	17.53	18	17.92
	16-QAM	RB1#0	1	1	17.36	17.88	18.35
		RB1#8	1	1	17.31	17.88	18.52
		RB1#14	1	1	17.32	17.83	18.4
		RB6#0	2	2	16.6	17.03	17.22
		RB6#9	2	2	16.64	17.1	17.08
		RB15#0	2	2	16.46	16.93	17.18
5M	QPSK	RB1#0	0	0	18.44	18.34	18.34
		RB1#13	0	0	18.43	18.39	18.35
		RB1#24	0	0	18.6	18.33	18.31
		RB15#0	1	1	17.57	17.29	17.45
		RB15#10	1	1	17.53	17.34	17.53
		RB25#0	1	1	17.44	17.33	17.48
	16-QAM	RB1#0	1	1	17.49	17.43	17.94
		RB1#13	1	1	17.55	17.31	17.92
		RB1#24	1	1	17.58	17.3	18.03
		RB15#0	2	2	16.64	16.26	16.4
		RB15#10	2	2	16.47	16.33	16.46
		RB25#0	2	2	16.52	16.23	16.38

Test Bandwidth	Test Modulation	Resource Block & RB offset	Target MPR	Meas MPR	Low Channel (dBm)	Middle Channel (dBm)	High Channel (dBm)
10M	QPSK	RB1#0	0	0	18.86	18.82	18.9
		RB1#25	0	0	18.82	18.79	18.71
		RB1#49	1	1	18.84	18.77	18.94
		RB25#0	1	1	17.91	17.77	17.65
		RB25#25	1	1	17.9	17.82	17.69
		RB50#0	1	1	18.03	17.82	17.58
	16-QAM	RB1#0	1	1	17.78	17.91	18.17
		RB1#25	1	1	17.73	17.74	18.02
		RB1#49	1	1	17.81	17.72	18.05
		RB25#0	2	2	17.03	16.79	16.66
		RB25#25	2	2	17	16.96	16.71
		RB50#0	2	2	16.95	16.75	16.54
15M	QPSK	RB1#0	0	0	18.43	18.93	18.56
		RB1#38	0	0	18.45	18.96	18.5
		RB1#74	1	1	18.35	18.71	18.46
		RB36#0	1	1	17.4	18.02	17.35
		RB36#39	1	1	17.44	17.95	17.33
		RB75#0	1	1	17.47	17.94	17.28
	16-QAM	RB1#0	1	1	17.56	18.02	17.74
		RB1#38	1	1	17.52	18	17.7
		RB1#74	2	2	17.43	17.87	17.76
		RB36#0	2	2	16.5	17.03	16.47
		RB36#39	2	2	16.37	16.95	16.44
		RB75#0	2	2	16.31	17.03	16.29
20M	QPSK	RB1#0	0	0	18.79	18.8	18.87
		RB1#50	0	0	18.82	18.83	18.97
		RB1#99	0	0	18.81	18.58	18.85
		RB50#0	1	1	17.87	17.68	17.96
		RB50#50	1	1	18.03	17.94	17.99
		RB100#0	1	1	17.9	17.61	18.03
	16-QAM	RB1#0	1	1	18.26	18.29	18.44
		RB1#50	1	1	18.26	18.37	18.35
		RB1#99	2	2	18.25	18.17	18.41
		RB50#0	2	2	17.02	16.81	17
		RB50#50	2	2	16.9	16.68	17.15
		RB100#0	2	2	16.85	16.62	17.01

LTE Band 4:

Test Bandwidth	Test Modulation	Resource Block & RB offset	Target MPR	Meas MPR	Low Channel (dBm)	Middle Channel (dBm)	High Channel (dBm)
1.4M	QPSK	RB1#0	0	0	16.05	16.11	16.59
		RB1#3	0	0	16.16	15.78	16.33
		RB1#5	0	0	16.03	15.91	16.16
		RB3#0	1	1	16.34	15.63	16.31
		RB3#3	1	1	16.14	15.81	16.62
		RB6#0	1	1	15.11	15.45	15.29
	16-QAM	RB1#0	1	1	14.97	15.47	15.70
		RB1#3	1	1	14.83	15.12	15.38
		RB1#5	2	2	15.09	15.15	15.70
		RB3#0	2	2	15.42	14.77	15.73
		RB3#3	2	2	15.40	15.00	15.44
		RB6#0	2	2	14.48	13.12	14.47
3M	QPSK	RB1#0	0	0	15.98	15.65	16.53
		RB1#8	0	0	15.84	15.66	16.34
		RB1#14	0	0	15.80	15.71	16.25
		RB6#0	1	1	15.62	15.55	15.53
		RB6#9	1	1	15.54	15.47	15.38
		RB15#0	1	1	15.15	15.15	15.15
	16-QAM	RB1#0	1	1	14.88	14.77	15.87
		RB1#8	1	1	14.60	14.78	15.78
		RB1#14	1	1	14.83	14.80	15.85
		RB6#0	2	2	14.02	13.91	14.38
		RB6#9	2	2	13.94	13.81	14.34
		RB15#0	2	2	14.09	13.77	14.24
5M	QPSK	RB1#0	0	0	16.22	16.29	15.67
		RB1#13	0	0	16.43	16.17	15.63
		RB1#24	0	0	16.38	16.31	15.88
		RB15#0	1	1	15.50	15.25	15.77
		RB15#10	1	1	15.44	15.19	15.67
		RB25#0	1	1	15.62	15.22	15.35
	16-QAM	RB1#0	1	1	15.50	13.75	15.23
		RB1#13	1	1	15.53	14.42	15.24
		RB1#24	1	1	15.52	14.33	15.42
		RB15#0	2	2	14.29	13.28	13.64
		RB15#10	2	2	14.64	13.15	13.61
		RB25#0	2	2	14.02	13.33	14.18

Test Bandwidth	Test Modulation	Resource Block & RB offset	Target MPR	Meas MPR	Low Channel (dBm)	Middle Channel (dBm)	High Channel (dBm)
10M	QPSK	RB1#0	0	0	16.47	16.23	16.60
		RB1#25	0	0	16.30	16.16	16.56
		RB1#49	1	1	16.43	16.36	16.61
		RB25#0	1	1	15.48	15.36	15.66
		RB25#25	1	1	15.53	15.23	15.61
		RB50#0	1	1	15.47	15.02	15.68
	16-QAM	RB1#0	1	1	15.66	15.44	15.46
		RB1#25	1	1	15.46	15.37	15.43
		RB1#49	1	1	15.55	15.56	15.53
		RB25#0	2	2	14.56	14.07	14.65
		RB25#25	2	2	14.67	14.10	14.80
		RB50#0	2	2	14.50	14.12	14.76
15M	QPSK	RB1#0	0	0	16.89	16.44	16.72
		RB1#38	0	0	16.91	16.38	16.73
		RB1#74	1	1	16.72	16.29	16.65
		RB36#0	1	1	15.82	15.44	15.49
		RB36#39	1	1	15.76	15.43	15.42
		RB75#0	1	1	15.73	15.56	15.63
	16-QAM	RB1#0	1	1	16.14	15.60	15.89
		RB1#38	1	1	15.92	15.58	15.83
		RB1#74	2	2	16.00	15.38	15.76
		RB36#0	2	2	14.92	14.45	14.59
		RB36#39	2	2	14.83	14.44	14.57
		RB75#0	2	2	14.77	14.56	14.57
20M	QPSK	RB1#0	0	0	16.87	16.91	16.22
		RB1#50	0	0	16.92	16.86	16.67
		RB1#99	0	0	16.77	16.82	16.66
		RB50#0	1	1	15.92	15.76	15.43
		RB50#50	1	1	16.17	15.73	15.80
		RB100#0	1	1	16.10	15.74	15.88
	16-QAM	RB1#0	1	1	16.44	16.43	16.11
		RB1#50	1	1	16.35	16.36	16.08
		RB1#99	2	2	16.25	16.27	16.00
		RB50#0	2	2	15.05	14.75	14.75
		RB50#50	2	2	15.07	14.90	14.94
		RB100#0	2	2	15.05	14.77	14.93

LTE Band 5:

Test Bandwidth	Test Modulation	Resource Block & RB offset	Target MPR	Meas MPR	Low Channel (dBm)	Middle Channel (dBm)	High Channel (dBm)
1.4M	QPSK	RB1#0	0	0	19.76	19.43	19.78
		RB1#3	0	0	19.82	19.28	19.76
		RB1#5	0	0	19.93	19.39	19.84
		RB3#0	1	1	19.88	19.32	19.64
		RB3#3	1	1	19.89	19.36	19.67
		RB6#0	1	1	18.94	18.38	18.58
	16-QAM	RB1#0	1	1	18.77	18.16	19.03
		RB1#3	1	1	18.63	18.24	18.91
		RB1#5	2	2	18.80	18.25	18.91
		RB3#0	2	2	19.03	18.61	18.94
		RB3#3	2	2	18.97	18.62	18.96
		RB6#0	2	2	18.11	17.52	17.56
3M	QPSK	RB1#0	0	0	19.15	19.12	19.74
		RB1#8	0	0	19.21	19.03	19.79
		RB1#14	0	0	19.06	18.96	19.78
		RB6#0	1	1	18.20	18.09	18.61
		RB6#9	1	1	18.14	18.08	18.63
		RB15#0	1	1	18.18	18.15	18.55
	16-QAM	RB1#0	1	1	18.09	18.16	18.93
		RB1#8	1	1	18.08	17.92	19.05
		RB1#14	1	1	18.00	18.13	19.02
		RB6#0	2	2	17.24	17.23	17.72
		RB6#9	2	2	17.10	17.17	17.64
		RB15#0	2	2	17.18	17.09	17.69
5M	QPSK	RB1#0	0	0	19.53	19.22	19.73
		RB1#13	0	0	19.62	19.13	19.74
		RB1#24	0	0	19.71	19.21	19.74
		RB15#0	1	1	18.48	18.03	18.73
		RB15#10	1	1	18.48	18.06	18.72
		RB25#0	1	1	18.66	18.19	18.70
	16-QAM	RB1#0	1	1	18.70	18.30	19.36
		RB1#13	1	1	18.57	18.21	19.23
		RB1#24	1	1	18.54	18.14	19.23
		RB15#0	2	2	17.59	17.19	17.80
		RB15#10	2	2	17.65	17.12	17.71
		RB25#0	2	2	17.67	17.24	17.69

Test Bandwidth	Test Modulation	Resource Block & RB offset	Target MPR	Meas MPR	Low Channel (dBm)	Middle Channel (dBm)	High Channel (dBm)
10M	QPSK	RB1#0	0	0	19.12	19.87	19.36
		RB1#25	0	0	18.87	19.85	19.37
		RB1#49	1	1	18.92	19.82	19.23
		RB25#0	1	1	18.53	18.91	18.49
		RB25#25	1	1	18.68	19.02	18.86
		RB50#0	1	1	18.22	18.88	18.27
	16-QAM	RB1#0	1	1	17.94	18.85	18.45
		RB1#25	1	1	17.87	18.85	18.47
		RB1#49	1	1	17.94	18.68	18.42
		RB25#0	2	2	17.14	17.90	17.16
		RB25#25	2	2	17.10	18.06	17.00
		RB50#0	2	2	17.17	17.97	17.05

LTE Band 7:

Test Bandwidth	Test Modulation	Resource Block & RB offset	Target MPR	Meas MPR	Low Channel (dBm)	Middle Channel (dBm)	High Channel (dBm)
5M	QPSK	RB1#0	0	0	14.93	14.97	15.3
		RB1#13	0	0	14.87	15.08	15.43
		RB1#24	0	0	14.78	15.18	15.44
		RB15#0	1	1	14.36	14.42	14.36
		RB15#10	1	1	14.57	14.37	14.42
		RB25#0	1	1	14.25	14.22	14.31
	16-QAM	RB1#0	1	1	14.31	14.11	14.35
		RB1#13	1	1	14.39	14.11	14.33
		RB1#24	1	1	14.42	14.08	14.38
		RB15#0	2	2	12.94	13.08	13.45
		RB15#10	2	2	12.87	13.07	13.43
		RB25#0	2	2	12.87	13.02	13.4
10M	QPSK	RB1#0	0	0	15.3	15.26	15.81
		RB1#25	0	0	15.24	15.45	15.58
		RB1#49	0	0	15.44	15.43	15.91
		RB25#0	1	1	14.63	14.65	14.76
		RB25#25	1	1	14.45	14.56	14.83
		RB50#0	1	1	14.29	14.42	14.82
	16-QAM	RB1#0	1	1	14.44	14.31	14.8
		RB1#25	1	1	14.57	14.36	14.77
		RB1#49	1	1	14.62	14.3	14.88
		RB25#0	2	2	13.24	13.68	13.82
		RB25#25	2	2	13.22	13.62	13.81
		RB50#0	2	2	13.24	13.55	13.72
15M	QPSK	RB1#0	0	0	14.84	15.37	16.05
		RB1#38	0	0	14.9	15.54	16.11
		RB1#74	0	0	14.95	15.47	16.04
		RB36#0	1	1	14.67	14.59	14.94
		RB36#39	1	1	14.58	14.62	14.83
		RB75#0	1	1	14.32	14.63	14.79
	16-QAM	RB1#0	1	1	13.91	14.4	15.3
		RB1#38	1	1	13.87	14.47	15.19
		RB1#74	1	1	13.94	14.66	15.22
		RB36#0	2	2	12.82	13.64	13.87
		RB36#39	2	2	12.86	13.6	13.9
		RB75#0	2	2	12.85	13.67	13.94

Test Bandwidth	Test Modulation	Resource Block & RB offset	Target MPR	Meas MPR	Low Channel (dBm)	Middle Channel (dBm)	High Channel (dBm)
20M	QPSK	RB1#0	0	0	14.86	15.45	15.74
		RB1#50	0	0	14.87	15.66	15.89
		RB1#99	0	0	15.32	15.58	15.90
		RB50#0	1	1	14.65	15.24	15.11
		RB50#50	1	1	14.33	14.78	14.87
		RB100#0	1	1	14.26	14.79	14.91
	16-QAM	RB1#0	1	1	14.13	14.72	15.33
		RB1#50	1	1	14.13	14.86	15.59
		RB1#99	1	1	14.32	14.96	15.62
		RB50#0	2	2	12.76	13.64	13.93
		RB50#50	2	2	12.7	13.63	13.91
		RB100#0	2	2	12.90	13.55	13.80

LTE Band 12:

Test Bandwidth	Test Modulation	Resource Block & RB offset	Target MPR	Meas MPR	Low Channel (dBm)	Middle Channel (dBm)	High Channel (dBm)
1.4M	QPSK	RB1#0	0	0	25.19	24.9	24.99
		RB1#3	0	0	25	24.77	24.83
		RB1#5	0	0	25.23	24.87	24.96
		RB3#0	1	1	24.97	24.91	24.85
		RB3#3	1	1	25.08	24.94	24.77
		RB6#0	1	1	23.92	23.87	23.81
	16-QAM	RB1#0	1	1	24.36	23.7	24.19
		RB1#3	1	1	24.29	23.69	24.08
		RB1#5	2	2	24.3	23.82	24.28
		RB3#0	2	2	24.23	24.11	24.14
		RB3#3	2	2	24.32	24.04	24.04
		RB6#0	2	2	22.89	23.05	22.78
3M	QPSK	RB1#0	0	0	24.74	24.87	24.84
		RB1#8	0	0	24.74	24.85	24.94
		RB1#14	0	0	24.73	24.96	24.94
		RB6#0	1	1	23.92	23.83	23.78
		RB6#9	1	1	23.82	23.92	23.82
		RB15#0	1	1	23.92	23.9	23.83
	16-QAM	RB1#0	1	1	23.87	23.71	24.11
		RB1#8	1	1	23.84	23.61	24.18
		RB1#14	1	1	23.79	23.84	24.11
		RB6#0	2	2	22.94	22.82	22.82
		RB6#9	2	2	22.84	22.92	22.84
		RB15#0	2	2	22.99	22.83	22.84
5M	QPSK	RB1#0	0	0	25.24	24.9	24.78
		RB1#13	0	0	25.13	25.03	24.83
		RB1#24	0	0	25.13	25.03	24.86
		RB15#0	1	1	24.07	24.07	24.01
		RB15#10	1	1	23.99	23.98	23.86
		RB25#0	1	1	24.13	24.09	23.96
	16-QAM	RB1#0	1	1	24.15	24.83	24.02
		RB1#13	1	1	24.18	24.71	23.93
		RB1#24	1	1	24.19	24.79	23.85
		RB15#0	2	2	23.17	23.03	22.93
		RB15#10	2	2	23	23.03	23.12
		RB25#0	2	2	23.15	23.16	22.92

Test Bandwidth	Test Modulation	Resource Block & RB offset	Target MPR	Meas MPR	Low Channel (dBm)	Middle Channel (dBm)	High Channel (dBm)
10M	QPSK	RB1#0	0	0	24.92	25.12	25.12
		RB1#25	0	0	24.85	25.07	25.09
		RB1#49	1	1	24.83	25.04	25.14
		RB25#0	1	1	24.39	24.45	24.26
		RB25#25	1	1	24.23	24.35	24.17
		RB50#0	1	1	24.12	24.06	24.06
	16-QAM	RB1#0	1	1	23.91	24.01	24.51
		RB1#25	1	1	23.91	23.84	24.23
		RB1#49	1	1	23.74	23.86	24.29
		RB25#0	2	2	23.09	23.07	23.12
		RB25#25	2	2	23.2	23.13	22.99
		RB50#0	2	2	23.18	23.02	22.89

LTE Band 13:

Test Bandwidth	Test Modulation	Resource Block & RB offset	Target MPR	Meas MPR	Low Channel (dBm)	Middle Channel (dBm)	High Channel (dBm)
5M	QPSK	RB1#0	0	0	23.38	/	23.63
		RB1#13	0	0	23.49	/	23.61
		RB1#24	1	1	23.38	/	23.66
		RB15#0	1	1	22.51	/	22.68
		RB15#10	1	1	22.53	/	22.43
		RB25#0	1	1	22.52	/	22.48
	16-QAM	RB1#0	1	1	23.04	/	22.74
		RB1#13	1	1	23.11	/	22.57
		RB1#24	1	1	23.27	/	22.59
		RB15#0	2	2	21.66	/	21.76
		RB15#10	2	2	21.49	/	21.64
		RB25#0	2	2	21.52	/	21.47
10M	QPSK	RB1#0	0	0	/	23.70	/
		RB1#25	0	0	/	23.75	/
		RB1#49	1	1	/	23.78	/
		RB25#0	1	1	/	22.83	/
		RB25#25	1	1	/	22.98	/
		RB50#0	1	1	/	22.85	/
	16-QAM	RB1#0	1	1	/	22.71	/
		RB1#25	1	1	/	22.80	/
		RB1#49	1	1	/	22.64	/
		RB25#0	2	2	/	21.80	/
		RB25#25	2	2	/	21.97	/
		RB50#0	2	2	/	21.87	/

LTE Band 17:

Test Bandwidth	Test Modulation	Resource Block & RB offset	Target MPR	Meas MPR	Low Channel (dBm)	Middle Channel (dBm)	High Channel (dBm)
5M	QPSK	RB1#0	0	0	25.01	24.85	25.1
		RB1#13	0	0	24.79	24.78	25.02
		RB1#24	1	1	24.73	24.74	24.88
		RB15#0	1	1	24.06	23.92	23.83
		RB15#10	1	1	24.06	24.03	23.93
		RB25#0	1	1	23.94	24.03	23.91
	16-QAM	RB1#0	1	1	24.67	24.06	24.02
		RB1#13	1	1	24.7	23.98	24.06
		RB1#24	1	1	24.51	23.89	23.91
		RB15#0	2	2	23.21	23.02	22.94
		RB15#10	2	2	23.18	23.01	22.89
		RB25#0	2	2	23.22	22.98	22.91
10M	QPSK	RB1#0	0	0	24.78	24.91	25
		RB1#25	0	0	24.73	24.92	25.06
		RB1#49	1	1	24.61	25.08	24.94
		RB25#0	1	1	24.04	23.91	23.99
		RB25#25	1	1	24.01	24	23.92
		RB50#0	1	1	23.99	23.9	23.88
	16-QAM	RB1#0	1	1	23.78	23.8	24.41
		RB1#25	1	1	23.65	23.91	24.4
		RB1#49	1	1	23.7	23.76	24.28
		RB25#0	2	2	23.05	23.13	23.01
		RB25#25	2	2	23.14	23.04	23.04
		RB50#0	2	2	22.92	22.94	22.89

LTE Band 38:

Test Bandwidth	Test Modulation	Resource Block & RB offset	Target MPR	Meas MPR	Low Channel (dBm)	Middle Channel (dBm)	High Channel (dBm)
5M	QPSK	RB1#0	0	0	17.65	17.54	17.03
		RB1#13	0	0	17.75	17.76	17.08
		RB1#24	0	0	17.7	17.72	16.92
		RB15#0	1	1	16.75	16.65	16.66
		RB15#10	1	1	16.76	16.6	16.56
		RB25#0	1	1	16.77	16.83	16.41
	16-QAM	RB1#0	1	1	17.02	17.23	16.27
		RB1#13	1	1	17.04	17.29	16.2
		RB1#24	1	1	17.12	17.38	16.27
		RB15#0	2	2	15.77	15.87	14.99
		RB15#10	2	2	15.79	15.92	14.94
		RB25#0	2	2	15.85	15.77	14.94
10M	QPSK	RB1#0	0	0	17.52	17.11	17.93
		RB1#25	0	0	17.45	17.28	17.91
		RB1#49	0	0	17.74	17.31	17.94
		RB25#0	1	1	16.63	16.76	17.17
		RB25#25	1	1	16.76	16.65	17.13
		RB50#0	1	1	16.53	16.43	17.05
	16-QAM	RB1#0	1	1	17.01	16.58	17.22
		RB1#25	1	1	17.08	16.53	17.22
		RB1#49	1	1	17.24	16.67	17.22
		RB25#0	2	2	15.69	15.42	15.95
		RB25#25	2	2	15.75	15.33	15.94
		RB50#0	2	2	15.69	15.41	16.08
15M	QPSK	RB1#0	0	0	18.15	17.8	18.18
		RB1#38	0	0	18.26	17.87	18.28
		RB1#74	0	0	18.31	17.97	18.16
		RB36#0	1	1	17.13	17.07	17.15
		RB36#39	1	1	17.3	17.18	17.13
		RB75#0	1	1	17.15	17.1	17.18
	16-QAM	RB1#0	1	1	17.66	17.31	17.69
		RB1#38	1	1	17.7	17.39	17.65
		RB1#74	1	1	17.74	17.35	17.51
		RB36#0	2	2	16.4	16.19	15.93
		RB36#39	2	2	15.9	16.12	16.01
		RB75#0	2	2	16.19	16.11	16.1

Test Bandwidth	Test Modulation	Resource Block & RB offset	Target MPR	Meas MPR	Low Channel (dBm)	Middle Channel (dBm)	High Channel (dBm)
20M	QPSK	RB1#0	0	0	18.07	17.4	18.26
		RB1#50	0	0	18.2	17.7	18.3
		RB1#99	0	0	18.32	17.68	18.16
		RB50#0	1	1	17.11	16.62	17.11
		RB50#50	1	1	17.23	16.68	17.19
		RB100#0	1	1	17.2	16.58	17.18
	16-QAM	RB1#0	1	1	17.24	16.63	17.57
		RB1#50	1	1	17.26	16.81	17.47
		RB1#99	1	1	17.54	16.87	17.33
		RB50#0	2	2	16.3	15.56	16.16
		RB50#50	2	2	16.16	15.57	16.18
		RB100#0	2	2	16.09	15.53	16.11

LTE Band 41:

Test Bandwidth	Test Modulation	Resource Block & RB offset	Target MPR	Meas MPR	Low Channel (dBm)	2549.5 MHz (dBm)	Middle Channel (dBm)	2636.5 MHz (dBm)	High Channel (dBm)
5M	QPSK	RB1#0	0	0	17.08	16.98	17.86	17.85	17.33
		RB1#13	0	0	17.08	17.16	17.94	18.04	17.24
		RB1#24	1	1	17.13	17.2	17.98	18.03	17.13
		RB15#0	1	1	16.91	16.97	16.85	16.86	16.75
		RB15#10	1	1	16.84	16.89	16.93	16.88	16.62
		RB25#0	1	1	16.57	16.48	16.95	16.95	16.44
	16-QAM	RB1#0	1	1	16.26	16.22	17.46	17.35	16.49
		RB1#13	1	1	16.24	16.22	17.41	17.4	16.48
		RB1#24	1	1	16.21	16.32	17.48	17.31	16.51
		RB15#0	2	2	14.82	14.82	15.94	16.07	15.34
		RB15#10	2	2	14.84	14.93	16.03	15.94	15.34
		RB25#0	2	2	15.01	15.04	15.86	15.92	15.32
10M	QPSK	RB1#0	0	0	17.5	17.34	18.12	18.13	17.41
		RB1#25	0	0	17.06	16.97	18.05	18.16	17.36
		RB1#49	1	1	17.13	17.1	18.19	18.11	17.27
		RB25#0	1	1	16.86	16.79	17.02	17	16.67
		RB25#25	1	1	16.73	16.52	17.12	17.12	16.54
		RB50#0	1	1	16.54	16.42	16.95	17	16.62
	16-QAM	RB1#0	1	1	16.34	16.29	17.31	17.41	17
		RB1#25	1	1	16.39	16.46	17.54	17.39	16.67
		RB1#49	1	1	16.39	16.56	17.36	17.42	16.71
		RB25#0	2	2	14.82	14.95	16.12	16.21	15.67
		RB25#25	2	2	14.83	14.91	16.06	16.19	15.6
		RB50#0	2	2	15.03	14.95	16.22	16.19	15.66
15M	QPSK	RB1#0	0	0	17.26	17.09	17.96	17.98	17.49
		RB1#38	0	0	17.23	17.23	18.08	18.24	17.39
		RB1#74	1	1	17.29	17.27	18.05	18.22	17.25
		RB36#0	1	1	16.74	16.62	17.01	17.05	16.66
		RB36#39	1	1	16.63	16.61	17.1	17.14	16.73
		RB75#0	1	1	16.43	16.53	17.09	17.01	16.72
	16-QAM	RB1#0	1	1	16.57	16.55	17.42	17.44	17.09
		RB1#38	1	1	16.63	16.55	17.53	17.71	16.7
		RB1#74	1	1	16.68	16.66	17.53	17.52	16.65
		RB36#0	2	2	15.24	15.08	16.15	16.1	15.85
		RB36#39	2	2	15.15	15.19	16.12	16.12	15.64
		RB75#0	2	2	15.05	15.04	16.08	16.05	15.71

Test Bandwidth	Test Modulation	Resource Block & RB offset	Target MPR	Meas MPR	Low Channel (dBm)	2549.5 MHz (dBm)	Middle Channel (dBm)	2636.5 MHz (dBm)	High Channel (dBm)
20M	QPSK	RB1#0	0	0	17.39	17.45	18.06	17.9	17.99
		RB1#50	0	0	17.46	17.31	18.11	18.02	17.87
		RB1#99	1	1	17.39	17.61	18.13	18.12	17.61
		RB50#0	1	1	17.16	17.07	17.95	17.76	17.62
		RB50#50	1	1	16.57	16.86	17.33	17.29	17.44
		RB100#0	1	1	16.45	16.78	16.96	17.11	16.88
	16-QAM	RB1#0	1	1	16.21	16.23	17.10	17.09	17.29
		RB1#50	1	1	16.41	16.35	17.34	17.24	17.12
		RB1#99	1	1	16.43	16.41	17.34	17.26	16.94
		RB50#0	2	2	15.05	14.92	15.97	15.96	15.98
		RB50#50	2	2	15.21	15.2	16.02	16.03	15.88
		RB100#0	2	2	14.99	15.04	15.98	16.02	15.97

LTE Band 66:

Test Bandwidth	Test Modulation	Resource Block & RB offset	Target MPR	Meas MPR	Low Channel (dBm)	Middle Channel (dBm)	High Channel (dBm)
1.4M	QPSK	RB1#0	0	0	16.89	16.04	16.52
		RB1#3	0	0	16.92	16.01	16.47
		RB1#5	0	0	16.88	16.02	16.65
		RB3#0	1	1	16.66	15.95	16.34
		RB3#3	1	1	16.85	15.97	16.40
		RB6#0	1	1	15.73	15.13	15.27
	16-QAM	RB1#0	1	1	16.08	14.98	15.69
		RB1#3	1	1	16.13	14.84	15.81
		RB1#5	2	2	15.98	14.84	15.78
		RB3#0	2	2	16.06	15.15	15.79
		RB3#3	2	2	16.15	15.33	15.65
		RB6#0	2	2	14.79	14.28	14.41
3M	QPSK	RB1#0	0	0	16.47	16.57	16.50
		RB1#8	0	0	16.55	16.62	16.64
		RB1#14	0	0	16.51	16.53	16.45
		RB6#0	1	1	15.62	15.63	15.36
		RB6#9	1	1	15.66	15.61	15.25
		RB15#0	1	1	15.68	15.64	15.29
	16-QAM	RB1#0	1	1	15.44	15.56	15.68
		RB1#8	1	1	15.42	15.56	15.83
		RB1#14	1	1	15.46	15.52	15.75
		RB6#0	2	2	14.68	14.76	14.57
		RB6#9	2	2	14.92	14.84	14.68
		RB15#0	2	2	14.90	14.76	14.54
5M	QPSK	RB1#0	0	0	16.94	16.06	15.69
		RB1#13	0	0	16.82	16.09	15.72
		RB1#24	0	0	16.88	16.07	15.72
		RB15#0	1	1	15.83	15.74	15.49
		RB15#10	1	1	15.77	15.62	15.56
		RB25#0	1	1	15.89	15.03	15.08
	16-QAM	RB1#0	1	1	15.99	14.91	15.38
		RB1#13	1	1	16.03	15.02	15.15
		RB1#24	1	1	15.89	14.97	15.21
		RB15#0	2	2	15.17	14.16	13.89
		RB15#10	2	2	15.10	14.15	13.95
		RB25#0	2	2	14.89	14.11	13.79

Test Bandwidth	Test Modulation	Resource Block & RB offset	Target MPR	Meas MPR	Low Channel (dBm)	Middle Channel (dBm)	High Channel (dBm)
10M	QPSK	RB1#0	0	0	16.72	16.74	16.90
		RB1#25	0	0	16.75	16.70	16.90
		RB1#49	1	1	16.79	16.72	16.90
		RB25#0	1	1	15.86	15.60	15.63
		RB25#25	1	1	15.82	15.74	15.68
		RB50#0	1	1	15.78	15.80	15.65
	16-QAM	RB1#0	1	1	15.74	15.80	15.96
		RB1#25	1	1	15.63	15.57	15.99
		RB1#49	1	1	15.54	15.76	16.04
		RB25#0	2	2	15.08	14.87	14.91
		RB25#25	2	2	14.90	14.85	14.84
		RB50#0	2	2	14.92	14.83	14.70
15M	QPSK	RB1#0	0	0	16.41	16.75	16.74
		RB1#38	0	0	16.40	16.83	16.86
		RB1#74	1	1	16.28	16.79	16.62
		RB36#0	1	1	15.40	15.99	15.69
		RB36#39	1	1	15.35	15.94	15.65
		RB75#0	1	1	15.32	15.91	15.74
	16-QAM	RB1#0	1	1	15.60	15.78	15.86
		RB1#38	1	1	15.54	15.96	15.91
		RB1#74	2	2	15.31	15.81	15.82
		RB36#0	2	2	14.36	14.96	14.69
		RB36#39	2	2	14.37	15.03	14.64
		RB75#0	2	2	14.30	14.95	14.76
20M	QPSK	RB1#0	0	0	16.72	16.25	16.18
		RB1#50	0	0	16.80	16.45	16.30
		RB1#99	0	0	16.62	16.24	16.23
		RB50#0	1	1	15.95	15.59	15.23
		RB50#50	1	1	15.87	15.36	15.24
		RB100#0	1	1	15.84	15.30	15.28
	16-QAM	RB1#0	1	1	16.28	15.90	15.61
		RB1#50	1	1	16.23	15.85	15.57
		RB1#99	2	2	16.11	15.91	15.54
		RB50#0	2	2	14.85	14.48	14.30
		RB50#50	2	2	15.00	14.48	14.54
		RB100#0	2	2	14.80	14.44	14.32

WLAN 2.4G:

Mode	Channel frequency (MHz)	Duty cycle (%)	RF Average Output Power(dBm)	
			Chain 0	Chain 1
802.11b	2412	100	10.64	14.06
	2437		11.36	14.38
	2462		10.43	14.41
802.11g	2412	100	9.87	12.39
	2437		10.69	12.41
	2462		9.84	12.21
802.11n ht20	2412	100	9.98	13.39
	2437		10.71	13.26
	2462		9.63	13.35

Note: WLAN 2.4G Duty Cycle please refer to RF Report Number: 2403U82760E-RF-00C

WLAN 5.2G:

Mode	Channel frequency (MHz)	Duty Cycle (%)	Conducted Average Output Power(dBm)
802.11a	5180	100	7.19
	5200		6.78
	5240		6.81
802.11n20	5180	100	6.59
	5200		6.62
	5240		6.42
802.11n40	5190	100	6.64
	5230		6.43
802.11ac80	5210	100	5.82

WLAN 5.3G:

Mode	Channel frequency (MHz)	Duty Cycle (%)	Conducted Average Output Power(dBm)
802.11a	5260	100	6.63
	5280		7.02
	5320		6.79
802.11ac20	5260	100	6.51
	5280		6.34
	5320		6.27
802.11ac40	5270	100	6.28
	5310		6.12
802.11ac80	5290	100	6.43

WLAN 5.6G:

Mode	Channel frequency (MHz)	Duty Cycle (%)	Conducted Average Output Power(dBm)
802.11a	5500	100	6.57
	5580		7.54
	5700		7.93
	5720		7.86
802.11ac20	5500	100	5.78
	5580		6.56
	5700		7.02
	5720		7.29
802.11ac40	5510	100	5.92
	5550		5.83
	5670		7.36
	5710		6.84
802.11ac80	5530	100	5.73
	5610		6.64
	5690		7.23

WLAN 5.8G:

Mode	Channel frequency (MHz)	Duty Cycle (%)	Conducted Average Output Power(dBm)
802.11a	5745	100	7.38
	5785		6.97
	5825		5.86
802.11ac20	5745	100	6.93
	5785		6.34
	5825		5.52
802.11ac40	5755	100	6.88
	5795		6.14
802.11ac80	5775	100	6.42

Note:

1.WLAN 5G Duty Cycle please refer to RF Report Number: 2403U82760E-RF-00D

2.The system support 802.11a/n ht20/n ht40/ac vht20/vht40/vht80, the vht20/vht40 were reduced since the identical parameters with 802.11n ht20 and ht40.

Bluetooth:

Mode	Channel frequency (MHz)	RF Output Power (dBm)	
		Chain 0	Chain 1
BDR(GFSK)	2402	1.97	1.95
	2441	2.34	2.36
	2480	2.21	1.08
EDR($\pi/4$ -DQPSK)	2402	1.03	0.98
	2441	1.54	1.47
	2480	1.31	0.34
EDR(8DPSK)	2402	0.92	0.85
	2441	1.44	1.32
	2480	1.22	0.13
BLE 1M	2402	-4.71	-5.16
	2440	-4.19	-4.82
	2480	-4.38	-5.99
BLE 2M	2404	-4.59	-5.03
	2440	-4.23	-4.72
	2478	-4.34	-5.54

Note: The test data of LTE Band 42/5G NR and LTE Carrier Aggregation, please refer to FCC ID: 2ADYY-KL8S, SAR report of 2401U82760E-SA, issued by Bay Area Compliance Laboratories Corp. (Shenzhen) on 2024/08/09.

7. Standalone SAR test exclusion considerations

Antennas Location:

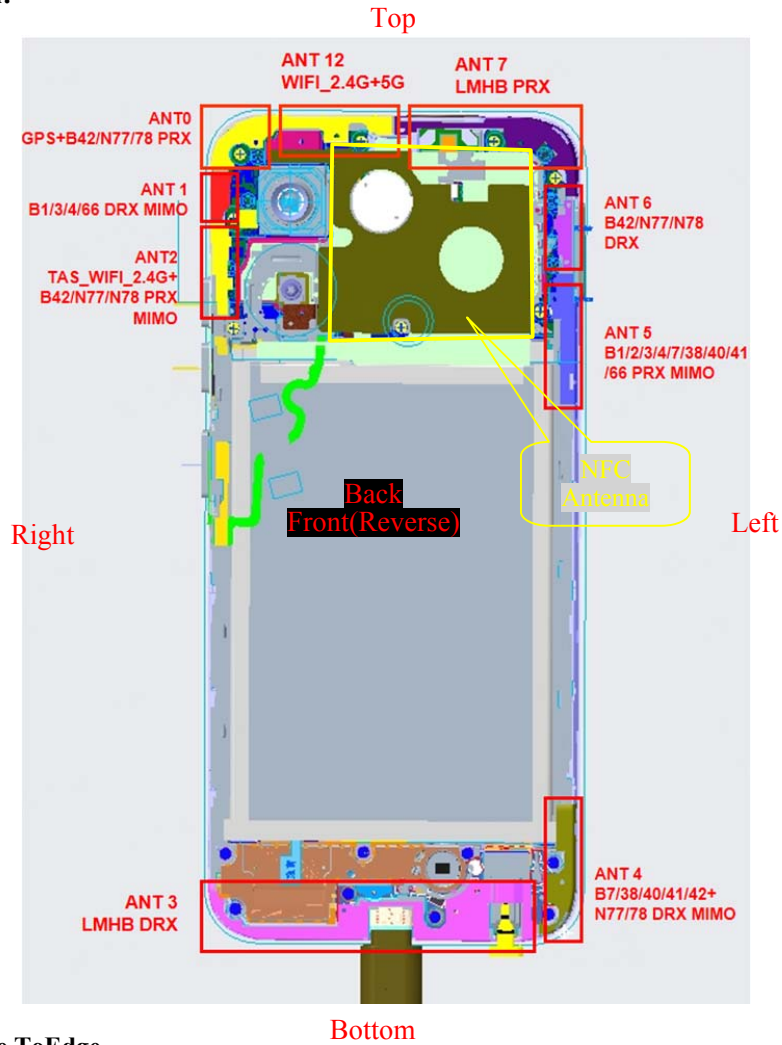

7.1 Antenna Distance ToEdge

Antenna Distance To Edge(mm)						
Antenna	Back	Front	Left	Right	Top	Bottom
Ant 0	< 5	< 5	61	< 5	< 5	155
Ant 2	< 5	< 5	70	< 5	22	135
Ant 3	< 5	< 5	8	< 5	152	< 5
Ant 4	< 5	< 5	< 5	70	144	< 5
Ant 5	< 5	< 5	< 5	70	31	104
Ant 6	< 5	< 5	< 5	72	11	134
Ant 7	< 5	< 5	< 5	38	< 5	158
Ant 12	< 5	< 5	39	16	< 5	160

Antenna	Description
Ant 0	LTE B42, 5G NR n77/78
Ant 2	WIFI 2.4G Chain 1, Bluetooth Chain 1 LTE B42, 5G NR n77/78
Ant 3	GSM850, PCS 1900, WCDMA B2/B4/B5, LTE B2/B4/B5/B7/B12/B13/B17/B38/B41/B66, 5G NR n5/7/12/38/41/66
Ant 4	LTE B42, 5G NR n77/78
Ant 5	WCDMA B2, LTE B2/B4/B7/B38/B41/B66, 5G NR n7/38/41/66
Ant 6	LTE B42, 5G NR n77/78
Ant 7	GSM850, PCS 1900, WCDMA B4/B5, LTE B4/B5/B7/B12/B13/B17/B38/B41/B66, 5G NR n5/7/12/38/41/66
Ant 12	WIFI 2.4G Chain 0, WIFI 5G, Bluetooth Chain 0

Note: The above statistics only include antennas with transmitting

7.2 Standalone SAR test exclusion considerations

Mode	Frequency (MHz)	Output Power (dBm)	Output Power (mW)	Distance (mm)	Calculated value	Threshold (1-g)	SAR Test Exclusion
WLAN 2.4G	2462	14.5	28.18	0	8.8	3.0	No
WLAN 5.2G	5240	7.5	5.62	0	2.6	3.0	YES
WLAN 5.3G	5320	7.5	5.62	0	2.6	3.0	YES
WLAN 5.6G	5720	8.2	6.61	0	3.2	3.0	No
WLAN 5.8G	5825	7.5	5.62	0	2.7	3.0	YES
Bluetooth	2480	2.5	1.78	0	0.6	3.0	YES

Note: The Wi-Fi based average power for calculation, The bluetooth based peak power for calculation.

NOTE:

The 1-g and 10-g SAR test exclusion thresholds for 100 MHz to 6 GHz at test separation distances ≤ 50 mm are determined by:

$[(\text{max. power of channel, including tune-up tolerance, mW}) / (\text{min. test separation distance, mm})] \cdot$

$[\sqrt{f(\text{GHz})}] \leq 3.0$ for 1-g SAR and ≤ 7.5 for 10-g extremity SAR, where

1. $f(\text{GHz})$ is the RF channel transmit frequency in GHz.

2. Power and distance are rounded to the nearest mW and mm before calculation.

3. The result is rounded to one decimal place for comparison.

4. When the minimum test separation distance is < 5 mm, a distance of 5 mm is applied to determine SAR test Exclusion.

According to KDB 447498 D01 General RF Exposure Guidance v06, clause 4.3. General SAR test exclusion guidance:

c) For frequencies below 100 MHz, the following may be considered for SAR test exclusion (also illustrated in Appendix C):

1) For test separation distances > 50 mm and < 200 mm, the power threshold at the corresponding test separation distance at 100 MHz in step b) is multiplied by $[1 + \log(100/f(\text{MHz}))]$

2) For test separation distances ≤ 50 mm, the power threshold determined by the equation in c) 1) for 50 mm and 100 MHz is multiplied by $\frac{1}{2}$

3) SAR measurement procedures are not established below 100 MHz.

Measurement Result:

For NFC, the power of EUT: E Field@3m is 64.67dBuV/m =-30.53dBm(0.0009mW)

Note: $E[\text{dB}\mu\text{V}/\text{m}] = \text{EIRP}[\text{dBm}] + 95.2$ for $d = 3 \text{ m}$.

SAR test exclusion threshold for NFC(13.56MHz) separation distance < 50mm

$$= [474 * (1 + \log(100/f_{\text{MHz}}))] / 2$$

$$= 443 \text{ mW}$$

$$> 0.0009 \text{ mW}$$

Conclusion:

The NFC SAR evaluation can be exempted.

7.3 Standalone SAR estimation:

Mode	Frequency (MHz)	Output Power (dBm)	Output Power (mW)	Distance (mm)	Estimated 1-g (W/kg)
BT Head	2480	2.5	1.78	0	0.07
BT Body	2480	2.5	1.78	10	0.04
WLAN 5.2G Head	5240	7.5	5.62	0	0.34
WLAN 5.2G Body	5240	7.5	5.62	10	0.17
WLAN 5.3G Head	5320	7.5	5.62	0	0.35
WLAN 5.3G Body	5320	7.5	5.62	10	0.18
WLAN 5.8G Head	5825	7.5	5.62	0	0.36
WLAN 5.8G Body	5825	7.5	5.62	10	0.18

Note: The Wi-Fi based average power for calculation, The bluetooth based peak power for calculation.

When standalone SAR test exclusion applies to an antenna that transmits simultaneously with other antennas, the standalone SAR must be estimated according to following to determine simultaneous transmission SAR test exclusion:

$$[(\text{max. power of channel, including tune-up tolerance, mW}) / (\text{min. test separation distance, mm})] \cdot [\sqrt{f(\text{GHz})} / x]$$

W/kg for test separation distances $\leq 50 \text{ mm}$;

where $x = 7.5$ for 1-g SAR.

When the minimum test separation distance is < 5 mm, a distance of 5 mm is applied to determine SAR test Exclusion

7.4 SAR test exclusion for the EUT edge considerations Result

Mode	Back	Front	Left	Right	Top	Bottom
Bluetooth	Exclusion*	Exclusion*	Exclusion*	Exclusion*	Exclusion*	Exclusion*
WLAN 5.2G	Exclusion*	Exclusion*	Exclusion*	Exclusion*	Exclusion*	Exclusion*
WLAN 5.3G	Exclusion*	Exclusion*	Exclusion*	Exclusion*	Exclusion*	Exclusion*
WLAN 5.6G	Required	Required	Exclusion	Required	Required	Exclusion
WLAN 5.8G	Exclusion*	Exclusion*	Exclusion*	Exclusion*	Exclusion*	Exclusion*
WWAN(Ant 3)	Required	Required	Required	Required	Exclusion	Required
WWAN(Ant 5)	Required	Required	Required	Exclusion	Exclusion	Exclusion
WWAN(Ant 7)	Required	Required	Required	Exclusion	Required	Exclusion
WLAN(Ant 2)	Required	Required	Exclusion	Required	Required	Exclusion
WLAN(Ant 12)	Required	Required	Exclusion	Required	Required	Exclusion

Note:

Required: The distance to Edge is less than 25mm, testing is required.

Exclusion*: SAR test exclusion evaluation has been done above.

Exclusion: The distance to Edge is more than 25 mm, testing is not required.

Extremity Exposure Considerations

Per KDB 648474 D04 D04v01r03, this device is considered a “Phablet” since the diagonal dimension is >160mm and < 200mm, when hotspot mode applies, extremity SAR is required only for the surfaces and edges with hotspot mode scaled to the maximum output power (with tolerance is 1g SAR > 1.2W/kg)

Extremity Exposure Condition		
Worst Mode	Hotspot SAR value	Extremity Condition Test
LTE Band 2	0.78 W/kg@1g	Exclusion

Note: The test data of LTE Band 42/5G NR and LTE Carrier Aggregation, please refer to FCC ID: 2ADYY-KL8S, SAR report of 2401U82760E-SA, issued by Bay Area Compliance Laboratories Corp. (Shenzhen) on 2024/08/09.

8. SAR MEASUREMENT RESULTS

This page summarizes the results of the performed dosimetric evaluation.

8.1 SAR Test Data

Environmental Conditions

Temperature:	22.9-23.6°C	22.2-23.7°C	22.1-23.5°C	22.6-23.7°C	22.5-23.8°C	22.7-23.6°C
Relative Humidity:	57%	54%	56 %	53 %	58%	54%
ATM Pressure:	101.5kPa	100.6kPa	100.8kPa	101kPa	100.9kPa	100.7kPa
Test Date:	2024/07/11	2024/07/12	2024/07/13	2024/07/14	2024/07/15	2024/07/16
Temperature:	22.5-23.8°C	22.9-24.1°C	22.2-23.6°C	21.7-22.9°C	21.7-22.9°C	21.9-23.1°C
Relative Humidity:	58%	55%	56 %	55 %	55 %	57 %
ATM Pressure:	101.6kPa	101.3kPa	100.6kPa	100.3kPa	100.4kPa	100.3kPa
Test Date:	2024/07/17	2024/07/18	2024/07/19	2024/07/20	2024/07/21	2024/07/22

Testing was performed by Wen Chen, Leo Lu, Aixlee Li, Ken Zong.

GSM 850(Ant 3):

EUT Position	Frequency (MHz)	Test Mode	Max. Meas. Power (dBm)	Max. Rated Power (dBm)	1g SAR (W/kg)			
					Scaled Factor	Meas. SAR	Scaled SAR	Plot
Head Left Cheek	824.2	GSM	/	/	/	/	/	/
	836.6	GSM	30.81	31.1	1.069	0.027	0.03	1#
	848.8	GSM	/	/	/	/	/	/
Head Left Tilt	824.2	GSM	/	/	/	/	/	/
	836.6	GSM	30.81	31.1	1.069	0.013	0.01	/
	848.8	GSM	/	/	/	/	/	/
Head Right Cheek	824.2	GSM	/	/	/	/	/	/
	836.6	GSM	30.81	31.1	1.069	0.011	0.01	/
	848.8	GSM	/	/	/	/	/	/
Head Right Tilt	824.2	GSM	/	/	/	/	/	/
	836.6	GSM	30.81	31.1	1.069	0.01	0.01	/
	848.8	GSM	/	/	/	/	/	/
Body Worn Front (10mm)	824.2	GSM	/	/	/	/	/	/
	836.6	GSM	30.81	31.1	1.069	0.049	0.05	/
	848.8	GSM	/	/	/	/	/	/
Body Worn Back (10mm)	824.2	GSM	/	/	/	/	/	/
	836.6	GSM	30.81	31.1	1.069	0.073	0.08	/
	848.8	GSM	/	/	/	/	/	/
Body Front (10mm)	824.2	GPRS	/	/	/	/	/	/
	836.6	GPRS	28.22	28.4	1.042	0.08	0.08	/
	848.8	GPRS	/	/	/	/	/	/
Body Back (10mm)	824.2	GPRS	/	/	/	/	/	/
	836.6	GPRS	28.22	28.4	1.042	0.153	0.16	2#
	848.8	GPRS	/	/	/	/	/	/
Body Left (10mm)	824.2	GPRS	/	/	/	/	/	/
	836.6	GPRS	28.22	28.4	1.042	< 0.01	0.01	/
	848.8	GPRS	/	/	/	/	/	/
Body Right (10mm)	824.2	GPRS	/	/	/	/	/	/
	836.6	GPRS	28.22	28.4	1.042	0.038	0.04	/
	848.8	GPRS	/	/	/	/	/	/
Body Bottom (10mm)	824.2	GPRS	/	/	/	/	/	/
	836.6	GPRS	28.22	28.4	1.042	0.084	0.09	/
	848.8	GPRS	/	/	/	/	/	/

The data above was performed on 2024/07/18.

GSM 850(Ant 7):

EUT Position	Frequency (MHz)	Test Mode	Max. Meas. Power (dBm)	Max. Rated Power (dBm)	1g SAR (W/kg)			
					Scaled Factor	Meas. SAR	Scaled SAR	Plot
Head Left Cheek	824.2	GSM	/	/	/	/	/	/
	836.6	GSM	30.81	31.1	1.069	0.362	0.39	/
	848.8	GSM	/	/	/	/	/	/
Head Left Tilt	824.2	GSM	/	/	/	/	/	/
	836.6	GSM	30.81	31.1	1.069	0.406	0.43	/
	848.8	GSM	/	/	/	/	/	/
Head Right Cheek	824.2	GSM	/	/	/	/	/	/
	836.6	GSM	30.81	31.1	1.069	0.688	0.74	3#
	848.8	GSM	/	/	/	/	/	/
Head Right Tilt	824.2	GSM	/	/	/	/	/	/
	836.6	GSM	30.81	31.1	1.069	0.626	0.67	/
	848.8	GSM	/	/	/	/	/	/
Body Worn Front (10mm)	824.2	GSM	/	/	/	/	/	/
	836.6	GSM	30.81	31.1	1.069	0.069	0.07	/
	848.8	GSM	/	/	/	/	/	/
Body Worn Back (10mm)	824.2	GSM	/	/	/	/	/	/
	836.6	GSM	30.81	31.1	1.069	0.135	0.14	/
	848.8	GSM	/	/	/	/	/	/
Body Front (10mm)	824.2	GPRS	/	/	/	/	/	/
	836.6	GPRS	28.22	28.4	1.042	0.189	0.20	/
	848.8	GPRS	/	/	/	/	/	/
Body Back (10mm)	824.2	GPRS	/	/	/	/	/	/
	836.6	GPRS	28.22	28.4	1.042	0.27	0.28	4#
	848.8	GPRS	/	/	/	/	/	/
Body Left (10mm)	824.2	GPRS	/	/	/	/	/	/
	836.6	GPRS	28.22	28.4	1.042	0.067	0.07	/
	848.8	GPRS	/	/	/	/	/	/
Body Top (10mm)	824.2	GPRS	/	/	/	/	/	/
	836.6	GPRS	28.22	28.4	1.042	0.236	0.25	/
	848.8	GPRS	/	/	/	/	/	/

The data above was performed on 2024/07/18.

Note:

1. When the 1-g SAR is $\leq 0.8\text{W/Kg}$, testing for other channels are optional.
2. The EUT transmit and receive through the same GSM antenna while testing SAR.
3. When SAR or MPE is not measured at the maximum power level allowed for production units, the results must be scaled to the maximum tune-up tolerance limit according to the power applied to the individual channels tested to determine compliance.
4. When the maximum output power variation across the required test channels is $> 0.5\text{ dB}$, instead of the middle channel, the highest output power channel must be used.
5. The Multi-slot Classes of EUT is Class 12 which has maximum 4 Downlink slots and 4 Uplink slots, the maximum active slots is 5, when perform the multiple slots scan, 1DL+4UL is the worst case.

PCS 1900(Ant 3):

EUT Position	Frequency (MHz)	Test Mode	Max. Meas. Power (dBm)	Max. Rated Power (dBm)	1g SAR (W/kg)			
					Scaled Factor	Meas. SAR	Scaled SAR	Plot
Head Left Cheek	1850.2	GSM	/	/	/	/	/	/
	1880	GSM	26.28	26.5	1.052	< 0.01	0.01	/
	1909.8	GSM	/	/	/	/	/	/
Head Left Tilt	1850.2	GSM	/	/	/	/	/	/
	1880	GSM	26.28	26.5	1.052	< 0.01	0.01	/
	1909.8	GSM	/	/	/	/	/	/
Head Right Cheek	1850.2	GSM	/	/	/	/	/	/
	1880	GSM	26.28	26.5	1.052	< 0.01	0.01	/
	1909.8	GSM	/	/	/	/	/	/
Head Right Tilt	1850.2	GSM	/	/	/	/	/	/
	1880	GSM	26.28	26.5	1.052	< 0.01	0.01	/
	1909.8	GSM	/	/	/	/	/	/
Body Worn Front (10mm)	1850.2	GSM	/	/	/	/	/	/
	1880	GSM	26.28	26.5	1.052	0.058	0.06	/
	1909.8	GSM	/	/	/	/	/	/
Body Worn Back (10mm)	1850.2	GSM	/	/	/	/	/	/
	1880	GSM	26.28	26.5	1.052	0.1	0.11	/
	1909.8	GSM	/	/	/	/	/	/
Body Front (10mm)	1850.2	GPRS	/	/	/	/	/	/
	1880	GPRS	25.17	25.3	1.03	0.081	0.08	/
	1909.8	GPRS	/	/	/	/	/	/
Body Back (10mm)	1850.2	GPRS	/	/	/	/	/	/
	1880	GPRS	25.17	25.3	1.03	0.113	0.12	/
	1909.8	GPRS	/	/	/	/	/	/
Body Left (10mm)	1850.2	GPRS	/	/	/	/	/	/
	1880	GPRS	25.17	25.3	1.03	0.015	0.02	/
	1909.8	GPRS	/	/	/	/	/	/
Body Right (10mm)	1850.2	GPRS	/	/	/	/	/	/
	1880	GPRS	25.17	25.3	1.03	< 0.01	0.01	/
	1909.8	GPRS	/	/	/	/	/	/
Body Bottom (10mm)	1850.2	GPRS	/	/	/	/	/	/
	1880	GPRS	25.17	25.3	1.03	0.263	0.27	5#
	1909.8	GPRS	/	/	/	/	/	/

The data above was performed on 2024/07/22.

PCS 1900(Ant 7):

EUT Position	Frequency (MHz)	Test Mode	Max. Meas. Power (dBm)	Max. Rated Power (dBm)	1g SAR (W/kg)			
					Scaled Factor	Meas. SAR	Scaled SAR	Plot
Head Left Cheek	1850.2	GSM	/	/	/	/	/	/
	1880	GSM	26.28	26.5	1.052	0.376	0.4	/
	1909.8	GSM	/	/	/	/	/	/
Head Left Tilt	1850.2	GSM	/	/	/	/	/	/
	1880	GSM	26.28	26.5	1.052	0.463	0.49	/
	1909.8	GSM	/	/	/	/	/	/
Head Right Cheek	1850.2	GSM	/	/	/	/	/	/
	1880	GSM	26.28	26.5	1.052	0.436	0.46	/
	1909.8	GSM	/	/	/	/	/	/
Head Right Tilt	1850.2	GSM	/	/	/	/	/	/
	1880	GSM	26.28	26.5	1.052	0.586	0.62	6#
	1909.8	GSM	/	/	/	/	/	/
Body Worn Front (10mm)	1850.2	GSM	/	/	/	/	/	/
	1880	GSM	26.28	26.5	1.052	0.117	0.12	/
	1909.8	GSM	/	/	/	/	/	/
Body Worn Back (10mm)	1850.2	GSM	/	/	/	/	/	/
	1880	GSM	26.28	26.5	1.052	0.168	0.18	/
	1909.8	GSM	/	/	/	/	/	/
Body Front (10mm)	1850.2	GPRS	/	/	/	/	/	/
	1880	GPRS	25.17	25.3	1.03	0.121	0.12	/
	1909.8	GPRS	/	/	/	/	/	/
Body Back (10mm)	1850.2	GPRS	/	/	/	/	/	/
	1880	GPRS	25.17	25.3	1.03	0.169	0.17	/
	1909.8	GPRS	/	/	/	/	/	/
Body Left (10mm)	1850.2	GPRS	/	/	/	/	/	/
	1880	GPRS	25.17	25.3	1.03	0.027	0.03	/
	1909.8	GPRS	/	/	/	/	/	/
Body Top (10mm)	1850.2	GPRS	/	/	/	/	/	/
	1880	GPRS	25.17	25.3	1.03	0.24	0.25	7#
	1909.8	GPRS	/	/	/	/	/	/

The data above was performed on 2024/07/22.

Note:

1. When the 1-g SAR is $\leq 0.8\text{W/Kg}$, testing for other channels are optional.
2. The EUT transmit and receive through the same GSM antenna while testing SAR.
3. When SAR or MPE is not measured at the maximum power level allowed for production units, the results must be scaled to the maximum tune-up tolerance limit according to the power applied to the individual channels tested to determine compliance.
4. When the maximum output power variation across the required test channels is $> 0.5\text{ dB}$, instead of the middle channel, the highest output power channel must be used.
5. The Multi-slot Classes of EUT is Class 12 which has maximum 4 Downlink slots and 4 Uplink slots, the maximum active slots is 5, when perform the multiple slots scan, 1DL+4UL is the worst case.

WCDMA Band 2(Ant 3):

EUT Position	Frequency (MHz)	Test Mode	Max. Meas. Power (dBm)	Max. Rated Power (dBm)	1g SAR (W/kg)			
					Scaled Factor	Meas. SAR	Scaled SAR	Plot
Head Left Cheek	1852.4	RMC	/	/	/	/	/	/
	1880	RMC	22.86	23.1	1.057	0.013	0.01	/
	1907.6	RMC	/	/	/	/	/	/
Head Left Tilt	1852.4	RMC	/	/	/	/	/	/
	1880	RMC	22.86	23.1	1.057	< 0.01	0.01	/
	1907.6	RMC	/	/	/	/	/	/
Head Right Cheek	1852.4	RMC	/	/	/	/	/	/
	1880	RMC	22.86	23.1	1.057	0.015	0.02	8#
	1907.6	RMC	/	/	/	/	/	/
Head Right Tilt	1852.4	RMC	/	/	/	/	/	/
	1880	RMC	22.86	23.1	1.057	< 0.01	0.01	/
	1907.6	RMC	/	/	/	/	/	/
Body Front (10mm)	1852.4	RMC	/	/	/	/	/	/
	1880	RMC	22.86	23.1	1.057	0.327	0.35	/
	1907.6	RMC	/	/	/	/	/	/
BodyBack (10mm)	1852.4	RMC	/	/	/	/	/	/
	1880	RMC	22.86	23.1	1.057	0.439	0.46	/
	1907.6	RMC	/	/	/	/	/	/
Body Left (10mm)	1852.4	RMC	/	/	/	/	/	/
	1880	RMC	22.86	23.1	1.057	< 0.01	0.01	/
	1907.6	RMC	/	/	/	/	/	/
Body Right (10mm)	1852.4	RMC	/	/	/	/	/	/
	1880	RMC	22.86	23.1	1.057	0.071	0.08	/
	1907.6	RMC	/	/	/	/	/	/
Body Bottom (10mm)	1852.4	RMC	/	/	/	/	/	/
	1880	RMC	22.86	23.1	1.057	0.539	0.57	9#
	1907.6	RMC	/	/	/	/	/	/

The data above was performed on 2024/07/22.

WCDMA Band 2(Ant 5):

EUT Position	Frequency (MHz)	Test Mode	Max. Meas. Power (dBm)	Max. Rated Power (dBm)	1g SAR (W/kg)			
					Scaled Factor	Meas. SAR	Scaled SAR	Plot
Head Left Cheek	1852.4	RMC	/	/	/	/	/	/
	1880	RMC	22.86	23.1	1.057	0.034	0.04	/
	1907.6	RMC	/	/	/	/	/	/
Head Left Tilt	1852.4	RMC	/	/	/	/	/	/
	1880	RMC	22.86	23.1	1.057	< 0.01	0.01	/
	1907.6	RMC	/	/	/	/	/	/
Head Right Cheek	1852.4	RMC	/	/	/	/	/	/
	1880	RMC	22.86	23.1	1.057	0.054	0.06	10#
	1907.6	RMC	/	/	/	/	/	/
Head Right Tilt	1852.4	RMC	/	/	/	/	/	/
	1880	RMC	22.86	23.1	1.057	0.017	0.02	/
	1907.6	RMC	/	/	/	/	/	/
Body Front (10mm)	1852.4	RMC	/	/	/	/	/	/
	1880	RMC	22.86	23.1	1.057	0.011	0.01	/
	1907.6	RMC	/	/	/	/	/	/
BodyBack (10mm)	1852.4	RMC	/	/	/	/	/	/
	1880	RMC	22.86	23.1	1.057	0.051	0.05	11#
	1907.6	RMC	/	/	/	/	/	/
Body Left (10mm)	1852.4	RMC	/	/	/	/	/	/
	1880	RMC	22.86	23.1	1.057	0.03	0.03	/
	1907.6	RMC	/	/	/	/	/	/

The data above was performed on 2024/07/22.

WCDMA Band 4(Ant 3):

EUT Position	Frequency (MHz)	Test Mode	Max. Meas. Power (dBm)	Max. Rated Power (dBm)	1g SAR (W/kg)			
					Scaled Factor	Meas. SAR	Scaled SAR	Plot
Head Left Cheek	1712.4	RMC	/	/	/	/	/	/
	1732.6	RMC	16.58	16.7	1.028	< 0.01	0.01	/
	1752.6	RMC	/	/	/	/	/	/
Head Left Tilt	1712.4	RMC	/	/	/	/	/	/
	1732.6	RMC	16.58	16.7	1.028	< 0.01	0.01	/
	1752.6	RMC	/	/	/	/	/	/
Head Right Cheek	1712.4	RMC	/	/	/	/	/	/
	1732.6	RMC	16.58	16.7	1.028	< 0.01	0.01	/
	1752.6	RMC	/	/	/	/	/	/
Head Right Tilt	1712.4	RMC	/	/	/	/	/	/
	1732.6	RMC	16.58	16.7	1.028	< 0.01	0.01	/
	1752.6	RMC	/	/	/	/	/	/
Body Front (10mm)	1712.4	RMC	/	/	/	/	/	/
	1732.6	RMC	16.58	16.7	1.028	0.035	0.04	/
	1752.6	RMC	/	/	/	/	/	/
BodyBack (10mm)	1712.4	RMC	/	/	/	/	/	/
	1732.6	RMC	16.58	16.7	1.028	0.043	0.04	12#
	1752.6	RMC	/	/	/	/	/	/
Body Left (10mm)	1712.4	RMC	/	/	/	/	/	/
	1732.6	RMC	16.58	16.7	1.028	< 0.01	0.01	/
	1752.6	RMC	/	/	/	/	/	/
Body Right (10mm)	1712.4	RMC	/	/	/	/	/	/
	1732.6	RMC	16.58	16.7	1.028	< 0.01	0.01	/
	1752.6	RMC	/	/	/	/	/	/
Body Bottom (10mm)	1712.4	RMC	/	/	/	/	/	/
	1732.6	RMC	16.58	16.7	1.028	0.043	0.04	/
	1752.6	RMC	/	/	/	/	/	/

The data above was performed on 2024/07/20.

WCDMA Band 4(Ant 7):

EUT Position	Frequency (MHz)	Test Mode	Max. Meas. Power (dBm)	Max. Rated Power (dBm)	1g SAR (W/kg)			
					Scaled Factor	Meas. SAR	Scaled SAR	Plot
Head Left Cheek	1712.4	RMC	/	/	/	/	/	/
	1732.6	RMC	16.58	16.7	1.028	0.22	0.23	/
	1752.6	RMC	/	/	/	/	/	/
Head Left Tilt	1712.4	RMC	/	/	/	/	/	/
	1732.6	RMC	16.58	16.7	1.028	0.294	0.30	/
	1752.6	RMC	/	/	/	/	/	/
Head Right Cheek	1712.4	RMC	/	/	/	/	/	/
	1732.6	RMC	16.58	16.7	1.028	0.331	0.34	/
	1752.6	RMC	/	/	/	/	/	/
Head Right Tilt	1712.4	RMC	/	/	/	/	/	/
	1732.6	RMC	16.58	16.7	1.028	0.409	0.42	13#
	1752.6	RMC	/	/	/	/	/	/
Body Front (10mm)	1712.4	RMC	/	/	/	/	/	/
	1732.6	RMC	16.58	16.7	1.028	0.1	0.10	/
	1752.6	RMC	/	/	/	/	/	/
BodyBack (10mm)	1712.4	RMC	/	/	/	/	/	/
	1732.6	RMC	16.58	16.7	1.028	0.104	0.11	/
	1752.6	RMC	/	/	/	/	/	/
Body Left (10mm)	1712.4	RMC	/	/	/	/	/	/
	1732.6	RMC	16.58	16.7	1.028	0.031	0.03	/
	1752.6	RMC	/	/	/	/	/	/
Body Top (10mm)	1712.4	RMC	/	/	/	/	/	/
	1732.6	RMC	16.58	16.7	1.028	0.142	0.15	14#
	1752.6	RMC	/	/	/	/	/	/

The data above was performed on 2024/07/20.

WCDMA Band 5(Ant 3):

EUT Position	Frequency (MHz)	Test Mode	Max. Meas. Power (dBm)	Max. Rated Power (dBm)	1g SAR (W/kg)			
					Scaled Factor	Meas. SAR	Scaled SAR	Plot
Head Left Cheek	826.4	RMC	/	/	/	/	/	/
	836.6	RMC	23.14	23.3	1.038	0.038	0.04	/
	846.6	RMC	/	/	/	/	/	/
Head Left Tilt	826.4	RMC	/	/	/	/	/	/
	836.6	RMC	23.14	23.3	1.038	0.016	0.02	/
	846.6	RMC	/	/	/	/	/	/
Head Right Cheek	826.4	RMC	/	/	/	/	/	/
	836.6	RMC	23.14	23.3	1.038	0.038	0.04	15#
	846.6	RMC	/	/	/	/	/	/
Head Right Tilt	826.4	RMC	/	/	/	/	/	/
	836.6	RMC	23.14	23.3	1.038	0.032	0.03	/
	846.6	RMC	/	/	/	/	/	/
Body Front (10mm)	826.4	RMC	/	/	/	/	/	/
	836.6	RMC	23.14	23.3	1.038	0.051	0.05	/
	846.6	RMC	/	/	/	/	/	/
Body Back (10mm)	826.4	RMC	/	/	/	/	/	/
	836.6	RMC	23.14	23.3	1.038	0.07	0.07	16#
	846.6	RMC	/	/	/	/	/	/
Body Left (10mm)	826.4	RMC	/	/	/	/	/	/
	836.6	RMC	23.14	23.3	1.038	< 0.01	0.01	/
	846.6	RMC	/	/	/	/	/	/
Body Right (10mm)	826.4	RMC	/	/	/	/	/	/
	836.6	RMC	23.14	23.3	1.038	0.025	0.03	/
	846.6	RMC	/	/	/	/	/	/
Body Bottom (10mm)	826.4	RMC	/	/	/	/	/	/
	836.6	RMC	23.14	23.3	1.038	0.067	0.07	/
	846.6	RMC	/	/	/	/	/	/

The data above was performed on 2024/07/18.

WCDMA Band 5(Ant 7):

EUT Position	Frequency (MHz)	Test Mode	Max. Meas. Power (dBm)	Max. Rated Power (dBm)	1g SAR (W/kg)			
					Scaled Factor	Meas. SAR	Scaled SAR	Plot
Head Left Cheek	826.4	RMC	/	/	/	/	/	/
	836.6	RMC	23.14	23.3	1.038	0.719	0.75	/
	846.6	RMC	/	/	/	/	/	/
Head Left Tilt	826.4	RMC	/	/	/	/	/	/
	836.6	RMC	23.14	23.3	1.038	0.512	0.53	/
	846.6	RMC	/	/	/	/	/	/
Head Right Cheek	826.4	RMC	/	/	/	/	/	/
	836.6	RMC	23.14	23.3	1.038	0.712	0.74	/
	846.6	RMC	/	/	/	/	/	/
Head Right Tilt	826.4	RMC	/	/	/	/	/	/
	836.6	RMC	23.14	23.3	1.038	0.753	0.78	17#
	846.6	RMC	/	/	/	/	/	/
Body Front (10mm)	826.4	RMC	/	/	/	/	/	/
	836.6	RMC	23.14	23.3	1.038	0.168	0.17	18#
	846.6	RMC	/	/	/	/	/	/
Body Back (10mm)	826.4	RMC	/	/	/	/	/	/
	836.6	RMC	23.14	23.3	1.038	0.165	0.17	/
	846.6	RMC	/	/	/	/	/	/
Body Left (10mm)	826.4	RMC	/	/	/	/	/	/
	836.6	RMC	23.14	23.3	1.038	0.046	0.05	/
	846.6	RMC	/	/	/	/	/	/
Body Top (10mm)	826.4	RMC	/	/	/	/	/	/
	836.6	RMC	23.14	23.3	1.038	0.156	0.16	/
	846.6	RMC	/	/	/	/	/	/

The data above was performed on 2024/07/18.

Note:

1. When the 1-g SAR is $\leq 0.8\text{W/Kg}$, testing for other channels are optional.
2. The EUT transmit and receive through the same antenna while testing SAR.
3. The default test configuration is to measure SAR with an established radio link between the EUT and a communication test set using a 12.2 kbps RMC (reference measurement Channel) Configured in Test Loop Model.
4. KDB 941225 D01-Body SAR is not required for HSDPA/HSUPA when the maximum average output of each RF channel is less than $\frac{1}{4}$ dB higher than measured 12.2kbps RMC or the maximum SAR for 12.2kbps RMC is $< 75\%$ of SAR limit.
5. When SAR or MPE is not measured at the maximum power level allowed for production units, the results must be scaled to the maximum tune-up tolerance limit according to the power applied to the individual channels tested to determine compliance.

LTE Band 2(Ant 3):

EUT Position	Frequency (MHz)	Bandwidth (MHz)	Test Mode	Max. Meas. Power (dBm)	Max. Rated Power (dBm)	1g SAR (W/kg)			
						Scaled Factor	Meas. SAR	Scaled SAR	Plot
Head Left Cheek	1860	20	1RB	/	/	/	/	/	/
	1880	20	1RB	18.83	19.3	1.114	0.014	0.02	19#
	1900	20	1RB	/	/	/	/	/	/
	1880	20	50%RB	17.94	19.3	1.368	0.012	0.02	/
Head Left Tilt	1860	20	1RB	/	/	/	/	/	/
	1880	20	1RB	18.83	19.3	1.114	< 0.01	0.01	/
	1900	20	1RB	/	/	/	/	/	/
	1880	20	50%RB	17.94	19.3	1.368	< 0.01	0.01	/
Head Right Cheek	1860	20	1RB	/	/	/	/	/	/
	1880	20	1RB	18.83	19.3	1.114	< 0.01	0.01	/
	1900	20	1RB	/	/	/	/	/	/
	1880	20	50%RB	17.94	19.3	1.368	< 0.01	0.01	/
Head Right Tilt	1860	20	1RB	/	/	/	/	/	/
	1880	20	1RB	18.83	19.3	1.114	< 0.01	0.01	/
	1900	20	1RB	/	/	/	/	/	/
	1880	20	50%RB	17.94	19.3	1.368	< 0.01	0.01	/
Body Front (10mm)	1860	20	1RB	/	/	/	/	/	/
	1880	20	1RB	18.83	19.3	1.114	0.323	0.36	/
	1900	20	1RB	/	/	/	/	/	/
	1880	20	50%RB	17.94	19.3	1.368	0.252	0.34	/
Body Back (10mm)	1860	20	1RB	/	/	/	/	/	/
	1880	20	1RB	18.83	19.3	1.114	0.461	0.51	/
	1900	20	1RB	/	/	/	/	/	/
	1880	20	50%RB	17.94	19.3	1.368	0.365	0.50	/
Body Left (10mm)	1860	20	1RB	/	/	/	/	/	/
	1880	20	1RB	18.83	19.3	1.114	0.023	0.03	/
	1900	20	1RB	/	/	/	/	/	/
	1880	20	50%RB	17.94	19.3	1.368	0.017	0.02	/
Body Right (10mm)	1860	20	1RB	/	/	/	/	/	/
	1880	20	1RB	18.83	19.3	1.114	0.027	0.03	/
	1900	20	1RB	/	/	/	/	/	/
	1880	20	50%RB	17.94	19.3	1.368	0.022	0.03	/
Body Bottom (10mm)	1860	20	1RB	/	/	/	/	/	/
	1880	20	1RB	18.83	19.3	1.114	0.704	0.78	20#
	1900	20	1RB	/	/	/	/	/	/
	1880	20	50%RB	17.94	19.3	1.368	0.559	0.76	/

The data above was performed on 2024/07/21.

LTE Band 2(Ant 5):

EUT Position	Frequency (MHz)	Bandwidth (MHz)	Test Mode	Max. Meas. Power (dBm)	Max. Rated Power (dBm)	1g SAR (W/kg)			
						Scaled Factor	Meas. SAR	Scaled SAR	Plot
Head Left Cheek	1860	20	1RB	/	/	/	/	/	/
	1880	20	1RB	18.83	19.3	1.114	0.038	0.04	/
	1900	20	1RB	/	/	/	/	/	/
	1880	20	50%RB	17.94	19.3	1.368	0.024	0.03	/
Head Left Tilt	1860	20	1RB	/	/	/	/	/	/
	1880	20	1RB	18.83	19.3	1.114	< 0.01	0.01	/
	1900	20	1RB	/	/	/	/	/	/
	1880	20	50%RB	17.94	19.3	1.368	< 0.01	0.01	/
Head Right Cheek	1860	20	1RB	/	/	/	/	/	/
	1880	20	1RB	18.83	19.3	1.114	0.057	0.06	21#
	1900	20	1RB	/	/	/	/	/	/
	1880	20	50%RB	17.94	19.3	1.368	0.039	0.05	/
Head Right Tilt	1860	20	1RB	/	/	/	/	/	/
	1880	20	1RB	18.83	19.3	1.114	0.011	0.01	/
	1900	20	1RB	/	/	/	/	/	/
	1880	20	50%RB	17.94	19.3	1.368	< 0.01	0.01	/
Body Front (10mm)	1860	20	1RB	/	/	/	/	/	/
	1880	20	1RB	18.83	19.3	1.114	0.029	0.03	/
	1900	20	1RB	/	/	/	/	/	/
	1880	20	50%RB	17.94	19.3	1.368	0.015	0.02	/
Body Back (10mm)	1860	20	1RB	/	/	/	/	/	/
	1880	20	1RB	18.83	19.3	1.114	0.041	0.05	/
	1900	20	1RB	/	/	/	/	/	/
	1880	20	50%RB	17.94	19.3	1.368	0.034	0.05	/
Body Left (10mm)	1860	20	1RB	/	/	/	/	/	/
	1880	20	1RB	18.83	19.3	1.114	0.124	0.14	22#
	1900	20	1RB	/	/	/	/	/	/
	1880	20	50%RB	17.94	19.3	1.368	0.1	0.14	/

The data above was performed on 2024/07/21.

LTE Band 5(Ant 3):

EUT Position	Frequency (MHz)	Bandwidth (MHz)	Test Mode	Max. Meas. Power (dBm)	Max. Rated Power (dBm)	1g SAR (W/kg)			
						Scaled Factor	Meas. SAR	Scaled SAR	Plot
Head Left Cheek	829	10	1RB	/	/	/	/	/	/
	836.5	10	1RB	19.87	20	1.03	0.022	0.02	/
	844	10	1RB	/	/	/	/	/	/
	836.5	10	50%RB	19.02	20	1.253	0.016	0.02	/
Head Left Tilt	829	10	1RB	/	/	/	/	/	/
	836.5	10	1RB	19.87	20	1.03	< 0.01	0.01	/
	844	10	1RB	/	/	/	/	/	/
	836.5	10	50%RB	19.02	20	1.253	< 0.01	0.01	/
Head Right Cheek	829	10	1RB	/	/	/	/	/	/
	836.5	10	1RB	19.87	20	1.03	0.032	0.03	/
	844	10	1RB	/	/	/	/	/	/
	836.5	10	50%RB	19.02	20	1.253	0.029	0.04	23#
Head Right Tilt	829	10	1RB	/	/	/	/	/	/
	836.5	10	1RB	19.87	20	1.03	0.015	0.02	/
	844	10	1RB	/	/	/	/	/	/
	836.5	10	50%RB	19.02	20	1.253	0.014	0.02	/
Body Front (10mm)	829	10	1RB	/	/	/	/	/	/
	836.5	10	1RB	19.87	20	1.03	0.148	0.15	/
	844	10	1RB	/	/	/	/	/	/
	836.5	10	50%RB	19.02	20	1.253	0.128	0.16	/
Body Back (10mm)	829	10	1RB	/	/	/	/	/	/
	836.5	10	1RB	19.87	20	1.03	0.214	0.22	24#
	844	10	1RB	/	/	/	/	/	/
	836.5	10	50%RB	19.02	20	1.253	0.176	0.22	/
Body Left (10mm)	829	10	1RB	/	/	/	/	/	/
	836.5	10	1RB	19.87	20	1.03	< 0.01	0.01	/
	844	10	1RB	/	/	/	/	/	/
	836.5	10	50%RB	19.02	20	1.253	< 0.01	0.01	/
Body Right (10mm)	829	10	1RB	/	/	/	/	/	/
	836.5	10	1RB	19.87	20	1.03	0.047	0.05	/
	844	10	1RB	/	/	/	/	/	/
	836.5	10	50%RB	19.02	20	1.253	0.038	0.05	/
Body Bottom (10mm)	829	10	1RB	/	/	/	/	/	/
	836.5	10	1RB	19.87	20	1.03	0.097	0.10	/
	844	10	1RB	/	/	/	/	/	/
	836.5	10	50%RB	19.02	20	1.253	0.076	0.10	/

The data above was performed on 2024/07/15.

LTE Band 5(Ant 7):

EUT Position	Frequency (MHz)	Bandwidth (MHz)	Test Mode	Max. Meas. Power (dBm)	Max. Rated Power (dBm)	1g SAR (W/kg)			
						Scaled Factor	Meas. SAR	Scaled SAR	Plot
Head Left Cheek	829	10	1RB	/	/	/	/	/	/
	836.5	10	1RB	19.87	20	1.03	0.232	0.24	/
	844	10	1RB	/	/	/	/	/	/
	836.5	10	50%RB	19.02	20	1.253	0.196	0.25	/
Head Left Tilt	829	10	1RB	/	/	/	/	/	/
	836.5	10	1RB	19.87	20	1.03	0.227	0.23	/
	844	10	1RB	/	/	/	/	/	/
	836.5	10	50%RB	19.02	20	1.253	0.184	0.23	/
Head Right Cheek	829	10	1RB	/	/	/	/	/	/
	836.5	10	1RB	19.87	20	1.03	0.311	0.32	/
	844	10	1RB	/	/	/	/	/	/
	836.5	10	50%RB	19.02	20	1.253	0.253	0.32	/
Head Right Tilt	829	10	1RB	/	/	/	/	/	/
	836.5	10	1RB	19.87	20	1.03	0.315	0.32	25#
	844	10	1RB	/	/	/	/	/	/
	836.5	10	50%RB	19.02	20	1.253	0.25	0.31	/
Body Front (10mm)	829	10	1RB	/	/	/	/	/	/
	836.5	10	1RB	19.87	20	1.03	0.054	0.06	/
	844	10	1RB	/	/	/	/	/	/
	836.5	10	50%RB	19.02	20	1.253	0.044	0.06	/
Body Back (10mm)	829	10	1RB	/	/	/	/	/	/
	836.5	10	1RB	19.87	20	1.03	0.089	0.09	26#
	844	10	1RB	/	/	/	/	/	/
	836.5	10	50%RB	19.02	20	1.253	0.074	0.09	/
Body Left (10mm)	829	10	1RB	/	/	/	/	/	/
	836.5	10	1RB	19.87	20	1.03	0.023	0.02	/
	844	10	1RB	/	/	/	/	/	/
	836.5	10	50%RB	19.02	20	1.253	0.021	0.03	/
Body Top (10mm)	829	10	1RB	/	/	/	/	/	/
	836.5	10	1RB	19.87	20	1.03	0.068	0.07	/
	844	10	1RB	/	/	/	/	/	/
	836.5	10	50%RB	19.02	20	1.253	0.057	0.07	/

The data above was performed on 2024/07/15.

LTE Band 7(Ant 3):

EUT Position	Frequency (MHz)	Bandwidth (MHz)	Test Mode	Max. Meas. Power (dBm)	Max. Rated Power (dBm)	1g SAR (W/kg)			
						Scaled Factor	Meas. SAR	Scaled SAR	Plot
Head Left Cheek	2510	20	1RB	/	/	/	/	/	/
	2535	20	1RB	15.66	16.2	1.132	< 0.01	0.01	/
	2560	20	1RB	/	/	/	/	/	/
	2535	20	50%RB	15.24	16.2	1.247	< 0.01	0.01	/
Head Left Tilt	2510	20	1RB	/	/	/	/	/	/
	2535	20	1RB	15.66	16.2	1.132	< 0.01	0.01	/
	2560	20	1RB	/	/	/	/	/	/
	2535	20	50%RB	15.24	16.2	1.247	< 0.01	0.01	/
Head Right Cheek	2510	20	1RB	/	/	/	/	/	/
	2535	20	1RB	15.66	16.2	1.132	< 0.01	0.01	/
	2560	20	1RB	/	/	/	/	/	/
	2535	20	50%RB	15.24	16.2	1.247	< 0.01	0.01	/
Head Right Tilt	2510	20	1RB	/	/	/	/	/	/
	2535	20	1RB	15.66	16.2	1.132	< 0.01	0.01	/
	2560	20	1RB	/	/	/	/	/	/
	2535	20	50%RB	15.24	16.2	1.247	< 0.01	0.01	/
Body Front (10mm)	2510	20	1RB	/	/	/	/	/	/
	2535	20	1RB	15.66	16.2	1.132	0.11	0.12	/
	2560	20	1RB	/	/	/	/	/	/
	2535	20	50%RB	15.24	16.2	1.247	0.109	0.14	/
Body Back (10mm)	2510	20	1RB	/	/	/	/	/	/
	2535	20	1RB	15.66	16.2	1.132	0.516	0.58	/
	2560	20	1RB	/	/	/	/	/	/
	2535	20	50%RB	15.24	16.2	1.247	0.518	0.65	27#
Body Left (10mm)	2510	20	1RB	/	/	/	/	/	/
	2535	20	1RB	15.66	16.2	1.132	0.041	0.05	/
	2560	20	1RB	/	/	/	/	/	/
	2535	20	50%RB	15.24	16.2	1.247	0.039	0.05	/
Body Right (10mm)	2510	20	1RB	/	/	/	/	/	/
	2535	20	1RB	15.66	16.2	1.132	< 0.01	0.01	/
	2560	20	1RB	/	/	/	/	/	/
	2535	20	50%RB	15.24	16.2	1.247	< 0.01	0.01	/
Body Bottom (10mm)	2510	20	1RB	/	/	/	/	/	/
	2535	20	1RB	15.66	16.2	1.132	0.358	0.41	/
	2560	20	1RB	/	/	/	/	/	/
	2535	20	50%RB	15.24	16.2	1.247	0.35	0.44	/

The data above was performed on 2024/07/12.

LTE Band 7(Ant 5):

EUT Position	Frequency (MHz)	Bandwidth (MHz)	Test Mode	Max. Meas. Power (dBm)	Max. Rated Power (dBm)	1g SAR (W/kg)			
						Scaled Factor	Meas. SAR	Scaled SAR	Plot
Head Left Cheek	2510	20	1RB	/	/	/	/	/	/
	2535	20	1RB	15.66	16.2	1.132	0.139	0.16	28#
	2560	20	1RB	/	/	/	/	/	/
	2535	20	50%RB	15.24	16.2	1.247	0.11	0.14	/
Head Left Tilt	2510	20	1RB	/	/	/	/	/	/
	2535	20	1RB	15.66	16.2	1.132	< 0.01	0.01	/
	2560	20	1RB	/	/	/	/	/	/
	2535	20	50%RB	15.24	16.2	1.247	< 0.01	0.01	/
Head Right Cheek	2510	20	1RB	/	/	/	/	/	/
	2535	20	1RB	15.66	16.2	1.132	0.066	0.07	/
	2560	20	1RB	/	/	/	/	/	/
	2535	20	50%RB	15.24	16.2	1.247	0.062	0.08	/
Head Right Tilt	2510	20	1RB	/	/	/	/	/	/
	2535	20	1RB	15.66	16.2	1.132	< 0.01	0.01	/
	2560	20	1RB	/	/	/	/	/	/
	2535	20	50%RB	15.24	16.2	1.247	< 0.01	0.01	/
Body Front (10mm)	2510	20	1RB	/	/	/	/	/	/
	2535	20	1RB	15.66	16.2	1.132	0.021	0.02	/
	2560	20	1RB	/	/	/	/	/	/
	2535	20	50%RB	15.24	16.2	1.247	0.016	0.02	/
Body Back (10mm)	2510	20	1RB	/	/	/	/	/	/
	2535	20	1RB	15.66	16.2	1.132	0.098	0.11	29#
	2560	20	1RB	/	/	/	/	/	/
	2535	20	50%RB	15.24	16.2	1.247	0.081	0.10	/
Body Left (10mm)	2510	20	1RB	/	/	/	/	/	/
	2535	20	1RB	15.66	16.2	1.132	0.081	0.09	/
	2560	20	1RB	/	/	/	/	/	/
	2535	20	50%RB	15.24	16.2	1.247	0.069	0.09	/

The data above was performed on 2024/07/12.

LTE Band 7(Ant 7):

EUT Position	Frequency (MHz)	Bandwidth (MHz)	Test Mode	Max. Meas. Power (dBm)	Max. Rated Power (dBm)	1g SAR (W/kg)			
						Scaled Factor	Meas. SAR	Scaled SAR	Plot
Head Left Cheek	2510	20	1RB	/	/	/	/	/	/
	2535	20	1RB	15.66	16.2	1.132	0.137	0.16	/
	2560	20	1RB	/	/	/	/	/	/
	2535	20	50%RB	15.24	16.2	1.247	0.129	0.16	/
Head Left Tilt	2510	20	1RB	/	/	/	/	/	/
	2535	20	1RB	15.66	16.2	1.132	0.161	0.18	/
	2560	20	1RB	/	/	/	/	/	/
	2535	20	50%RB	15.24	16.2	1.247	0.138	0.17	/
Head Right Cheek	2510	20	1RB	/	/	/	/	/	/
	2535	20	1RB	15.66	16.2	1.132	0.369	0.42	30#
	2560	20	1RB	/	/	/	/	/	/
	2535	20	50%RB	15.24	16.2	1.247	0.293	0.37	/
Head Right Tilt	2510	20	1RB	/	/	/	/	/	/
	2535	20	1RB	15.66	16.2	1.132	0.25	0.28	/
	2560	20	1RB	/	/	/	/	/	/
	2535	20	50%RB	15.24	16.2	1.247	0.204	0.25	/
Body Front (10mm)	2510	20	1RB	/	/	/	/	/	/
	2535	20	1RB	15.66	16.2	1.132	0.186	0.21	/
	2560	20	1RB	/	/	/	/	/	/
	2535	20	50%RB	15.24	16.2	1.247	0.155	0.19	/
Body Back (10mm)	2510	20	1RB	/	/	/	/	/	/
	2535	20	1RB	15.66	16.2	1.132	0.169	0.19	/
	2560	20	1RB	/	/	/	/	/	/
	2535	20	50%RB	15.24	16.2	1.247	0.134	0.17	/
Body Left (10mm)	2510	20	1RB	/	/	/	/	/	/
	2535	20	1RB	15.66	16.2	1.132	0.103	0.12	/
	2560	20	1RB	/	/	/	/	/	/
	2535	20	50%RB	15.24	16.2	1.247	0.045	0.06	/
Body Top (10mm)	2510	20	1RB	/	/	/	/	/	/
	2535	20	1RB	15.66	16.2	1.132	0.218	0.25	31#
	2560	20	1RB	/	/	/	/	/	/
	2535	20	50%RB	15.24	16.2	1.247	0.175	0.22	/

The data above was performed on 2024/07/13.

LTE Band 12&17(Ant 3):

EUT Position	Frequency (MHz)	Bandwidth (MHz)	Test Mode	Max. Meas. Power (dBm)	Max. Rated Power (dBm)	1g SAR (W/kg)			
						Scaled Factor	Meas. SAR	Scaled SAR	Plot
Head Left Cheek	704	10	1RB	/	/	/	/	/	/
	707.5	10	1RB	25.12	25.3	1.042	0.023	0.02	32#
	711	10	1RB	/	/	/	/	/	/
	707.5	10	50%RB	24.45	25.3	1.216	0.019	0.02	/
Head Left Tilt	704	10	1RB	/	/	/	/	/	/
	707.5	10	1RB	25.12	25.3	1.042	0.015	0.02	/
	711	10	1RB	/	/	/	/	/	/
	707.5	10	50%RB	24.45	25.3	1.216	0.013	0.02	/
Head Right Cheek	704	10	1RB	/	/	/	/	/	/
	707.5	10	1RB	25.12	25.3	1.042	0.023	0.02	/
	711	10	1RB	/	/	/	/	/	/
	707.5	10	50%RB	24.45	25.3	1.216	0.018	0.02	/
Head Right Tilt	704	10	1RB	/	/	/	/	/	/
	707.5	10	1RB	25.12	25.3	1.042	< 0.01	0.01	/
	711	10	1RB	/	/	/	/	/	/
	707.5	10	50%RB	24.45	25.3	1.216	< 0.01	0.01	/
Body Front (10mm)	704	10	1RB	/	/	/	/	/	/
	707.5	10	1RB	25.12	25.3	1.042	0.038	0.04	/
	711	10	1RB	/	/	/	/	/	/
	707.5	10	50%RB	24.45	25.3	1.216	0.031	0.04	/
Body Back (10mm)	704	10	1RB	/	/	/	/	/	/
	707.5	10	1RB	25.12	25.3	1.042	0.049	0.05	/
	711	10	1RB	/	/	/	/	/	/
	707.5	10	50%RB	24.45	25.3	1.216	0.039	0.05	/
Body Left (10mm)	704	10	1RB	/	/	/	/	/	/
	707.5	10	1RB	25.12	25.3	1.042	< 0.01	0.01	/
	711	10	1RB	/	/	/	/	/	/
	707.5	10	50%RB	24.45	25.3	1.216	< 0.01	0.01	/
Body Right (10mm)	704	10	1RB	/	/	/	/	/	/
	707.5	10	1RB	25.12	25.3	1.042	0.061	0.06	33#
	711	10	1RB	/	/	/	/	/	/
	707.5	10	50%RB	24.45	25.3	1.216	0.05	0.06	/
Body Bottom (10mm)	704	10	1RB	/	/	/	/	/	/
	707.5	10	1RB	25.12	25.3	1.042	0.027	0.03	/
	711	10	1RB	/	/	/	/	/	/
	707.5	10	50%RB	24.45	25.3	1.216	0.023	0.03	/

The data above was performed on 2024/07/16.

Note: The E-UTRA Operating Band 17 is a subset of band 12, and they are same in modulation type and rated output power, therefore, they were considered as one frequency band during SAR measurement.

LTE Band 12&17(Ant 7):

EUT Position	Frequency (MHz)	Bandwidth (MHz)	Test Mode	Max. Meas. Power (dBm)	Max. Rated Power (dBm)	1g SAR (W/kg)			
						Scaled Factor	Meas. SAR	Scaled SAR	Plot
Head Left Cheek	704	10	1RB	/	/	/	/	/	/
	707.5	10	1RB	25.12	25.3	1.042	0.208	0.22	/
	711	10	1RB	/	/	/	/	/	/
	707.5	10	50%RB	24.45	25.3	1.216	0.171	0.21	/
Head Left Tilt	704	10	1RB	/	/	/	/	/	/
	707.5	10	1RB	25.12	25.3	1.042	0.212	0.22	/
	711	10	1RB	/	/	/	/	/	/
	707.5	10	50%RB	24.45	25.3	1.216	0.168	0.20	/
Head Right Cheek	704	10	1RB	/	/	/	/	/	/
	707.5	10	1RB	25.12	25.3	1.042	0.306	0.32	/
	711	10	1RB	/	/	/	/	/	/
	707.5	10	50%RB	24.45	25.3	1.216	0.259	0.31	/
Head Right Tilt	704	10	1RB	/	/	/	/	/	/
	707.5	10	1RB	25.12	25.3	1.042	0.329	0.34	34#
	711	10	1RB	/	/	/	/	/	/
	707.5	10	50%RB	24.45	25.3	1.216	0.274	0.33	/
Body Front (10mm)	704	10	1RB	/	/	/	/	/	/
	707.5	10	1RB	25.12	25.3	1.042	0.048	0.05	/
	711	10	1RB	/	/	/	/	/	/
	707.5	10	50%RB	24.45	25.3	1.216	0.039	0.05	/
Body Back (10mm)	704	10	1RB	/	/	/	/	/	/
	707.5	10	1RB	25.12	25.3	1.042	0.093	0.10	35#
	711	10	1RB	/	/	/	/	/	/
	707.5	10	50%RB	24.45	25.3	1.216	0.077	0.09	/
Body Left (10mm)	704	10	1RB	/	/	/	/	/	/
	707.5	10	1RB	25.12	25.3	1.042	0.053	0.06	/
	711	10	1RB	/	/	/	/	/	/
	707.5	10	50%RB	24.45	25.3	1.216	0.052	0.06	/
Body Top (10mm)	704	10	1RB	/	/	/	/	/	/
	707.5	10	1RB	25.12	25.3	1.042	0.046	0.05	/
	711	10	1RB	/	/	/	/	/	/
	707.5	10	50%RB	24.45	25.3	1.216	0.034	0.04	/

The data above was performed on 2024/07/16.

Note: The E-UTRA Operating Band 17 is a subset of band 12, and they are same in modulation type and rated output power, therefore, they were considered as one frequency band during SAR measurement.

LTE Band 13(Ant 3):

EUT Position	Frequency (MHz)	Bandwidth (MHz)	Test Mode	Max. Meas. Power (dBm)	Max. Rated Power (dBm)	1g SAR (W/kg)			
						Scaled Factor	Meas. SAR	Scaled SAR	Plot
Head Left Cheek	782	10	1RB	23.78	23.9	1.028	0.045	0.05	36#
	782	10	50%RB	22.98	23.9	1.236	0.033	0.04	/
Head Left Tilt	782	10	1RB	23.78	23.9	1.028	0.023	0.02	/
	782	10	50%RB	22.98	23.9	1.236	0.018	0.02	/
Head Right Cheek	782	10	1RB	23.78	23.9	1.028	0.043	0.04	/
	782	10	50%RB	22.98	23.9	1.236	0.033	0.04	/
Head Right Tilt	782	10	1RB	23.78	23.9	1.028	0.011	0.01	/
	782	10	50%RB	22.98	23.9	1.236	< 0.01	0.01	/
Body Front (10mm)	782	10	1RB	23.78	23.9	1.028	0.078	0.08	/
	782	10	50%RB	22.98	23.9	1.236	0.061	0.08	/
Body Back (10mm)	782	10	1RB	23.78	23.9	1.028	0.102	0.10	37#
	782	10	50%RB	22.98	23.9	1.236	0.081	0.10	/
Body Left (10mm)	782	10	1RB	23.78	23.9	1.028	< 0.01	0.01	/
	782	10	50%RB	22.98	23.9	1.236	< 0.01	0.01	/
Body Right (10mm)	782	10	1RB	23.78	23.9	1.028	0.08	0.08	/
	782	10	50%RB	22.98	23.9	1.236	0.063	0.08	/
Body Bottom (10mm)	782	10	1RB	23.78	23.9	1.028	0.056	0.06	/
	782	10	50%RB	22.98	23.9	1.236	0.044	0.05	/

The data above was performed on 2024/07/17.

LTE Band 13(Ant 7):

EUT Position	Frequency (MHz)	Bandwidth (MHz)	Test Mode	Max. Meas. Power (dBm)	Max. Rated Power (dBm)	1g SAR (W/kg)			
						Scaled Factor	Meas. SAR	Scaled SAR	Plot
Head Left Cheek	782	10	1RB	23.78	23.9	1.028	0.276	0.28	/
	782	10	50%RB	22.98	23.9	1.236	0.217	0.27	/
Head Left Tilt	782	10	1RB	23.78	23.9	1.028	0.277	0.28	/
	782	10	50%RB	22.98	23.9	1.236	0.217	0.27	/
Head Right Cheek	782	10	1RB	23.78	23.9	1.028	0.364	0.37	/
	782	10	50%RB	22.98	23.9	1.236	0.296	0.37	/
Head Right Tilt	782	10	1RB	23.78	23.9	1.028	0.403	0.41	38#
	782	10	50%RB	22.98	23.9	1.236	0.318	0.39	/
Body Front (10mm)	782	10	1RB	23.78	23.9	1.028	0.065	0.07	/
	782	10	50%RB	22.98	23.9	1.236	0.053	0.07	/
Body Back (10mm)	782	10	1RB	23.78	23.9	1.028	0.125	0.13	39#
	782	10	50%RB	22.98	23.9	1.236	0.097	0.12	/
Body Left (10mm)	782	10	1RB	23.78	23.9	1.028	0.047	0.05	/
	782	10	50%RB	22.98	23.9	1.236	0.036	0.04	/
Body Top (10mm)	782	10	1RB	23.78	23.9	1.028	0.062	0.06	/
	782	10	50%RB	22.98	23.9	1.236	0.053	0.07	/

The data above was performed on 2024/07/17.

LTE Band 41(Ant3):

EUT Position	Frequency (MHz)	Bandwidth (MHz)	Test Mode	Max. Meas. Power (dBm)	Max. Rated Power (dBm)	1g SAR (W/kg)			
						Scaled Factor	Meas. SAR	Scaled SAR	Plot
Head Left Cheek	2506	20	1RB	/	/	/	/	/	/
	2549.5	20	1RB	/	/	/	/	/	/
	2593	20	1RB	18.13	18.4	1.064	< 0.01	0.01	/
	2636.5	20	1RB	/	/	/	/	/	/
	2680	20	1RB	/	/	/	/	/	/
	2593	20	50%RB	17.95	18.4	1.109	< 0.01	0.01	/
Head Left Tilt	2506	20	1RB	/	/	/	/	/	/
	2549.5	20	1RB	/	/	/	/	/	/
	2593	20	1RB	18.13	18.4	1.064	< 0.01	0.01	/
	2636.5	20	1RB	/	/	/	/	/	/
	2680	20	1RB	/	/	/	/	/	/
	2593	20	50%RB	17.95	18.4	1.109	< 0.01	0.01	/
Head Right Cheek	2506	20	1RB	/	/	/	/	/	/
	2549.5	20	1RB	/	/	/	/	/	/
	2593	20	1RB	18.13	18.4	1.064	< 0.01	0.01	/
	2636.5	20	1RB	/	/	/	/	/	/
	2680	20	1RB	/	/	/	/	/	/
	2593	20	50%RB	17.95	18.4	1.109	< 0.01	0.01	/
Head Right Tilt	2506	20	1RB	/	/	/	/	/	/
	2549.5	20	1RB	/	/	/	/	/	/
	2593	20	1RB	18.13	18.4	1.064	< 0.01	0.01	/
	2636.5	20	1RB	/	/	/	/	/	/
	2680	20	1RB	/	/	/	/	/	/
	2593	20	50%RB	17.95	18.4	1.109	< 0.01	0.01	/
Body Front (10mm)	2506	20	1RB	/	/	/	/	/	/
	2549.5	20	1RB	/	/	/	/	/	/
	2593	20	1RB	18.13	18.4	1.064	0.044	0.05	/
	2636.5	20	1RB	/	/	/	/	/	/
	2680	20	1RB	/	/	/	/	/	/
	2593	20	50%RB	17.95	18.4	1.109	0.039	0.04	/
Body Back (10mm)	2506	20	1RB	/	/	/	/	/	/
	2549.5	20	1RB	/	/	/	/	/	/
	2593	20	1RB	18.13	18.4	1.064	0.178	0.19	40#
	2636.5	20	1RB	/	/	/	/	/	/
	2680	20	1RB	/	/	/	/	/	/
	2593	20	50%RB	17.95	18.4	1.109	0.16	0.18	/

Body Left (10mm)	2506	20	1RB	/	/	/	/	/	/
	2549.5	20	1RB	/	/	/	/	/	/
	2593	20	1RB	18.13	18.4	1.064	< 0.01	0.01	/
	2636.5	20	1RB	/	/	/	/	/	/
	2680	20	1RB	/	/	/	/	/	/
	2593	20	50%RB	17.95	18.4	1.109	< 0.01	0.01	/
Body Right (10mm)	2506	20	1RB	/	/	/	/	/	/
	2549.5	20	1RB	/	/	/	/	/	/
	2593	20	1RB	18.13	18.4	1.064	< 0.01	0.01	/
	2636.5	20	1RB	/	/	/	/	/	/
	2680	20	1RB	/	/	/	/	/	/
	2593	20	50%RB	17.95	18.4	1.109	< 0.01	0.01	/
Body Bottom (10mm)	2506	20	1RB	/	/	/	/	/	/
	2549.5	20	1RB	/	/	/	/	/	/
	2593	20	1RB	18.13	18.4	1.064	0.103	0.11	/
	2636.5	20	1RB	/	/	/	/	/	/
	2680	20	1RB	/	/	/	/	/	/
	2593	20	50%RB	17.95	18.4	1.109	0.084	0.09	/

The data above was performed on 2024/07/13.

Note: 1. The frequency range of LTE Band 41 is 2496~ 2690MHz. Per KDB 447498 D01, according to the following formula calculate N_c is 5.

KDB procedures, the following should be applied to determine the number of required test channels. The test channels should be evenly spread across the transmission frequency band of each wireless mode.¹⁴

$$N_c = \text{Round} \left\{ \left[100 \left(\frac{f_{\text{high}} - f_{\text{low}}}{f_c} \right) \right]^{0.5} \times (f_c / 100)^{0.2} \right\},$$

where

- N_c is the number of test channels, rounded to the nearest integer,
- f_{high} and f_{low} are the highest and lowest channel frequencies within the transmission band,
- f_c is the mid-band channel frequency,
- all frequencies are in MHz.

2. The power class 3 used for LTE Band 41 SAR testing.

LTE Band 41(Ant5):

EUT Position	Frequency (MHz)	Bandwidth (MHz)	Test Mode	Max. Meas. Power (dBm)	Max. Rated Power (dBm)	1g SAR (W/kg)			
						Scaled Factor	Meas. SAR	Scaled SAR	Plot
Head Left Cheek	2506	20	1RB	/	/	/	/	/	/
	2549.5	20	1RB	/	/	/	/	/	/
	2593	20	1RB	18.13	18.4	1.064	0.025	0.03	/
	2636.5	20	1RB	/	/	/	/	/	/
	2680	20	1RB	/	/	/	/	/	/
	2593	20	50%RB	17.95	18.4	1.109	0.021	0.02	/
Head Left Tilt	2506	20	1RB	/	/	/	/	/	/
	2549.5	20	1RB	/	/	/	/	/	/
	2593	20	1RB	18.13	18.4	1.064	< 0.01	0.01	/
	2636.5	20	1RB	/	/	/	/	/	/
	2680	20	1RB	/	/	/	/	/	/
	2593	20	50%RB	17.95	18.4	1.109	< 0.01	0.01	/
Head Right Cheek	2506	20	1RB	/	/	/	/	/	/
	2549.5	20	1RB	/	/	/	/	/	/
	2593	20	1RB	18.13	18.4	1.064	0.059	0.06	41#
	2636.5	20	1RB	/	/	/	/	/	/
	2680	20	1RB	/	/	/	/	/	/
	2593	20	50%RB	17.95	18.4	1.109	0.048	0.05	/
Head Right Tilt	2506	20	1RB	/	/	/	/	/	/
	2549.5	20	1RB	/	/	/	/	/	/
	2593	20	1RB	18.13	18.4	1.064	< 0.01	0.01	/
	2636.5	20	1RB	/	/	/	/	/	/
	2680	20	1RB	/	/	/	/	/	/
	2593	20	50%RB	17.95	18.4	1.109	< 0.01	0.01	/
Body Front (10mm)	2506	20	1RB	/	/	/	/	/	/
	2549.5	20	1RB	/	/	/	/	/	/
	2593	20	1RB	18.13	18.4	1.064	0.021	0.02	/
	2636.5	20	1RB	/	/	/	/	/	/
	2680	20	1RB	/	/	/	/	/	/
	2593	20	50%RB	17.95	18.4	1.109	0.016	0.02	/
Body Back (10mm)	2506	20	1RB	/	/	/	/	/	/
	2549.5	20	1RB	/	/	/	/	/	/
	2593	20	1RB	18.13	18.4	1.064	0.067	0.07	42#
	2636.5	20	1RB	/	/	/	/	/	/
	2680	20	1RB	/	/	/	/	/	/
	2593	20	50%RB	17.95	18.4	1.109	0.057	0.06	/

Body Left (10mm)	2506	20	1RB	/	/	/	/	/	/
	2549.5	20	1RB	/	/	/	/	/	/
	2593	20	1RB	18.13	18.4	1.064	0.027	0.03	/
	2636.5	20	1RB	/	/	/	/	/	/
	2680	20	1RB	/	/	/	/	/	/
	2593	20	50%RB	17.95	18.4	1.109	0.024	0.03	/

The data above was performed on 2024/07/14.

Note: 1. The frequency range of LTE Band 41 is 2496~ 2690MHz. Per KDB 447498 D01, according to the following formula calculate N_c is 5.

KDB procedures, the following should be applied to determine the number of required test channels. The test channels should be evenly spread across the transmission frequency band of each wireless mode.¹⁴

$$N_c = \text{Round} \left\{ \left[100 \left(\frac{f_{\text{high}} - f_{\text{low}}}{f_c} \right) \right]^{0.5} \times (f_c / 100)^{0.2} \right\},$$

where

- N_c is the number of test channels, rounded to the nearest integer.
- f_{high} and f_{low} are the highest and lowest channel frequencies within the transmission band,
- f_c is the mid-band channel frequency,
- all frequencies are in MHz.

2. The power class 3 used for LTE Band 41 SAR testing.

LTE Band 41(Ant7):

EUT Position	Frequency (MHz)	Bandwidth (MHz)	Test Mode	Max. Meas. Power (dBm)	Max. Rated Power (dBm)	1g SAR (W/kg)			
						Scaled Factor	Meas. SAR	Scaled SAR	Plot
Head Left Cheek	2506	20	1RB	/	/	/	/	/	/
	2549.5	20	1RB	/	/	/	/	/	/
	2593	20	1RB	18.13	18.4	1.064	0.531	0.56	43#
	2636.5	20	1RB	/	/	/	/	/	/
	2680	20	1RB	/	/	/	/	/	/
	2593	20	50%RB	17.95	18.4	1.109	0.505	0.56	/
Head Left Tilt	2506	20	1RB	/	/	/	/	/	/
	2549.5	20	1RB	/	/	/	/	/	/
	2593	20	1RB	18.13	18.4	1.064	0.175	0.19	/
	2636.5	20	1RB	/	/	/	/	/	/
	2680	20	1RB	/	/	/	/	/	/
	2593	20	50%RB	17.95	18.4	1.109	0.144	0.16	/
Head Right Cheek	2506	20	1RB	/	/	/	/	/	/
	2549.5	20	1RB	/	/	/	/	/	/
	2593	20	1RB	18.13	18.4	1.064	0.341	0.36	/
	2636.5	20	1RB	/	/	/	/	/	/
	2680	20	1RB	/	/	/	/	/	/
	2593	20	50%RB	17.95	18.4	1.109	0.282	0.31	/
Head Right Tilt	2506	20	1RB	/	/	/	/	/	/
	2549.5	20	1RB	/	/	/	/	/	/
	2593	20	1RB	18.13	18.4	1.064	0.438	0.47	/
	2636.5	20	1RB	/	/	/	/	/	/
	2680	20	1RB	/	/	/	/	/	/
	2593	20	50%RB	17.95	18.4	1.109	0.363	0.40	/
Body Front (10mm)	2506	20	1RB	/	/	/	/	/	/
	2549.5	20	1RB	/	/	/	/	/	/
	2593	20	1RB	18.13	18.4	1.064	0.126	0.13	/
	2636.5	20	1RB	/	/	/	/	/	/
	2680	20	1RB	/	/	/	/	/	/
	2593	20	50%RB	17.95	18.4	1.109	0.105	0.12	/
Body Back (10mm)	2506	20	1RB	/	/	/	/	/	/
	2549.5	20	1RB	/	/	/	/	/	/
	2593	20	1RB	18.13	18.4	1.064	0.338	0.36	44#
	2636.5	20	1RB	/	/	/	/	/	/
	2680	20	1RB	/	/	/	/	/	/
	2593	20	50%RB	17.95	18.4	1.109	0.279	0.31	/

Body Left (10mm)	2506	20	1RB	/	/	/	/	/	/
	2549.5	20	1RB	/	/	/	/	/	/
	2593	20	1RB	18.13	18.4	1.064	0.096	0.10	/
	2636.5	20	1RB	/	/	/	/	/	/
	2680	20	1RB	/	/	/	/	/	/
	2593	20	50%RB	17.95	18.4	1.109	0.08	0.09	/
Body Top (10mm)	2506	20	1RB	/	/	/	/	/	/
	2549.5	20	1RB	/	/	/	/	/	/
	2593	20	1RB	18.13	18.4	1.064	0.244	0.26	/
	2636.5	20	1RB	/	/	/	/	/	/
	2680	20	1RB	/	/	/	/	/	/
	2593	20	50%RB	17.95	18.4	1.109	0.296	0.33	/

The data above was performed on 2024/07/14.

Note: 1.The frequency range of LTE Band 41 is 2496~ 2690MHz. Per KDB 447498 D01, according to the following formulacalculate N_c is 5.

KDB procedures, the following should be applied to determine the number of required test channels. The test channels should be evenly spread across the transmission frequency band of each wireless mode.¹⁴

$$N_c = \text{Round} \left\{ \left[100(f_{\text{high}} - f_{\text{low}}) / f_c \right]^{0.5} \times (f_c / 100)^{0.2} \right\},$$

where

- N_c is the number of test channels, rounded to the nearest integer,
- f_{high} and f_{low} are the highest and lowest channel frequencies within the transmission band,
- f_c is the mid-band channel frequency,
- all frequencies are in MHz.

2. The power class 3 used for LTE Band 41 SAR testing.

LTE Band 66&4 (Ant 3):

EUT Position	Frequency (MHz)	Bandwidth (MHz)	Test Mode	Max. Meas. Power (dBm)	Max. Rated Power (dBm)	1g SAR (W/kg)			
						Scaled Factor	Meas. SAR	Scaled SAR	Plot
Head Left Cheek	1720	20	1RB	/	/	/	/	/	/
	1745	20	1RB	16.45	17	1.135	< 0.01	0.01	/
	1770	20	1RB	/	/	/	/	/	/
	1745	20	50%RB	15.59	17	1.384	< 0.01	0.01	/
Head Left Tilt	1720	20	1RB	/	/	/	/	/	/
	1745	20	1RB	16.45	17	1.135	< 0.01	0.01	/
	1770	20	1RB	/	/	/	/	/	/
	1745	20	50%RB	15.59	17	1.384	< 0.01	0.01	/
Head Right Cheek	1720	20	1RB	/	/	/	/	/	/
	1745	20	1RB	16.45	17	1.135	< 0.01	0.01	/
	1770	20	1RB	/	/	/	/	/	/
	1745	20	50%RB	15.59	17	1.384	< 0.01	0.01	/
Head Right Tilt	1720	20	1RB	/	/	/	/	/	/
	1745	20	1RB	16.45	17	1.135	0.011	0.01	45#
	1770	20	1RB	/	/	/	/	/	/
	1745	20	50%RB	15.59	17	1.384	< 0.01	0.01	/
Body Front (10mm)	1720	20	1RB	/	/	/	/	/	/
	1745	20	1RB	16.45	17	1.135	0.201	0.23	/
	1770	20	1RB	/	/	/	/	/	/
	1745	20	50%RB	15.59	17	1.384	0.153	0.21	/
Body Back (10mm)	1720	20	1RB	/	/	/	/	/	/
	1745	20	1RB	16.45	17	1.135	0.318	0.36	/
	1770	20	1RB	/	/	/	/	/	/
	1745	20	50%RB	15.59	17	1.384	0.232	0.32	/
Body Left (10mm)	1720	20	1RB	/	/	/	/	/	/
	1745	20	1RB	16.45	17	1.135	< 0.01	0.01	/
	1770	20	1RB	/	/	/	/	/	/
	1745	20	50%RB	15.59	17	1.384	< 0.01	0.01	/
Body Right (10mm)	1720	20	1RB	/	/	/	/	/	/
	1745	20	1RB	16.45	17	1.135	0.063	0.07	/
	1770	20	1RB	/	/	/	/	/	/
	1745	20	50%RB	15.59	17	1.384	0.046	0.06	/
Body Bottom (10mm)	1720	20	1RB	/	/	/	/	/	/
	1745	20	1RB	16.45	17	1.135	0.321	0.36	46#
	1770	20	1RB	/	/	/	/	/	/
	1745	20	50%RB	15.59	17	1.384	0.262	0.36	/

The data above was performed on 2024/07/19.

Note: The E-UTRA Operating Band 4 is a subset of band 66, and they are same in modulation type and rated output power, therefore, they were considered as one frequency band during SAR measurement.

LTE Band 66&4 (Ant 5):

EUT Position	Frequency (MHz)	Bandwidth (MHz)	Test Mode	Max. Meas. Power (dBm)	Max. Rated Power (dBm)	1g SAR (W/kg)			
						Scaled Factor	Meas. SAR	Scaled SAR	Plot
Head Left Cheek	1720	20	1RB	/	/	/	/	/	/
	1745	20	1RB	16.45	17	1.135	0.041	0.05	/
	1770	20	1RB	/	/	/	/	/	/
	1745	20	50%RB	15.59	17	1.384	0.033	0.05	/
Head Left Tilt	1720	20	1RB	/	/	/	/	/	/
	1745	20	1RB	16.45	17	1.135	0.071	0.08	/
	1770	20	1RB	/	/	/	/	/	/
	1745	20	50%RB	15.59	17	1.384	0.058	0.08	/
Head Right Cheek	1720	20	1RB	/	/	/	/	/	/
	1745	20	1RB	16.45	17	1.135	0.05	0.06	/
	1770	20	1RB	/	/	/	/	/	/
	1745	20	50%RB	15.59	17	1.384	0.044	0.06	/
Head Right Tilt	1720	20	1RB	/	/	/	/	/	/
	1745	20	1RB	16.45	17	1.135	0.084	0.10	47#
	1770	20	1RB	/	/	/	/	/	/
	1745	20	50%RB	15.59	17	1.384	0.064	0.09	/
Body Front (10mm)	1720	20	1RB	/	/	/	/	/	/
	1745	20	1RB	16.45	17	1.135	0.037	0.04	/
	1770	20	1RB	/	/	/	/	/	/
	1745	20	50%RB	15.59	17	1.384	0.032	0.04	/
Body Back (10mm)	1720	20	1RB	/	/	/	/	/	/
	1745	20	1RB	16.45	17	1.135	0.077	0.09	48#
	1770	20	1RB	/	/	/	/	/	/
	1745	20	50%RB	15.59	17	1.384	0.06	0.08	/
Body Left (10mm)	1720	20	1RB	/	/	/	/	/	/
	1745	20	1RB	16.45	17	1.135	0.019	0.02	/
	1770	20	1RB	/	/	/	/	/	/
	1745	20	50%RB	15.59	17	1.384	0.014	0.02	/

The data above was performed on 2024/07/20.

Note: The E-UTRA Operating Band 4 is a subset of band 66, and they are same in modulation type and rated output power, therefore, they were considered as one frequency band during SAR measurement.

LTE Band 66&4 (Ant 7):

EUT Position	Frequency (MHz)	Bandwidth (MHz)	Test Mode	Max. Meas. Power (dBm)	Max. Rated Power (dBm)	1g SAR (W/kg)			
						Scaled Factor	Meas. SAR	Scaled SAR	Plot
Head Left Cheek	1720	20	1RB	/	/	/	/	/	/
	1745	20	1RB	16.45	17	1.135	0.197	0.22	/
	1770	20	1RB	/	/	/	/	/	/
	1745	20	50%RB	15.59	17	1.384	0.182	0.25	/
Head Left Tilt	1720	20	1RB	/	/	/	/	/	/
	1745	20	1RB	16.45	17	1.135	0.189	0.21	/
	1770	20	1RB	/	/	/	/	/	/
	1745	20	50%RB	15.59	17	1.384	0.186	0.26	/
Head Right Cheek	1720	20	1RB	/	/	/	/	/	/
	1745	20	1RB	16.45	17	1.135	0.311	0.35	/
	1770	20	1RB	/	/	/	/	/	/
	1745	20	50%RB	15.59	17	1.384	0.265	0.37	/
Head Right Tilt	1720	20	1RB	/	/	/	/	/	/
	1745	20	1RB	16.45	17	1.135	0.328	0.37	49#
	1770	20	1RB	/	/	/	/	/	/
	1745	20	50%RB	15.59	17	1.384	0.263	0.36	/
Body Front (10mm)	1720	20	1RB	/	/	/	/	/	/
	1745	20	1RB	16.45	17	1.135	0.066	0.07	/
	1770	20	1RB	/	/	/	/	/	/
	1745	20	50%RB	15.59	17	1.384	0.055	0.08	/
Body Back (10mm)	1720	20	1RB	/	/	/	/	/	/
	1745	20	1RB	16.45	17	1.135	0.09	0.10	/
	1770	20	1RB	/	/	/	/	/	/
	1745	20	50%RB	15.59	17	1.384	0.07	0.10	/
Body Left (10mm)	1720	20	1RB	/	/	/	/	/	/
	1745	20	1RB	16.45	17	1.135	0.022	0.02	/
	1770	20	1RB	/	/	/	/	/	/
	1745	20	50%RB	15.59	17	1.384	0.019	0.03	/
Body Top (10mm)	1720	20	1RB	/	/	/	/	/	/
	1745	20	1RB	16.45	17	1.135	0.136	0.15	50#
	1770	20	1RB	/	/	/	/	/	/
	1745	20	50%RB	15.59	17	1.384	0.108	0.15	/

The data above was performed on 2024/07/19.

Note: The E-UTRA Operating Band 4 is a subset of band 66, and they are same in modulation type and rated output power, therefore, they were considered as one frequency band during SAR measurement.

Note:

1. When the 1-g SAR is ≤ 0.8 W/Kg, testing for other channels are optional.
2. SAR for LTE band exposure configurations is measured according to the procedures of KDB 941225 D05 SAR for LTE Devices v02.
3. KDB941225D05-SAR for higher order modulation is required only when the highest maximum output power for the configuration in the higher order modulation is > 0.5 dB higher than the same configuration in QPSK or when the reported SAR for the QPSK configuration is > 1.45 W/kg
4. KDB941225D05-For QPSK with 100% RB allocation, when the reported SAR measured for the Highest output power channel is < 1.45 W/kg, tests for the remaining required test channels are optional.
5. KDB941225D05- For QPSK with 100% RB allocation, SAR is not required when the highest maximum output power for 100 % RB allocation is less than the highest maximum output power in 50% and 1 RB allocations and the highest reported SAR for 1 RB and 50% RB allocation are ≤ 0.8 W/kg.
6. KDB941225D05- Start with the largest channel bandwidth and measure SAR for QPSK with 1 RB allocation, using the RB offset and required test channel combination with the highest maximum output power among RB offset the upper edge, middle and lower edge of each required test channel.
7. KDB941225D05- other channel bandwidths SAR test is required when the highest maximum output power of a configuration requiring testing in the smaller channel bandwidth is > 0.5 dB higher than the equivalent channel configurations in the largest channel bandwidth configuration or the reported SAR of a configuration for the largest channel bandwidth is > 1.45 W/kg.
8. Worst case SAR for 50% RB allocation is selected to be tested.

WLAN 2.4G Chain 0:

EUT Position	Frequency (MHz)	Test Mode	Max. Meas. Power (dBm)	Max. Rated Power (dBm)	1g SAR (W/kg)				
					Scaled Factor	Duty cycle Factor	Meas. SAR	Scaled SAR	Plot
Head Left Cheek	2412	802.11b	/	/	/	/	/	/	/
	2437	802.11b	11.36	11.5	1.033	1	0.245	0.25	51#
	2462	802.11b	/	/	/	/	/	/	/
Head Left Tilt	2412	802.11b	/	/	/	/	/	/	/
	2437	802.11b	11.36	11.5	1.033	1	0.223	0.23	/
	2462	802.11b	/	/	/	/	/	/	/
Head RightCheek	2412	802.11b	/	/	/	/	/	/	/
	2437	802.11b	11.36	11.5	1.033	1	0.133	0.14	/
	2462	802.11b	/	/	/	/	/	/	/
Head Right Tilt	2412	802.11b	/	/	/	/	/	/	/
	2437	802.11b	11.36	11.5	1.033	1	0.107	0.11	/
	2462	802.11b	/	/	/	/	/	/	/
Body Front (10mm)	2412	802.11b	/	/	/	/	/	/	/
	2437	802.11b	11.36	11.5	1.033	1	0.056	0.06	/
	2462	802.11b	/	/	/	/	/	/	/
Body Back (10mm)	2412	802.11b	/	/	/	/	/	/	/
	2437	802.11b	11.36	11.5	1.033	1	0.104	0.11	52#
	2462	802.11b	/	/	/	/	/	/	/
Body Right (10mm)	2412	802.11b	/	/	/	/	/	/	/
	2437	802.11b	11.36	11.5	1.033	1	0.025	0.03	/
	2462	802.11b	/	/	/	/	/	/	/
Body Top (10mm)	2412	802.11b	/	/	/	/	/	/	/
	2437	802.11b	11.36	11.5	1.033	1	0.051	0.05	/
	2462	802.11b	/	/	/	/	/	/	/

The data above was performed on 2024/07/11.

Note:

1. When the 1-g SAR is $\leq 0.8\text{W/kg}$, testing for other channels are optional.
2. When SAR or MPE is not measured at the maximum power level allowed for production units, the results must be scaled to the maximum tune-up tolerance limit according to the power applied to the individual channels tested to determine compliance.
3. According 2016 Oct. TCB, for SAR testing of 2.4 WIFI 802.11b signal with non-100% duty cycle, the measured SAR is scaled-up by the duty cycle scaling factor which is equal to "1/(duty cycle)".

WLAN 2.4GChain 1:

EUT Position	Frequency (MHz)	Test Mode	Max. Meas. Power (dBm)	Max. Rated Power (dBm)	1g SAR (W/kg)				
					Scaled Factor	Duty cycle Factor	Meas. SAR	Scaled SAR	Plot
Head Left Cheek	2412	802.11b	/	/	/	/	/	/	/
	2437	802.11b	14.38	14.5	1.028	1	0.195	0.2	53#
	2462	802.11b	/	/	/	/	/	/	/
Head Left Tilt	2412	802.11b	/	/	/	/	/	/	/
	2437	802.11b	14.38	14.5	1.028	1	0.031	0.03	/
	2462	802.11b	/	/	/	/	/	/	/
Head RightCheek	2412	802.11b	/	/	/	/	/	/	/
	2437	802.11b	14.38	14.5	1.028	1	0.06	0.06	/
	2462	802.11b	/	/	/	/	/	/	/
Head Right Tilt	2412	802.11b	/	/	/	/	/	/	/
	2437	802.11b	14.38	14.5	1.028	1	0.011	0.01	/
	2462	802.11b	/	/	/	/	/	/	/
Body Front (10mm)	2412	802.11b	/	/	/	/	/	/	/
	2437	802.11b	14.38	14.5	1.028	1	0.017	0.02	/
	2462	802.11b	/	/	/	/	/	/	/
Body Back (10mm)	2412	802.11b	/	/	/	/	/	/	/
	2437	802.11b	14.38	14.5	1.028	1	0.051	0.05	/
	2462	802.11b	/	/	/	/	/	/	/
Body Right (10mm)	2412	802.11b	/	/	/	/	/	/	/
	2437	802.11b	14.38	14.5	1.028	1	0.056	0.06	54#
	2462	802.11b	/	/	/	/	/	/	/
Body Top (10mm)	2412	802.11b	/	/	/	/	/	/	/
	2437	802.11b	14.38	14.5	1.028	1	< 0.01	0.01	/
	2462	802.11b	/	/	/	/	/	/	/

The data above was performed on 2024/07/11.

Note:

1. When the 1-g SAR is $\leq 0.8\text{W/kg}$, testing for other channels are optional.
2. When SAR or MPE is not measured at the maximum power level allowed for production units, the results must be scaled to the maximum tune-up tolerance limit according to the power applied to the individual channels tested to determine compliance.
3. According 2016 Oct. TCB, for SAR testing of 2.4 WIFI 802.11b signal with non-100% duty cycle, the measured SAR is scaled-up by the duty cycle scaling factor which is equal to "1/(duty cycle)".

WLAN5.6G:

EUT Position	Frequency (MHz)	Test Mode	Max. Meas. Power (dBm)	Max. Rated Power (dBm)	1g SAR (W/kg)				
					Scaled Factor	Duty cycle Factor	Meas. SAR	Scaled SAR	Plot
Head Left Cheek	5500	802.11a	/	/	/	/	/	/	/
	5580	802.11a	7.54	8.2	1.164	1	0.284	0.33	/
	5700	802.11a	/	/	/	/	/	/	/
Head Left Tilt	5500	802.11a	/	/	/	/	/	/	/
	5580	802.11a	7.54	8.2	1.164	1	0.405	0.47	55#
	5700	802.11a	/	/	/	/	/	/	/
Head Right Cheek	5500	802.11a	/	/	/	/	/	/	/
	5580	802.11a	7.54	8.2	1.164	1	0.257	0.30	/
	5700	802.11a	/	/	/	/	/	/	/
Head Right Tilt	5500	802.11a	/	/	/	/	/	/	/
	5580	802.11a	7.54	8.2	1.164	1	0.267	0.31	/
	5700	802.11a	/	/	/	/	/	/	/
Body Front (10mm)	5500	802.11a	/	/	/	/	/	/	/
	5580	802.11a	7.54	8.2	1.164	1	0.031	0.04	/
	5700	802.11a	/	/	/	/	/	/	/
Body Back (10mm)	5500	802.11a	/	/	/	/	/	/	/
	5580	802.11a	7.54	8.2	1.164	1	0.043	0.05	/
	5700	802.11a	/	/	/	/	/	/	/
Body Right (10mm)	5500	802.11a	/	/	/	/	/	/	/
	5580	802.11a	7.54	8.2	1.164	1	0.011	0.01	/
	5700	802.11a	/	/	/	/	/	/	/
Body Top (10mm)	5500	802.11a	/	/	/	/	/	/	/
	5580	802.11a	7.54	8.2	1.164	1	0.223	0.26	56#
	5700	802.11a	/	/	/	/	/	/	/

The data above was performed on 2024/07/11.

Note:

1. When the 1-g SAR is ≤ 0.8 W/kg, testing for other channels are optional.
2. When SAR or MPE is not measured at the maximum power level allowed for production units, the results must be scaled to the maximum tune-up tolerance limit according to the power applied to the individual channels tested to determine compliance.
3. For 802.11a mode power is the largest among 802.11a/n/ax/ac, 802.11 a mode as initial test configuration is selected to test.
4. According 2016 Oct. TCB, for SAR testing of 5G WIFI 802.11a signal with non-100% duty cycle, the measured SAR is scaled-up by the duty cycle scaling factor which is equal to "1/(duty cycle)".

9. Measurement Variability

In accordance with published RF Exposure KDB procedure 865664 D01 SAR measurement 100 MHz to 6 GHz v01. These additional measurements are repeated after the completion of all measurements requiring the same head or body tissue-equivalent medium in a frequency band. The test device should be returned to ambient conditions (normal room temperature) with the battery fully charged before it is re-mounted on the device holder for the repeated measurement(s) to minimize any unexpected variations in the repeated results

- 1) Repeated measurement is not required when the original highest measured SAR is < 0.80 W/kg; steps 2) through 4) do not apply.
- 2) When the original highest measured SAR is ≥ 0.80 W/kg, repeat that measurement once.
- 3) Perform a second repeated measurement only if the ratio of largest to smallest SAR for the original and first repeated measurements is > 1.20 or when the original or repeated measurement is ≥ 1.45 W/kg (~ 10% from the 1-g SAR limit).
- 4) Perform a third repeated measurement only if the original, first or second repeated measurement is ≥ 1.5 W/kg and the ratio of largest to smallest SAR for the original, first and second repeated measurements is > 1.20 .

Note: The same procedures should be adapted for measurements according to extremity and occupational exposure limits by applying a factor of 2.5 for extremity exposure and a factor of 5 for occupational exposure to the corresponding SAR thresholds.

The Highest Measured SAR Configuration in Each Frequency Band Head

SAR probe calibration point	Frequency Band	Freq.(MHz)	EUT Position	Meas. SAR (W/kg)		Largest toSmallestSAR Ratio
				Original	Repeated	
/	/	/	/	/	/	/

Body

SAR probe calibration point	Frequency Band	Freq.(MHz)	EUT Position	Meas. SAR (W/kg)		Largest toSmallestSARRatio
				Original	Repeated	
/	/	/	/	/	/	/

Note:

1. Second Repeated Measurement is not required since the ratio of the largest to smallest SAR for the original and first repeated measurement is not > 1.20 .
2. The measured SAR results **do not** have to be scaled to the maximum tune-up tolerance to determine if repeated measurements are required.
3. SAR measurement variability must be assessed for each frequency band, which is determined by the **SAR probe calibration point and tissue-equivalent medium** used for the device measurements.

10. DUT HOLDER PERTURBATIONS

In accordance with TCB workshop October 2016:

- 1) SAR perturbation due to test device holders, depending on antenna locations, buttons locations on phones or device, form factor (e.g. dongles etc.), the measured SAR could be influenced by the relative positions of the test device and its holder
- 2) SAR measurement standards have included protocols to evaluate this with a flat phantom, with and without the device holder
- 3) When the highest reported SAR of an antenna is > 1.2 W/kg, holder perturbation verification is required for each antenna, using the highest SAR configuration among all applicable frequency bands in the same exact device and holder positions used for head and body SAR measurements; i.e. same device/button locations in the holder

Per IEEE 1528: 2013/Annex E/E.4.1.1: Device holder perturbation tolerance for a specific test device: Type B

When it is unknown if a device holder perturbs the fields of a test device, the SAR uncertainty shall be assessed with a flat phantom (see Clause 5) by comparing the SAR with and without the device holder according to the following tests:

The SAR tolerance for device holder disturbance is computed using Equation (E.21) and entered in the corresponding row of the appropriate uncertainty table with an assumed rectangular probability distribution and $\nu_i = \infty$ degrees of freedom:

$$SAR_{\text{tolerance}}[\%] = 100 \times \left(\frac{SAR_{\text{w/holder}} - SAR_{\text{w/o holder}}}{SAR_{\text{w/o holder}}} \right) \quad (\text{E.21})$$

The Highest Measured SAR Configuration among all applicable Frequency Band

Frequency Band	Freq.(MHz)	EUT Position	Meas. SAR (W/kg)		The Device holder perturbation uncertainty
			With holder	Without holder	
/	/	/	/	/	/

11. SAR SIMULTANEOUS TRANSMISSION DESCRIPTION

Simultaneous Transmission:

Description of Simultaneous Transmit Capabilities		
Transmitter Combination	Simultaneous?	Hotspot?
WWAN(GSM/WCDMA/LTE/5G NR)Antenna + WIFI 2.4G Chain 0+ NFC	√	√
WWAN(GSM/WCDMA/LTE/5G NR)Antenna + WIFI 2.4G Chain 1+ NFC	√	√
WWAN(GSM/WCDMA/LTE/5G NR)Antenna + WIFI 5G + NFC	√	√
WWAN(GSM/WCDMA/LTE/5G NR)Antenna + Bluetooth+ NFC	√	×
WLAN2.4G+Bluetooth+ NFC	×	×
WLAN 5G + Bluetooth+ NFC	×	×
WLAN2.4G +WLAN 5G+ NFC	×	×

EN-DC Carrier Aggregation Possible Combinations	
LTE Anchor Bands for NR band n7	LTE Band 2/5/7/66
LTE Anchor Bands for NR band n41	LTE Band 4/5/41/66
LTE Anchor Bands for NR band n66	LTE Band 2/5/7/66
LTE Anchor Bands for NR band n77	LTE Band 5/7/41/66
LTE Anchor Bands for NR band n78	LTE Band 2/4/5/7/38/41/66

Note:5G NR bands supports SA Band 5/7/12/38/41/66/77/78 and NSA DC_2A_n66A/ DC_2A_n78A/ DC_2A_n7A/ DC_38A_n78A/ DC_41A_n41A/ DC_41A_n77A/ DC_41A_n78A/ DC_4A_n41A/ DC_4A_n78A/ DC_5A_n41A/ DC_5A_n66A/ DC_5A_n77A/ DC_5A_n78A/ DC_5A_n7A/ DC_66A_n41A/ DC_66A_n66A/ DC_66A_n7A/ DC_66A_n77A/ DC_66A_n78A/ DC_7A_n66A/ DC_7A_n7A/ DC_7A_n77A/ DC_7A_n78A mode.

EN-DC SAR Assessment:

Mode(SAR1+SAR2)	Position	Reported SAR(W/kg)		Σ SAR < 1.6W/kg
		SAR1	SAR2	
DC_2A_n7A	Head Left Cheek	0.04	0.22	0.26
	Head Left Tilt	0.01	0.31	0.32
	Head Right Cheek	0.06	0.38	0.44
	Head Right Tilt	0.01	0.43	0.44
	Body Front	0.36	0.08	0.44
	Body Back	0.51	0.24	0.75
	Body Left	0.14	0.07	0.21
	Body Right	0.03	0.07	0.1
	Body Top	NA	0.26	0.26
	Body Bottom	0.78	0.36	1.14
DC_5A_n7A	Head Left Cheek	0.25	0.22	0.47
	Head Left Tilt	0.23	0.31	0.54
	Head Right Cheek	0.32	0.38	0.7
	Head Right Tilt	0.32	0.43	0.75
	Body Front	0.16	0.08	0.24
	Body Back	0.22	0.24	0.46
	Body Left	0.03	0.07	0.1
	Body Right	0.05	0.07	0.12
	Body Top	0.07	0.26	0.33
	Body Bottom	0.1	0.36	0.46
DC_7A_n7A	Head Left Cheek	0.16	0.22	0.38
	Head Left Tilt	0.18	0.31	0.49
	Head Right Cheek	0.42	0.38	0.8
	Head Right Tilt	0.28	0.43	0.71
	Body Front	0.21	0.08	0.29
	Body Back	0.65	0.24	0.89
	Body Left	0.12	0.07	0.19
	Body Right	0.01	0.07	0.08
	Body Top	0.25	0.26	0.51
	Body Bottom	0.44	0.36	0.8
DC_66A_n7A	Head Left Cheek	0.25	0.22	0.47
	Head Left Tilt	0.26	0.31	0.57
	Head Right Cheek	0.37	0.38	0.75
	Head Right Tilt	0.38	0.43	0.81
	Body Front	0.23	0.08	0.31
	Body Back	0.36	0.24	0.6
	Body Left	0.03	0.07	0.1
	Body Right	0.07	0.07	0.14
Body Top	0.15	0.26	0.41	

	Body Bottom	0.36	0.36	0.72
DC_4A_n41A	Head Left Cheek	0.25	0.17	0.42
	Head Left Tilt	0.26	0.24	0.5
	Head Right Cheek	0.37	0.35	0.72
	Head Right Tilt	0.38	0.42	0.8
	Body Front	0.23	0.08	0.31
	Body Back	0.36	0.23	0.59
	Body Left	0.03	0.06	0.09
	Body Right	0.07	0.02	0.09
	Body Top	0.15	0.24	0.39
		Body Bottom	0.36	0.07
DC_5A_n41A	Head Left Cheek	0.25	0.17	0.42
	Head Left Tilt	0.23	0.24	0.47
	Head Right Cheek	0.32	0.35	0.67
	Head Right Tilt	0.32	0.42	0.74
	Body Front	0.16	0.08	0.24
	Body Back	0.22	0.23	0.45
	Body Left	0.03	0.06	0.09
	Body Right	0.05	0.02	0.07
	Body Top	0.07	0.24	0.31
		Body Bottom	0.1	0.07
DC_41A_n41A	Head Left Cheek	0.56	0.17	0.73
	Head Left Tilt	0.19	0.24	0.43
	Head Right Cheek	0.36	0.35	0.71
	Head Right Tilt	0.47	0.42	0.89
	Body Front	0.13	0.08	0.21
	Body Back	0.36	0.23	0.59
	Body Left	0.10	0.06	0.16
	Body Right	0.01	0.02	0.03
	Body Top	0.32	0.24	0.56
		Body Bottom	0.11	0.07
DC_66A_n41A	Head Left Cheek	0.25	0.17	0.42
	Head Left Tilt	0.26	0.24	0.5
	Head Right Cheek	0.37	0.35	0.72
	Head Right Tilt	0.38	0.42	0.8
	Body Front	0.23	0.08	0.31
	Body Back	0.36	0.23	0.59
	Body Left	0.03	0.06	0.09
	Body Right	0.07	0.02	0.09
	Body Top	0.15	0.24	0.39
		Body Bottom	0.36	0.07
DC_2A_n66A	Head Left Cheek	0.04	0.28	0.32
	Head Left Tilt	0.01	0.36	0.37

	Head Right Cheek	0.06	0.38	0.44
	Head Right Tilt	0.01	0.48	0.49
	Body Front	0.36	0.14	0.5
	Body Back	0.51	0.22	0.73
	Body Left	0.14	0.03	0.17
	Body Right	0.03	0.05	0.08
	Body Top	NA	0.14	0.14
	Body Bottom	0.78	0.24	1.02
DC_5A_n66A	Head Left Cheek	0.25	0.28	0.53
	Head Left Tilt	0.23	0.36	0.59
	Head Right Cheek	0.32	0.38	0.7
	Head Right Tilt	0.32	0.48	0.8
	Body Front	0.16	0.14	0.3
	Body Back	0.22	0.22	0.44
	Body Left	0.03	0.03	0.06
	Body Right	0.05	0.05	0.1
	Body Top	0.07	0.14	0.21
	Body Bottom	0.1	0.24	0.34
DC_7A_n66A	Head Left Cheek	0.16	0.28	0.44
	Head Left Tilt	0.18	0.36	0.54
	Head Right Cheek	0.42	0.38	0.8
	Head Right Tilt	0.28	0.48	0.76
	Body Front	0.21	0.14	0.35
	Body Back	0.65	0.22	0.87
	Body Left	0.12	0.03	0.15
	Body Right	0.01	0.05	0.06
	Body Top	0.25	0.14	0.39
	Body Bottom	0.44	0.24	0.68
DC_66A_n66A	Head Left Cheek	0.25	0.28	0.53
	Head Left Tilt	0.26	0.36	0.62
	Head Right Cheek	0.37	0.38	0.75
	Head Right Tilt	0.38	0.48	0.86
	Body Front	0.23	0.14	0.37
	Body Back	0.36	0.22	0.58
	Body Left	0.03	0.03	0.06
	Body Right	0.07	0.05	0.12
	Body Top	0.15	0.14	0.29
	Body Bottom	0.36	0.24	0.6
DC_5A_n77A	Head Left Cheek	0.25	0.41	0.66
	Head Left Tilt	0.23	0.37	0.6
	Head Right Cheek	0.32	0.39	0.71
	Head Right Tilt	0.32	0.26	0.58
	Body Front	0.16	0.11	0.27

	Body Back	0.22	0.23	0.45	
	Body Left	0.03	0.16	0.19	
	Body Right	0.05	0.15	0.2	
	Body Top	0.07	0.08	0.15	
	Body Bottom	0.1	0.09	0.19	
DC_7A_n77A	Head Left Cheek	0.16	0.41	0.57	
	Head Left Tilt	0.18	0.37	0.55	
	Head Right Cheek	0.42	0.39	0.81	
	Head Right Tilt	0.28	0.26	0.54	
	Body Front	0.21	0.11	0.32	
	Body Back	0.65	0.23	0.88	
	Body Left	0.12	0.16	0.28	
	Body Right	0.01	0.15	0.16	
	Body Top	0.25	0.08	0.33	
	Body Bottom	0.44	0.09	0.53	
	DC_41A_n77A	Head Left Cheek	0.56	0.41	0.97
		Head Left Tilt	0.19	0.37	0.56
		Head Right Cheek	0.36	0.39	0.75
Head Right Tilt		0.47	0.26	0.73	
Body Front		0.13	0.11	0.24	
Body Back		0.36	0.23	0.59	
Body Left		0.10	0.16	0.26	
Body Right		0.01	0.15	0.16	
Body Top		0.32	0.08	0.4	
Body Bottom		0.11	0.09	0.2	
DC_66A_n77A	Head Left Cheek	0.25	0.41	0.66	
	Head Left Tilt	0.26	0.37	0.63	
	Head Right Cheek	0.37	0.39	0.76	
	Head Right Tilt	0.38	0.26	0.64	
	Body Front	0.23	0.11	0.34	
	Body Back	0.36	0.23	0.59	
	Body Left	0.03	0.16	0.19	
	Body Right	0.07	0.15	0.22	
	Body Top	0.15	0.08	0.23	
	Body Bottom	0.36	0.09	0.45	
DC_2A_n78A	Head Left Cheek	0.04	0.41	0.45	
	Head Left Tilt	0.01	0.37	0.38	
	Head Right Cheek	0.06	0.39	0.45	
	Head Right Tilt	0.01	0.26	0.27	
	Body Front	0.36	0.11	0.47	
	Body Back	0.51	0.23	0.74	
	Body Left	0.14	0.16	0.3	
	Body Right	0.03	0.15	0.18	

	Body Top	NA	0.08	0.08
	Body Bottom	0.78	0.09	0.87
DC_4A_n78A	Head Left Cheek	0.25	0.41	0.66
	Head Left Tilt	0.26	0.37	0.63
	Head Right Cheek	0.37	0.39	0.76
	Head Right Tilt	0.38	0.26	0.64
	Body Front	0.23	0.11	0.34
	Body Back	0.36	0.23	0.59
	Body Left	0.03	0.16	0.19
	Body Right	0.07	0.15	0.22
	Body Top	0.15	0.08	0.23
	Body Bottom	0.36	0.09	0.45
	DC_5A_n78A	Head Left Cheek	0.25	0.41
Head Left Tilt		0.23	0.37	0.6
Head Right Cheek		0.32	0.39	0.71
Head Right Tilt		0.32	0.26	0.58
Body Front		0.16	0.11	0.27
Body Back		0.22	0.23	0.45
Body Left		0.03	0.16	0.19
Body Right		0.05	0.15	0.2
Body Top		0.07	0.08	0.15
Body Bottom		0.1	0.09	0.19
DC_7A_n78A	Head Left Cheek	0.16	0.41	0.57
	Head Left Tilt	0.18	0.37	0.55
	Head Right Cheek	0.42	0.39	0.81
	Head Right Tilt	0.28	0.26	0.54
	Body Front	0.21	0.11	0.32
	Body Back	0.65	0.23	0.88
	Body Left	0.12	0.16	0.28
	Body Right	0.01	0.15	0.16
	Body Top	0.25	0.08	0.33
	Body Bottom	0.44	0.09	0.53
DC_38A_n78A	Head Left Cheek	0.56	0.41	0.97
	Head Left Tilt	0.19	0.37	0.56
	Head Right Cheek	0.36	0.39	0.75
	Head Right Tilt	0.47	0.26	0.73
	Body Front	0.13	0.11	0.24
	Body Back	0.36	0.23	0.59
	Body Left	0.1	0.16	0.26
	Body Right	0.01	0.15	0.16
	Body Top	0.32	0.08	0.4
Body Bottom	0.11	0.09	0.2	
DC_41A_n78A	Head Left Cheek	0.56	0.41	0.97

	Head Left Tilt	0.19	0.37	0.56
	Head Right Cheek	0.36	0.39	0.75
	Head Right Tilt	0.47	0.26	0.73
	Body Front	0.13	0.11	0.24
	Body Back	0.36	0.23	0.59
	Body Left	0.1	0.16	0.26
	Body Right	0.01	0.15	0.16
	Body Top	0.32	0.08	0.4
	Body Bottom	0.11	0.09	0.2
DC_66A_n78A	Head Left Cheek	0.25	0.41	0.66
	Head Left Tilt	0.26	0.37	0.63
	Head Right Cheek	0.37	0.39	0.76
	Head Right Tilt	0.38	0.26	0.64
	Body Front	0.23	0.11	0.34
	Body Back	0.36	0.23	0.59
	Body Left	0.03	0.16	0.19
	Body Right	0.07	0.15	0.22
	Body Top	0.15	0.08	0.23
	Body Bottom	0.36	0.09	0.45

Simultaneous SAR test exclusion considerations:

Mode(SAR1+SAR2)	Position	Reported SAR(W/kg)		Σ SAR < 1.6W/kg
		SAR1	SAR2	
MAX.WWAN(GSM/WCDMA/LTE/5G NR)+Bluetooth	Head	0.97	0.07	1.04
	Body	1.14	0.04	1.18

Mode(SAR1+SAR2)	Position	Reported SAR(W/kg)		Σ SAR < 1.6W/kg
		SAR1	SAR2	
MAX.WWAN(GSM/WCDMA/LTE/5G NR)+WIFI 2.4G Chain 0	Head	0.97	0.25	1.22
MAX.WWAN(GSM/WCDMA/LTE/5G NR)+WIFI 2.4G Chain 0(Hotspot)	Body	1.14	0.11	1.25
MAX.WWAN(GSM/WCDMA/LTE/5G NR)+WIFI 2.4G Chain 1	Head	0.97	0.2	1.17
MAX.WWAN(GSM/WCDMA/LTE/5G NR)+WIFI 2.4G Chain 1(Hotspot)	Body	1.14	0.06	1.2
MAX.WWAN(GSM/WCDMA/LTE/5G NR)+WIFI 5.2G	Head	0.97	0.34	1.31
MAX.WWAN(GSM/WCDMA/LTE/5G NR)+WIFI 5.2G (Hotspot)	Body	1.14	0.17	1.31
MAX.WWAN(GSM/WCDMA/LTE/5G NR)+WIFI 5.3G	Head	0.97	0.35	1.32
MAX.WWAN(GSM/WCDMA/LTE/5G NR)+WIFI 5.3G (Hotspot)	Body	1.14	0.18	1.32
MAX.WWAN(GSM/WCDMA/LTE/5G NR)+WIFI 5.6G	Head	0.97	0.47	1.44

MAX.WWAN(GSM/WCDMA/LTE/5G NR)+ WIFI 5.6G (Hotspot)	Body	1.14	0.26	1.4
MAX.WWAN(GSM/WCDMA/LTE/5G NR)+ WIFI 5.8G	Head	0.97	0.36	1.33
MAX.WWAN(GSM/WCDMA/LTE/5G NR)+ WIFI 5.8G (Hotspot)	Body	1.14	0.18	1.32

Note: For the EIRP of NFC is 0.0009mW, per KDB447498 D01 clause 4.3, the estimated SAR is so lower, so the NFC almost have no influence on the results of simultaneous transmission.

Conclusion:

Sum of SAR: $\Sigma SAR \leq 1.6$ W/kg therefore simultaneous transmission SAR with Volume Scans is **not required**.

Note: The test data of LTE Band 42/5G NR and LTE Carrier Aggregation, please refer to FCC ID: 2ADYY-KL8S, SAR report of 2401U82760E-SA, issued by Bay Area Compliance Laboratories Corp. (Shenzhen) on 2024/08/09.

11. SAR Plots

Please Refer to the Attachment.

APPENDIX A MEASUREMENT UNCERTAINTY

The uncertainty budget has been determined for the measurement system and is given in the following Table.

Measurement uncertainty evaluation for IEEE1528-2013 SAR test

Source of uncertainty	Tolerance/uncertainty ± %	Probability distribution	Divisor	ci (1 g)	ci (10 g)	Standard uncertainty ± %, (1 g)	Standard uncertainty ± %, (10 g)
Measurement system							
Probe calibration	6.55	N	1	1	1	6.3	6.3
Axial Isotropy	4.7	R	$\sqrt{3}$	1	1	2.7	2.7
Hemispherical Isotropy	9.6	R	$\sqrt{3}$	0	0	0.0	0.0
Boundary effect	1.0	R	$\sqrt{3}$	1	1	0.6	0.6
Linearity	4.7	R	$\sqrt{3}$	1	1	2.7	2.7
Detection limits	1.0	R	$\sqrt{3}$	1	1	0.6	0.6
Readout electronics	0.3	N	1	1	1	0.3	0.3
Response time	0.0	R	$\sqrt{3}$	1	1	0.0	0.0
Integration time	0.0	R	$\sqrt{3}$	1	1	0.0	0.0
RF ambient conditions – noise	1.0	R	$\sqrt{3}$	1	1	0.6	0.6
RF ambient conditions – reflections	1.0	R	$\sqrt{3}$	1	1	0.6	0.6
Probe positioner mech. Restrictions	0.8	R	$\sqrt{3}$	1	1	0.5	0.5
Probe positioning with respect to phantom shell	6.7	R	$\sqrt{3}$	1	1	3.9	3.9
Post-processing	2.0	R	$\sqrt{3}$	1	1	1.2	1.2
Test sample related							
Test sample positioning	2.8	N	1	1	1	2.8	2.8
Device holder uncertainty	6.3	N	1	1	1	6.3	6.3
Drift of output power	5.0	R	$\sqrt{3}$	1	1	2.9	2.9
Phantom and set-up							
Phantom uncertainty (shape and thickness tolerances)	4.0	R	$\sqrt{3}$	1	1	2.3	2.3
Liquid conductivity target)	5.0	R	$\sqrt{3}$	0.64	0.43	1.8	1.2
Liquid conductivity meas.)	2.5	N	1	0.64	0.43	1.6	1.1
Liquid permittivity target)	5.0	R	$\sqrt{3}$	0.6	0.49	1.7	1.4
Liquid permittivity meas.)	2.5	N	1	0.6	0.49	1.5	1.2
Combined standard uncertainty		RSS				12.2	12.0
Expanded uncertainty 95 % confidence interval)						24.1	23.7

APPENDIX B EUT TEST POSITION PHOTOS

Please Refer to the Attachment.

APPENDIX C CALIBRATION CERTIFICATES

Please Refer to the Attachment.

******* END OF REPORT *******