

TEST REPORT

Applicant: TECNO MOBILE LIMITED

Address: FLAT N 16/F BLOCK B UNIVERSAL INDUSTRIAL CENTRE
19-25 SHAN MEI STREET FOTAN NT HONGKONG

Product Name: Mobile phone

FCC ID: 2ADYY-KL6

Standard(s): 47 CFR Part 15, Subpart C(15.225)
ANSI C63.10-2013

Report Number: 2402V85515E-RF-00H

Report Date: 2024/8/5

The above device has been tested and found compliant with the requirement of the relative standards by Bay Area Compliance Laboratories Corp. (Dongguan).

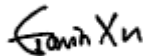

Reviewed By: Gavin Xu
Title: RF Engineer



Approved By: Ivan Cao
Title: EMC Manager

Bay Area Compliance Laboratories Corp. (Dongguan)
No.12, Pulong East 1st Road, Tangxia Town, Dongguan, Guangdong, China

Tel: +86-769-86858888

Fax: +86-769-86858891

www.baclcorp.com.cn

Note: The information marked ▲ is provided by the applicant, the laboratory is not responsible for its authenticity and this information can affect the validity of the result in the test report. Unless otherwise stated the results shown in this test report refer only to the sample(s) tested. This report cannot be reproduced except in full, without prior written approval of the Company. This report is valid only with a valid digital signature. The digital signature may be available only under the Adobe software above version 7.0. This report may contain data that are not covered by the accreditation scope and shall be marked with ★. This report must not be used by the client to claim product certification, approval, or endorsement by NVLAP, NIST, or any agency of the U.S. Government.

CONTENTS

DOCUMENT REVISION HISTORY	4
1. GENERAL INFORMATION	5
1.1 GENERAL DESCRIPTION OF EQUIPMENT UNDER TEST	5
1.2 ACCESSORY INFORMATION	5
1.3 ANTENNA INFORMATION DETAIL▲	5
1.4 EQUIPMENT MODIFICATIONS	5
2. SUMMARY OF TEST RESULTS	6
3. DESCRIPTION OF TEST CONFIGURATION	7
3.1 EUT OPERATION CONDITION	7
3.2 EUT EXERCISE SOFTWARE	7
3.3 SUPPORT EQUIPMENT LIST AND DETAILS	7
3.4 SUPPORT CABLE LIST AND DETAILS	7
3.5 BLOCK DIAGRAM OF TEST SETUP	8
3.6 TEST FACILITY	9
3.7 MEASUREMENT UNCERTAINTY	9
4. REQUIREMENTS AND TEST RESULTS	10
4.1 AC LINE CONDUCTED EMISSIONS	10
4.1.1 Applicable Standard	10
4.1.2 EUT Setup	11
4.1.3 EMI Test Receiver Setup	11
4.1.4 Test Procedure	12
4.1.5 Corrected Amplitude & Margin Calculation	12
4.1.6 Test Data	13
4.2 RADIATED SPURIOUS EMISSIONS	16
4.2.1 Applicable Standard	16
4.2.2 EUT Setup	16
4.2.3 EMI Test Receiver & Spectrum Analyzer Setup	17
4.2.4 Test Procedure	18
4.2.5 Corrected Result & Margin Calculation	18
4.2.6 Test Data	19
4.3 20 DB EMISSION BANDWIDTH	31
4.3.1 Applicable Standard	31
4.3.2 EUT Setup	31
4.3.3 Test Procedure	31
4.3.4 Test Data	33
4.4 FREQUENCY STABILITY	34
4.4.1 Applicable Standard	34
4.4.2 EUT Setup	34
4.4.3 Test Procedure	34
4.4.4 Test Result	36
4.5 ANTENNA REQUIREMENT	37

4.5.1 Applicable Standard	37
4.5.2 Judgment	37
APPENDIX A - EUT PHOTOGRAPHS	38
APPENDIX B - TEST SETUP PHOTOGRAPHS	39
APPENDIX C - RF EXPOSURE EVALUATION	40
APPLICABLE STANDARD	40

DOCUMENT REVISION HISTORY

Revision Number	Report Number	Description of Revision	Date of Revision
1.0	2402V85515E-RF-00H	Original Report	2024/8/5

1. GENERAL INFORMATION

1.1 General Description of Equipment under Test

EUT Name:	Mobile phone
EUT Model:	KL6
Operation Frequency:	13.56 MHz
Modulation Type:	ASK
Rated Input Voltage:	DC 3.87V from battery or DC 5.0/7.5V from adapter
Serial Number:	AC Line Conducted Emissions and Radiated Spurious Emission: 20CI-1 RF Conducted: 20CI-2
EUT Received Date:	2024/7/12
EUT Received Status:	Good

1.2 Accessory Information

Accessory Description	Manufacturer	Model	Parameters
Adapter	TECNO MOBILE LIMITED	U180TSA	Input: 100-240Vac 50/60Hz 0.6A Output: 5.0Vdc 2.4A or 7.5Vdc 2.4A 18W MAX
Earphone	TECNO MOBILE LIMITED	Unknown	Unknown

1.3 Antenna Information Detail ▲

Antenna Manufacturer	Antenna Type	input impedance (Ohm)	Frequency Range	Antenna Gain
TECNO MOBILE LIMITED	FPC	50	13.56MHz	Unknown
The design of compliance with §15.203:				
<input checked="" type="checkbox"/> Unit uses a permanently attached antenna.				
<input type="checkbox"/> Unit uses a unique coupling to the intentional radiator.				
<input type="checkbox"/> Unit was professionally installed, and installer shall be responsible for verifying that the correct antenna is employed with the unit.				

1.4 Equipment Modifications

No modifications are made to the EUT during all test items.

2. SUMMARY OF TEST RESULTS

FCC Rules	Description of Test	Result
FCC§15.207 (a)	AC Line Conducted Emissions	Compliant
§15.225 §15.209 §15.205	Radiated Spurious Emissions	Compliant
§15.225(e)	Frequency Stability	Compliant
§15.215(c)	20 dB Bandwidth	Compliant
FCC§15.203	Antenna Requirement	Compliant

3. DESCRIPTION OF TEST CONFIGURATION

3.1 EUT Operation Condition

The system was configured for testing in Engineering Mode, which was provided by the manufacturer. The following summary table is showing all test modes to demonstrate in compliance with the standard:

Test Items	Test Modes
RF Test	Mode 1: Transmitting
Radiated Spurious Emission	Mode 1: Transmitting
AC Line Conducted Emission	Mode 1: Transmitting

3.2 EUT Exercise Software

No software was used in test. The EUT transmit when EUT was power up.

3.3 Support Equipment List and Details

Manufacturer	Description	Model	Serial Number
/	NFC Card	/	/

3.4 Support Cable List and Details

Cable Description	Shielding Type	Ferrite Core	Length (m)	From Port	To
USB Cable	no	no	1.0	Adapter	EUT
earphone Cable	no	no	1.2	Earphone	EUT

3.5 Block Diagram of Test Setup

AC line conducted emissions:

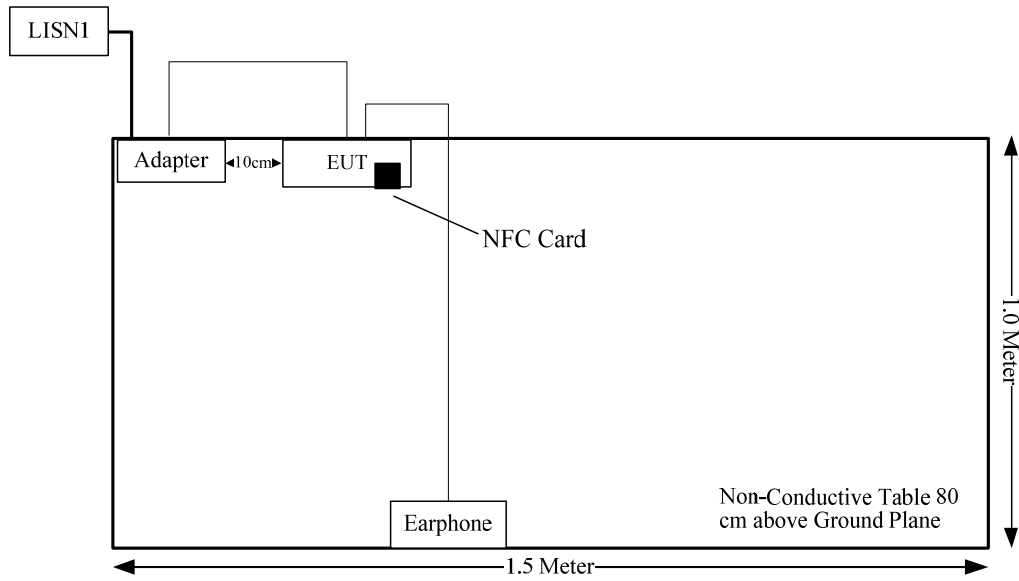

Spurious Emissions:

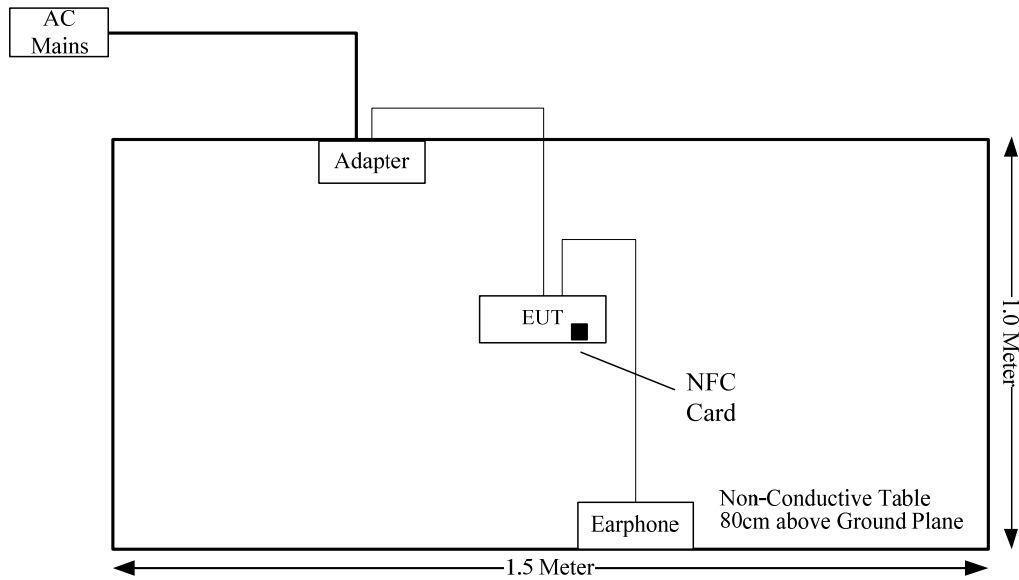

3.6 Test Facility

The Test site used by Bay Area Compliance Laboratories Corp. (Dongguan) to collect test data is located on the No.12, Pulong East 1st Road, Tangxia Town, Dongguan, Guangdong, China.

The lab has been recognized as the FCC accredited lab under the KDB 974614 D01 and is listed in the FCC Public Access Link (PAL) database, FCC Registration No. : 829273, the FCC Designation No. : CN5044.

The lab has been recognized by Innovation, Science and Economic Development Canada to test to Canadian radio equipment requirements, the CAB identifier: CN0022.

3.7 Measurement Uncertainty

Otherwise required by the applicant or Product Regulations, Decision Rule in this report did not consider the uncertainty. The extended uncertainty given in this report is obtained by combining the standard uncertainty times the coverage factor K with the 95% confidence interval.

Parameter	Measurement Uncertainty
Occupied Channel Bandwidth	±5 %
RF output power, conducted	±0.61dB
Power Spectral Density, conducted	±0.61 dB
Unwanted Emissions, radiated	9kHz~30MHz: 3.3dB, 30MHz~200MHz: 4.55 dB, 200MHz~1GHz: 5.92 dB, 1GHz~6GHz: 4.98 dB, 6GHz~18GHz: 5.89 dB, 18GHz~26.5GHz:5.47 dB, 26.5GHz~40GHz:5.63 dB
Unwanted Emissions, conducted	±2.47 dB
Temperature	±1°C
Humidity	±5%
DC and low frequency voltages	±0.4%
Duty Cycle	1%
AC Power Lines Conducted Emission	3.11 dB (150 kHz to 30 MHz)

4. REQUIREMENTS AND TEST RESULTS

4.1 AC Line Conducted Emissions

4.1.1 Applicable Standard

FCC§15.207(a).

(a) Except as shown in paragraphs (b) and (c) of this section, for an intentional radiator that is designed to be connected to the public utility (AC) power line, the radio frequency voltage that is conducted back onto the AC power line on any frequency or frequencies, within the band 150 kHz to 30 MHz, shall not exceed the limits in the following table, as measured using a 50 μ H/50 ohms line impedance stabilization network (LISN). Compliance with the provisions of this paragraph shall be based on the measurement of the radio frequency voltage between each power line and ground at the power terminal. The lower limit applies at the boundary between the frequency ranges.

Frequency of emission (MHz)	Conducted limit (dB μ V)	
	Quasi-peak	Average
0.15-0.5	66 to 56*	56 to 46*
0.5-5	56	46
5-30	60	50

*Decreases with the logarithm of the frequency.

(b) The limit shown in paragraph (a) of this section shall not apply to carrier current systems operating as intentional radiators on frequencies below 30 MHz. In lieu thereof, these carrier current systems shall be subject to the following standards:

(1) For carrier current system containing their fundamental emission within the frequency band 535-1705 kHz and intended to be received using a standard AM broadcast receiver: no limit on conducted emissions.

(2) For all other carrier current systems: 1000 μ V within the frequency band 535-1705 kHz, as measured using a 50 μ H/50 ohms LISN.

(3) Carrier current systems operating below 30 MHz are also subject to the radiated emission limits in §15.205, §15.209, §15.221, §15.223, or §15.227, as appropriate.

(c) Measurements to demonstrate compliance with the conducted limits are not required for devices which only employ battery power for operation and which do not operate from the AC power lines or contain provisions for operation while connected to the AC power lines. Devices that include, or make provisions for, the use of battery chargers which permit operating while charging, AC adapters or battery eliminators or that connect to the AC power lines indirectly, obtaining their power through another device which is connected to the AC power lines, shall be tested to demonstrate compliance with the conducted limits.

4.1.2 EUT Setup

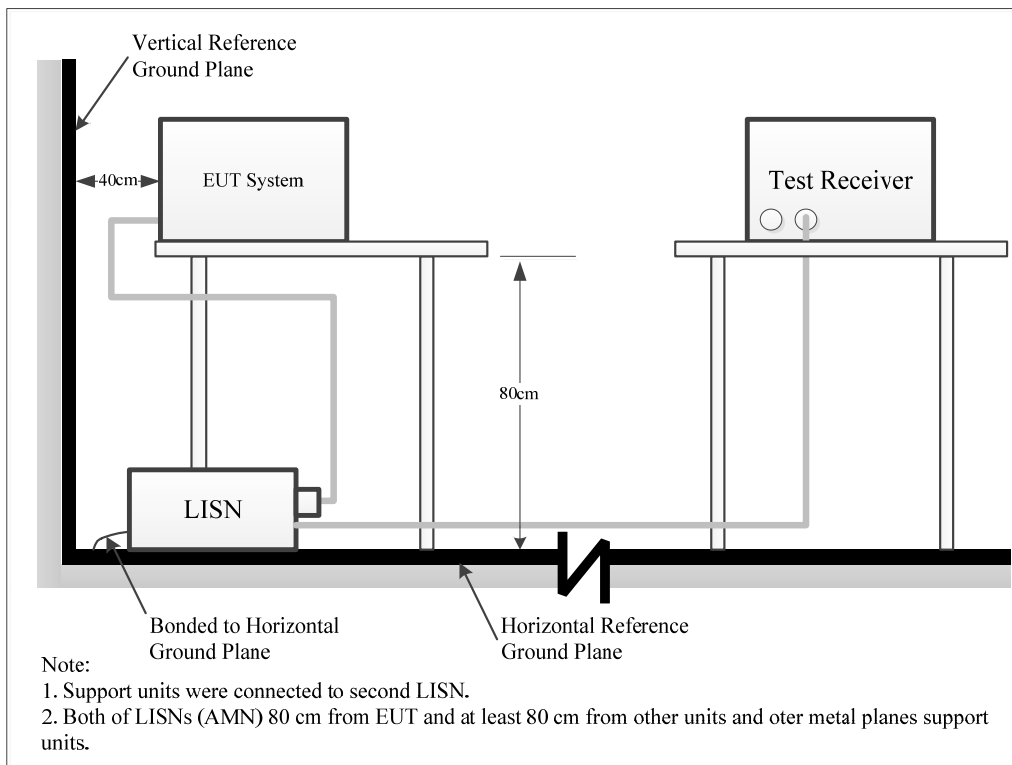

The setup of EUT is according with per ANSI C63.10-2013 measurement procedure. The specification used was with the FCC Part 15.207 limits.

The spacing between the peripherals was 10 cm.

The adapter or EUT was connected to the main LISN with a 120 V/60 Hz AC power source.

4.1.3 EMI Test Receiver Setup

The EMI test receiver was set to investigate the spectrum from 150 kHz to 30 MHz.

During the conducted emission test, the EMI test receiver was set with the following configurations:

Frequency Range	IF B/W
150 kHz – 30 MHz	9 kHz

4.1.4 Test Procedure

During the conducted emission test, the adapter was connected to the outlet of the LISN.

The frequency and amplitude of the six highest ac power-line conducted emissions relative to the limit, measured over all the current-carrying conductors of the EUT power cords, and the operating frequency or frequency to which the EUT is tuned (if appropriate), should be reported, unless such emissions are more than 20 dB below the limit. AC power-line conducted emissions measurements are to be separately carried out only on each of the phase (“hot”) line(s) and (if used) on the neutral line(s), but not on the ground [protective earth] line(s). If less than six emission frequencies are within 20 dB of the limit, then the noise level of the measuring instrument at representative frequencies should be reported. The specific conductor of the power-line cord for each of the reported emissions should be identified. Measure the six highest emissions with respect to the limit on each current-carrying conductor of each power cord associated with the EUT (but not the power cords of associated or peripheral equipment that are part of the test configuration). Then, report the six highest emissions with respect to the limit from among all the measurements identifying the frequency and specific current-carrying conductor identified with the emission. The six highest emissions should be reported for each of the current-carrying conductors, or the six highest emissions may be reported over all the current-carrying conductors.

According FCC publication number 174176, for a device with a permanent antenna operating at or below 30 MHz, the measurements done with a suitable dummy load, in lieu of the permanent antenna under the following conditions: (1) perform the AC line conducted tests with the permanent antenna to determine compliance with the Section 15.207 limits outside the transmitter's fundamental emission band; (2) retest with a dummy load in lieu of the permanent antenna to determine compliance with the Section 15.207 limits within the transmitter's fundamental emission band.

4.1.5 Corrected Amplitude & Margin Calculation

The basic equation is as follows:

Result = Reading + Factor

Factor = attenuation caused by cable loss + voltage division factor of AMN

The “**Margin**” column of the following data tables indicates the degree of compliance within the applicable limit. The equation for margin calculation is as follows:

Margin = Limit – Result

4.1.6 Test Data

Serial Number:	2OCI-1	Test Date:	2024/7/23
Test Site:	CE	Test Mode:	Transmitting
Tester:	Lane Sun	Test Result:	Pass

Environmental Conditions:

Temperature: (°C)	27.1	Relative Humidity: (%)	63	ATM Pressure: (kPa)	100.4
----------------------	------	------------------------------	----	------------------------	-------

Test Equipment List and Details:

Manufacturer	Description	Model	Serial Number	Calibration Date	Calibration Due Date
R&S	LISN	ENV216	101614	2023/10/18	2024/10/17
MICRO-COAX	Coaxial Cable	C-NJNJ-50	C-0200-01	2023/9/7	2024/9/6
R&S	EMI Test Receiver	ESCI	100035	2023/8/18	2024/8/17
R&S	Test Software	EMC32	V9.10.00	N/A	N/A

** Statement of Traceability: Bay Area Compliance Laboratories Corp. (Dongguan) attests that all calibrations have been performed, traceable to National Primary Standards and International System of Units (SI).*

Project No: 2402V85515E-RF
 Test Date: 2024-7-23
 Test Engineer: Lane Sun
 Port: L
 Test Mode: Transmitting
 Power Source: AC 120V/60Hz

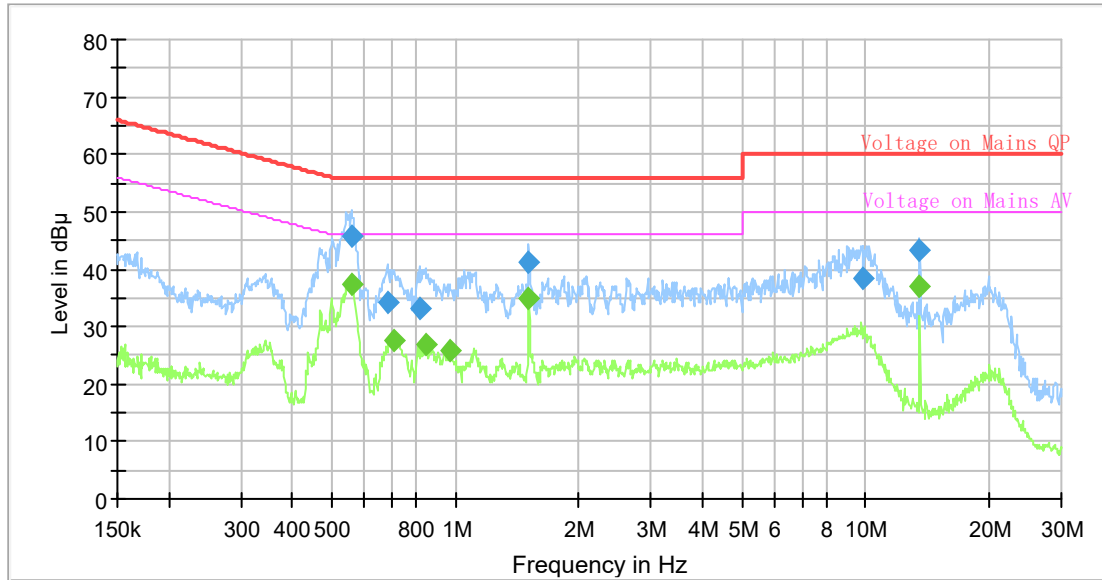

Final Result

Frequency (MHz)	QuasiPeak (dB μV)	Average (dB μV)	Limit (dB μV)	Margin (dB)	Bandwidth (kHz)	Line	Corr. (dB)
0.556885	45.80	---	56.00	10.20	9.000	L1	10.8
0.562468	---	37.42	46.00	8.58	9.000	L1	10.8
0.683241	34.41	---	56.00	21.59	9.000	L1	10.9
0.711054	---	27.46	46.00	18.54	9.000	L1	10.9
0.817621	33.12	---	56.00	22.88	9.000	L1	10.9
0.846671	---	26.93	46.00	19.07	9.000	L1	10.9
0.968720	---	25.69	46.00	20.31	9.000	L1	10.9
1.510003	41.17	---	56.00	14.83	9.000	L1	10.8
1.510003	---	34.97	46.00	11.03	9.000	L1	10.8
9.849566	38.46	---	60.00	21.54	9.000	L1	10.8
13.553299	---	37.06	50.00	12.94	9.000	L1	10.8
13.553299	43.49	---	60.00	16.51	9.000	L1	10.8

Project No: 2402V85515E-RF
 Test Date: 2024-7-23
 Test Engineer: Lane Sun
 Port: N
 Test Mode: Transmitting
 Power Source: AC 120V/60Hz

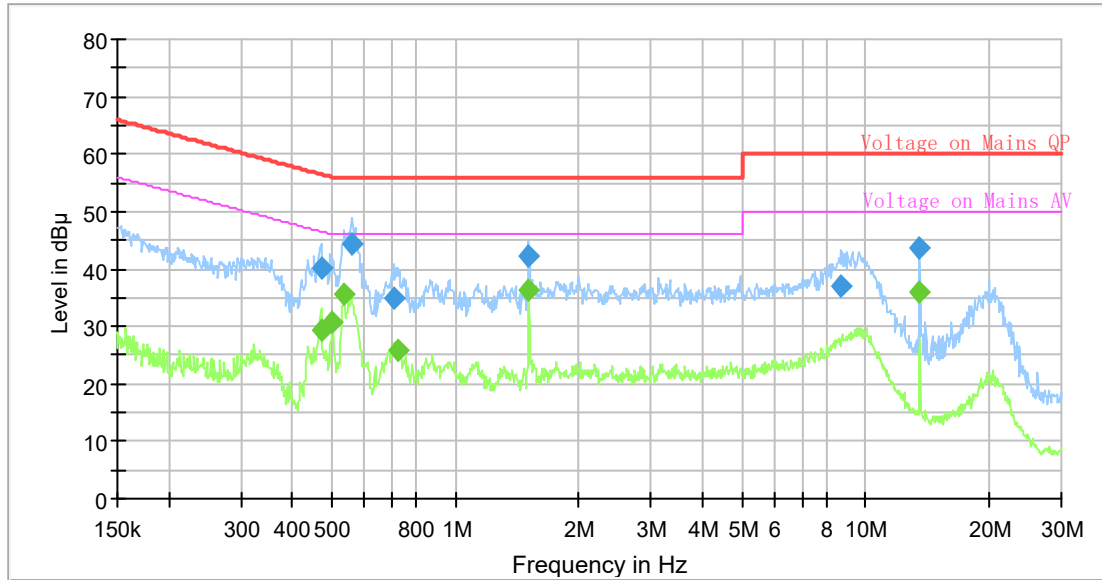

Final Result

Frequency (MHz)	QuasiPeak (dB μV)	Average (dB μV)	Limit (dB μV)	Margin (dB)	Bandwidth (kHz)	Line	Corr. (dB)
0.470023	---	29.29	46.51	17.22	9.000	N	10.7
0.470023	40.12	---	56.51	16.39	9.000	N	10.7
0.501508	---	30.89	46.00	15.11	9.000	N	10.7
0.535103	---	35.66	46.00	10.34	9.000	N	10.7
0.562468	44.29	---	56.00	11.71	9.000	N	10.7
0.707516	35.01	---	56.00	20.99	9.000	N	10.8
0.721773	---	26.00	46.00	20.00	9.000	N	10.8
1.510003	42.35	---	56.00	13.65	9.000	N	10.9
1.510003	---	36.19	46.00	9.81	9.000	N	10.9
8.738393	37.14	---	60.00	22.86	9.000	N	10.8
13.553299	---	35.98	50.00	14.02	9.000	N	10.9
13.553299	43.58	---	60.00	16.42	9.000	N	10.9

4.2 Radiated Spurious Emissions

4.2.1 Applicable Standard

As per FCC Part 15.225

- (a) The field strength of any emissions within the band 13.553–13.567 MHz shall not exceed 15,848 microvolts/meter at 30 meters.
- (b) Within the bands 13.410–13.553 MHz and 13.567–13.710 MHz, the field strength of any emissions shall not exceed 334 microvolts/meter at 30 meters.
- (c) Within the bands 13.110–13.410 MHz and 13.710–14.010 MHz the field strength of any emissions shall not exceed 106 microvolts/meter at 30 meters.
- (d) The field strength of any emissions appearing outside of the 13.110–14.010 MHz band shall not exceed the general radiated emission limits in §15.209.

4.2.2 EUT Setup

9kHz~30MHz:

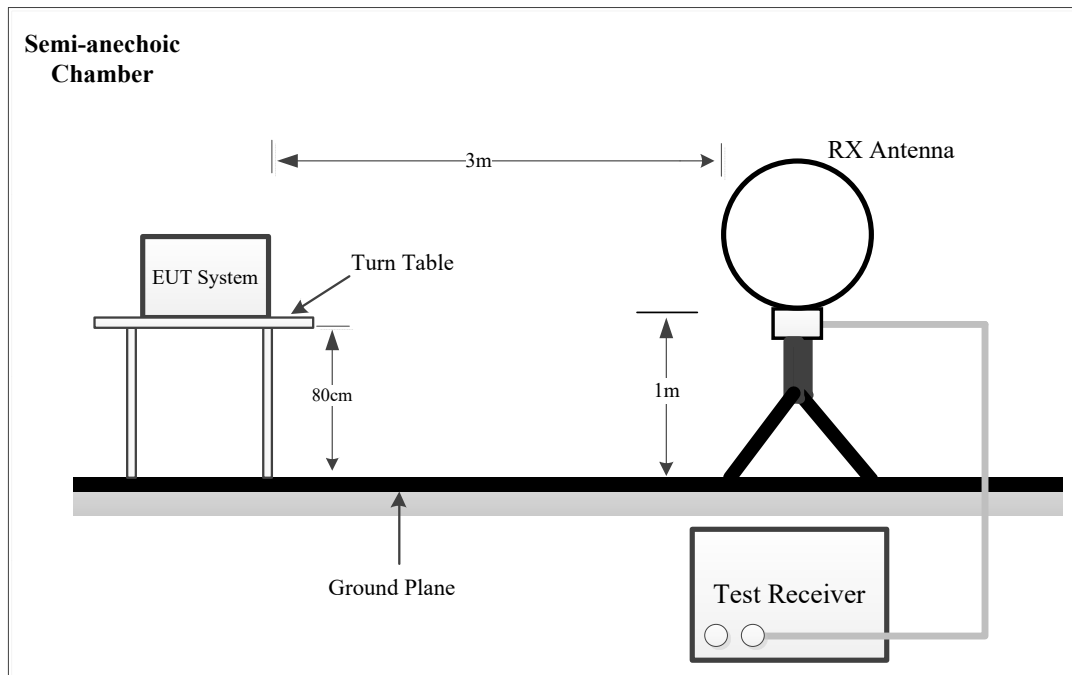

30MHz~1GHz:

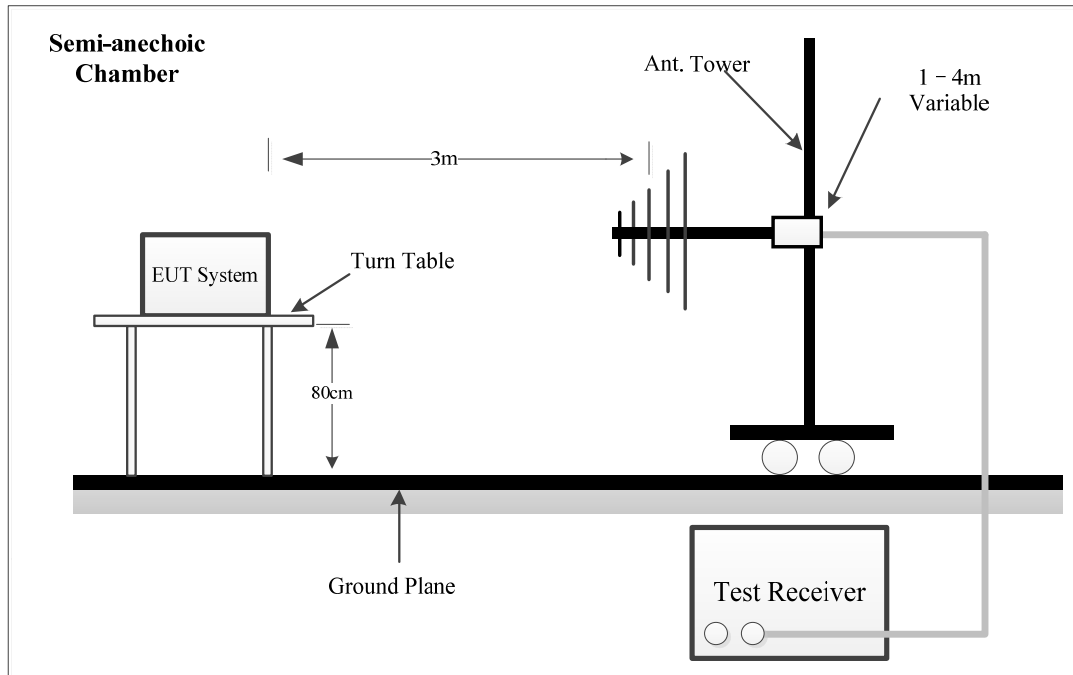

The radiated emission tests were performed in the 3-meter chamber test site, using the setup accordance with the ANSI C63.10-2013.

The external I/O cables were draped along the test table and formed a bundle 30 to 40 cm long in the middle.

The spacing between the peripherals was 10 cm.

For 9kHz-30MHz test, the lowest height of the magnetic antenna shall be 1 m above the ground and three antenna orientations (parallel, perpendicular, and ground-parallel) shall be measured.

4.2.3 EMI Test Receiver & Spectrum Analyzer Setup

The system was investigated from 9 kHz to 1 GHz.

During the radiated emission test, the EMI test Receiver was set with the following configurations:

Frequency Range	RBW	Video B/W	IF B/W	Measurement
9 kHz – 150 kHz	200 Hz	1 kHz	200 Hz	QP/AV
150 kHz – 30 MHz	9 kHz	30 kHz	9 kHz	QP/AV
30 MHz – 1000 MHz	100 kHz	300 kHz	/	PK
	/	/	120 kHz	QP

If the maximized peak measured value complies with the limit, then it is unnecessary to perform an QP measurement

4.2.4 Test Procedure

Maximizing procedure was performed on the highest emissions to ensure that the EUT complied with all installation combinations.

Data was recorded in Quasi-peak detection mode for frequency range of 9 kHz-1 GHz except 9-90 kHz, 110-490 kHz, employing an average detector.

All emissions under the average limit and under the noise floor have not recorded in the report.

4.2.5 Corrected Result & Margin Calculation

The basic equation is as follows:

Result = Reading + Factor

Factor = Antenna Factor + Cable Loss - Amplifier Gain

The “**Margin**” column of the following data tables indicates the degree of compliance within the applicable limit. The equation for margin calculation is as follows:

Margin = Limit – Result

4.2.6 Test Data

Serial Number:	2OCI-1	Test Date:	2024/7/24
Test Site:	Chamber 10m	Test Mode:	Transmitting
Tester:	Leesin Xiang	Test Result:	Pass

Environmental Conditions:					
Temperature: (°C)	29.3	Relative Humidity: (%)	38	ATM Pressure: (kPa)	99.9

Test Equipment List and Details:

Manufacturer	Description	Model	Serial Number	Calibration Date	Calibration Due Date
9kHz~1000MHz					
EMCO	Passive Loop Antenna	6512	9706-1206	2023/10/21	2026/10/20
Sunol Sciences	Hybrid Antenna	JB3	A060611-1	2023/9/6	2026/9/5
Narda	Coaxial Attenuator	779-6dB	04269	2023/9/6	2026/9/5
Unknown	Coaxial Cable	C-NJNJ-50	C-1000-01	2023/8/1	2024/7/31
Unknown	Coaxial Cable	C-NJNJ-50	C-0400-04	2023/8/1	2024/7/31
Unknown	Coaxial Cable	C-NJNJ-50	C-0530-01	2023/8/1	2024/7/31
Sonoma	Amplifier	310N	185914	2023/8/1	2024/7/31
R&S	EMI Test Receiver	ESCI	100224	2023/8/18	2024/8/17
Farad	Test Software	EZ-EMC	V1.1.4.2	N/A	N/A

* Statement of Traceability: Bay Area Compliance Laboratories Corp. (Dongguan) attests that all calibrations have been performed, traceable to National Primary Standards and International System of Units (SI).

Test Data:

Please refer to the below table and plots.
After pre-scan in the X, Y and Z axes of orientation, the worst case is refer to table and plots.

1) 9kHz~30MHz

Project No: 2402V85515E-RF
 Test Engineer: Leesin Xiang
 Test Date: 2024-7-24
 Polarization: Parallel
 Test Mode: Transmitting

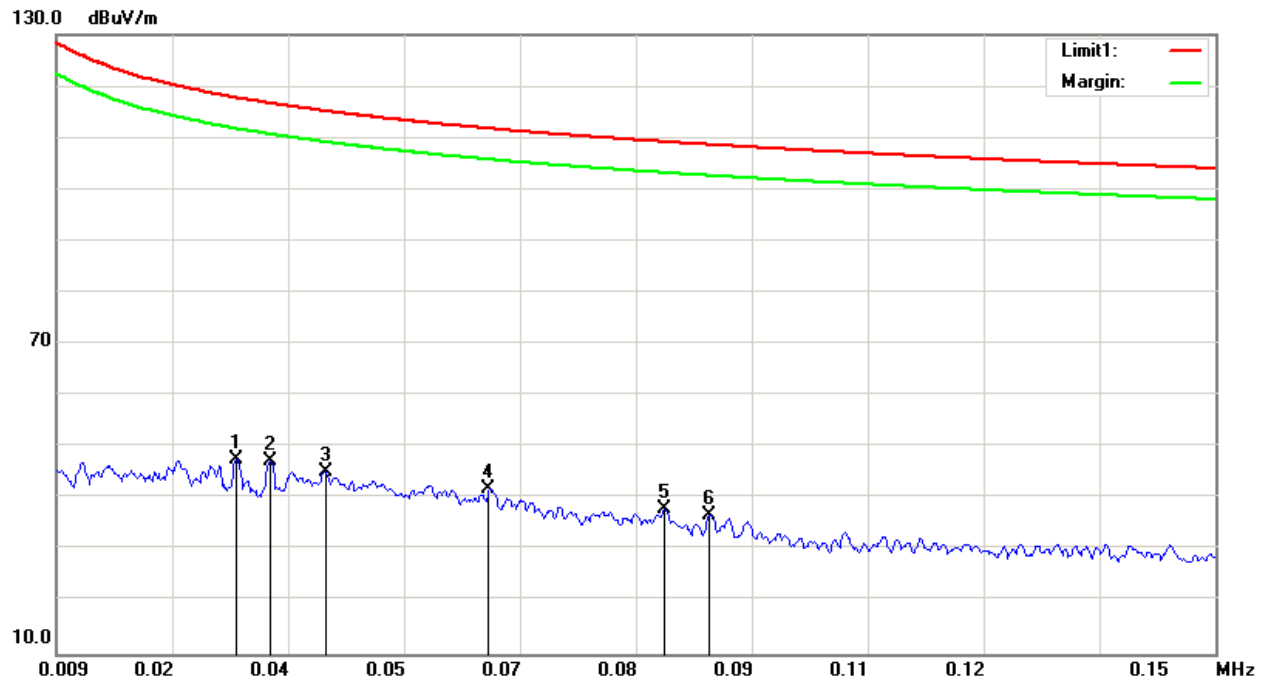

No.	Frequency (MHz)	Reading (dBuV)	Detector	Factor (dB/m)	Result (dBuV/m)	Limit (dBuV/m)	Margin (dB)
1	0.0310	0.28	peak	47.37	47.65	117.78	70.13
2	0.0350	0.82	peak	46.66	47.48	116.72	69.24
3	0.0417	-0.08	peak	45.47	45.39	115.20	69.81
4	0.0616	-0.19	peak	42.07	41.88	111.81	69.93
5	0.0830	-0.32	peak	38.38	38.06	109.22	71.16
6	0.0884	-0.49	peak	37.42	36.93	108.67	71.74

Project No: 2402V85515E-RF
 Test Engineer: Leesin Xiang
 Test Date: 2024-7-24
 Polarization: Parallel
 Test Mode: Transmitting

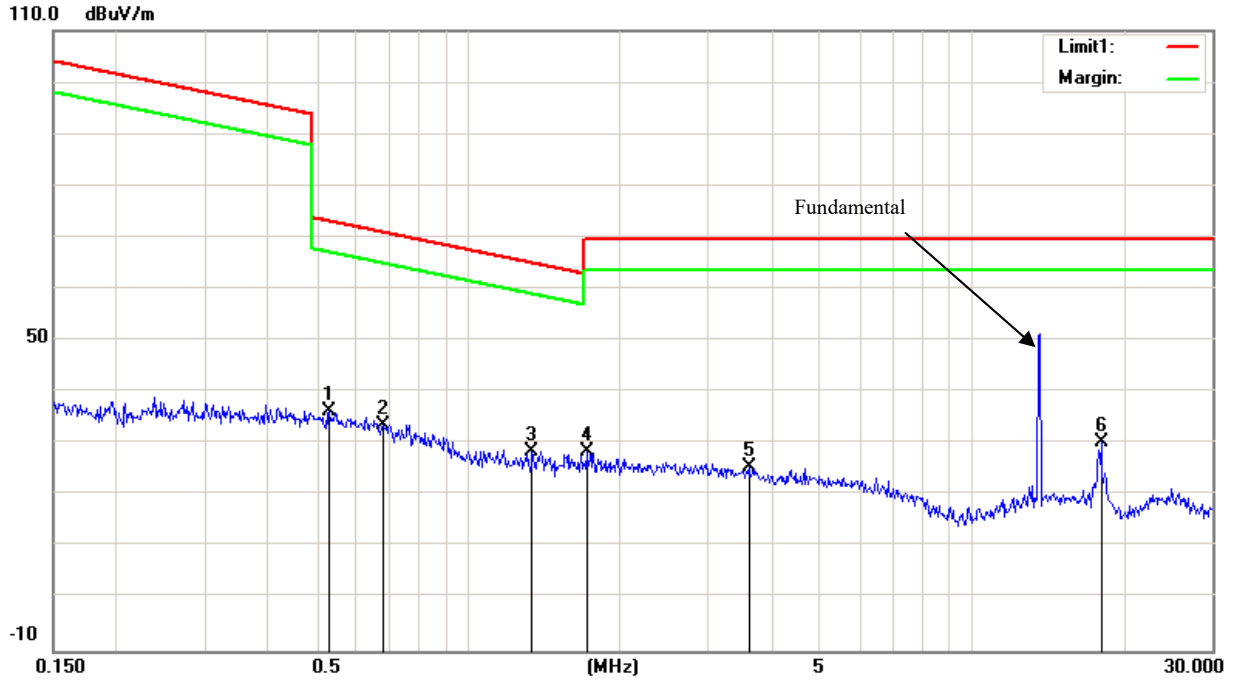

No.	Frequency (MHz)	Reading (dBuV)	Detector	Factor (dB/m)	Result (dBuV/m)	Limit (dBuV/m)	Margin (dB)
1	0.5292	13.26	peak	23.22	36.48	73.13	36.65
2	0.6753	11.94	peak	21.72	33.66	71.00	37.34
3	1.3380	13.47	peak	15.06	28.53	65.03	36.50
4	1.7160	15.12	peak	13.38	28.50	69.54	41.04
5	3.6034	17.14	peak	8.54	25.68	69.54	43.86
6	18.0393	26.13	peak	4.29	30.42	69.54	39.12

Project No: 2402V85515E-RF
 Test Engineer: Leesin Xiang
 Test Date: 2024-7-24
 Polarization: Parallel
 Test Mode: Transmitting

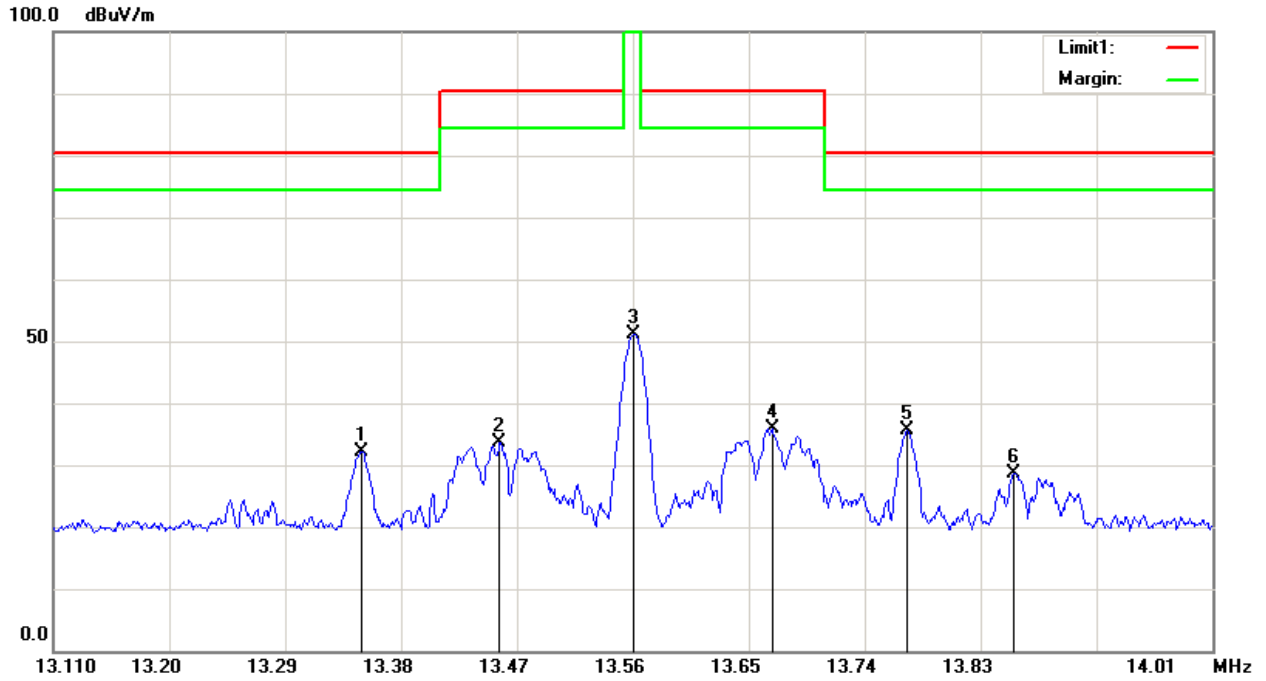

No.	Frequency (MHz)	Reading (dBuV)	Detector	Factor (dB/m)	Result (dBuV/m)	Limit (dBuV/m)	Margin (dB)
1	13.3494	27.56	peak	4.57	32.13	80.50	48.37
2	13.4565	29.04	peak	4.55	33.59	90.50	56.91
3	13.5610*	46.64	peak	4.53	51.17	124.00	72.83
4	13.6680	31.38	peak	4.51	35.89	90.50	54.61
5	13.7733	31.09	peak	4.51	35.60	80.50	44.90
6	13.8561	24.18	peak	4.49	28.67	80.50	51.83

Note:* is Fundamental .

Project No: 2402V85515E-RF
 Test Engineer: Leesin Xiang
 Test Date: 2024-7-24
 Polarization: Perpendicular
 Test Mode: Transmitting

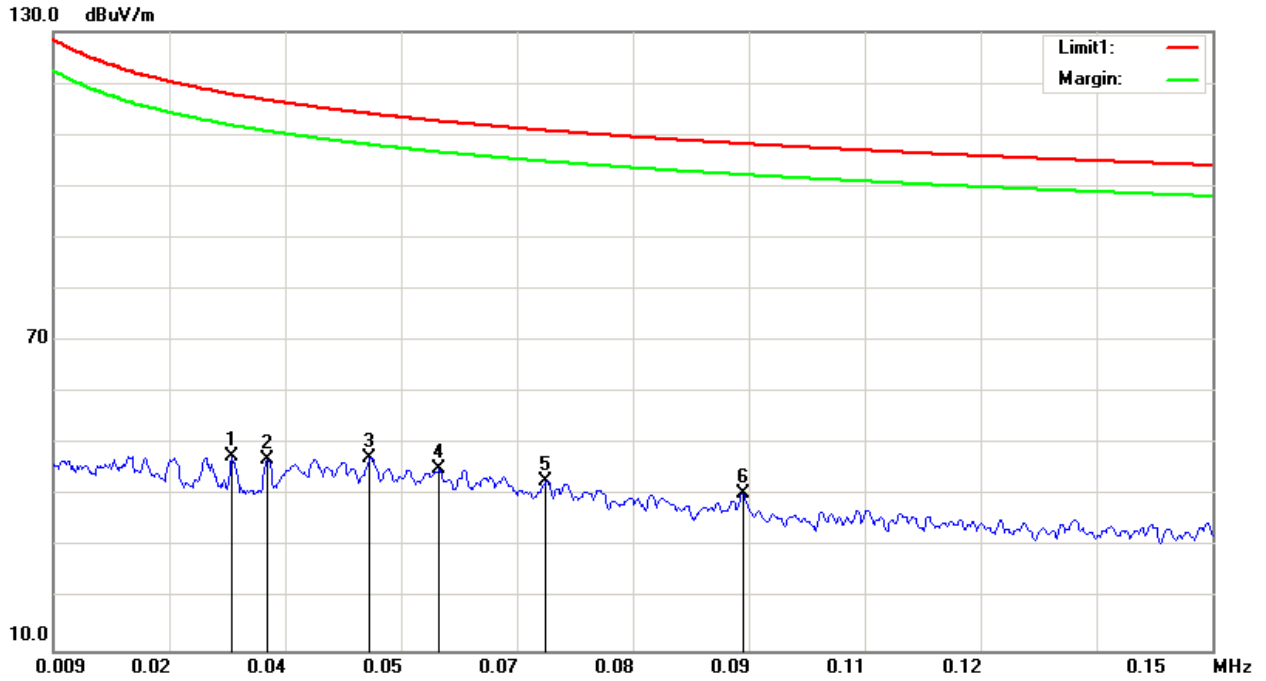

No.	Frequency (MHz)	Reading (dBuV)	Detector	Factor (dB/m)	Result (dBuV/m)	Limit (dBuV/m)	Margin (dB)
1	0.0307	0.08	peak	47.43	47.51	117.86	70.35
2	0.0350	0.53	peak	46.66	47.19	116.72	69.53
3	0.0475	2.99	peak	44.48	47.47	114.07	66.60
4	0.0560	2.09	peak	43.02	45.11	112.64	67.53
5	0.0690	2.16	peak	40.76	42.92	110.83	67.91
6	0.0928	3.82	peak	36.65	40.47	108.25	67.78

Project No: 2402V85515E-RF
 Test Engineer: Leesin Xiang
 Test Date: 2024-7-24
 Polarization: Perpendicular
 Test Mode: Transmitting

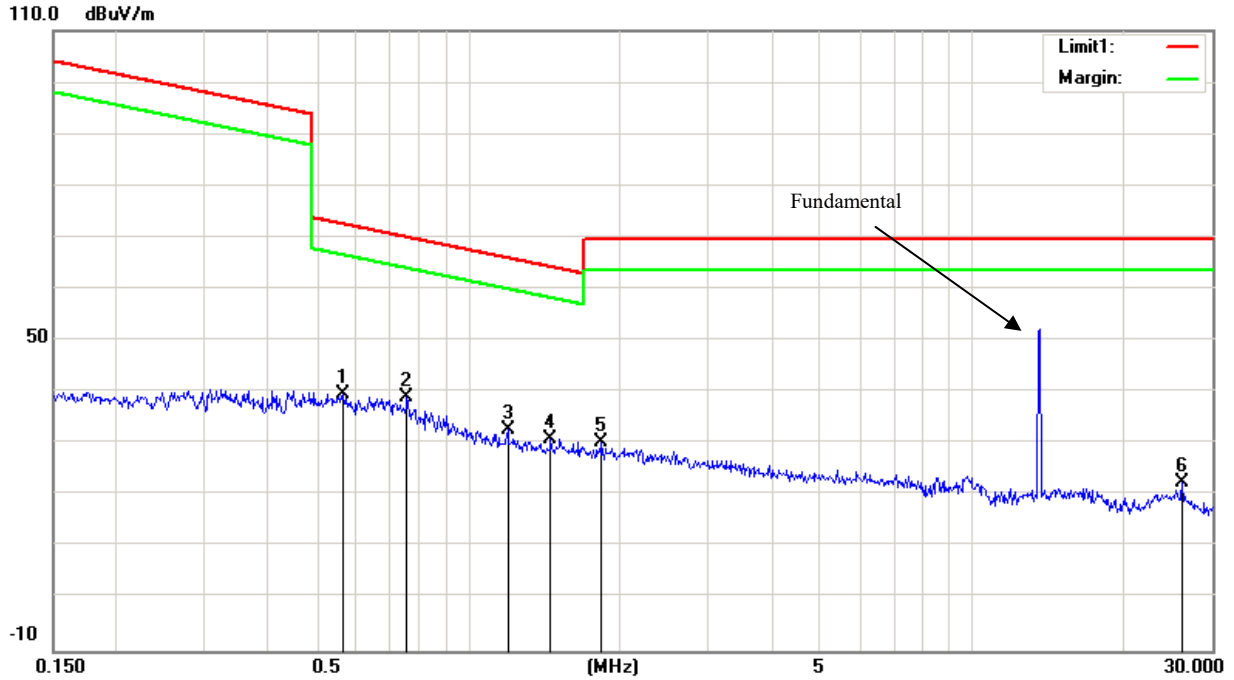

No.	Frequency (MHz)	Reading (dBuV)	Detector	Factor (dB/m)	Result (dBuV/m)	Limit (dBuV/m)	Margin (dB)
1	0.5641	16.93	peak	22.85	39.78	72.57	32.79
2	0.7550	17.95	peak	20.97	38.92	70.03	31.11
3	1.1970	16.97	peak	15.68	32.65	66.01	33.36
4	1.4560	16.33	peak	14.54	30.87	64.30	33.43
5	1.8386	17.65	peak	12.84	30.49	69.54	39.05
6	26.1391	18.27	peak	4.20	22.47	69.54	47.07

Project No: 2402V85515E-RF
 Test Engineer: Leesin Xiang
 Test Date: 2024-7-24
 Polarization: Perpendicular
 Test Mode: Transmitting

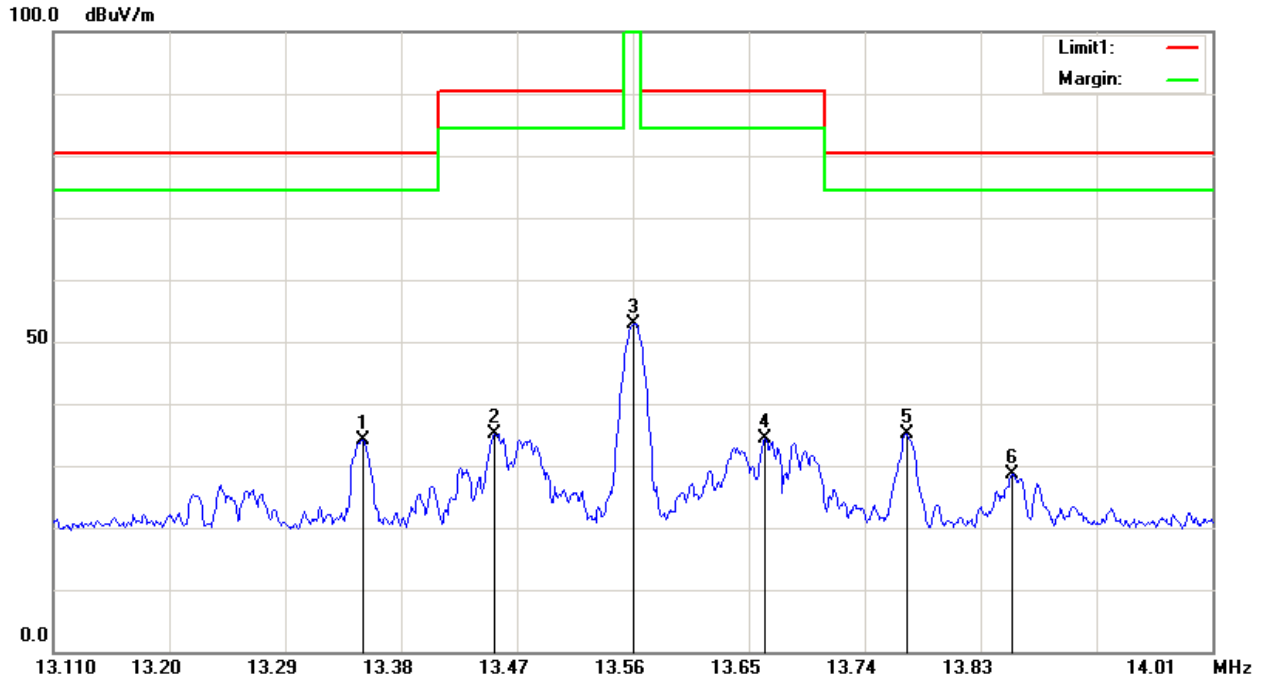

No.	Frequency (MHz)	Reading (dBuV)	Detector	Factor (dB/m)	Result (dBuV/m)	Limit (dBuV/m)	Margin (dB)
1	13.3503	29.52	peak	4.57	34.09	80.50	46.41
2	13.4530	30.68	peak	4.55	35.23	90.50	55.27
3	13.5610*	48.47	peak	4.53	53.00	124.00	71.00
4	13.6626	29.80	peak	4.51	34.31	90.50	56.19
5	13.7724	30.67	peak	4.51	35.18	80.50	45.32
6	13.8543	24.09	peak	4.49	28.58	80.50	51.92

Note:* is Fundamental .

Project No: 2402V85515E-RF
 Test Engineer: Leesin Xiang
 Test Date: 2024-7-24
 Polarization: Ground-parallel
 Test Mode: Transmitting

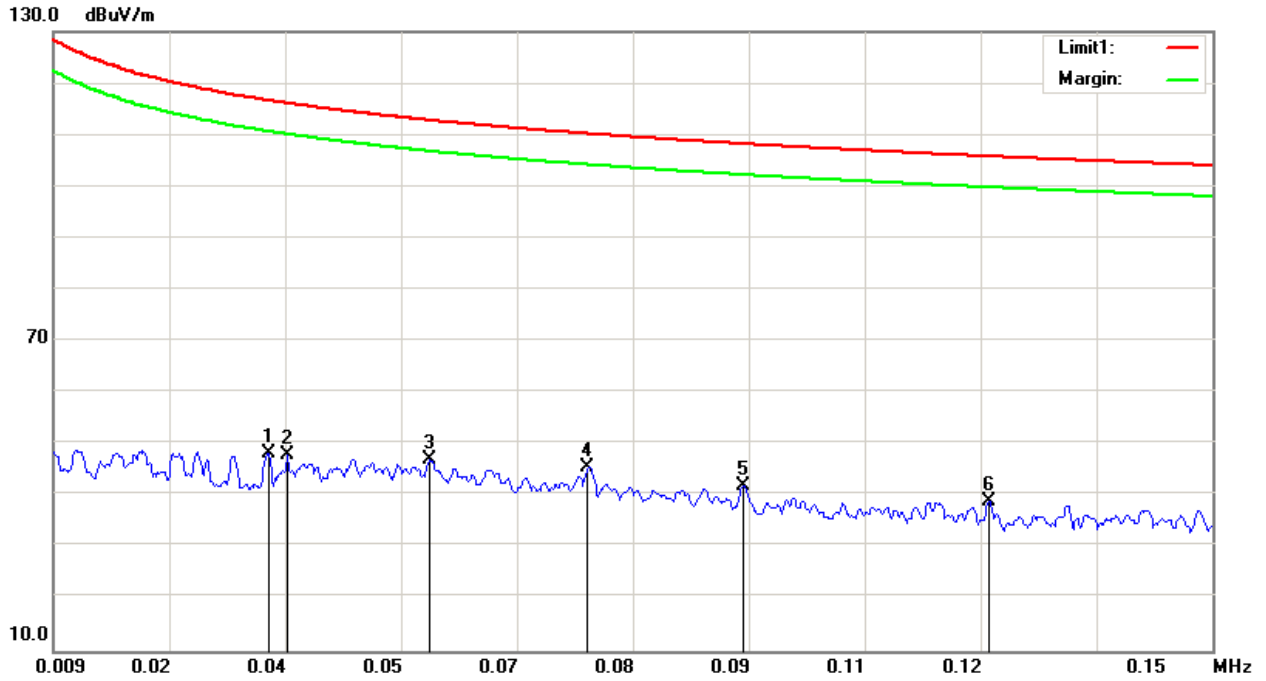

No.	Frequency (MHz)	Reading (dBuV)	Detector	Factor (dB/m)	Result (dBuV/m)	Limit (dBuV/m)	Margin (dB)
1	0.0352	1.61	peak	46.63	48.24	116.67	68.43
2	0.0374	1.84	peak	46.24	48.08	116.15	68.07
3	0.0548	3.71	peak	43.23	46.94	112.83	65.89
4	0.0740	5.65	peak	39.92	45.57	110.22	64.65
5	0.0928	5.36	peak	36.65	42.01	108.25	66.24
6	0.1228	4.76	peak	34.14	38.90	105.82	66.92

Project No: 2402V85515E-RF
 Test Engineer: Leesin Xiang
 Test Date: 2024-7-24
 Polarization: Ground-parallel
 Test Mode: Transmitting

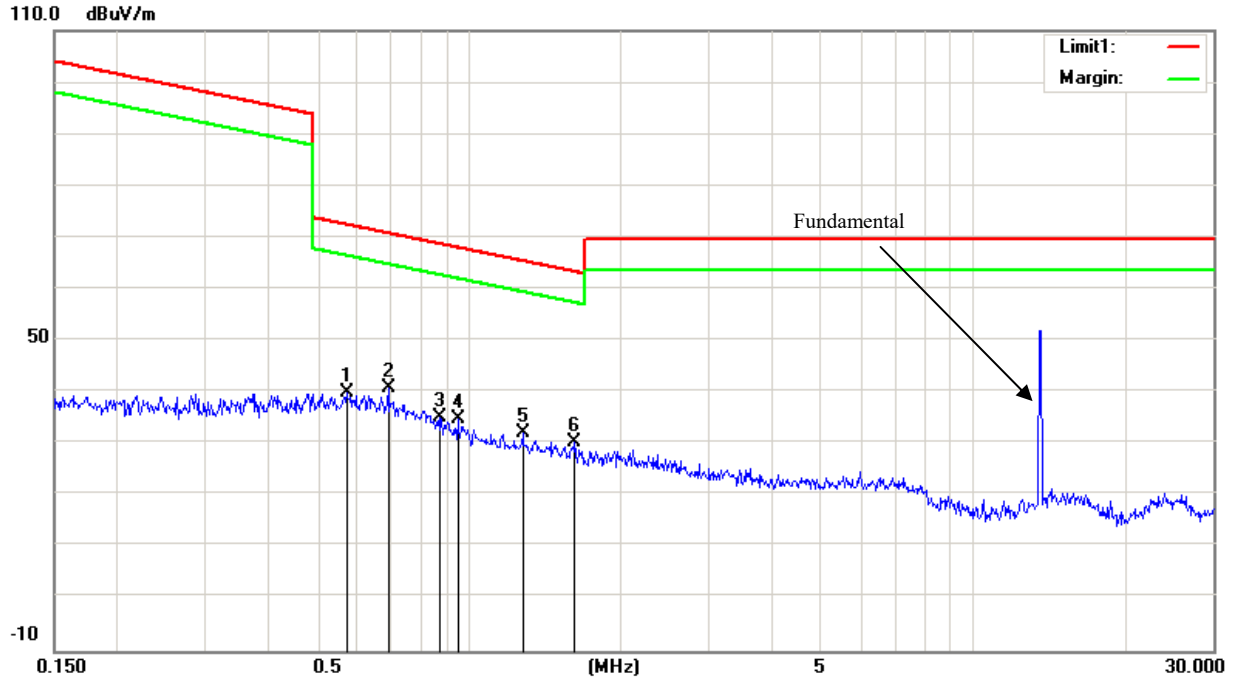

No.	Frequency (MHz)	Reading (dBuV)	Detector	Factor (dB/m)	Result (dBuV/m)	Limit (dBuV/m)	Margin (dB)
1	0.5701	17.16	peak	22.78	39.94	72.48	32.54
2	0.6897	19.36	peak	21.58	40.94	70.82	29.88
3	0.8757	16.13	peak	19.05	35.18	68.73	33.55
4	0.9481	17.23	peak	17.60	34.83	68.04	33.21
5	1.2756	16.74	peak	15.34	32.08	65.45	33.37
6	1.6190	16.44	peak	13.81	30.25	63.37	33.12

Project No: 2402V85515E-RF
 Test Engineer: Leesin Xiang
 Test Date: 2024-7-24
 Polarization: Ground-parallel
 Test Mode: Transmitting

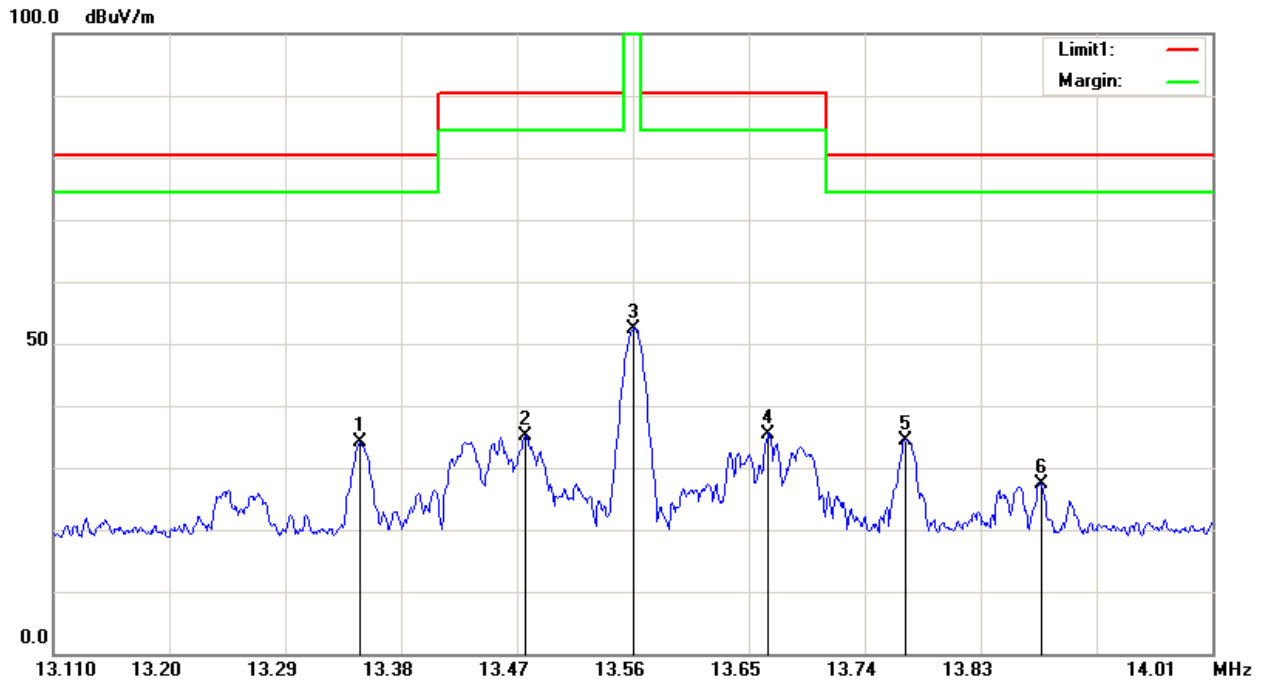

No.	Frequency (MHz)	Reading (dBuV)	Detector	Factor (dB/m)	Result (dBuV/m)	Limit (dBuV/m)	Margin (dB)
1	13.3485	29.52	peak	4.57	34.09	80.50	46.41
2	13.4763	30.54	peak	4.55	35.09	90.50	55.41
3	13.5610*	47.97	peak	4.53	52.50	124.00	71.50
4	13.6653	30.99	peak	4.51	35.50	90.50	55.00
5	13.7715	29.99	peak	4.51	34.50	80.50	46.00
6	13.8768	22.94	peak	4.48	27.42	80.50	53.08

Note:* is Fundamental .

2) 30MHz-1GHz

Project No: 2402V85515E-RF
 Test Engineer: Leesin Xiang
 Test Date: 2024-7-24
 Polarization: Horizontal
 Test Mode: Transmitting

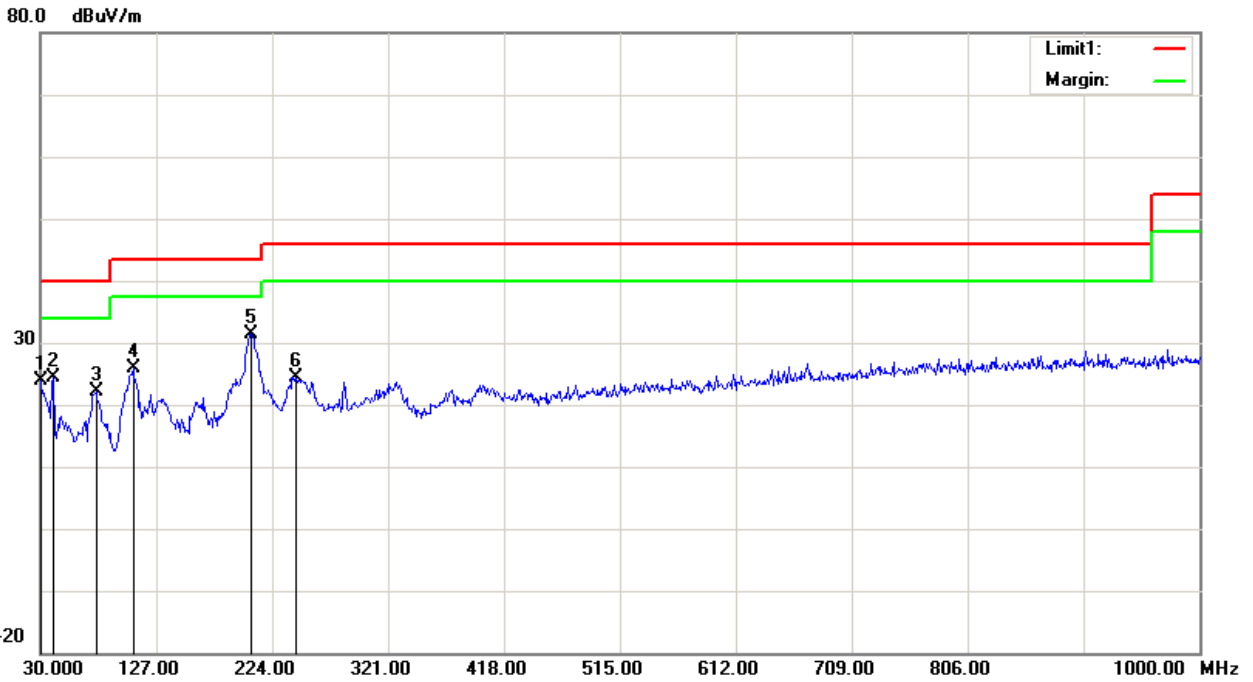

No.	Frequency (MHz)	Reading (dBuV)	Detector	Factor (dB/m)	Result (dBuV/m)	Limit (dBuV/m)	Margin (dB)
1	30.0000	27.76	peak	-3.80	23.96	40.00	16.04
2	40.6700	35.78	peak	-11.29	24.49	40.00	15.51
3	76.5600	38.44	peak	-16.25	22.19	40.00	17.81
4	107.6000	37.92	peak	-12.09	25.83	43.50	17.67
5	206.5400	43.68	peak	-12.21	31.47	43.50	12.03
6	243.4000	36.03	peak	-11.64	24.39	46.00	21.61

Project No: 2402V85515E-RF
 Test Engineer: Leesin Xiang
 Test Date: 2024-7-24
 Polarization: Vertical
 Test Mode: Transmitting

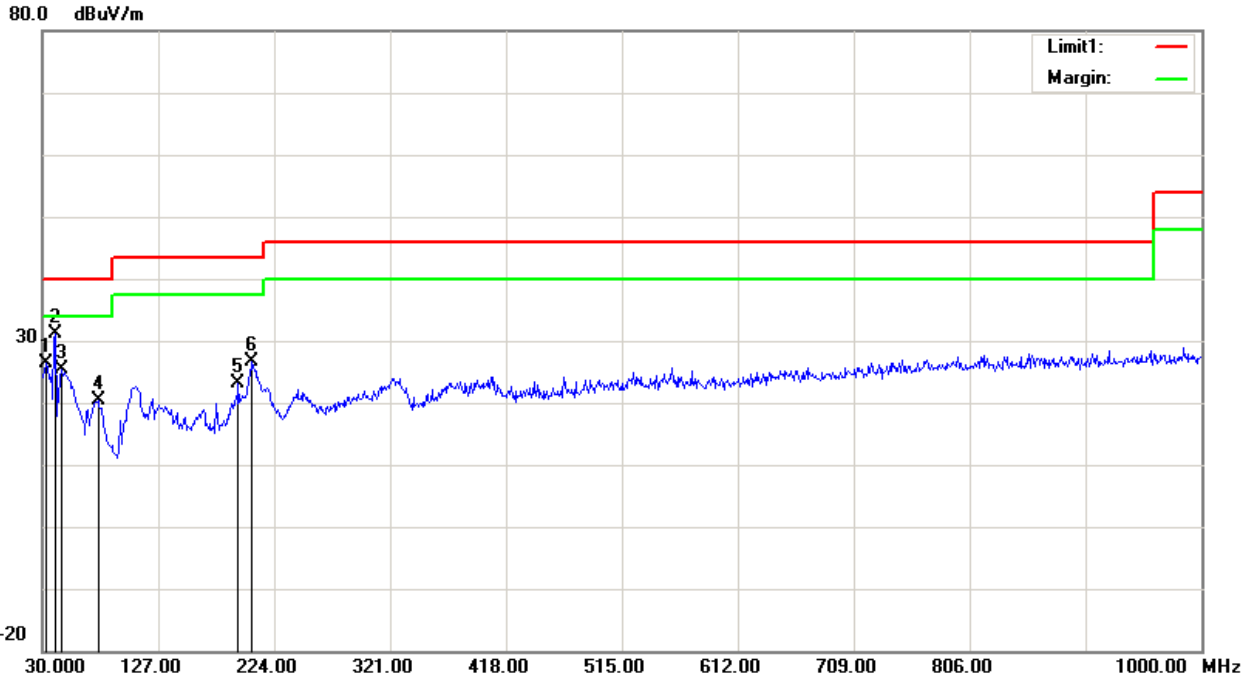

No.	Frequency (MHz)	Reading (dBuV)	Detector	Factor (dB/m)	Result (dBuV/m)	Limit (dBuV/m)	Margin (dB)
1	32.9100	32.34	peak	-5.91	26.43	40.00	13.57
2	40.6700	42.53	peak	-11.29	31.24	40.00	8.76
3	46.4900	39.90	peak	-14.49	25.41	40.00	14.59
4	76.5600	36.56	peak	-16.25	20.31	40.00	19.69
5	193.9300	34.98	peak	-11.88	23.10	43.50	20.40
6	205.5700	38.67	peak	-12.11	26.56	43.50	16.94

4.3 20 dB Emission Bandwidth

4.3.1 Applicable Standard

FCC §15.215

Intentional radiators operating under the alternative provisions to the general emission limits, as contained in §15.217 through § 15.257 and in Subpart E of this part, must be designed to ensure that the 20 dB bandwidth of the emission, or whatever bandwidth may otherwise be specified in the specific rule section under which the equipment operates, is contained within the frequency band designated in the rule section under which the equipment is operated. The requirement to contain the designated bandwidth of the emission within the specified frequency band includes the effects from frequency sweeping, frequency hopping and other modulation techniques that may be employed as well as the frequency stability of the transmitter over expected variations in temperature and supply voltage. If a frequency stability is not specified in the regulations, it is recommended that the fundamental emission be kept within at least the central 80% of the permitted band in order to minimize the possibility of out-of band operation.

4.3.2 EUT Setup

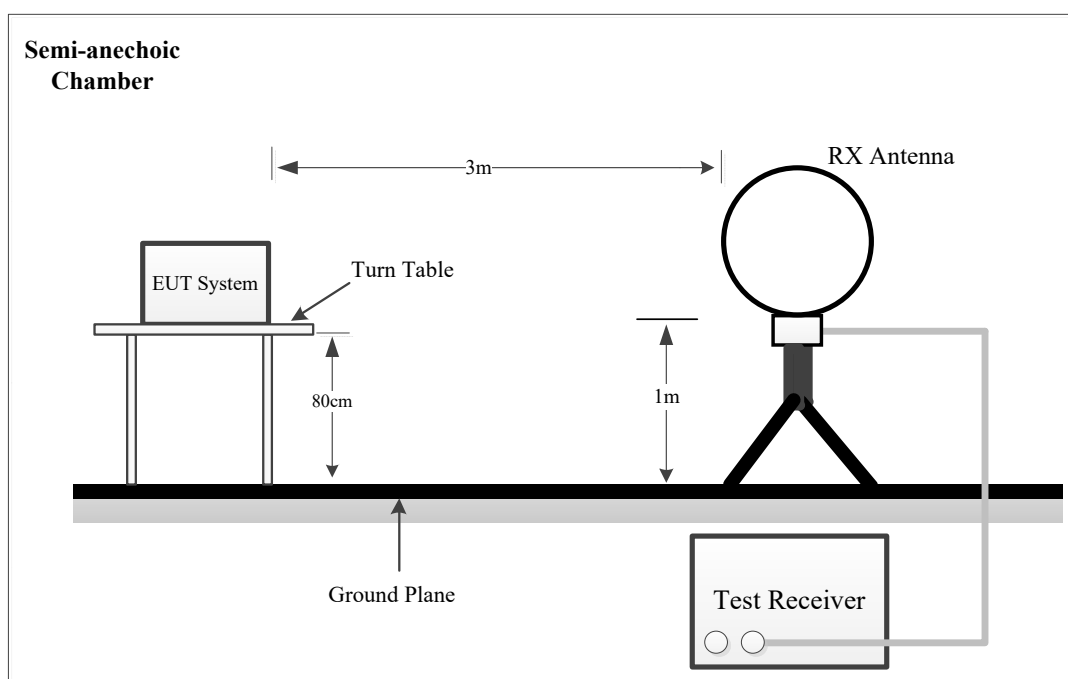

4.3.3 Test Procedure

According to ANSI C63.10-2013 Section 6.9.2

- The spectrum analyzer center frequency is set to the nominal EUT channel center frequency. The span range for the EMI receiver or spectrum analyzer shall be between two times and five times the OBW.
- The nominal IF filter bandwidth (3 dB RBW) shall be in the range of 1% to 5% of the OBW and video bandwidth (VBW) shall be approximately three times RBW, unless otherwise specified by the applicable requirement.
- Set the reference level of the instrument as required, keeping the signal from exceeding the maximum input mixer level for linear operation. In general, the peak of the spectral envelope shall be more than $[10 \log (\text{OBW}/\text{RBW})]$ below the reference level. Specific guidance is given in 4.1.5.2
- Steps a) through c) might require iteration to adjust within the specified tolerances.
- The dynamic range of the instrument at the selected RBW shall be more than 10 dB below the target

“-xx dB down” requirement; that is, if the requirement calls for measuring the -20 dB OBW, the instrument noise floor at the selected RBW shall be at least 30 dB below the reference value.

f) Set detection mode to peak and trace mode to max hold.

g) Determine the reference value: Set the EUT to transmit an unmodulated carrier or modulated signal, as applicable. Allow the trace to stabilize. Set the spectrum analyzer marker to the highest level of the displayed trace (this is the reference value).

h) Determine the “-xx dB down amplitude” using [(reference value) - xx]. Alternatively, this calculation may be made by using the marker-delta function of the instrument.

i) If the reference value is determined by an unmodulated carrier, then turn the EUT modulation ON, and either clear the existing trace or start a new trace on the spectrum analyzer and allow the new trace to stabilize. Otherwise, the trace from step g) shall be used for step j).

j) Place two markers, one at the lowest frequency and the other at the highest frequency of the envelope of the spectral display, such that each marker is at or slightly below the “-xx dB down amplitude” determined in step h). If a marker is below this “-xx dB down amplitude” value, then it shall be as close as possible to this value. The occupied bandwidth is the frequency difference between the two markers. Alternatively, set a marker at the lowest frequency of the envelope of the spectral display, such that the marker is at or slightly below the “-xx dB down amplitude” determined in step h). Reset the marker-delta function and move the marker to the other side of the emission until the delta marker amplitude is at the same level as the reference marker amplitude. The marker-delta frequency reading at this point is the specified emission bandwidth.

k) The occupied bandwidth shall be reported by providing plot(s) of the measuring instrument display; the plot axes and the scale units per division shall be clearly labeled. Tabular data may be reported in addition to the plot(s).

4.3.4 Test Data

Serial Number:	20CI-1	Test Date:	2024/7/24
Test Site:	Chamber 10m	Test Mode:	Transmitting
Tester:	Leesin Xiang	Test Result:	Pass

Environmental Conditions:					
Temperature: (°C)	29.3	Relative Humidity: (%)	38	ATM Pressure: (kPa)	99.9

Test Equipment List and Details:

Manufacturer	Description	Model	Serial Number	Calibration Date	Calibration Due Date
EMCO	Passive Loop Antenna	6512	9706-1206	2023/10/21	2026/10/20
Narda	Coaxial Attenuator	779-6dB	04269	2023/9/6	2026/9/5
Unknown	Coaxial Cable	C-NJNJ-50	C-1000-01	2023/8/1	2024/7/31
Unknown	Coaxial Cable	C-NJNJ-50	C-0400-04	2023/8/1	2024/7/31
Unknown	Coaxial Cable	C-NJNJ-50	C-0530-01	2023/8/1	2024/7/31
Sonoma	Amplifier	310N	185914	2023/8/1	2024/7/31
R&S	EMI Test Receiver	ESCI	100224	2023/8/18	2024/8/17

** Statement of Traceability: China Certification ICT Co., Ltd (Dongguan) attests that all calibrations have been performed, traceable to National Primary Standards and International System of Units (SI).*

Test Data:

Frequency (MHz)	20 dB Bandwidth (kHz)
13.56	0.8

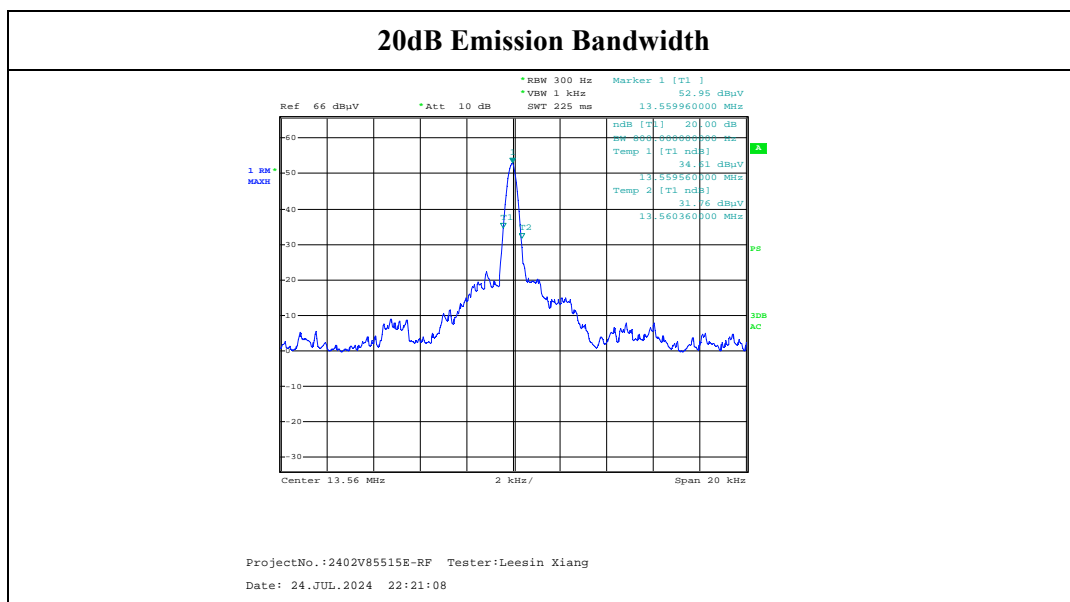

4.4 Frequency Stability

4.4.1 Applicable Standard

As per FCC Part 15.225:

The frequency tolerance of the carrier signal shall be maintained within $\pm 0.01\%$ of the operating frequency over a temperature variation of -20 degrees to $+50$ degrees C at normal supply voltage, and for a variation in the primary supply voltage from 85% to 115% of the rated supply voltage at a temperature of 20 degrees C. For battery operated equipment, the equipment tests shall be performed using a new battery.

4.4.2 EUT Setup

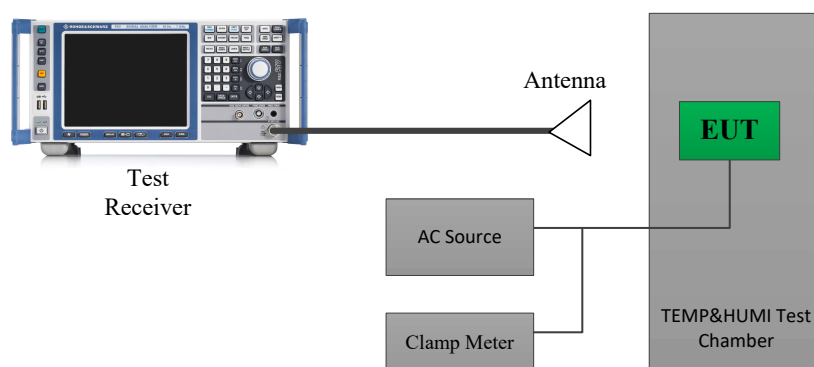

4.4.3 Test Procedure

According to ANSI C63.10-2013 Section 6.8

Frequency stability with respect to ambient temperature

- Supply the EUT with a nominal ac voltage or install a new or fully charged battery in the EUT. If possible, a dummy load shall be connected to the EUT because an antenna near the metallic walls of an environmental test chamber could affect the output frequency of the EUT. If the EUT is equipped with a permanently attached, adjustable-length antenna, then the EUT shall be placed in the center of the chamber with the antenna adjusted to the shortest length possible. Turn ON the EUT and tune it to one of the number of frequencies shown in 5.6.
- Couple the unlicensed wireless device output to the measuring instrument by connecting an antenna to the measuring instrument with a suitable length of coaxial cable and placing the measuring antenna near the EUT (e.g., 15 cm away), or by connecting a dummy load to the measuring instrument, through an attenuator if necessary.

NOTE—An instrument that has an adequate level of accuracy as specified by the procuring or regulatory agency is the recommended measuring instrument.

- Adjust the location of the measurement antenna and the controls on the measurement instrument to obtain a suitable signal level (i.e., a level that will not overload the measurement instrument but is strong enough to allow measurement of the operating or fundamental frequency of the EUT).
- Turn the EUT OFF and place it inside the environmental temperature chamber. For devices that have oscillator heaters, energize only the heater circuit.

- e) Set the temperature control on the chamber to the highest specified in the regulatory requirements for the type of device and allow the oscillator heater and the chamber temperature to stabilize.
- f) While maintaining a constant temperature inside the environmental chamber, turn the EUT ON and record the operating frequency at startup, and at 2 minutes, 5 minutes, and 10 minutes after the EUT is energized. Four measurements in total are made.
- g) Measure the frequency at each of frequencies specified in 5.6.
- h) Switch OFF the EUT but do not switch OFF the oscillator heater.
- i) Lower the chamber temperature by not more than 10 °C, and allow the temperature inside the chamber to stabilize.
- j) Repeat step f) through step i) down to the lowest specified temperature.

Frequency stability when varying supply voltage

Unless otherwise specified, these tests shall be made at ambient room temperature (+15 °C to +25 °C). An antenna shall be connected to the antenna output terminals of the EUT if possible. If the EUT is equipped with or uses an adjustable-length antenna, then it shall be fully extended.

- a) Supply the EUT with nominal voltage or install a new or fully charged battery in the EUT. Turn ON the EUT and couple its output to a frequency counter or other frequency-measuring instrument.
NOTE—An instrument that has an adequate level of accuracy as specified by the procuring or regulatory agency is the recommended measuring instrument.
- b) Tune the EUT to one of the number of frequencies required in 5.6. Adjust the location of the measurement antenna and the controls on the measurement instrument to obtain a suitable signal level (i.e., a level that will not overload the measurement instrument but is strong enough to allow measurement of the operating or fundamental frequency of the EUT).
- c) Measure the frequency at each of the frequencies specified in 5.6.
- d) Repeat the above procedure at 85% and 115% of the nominal supply voltage as described in 5.13.

4.4.4 Test Result

Serial Number:	2OCI-2	Test Date:	2024/7/24
Test Site:	RF	Test Mode:	Transmitting
Tester:	Leesin Xiang	Test Result:	Pass

Environmental Conditions:					
Temperature: (°C)	29.3	Relative Humidity: (%)	38	ATM Pressure: (kPa)	99.9

Test Equipment List and Details:

Manufacturer	Description	Model	Serial Number	Calibration Date	Calibration Due Date
EMCO	Passive Loop Antenna	6512	9706-1206	2023/10/21	2026/10/20
Unknown	Coaxial Cable	C-NJNJ-50	C-1000-01	2023/8/1	2024/7/31
Sonoma	Amplifier	310N	185914	2023/8/1	2024/7/31
R&S	EMI Test Receiver	ESCI	100224	2023/8/18	2024/8/17
BACL	TEMP&HUMI Test Chamber	BTH-150-40	30173	2023/10/18	2024/10/17
All-sun	Clamp Meter	EM305A	8348897	2023/8/3	2024/8/2
TDK-Lambda	DC Power Supply	Z+60-14	F-08-EM038-1	N/A	N/A

* *Statement of Traceability:* China Certification ICT Co., Ltd (Dongguan) attests that all calibrations have been performed, traceable to National Primary Standards and International System of Units (SI).

Test Data:

f ₀ = 13.56 MHz				
Temperature	Voltage	Measured frequency	Frequency Error	Limit
°C	V _{DC}	MHz	Hz	Hz
-30	3.87	13.55997	-30	±1356
-20		13.55994	-60	±1356
-10		13.55995	-50	±1356
0		13.55993	-70	±1356
10		13.55992	-80	±1356
20		13.55996	-40	±1356
30		13.55999	-10	±1356
40		13.55991	-90	±1356
50		13.55998	-20	±1356
20		3.45	13.55997	-30
20	4.45	13.55992	-80	±1356

Note: the voltage range was declared by manufacturer.

4.5 Antenna Requirement

4.5.1 Applicable Standard

FCC §15.203

An intentional radiator shall be designed to ensure that no antenna other than that furnished by the responsible party shall be used with the device. The use of a permanently attached antenna or of an antenna that uses a unique coupling to the intentional radiator shall be considered sufficient to comply with the provisions of this section. The manufacturer may design the unit so that a broken antenna can be replaced by the user, but the use of a standard antenna jack or electrical connector is prohibited. This requirement does not apply to carrier current devices or to devices operated under the provisions of §§15.211, 15.213, 15.217, 15.219, 15.221, or §15.236. Further, this requirement does not apply to intentional radiators that must be professionally installed, such as perimeter protection systems and some field disturbance sensors, or to other intentional radiators which, in accordance with §15.31(d), must be measured at the installation site. However, the installer shall be responsible for ensuring that the proper antenna is employed so that the limits in this part are not exceeded.

4.5.2 Judgment

Please refer to the Antenna Information detail in Section 1.3.

APPENDIX A - EUT PHOTOGRAPHS

Please refer to the attachment 2402V85515E-RF-EXP EUT external photographs and 2402V85515E-RF-INP EUT internal photographs.

APPENDIX B - TEST SETUP PHOTOGRAPHS

Please refer to the attachment 2402V85515E-RF-00H-TSP test setup photographs.

APPENDIX C - RF EXPOSURE EVALUATION

Applicable Standard

According to KDB447498 D01 General RF Exposure Guidance v06: 4.3. General SAR test exclusion guidance

c) For frequencies below 100 MHz, the following may be considered for SAR test exclusion (also illustrated in Appendix C):

- 1) For *test separation distances* > 50 mm and < 200 mm, the power threshold at the corresponding test separation distance at 100 MHz in step b) is multiplied by $[1 + \log(100/f_{\text{(MHz)}})]$
- 2) For *test separation distances* ≤ 50 mm, the power threshold determined by the equation in c) 1) for 50 mm and 100 MHz is multiplied by $\frac{1}{2}$
- 3) SAR measurement procedures are not established below 100 MHz

Measurement Result:

For NFC, the power of EUT: E Field@3m is 53.00 dBuV/m = -42.2dBm (0.0001mW)

Note: $E[\text{dB}\mu\text{V}/\text{m}] = \text{EIRP}[\text{dBm}] + 95.2$ for $d = 3$ m.

SAR test exclusion threshold for NFC(13.56MHz) separation distance < 50 mm

$$=[474*(1 + \log(100/f_{\text{(MHz)}}))]/2$$

$$= 443\text{mW}$$

$$>0.0001\text{mW}$$

Result: Compliant.

******* END OF REPORT *******