



FCC PART 27
FCC PART 22H, PART 24E
TEST REPORT

For

TECNO MOBILE LIMITED

FLAT 39 8/F BLOCK D WAH LOK INDUSTRIAL CENTRE 31-35 SHAN MEI STREET
FOTAN NT Hong Kong

FCC ID: 2ADYY-KG8

Report Type: Original Report	Product Type: Mobile Phone
Report Number: <u>SZ1210723-30705E-RF-00D</u>	
Report Date: <u>2021-08-18</u>	
Reviewed By: RF Engineer	<i>Jimmy Xiao</i>
Prepared By: Bay Area Compliance Laboratories Corp. (Shenzhen) 5F(B-West) ,6F,7F,the 3rd Phase of Wan Li Industrial Building D,Shihua Rd, FuTian Free Trade Zone, Shenzhen, China Tel: +86-755-33320018 Fax: +86-755-33320008 www.baclcorp.com.cn	

Note: This report may contain data that are not covered by the A2LA accreditation and are marked with an asterisk “★”.

BACL is not responsible for the authenticity of any test data provided by the applicant. Data included from the applicant that may affect test results are marked with an asterisk “*”. Customer model name, addresses, names, trademarks etc. are not considered data.

This report cannot be reproduced except in full, without prior written approval of the Company. Unless otherwise stated the results shown in this test report refer only to the sample(s) tested. This report is valid only with a valid digital signature. The digital signature may be available only under the Adobe software above version 7.0.

TABLE OF CONTENTS

GENERAL INFORMATION.....	3
PRODUCT DESCRIPTION FOR EQUIPMENT UNDER TEST (EUT).....	3
OBJECTIVE.....	3
TEST METHODOLOGY.....	4
MEASUREMENT UNCERTAINTY.....	4
TEST FACILITY.....	4
SYSTEM TEST CONFIGURATION.....	5
DESCRIPTION OF TEST CONFIGURATION.....	5
EQUIPMENT MODIFICATIONS.....	6
SUPPORT EQUIPMENT LIST AND DETAILS.....	6
SUPPORT CABLE DESCRIPTION.....	6
BLOCK DIAGRAM OF TEST SETUP.....	7
SUMMARY OF TEST RESULTS.....	8
TEST EQUIPMENT LIST.....	9
FCC §1.1307(B) & §2.1093 - RF EXPOSURE INFORMATION.....	11
APPLICABLE STANDARD.....	11
TEST RESULT.....	11
FCC §2.1047 - MODULATION CHARACTERISTIC.....	12
FCC § 2.1046, § 22.913 (A) & § 24.232 (C); §27.50 (C) (D) (H) - RF OUTPUT POWER.....	13
APPLICABLE STANDARD.....	13
TEST PROCEDURE.....	13
TEST DATA.....	13
FCC §2.1049, §22.917, §22.905 & §24.238 & §27.53 - OCCUPIED BANDWIDTH.....	45
APPLICABLE STANDARD.....	45
TEST PROCEDURE.....	45
TEST DATA.....	45
FCC §2.1051, §22.917(A) & §24.238(A); §27.53 - SPURIOUS EMISSIONS AT ANTENNA TERMINALS.....	72
APPLICABLE STANDARD.....	72
TEST PROCEDURE.....	72
TEST DATA.....	72
FCC § 2.1053; § 22.917 (A);§ 24.238 (A); §27.53 SPURIOUS RADIATED EMISSIONS.....	90
APPLICABLE STANDARD.....	90
TEST PROCEDURE.....	90
TEST DATA.....	90
FCC § 22.917 (A);§ 24.238 (A); §27.53(C) (H)(M) - BAND EDGES.....	103
APPLICABLE STANDARD.....	103
TEST PROCEDURE.....	103
TEST DATA.....	103
FCC § 2.1055; § 22.355; § 24.235; §27.54 - FREQUENCY STABILITY.....	117
APPLICABLE STANDARD.....	117
TEST PROCEDURE.....	117
TEST DATA.....	118

GENERAL INFORMATION

Product Description for Equipment under Test (EUT)

Product	Mobile Phone
Tested Model	KG8
Frequency Range	GSM 850: 824-849MHz(TX); 869-894MHz(RX) PCS 1900: 1850-1910MHz(TX); 1930-1990MHz(RX) WCDMA Band 2: 1850-1910MHz(TX); 1930-1990MHz(RX) WCDMA Band 4: 1710-1755MHz(TX); 2110-2155MHz(RX) WCDMA Band 5: 824-849MHz(TX); 869-894MHz(RX) LTE Band 2: 1850-1910MHz(TX); 1930-1990MHz(RX) LTE Band 4: 1710-1755MHz(TX); 2110-2155MHz(RX) LTE Band 5: 824-849MHz(TX); 869-894MHz(RX) LTE Band 7: 2500-2570MHz(TX); 2620-2690MHz(RX) LTE Band 17: 704-716MHz(TX); 734-746MHz(RX) LTE Band 38: 2570-2620MHz(TX/RX) LTE Band 41: 2535-2655MHz(TX/RX) LTE Band 66: 1710-1780MHz(TX); 2110-2180MHz(RX)
Modulation Technique	2G: GMSK, 8PSK 3G: BPSK, QPSK, 16QAM 4G: QPSK, 16QAM
Antenna Specification*	GSM850/WCDMA Band 5/LTE Band 5: -3.86dBi PCS1900/WCDMA Band 2/ LTE Band 2: -0.16dBi WCDMA Band 4/ LTE Band 4/LTE Band 66: 0.37dBi LTE Band 7/LTE Band 38/LTE Band 41: 0.11dBi LTE Band 17: -5.9dBi (provided by the applicant)
Voltage Range	DC 3.87V from battery or DC 5.0V/10.0V from adapter
Date of Test	2021-07-29 to 2021-08-18
Sample number	SZ1210723-30705E-RF-S1(RF Conducted Test), SZ1210723-30705E-RF-S4(RF Radiated Test) (Assigned by BAACL, Shenzhen)
Received date	2021-07-23
Sample/EUT Status	Good condition
Adapter information	Model: U330TSA Input: AC 100-240V ~ 50/60Hz, 1.5A Output: DC 5.0V, 3.0A 15.0W or 10.0V, 3.3A 33.0W MAX

Objective

This test report is in accordance with Part 2-Subpart J, Part 22-Subpart H and Part 24-Subpart E and Subpart 27 of the Federal Communication Commissions rules.

The objective is to determine the compliance of the EUT with FCC rules for output power, modulation characteristic, occupied bandwidth, and spurious emission at antenna terminal, spurious radiated emission, frequency stability and band edge.

Test Methodology

All tests and measurements indicated in this document were performed in accordance with the Code of Federal Regulations Title 47 Part 2-Subpart J as well as the following parts:

Part 22 Subpart H - Public Mobile Services
 Part 24 Subpart E - Personal Communication Services
 Part 27 – Miscellaneous wireless communications services

ANSI C63.26-2015: American National Standard for Compliance Testing of Transmitters Used in Licensed Radio Services

All emissions measurement was performed at Bay Area Compliance Laboratories Corp. (Shenzhen). The radiated testing was performed at an antenna-to-EUT distance of 3 meters. Each test item follows test standards and with no deviation.

Measurement Uncertainty

Parameter		Uncertainty
Occupied Channel Bandwidth		±5%
RF output power, conducted		±0.73dB
Unwanted Emission, conducted		±1.6dB
Emissions, Radiated	Below 1GHz	±4.75dB
	Above 1GHz	±4.88dB
Temperature		±1°C
Humidity		±6%
Supply voltages		±0.4%

Note: The extended uncertainty given in this report is obtained by combining the standard uncertainty times the coverage factor K with the 95% confidence interval. Otherwise required by the applicant or Product Regulations, Decision Rule in this report did not consider the uncertainty.

Test Facility

The Test site used by Bay Area Compliance Laboratories Corp. (Shenzhen) to collect test data is located on the 5F(B-West) ,6F,7F,the 3rd Phase of Wan Li Industrial Building D,Shihua Rd, FuTian Free Trade Zone, Shenzhen, China.

The test site has been approved by the FCC under the KDB 974614 D01 and is listed in the FCC Public Access Link (PAL) database, FCC Registration No.: 342867, the FCC Designation No.: CN1221.

The test site has been registered with ISED Canada under ISED Canada Registration Number 3062B.

SYSTEM TEST CONFIGURATION

Description of Test Configuration

The final qualification test was performed with the EUT operating at normal mode.

Test was performed as below table:

Frequency band	Bandwidth (MHz)	Test Frequency(MHz)		
		Low	Middle	High
GSM850	0.25	824.2	836.6	848.8
PCS1900	0.25	1850.2	1880	1909.8
WCDMA B2	4.2	1852.4	1880	1907.6
WCDMA B4	4.2	1712.4	1732.6	1752.6
WCDMA B5	4.2	826.4	836.6	846.6
LTE B2	1.4	1850.7	1880	1909.3
	3	1851.5	1880	1908.5
	5	1852.5	1880	1907.5
	10	1855	1880	1905
	15	1857.5	1880	1902.5
	20	1860	1880	1900
LTE B4	1.4	1710.7	1732.5	1754.3
	3	1711.5	1732.5	1753.5
	5	1712.5	1732.5	1752.5
	10	1715	1732.5	1750
	15	1717.5	1732.5	1747.5
	20	1720	1732.5	1745
LTE B5	1.4	824.7	836.5	848.3
	3	825.5	836.5	847.5
	5	826.5	836.5	846.5
	10	829	836.5	844
LTE B7	5	2502.5	2535	2567.5
	10	2505	2535	2565
	15	2507.5	2535	2562.5
	20	2510	2535	2560
LTE B17	5	706.5	710	713.5
	10	709	710	711

Frequency band	Bandwidth (MHz)	Test Frequency(MHz)		
		Low	Middle	High
LTE B38	5	2572.5	2595	2617.5
	10	2575	2595	2615
	15	2577.5	2595	2612.5
	20	2580	2595	2610
LTE B41	5	2537.5	2595	2652.5
	10	2540	2595	2650
	15	2542.5	2595	2647.5
	20	2545	2595	2645
LTE B66	1.4	1710.7	1745	1779.3
	3	1711.5	1745	1778.5
	5	1712.5	1745	1777.5
	10	1715	1745	1775
	15	1717.5	1745	1772.5
	20	1720	1745	1770

Equipment Modifications

No modification was made to the EUT.

Support Equipment List and Details

Manufacturer	Description	Model	Serial Number
Rohde & Schwarz	Wideband Radio Communication Tester	CMW500	1201.002K50-116218-UY
Rohde & Schwarz	Universal Radio Communication Tester	CMU200	110605

Support Cable Description

Cable Description	Length (m)	From / Port	To
Un-Shielded Detachable AC Cable	1.2	AC Power	CMW500/ CMU200

Block Diagram of Test Setup

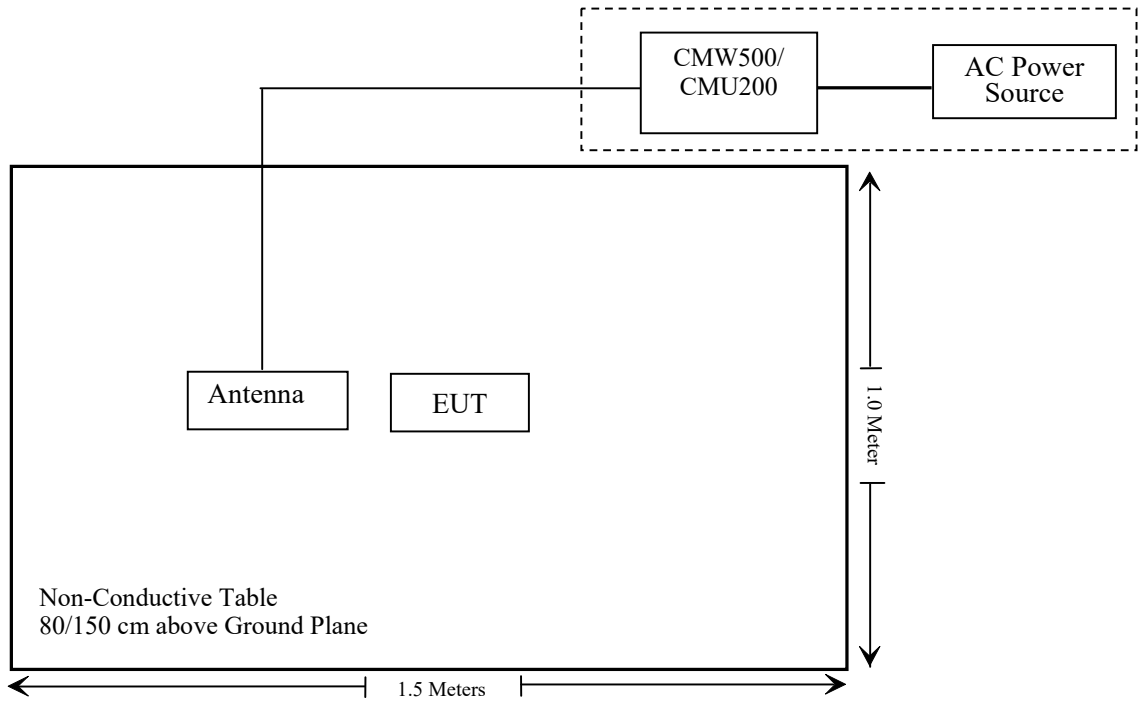

SUMMARY OF TEST RESULTS

FCC Rules	Description of Test	Result
§ 1.1307 , §2.1093	RF Exposure (SAR)	Compliant*
§2.1046; § 22.913 (a); § 24.232 (c); §27.50 (c) (d) (h)	RF Output Power	Compliant
§ 2.1047	Modulation Characteristics	Not Applicable
§ 2.1049; § 22.905; § 22.917; § 24.238; §27.53	Occupied Bandwidth	Compliant
§ 2.1051; § 22.917 (a); § 24.238 (a); §27.53	Spurious Emissions at Antenna Terminal	Compliant
§ 2.1053; § 22.917 (a); § 24.238 (a); §27.53	Field Strength of Spurious Radiation	Compliant
§ 22.917 (a); § 24.238 (a); §27.53(c)(h) (m)	Band Edge	Compliant
§ 2.1055; § 22.355; § 24.235; §27.54;	Frequency stability	Compliant

Note: * Please refer to SAR report released by BACL, report number: SZ1210723-30705E-SA.

TEST EQUIPMENT LIST

Manufacturer	Description	Model	Serial Number	Calibration Date	Calibration Due Date
Radiated Emission Test					
R&S	EMI Test Receiver	ESR3	102455	2021/07/06	2022/07/05
Sonoma instrument	Pre-amplifier	310 N	186238	2020/08/04	2021/08/03
Sunol Sciences	Broadband Antenna	JB1	A040904-2	2020/12/22	2023/12/21
COM-POWER	Dipole Antenna	AD-100	721027	NCR	NCR
Unknown	Cable 2	RF Cable 2	F-03-EM197	2020/11/29	2021/11/28
Unknown	Cable	Chamber Cable 1	F-03-EM236	2020/11/29	2021/11/28
Rohde & Schwarz	Spectrum Analyzer	FSV40-N	102259	2021/07/06	2022/07/05
COM-POWER	Pre-amplifier	PA-122	181919	2020/11/29	2021/11/28
Quinstar	Amplifier	QLW-18405536-J0	15964001002	2020/11/29	2021/11/28
Sunol Sciences	Horn Antenna	3115	9107-3694	2021/01/15	2024/01/14
A.H.System	Horn Antenna	SAS-200/571	135	2018/09/01	2021/08/31
Insulted Wire Inc.	RF Cable	SPS-2503-3150	02222010	2020/11/29	2021/11/28
Unknown	RF Cable	W1101-EQ1 OUT	F-19-EM005	2020/11/29	2021/11/28
MICRO-TRONICS	Passband filter	HPM50111	F-19-EM006	2021/04/20	2022/04/19
Unknown	High Pass filter	1.3GHz	101120	2021/04/20	2022/04/19
Ducommun Technologies	Horn antenna	ARH-4223-02	1007726-01 1304	2020/12/06	2023/12/05
Ducommun Technologies	Horn antenna	ARH-4223-02	1007726-02 1304	2020/12/06	2023/12/05
Agilent	Signal Generator	N5183A	MY51040755	2020/12/29	2021/12/28
Rohde & Schwarz	Wideband Radio Communication Tester	CMW500	1201.002K50-146520-wh	2020/08/04	2021/08/03
Rohde & Schwarz	Universal Radio Communication Tester	CMU200	115500	2021/07/06	2022/07/05

Manufacturer	Description	Model	Serial Number	Calibration Date	Calibration Due Date
RF Conducted Test					
Rohde & Schwarz	Signal and Spectrum Analyzer	FSV40	101473	2021/07/06	2022/07/05
Rohde & Schwarz	Wideband Radio Communication Tester	CMW500	1201.002K50-146520-wh	2021/07/06	2022/07/05
Unknown	RF Cable	Unknown	2301 276	2020/11/29	2021/11/28
Unknown	RF Cable	Unknown	DLO J5/W6102	2020/11/29	2021/11/28
Weinschel	Power divider	1515	MY628	2020/11/29	2021/11/28
Rohde & Schwarz	Universal Radio Communication Tester	CMU200	115500	2021/07/06	2022/07/05
instek	DC Power Supply	GPS-3030DD	EM832096	NCR	NCR
ESPEC	Temperature & Humidity Chamber	EL-10KA	9107726	2021/02/23	2022/02/22
Fluke	Digital Multimeter	287	19000011	2021/02/22	2022/02/21

* Statement of Traceability: Bay Area Compliance Laboratories Corp. (Shenzhen) attests that all calibrations have been performed in accordance to requirements that traceable to National Primary Standards and International System of Units (SI).

FCC §1.1307(b) & §2.1093 - RF EXPOSURE INFORMATION

Applicable Standard

FCC§1.1310 and §2.1093.

Test Result

Compliance, please refer to the SAR report: SZ1210723-30705E-SA.

FCC §2.1047 - MODULATION CHARACTERISTIC

According to FCC § 2.1047(d), Part 22H & 24E & 27 there is no specific requirement for digital modulation, therefore modulation characteristic is not presented.

FCC § 2.1046, § 22.913 (a) & § 24.232 (c); §27.50 (c) (d) (h) - RF OUTPUT POWER

Applicable Standard

According to FCC §2.1046 and §22.913 (a), the ERP of mobile transmitters and auxiliary test transmitters must not exceed 7 watts.

According to FCC §2.1046 and §24.232 (C), mobile and portable stations are limited to 2 watts EIRP and the equipment must employ a means for limiting power to the minimum necessary for successful communications.

The peak-to-average power ratio (PAPR) of the transmitter output power must not exceed 13 dB.

According to §27.50(c), Portable stations (hand-held devices) in the 600 MHz uplink band and the 698-746 MHz band, and fixed and mobile stations in the 600 MHz uplink band are limited to 3 watts ERP.

According to §27.50(d), the maximum EIRP must not exceed 1Watts (30dBm) for 1710-1780MHz.

According to §27.50(h), the maximum EIRP must not exceed 2Watts (33dBm) for 2500-2570MHz & 2496-2690MHz.

Test Procedure

Conducted method:

The RF output of the transmitter was connected to the CMW500/CMU200 through sufficient attenuation.

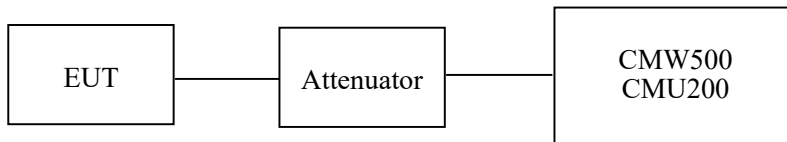

Test Data

Environmental Conditions

Temperature:	28.5~29.2 °C
Relative Humidity:	51~53 %
ATM Pressure:	101.0 kPa

The testing was performed by Pedro Yun from 2021-08-06 to 2021-08-18.

Conducted Power

Cellular Band (Part 22H)

Mode	Channel	Frequency (MHz)	Average Output Power (dBm)	ERP (dBm)	Limit (dBm)
GSM	128	824.2	33.40	27.39	38.45
	190	836.6	33.50	27.49	38.45
	251	848.8	33.60	27.59	38.45

Mode	Channel	Frequency (MHz)	Average Output Power (dBm)				ERP(dBm)				Limit (dBm)
			1 slot	2 slots	3 slots	4 slots	1 slot	2 slots	3 slots	4 slots	
GPRS	128	824.2	32.92	31.87	29.72	28.45	26.91	25.86	23.71	22.44	38.45
	190	836.6	33.03	31.93	29.78	28.54	27.02	25.92	23.77	22.53	38.45
	251	848.8	33.11	32.07	29.94	28.71	27.10	26.06	23.93	22.70	38.45

Mode	Channel	Frequency (MHz)	Average Output Power (dBm)				ERP(dBm)				Limit (dBm)
			1 slot	2 slots	3 slots	4 slots	1 slot	2 slots	3 slots	4 slots	
EGPRS	128	824.2	27.17	25.73	23.32	21.75	21.16	19.72	17.31	15.74	38.45
	190	836.6	27.04	25.61	23.12	21.60	21.03	19.60	17.11	15.59	38.45
	251	848.8	26.72	25.31	23.01	21.41	20.71	19.30	17.00	15.40	38.45

Mode	Test Mode	3GPP Sub Test	Average Output Power (dBm)			ERP(dBm)		
			Low	Mid	High	Low	Mid	High
WCDMA (Band 5)	RMC12.2k		23.20	23.25	23.46	17.19	17.24	17.45
	HSDPA	1	22.16	22.22	22.42	16.15	16.21	16.41
		2	22.18	22.25	22.44	16.17	16.24	16.43
		3	22.24	22.28	22.48	16.23	16.27	16.47
		4	22.29	22.35	22.52	16.28	16.34	16.51
	HSUPA	1	22.78	22.86	23.02	16.77	16.85	17.01
		2	22.84	22.92	23.08	16.83	16.91	17.07
		3	22.88	23.00	23.14	16.87	16.99	17.13
		4	22.94	23.08	23.20	16.93	17.07	17.19
		5	22.96	23.10	23.25	16.95	17.09	17.24
HSPA+	1	22.99	23.17	23.31	16.98	17.16	17.30	

Note: ERP(dBm) = Conducted Power(dBm) + Antenna Gain(dBd)
 For GSM850/WCDMA Band 5: Antenna Gain = -3.86dBi = -6.01dBd (0dBd=2.15dBi)
 The limit: ERP ≤ 38.45dBm

PCS Band (Part 24E)

Mode	Channel	Frequency (MHz)	Average Output Power (dBm)	EIRP(dBm)	Limit (dBm)
GSM	512	1850.2	26.60	26.44	33
	661	1880.0	26.80	26.64	33
	810	1909.8	26.90	26.74	33

Mode	Channel	Frequency (MHz)	Average Output Power (dBm)				EIRP(dBm)				Limit (dBm)
			1 slot	2 slots	3 slots	4 slots	1 slot	2 slots	3 slots	4 slots	
GPRS	512	1850.2	26.50	26.04	25.37	24.12	26.34	25.88	25.21	23.96	33
	661	1880.0	26.76	26.01	25.12	24.98	26.60	25.85	24.96	24.82	33
	810	1909.8	26.82	26.54	25.68	25.25	26.66	26.38	25.52	25.09	33

Mode	Channel	Frequency (MHz)	Average Output Power (dBm)				EIRP(dBm)				Limit (dBm)
			1 slot	2 slots	3 slots	4 slots	1 slot	2 slots	3 slots	4 slots	
EGPRS	512	1850.2	25.98	25.12	23.11	21.97	25.82	24.96	22.95	21.81	33
	661	1880.0	25.68	24.59	23.08	21.98	25.52	24.43	22.92	21.82	33
	810	1909.8	25.19	24.23	23.25	22.01	25.03	24.07	23.09	21.85	33

Mode	Test Mode	3GPP Sub Test	Average Output Power (dBm)			EIRP(dBm)		
			Low	Mid	High	Low	Mid	High
WCDMA (Band 2)	RMC12.2k		16.82	16.60	16.22	16.66	16.44	16.06
	HSDPA	1	15.73	15.47	15.12	15.57	15.31	14.96
		2	15.80	15.52	15.19	15.64	15.36	15.03
		3	15.85	15.59	15.23	15.69	15.43	15.07
		4	15.88	15.62	15.30	15.72	15.46	15.14
	HSUPA	1	16.33	16.10	15.81	16.17	15.94	15.65
		2	16.40	16.15	15.87	16.24	15.99	15.71
		3	16.45	16.17	15.94	16.29	16.01	15.78
		4	16.49	16.20	15.97	16.33	16.04	15.81
		5	16.56	16.24	16.03	16.40	16.08	15.87
HSPA+	1	16.63	16.31	16.09	16.47	16.15	15.93	

Note: EIRP(dBm) = Conducted Power(dBm) + Antenna Gain(dBi)
 For PCS1900/WCDMA Band 2: Antenna Gain = -0.16dBi
 The limit: EIRP ≤ 33dBm

AWS Band (Part 27)

Mode	Test Mode	3GPP Sub Test	Average Output Power (dBm)			EIRP(dBm)		
			Low	Mid	High	Low	Mid	High
WCDMA (Band 4)	RMC12.2k		15.89	15.68	15.40	16.26	16.05	15.77
	HSDPA	1	14.73	14.61	14.28	15.10	14.98	14.65
		2	14.80	14.63	14.36	15.17	15.00	14.73
		3	14.86	14.66	14.38	15.23	15.03	14.75
		4	14.91	14.71	14.40	15.28	15.08	14.77
	HSUPA	1	15.47	15.24	14.89	15.84	15.61	15.26
		2	15.52	15.27	14.92	15.89	15.64	15.29
		3	15.57	15.30	14.97	15.94	15.67	15.34
		4	15.61	15.35	15.00	15.98	15.72	15.37
		5	15.66	15.37	15.04	16.03	15.74	15.41
	HSPA+	1	15.72	15.45	15.08	16.09	15.82	15.45

Note: EIRP(dBm) = Conducted Power(dBm) + Antenna Gain(dBi)
 For WCDMA Band 4: Antenna Gain = 0.37dBi
 The limit: EIRP ≤ 30dBm

Peak-to-average ratio (PAR)

Cellular Band

Mode	Channel	PAR (dB)	Limit (dB)
GSM	Low	3.16	13
	Middle	3.15	13
	High	3.27	13

Mode	Channel	PAR (dB)	Limit (dB)
EGPRS	Low	3.18	13
	Middle	3.36	13
	High	3.24	13

Mode	Channel	PAR (dB)	Limit (dB)
RMC (BPSK)	Low	3.48	13
	Middle	3.32	13
	High	3.48	13
HSDPA (16QAM)	Low	3.46	13
	Middle	3.29	13
	High	3.37	13
HSUPA (BPSK)	Low	3.17	13
	Middle	3.22	13
	High	3.43	13
HSPA+	Low	3.51	13
	Middle	3.41	13
	High	3.36	13

PCS Band

Mode	Channel	PAR (dB)	Limit (dB)
GSM	Low	3.15	13
	Middle	3.12	13
	High	3.36	13

Mode	Channel	PAR (dB)	Limit (dB)
EGPRS	Low	3.32	13
	Middle	3.14	13
	High	3.35	13

Mode	Channel	PAR (dB)	Limit (dB)
RMC (BPSK)	Low	3.57	13
	Middle	3.64	13
	High	3.72	13
HSDPA (16QAM)	Low	3.26	13
	Middle	3.25	13
	High	3.21	13
HSUPA (BPSK)	Low	3.35	13
	Middle	3.78	13
	High	3.25	13
HSPA+	Low	3.36	13
	Middle	3.39	13
	High	3.42	13

AWS Band

Mode	Channel	PAR (dB)	Limit (dB)
RMC (BPSK)	Low	3.25	13
	Middle	3.24	13
	High	3.56	13
HSDPA (16QAM)	Low	3.37	13
	Middle	3.46	13
	High	3.62	13
HSUPA (BPSK)	Low	3.18	13
	Middle	3.47	13
	High	3.35	13
HSPA+	Low	3.37	13
	Middle	3.44	13
	High	3.31	13

LTE Band 2:

Maximum Output Power

Bandwidth (MHz)	Modulation	RB size/ RB Offset	Conducted Average Output Power (dBm)			EIRP(dBm)		
			Low	Mid	High	Low	Mid	High
1.4	QPSK	RB1#0	14.71	14.60	14.68	14.55	14.44	14.52
		RB1#3	14.80	14.78	14.78	14.64	14.62	14.62
		RB1#5	14.60	14.57	14.68	14.44	14.41	14.52
		RB3#0	14.75	14.71	14.77	14.59	14.55	14.61
		RB3#3	14.79	14.68	14.76	14.63	14.52	14.60
		RB6#0	13.72	13.62	13.74	13.56	13.46	13.58
	16QAM	RB1#0	13.70	13.60	13.79	13.54	13.44	13.63
		RB1#3	13.90	13.81	13.95	13.74	13.65	13.79
		RB1#5	13.71	13.62	13.83	13.55	13.46	13.67
		RB3#0	13.88	13.89	13.71	13.72	13.73	13.55
		RB3#3	13.84	13.89	13.77	13.68	13.73	13.61
		RB6#0	12.69	12.65	12.79	12.53	12.49	12.63
3.0	QPSK	RB1#0	14.70	14.67	14.70	14.54	14.51	14.54
		RB1#8	14.68	14.63	14.70	14.52	14.47	14.54
		RB1#14	14.66	14.65	14.71	14.50	14.49	14.55
		RB6#0	13.65	13.58	13.68	13.49	13.42	13.52
		RB6#9	13.62	13.60	13.68	13.46	13.44	13.52
		RB15#0	13.69	13.61	13.72	13.53	13.45	13.56
	16QAM	RB1#0	14.37	13.81	13.74	14.21	13.65	13.58
		RB1#8	14.28	13.77	13.68	14.12	13.61	13.52
		RB1#14	14.31	13.77	13.74	14.15	13.61	13.58
		RB6#0	12.76	12.57	12.64	12.60	12.41	12.48
		RB6#9	12.72	12.60	12.61	12.56	12.44	12.45
		RB15#0	12.77	12.57	12.77	12.61	12.41	12.61

Bandwidth (MHz)	Modulation	RB size/ RB Offset	Conducted Average Output Power (dBm)			EIRP(dBm)		
			Low	Mid	High	Low	Mid	High
5.0	QPSK	RB1#0	14.70	14.64	14.69	14.54	14.48	14.53
		RB1#13	14.76	14.64	14.74	14.60	14.48	14.58
		RB1#24	14.71	14.65	14.73	14.55	14.49	14.57
		RB15#0	13.74	13.68	13.79	13.58	13.52	13.63
		RB15#10	13.70	13.65	13.71	13.54	13.49	13.55
		RB25#0	13.71	13.64	13.71	13.55	13.48	13.55
	16QAM	RB1#0	13.63	13.95	13.79	13.47	13.79	13.63
		RB1#13	13.62	13.96	13.81	13.46	13.80	13.65
		RB1#24	13.61	13.95	13.77	13.45	13.79	13.61
		RB15#0	12.79	12.64	12.82	12.63	12.48	12.66
		RB15#10	12.76	12.62	12.76	12.60	12.46	12.60
		RB25#0	12.75	12.62	12.71	12.59	12.46	12.55
10.0	QPSK	RB1#0	14.70	14.65	14.69	14.54	14.49	14.53
		RB1#25	14.79	14.70	14.84	14.63	14.54	14.68
		RB1#49	14.66	14.59	14.69	14.50	14.43	14.53
		RB25#0	13.73	13.71	13.83	13.57	13.55	13.67
		RB25#25	13.75	13.62	13.69	13.59	13.46	13.53
		RB50#0	13.74	13.65	13.77	13.58	13.49	13.61
	16QAM	RB1#0	14.30	13.79	13.71	14.14	13.63	13.55
		RB1#25	14.35	13.89	13.84	14.19	13.73	13.68
		RB1#49	14.28	13.75	13.74	14.12	13.59	13.58
		RB25#0	12.76	12.76	12.91	12.60	12.60	12.75
		RB25#25	12.83	12.64	12.78	12.67	12.48	12.62
		RB50#0	12.78	12.70	12.80	12.62	12.54	12.64

Bandwidth (MHz)	Modulation	RB size/ RB Offset	Conducted Average Output Power (dBm)			EIRP(dBm)		
			Low	Mid	High	Low	Mid	High
15.0	QPSK	RB1#0	14.63	14.64	14.57	14.47	14.48	14.41
		RB1#38	14.61	14.63	14.63	14.45	14.47	14.47
		RB1#74	14.56	14.59	14.67	14.40	14.43	14.51
		RB36#0	13.75	13.69	13.73	13.59	13.53	13.57
		RB36#39	13.66	13.66	13.69	13.50	13.50	13.53
		RB75#0	13.67	13.66	13.69	13.51	13.50	13.53
	16QAM	RB1#0	14.26	13.77	13.99	14.10	13.61	13.83
		RB1#38	14.24	13.76	14.06	14.08	13.60	13.90
		RB1#74	14.21	13.75	14.07	14.05	13.59	13.91
		RB36#0	12.72	12.70	12.67	12.56	12.54	12.51
		RB36#39	12.61	12.60	12.65	12.45	12.44	12.49
		RB75#0	12.70	12.64	12.66	12.54	12.48	12.50
20.0	QPSK	RB1#0	14.57	14.55	14.47	14.41	14.39	14.31
		RB1#50	14.83	14.82	14.66	14.67	14.66	14.50
		RB1#99	14.54	14.53	14.58	14.38	14.37	14.42
		RB50#0	13.72	13.80	13.78	13.56	13.64	13.62
		RB50#50	13.68	13.72	13.60	13.52	13.56	13.44
		RB100#0	13.75	13.74	13.71	13.59	13.58	13.55
	16QAM	RB1#0	13.92	13.79	14.05	13.76	13.63	13.89
		RB1#50	14.15	14.01	14.31	13.99	13.85	14.15
		RB1#99	13.84	13.73	14.16	13.68	13.57	14.00
		RB50#0	12.72	12.80	12.80	12.56	12.64	12.64
		RB50#50	12.65	12.72	12.63	12.49	12.56	12.47
		RB100#0	12.79	12.77	12.75	12.63	12.61	12.59

Note: EIRP(dBm) = Conducted Power(dBm) + Antenna Gain(dBi)
 For LTE Band2: Antenna Gain = -0.16dBi
 The Limit: EIRP ≤ 33dBm

Peak-to-average ratio (PAR)**20MHz Bandwidth**

Modulation	Low channel (dB)	Middle channel (dB)	High channel (dB)	PAR Limit (dB)	Result
QPSK (1RB Size)	5.93	5.38	5.54	13	Pass
QPSK (100RB Size)	5.64	5.67	5.74	13	Pass
16QAM (1RB Size)	7.12	6.15	6.57	13	Pass
16QAM (100RB Size)	6.54	6.51	6.51	13	Pass

LTE Band 4

Maximum Output Power

Bandwidth (MHz)	Modulation	RB size/ RB Offset	Conducted Average Output Power (dBm)			EIRP(dBm)		
			Low	Mid	High	Low	Mid	High
1.4	QPSK	RB1#0	16.14	16.19	16.12	16.51	16.56	16.49
		RB1#3	16.28	16.33	16.28	16.65	16.70	16.65
		RB1#5	16.12	16.18	16.08	16.49	16.55	16.45
		RB3#0	16.24	16.24	16.19	16.61	16.61	16.56
		RB3#3	16.20	16.22	16.22	16.57	16.59	16.59
		RB6#0	15.20	15.20	15.27	15.57	15.57	15.64
	16QAM	RB1#0	15.21	15.34	15.19	15.58	15.71	15.56
		RB1#3	15.23	15.45	15.38	15.60	15.82	15.75
		RB1#5	15.20	15.36	15.27	15.57	15.73	15.64
		RB3#0	15.43	15.23	15.35	15.80	15.60	15.72
		RB3#3	15.45	15.27	15.47	15.82	15.64	15.84
		RB6#0	14.23	14.25	14.12	14.60	14.62	14.49
3.0	QPSK	RB1#0	16.19	16.25	16.28	16.56	16.62	16.65
		RB1#8	16.14	16.26	16.21	16.51	16.63	16.58
		RB1#14	16.17	16.27	16.27	16.54	16.64	16.64
		RB6#0	15.20	15.20	15.28	15.57	15.57	15.65
		RB6#9	15.24	15.20	15.18	15.61	15.57	15.55
		RB15#0	15.24	15.27	15.30	15.61	15.64	15.67
	16QAM	RB1#0	15.90	15.46	15.36	16.27	15.83	15.73
		RB1#8	15.82	15.38	15.23	16.19	15.75	15.60
		RB1#14	15.88	15.44	15.29	16.25	15.81	15.66
		RB6#0	14.26	14.26	14.25	14.63	14.63	14.62
		RB6#9	14.29	14.31	14.18	14.66	14.68	14.55
		RB15#0	14.31	14.25	14.35	14.68	14.62	14.72

Bandwidth (MHz)	Modulation	RB size/ RB Offset	Conducted Average Output Power (dBm)			EIRP(dBm)		
			Low	Mid	High	Low	Mid	High
5.0	QPSK	RB1#0	16.21	16.22	16.24	16.58	16.59	16.61
		RB1#13	16.22	16.24	16.26	16.59	16.61	16.63
		RB1#24	16.18	16.22	16.21	16.55	16.59	16.58
		RB15#0	15.21	15.28	15.36	15.58	15.65	15.73
		RB15#10	15.25	15.28	15.24	15.62	15.65	15.61
		RB25#0	15.22	15.28	15.31	15.59	15.65	15.68
	16QAM	RB1#0	15.17	15.65	15.41	15.54	16.02	15.78
		RB1#13	15.14	15.60	15.39	15.51	15.97	15.76
		RB1#24	15.18	15.58	15.37	15.55	15.95	15.74
		RB15#0	14.28	14.27	14.36	14.65	14.64	14.73
		RB15#10	14.28	14.29	14.28	14.65	14.66	14.65
		RB25#0	14.26	14.30	14.35	14.63	14.67	14.72
10.0	QPSK	RB1#0	16.16	16.26	16.22	16.53	16.63	16.59
		RB1#25	16.24	16.39	16.39	16.61	16.76	16.76
		RB1#49	16.14	16.23	16.22	16.51	16.60	16.59
		RB25#0	15.23	15.32	15.35	15.60	15.69	15.72
		RB25#25	15.31	15.30	15.30	15.68	15.67	15.67
		RB50#0	15.26	15.30	15.33	15.63	15.67	15.70
	16QAM	RB1#0	15.86	15.43	15.33	16.23	15.80	15.70
		RB1#25	15.93	15.55	15.39	16.30	15.92	15.76
		RB1#49	15.90	15.43	15.27	16.27	15.80	15.64
		RB25#0	14.29	14.42	14.46	14.66	14.79	14.83
		RB25#25	14.36	14.38	14.39	14.73	14.75	14.76
		RB50#0	14.29	14.35	14.35	14.66	14.72	14.72

Bandwidth (MHz)	Modulation	RB size/ RB Offset	Conducted Average Output Power (dBm)			EIRP(dBm)		
			Low	Mid	High	Low	Mid	High
15.0	QPSK	RB1#0	16.10	16.16	16.18	16.47	16.53	16.55
		RB1#38	16.14	16.15	16.15	16.51	16.52	16.52
		RB1#74	16.19	16.21	16.19	16.56	16.58	16.56
		RB36#0	15.25	15.26	15.32	15.62	15.63	15.69
		RB36#39	15.30	15.26	15.30	15.67	15.63	15.67
		RB75#0	15.23	15.23	15.29	15.60	15.60	15.66
	16QAM	RB1#0	15.82	15.37	15.63	16.19	15.74	16.00
		RB1#38	15.83	15.35	15.69	16.20	15.72	16.06
		RB1#74	15.91	15.42	15.69	16.28	15.79	16.06
		RB36#0	14.20	14.24	14.27	14.57	14.61	14.64
		RB36#39	14.32	14.25	14.26	14.69	14.62	14.63
		RB75#0	14.26	14.27	14.25	14.63	14.64	14.62
20.0	QPSK	RB1#0	16.02	16.13	16.05	16.39	16.50	16.42
		RB1#50	16.31	16.41	16.37	16.68	16.78	16.74
		RB1#99	16.13	16.15	16.07	16.50	16.52	16.44
		RB50#0	15.22	15.29	15.38	15.59	15.66	15.75
		RB50#50	15.34	15.30	15.30	15.71	15.67	15.67
		RB100#0	15.31	15.31	15.35	15.68	15.68	15.72
	16QAM	RB1#0	15.42	15.40	15.75	15.79	15.77	16.12
		RB1#50	15.72	15.64	15.98	16.09	16.01	16.35
		RB1#99	15.50	15.44	15.78	15.87	15.81	16.15
		RB50#0	14.21	14.33	14.40	14.58	14.70	14.77
		RB50#50	14.38	14.35	14.31	14.75	14.72	14.68
		RB100#0	14.32	14.32	14.36	14.69	14.69	14.73

Note: EIRP(dBm) = Conducted Power(dBm) + Antenna Gain(dBi)
 For LTE Band 4: Antenna Gain = 0.37dBi
 The Limit: EIRP≤30dBm

Peak-to-average ratio (PAR)**20MHz Bandwidth**

Modulation	Low channel (dB)	Middle channel (dB)	High channel (dB)	PAR Limit (dB)	Result
QPSK (1RB Size)	5.42	5.61	5.48	13	Pass
QPSK (100RB Size)	5.77	5.71	5.67	13	Pass
16QAM (1RB Size)	6.60	7.08	6.12	13	Pass
16QAM (100RB Size)	6.47	6.51	6.51	13	Pass

LTE Band 5:

Maximum Output Power

Bandwidth (MHz)	Modulation	RB size/ RB Offset	Conducted Average Output Power (dBm)			ERP(dBm)		
			Low	Mid	High	Low	Mid	High
1.4	QPSK	RB1#0	22.96	23.01	23.05	16.95	17.00	17.04
		RB1#3	23.09	23.14	23.17	17.08	17.13	17.16
		RB1#5	22.97	23.00	23.05	16.96	16.99	17.04
		RB3#0	23.01	23.07	23.04	17.00	17.06	17.03
		RB3#3	22.97	23.01	23.07	16.96	17.00	17.06
		RB6#0	22.06	22.08	22.09	16.05	16.07	16.08
	16QAM	RB1#0	21.94	22.09	22.00	15.93	16.08	15.99
		RB1#3	22.05	22.21	22.16	16.04	16.20	16.15
		RB1#5	21.92	22.06	22.02	15.91	16.05	16.01
		RB3#0	22.17	21.99	22.07	16.16	15.98	16.06
		RB3#3	22.17	22.03	22.09	16.16	16.02	16.08
		RB6#0	21.05	21.08	21.09	15.04	15.07	15.08
3.0	QPSK	RB1#0	23.08	23.06	23.18	17.07	17.05	17.17
		RB1#8	23.02	23.05	23.12	17.01	17.04	17.11
		RB1#14	23.05	23.05	23.14	17.04	17.04	17.13
		RB6#0	22.07	22.06	22.02	16.06	16.05	16.01
		RB6#9	22.01	22.02	22.07	16.00	16.01	16.06
		RB15#0	22.05	22.08	22.06	16.04	16.07	16.05
	16QAM	RB1#0	22.49	22.18	22.08	16.48	16.17	16.07
		RB1#8	22.42	22.13	22.06	16.41	16.12	16.05
		RB1#14	22.50	22.20	22.06	16.49	16.19	16.05
		RB6#0	21.07	21.09	20.99	15.06	15.08	14.98
		RB6#9	21.13	21.13	21.06	15.12	15.12	15.05
		RB15#0	21.08	21.03	21.17	15.07	15.02	15.16

Bandwidth (MHz)	Modulation	RB size/ RB Offset	Conducted Average Output Power (dBm)			ERP(dBm)		
			Low	Mid	High	Low	Mid	High
5.0	QPSK	RB1#0	23.00	23.08	23.05	16.99	17.07	17.04
		RB1#13	23.10	23.10	23.12	17.09	17.09	17.11
		RB1#24	23.05	23.09	23.09	17.04	17.08	17.08
		RB15#0	22.10	22.08	22.17	16.09	16.07	16.16
		RB15#10	22.08	22.09	22.06	16.07	16.08	16.05
		RB25#0	22.05	22.08	22.07	16.04	16.07	16.06
	16QAM	RB1#0	21.92	22.33	22.07	15.91	16.32	16.06
		RB1#13	21.93	22.36	22.13	15.92	16.35	16.12
		RB1#24	21.90	22.28	22.09	15.89	16.27	16.08
		RB15#0	21.10	21.10	21.23	15.09	15.09	15.22
		RB15#10	21.15	21.12	21.12	15.14	15.11	15.11
		RB25#0	21.13	21.12	21.15	15.12	15.11	15.14
10.0	QPSK	RB1#0	23.08	23.08	23.13	17.07	17.07	17.12
		RB1#25	23.14	23.16	23.19	17.13	17.15	17.18
		RB1#49	23.07	23.06	23.14	17.06	17.05	17.13
		RB25#0	22.02	22.08	22.10	16.01	16.07	16.09
		RB25#25	22.08	22.06	21.98	16.07	16.05	15.97
		RB50#0	22.01	22.11	22.08	16.00	16.10	16.07
	16QAM	RB1#0	22.50	22.21	22.07	16.49	16.20	16.06
		RB1#25	22.67	22.24	22.09	16.66	16.23	16.08
		RB1#49	22.54	22.17	22.07	16.53	16.16	16.06
		RB25#0	21.09	21.12	21.21	15.08	15.11	15.20
		RB25#25	21.17	21.12	21.15	15.16	15.11	15.14
		RB50#0	21.09	21.11	21.15	15.08	15.10	15.14

Note: ERP(dBm) = Conducted Power(dBm) + Antenna Gain(dBd)
 For LTE Band 5: Antenna Gain = -3.86dBi = -6.01dBd (0dBd=2.15dBi)
 Limit: ERP ≤ 38.45dBm

Peak-to-average ratio (PAR)

10MHz bandwidth

Modulation	Low channel (dB)	Middle channel (dB)	High channel (dB)	PAR Limit (dB)	Result
QPSK (1RB Size)	3.30	3.91	3.43	13	Pass
QPSK (50RB Size)	5.32	5.42	5.29	13	Pass
16QAM (1RB Size)	4.01	4.81	4.65	13	Pass
16QAM (50RB Size)	6.19	6.19	6.19	13	Pass

LTE Band 7:

Maximum Output Power

Bandwidth (MHz)	Modulation	RB size/ RB Offset	Conducted Average Output Power (dBm)			EIRP(dBm)		
			Low	Mid	High	Low	Mid	High
5.0	QPSK	RB1#0	15.33	15.24	15.35	15.44	15.35	15.46
		RB1#13	15.40	15.24	15.39	15.51	15.35	15.50
		RB1#24	15.33	15.23	15.37	15.44	15.34	15.48
		RB15#0	14.31	14.24	14.44	14.42	14.35	14.55
		RB15#10	14.32	14.25	14.37	14.43	14.36	14.48
		RB25#0	14.33	14.23	14.44	14.44	14.34	14.55
	16QAM	RB1#0	14.23	14.51	14.41	14.34	14.62	14.52
		RB1#13	14.27	14.54	14.49	14.38	14.65	14.60
		RB1#24	14.23	14.51	14.46	14.34	14.62	14.57
		RB15#0	13.38	13.23	13.46	13.49	13.34	13.57
		RB15#10	13.40	13.22	13.43	13.51	13.33	13.54
		RB25#0	13.41	13.28	13.43	13.52	13.39	13.54
10.0	QPSK	RB1#0	15.30	15.26	15.35	15.41	15.37	15.46
		RB1#25	15.36	15.33	15.47	15.47	15.44	15.58
		RB1#49	15.28	15.26	15.42	15.39	15.37	15.53
		RB25#0	14.25	14.25	14.35	14.36	14.36	14.46
		RB25#25	14.31	14.23	14.45	14.42	14.34	14.56
		RB50#0	14.30	14.26	14.39	14.41	14.37	14.50
	16QAM	RB1#0	14.91	14.38	14.35	15.02	14.49	14.46
		RB1#25	15.00	14.46	14.50	15.11	14.57	14.61
		RB1#49	14.86	14.38	14.39	14.97	14.49	14.50
		RB25#0	13.32	13.26	13.43	13.43	13.37	13.54
		RB25#25	13.37	13.32	13.50	13.48	13.43	13.61
		RB50#0	13.31	13.25	13.37	13.42	13.36	13.48

Bandwidth (MHz)	Modulation	RB size/ RB Offset	Conducted Average Output Power (dBm)			EIRP(dBm)		
			Low	Mid	High	Low	Mid	High
15.0	QPSK	RB1#0	15.26	15.23	15.31	15.37	15.34	15.42
		RB1#38	15.32	15.26	15.38	15.43	15.37	15.49
		RB1#74	15.25	15.26	15.39	15.36	15.37	15.50
		RB36#0	14.30	14.28	14.38	14.41	14.39	14.49
		RB36#39	14.36	14.33	14.48	14.47	14.44	14.59
		RB75#0	14.32	14.29	14.39	14.43	14.40	14.50
	16QAM	RB1#0	14.88	14.39	14.69	14.99	14.50	14.80
		RB1#38	14.86	14.40	14.76	14.97	14.51	14.87
		RB1#74	14.85	14.39	14.78	14.96	14.50	14.89
		RB36#0	13.30	13.23	13.35	13.41	13.34	13.46
		RB36#39	13.31	13.30	13.37	13.42	13.41	13.48
		RB75#0	13.35	13.25	13.37	13.46	13.36	13.48
20.0	QPSK	RB1#0	15.18	15.17	15.09	15.29	15.28	15.20
		RB1#50	15.39	15.44	15.53	15.50	15.55	15.64
		RB1#99	15.14	15.19	15.25	15.25	15.30	15.36
		RB50#0	14.32	14.26	14.40	14.43	14.37	14.51
		RB50#50	14.35	14.35	14.43	14.46	14.46	14.54
		RB100#0	14.32	14.33	14.42	14.43	14.44	14.53
	16QAM	RB1#0	14.47	14.34	14.76	14.58	14.45	14.87
		RB1#50	14.73	14.63	15.03	14.84	14.74	15.14
		RB1#99	14.45	14.34	14.82	14.56	14.45	14.93
		RB50#0	13.33	13.25	13.42	13.44	13.36	13.53
		RB50#50	13.35	13.34	13.43	13.46	13.45	13.54
		RB100#0	13.34	13.31	13.42	13.45	13.42	13.53

Note: ERP(dBm) = Conducted Power(dBm) + Antenna Gain(dBi)
 For LTE Band 7: Antenna Gain = 0.11dBi
 Limit: EIRP ≤ 33dBm

Peak-to-average ratio (PAR)**20MHz bandwidth**

Modulation	Low channel (dB)	Middle channel (dB)	High channel (dB)	PAR Limit (dB)	Result
QPSK (1RB Size)	5.64	5.29	5.38	13	Pass
QPSK (100RB Size)	5.61	5.64	5.67	13	Pass
16QAM (1RB Size)	7.08	5.83	6.83	13	Pass
16QAM (100RB Size)	6.41	6.41	6.44	13	Pass

LTE Band 17:

Maximum Output Power

Bandwidth (MHz)	Modulation	RB size/ RB Offset	Conducted Average Output Power (dBm)			ERP(dBm)		
			Low	Mid	High	Low	Mid	High
5.0	QPSK	RB1#0	23.42	23.47	23.40	15.37	15.42	15.35
		RB1#13	23.39	23.44	23.46	15.34	15.39	15.41
		RB1#24	23.40	23.46	23.55	15.35	15.41	15.50
		RB15#0	22.51	22.54	22.59	14.46	14.49	14.54
		RB15#10	22.57	22.52	22.52	14.52	14.47	14.47
		RB25#0	22.53	22.55	22.55	14.48	14.50	14.50
	16QAM	RB1#0	22.36	22.81	22.52	14.31	14.76	14.47
		RB1#13	22.34	22.84	22.55	14.29	14.79	14.50
		RB1#24	22.41	22.81	22.51	14.36	14.76	14.46
		RB15#0	21.56	21.55	21.63	13.51	13.50	13.58
		RB15#10	21.62	21.56	21.58	13.57	13.51	13.53
		RB25#0	21.60	21.53	21.61	13.55	13.48	13.56
10.0	QPSK	RB1#0	23.46	23.46	23.45	15.41	15.41	15.40
		RB1#25	23.61	23.61	23.64	15.56	15.56	15.59
		RB1#49	23.48	23.60	23.66	15.43	15.55	15.61
		RB25#0	22.59	22.62	22.58	14.54	14.57	14.53
		RB25#25	22.60	22.58	22.52	14.55	14.53	14.47
		RB50#0	22.64	22.59	22.61	14.59	14.54	14.56
	16QAM	RB1#0	23.10	22.68	22.56	15.05	14.63	14.51
		RB1#25	23.21	22.76	22.65	15.16	14.71	14.60
		RB1#49	23.03	22.72	22.51	14.98	14.67	14.46
		RB25#0	21.71	21.65	21.74	13.66	13.60	13.69
		RB25#25	21.68	21.62	21.67	13.63	13.57	13.62
		RB50#0	21.66	21.63	21.67	13.61	13.58	13.62

Note: ERP(dBm) = Conducted Power(dBm) + Antenna Gain(dBd)
 For LTE Band17: Antenna Gain = -5.9dBi = -8.05dBd (0dBd=2.15dBi)
 Limit: ERP ≤ 34.77dBm

Peak-to-average ratio (PAR)**10MHz bandwidth**

Modulation	Low channel (dB)	Middle channel (dB)	High channel (dB)	PAR Limit (dB)	Result
QPSK (1RB Size)	4.39	4.26	4.42	13	Pass
QPSK (50RB Size)	5.71	5.58	5.54	13	Pass
16QAM (1RB Size)	5.06	5.16	5.10	13	Pass
16QAM (50RB Size)	6.57	6.51	6.38	13	Pass

LTE Band 38:

Maximum Output Power

Bandwidth (MHz)	Modulation	RB size/ RB Offset	Conducted Average Output Power (dBm)			EIRP(dBm)		
			Low	Mid	High	Low	Mid	High
5.0	QP SK	RB1#0	21.88	21.94	21.87	21.99	22.05	21.98
		RB1#13	21.92	21.92	21.87	22.03	22.03	21.98
		RB1#24	21.93	21.93	21.84	22.04	22.04	21.95
		RB15#0	20.81	20.86	20.84	20.92	20.97	20.95
		RB15#10	20.83	20.84	20.84	20.94	20.95	20.95
		RB25#0	20.83	20.87	20.91	20.94	20.98	21.02
	16QAM	RB1#0	21.12	20.89	20.91	21.23	21.00	21.02
		RB1#13	21.15	20.95	20.94	21.26	21.06	21.05
		RB1#24	21.17	20.91	20.89	21.28	21.02	21.00
		RB15#0	19.83	19.78	19.86	19.94	19.89	19.97
		RB15#10	19.86	19.81	19.77	19.97	19.92	19.88
		RB25#0	19.83	19.88	19.73	19.94	19.99	19.84
10.0	QPSK	RB1#0	21.92	22.01	21.98	22.03	22.12	22.09
		RB1#25	22.17	22.22	22.15	22.28	22.33	22.26
		RB1#49	21.95	21.99	21.94	22.06	22.10	22.05
		RB25#0	20.87	20.94	20.83	20.98	21.05	20.94
		RB25#25	20.91	20.93	20.88	21.02	21.04	20.99
		RB50#0	20.93	20.90	20.87	21.04	21.01	20.98
	16QAM	RB1#0	21.15	20.89	21.01	21.26	21.00	21.12
		RB1#25	21.34	21.15	21.25	21.45	21.26	21.36
		RB1#49	21.15	20.88	20.99	21.26	20.99	21.10
		RB25#0	19.85	19.90	19.88	19.96	20.01	19.99
		RB25#25	19.86	19.92	19.86	19.97	20.03	19.97
		RB50#0	19.85	19.87	19.85	19.96	19.98	19.96

Bandwidth (MHz)	Modulation	RB size/ RB Offset	Conducted Average Output Power (dBm)			EIRP(dBm)		
			Low	Mid	High	Low	Mid	High
15.0	QPSK	RB1#0	21.90	21.95	21.91	22.01	22.06	22.02
		RB1#38	21.92	21.93	21.90	22.03	22.04	22.01
		RB1#74	21.93	21.96	21.91	22.04	22.07	22.02
		RB36#0	20.92	20.96	20.91	21.03	21.07	21.02
		RB36#39	20.95	20.94	20.88	21.06	21.05	20.99
		RB75#0	20.94	20.94	20.88	21.05	21.05	20.99
	16QAM	RB1#0	21.07	20.89	21.12	21.18	21.00	21.23
		RB1#38	21.11	20.87	21.12	21.22	20.98	21.23
		RB1#74	21.11	20.89	21.07	21.22	21.00	21.18
		RB36#0	19.87	19.91	19.95	19.98	20.02	20.06
		RB36#39	19.90	19.88	19.93	20.01	19.99	20.04
		RB75#0	19.86	19.91	19.86	19.97	20.02	19.97
20.0	QPSK	RB1#0	21.80	21.79	21.91	21.91	21.90	22.02
		RB1#50	22.15	22.13	22.21	22.26	22.24	22.32
		RB1#99	21.85	21.81	21.86	21.96	21.92	21.97
		RB50#0	20.88	20.94	20.94	20.99	21.05	21.05
		RB50#50	20.96	20.95	20.89	21.07	21.06	21.00
		RB100#0	20.96	20.99	20.98	21.07	21.10	21.09
	16QAM	RB1#0	20.84	20.79	21.09	20.95	20.90	21.20
		RB1#50	21.20	21.11	21.41	21.31	21.22	21.52
		RB1#99	20.92	20.81	21.07	21.03	20.92	21.18
		RB50#0	19.91	19.97	19.96	20.02	20.08	20.07
		RB50#50	19.94	19.98	19.91	20.05	20.09	20.02
		RB100#0	19.90	19.97	19.92	20.01	20.08	20.03

Note: ERP(dBm) = Conducted Power(dBm) + Antenna Gain(dBi)
 For LTE Band 38: Antenna Gain = 0.11dBi
 Limit: EIRP ≤ 33dBm

Peak-to-average ratio (PAR)**20MHz bandwidth**

Modulation	Low channel (dB)	Middle channel (dB)	High channel (dB)	PAR Limit (dB)	Result
QPSK (1RB Size)	7.94	7.85	7.02	13	Pass
QPSK (100RB Size)	7.28	8.61	7.66	13	Pass
16QAM (1RB Size)	7.34	8.97	9.84	13	Pass
16QAM (100RB Size)	9.81	8.62	8.75	13	Pass

LTE Band 41:

Maximum Output Power

Bandwidth (MHz)	Modulation	RB size/ RB Offset	Conducted Average Output Power (dBm)			EIRP(dBm)		
			Low	Mid	High	Low	Mid	High
5.0	QP SK	RB1#0	21.75	21.96	21.73	21.86	22.07	21.84
		RB1#13	21.76	21.96	21.75	21.87	22.07	21.86
		RB1#24	21.73	21.92	21.74	21.84	22.03	21.85
		RB15#0	20.65	20.86	20.68	20.76	20.97	20.79
		RB15#10	20.70	20.87	20.70	20.81	20.98	20.81
		RB25#0	20.72	20.89	20.68	20.83	21.00	20.79
	16QAM	RB1#0	20.75	21.03	20.95	20.86	21.14	21.06
		RB1#13	20.77	21.00	20.96	20.88	21.11	21.07
		RB1#24	20.75	20.99	20.97	20.86	21.10	21.08
		RB15#0	19.55	19.89	19.71	19.66	20.00	19.82
		RB15#10	19.65	19.89	19.73	19.76	20.00	19.84
		RB25#0	19.72	19.92	19.67	19.83	20.03	19.78
10.0	QPSK	RB1#0	21.76	22.01	21.67	21.87	22.12	21.78
		RB1#25	21.98	22.22	22.00	22.09	22.33	22.11
		RB1#49	21.77	22.03	21.80	21.88	22.14	21.91
		RB25#0	20.64	20.90	20.70	20.75	21.01	20.81
		RB25#25	20.72	20.93	20.75	20.83	21.04	20.86
		RB50#0	20.67	20.93	20.67	20.78	21.04	20.78
	16QAM	RB1#0	20.94	20.91	20.85	21.05	21.02	20.96
		RB1#25	21.16	21.11	21.07	21.27	21.22	21.18
		RB1#49	20.96	20.94	20.87	21.07	21.05	20.98
		RB25#0	19.66	19.93	19.73	19.77	20.04	19.84
		RB25#25	19.71	19.93	19.79	19.82	20.04	19.90
		RB50#0	19.68	19.88	19.73	19.79	19.99	19.84

Bandwidth (MHz)	Modulation	RB size/ RB Offset	Conducted Average Output Power (dBm)			EIRP(dBm)		
			Low	Mid	High	Low	Mid	High
15.0	QPSK	RB1#0	21.72	21.95	21.75	21.83	22.06	21.86
		RB1#38	21.75	21.96	21.77	21.86	22.07	21.88
		RB1#74	21.77	21.95	21.74	21.88	22.06	21.85
		RB36#0	20.74	20.93	20.78	20.85	21.04	20.89
		RB36#39	20.79	20.92	20.82	20.90	21.03	20.93
		RB75#0	20.74	20.93	20.72	20.85	21.04	20.83
	16QAM	RB1#0	20.87	20.86	20.94	20.98	20.97	21.05
		RB1#38	20.92	20.88	20.96	21.03	20.99	21.07
		RB1#74	21.07	20.88	20.94	21.18	20.99	21.05
		RB36#0	19.67	19.89	19.82	19.78	20.00	19.93
		RB36#39	19.75	19.88	19.85	19.86	19.99	19.96
		RB75#0	19.70	19.92	19.75	19.81	20.03	19.86
20.0	QPSK	RB1#0	21.63	21.79	21.72	21.74	21.90	21.83
		RB1#50	21.98	22.15	22.08	22.09	22.26	22.19
		RB1#99	21.65	21.76	21.68	21.76	21.87	21.79
		RB50#0	20.72	20.95	20.73	20.83	21.06	20.84
		RB50#50	20.78	20.97	20.84	20.89	21.08	20.95
		RB100#0	20.71	20.96	20.82	20.82	21.07	20.93
	16QAM	RB1#0	20.67	20.76	20.94	20.78	20.87	21.05
		RB1#50	21.07	21.14	21.28	21.18	21.25	21.39
		RB1#99	20.72	20.77	20.91	20.83	20.88	21.02
		RB50#0	19.67	20.00	19.78	19.78	20.11	19.89
		RB50#50	19.74	20.00	19.87	19.85	20.11	19.98
		RB100#0	19.75	20.00	19.83	19.86	20.11	19.94

Note: ERP(dBm) = Conducted Power(dBm) + Antenna Gain(dBi)
 For LTE Band 41: Antenna Gain = 0.11dBi
 Limit: EIRP ≤ 33dBm

Peak-to-average ratio (PAR)**20MHz bandwidth**

Modulation	Low channel (dB)	Middle channel (dB)	High channel (dB)	PAR Limit (dB)	Result
QPSK (1RB Size)	7.86	7.79	8.43	13	Pass
QPSK (100RB Size)	7.34	7.40	7.95	13	Pass
16QAM (1RB Size)	7.98	8.76	7.60	13	Pass
16QAM (100RB Size)	8.12	8.49	8.59	13	Pass

LTE Band 66:

Maximum Output Power

Bandwidth (MHz)	Modulation	RB size/ RB Offset	Conducted Average Output Power (dBm)			EIRP(dBm)		
			Low	Mid	High	Low	Mid	High
1.4	QP SK	RB1#0	14.70	14.75	14.63	15.07	15.12	15.00
		RB1#3	14.81	14.90	14.85	15.18	15.27	15.22
		RB1#5	14.71	14.78	14.62	15.08	15.15	14.99
		RB3#0	14.81	14.95	14.72	15.18	15.32	15.09
		RB3#3	14.81	14.92	14.75	15.18	15.29	15.12
		RB6#0	13.81	13.82	13.71	14.18	14.19	14.08
	16QAM	RB1#0	13.74	13.90	13.66	14.11	14.27	14.03
		RB1#3	13.90	14.12	13.88	14.27	14.49	14.25
		RB1#5	13.70	13.90	13.70	14.07	14.27	14.07
		RB3#0	13.96	13.86	13.86	14.33	14.23	14.23
		RB3#3	13.96	13.90	13.80	14.33	14.27	14.17
		RB6#0	12.79	12.86	12.67	13.16	13.23	13.04
3.0	QPSK	RB1#0	14.75	14.86	14.66	15.12	15.23	15.03
		RB1#8	14.75	14.82	14.70	15.12	15.19	15.07
		RB1#14	14.77	14.84	14.67	15.14	15.21	15.04
		RB6#0	13.73	13.79	13.61	14.10	14.16	13.98
		RB6#9	13.76	13.77	13.65	14.13	14.14	14.02
		RB15#0	13.76	13.84	13.65	14.13	14.21	14.02
	16QAM	RB1#0	14.42	14.00	13.76	14.79	14.37	14.13
		RB1#8	14.37	14.00	13.75	14.74	14.37	14.12
		RB1#14	14.36	14.00	13.68	14.73	14.37	14.05
		RB6#0	12.83	12.82	12.61	13.20	13.19	12.98
		RB6#9	12.85	12.83	12.60	13.22	13.20	12.97
		RB15#0	12.81	12.81	12.74	13.18	13.18	13.11

Bandwidth (MHz)	Modulation	RB size/ RB Offset	Conducted Average Output Power (dBm)			EIRP(dBm)		
			Low	Mid	High	Low	Mid	High
5.0	QP SK	RB1#0	14.74	14.78	14.58	15.11	15.15	14.95
		RB1#13	14.89	14.89	14.73	15.26	15.26	15.10
		RB1#24	14.73	14.80	14.65	15.10	15.17	15.02
		RB15#0	13.74	13.87	13.70	14.11	14.24	14.07
		RB15#10	13.80	13.84	13.73	14.17	14.21	14.10
		RB25#0	13.76	13.82	13.69	14.13	14.19	14.06
	16QAM	RB1#0	13.64	14.10	13.67	14.01	14.47	14.04
		RB1#13	13.72	14.17	13.83	14.09	14.54	14.20
		RB1#24	13.66	14.10	13.71	14.03	14.47	14.08
		RB15#0	12.83	12.84	12.74	13.20	13.21	13.11
		RB15#10	12.84	12.81	12.72	13.21	13.18	13.09
		RB25#0	12.84	12.86	12.70	13.21	13.23	13.07
10.0	QPSK	RB1#0	14.75	14.88	14.82	15.12	15.25	15.19
		RB1#25	14.91	15.07	14.83	15.28	15.44	15.20
		RB1#49	14.80	14.89	14.71	15.17	15.26	15.08
		RB25#0	13.78	13.92	13.82	14.15	14.29	14.19
		RB25#25	13.89	13.88	13.74	14.26	14.25	14.11
		RB50#0	13.84	13.92	13.80	14.21	14.29	14.17
	16QAM	RB1#0	14.40	14.03	13.83	14.77	14.40	14.20
		RB1#25	14.56	14.13	13.88	14.93	14.50	14.25
		RB1#49	14.44	14.03	13.73	14.81	14.40	14.10
		RB25#0	12.84	12.96	12.92	13.21	13.33	13.29
		RB25#25	12.94	12.93	12.81	13.31	13.30	13.18
		RB50#0	12.85	12.93	12.81	13.22	13.30	13.18

Bandwidth (MHz)	Modulation	RB size/ RB Offset	Conducted Average Output Power (dBm)			EIRP(dBm)		
			Low	Mid	High	Low	Mid	High
15.0	QPSK	RB1#0	14.68	14.83	14.77	15.05	15.20	15.14
		RB1#38	14.86	14.93	14.82	15.23	15.30	15.19
		RB1#74	14.81	14.87	14.70	15.18	15.24	15.07
		RB36#0	13.81	13.96	13.97	14.18	14.33	14.34
		RB36#39	13.88	13.90	13.76	14.25	14.27	14.13
		RB75#0	13.83	13.91	13.83	14.20	14.28	14.20
	16QAM	RB1#0	14.33	13.96	14.19	14.70	14.33	14.56
		RB1#38	14.48	14.08	14.23	14.85	14.45	14.60
		RB1#74	14.41	14.00	14.13	14.78	14.37	14.50
		RB36#0	12.82	12.96	12.91	13.19	13.33	13.28
		RB36#39	12.87	12.90	12.70	13.24	13.27	13.07
		RB75#0	12.88	12.92	12.83	13.25	13.29	13.20
20.0	QPSK	RB1#0	14.58	14.72	14.63	14.95	15.09	15.00
		RB1#50	15.01	15.13	14.97	15.38	15.50	15.34
		RB1#99	14.70	14.75	14.50	15.07	15.12	14.87
		RB50#0	13.83	14.00	14.02	14.20	14.37	14.39
		RB50#50	13.92	13.87	13.77	14.29	14.24	14.14
		RB100#0	13.88	13.94	13.89	14.25	14.31	14.26
	16QAM	RB1#0	13.88	13.96	14.22	14.25	14.33	14.59
		RB1#50	14.34	14.38	14.64	14.71	14.75	15.01
		RB1#99	14.02	13.95	14.11	14.39	14.32	14.48
		RB50#0	12.82	12.96	13.07	13.19	13.33	13.44
		RB50#50	12.96	12.89	12.79	13.33	13.26	13.16
		RB100#0	12.87	12.93	12.89	13.24	13.30	13.26

Note: EIRP(dBm) = Conducted Power(dBm) + Antenna Gain(dBi)
 For LTE Band 66: Antenna Gain = 0.37dBi
 The Limit: EIRP ≤ 30dBm

Peak-to-average ratio (PAR)**20MHz bandwidth**

Modulation	Low channel (dB)	Middle channel (dB)	High channel (dB)	PAR Limit (dB)	Result
QPSK (1RB Size)	8.40	5.71	5.77	13	Pass
QPSK (100RB Size)	5.58	5.74	5.64	13	Pass
16QAM (1RB Size)	6.03	7.18	7.05	13	Pass
16QAM (100RB Size)	6.44	6.44	6.54	13	Pass

FCC §2.1049, §22.917, §22.905 & §24.238 & §27.53 - OCCUPIED BANDWIDTH

Applicable Standard

FCC 47 §2.1049, §22.917, §22.905, §24.238 and §27.53.

Test Procedure

The RF output of the transmitter was connected to the simulator and the spectrum analyzer through sufficient attenuation.

The resolution bandwidth of the spectrum analyzer was set at 1% to 5% of the anticipated emission bandwidth and the 26 dB & 99% bandwidth was recorded.

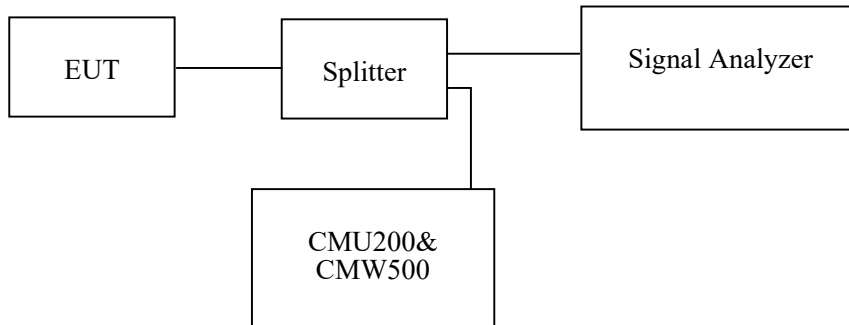

Test Data

Environmental Conditions

Temperature:	28.5~29.2 °C
Relative Humidity:	51~53 %
ATM Pressure:	101.0 kPa

The testing was performed by Pedro Yun from 2021-08-06 to 2021-08-18.

EUT operation mode: Transmitting

Test Result: Pass

Please refer to the following tables and plots.

Cellular Band (Part 22H)

Mode	Channel	Frequency (MHz)	99% Occupied Bandwidth (kHz)	26 dB Emission Bandwidth (kHz)
GSM(GMSK)	128	824.2	247.50	321.54
	190	836.6	245.00	319.87
	251	848.8	245.00	314.42
EGPRS(8PSK)	128	824.2	247.50	317.63
	190	836.6	250.00	310.58
	251	848.8	247.50	318.91

	Frequency (MHz)	Occupied Bandwidth (MHz)	26dB Bandwidth (MHz)
RMC	826.4	4.20	4.71
	836.6	4.15	4.73
	846.6	4.18	4.74
HSDPA	826.4	4.23	4.87
	836.6	4.20	4.81
	846.6	4.20	4.75
HSUPA	826.4	4.20	5.00
	836.6	4.20	4.76
	846.6	4.20	4.87

PCS Band (Part 24E)

Mode	Channel	Frequency (MHz)	99% Occupied Bandwidth (kHz)	26 dB Emission Bandwidth (kHz)
GSM(GMSK)	512	1850.2	245.00	317.31
	661	1880.0	247.50	314.42
	810	1909.8	247.50	323.53
EGPRS(8PSK)	512	1850.2	252.50	313.08
	661	1880.0	245.00	314.42
	810	1909.8	250.00	318.91

Frequency (MHz)		Occupied Bandwidth (MHz)	26dB Bandwidth (MHz)
RMC	1852.4	4.20	4.73
	1880.0	4.20	4.72
	1907.6	4.20	4.73
HSDPA	1852.4	4.20	4.74
	1880.0	4.20	4.73
	1907.6	4.23	5.00
HSUPA	1852.4	4.20	4.71
	1880.0	4.20	4.72
	1907.6	4.20	5.32

AWS Band (Part 27)

Frequency (MHz)		Occupied Bandwidth (MHz)	26dB Bandwidth (MHz)
RMC	1712.4	4.20	4.72
	1732.6	4.18	4.73
	1752.6	4.20	4.71
HSDPA	1712.4	4.20	4.73
	1732.6	4.20	4.75
	1752.6	4.20	4.72
HSUPA	1712.4	4.20	4.73
	1732.6	4.20	4.73
	1752.6	4.20	4.74

Cellular Band (Part 22H)

26 dB Emissions & 99% Occupied Bandwidth for GSM (GMSK) Mode, Low channel

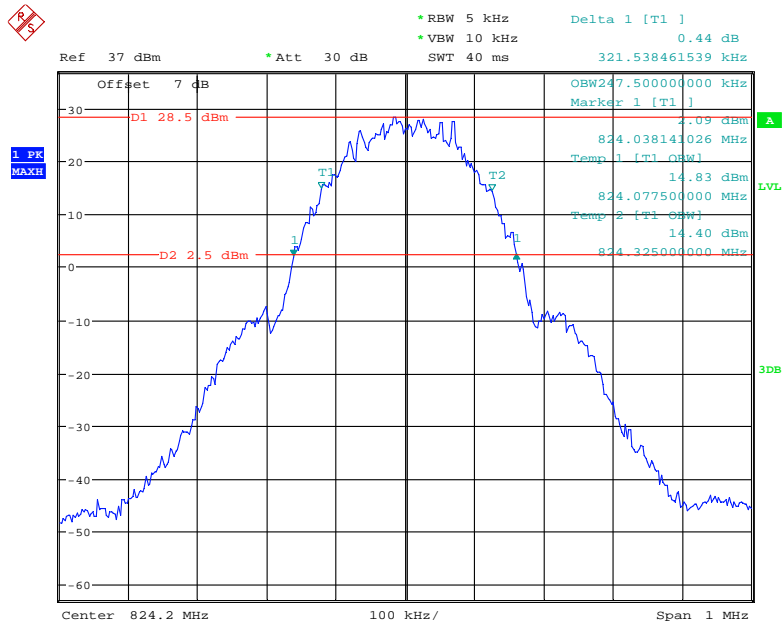

Date: 6.AUG.2021 23:17:25

26 dB Emissions & 99% Occupied Bandwidth for GSM (GMSK) Mode, Middle channel

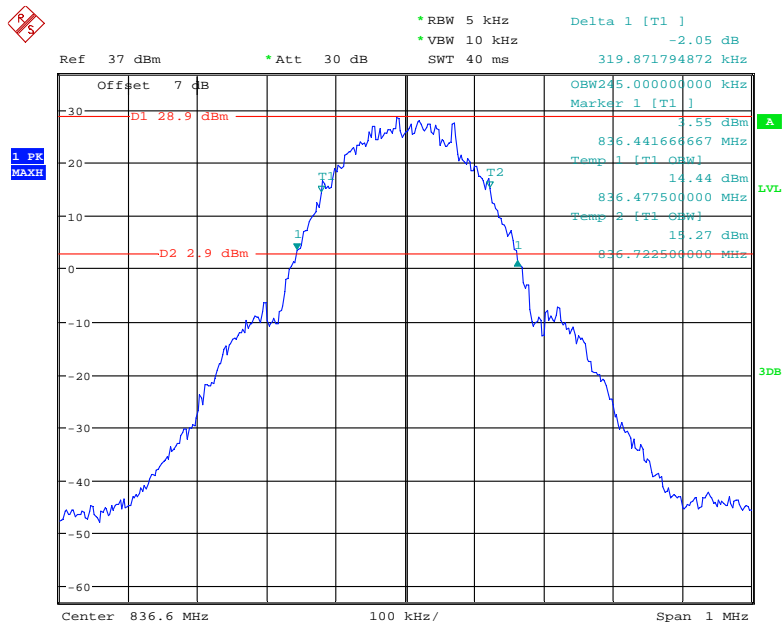

Date: 6.AUG.2021 23:18:57

26 dB Emissions & 99% Occupied Bandwidth for GSM (GMSK) Mode, High channel

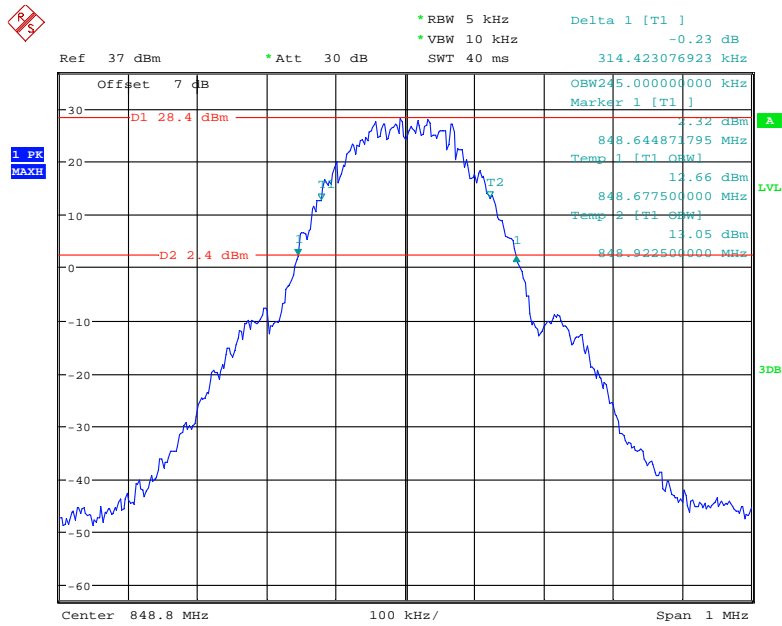

Date: 6.AUG.2021 23:19:43

26 dB Emissions & 99% Occupied Bandwidth for EGPRS (8PSK) Mode, Low channel

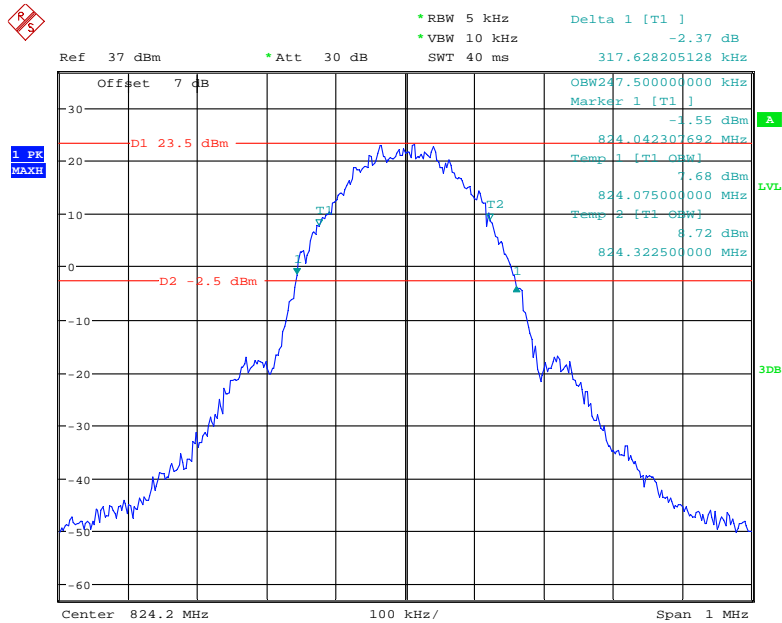

Date: 6.AUG.2021 23:26:31

26 dB Emissions & 99% Occupied Bandwidth for EGPRS (8PSK) Mode, Middle channel

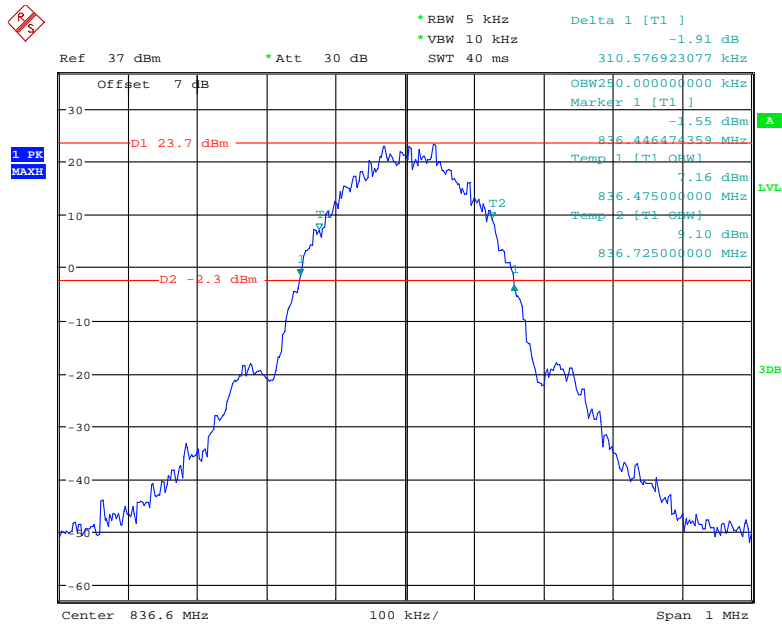

Date: 6.AUG.2021 23:27:33

26 dB Emissions & 99% Occupied Bandwidth for EGPRS (8PSK) Mode, High channel

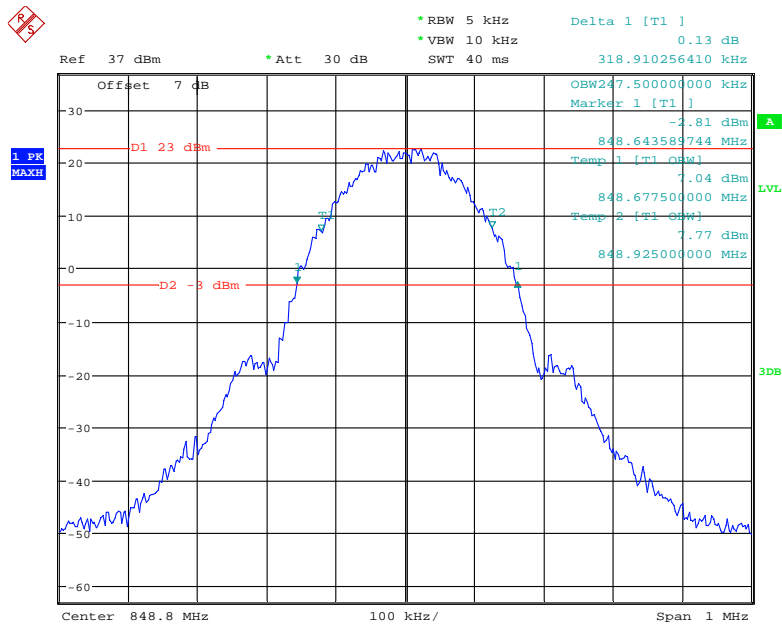

Date: 6.AUG.2021 23:29:38

26 dB Emissions & 99% Occupied Bandwidth for RMC (BPSK) Mode, Low channel

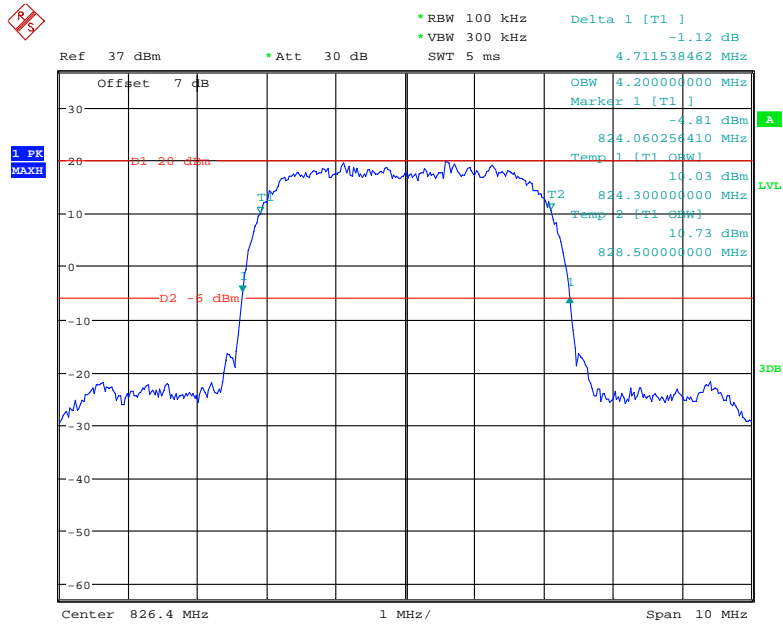

Date: 6.AUG.2021 21:36:15

26 dB Emissions & 99% Occupied Bandwidth for RMC (BPSK) Mode, Middle channel

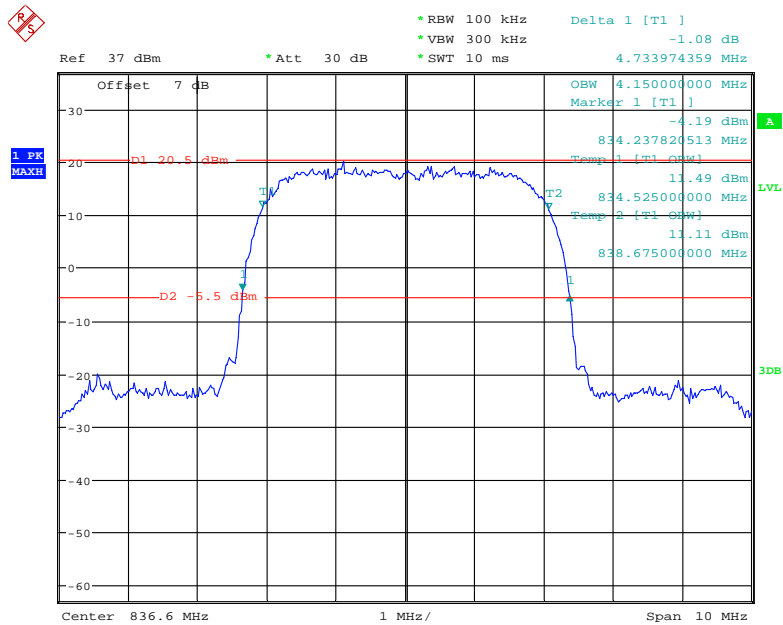

Date: 6.AUG.2021 21:34:51

26 dB Emissions & 99% Occupied Bandwidth for RMC (BPSK) Mode, High channel

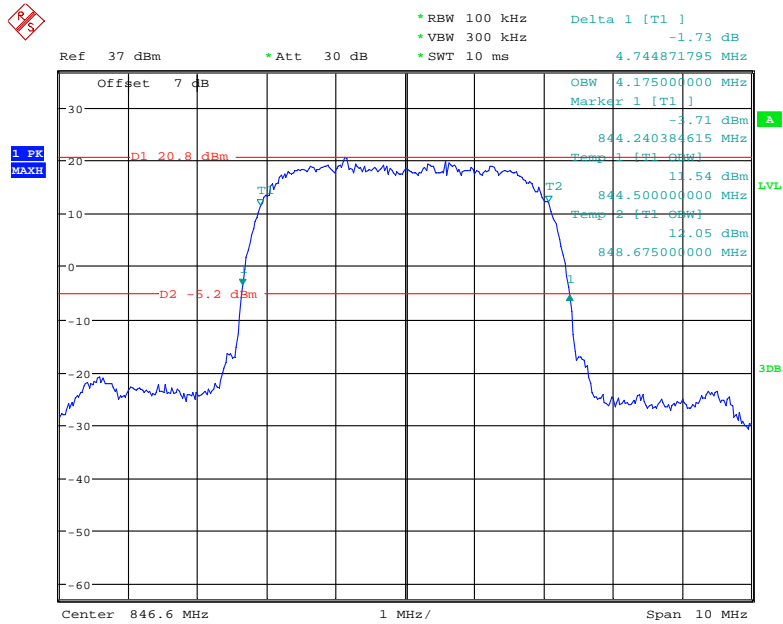

Date: 6.AUG.2021 21:33:28

26 dB Emissions & 99% Occupied Bandwidth for HSUPA (BPSK) Mode, Low channel

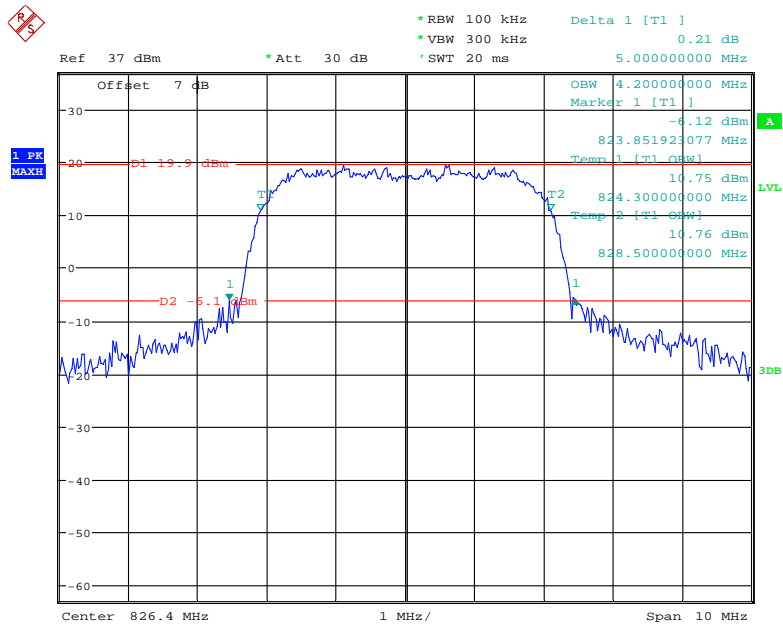

Date: 6.AUG.2021 22:53:24

26 dB Emissions & 99% Occupied Bandwidth for HSUPA (BPSK) Mode, Middle channel

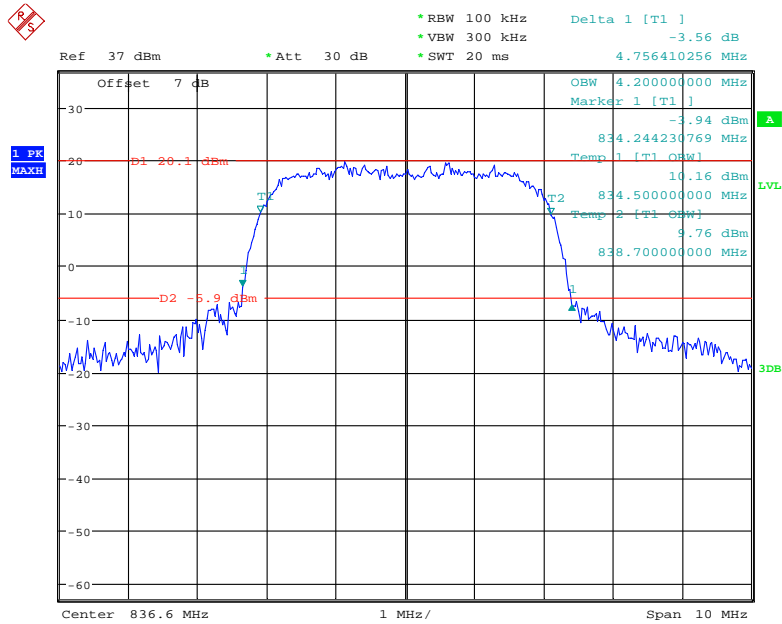

Date: 6.AUG.2021 22:55:00

26 dB Emissions & 99% Occupied Bandwidth for HSUPA (BPSK) Mode, High channel

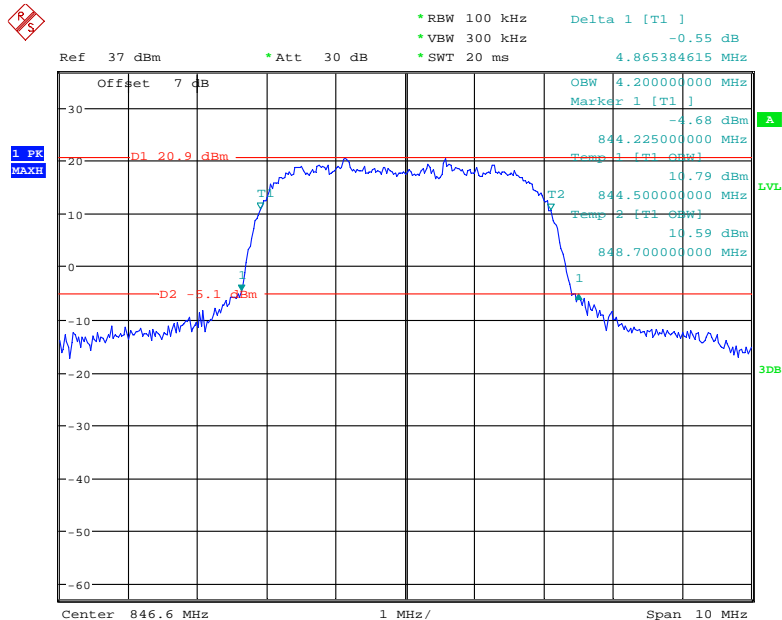

Date: 6.AUG.2021 22:56:13

26 dB Emissions & 99% Occupied Bandwidth for HSDPA (16QAM) Mode, Low channel

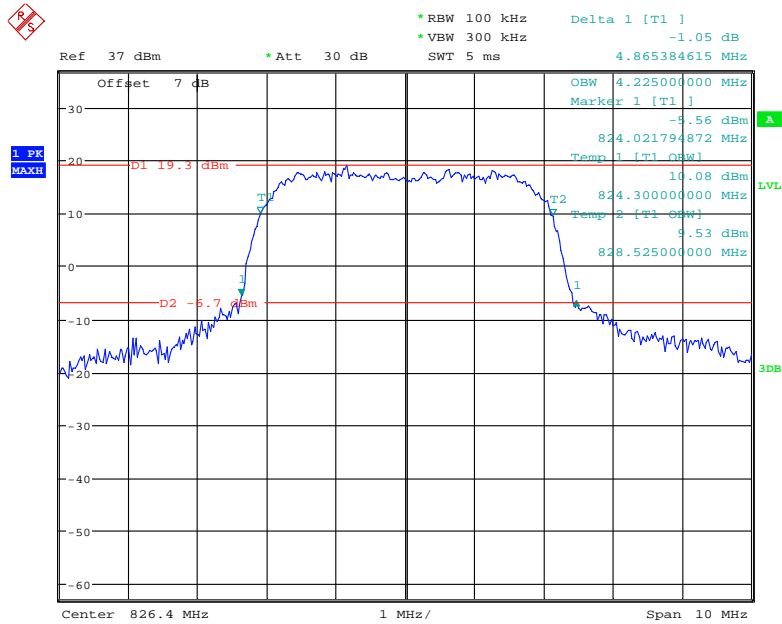

Date: 6.AUG.2021 22:22:19

26 dB Emissions & 99% Occupied Bandwidth for HSDPA (16QAM) Mode, Middle channel

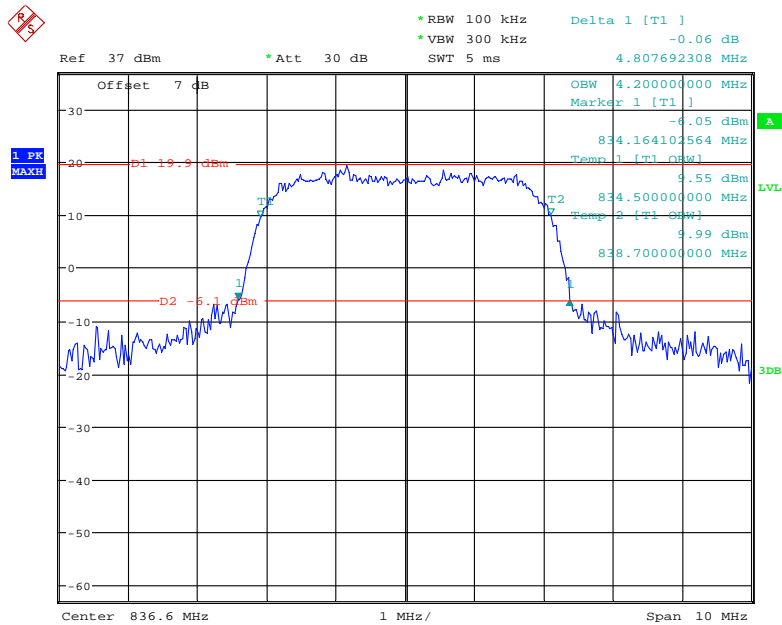

Date: 6.AUG.2021 22:20:21

26 dB Emissions & 99% Occupied Bandwidth for HSDPA (16QAM) Mode, High channel

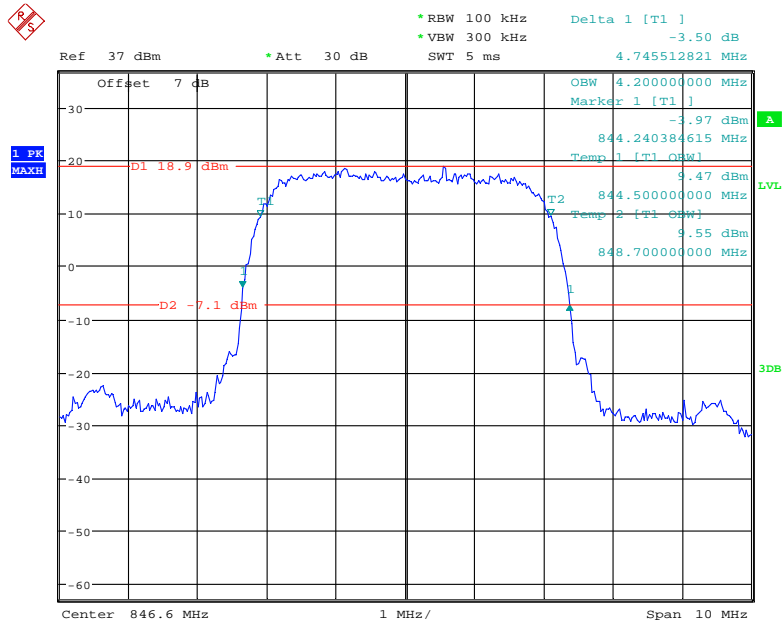

Date: 6.AUG.2021 22:18:24

PCS Band (Part 24E)

26 dB Emissions & 99% Occupied Bandwidth for GSM (GMSK) Mode, Low channel

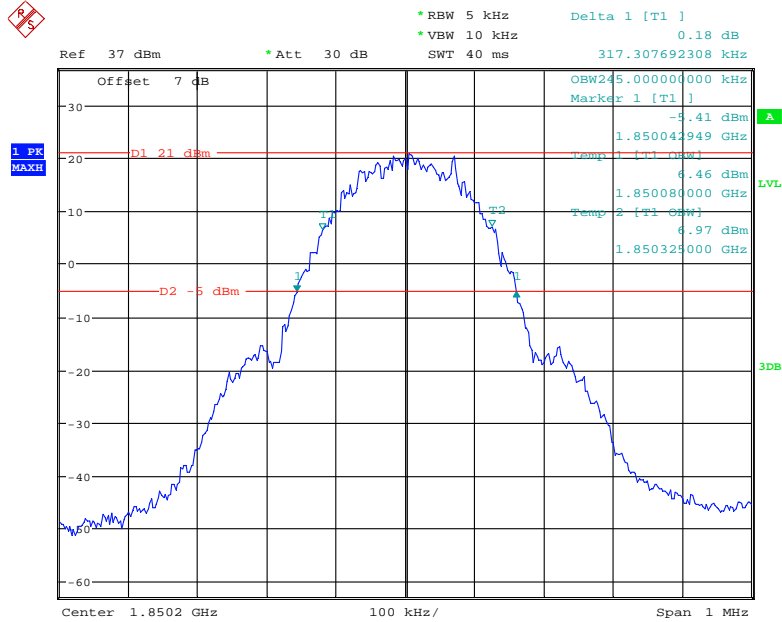

Date: 6.AUG.2021 23:37:40

26 dB Emissions & 99% Occupied Bandwidth for GSM (GMSK) Mode, Middle channel

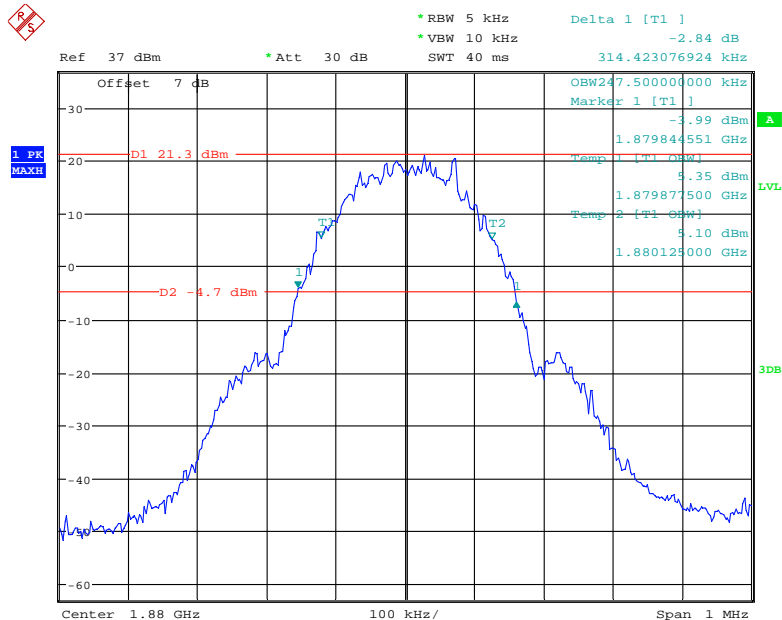

Date: 6.AUG.2021 23:36:15

26 dB Emissions & 99% Occupied Bandwidth for GSM (GMSK) Mode, High channel

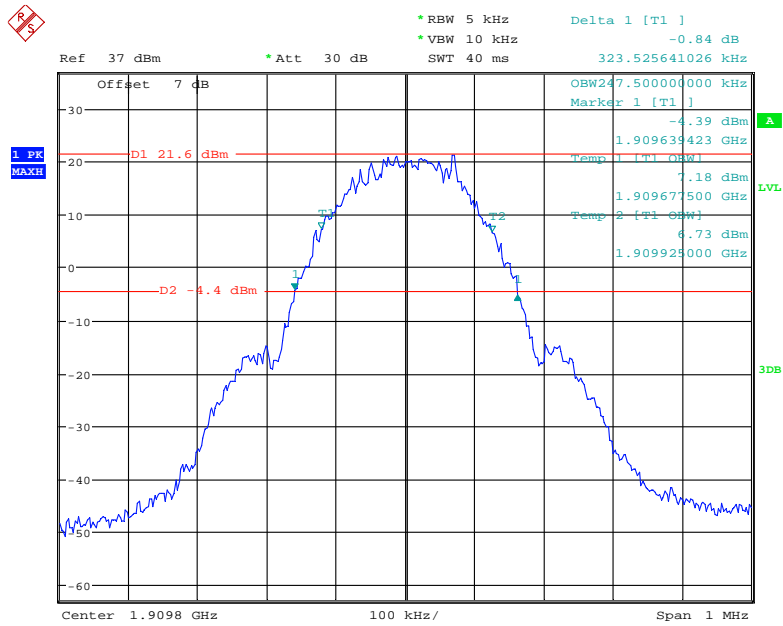

Date: 6.AUG.2021 23:35:13

26 dB Emissions & 99% Occupied Bandwidth for EGPRS (8PSK) Mode, Low channel

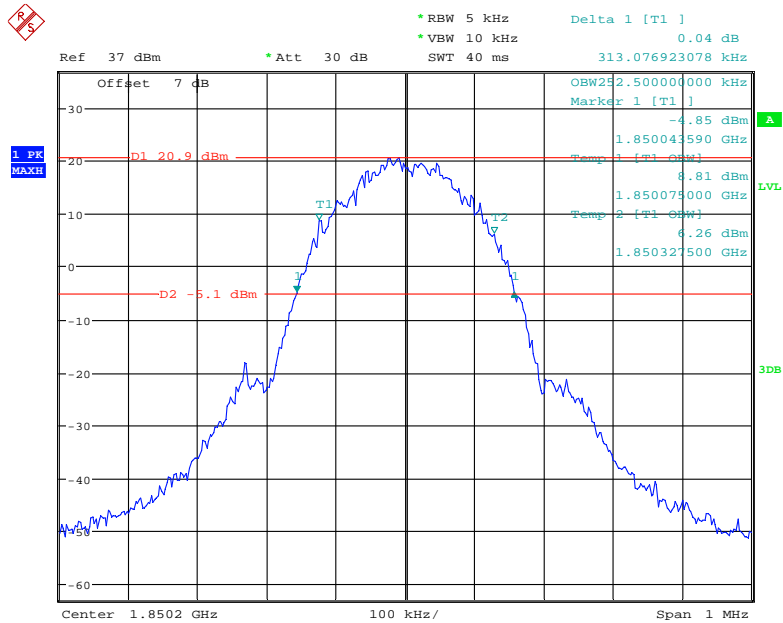

Date: 6.AUG.2021 23:44:44

26 dB Emissions & 99% Occupied Bandwidth for EGPRS (8PSK) Mode, Middle channel

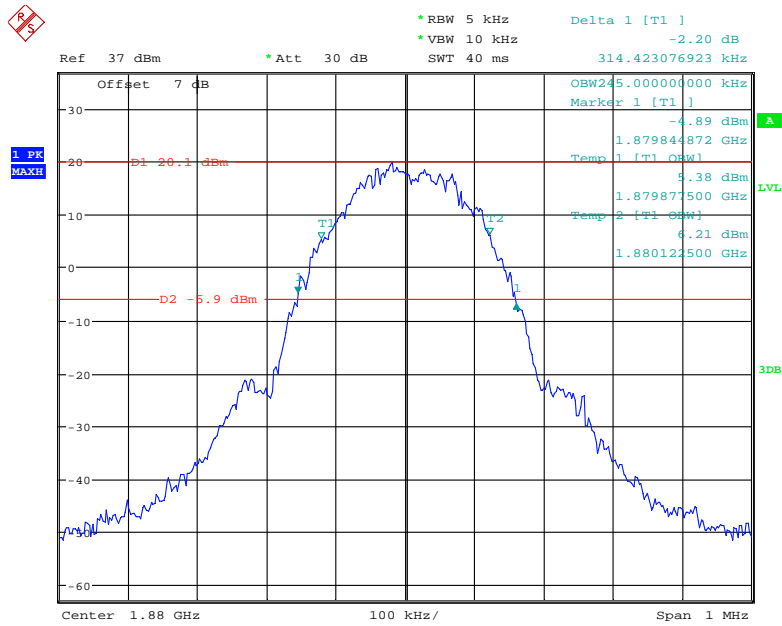

Date: 6.AUG.2021 23:45:47

26 dB Emissions & 99% Occupied Bandwidth for EGPRS (8PSK) Mode, High channel

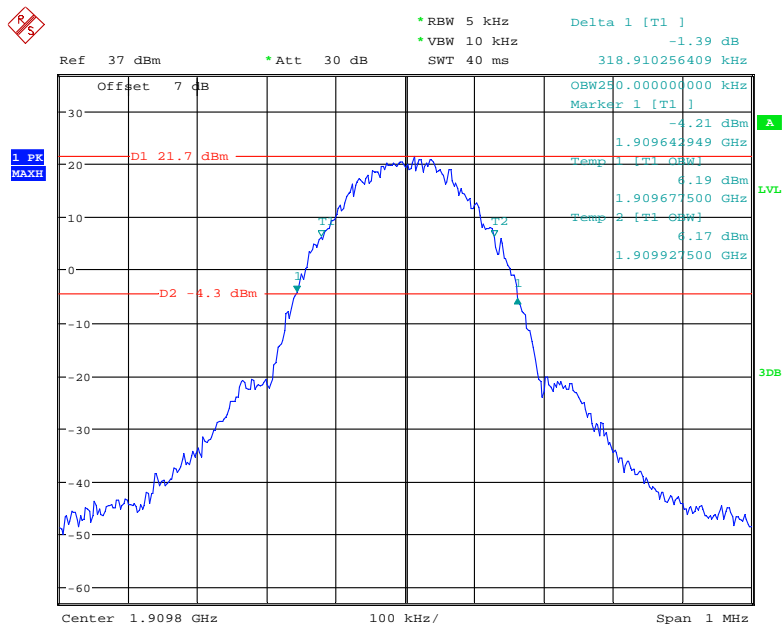

Date: 6.AUG.2021 23:47:02

26 dB Emissions & 99% Occupied Bandwidth for RMC (BPSK) Mode, Low channel

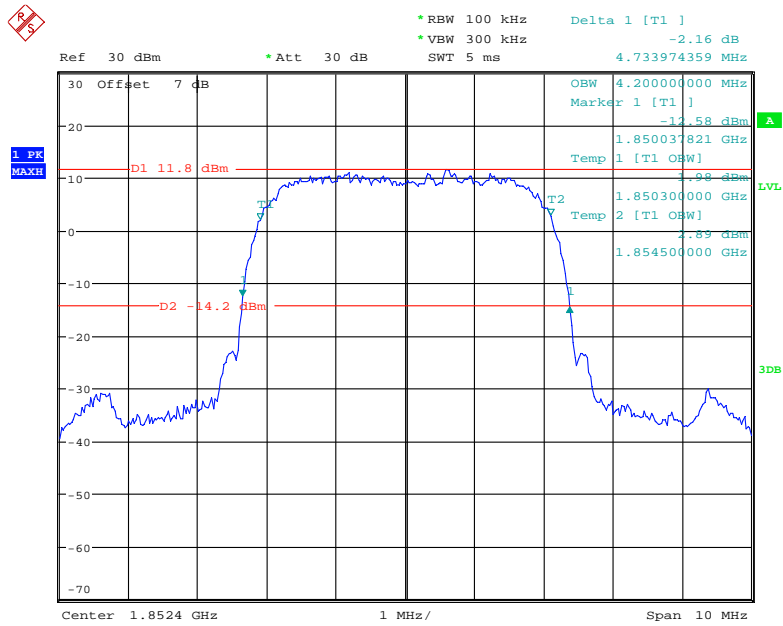

Date: 6.AUG.2021 21:44:13

26 dB Emissions & 99% Occupied Bandwidth for RMC (BPSK) Mode, Middle channel

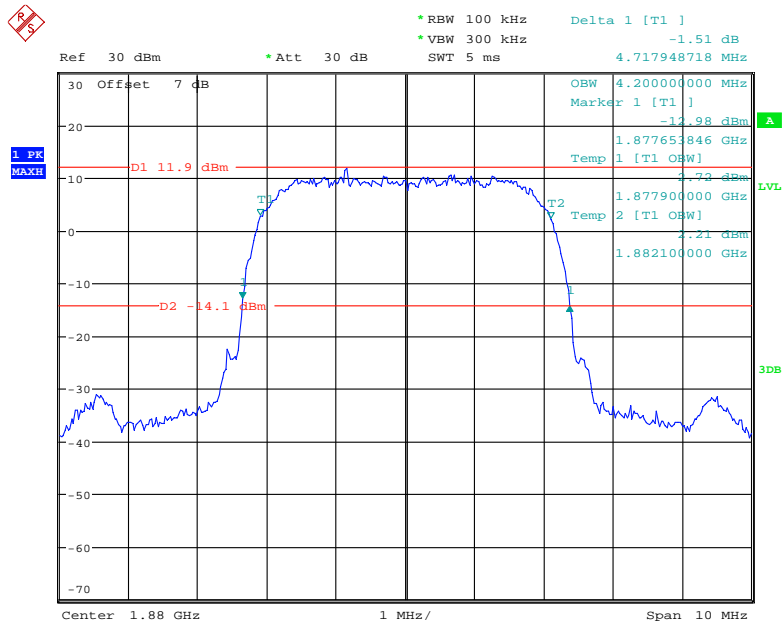

Date: 6.AUG.2021 21:43:03

26 dB Emissions & 99% Occupied Bandwidth for RMC (BPSK) Mode, High channel

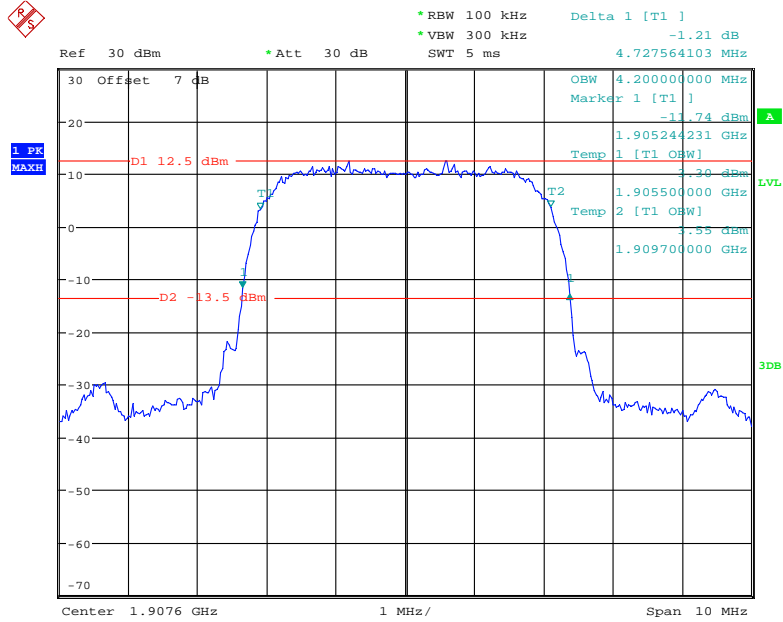

Date: 6.AUG.2021 21:42:14

26 dB Emissions & 99% Occupied Bandwidth for HSUPA (BPSK) Mode, Low channel

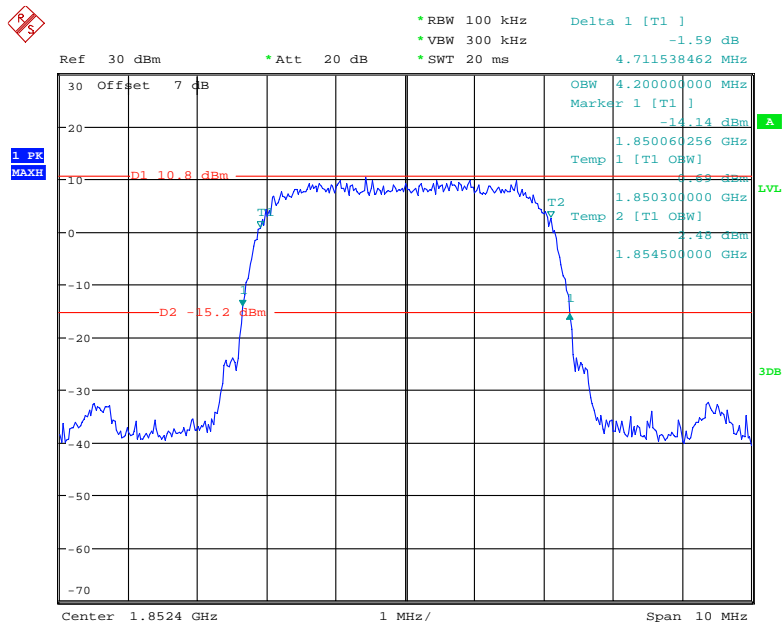

Date: 6.AUG.2021 22:47:20

26 dB Emissions & 99% Occupied Bandwidth for HSUPA (BPSK) Mode, Middle channel

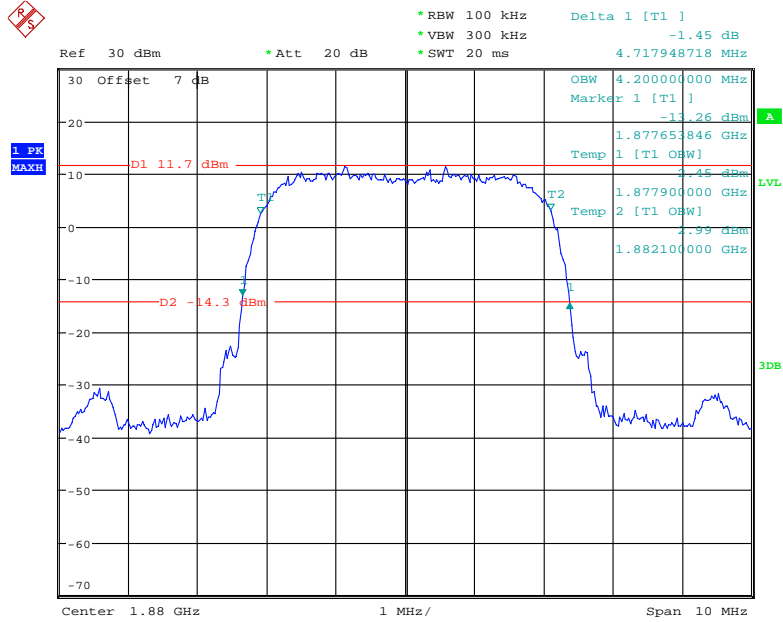

Date: 6.AUG.2021 22:43:40

26 dB Emissions & 99% Occupied Bandwidth for HSUPA (BPSK) Mode, High channel

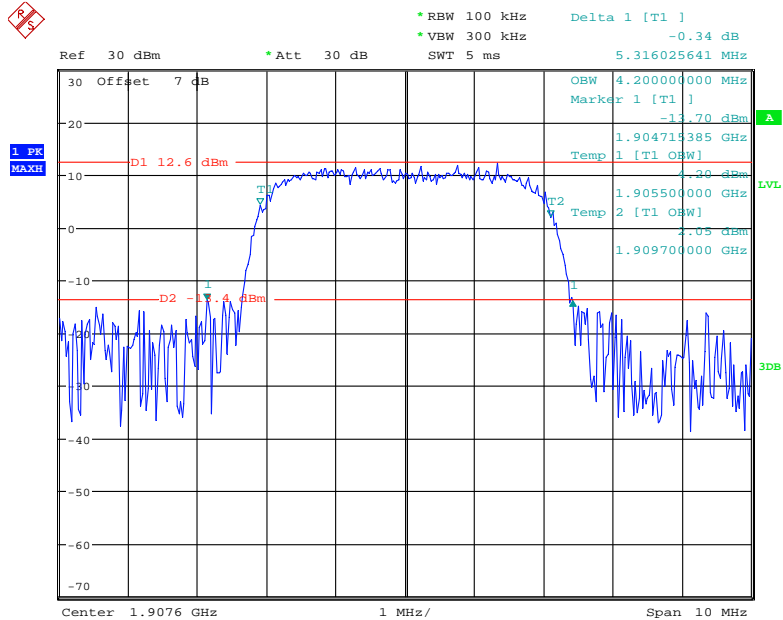

Date: 18.AUG.2021 19:37:57

26 dB Emissions & 99% Occupied Bandwidth for HSDPA (16QAM) Mode, Low channel

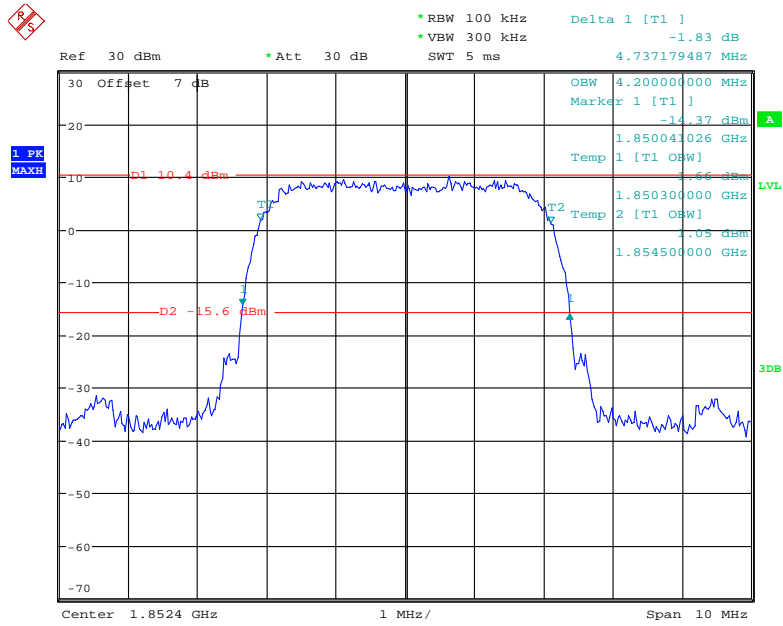

Date: 6.AUG.2021 22:29:05

26 dB Emissions & 99% Occupied Bandwidth for HSDPA (16QAM) Mode, Middle channel

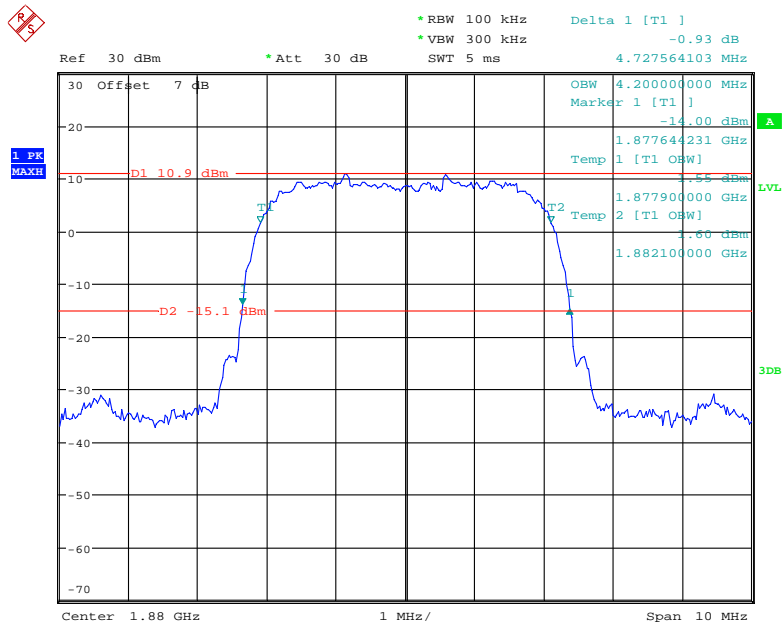

Date: 6.AUG.2021 22:33:16

26 dB Emissions & 99% Occupied Bandwidth for HSDPA (16QAM) Mode, High channel

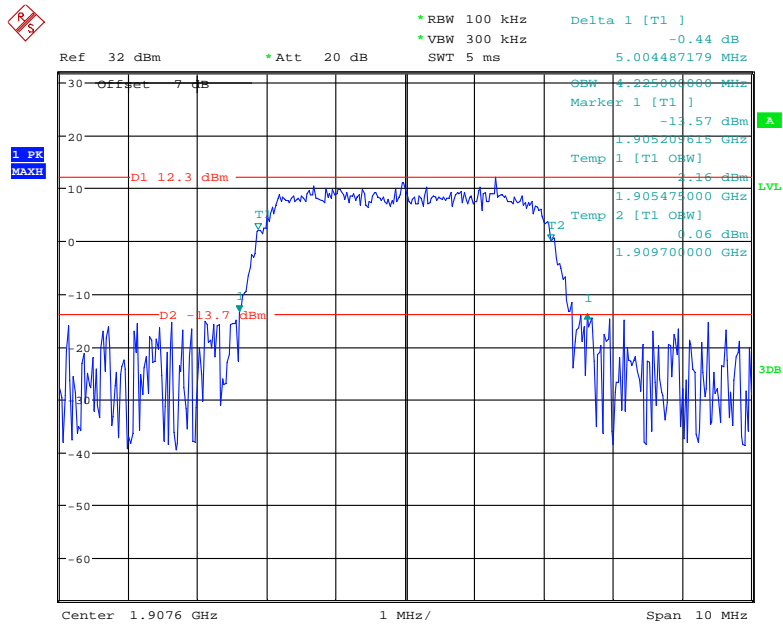

Date: 18.AUG.2021 20:01:32

AWS Band (Part 27)

26 dB Emissions & 99% Occupied Bandwidth for RMC (BPSK) Mode, Low channel

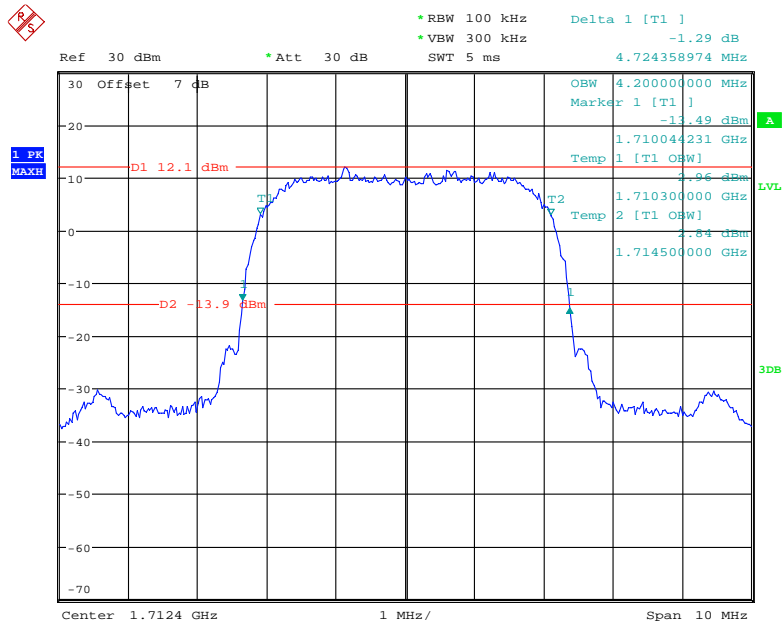

Date: 6.AUG.2021 21:37:58

26 dB Emissions & 99% Occupied Bandwidth for RMC (BPSK) Mode, Middle channel

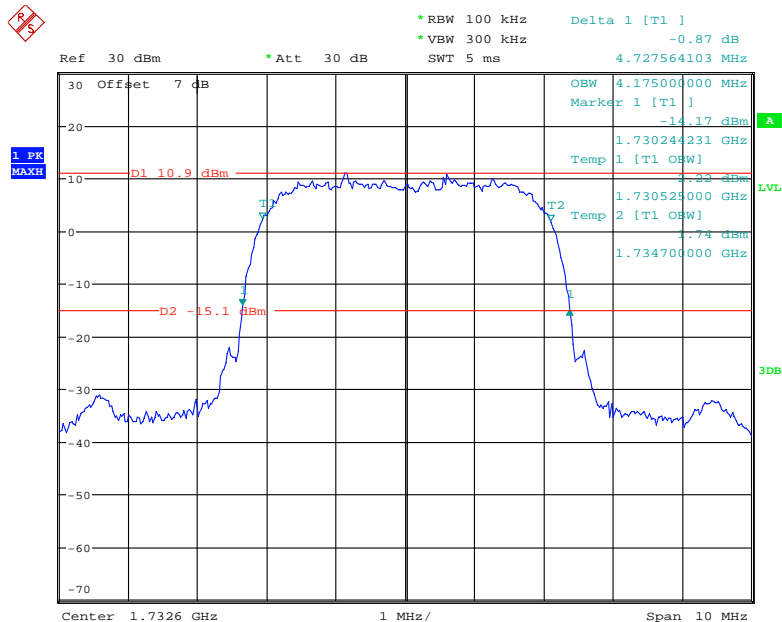

Date: 6.AUG.2021 21:39:10

26 dB Emissions & 99% Occupied Bandwidth for RMC (BPSK) Mode, High channel

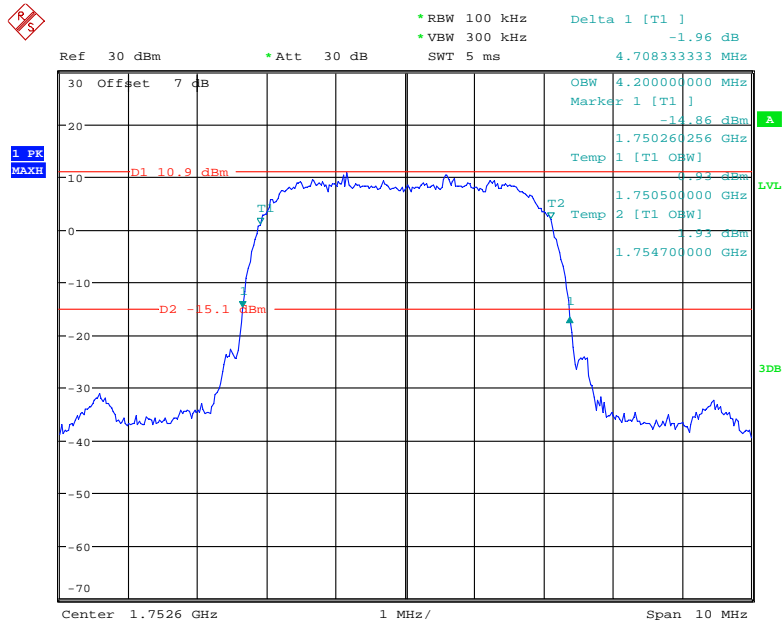

Date: 6.AUG.2021 21:40:32

26 dB Emissions & 99% Occupied Bandwidth for HSUPA (BPSK) Mode, Low channel

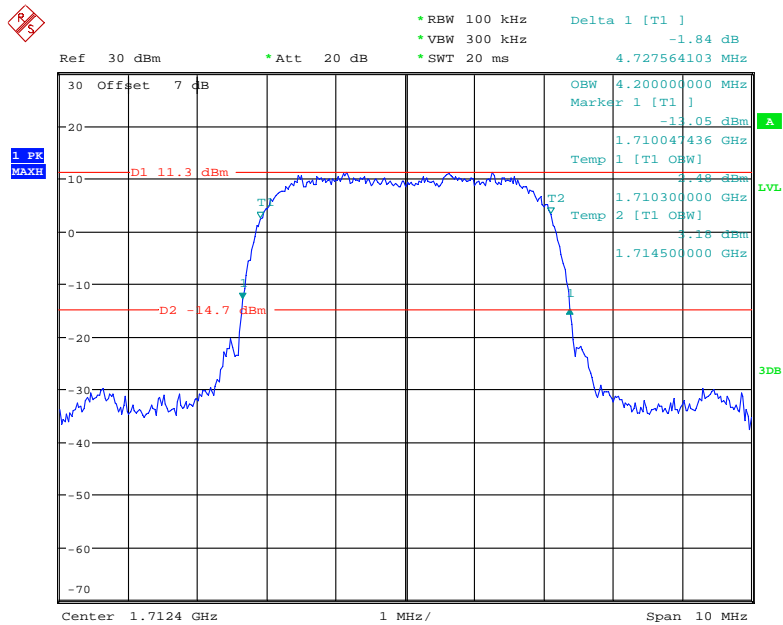

Date: 6.AUG.2021 22:48:29

26 dB Emissions & 99% Occupied Bandwidth for HSUPA (BPSK) Mode, Middle channel

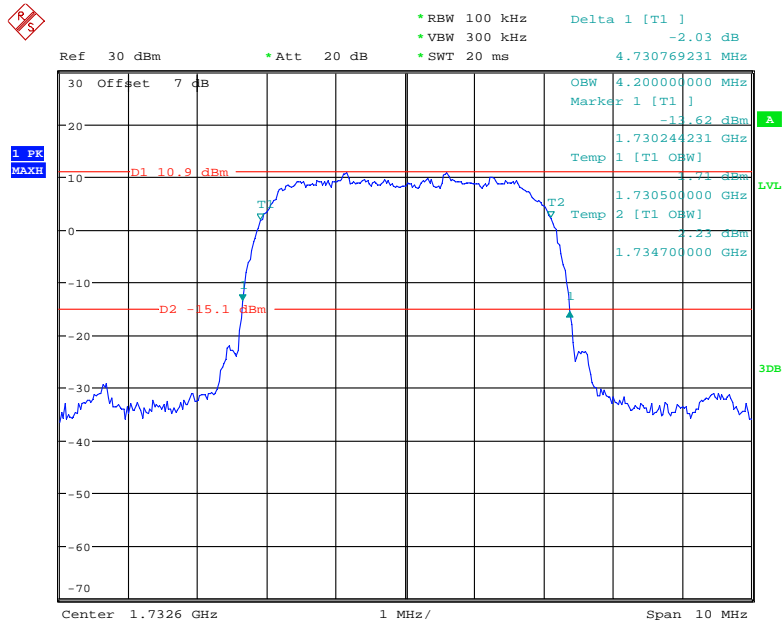

Date: 6.AUG.2021 22:50:53

26 dB Emissions & 99% Occupied Bandwidth for HSUPA (BPSK) Mode, High channel

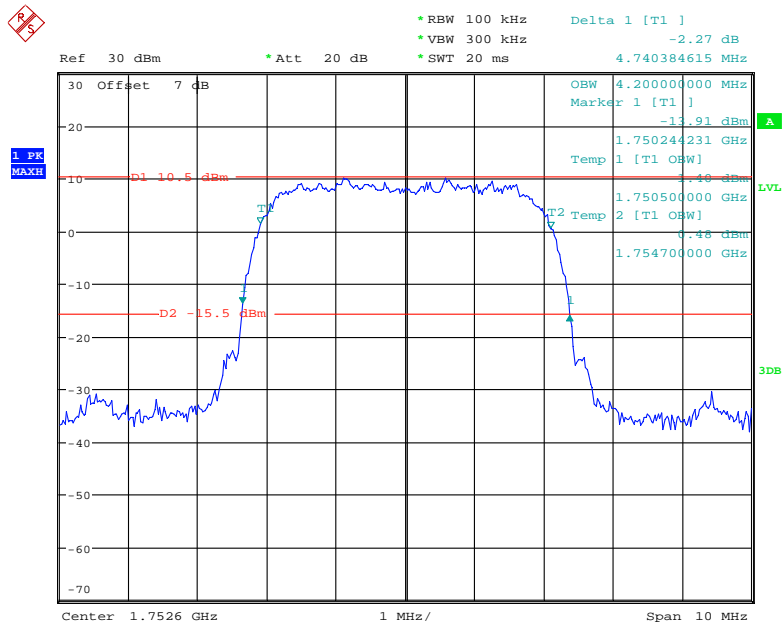

Date: 6.AUG.2021 22:51:54

26 dB Emissions & 99% Occupied Bandwidth for HSDPA (16QAM) Mode, Low channel

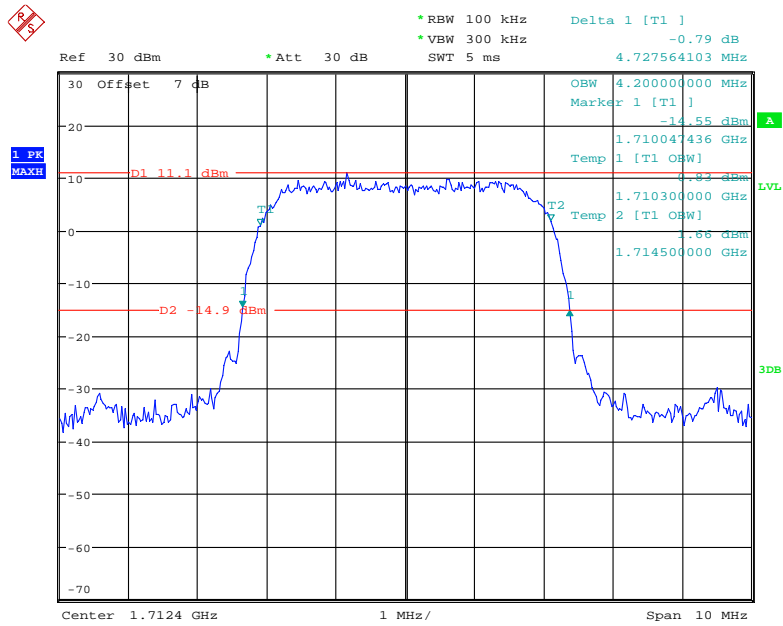

Date: 6.AUG.2021 22:28:00

26 dB Emissions & 99% Occupied Bandwidth for HSDPA (16QAM) Mode, Middle channel

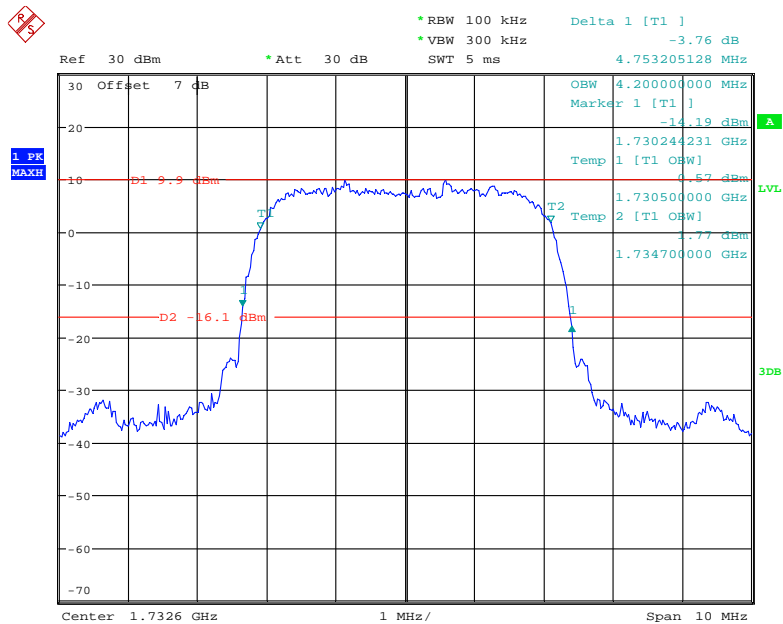

Date: 6.AUG.2021 22:27:05

26 dB Emissions & 99% Occupied Bandwidth for HSDPA (16QAM) Mode, High channel

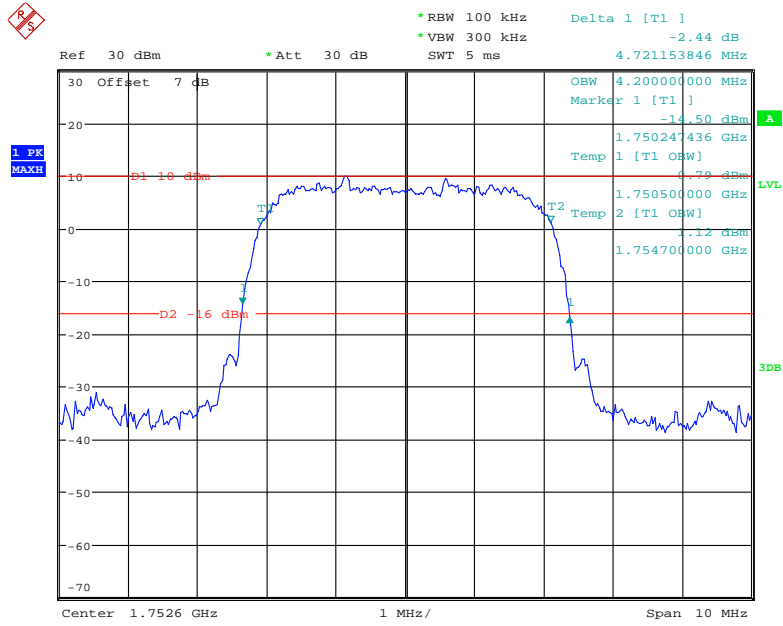

Date: 6.AUG.2021 22:25:17

LTE Band 2:

Bandwidth	Modulation	Low channel		Middle channel		High channel	
		OBW (MHz)	26dB EBW (MHz)	OBW (MHz)	26dB EBW (MHz)	OBW (MHz)	26dB EBW (MHz)
1.4 MHz	QPSK	1.110	1.290	1.098	1.308	1.110	1.312
	16QAM	1.098	1.290	1.104	1.294	1.092	1.296
3 MHz	QPSK	2.688	2.868	2.688	2.892	2.688	2.892
	16QAM	2.688	2.904	2.688	2.892	2.688	2.868
5 MHz	QPSK	4.520	4.960	4.520	4.960	4.520	4.900
	16QAM	4.500	4.920	4.520	4.940	4.520	5.000
10 MHz	QPSK	9.000	9.640	8.960	9.560	8.960	9.560
	16QAM	9.000	9.560	8.960	9.560	8.960	9.640
15 MHz	QPSK	13.560	14.760	13.500	14.640	13.500	14.700
	16QAM	13.500	14.820	13.500	14.760	13.560	14.820
20 MHz	QPSK	18.000	19.280	18.000	19.280	17.920	19.360
	16QAM	18.080	19.280	18.000	19.440	17.920	19.280

LTE Band 4:

Bandwidth	Modulation	Low channel		Middle channel		High channel	
		OBW (MHz)	26dB EBW (MHz)	OBW (MHz)	26dB EBW (MHz)	OBW (MHz)	26dB EBW (MHz)
1.4 MHz	QPSK	1.098	1.302	1.098	1.314	1.110	1.296
	16QAM	1.110	1.298	1.092	1.296	1.098	1.296
3 MHz	QPSK	2.688	2.892	2.700	2.880	2.688	2.892
	16QAM	2.688	2.880	2.688	2.880	2.688	2.880
5 MHz	QPSK	4.520	4.960	4.520	4.920	4.520	4.920
	16QAM	4.500	4.880	4.520	4.980	4.500	4.960
10 MHz	QPSK	8.960	9.640	8.960	9.600	8.960	9.640
	16QAM	8.960	9.560	8.960	9.600	8.960	9.640
15 MHz	QPSK	13.560	14.820	13.500	14.760	13.500	14.760
	16QAM	13.500	14.700	13.500	14.760	13.560	14.760
20 MHz	QPSK	18.000	19.280	18.000	19.360	18.000	19.520
	16QAM	18.000	19.440	18.000	19.280	18.000	19.280

LTE Band 5:

Bandwidth	Modulation	Low channel		Middle channel		High channel	
		OBW (MHz)	26dB EBW (MHz)	OBW (MHz)	26dB EBW (MHz)	OBW (MHz)	26dB EBW (MHz)
1.4 MHz	QPSK	1.104	1.314	1.104	1.308	1.104	1.296
	16QAM	1.110	1.314	1.098	1.290	1.098	1.302
3 MHz	QPSK	2.688	2.880	2.688	2.880	2.688	2.880
	16QAM	2.688	2.904	2.688	2.868	2.688	2.880
5 MHz	QPSK	4.520	4.960	4.520	4.920	4.520	4.900
	16QAM	4.500	4.940	4.520	4.920	4.520	4.960
10 MHz	QPSK	8.960	9.640	8.960	9.520	8.960	9.520
	16QAM	8.960	9.600	8.960	9.560	9.000	9.600

LTE Band 7:

Bandwidth	Modulation	Low channel		Middle channel		High channel	
		OBW (MHz)	26dB EBW (MHz)	OBW (MHz)	26dB EBW (MHz)	OBW (MHz)	26dB EBW (MHz)
5 MHz	QPSK	4.540	4.920	4.520	4.960	4.500	4.920
	16QAM	4.500	4.920	4.520	4.940	4.540	4.920
10 MHz	QPSK	8.960	9.680	8.960	9.640	8.960	9.560
	16QAM	8.920	9.640	8.920	9.600	8.960	9.640
15 MHz	QPSK	13.560	14.880	13.500	14.700	13.500	14.820
	16QAM	13.560	14.760	13.560	14.820	13.500	14.700
20 MHz	QPSK	18.000	19.200	17.920	19.360	18.000	19.360
	16QAM	18.080	19.360	18.000	19.280	18.000	19.280

LTE Band 17

Bandwidth	Modulation	Low channel		Middle channel		High channel	
		OBW (MHz)	26dB EBW (MHz)	OBW (MHz)	26dB EBW (MHz)	OBW (MHz)	26dB EBW (MHz)
5 MHz	QPSK	4.540	5.200	4.540	5.200	4.520	5.160
	16QAM	4.520	5.160	4.560	5.160	4.560	5.240
10 MHz	QPSK	8.960	9.880	8.960	9.800	8.960	9.800
	16QAM	8.960	9.880	8.960	9.840	8.960	9.880

LTE Band 38

Bandwidth	Modulation	Low channel		Middle channel		High channel	
		OBW (MHz)	26dB EBW (MHz)	OBW (MHz)	26dB EBW (MHz)	OBW (MHz)	26dB EBW (MHz)
5 MHz	QPSK	4.520	5.140	4.500	5.180	4.540	5.020
	16QAM	4.520	5.400	4.500	5.022	4.500	5.080
10 MHz	QPSK	8.960	9.600	8.960	9.680	8.960	9.720
	16QAM	8.960	9.520	8.960	9.560	8.960	10.200
15 MHz	QPSK	13.560	15.660	13.500	15.670	13.560	15.237
	16QAM	13.500	15.840	13.620	15.910	13.560	15.814
20 MHz	QPSK	18.000	19.760	18.000	19.360	18.000	19.920
	16QAM	18.000	19.280	18.000	20.240	18.000	19.280

LTE Band 41

Bandwidth	Modulation	Low channel		Middle channel		High channel	
		OBW (MHz)	26dB EBW (MHz)	OBW (MHz)	26dB EBW (MHz)	OBW (MHz)	26dB EBW (MHz)
5 MHz	QPSK	4.500	4.960	4.520	5.420	4.500	5.020
	16QAM	4.500	5.135	4.500	5.080	4.500	5.040
10 MHz	QPSK	8.960	9.600	8.960	9.760	8.960	9.840
	16QAM	8.960	9.520	8.960	9.520	8.960	9.800
15 MHz	QPSK	13.560	15.420	13.500	15.360	13.500	15.480
	16QAM	13.500	15.660	13.560	15.900	13.560	16.192
20 MHz	QPSK	18.000	19.200	18.000	19.680	18.000	19.440
	16QAM	18.000	19.360	18.000	20.400	18.000	19.360

LTE Band 66:

Bandwidth	Modulation	Low channel		Middle channel		High channel	
		OBW (MHz)	26dB EBW (MHz)	OBW (MHz)	26dB EBW (MHz)	OBW (MHz)	26dB EBW (MHz)
1.4 MHz	QPSK	1.104	1.288	1.098	1.314	1.104	1.308
	16QAM	1.098	1.290	1.104	1.314	1.098	1.284
3 MHz	QPSK	2.688	2.868	2.688	2.880	2.688	2.892
	16QAM	2.688	2.904	2.688	2.880	2.688	2.880
5 MHz	QPSK	4.540	5.120	4.540	5.140	4.520	5.140
	16QAM	4.540	5.100	4.540	5.200	4.540	5.260
10 MHz	QPSK	8.960	9.920	8.960	9.840	8.960	9.880
	16QAM	8.960	9.760	8.960	9.920	8.960	9.960
15 MHz	QPSK	13.620	15.240	13.500	15.120	13.560	15.120
	16QAM	13.560	15.180	13.500	15.180	13.560	15.060
20 MHz	QPSK	18.000	19.440	18.000	19.760	18.000	19.760
	16QAM	18.000	19.680	18.000	19.920	18.000	19.440

The test plots of LTE band please refer to the Appendix A.

FCC §2.1051, §22.917(a) & §24.238(a); §27.53 - SPURIOUS EMISSIONS AT ANTENNA TERMINALS

Applicable Standard

FCC §2.1051, §22.917(a) and §24.238(a) and §27.53.

The spectrum was to be investigated to the tenth harmonics of the highest fundamental frequency as specified in § 2.1051.

Test Procedure

The RF output of the transceiver was connected to a spectrum analyzer and simulator through appropriate attenuation. The resolution bandwidth of the spectrum analyzer was set at 1MHz. Sufficient scans were taken to show any out of band emissions up to 10th harmonic.

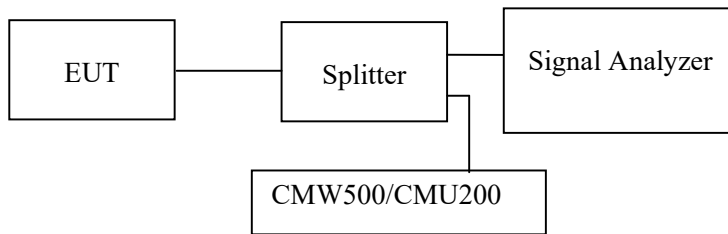

Test Data

Environmental Conditions

Temperature:	28.5~29.2 °C
Relative Humidity:	51~53 %
ATM Pressure:	101.0 kPa

The testing was performed by Pedro Yun from 2021-08-06 to 2021-08-18.

EUT operation mode: Transmitting

Test result: Pass

Please refer to the following plots.

**Cellular Band (Part 22H)
Low Channel:**

30 MHz – 1 GHz (GSM Mode)

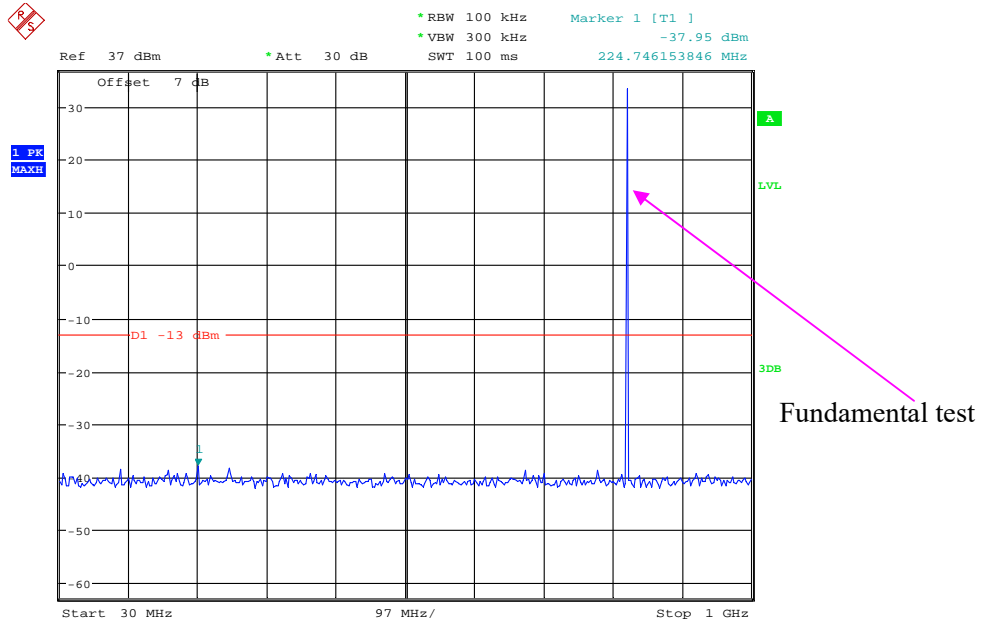

Date: 6.AUG.2021 23:22:07

1 GHz – 10 GHz (GSM Mode)

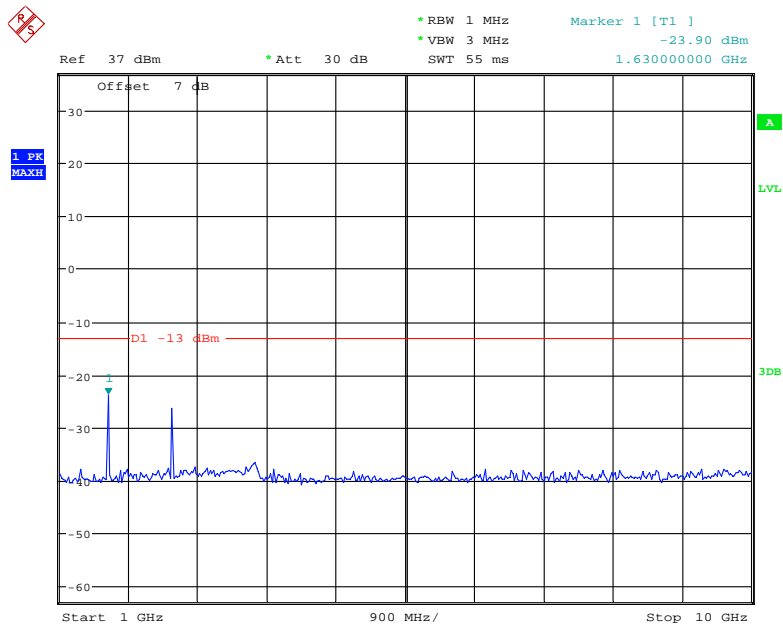

Date: 6.AUG.2021 23:22:30

30 MHz – 1 GHz (WCDMA Mode)

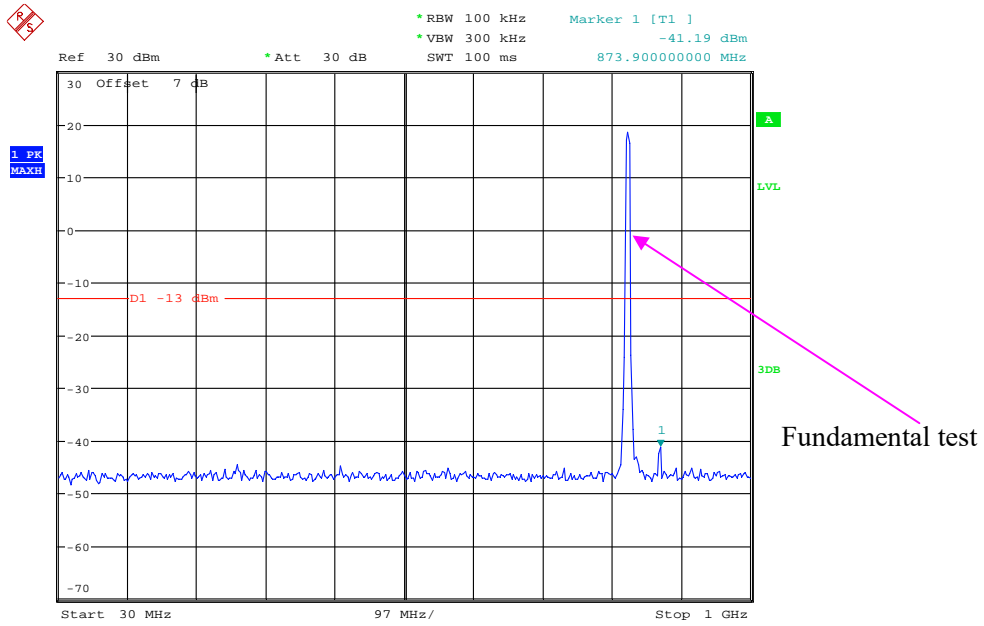

Date: 6.AUG.2021 21:48:00

1 GHz – 20 GHz (WCDMA Mode)

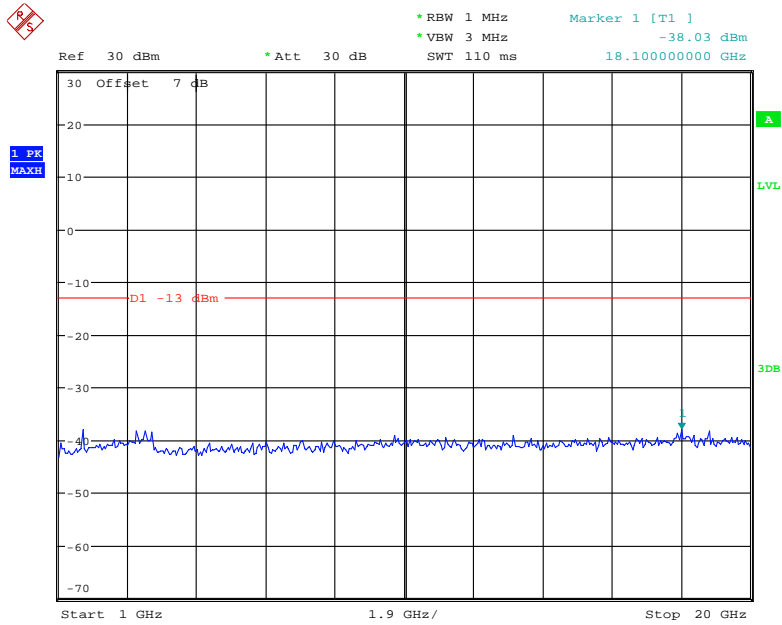

Date: 6.AUG.2021 21:49:44

Middle Channel:

30 MHz – 1 GHz (GSM Mode)

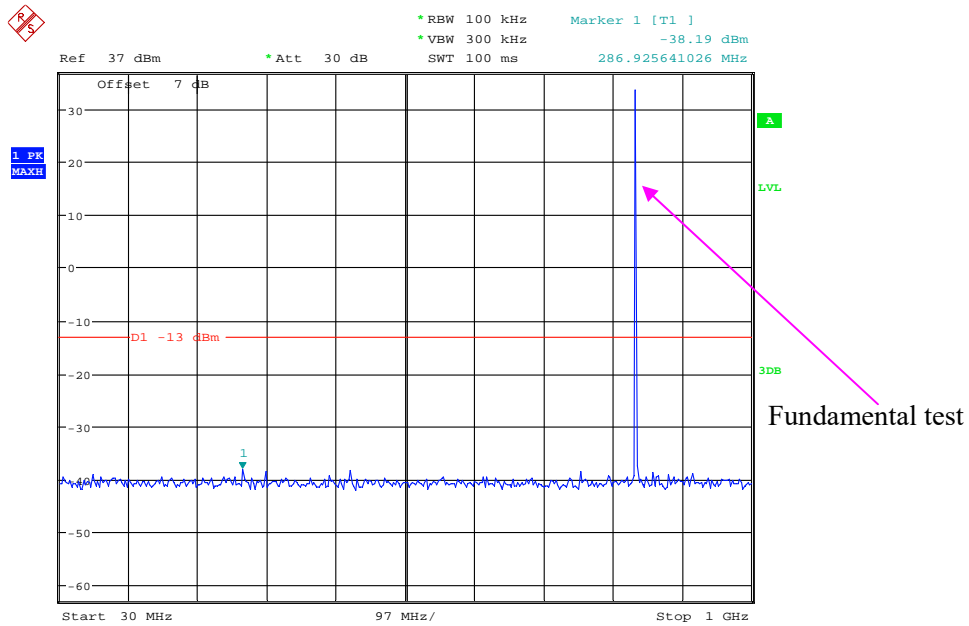

Date: 6.AUG.2021 23:21:45

1 GHz – 10 GHz (GSM Mode)

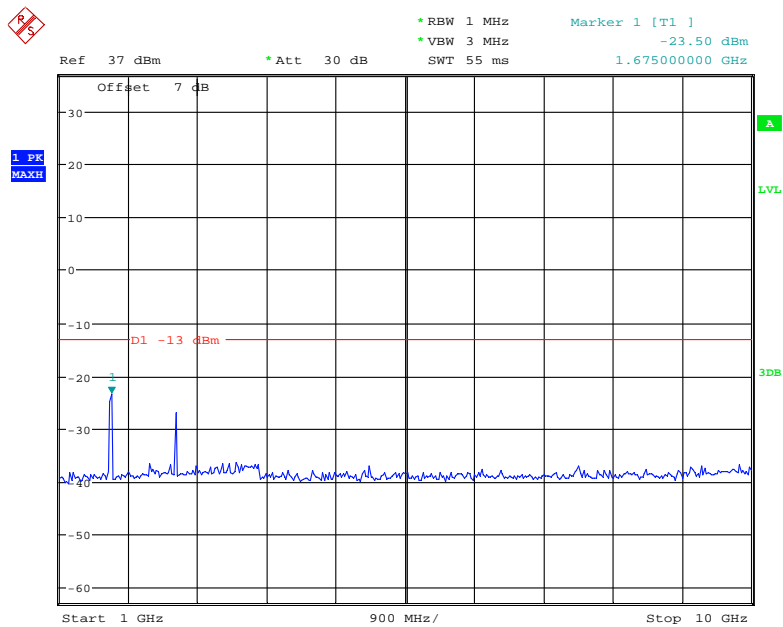

Date: 6.AUG.2021 23:23:14

30 MHz – 1 GHz (WCDMA Mode)

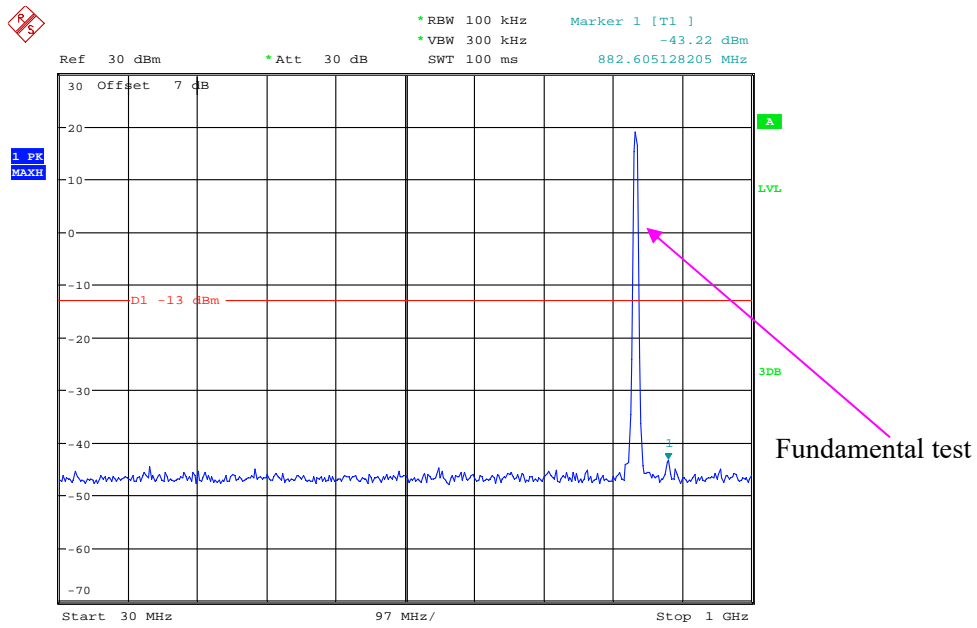

Date: 6.AUG.2021 21:48:30

1 GHz – 20 GHz (WCDMA Mode)

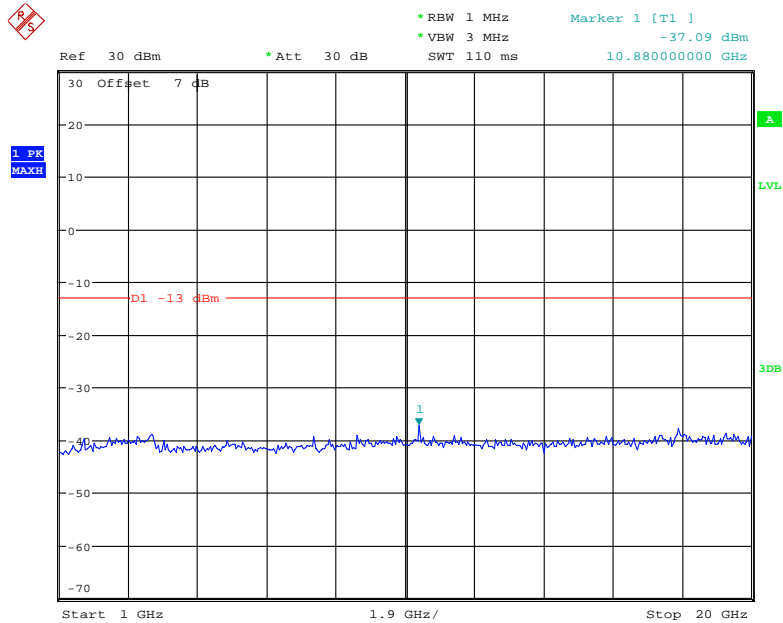

Date: 6.AUG.2021 21:50:04

High Channel:

30 MHz – 1 GHz (GSM Mode)

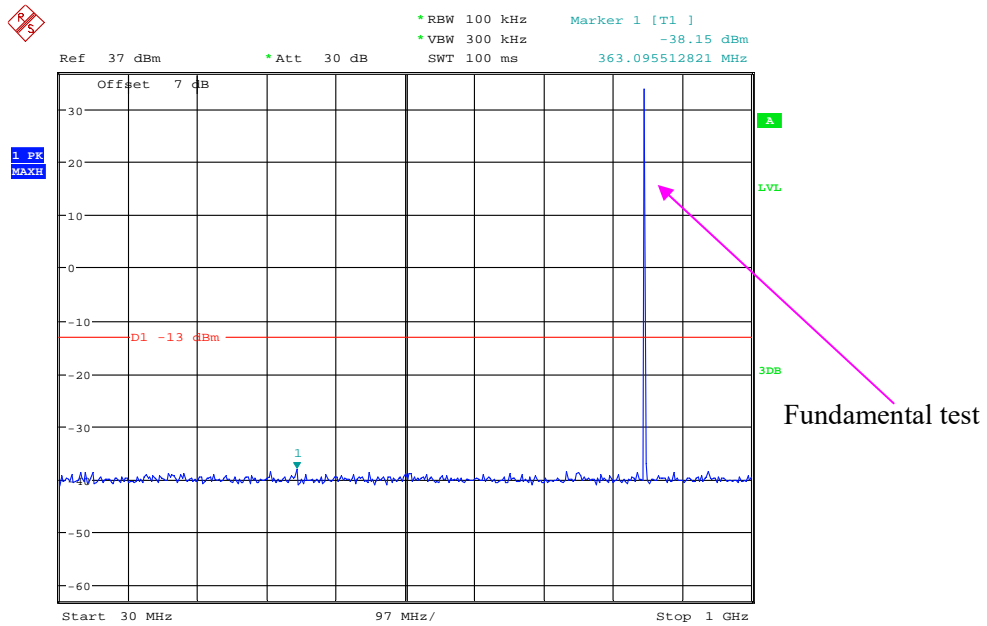

Date: 6.AUG.2021 23:21:02

1 GHz – 10 GHz (GSM Mode)

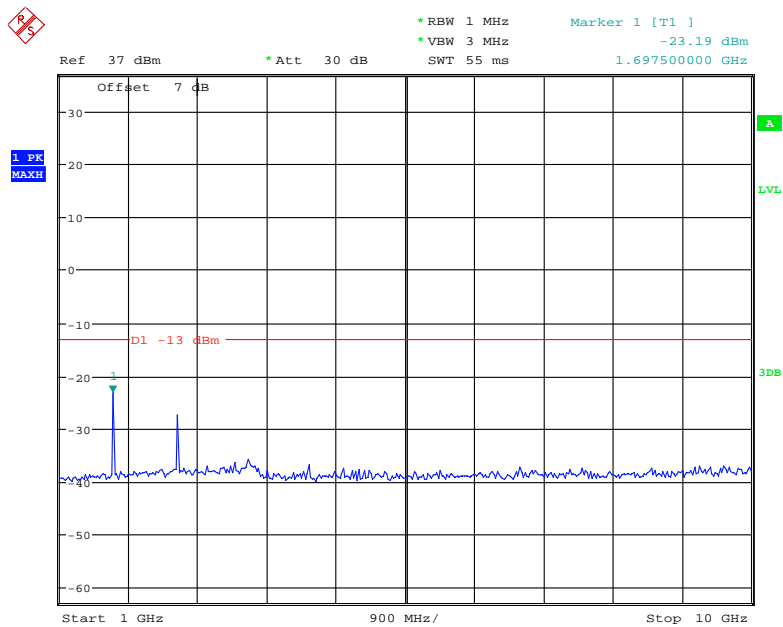

Date: 6.AUG.2021 23:24:06

30 MHz – 1 GHz (WCDMA Mode)

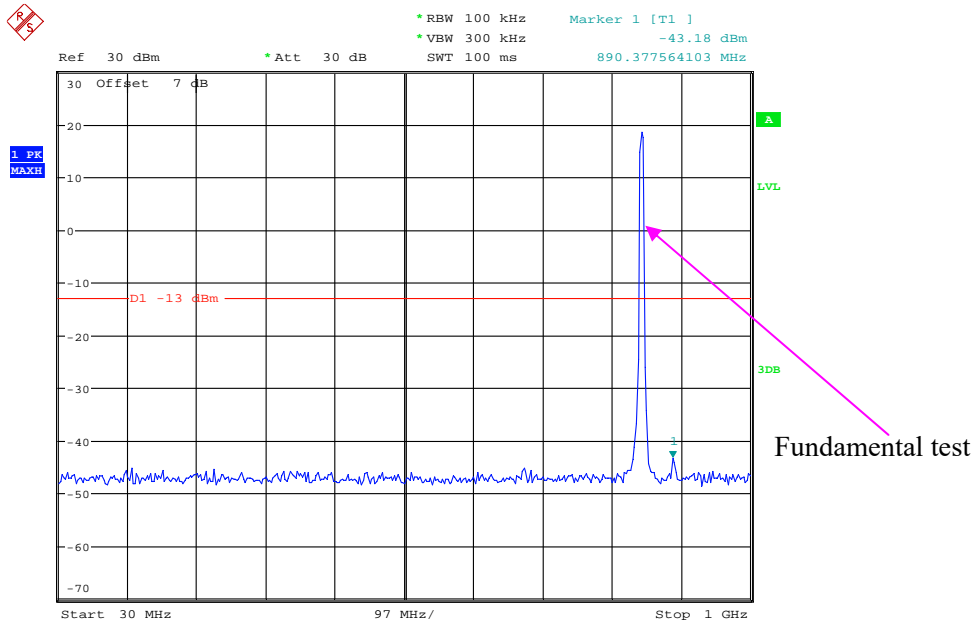

Date: 6.AUG.2021 21:48:53

1 GHz – 20 GHz (WCDMA Mode)

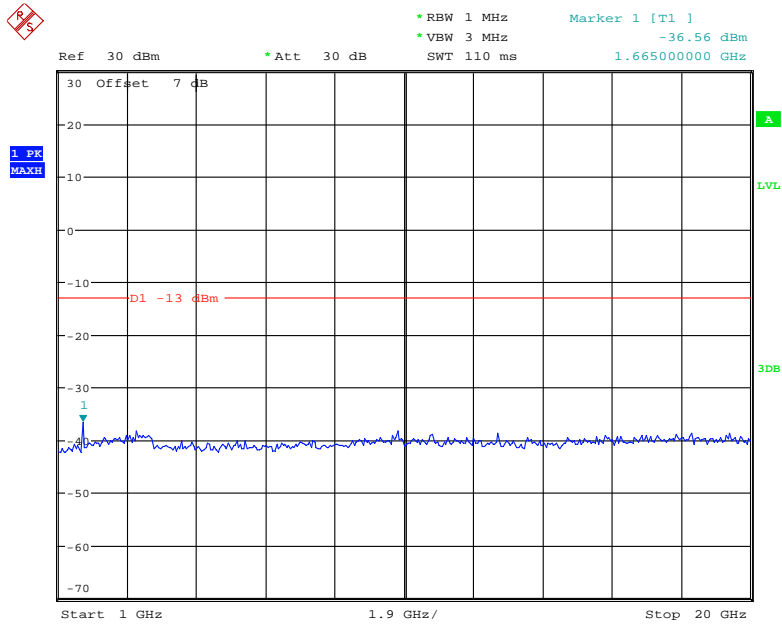

Date: 6.AUG.2021 21:49:22

PCS Band (Part 24E) Low Channel:

30 MHz – 1 GHz (GSM Mode)

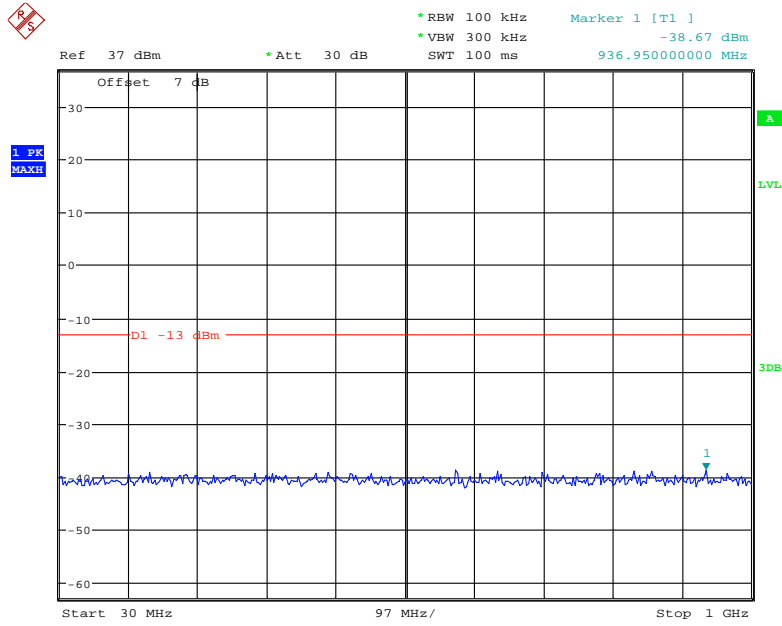

Date: 6.AUG.2021 23:39:17

1 GHz – 2 GHz (GSM Mode)

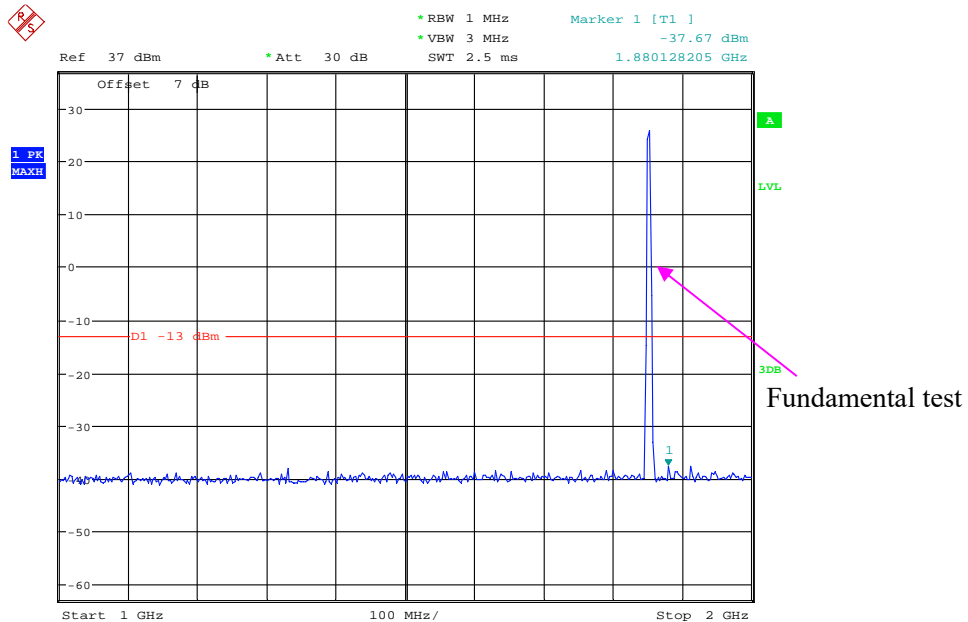

Date: 6.AUG.2021 23:39:50

2 GHz – 20 GHz (GSM Mode)

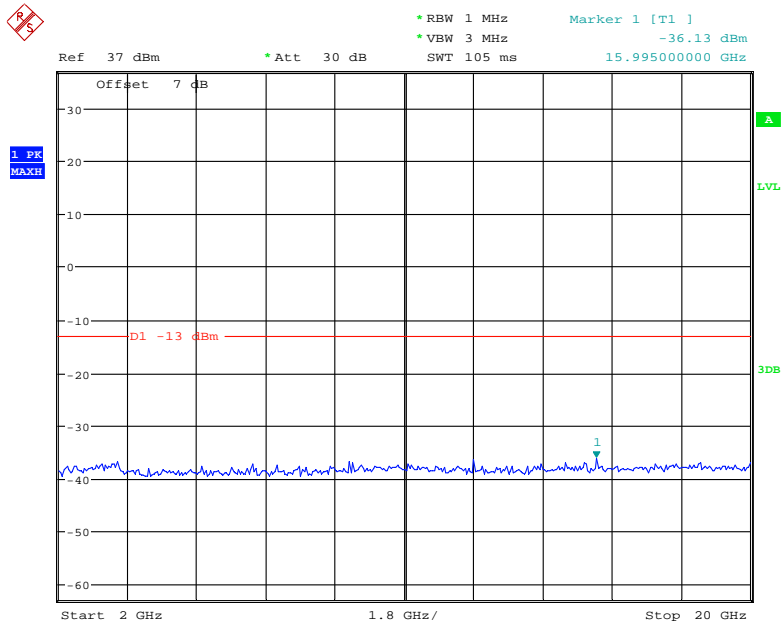

Date: 6.AUG.2021 23:41:47

30 MHz – 1 GHz (WCDMA Mode)

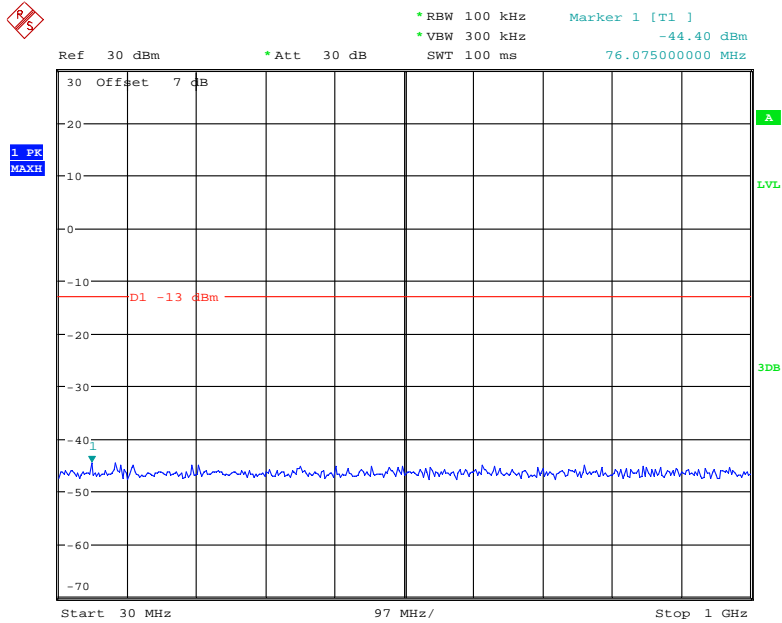

Date: 6.AUG.2021 21:45:43

1 GHz – 20 GHz (WCDMA Mode)

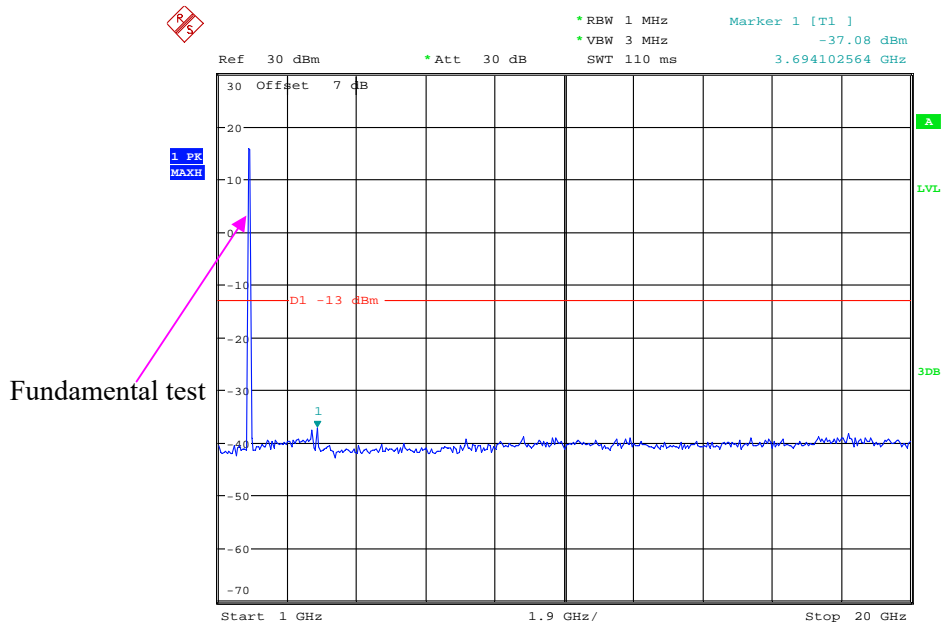

Date: 6.AUG.2021 21:52:01

Middle Channel:

30 MHz – 1 GHz (GSM Mode)

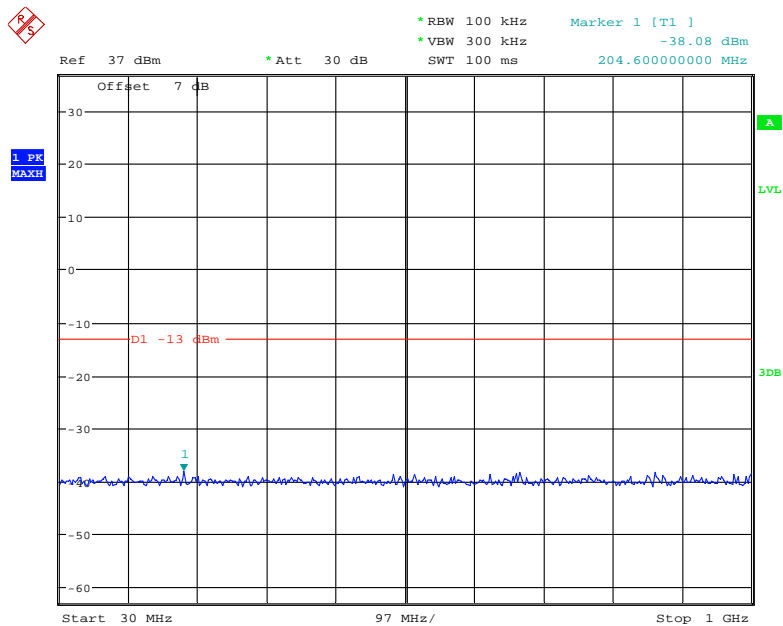

Date: 6.AUG.2021 23:38:59

1 GHz – 2 GHz (GSM Mode)

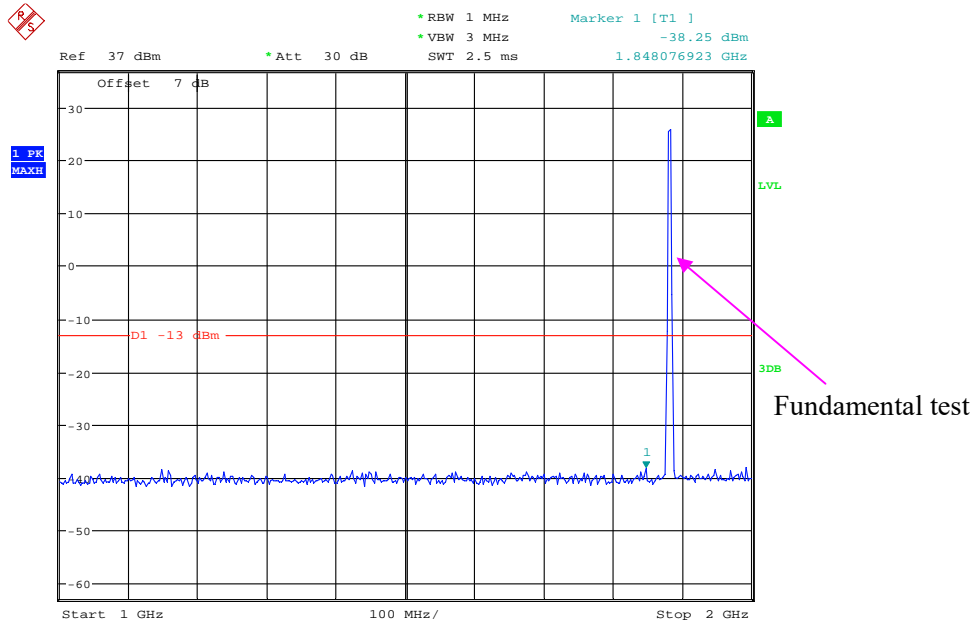

Date: 6.AUG.2021 23:40:20

2 GHz – 20 GHz (GSM Mode)

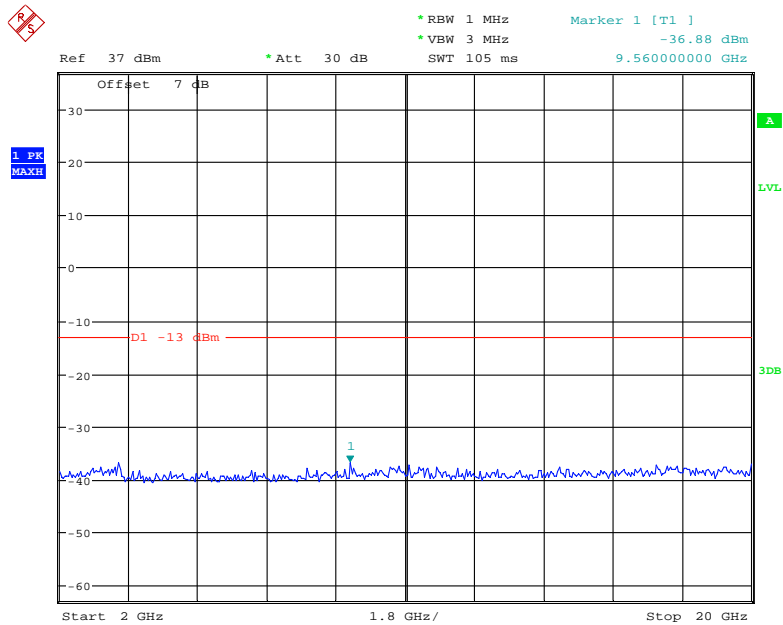

Date: 6.AUG.2021 23:41:33

30 MHz – 1 GHz (WCDMA Mode)

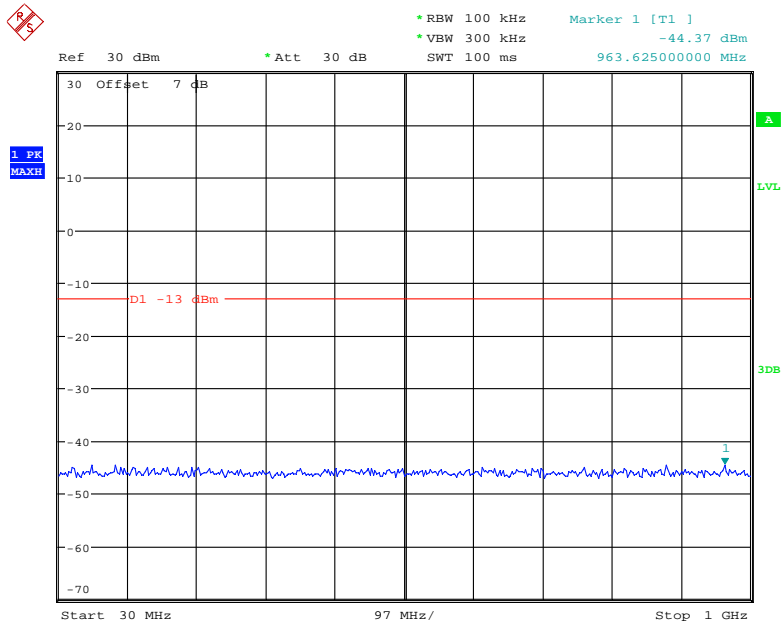

Date: 6.AUG.2021 21:46:10

1 GHz – 20 GHz (WCDMA Mode)

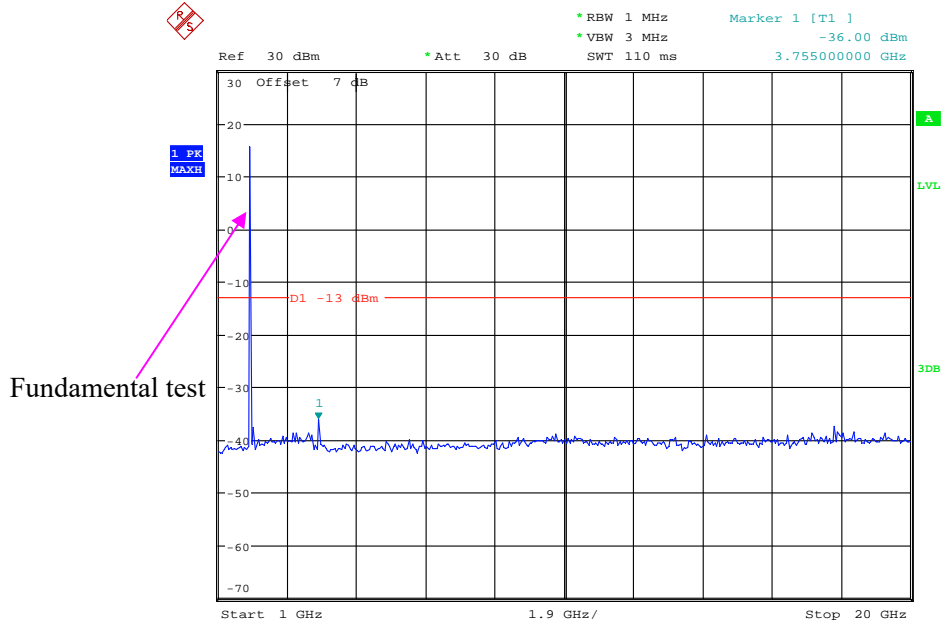

Date: 6.AUG.2021 21:52:25

High Channel:

30 MHz – 1 GHz (GSM Mode)

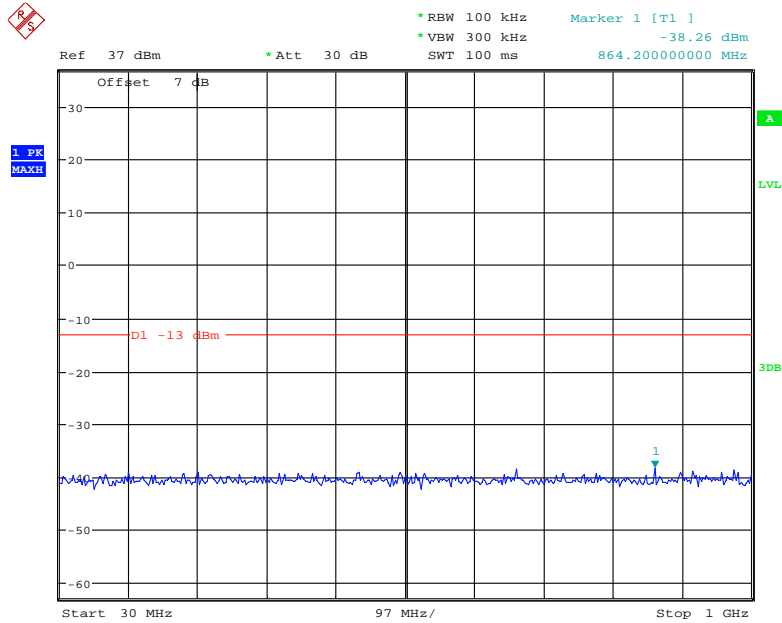

Date: 6.AUG.2021 23:38:32

1 GHz – 2 GHz (GSM Mode)

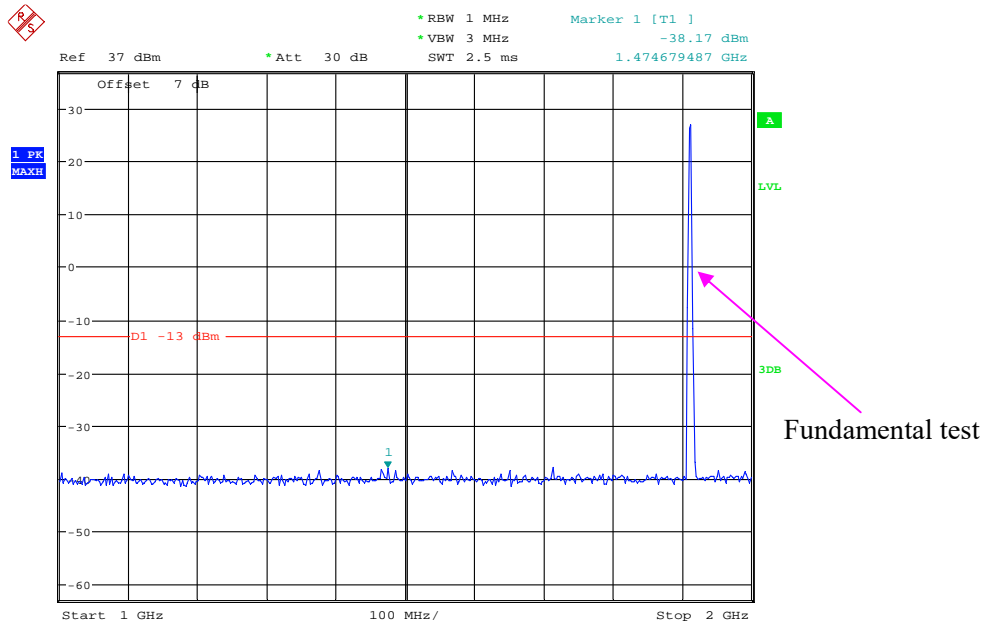

Date: 6.AUG.2021 23:40:43

2 GHz – 20 GHz (GSM Mode)

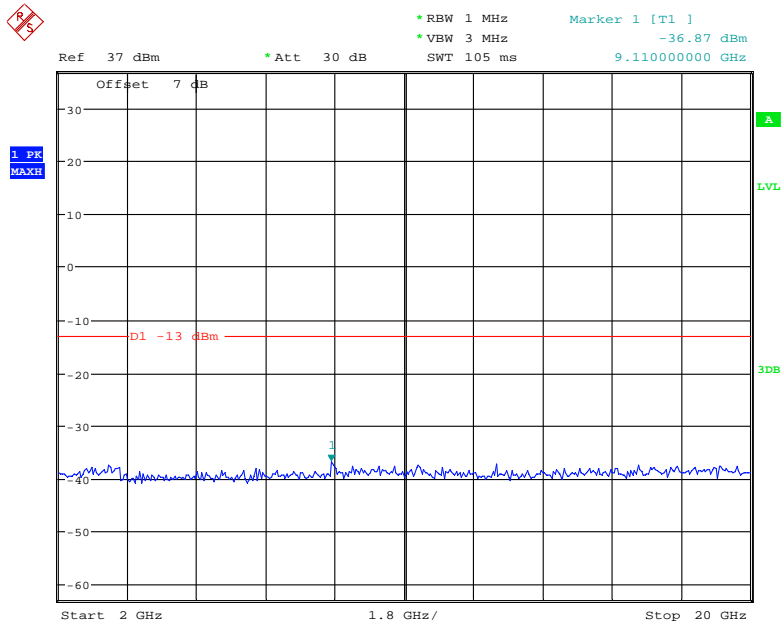

Date: 6.AUG.2021 23:41:12

30 MHz – 1 GHz (WCDMA Mode)

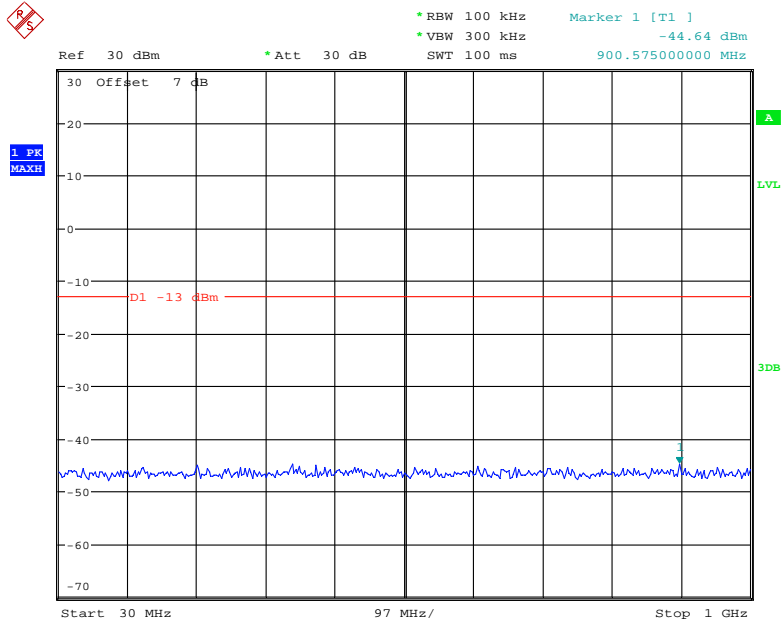

Date: 6.AUG.2021 21:46:41

1 GHz – 20 GHz (WCDMA Mode)

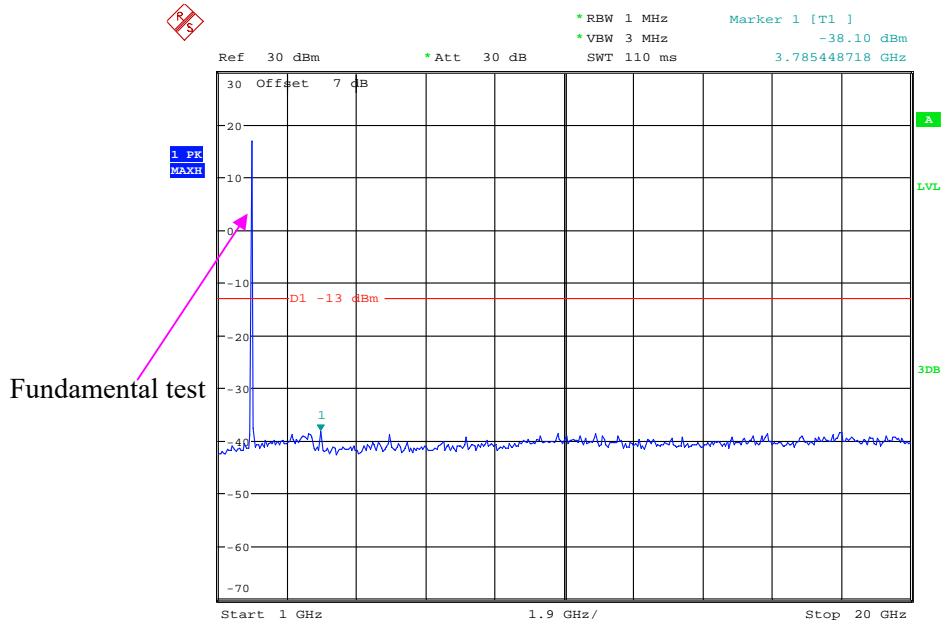

Date: 6.AUG.2021 21:52:47

**AWS Band (Part 27)
Low Channel:**

30 MHz – 1 GHz (WCDMA Mode)

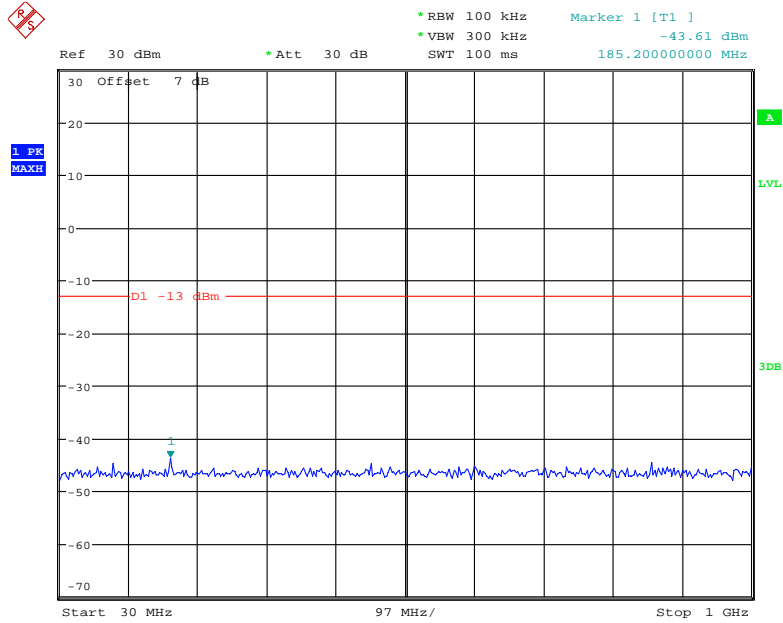

Date: 6.AUG.2021 21:47:12

1 GHz – 20 GHz (WCDMA Mode)

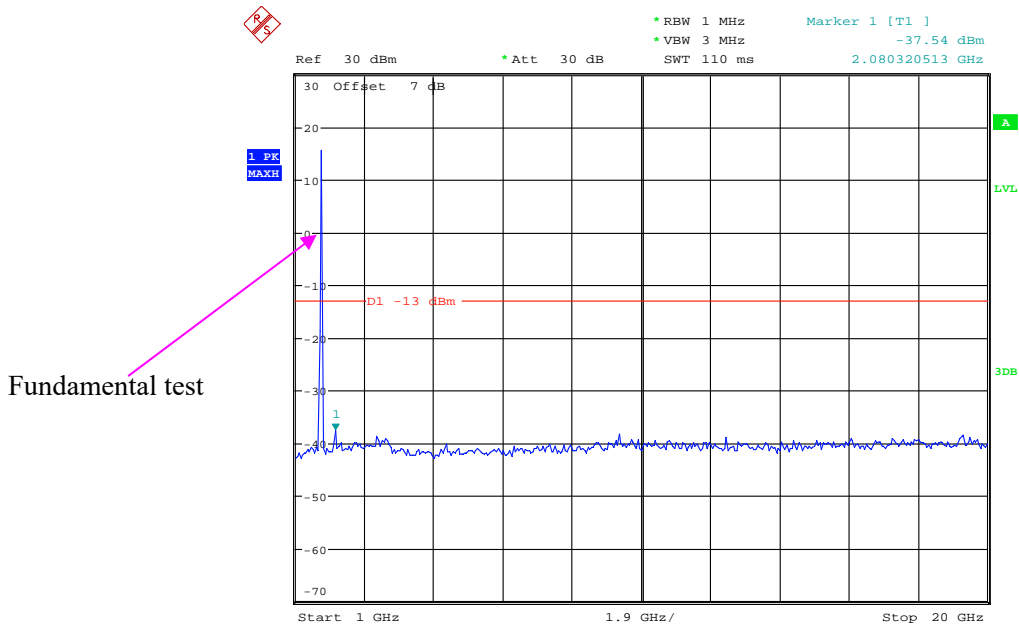

Date: 6.AUG.2021 21:51:29

Middle Channel

30 MHz – 1 GHz (WCDMA Mode)

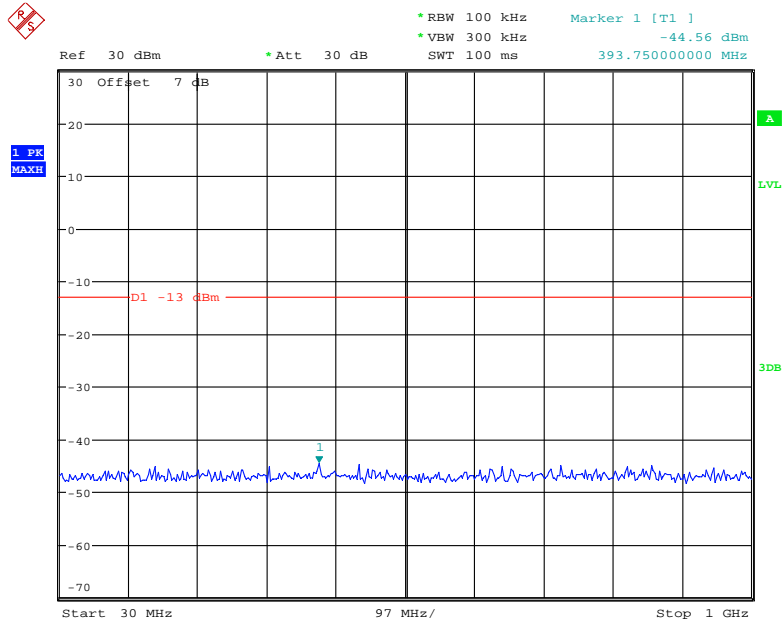

Date: 6.AUG.2021 21:47:27

1 GHz – 20 GHz (WCDMA Mode)

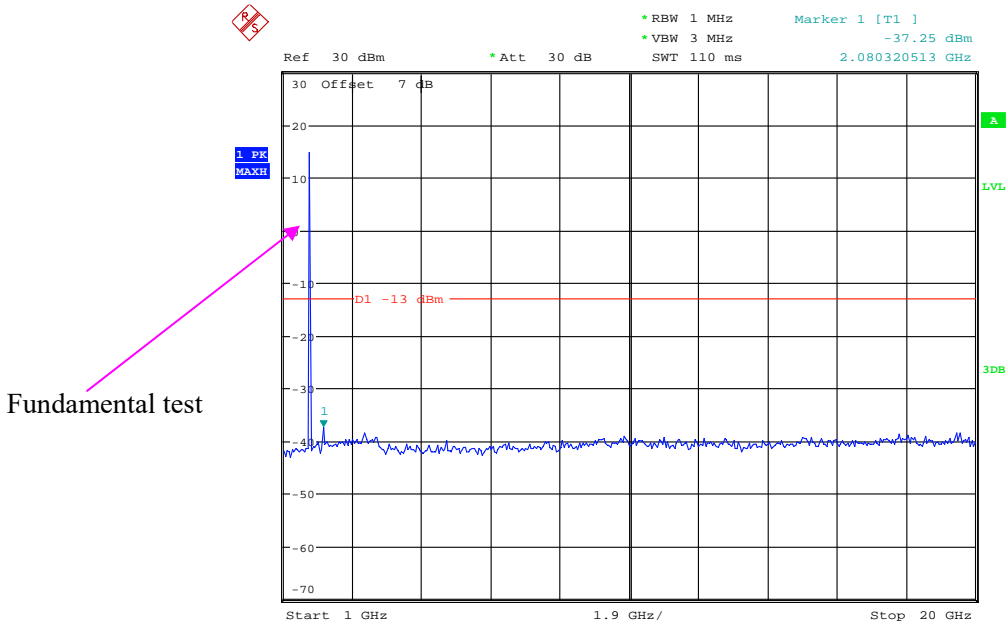

Date: 6.AUG.2021 21:51:10

High Channel:

30 MHz – 1 GHz (WCDMA Mode)

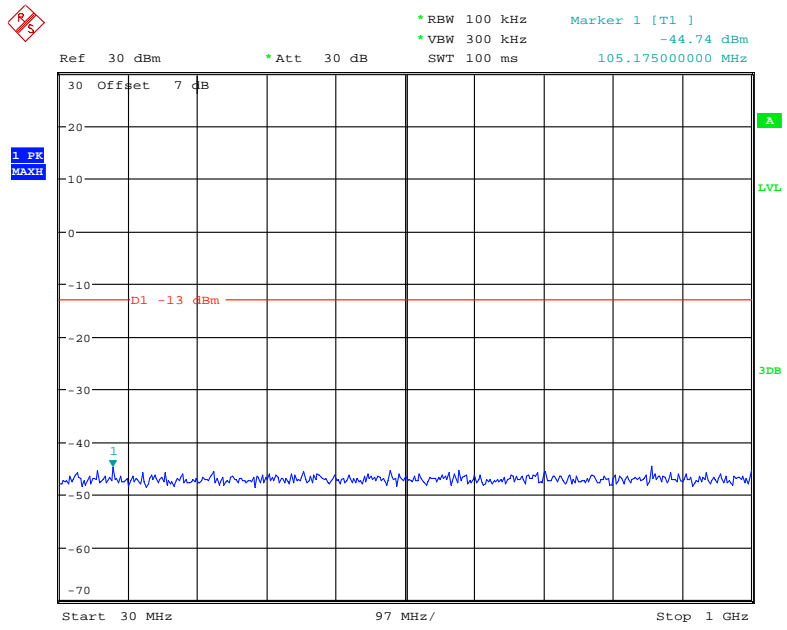

Date: 6.AUG.2021 21:47:04

1 GHz – 20 GHz (WCDMA Mode)

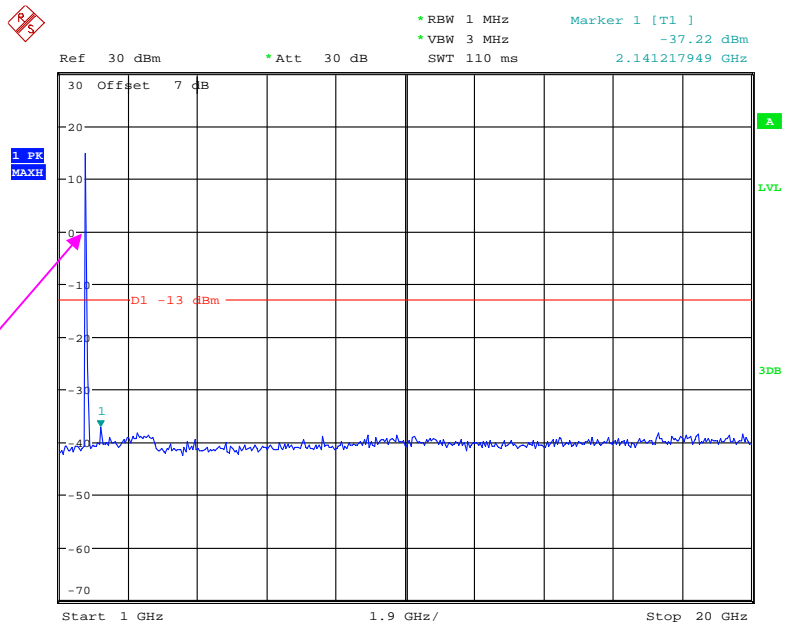

Fundamental test

Date: 6.AUG.2021 21:50:46

The test plots of LTE band please refer to the Appendix B.

FCC § 2.1053; § 22.917 (a); § 24.238 (a); § 27.53 SPURIOUS RADIATED EMISSIONS

Applicable Standard

FCC § 2.1053, § 22.917(a) and § 24.238(a) and § 27.53

Test Procedure

The transmitter was placed on a wooden turntable, and it was transmitting into a non-radiating load which was also placed on the turntable.

The measurement antenna was placed at a distance of 3 meters from the EUT. During the tests, the receiving antenna height and polarization as well as EUT azimuth were varied in order to identify the maximum level of emissions from the EUT. The test was performed by placing the EUT on 3-orthogonal axis.

The frequency range up to tenth harmonic of the fundamental frequency was investigated.

Test Data**Environmental Conditions**

Temperature:	26~28.3 °C
Relative Humidity:	46~56 %
ATM Pressure:	101.0~101.1 kPa

The testing was performed by William Wang and Cloud Qiu on 2021-07-29 for below 1GHz and Hanic Pan on 2021-07-31 for above 1GHz.

EUT operation mode: Transmitting

30 MHz ~ 10 GHz:

Cellular Band (Part 22H)

Frequency (MHz)	Receiver Reading (dBµV)	Turntable Angle Degree	Rx Antenna		Substituted			Absolute Level (dBm)	FCC Part 22H	
			Height (m)	Polar (H/V)	Level (dBm)	Cable Loss (dB)	Antenna Gain (dBd/dBi)		Limit (dBm)	Margin (dB)
GSM Mode										
Low channel										
952.3	30.11	302	2.3	H	-66.4	1.36	0.0	-67.76	-13	54.76
952.3	31.52	5	1.8	V	-62.5	1.36	0.0	-63.86	-13	50.86
1648.40	50.01	186	1.1	H	-58.1	1.40	8.70	-50.80	-13	37.80
1648.40	47.89	330	2.0	V	-60.0	1.40	8.70	-52.70	-13	39.70
2472.60	46.31	207	1.2	H	-57.0	2.60	10.20	-49.40	-13	36.40
2472.60	48.62	198	1.7	V	-54.1	2.60	10.20	-46.50	-13	33.50
Middle channel										
960.1	30.24	272	1.4	H	-66.3	1.36	0.0	-67.66	-13	54.66
960.1	31.67	156	1.7	V	-62.4	1.36	0.0	-63.76	-13	50.76
1673.20	50.01	186	1.1	H	-58.1	1.40	8.70	-50.80	-13	37.80
1673.20	47.89	330	2.0	V	-60.0	1.40	8.70	-52.70	-13	39.70
2472.60	46.31	207	1.2	H	-57.0	2.60	10.20	-49.40	-13	36.40
2472.60	48.62	198	1.7	V	-54.1	2.60	10.20	-46.50	-13	33.50
High channel										
954.8	30.28	233	2.5	H	-66.2	1.36	0.0	-67.56	-13	54.56
954.8	31.61	357	1.0	V	-62.4	1.36	0.0	-63.76	-13	50.76
1697.60	48.33	135	1.6	H	-58.0	1.30	8.90	-50.40	-13	37.40
1697.60	46.91	332	1.6	V	-58.8	1.30	8.90	-51.20	-13	38.20
2546.40	45.03	254	2.3	H	-58.3	2.60	10.20	-50.70	-13	37.70
2546.40	46.91	10	1.2	V	-55.8	2.60	10.20	-48.20	-13	35.20

Frequency (MHz)	Receiver Reading (dBµV)	Turntable Angle Degree	Rx Antenna		Substituted			Absolute Level (dBm)	FCC Part 22H	
			Height (m)	Polar (H/V)	Level (dBm)	Cable Loss (dB)	Antenna Gain (dBd/dBi)		Limit (dBm)	Margin (dB)
WCDMA Mode										
Low channel										
950.3	30.59	26	2.5	H	-65.9	1.36	0.0	-67.26	-13	54.26
950.3	31.91	176	1.0	V	-62.1	1.36	0.0	-63.46	-13	50.46
1652.80	48.63	101	2.1	H	-57.7	1.30	8.90	-50.10	-13	37.10
1652.80	48.29	310	2.2	V	-57.4	1.30	8.90	-49.80	-13	36.80
2479.20	43.76	312	1.4	H	-59.6	2.60	10.20	-52.00	-13	39.00
2479.20	45.01	135	1.4	V	-57.7	2.60	10.20	-50.10	-13	37.10
Middle channel										
951.2	30.56	223	2.3	H	-65.9	1.36	0.0	-67.26	-13	54.26
951.2	31.47	145	1.2	V	-62.6	1.36	0.0	-63.96	-13	50.96
1673.20	49.11	266	2.4	H	-57.2	1.30	8.90	-49.60	-13	36.60
1673.20	48.58	328	1.5	V	-57.2	1.30	8.90	-49.60	-13	36.60
2509.80	44.01	46	1.6	H	-59.3	2.60	10.20	-51.70	-13	38.70
2509.80	44.72	334	1.3	V	-58.0	2.60	10.20	-50.40	-13	37.40
High channel										
960.8	30.36	256	1.4	H	-66.1	1.36	0.0	-67.46	-13	54.46
960.8	31.42	202	1.3	V	-62.6	1.36	0.0	-63.96	-13	50.96
1693.20	50.93	213	1.2	H	-55.4	1.30	8.90	-47.80	-13	34.80
1693.20	47.21	135	2.0	V	-58.5	1.30	8.90	-50.90	-13	37.90
2539.80	44.13	136	2.0	H	-59.2	2.60	10.20	-51.60	-13	38.60
2539.80	43.69	294	1.5	V	-59.1	2.60	10.20	-51.50	-13	38.50

30 MHz ~ 20 GHz:

PCS Band (Part 24E)

Frequency (MHz)	Receiver Reading (dBµV)	Turntable Angle Degree	Rx Antenna		Substituted			Absolute Level (dBm)	FCC Part 24E	
			Height (m)	Polar (H/V)	Level (dBm)	Cable Loss (dB)	Antenna Gain (dBd/dBi)		Limit (dBm)	Margin (dB)
GSM Mode										
Low channel										
952.1	30.53	246	1.2	H	-66.0	1.36	0.0	-67.36	-13	54.36
952.1	31.41	255	1.5	V	-62.6	1.36	0.0	-63.96	-13	50.96
3700.40	43.67	128	2.4	H	-58.1	1.60	11.90	-47.80	-13	34.80
3700.40	43.50	80	2.0	V	-57.7	1.60	11.90	-47.40	-13	34.40
Middle channel										
952.6	30.43	60	2.0	H	-66.1	1.36	0.0	-67.46	-13	54.46
952.6	31.48	11	1.2	V	-62.6	1.36	0.0	-63.96	-13	50.96
3760.00	44.01	29	1.3	H	-58.0	1.50	11.80	-47.70	-13	34.70
3760.00	43.61	165	2.2	V	-58.0	1.50	11.80	-47.70	-13	34.70
High channel										
952.8	30.39	91	1.7	H	-66.1	1.36	0.0	-67.46	-13	54.46
952.8	31.55	202	1.1	V	-62.5	1.36	0.0	-63.86	-13	50.86
3819.60	44.06	249	1.3	H	-58.0	1.50	11.80	-47.70	-13	34.70
3819.60	43.61	295	1.1	V	-58.0	1.50	11.80	-47.70	-13	34.70
WCDMA Mode										
Low Channel										
950.8	30.87	133	2.4	H	-65.6	1.36	0.0	-66.96	-13	53.96
950.8	31.98	177	2.1	V	-62.1	1.36	0.0	-63.46	-13	50.46
3704.80	49.10	238	2.1	H	-52.7	1.60	11.90	-42.40	-13	29.40
3704.80	47.28	319	1.8	V	-53.9	1.60	11.90	-43.60	-13	30.60
Middle channel										
950.8	30.87	133	2.4	H	-65.6	1.36	0.0	-66.96	-13	53.96
950.8	31.98	177	2.1	V	-62.1	1.36	0.0	-63.46	-13	50.46
3760.00	50.73	65	1.8	H	-51.3	1.50	11.80	-41.00	-13	28.00
3760.00	46.59	214	1.9	V	-55.0	1.50	11.80	-44.70	-13	31.70
High channel										
949.2	30.67	219	1.8	H	-65.8	1.36	0.0	-67.16	-13	54.16
949.2	31.87	120	2.0	V	-62.2	1.36	0.0	-63.56	-13	50.56
3815.20	50.99	353	1.5	H	-51.1	1.50	11.80	-40.80	-13	27.80
3815.20	48.83	112	2.2	V	-52.8	1.50	11.80	-42.50	-13	29.50

30 MHz ~ 20 GHz:

AWS Band

Frequency (MHz)	Receiver Reading (dBµV)	Turntable Angle Degree	Rx Antenna		Substituted			Absolute Level (dBm)	FCC Part 27	
			Height (m)	Polar (H/V)	Level (dBm)	Cable Loss (dB)	Antenna Gain (dBd/dBi)		Limit (dBm)	Margin (dB)
WCDMA Mode										
Low channel										
952.3	30.62	302	1.8	H	-65.9	1.36	0.0	-67.26	-13	54.26
952.3	31.84	108	1.0	V	-62.2	1.36	0.0	-63.56	-13	50.56
3424.80	46.83	286	1.0	H	-54.0	1.40	11.80	-43.60	-13	30.60
3424.80	44.29	309	1.1	V	-56.3	1.40	11.80	-45.90	-13	32.90
Middle channel										
950.6	30.77	182	2.0	H	-65.7	1.36	0.0	-67.06	-13	54.06
950.6	31.88	171	1.1	V	-62.2	1.36	0.0	-63.56	-13	50.56
3465.20	45.73	112	1.9	H	-55.0	1.50	12.00	-44.50	-13	31.50
3465.20	44.67	141	1.3	V	-56.8	1.50	12.00	-46.30	-13	33.30
High channel										
953.8	30.73	81	1.9	H	-65.8	1.36	0.0	-67.16	-13	54.16
953.8	31.96	130	1.3	V	-62.1	1.36	0.0	-63.46	-13	50.46
3505.20	45.90	153	2.3	H	-54.8	1.50	12.00	-44.30	-13	31.30
3505.20	45.37	156	1.4	V	-56.1	1.50	12.00	-45.60	-13	32.60

LTE Band: (Pre-scan with all the bandwidth, and worst case as below)

Frequency (MHz)	Receiver Reading (dBµV)	Turntable Angle Degree	Rx Antenna		Substituted			Absolute Level (dBm)	Limit (dBm)	Margin (dB)
			Height (m)	Polar (H/V)	Level (dBm)	Cable Loss (dB)	Antenna Gain (dBd/dBi)			
Band 2										
Test frequency range: 30 MHz ~ 20 GHz										
1.4MHz, Low channel										
960.6	31.36	126	2.2	H	-65.1	1.36	0.0	-66.46	-13	53.46
960.6	32.41	317	1.5	V	-61.6	1.36	0.0	-62.96	-13	49.96
3701.40	54.77	159	2.0	H	-47.0	1.60	11.90	-36.70	-13	23.70
3701.40	49.02	26	1.3	V	-52.2	1.60	11.90	-41.90	-13	28.90
5552.10	44.39	116	1.6	H	-55.3	1.70	12.40	-44.60	-13	31.60
5552.10	44.01	284	1.0	V	-55.3	1.70	12.40	-44.60	-13	31.60
1.4MHz, Middle channel										
950.3	31.11	249	1.5	H	-65.4	1.36	0.0	-66.76	-13	53.76
950.3	32.47	316	2.1	V	-61.6	1.36	0.0	-62.96	-13	49.96
3760.00	55.56	68	1.5	H	-46.5	1.50	11.80	-36.20	-13	23.20
3760.00	48.15	349	2.2	V	-53.4	1.50	11.80	-43.10	-13	30.10
5640.00	44.88	329	1.9	H	-54.8	1.70	12.40	-44.10	-13	31.10
5640.00	43.52	14	1.2	V	-55.8	1.70	12.40	-45.10	-13	32.10
1.4MHz, High channel										
957.1	31.17	53	1.0	H	-65.3	1.36	0.0	-66.66	-13	53.66
957.1	32.56	118	1.9	V	-61.5	1.36	0.0	-62.86	-13	49.86
3818.60	57.01	64	1.4	H	-45.0	1.50	11.80	-34.70	-13	21.70
3818.60	50.33	206	1.6	V	-51.3	1.50	11.80	-41.00	-13	28.00
5727.90	45.12	43	1.5	H	-54.7	1.60	12.10	-44.20	-13	31.20
5727.90	44.73	76	2.0	V	-54.5	1.60	12.10	-44.00	-13	31.00

Band 4										
Test frequency range:30 MHz ~ 20 GHz										
1.4MHz, Low channel										
953.3	31.46	306	1.9	H	-65.0	1.36	0.0	-66.36	-13	53.36
953.3	32.77	235	1.6	V	-61.3	1.36	0.0	-62.66	-13	49.66
3421.40	47.83	109	1.8	H	-53.0	1.40	11.80	-42.60	-13	29.60
3421.40	45.67	103	1.5	V	-54.9	1.40	11.80	-44.50	-13	31.50
5132.10	46.24	244	1.7	H	-53.8	1.60	12.10	-43.30	-13	30.30
5132.10	46.87	171	1.9	V	-53.1	1.60	12.10	-42.60	-13	29.60
6842.80	47.33	282	1.8	H	-51.4	1.80	11.20	-42.00	-13	29.00
6842.80	50.16	234	2.2	V	-49.0	1.80	11.20	-39.60	-13	26.60
8553.50	44.25	309	1.9	H	-53.8	2.10	11.40	-44.50	-13	31.50
8553.50	43.99	248	1.5	V	-54.1	2.10	11.40	-44.80	-13	31.80
1.4MHz, Middle channel										
958.1	31.42	350	2.4	H	-65.1	1.36	0.0	-66.46	-13	53.46
958.1	32.73	236	2.3	V	-61.3	1.36	0.0	-62.66	-13	49.66
3465.00	48.98	286	1.5	H	-51.8	1.50	12.00	-41.30	-13	28.30
3465.00	45.61	297	2.0	V	-55.9	1.50	12.00	-45.40	-13	32.40
5197.50	45.23	283	1.2	H	-54.9	1.60	12.10	-44.40	-13	31.40
5197.50	46.99	296	1.1	V	-52.6	1.60	12.10	-42.10	-13	29.10
6930.00	48.14	148	1.4	H	-50.2	1.80	11.30	-40.70	-13	27.70
6930.00	49.31	172	1.1	V	-49.2	1.80	11.30	-39.70	-13	26.70
8662.50	44.87	298	2.1	H	-53.1	2.10	11.40	-43.80	-13	30.80
8662.50	46.29	120	1.7	V	-51.8	2.10	11.40	-42.50	-13	29.50
1.4MHz, High channel										
949.1	31.59	63	2.1	H	-64.9	1.36	0.0	-66.26	-13	53.26
949.1	32.53	229	1.5	V	-61.5	1.36	0.0	-62.86	-13	49.86
3508.60	50.11	153	1.8	H	-50.6	1.50	12.00	-40.10	-13	27.10
3508.60	46.83	100	2.0	V	-54.7	1.50	12.00	-44.20	-13	31.20
5262.90	46.33	133	1.4	H	-53.4	1.60	12.20	-42.80	-13	29.80
5262.90	47.29	98	1.1	V	-51.9	1.60	12.20	-41.30	-13	28.30
7017.20	47.53	199	1.7	H	-51.3	1.90	11.20	-42.00	-13	29.00
7017.20	50.27	305	1.3	V	-48.7	1.90	11.20	-39.40	-13	26.40
8771.50	45.33	133	1.7	H	-52.1	2.10	11.60	-42.60	-13	29.60
8771.50	45.79	81	1.5	V	-51.1	2.10	11.60	-41.60	-13	28.60

Frequency (MHz)	Receiver	Turntable Angle Degree	Rx Antenna		Substituted			Absolute Level (dBm)	Limit (dBm)	Margin (dB)
	Reading (dBμV)		Height (m)	Polar (H/V)	Level (dBm)	Cable Loss (dB)	Antenna Gain (dBd/dBi)			
Band 5										
Test frequency range:30 MHz ~ 10 GHz										
1.4MHz, Low channel										
952.8	31.55	352	1.8	H	-65.0	1.36	0.0	-66.36	-13	53.36
952.8	32.51	332	1.3	V	-61.5	1.36	0.0	-62.86	-13	49.86
1649.40	46.97	110	2.1	H	-61.1	1.40	8.70	-53.80	-13	40.80
1649.40	45.2	84	1.5	V	-62.7	1.40	8.70	-55.40	-13	42.40
2474.10	53.97	64	2.0	H	-49.4	2.60	10.20	-41.80	-13	28.80
2474.10	47.39	239	1.8	V	-55.4	2.60	10.20	-47.80	-13	34.80
3298.80	48.22	303	1.9	H	-52.7	1.50	11.70	-42.50	-13	29.50
3298.80	45.73	86	1.4	V	-55.2	1.50	11.70	-45.00	-13	32.00
4123.50	49.22	205	1.9	H	-52.9	1.40	12.20	-42.10	-13	29.10
4123.50	46.37	270	1.4	V	-54.7	1.40	12.20	-43.90	-13	30.90
4948.20	50.18	23	1.5	H	-50.0	1.60	12.10	-39.50	-13	26.50
4948.20	52.60	263	1.8	V	-47.8	1.60	12.10	-37.30	-13	24.30
1.4MHz, Middle channel										
955.2	31.47	80	1.9	H	-65.0	1.36	0.0	-66.36	-13	53.36
955.2	32.57	352	1.3	V	-61.5	1.36	0.0	-62.86	-13	49.86
1673.00	47.73	82	1.3	H	-58.6	1.30	8.90	-51.00	-13	38.00
1673.00	45.19	329	1.2	V	-60.5	1.30	8.90	-52.90	-13	39.90
2509.50	52.69	78	2.4	H	-50.7	2.60	10.20	-43.10	-13	30.10
2509.50	47.7	52	1.7	V	-55.0	2.60	10.20	-47.40	-13	34.40
3346.00	47.15	37	2.1	H	-53.7	1.50	11.70	-43.50	-13	30.50
3346.00	46.51	179	1.8	V	-54.4	1.50	11.70	-44.20	-13	31.20
4182.50	51.46	108	1.3	H	-50.5	1.50	11.80	-40.20	-13	27.20
4182.50	47.96	287	2.1	V	-53.2	1.50	11.80	-42.90	-13	29.90
5019.00	51.08	115	1.0	H	-47.7	1.70	12.00	-37.40	-13	24.40
5019.00	53.71	179	1.6	V	-44.5	1.70	12.00	-34.20	-13	21.20
1.4MHz, High channel										
949.6	31.43	196	1.6	H	-65.1	1.36	0.0	-66.46	-13	53.46
949.6	32.44	47	1.8	V	-61.6	1.36	0.0	-62.96	-13	49.96
1696.60	47.69	245	1.6	H	-58.6	1.30	8.90	-51.00	-13	38.00
1696.60	46.83	228	2.4	V	-58.9	1.30	8.90	-51.30	-13	38.30
2544.90	52.69	226	2.2	H	-50.7	2.60	10.20	-43.10	-13	30.10
2544.90	46.33	309	1.4	V	-56.4	2.60	10.20	-48.80	-13	35.80
3393.20	49.18	28	1.3	H	-52.1	1.40	11.80	-41.70	-13	28.70
3393.20	48.55	256	2.0	V	-52.5	1.40	11.80	-42.10	-13	29.10
4241.50	49.27	340	1.0	H	-52.7	1.50	11.80	-42.40	-13	29.40
4241.50	46.77	111	1.3	V	-54.4	1.50	11.80	-44.10	-13	31.10
5089.80	52.85	107	1.4	H	-44.8	1.60	12.10	-34.30	-13	21.30
5089.80	52.67	358	1.7	V	-45.0	1.60	12.10	-34.50	-13	21.50

Frequency (MHz)	Receiver Reading (dBμV)	Turntable Angle Degree	Rx Antenna		Substituted			Absolute Level (dBm)	Limit (dBm)	Margin (dB)
			Height (m)	Polar (H/V)	Level (dBm)	Cable Loss (dB)	Antenna Gain (dBd/dBi)			
Band 7										
Test frequency range: 30 MHz ~ 26.5 GHz										
5MHz, Low channel										
957.3	31.36	146	2.3	H	-65.1	1.36	0.0	-66.46	-25	41.46
957.3	32.55	272	2.4	V	-61.5	1.36	0.0	-62.86	-25	37.86
5005.00	46.84	165	1.5	H	-53.8	1.70	12.00	-43.50	-25	18.50
5005.00	52.15	15	2.5	V	-47.9	1.70	12.00	-37.60	-25	12.60
5MHz, Middle channel										
948.6	31.39	36	1.9	H	-65.1	1.36	0.0	-66.46	-25	41.46
948.6	32.63	98	1.6	V	-61.4	1.36	0.0	-62.76	-25	37.76
5070.00	47.37	117	1.3	H	-52.6	1.60	12.10	-42.10	-25	17.10
5070.00	51.54	208	1.6	V	-48.5	1.60	12.10	-38.00	-25	13.00
5MHz, High channel										
957.9	31.45	339	1.9	H	-65.1	1.36	0.0	-66.46	-25	41.46
957.9	32.49	197	2.1	V	-61.6	1.36	0.0	-62.96	-25	37.96
5135.00	47.22	358	1.1	H	-52.8	1.60	12.10	-42.30	-25	17.30
5135.00	51.24	182	2.1	V	-48.8	1.60	12.10	-38.30	-25	13.30

Band 17										
Test frequency range: 30 MHz ~ 10 GHz										
5MHz, Low channel										
956.5	31.42	177	2.4	H	-65.1	1.36	0.0	-66.46	-13	53.46
956.5	32.66	288	1.9	V	-61.4	1.36	0.0	-62.76	-13	49.76
1413.00	45.22	267	2.0	H	-63.0	1.60	7.90	-56.70	-13	43.70
1413.00	46.71	112	2.3	V	-61.7	1.60	7.90	-55.40	-13	42.40
2119.50	61.97	190	1.2	H	-39.2	1.30	9.70	-30.80	-13	17.80
2119.50	54.82	190	1.7	V	-47.1	1.30	9.70	-38.70	-13	25.70
2826.00	48.33	109	2.4	H	-55.6	1.80	10.50	-46.90	-13	33.90
2826.00	52.87	188	1.1	V	-50.7	1.80	10.50	-42.00	-13	29.00
3532.50	53.71	25	1.3	H	-47.2	1.50	12.00	-36.70	-13	23.70
3532.50	50.66	229	1.8	V	-51.0	1.50	12.00	-40.50	-13	27.50
4239.00	49.01	262	1.7	H	-52.9	1.50	11.80	-42.60	-13	29.60
4239.00	48.83	19	1.0	V	-52.3	1.50	11.80	-42.00	-13	29.00
4945.50	51.66	309	1.4	H	-48.5	1.60	12.10	-38.00	-13	25.00
4945.50	53.83	286	1.7	V	-46.6	1.60	12.10	-36.10	-13	23.10
5MHz, Middle channel										
951.5	31.73	280	2.3	H	-64.8	1.36	0.0	-66.16	-13	53.16
951.5	32.39	293	1.2	V	-61.7	1.36	0.0	-63.06	-13	50.06
1420.00	44.2	52	1.5	H	-64.0	1.60	7.90	-57.70	-13	44.70
1420.00	44.44	346	1.5	V	-64.0	1.60	7.90	-57.70	-13	44.70
2130.00	60.12	246	1.2	H	-41.0	1.30	9.70	-32.60	-13	19.60
2130.00	52.22	352	2.0	V	-49.7	1.30	9.70	-41.30	-13	28.30
2840.00	49.17	93	1.7	H	-54.8	1.80	10.50	-46.10	-13	33.10
2840.00	51.30	349	2.3	V	-52.3	1.80	10.50	-43.60	-13	30.60
3550.00	52.02	244	1.2	H	-49.7	1.50	12.10	-39.10	-13	26.10
3550.00	51.08	197	1.1	V	-50.1	1.50	12.10	-39.50	-13	26.50
4260.00	47.53	67	1.0	H	-53.9	1.50	11.70	-43.70	-13	30.70
4260.00	47.39	200	2.1	V	-53.3	1.50	11.70	-43.10	-13	30.10
4970.00	49.99	305	2.1	H	-48.8	1.70	12.00	-38.50	-13	25.50
4970.00	52.34	149	1.6	V	-45.9	1.70	12.00	-35.60	-13	22.60
5MHz, High channel										
953.8	31.67	292	1.5	H	-64.8	1.36	0.0	-66.16	-13	53.16
953.8	32.48	210	2.3	V	-61.6	1.36	0.0	-62.96	-13	49.96
1427.00	44.19	52	2.0	H	-64.0	1.60	7.90	-57.70	-13	44.70
1427.00	45.2	252	1.8	V	-63.2	1.60	7.90	-56.90	-13	43.90
2140.50	49.83	319	1.7	H	-51.3	1.30	9.70	-42.90	-13	29.90
2140.50	53.71	160	1.0	V	-48.2	1.30	9.70	-39.80	-13	26.80
2854.00	48.62	96	1.1	H	-56.1	1.70	10.70	-47.10	-13	34.10
2854.00	52.71	9	1.5	V	-52.0	1.70	10.70	-43.00	-13	30.00
3567.50	51.19	258	1.2	H	-50.5	1.50	12.10	-39.90	-13	26.90
3567.50	49.83	150	1.1	V	-51.4	1.50	12.10	-40.80	-13	27.80
4281.00	48.83	61	2.0	H	-52.6	1.50	11.70	-42.40	-13	29.40
4281.00	46.21	49	1.8	V	-54.5	1.50	11.70	-44.30	-13	31.30
4994.50	50.33	261	2.3	H	-48.5	1.70	12.00	-38.20	-13	25.20
4994.50	51.79	22	1.9	V	-46.5	1.70	12.00	-36.20	-13	23.20

Frequency (MHz)	Receiver Reading (dBµV)	Turntable Angle Degree	Rx Antenna		Substituted			Absolute Level (dBm)	Limit (dBm)	Margin (dB)
			Height (m)	Polar (H/V)	Level (dBm)	Cable Loss (dB)	Antenna Gain (dBd/dBi)			
Band 38										
Test frequency range: 30 MHz ~ 26.5GHz										
5MHz, Low channel										
962.2	31.54	24	2.0	H	-65.0	1.36	0.0	-66.36	-25	41.36
962.2	32.52	41	1.0	V	-61.5	1.36	0.0	-62.86	-25	37.86
5145.00	53.21	146	1.6	H	-46.8	1.60	12.10	-36.30	-25	11.30
5145.00	58.21	233	2.0	V	-41.8	1.60	12.10	-31.30	-25	6.30
7717.50	58.14	269	1.1	H	-39.4	2.10	10.50	-31.00	-25	6.00
7717.50	57.56	163	2.0	V	-39.7	2.10	10.50	-31.30	-25	6.30
10290.0	48.87	151	1.1	H	-47.5	2.60	10.60	-39.50	-25	14.50
10290.0	50.25	234	2.0	V	-45.4	2.60	10.60	-37.40	-25	12.40
5MHz, Middle channel										
949.5	31.33	242	1.0	H	-65.2	1.36	0.0	-66.56	-25	41.56
949.5	32.41	255	1.5	V	-61.6	1.36	0.0	-62.96	-25	37.96
5190.00	52.06	253	1.1	H	-48.0	1.60	12.10	-37.50	-25	12.50
5190.00	57.56	329	1.2	V	-42.1	1.60	12.10	-31.60	-25	6.60
7785.00	56.58	17	2.4	H	-39.7	2.00	10.50	-31.20	-25	6.20
7785.00	56.27	31	1.8	V	-39.9	2.00	10.50	-31.40	-25	6.40
10380.0	47.90	84	1.4	H	-47.5	2.60	10.50	-39.60	-25	14.60
10380.0	48.75	124	1.4	V	-47.2	2.60	10.50	-39.30	-25	14.30
5MHz, High channel										
950.5	31.25	171	1.6	H	-65.3	1.36	0.0	-66.66	-25	41.66
950.5	32.34	20	2.2	V	-61.7	1.36	0.0	-63.06	-25	38.06
5235.00	54.58	192	1.3	H	-45.5	1.60	12.10	-35.00	-25	10.00
5235.00	60.74	330	1.3	V	-38.9	1.60	12.10	-28.40	-25	3.40
7852.50	56.33	154	1.8	H	-39.9	2.00	10.50	-31.40	-25	6.40
7852.50	56.41	81	1.9	V	-39.8	2.00	10.50	-31.30	-25	6.30
10470.0	49.25	191	1.9	H	-46.2	2.60	10.50	-38.30	-25	13.30
10470.0	50.27	203	2.2	V	-45.7	2.60	10.50	-37.80	-25	12.80

Frequency (MHz)	Receiver Reading (dBµV)	Turntable Angle Degree	Rx Antenna		Substituted			Absolute Level (dBm)	Limit (dBm)	Margin (dB)
			Height (m)	Polar (H/V)	Level (dBm)	Cable Loss (dB)	Antenna Gain (dBd/dBi)			
Band 41										
Test frequency range: 30 MHz ~ 26.5GHz										
5MHz, Low channel										
954.4	31.26	320	1.4	H	-65.2	1.36	0.0	-66.56	-25	41.56
954.4	32.44	91	1.3	V	-61.6	1.36	0.0	-62.96	-25	37.96
5075.00	52.18	165	1.5	H	-48.7	1.60	12.10	-38.20	-25	13.20
5075.00	58.69	31	1.1	V	-42.2	1.60	12.10	-31.70	-25	6.70
7612.50	62.35	310	1.4	H	-36.2	2.10	10.50	-27.80	-25	2.80
7612.50	61.21	150	1.6	V	-37.1	2.10	10.50	-28.70	-25	3.70
10150.0	51.97	316	1.6	H	-45.6	2.60	10.60	-37.60	-25	12.60
10150.0	53.11	174	2.1	V	-43.7	2.60	10.60	-35.70	-25	10.70
5MHz, Middle Channel										
962.6	31.31	55	2.5	H	-65.2	1.36	0.0	-66.56	-25	41.56
962.6	32.58	77	1.9	V	-61.5	1.36	0.0	-62.86	-25	37.86
5186.00	52.23	313	1.9	H	-48.7	1.60	12.10	-38.20	-25	13.20
5186.00	58.41	12	2.4	V	-42.0	1.60	12.10	-31.50	-25	6.50
7779.00	57.28	109	1.1	H	-40.7	2.00	10.50	-32.20	-25	7.20
7779.00	57.87	113	1.0	V	-40.1	2.00	10.50	-31.60	-25	6.60
10372.0	44.99	192	1.5	H	-51.3	2.60	10.50	-43.40	-25	18.40
10372.0	45.14	309	2.0	V	-51.7	2.60	10.50	-43.80	-25	18.80
5MHz, High Channel										
953.8	31.52	267	1.6	H	-65.0	1.36	0.0	-66.36	-25	41.36
953.8	32.62	332	2.2	V	-61.4	1.36	0.0	-62.76	-25	37.76
5375.00	51.76	39	1.8	H	-49.3	1.60	12.30	-38.60	-25	13.60
5375.00	57.66	272	1.0	V	-42.6	1.60	12.30	-31.90	-25	6.90
8062.50	58.91	98	2.5	H	-40.0	2.10	10.70	-31.40	-25	6.40
8062.50	57.57	268	1.5	V	-41.3	2.10	10.70	-32.70	-25	7.70
10750.0	44.86	73	2.1	H	-51.8	2.60	10.40	-44.00	-25	19.00
10750.0	44.47	266	1.2	V	-51.7	2.60	10.40	-43.90	-25	18.90

Band 66										
Test frequency range: 30 MHz ~ 20GHz										
1.4MHz, Low channel										
963.2	31.58	33	1.9	H	-64.9	1.36	0.0	-66.26	-13	53.26
963.2	32.67	45	1.1	V	-61.4	1.36	0.0	-62.76	-13	49.76
3421.40	45.49	229	1.1	H	-55.3	1.40	11.80	-44.90	-13	31.90
3421.40	44.96	156	1.1	V	-55.6	1.40	11.80	-45.20	-13	32.20
1.4MHz, Middle channel										
952.6	31.68	9	1.6	H	-64.8	1.36	0.0	-66.16	-13	53.16
952.6	32.53	22	1.9	V	-61.5	1.36	0.0	-62.86	-13	49.86
3490.00	47.52	195	1.5	H	-53.2	1.50	12.00	-42.70	-13	29.70
3490.00	44.27	19	1.5	V	-57.2	1.50	12.00	-46.70	-13	33.70
1.4MHz, High channel										
963.2	31.73	314	1.1	H	-64.8	1.36	0.0	-66.16	-13	53.16
963.2	32.45	40	1.1	V	-61.6	1.36	0.0	-62.96	-13	49.96
3558.60	46.27	163	1.1	H	-55.3	1.50	12.10	-44.70	-13	31.70
3558.60	45.17	9	1.4	V	-55.9	1.50	12.10	-45.30	-13	32.30

Note:

Absolute Level = Substituted Level - Cable loss + Antenna Gain

Margin = Limit- Absolute Level

dBd is for the ERP, dBi is for EIRP.

FCC § 22.917 (a); § 24.238 (a); §27.53(c) (h)(m) - BAND EDGES

Applicable Standard

According to § 22.917(a), the power of any emissions outside of the authorized operating frequency ranges must be attenuated below the transmitting power (P) by a factor of at least $43 + 10 \log(P)$ dB.

According to §24.238(a), the power of any emissions outside of the authorized operating frequency ranges must be attenuated below the transmitting power (P) by a factor of at least $43 + 10 \log(P)$ dB.

According to FCC §27.53 (c)(h)(m), the power of any emission outside of the authorized operating frequency ranges must be attenuated below the transmitting power (P) by a factor of at least $43 + 10 \log(P)$ dB.

Test Procedure

The RF output of the transmitter was connected to the input of the spectrum analyzer through sufficient attenuation.

The center of the spectrum analyzer was set to block edge frequency

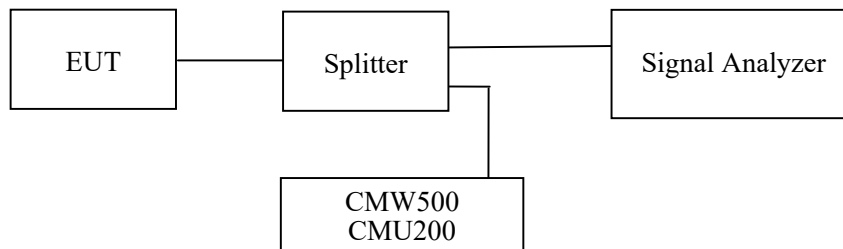

Test Data

Environmental Conditions

Temperature:	28.5~29.2 °C
Relative Humidity:	51~53 %
ATM Pressure:	101.0 kPa

The testing was performed by Pedro Yun from 2021-08-06 to 2021-08-18.

EUT operation mode: Transmitting (Worst case)

Test Result: Pass

Please refer to the following plots.

Cellular Band, Left Band Edge for GSM (GMSK) Mode

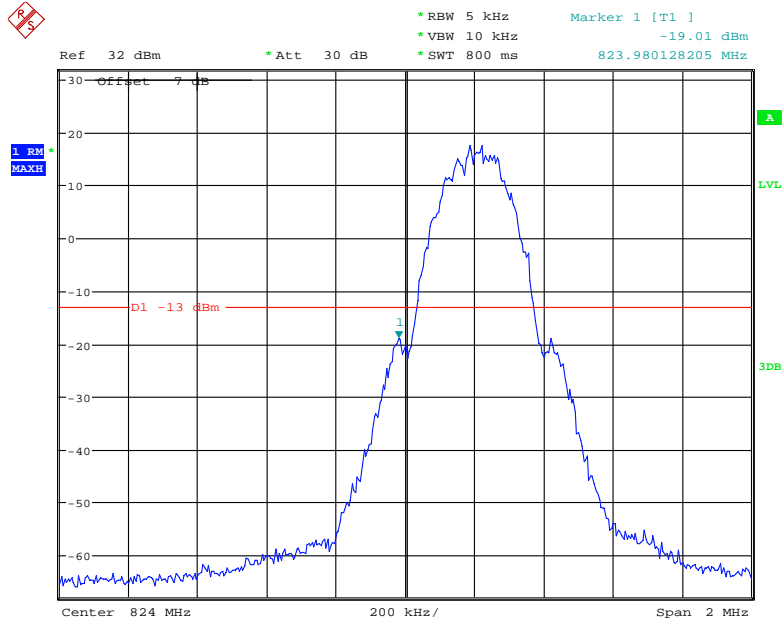

Date: 6.AUG.2021 23:15:39

Cellular Band, Right Band Edge for GSM (GMSK) Mode

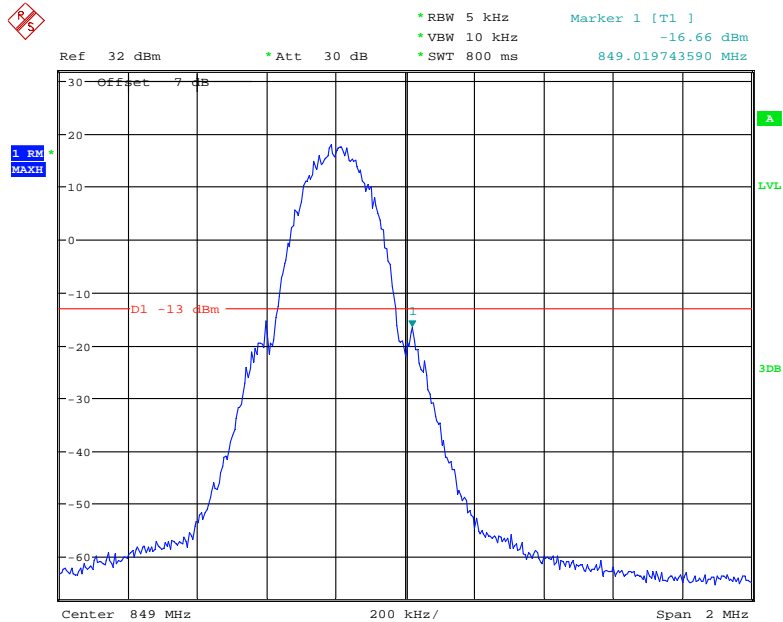

Date: 6.AUG.2021 23:14:47

Cellular Band, Left Band Edge for EGPRS (8PSK) Mode

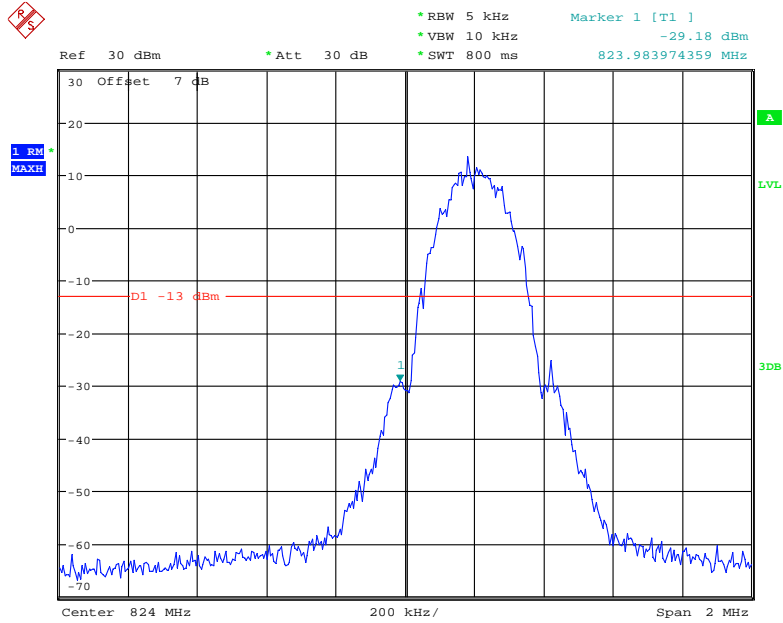

Date: 6.AUG.2021 23:31:16

Cellular Band, Right Band Edge for EGPRS (8PSK) Mode

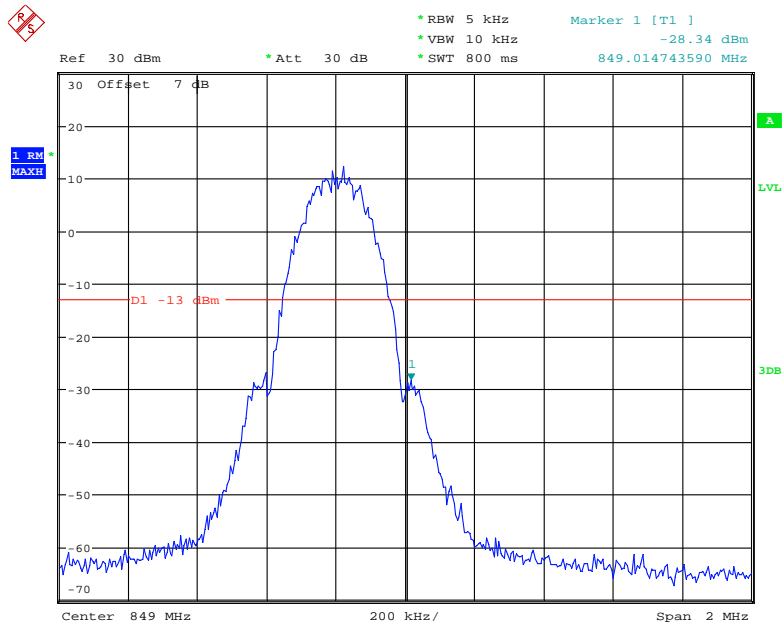

Date: 6.AUG.2021 23:30:40

Cellular Band, Left Band Edge for RMC (BPSK) Mode

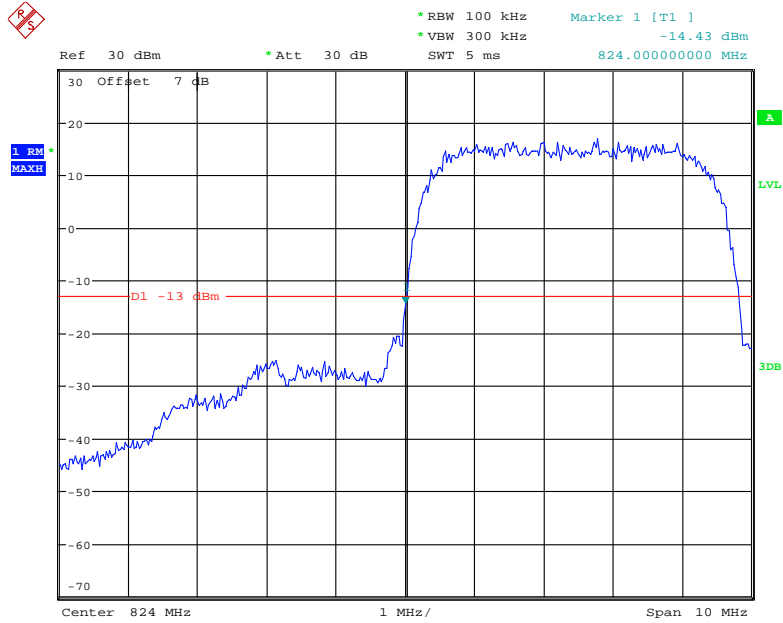

Date: 6.AUG.2021 21:01:32

Cellular Band, Right Band Edge for RMC (BPSK) Mode

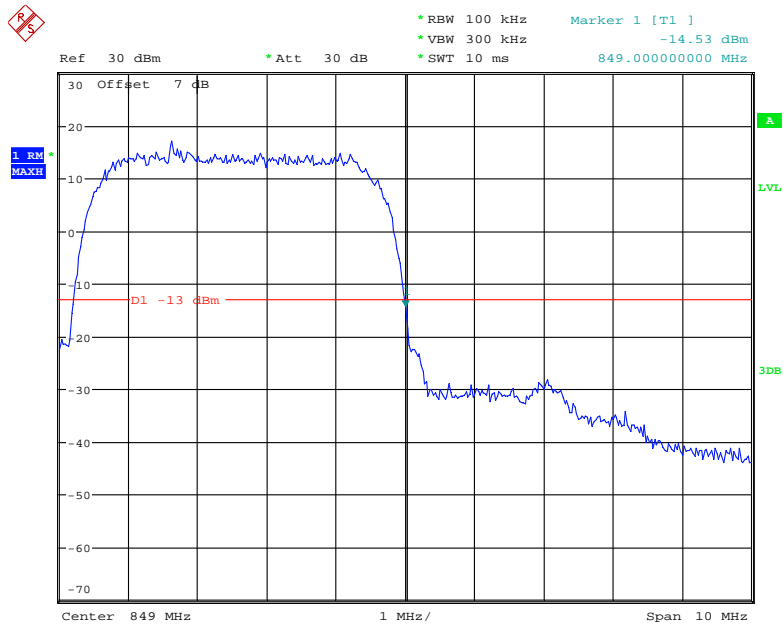

Date: 6.AUG.2021 21:02:23

Cellular Band, Left Band Edge for HSDPA (16QAM) Mode

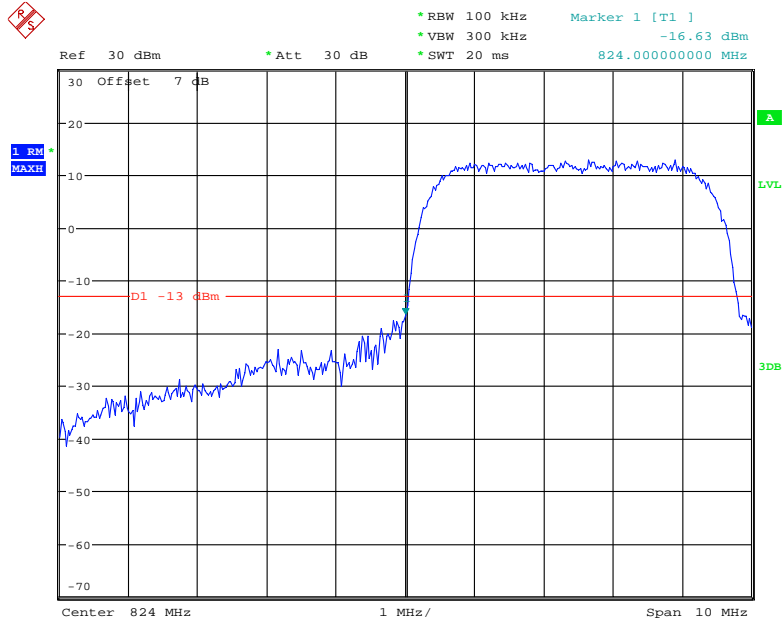

Date: 6.AUG.2021 22:03:48

Cellular Band, Right Band Edge for HSDPA (16QAM) Mode

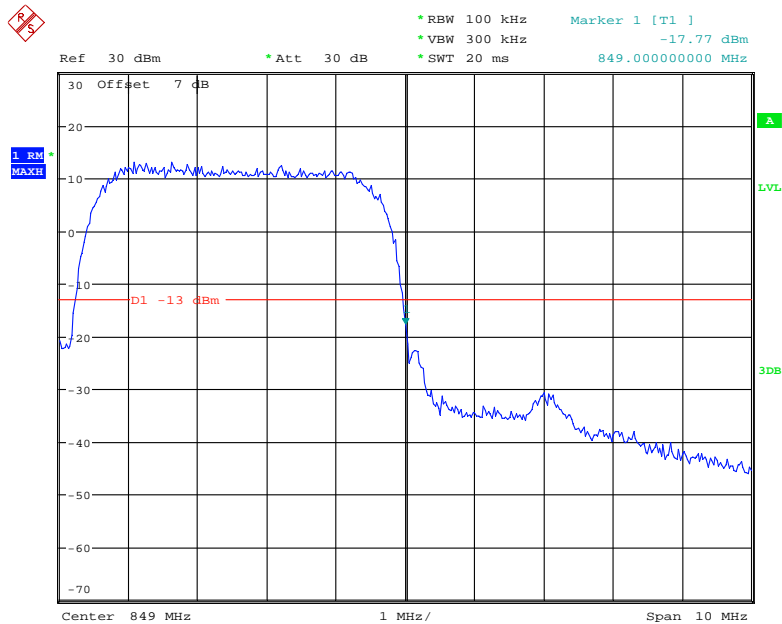

Date: 6.AUG.2021 22:04:20

Cellular Band, Left Band Edge for HSUPA (BPSK) Mode

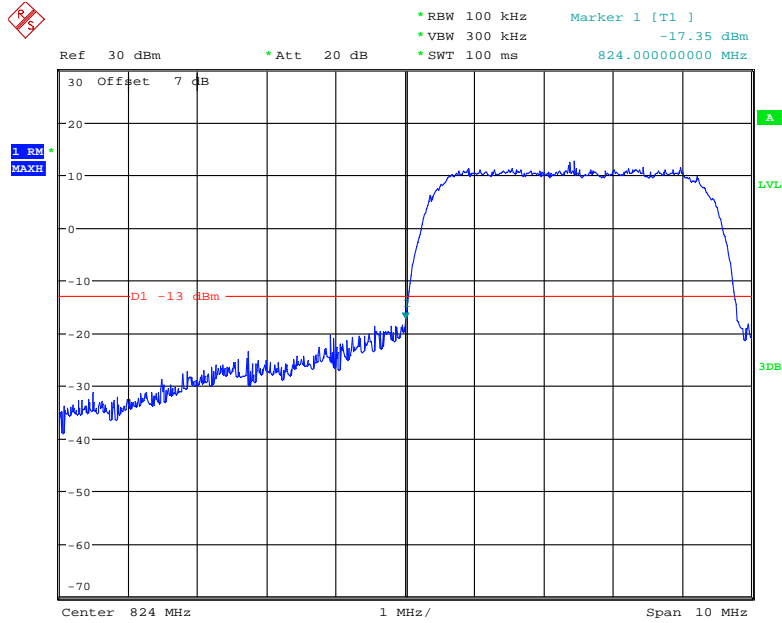

Date: 18.AUG.2021 19:21:51

Cellular Band, Right Band Edge for HSUPA (BPSK) Mode

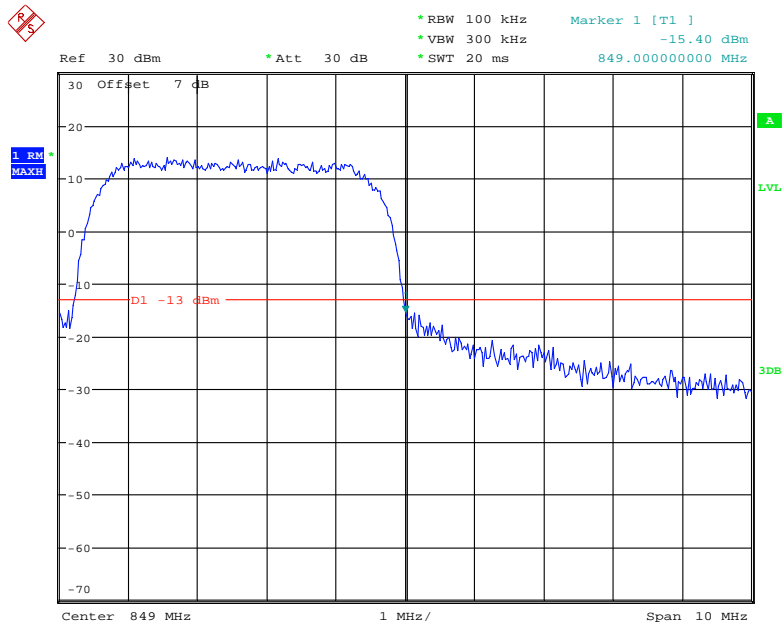

Date: 6.AUG.2021 22:58:50

PCS Band, Left Band Edge for GSM (GMSK) Mode

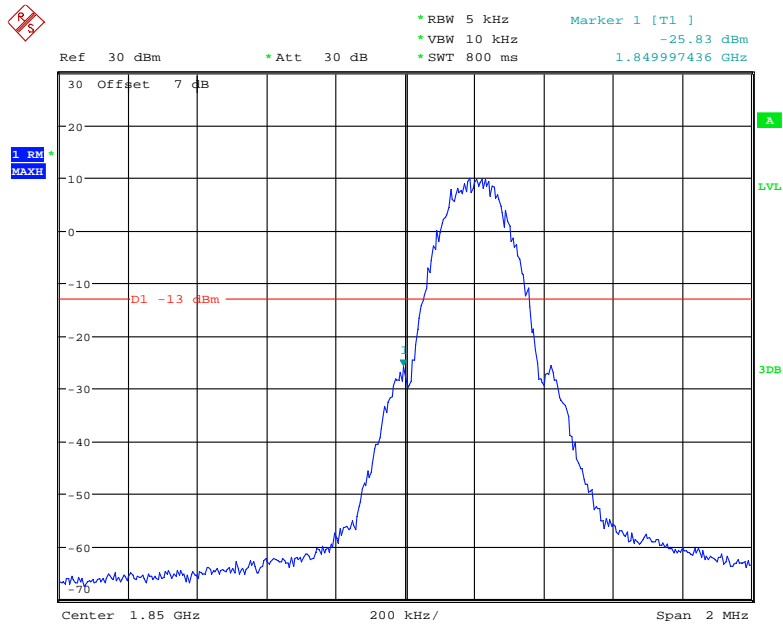

Date: 6.AUG.2021 23:33:14

PCS Band, Right Band Edge for GSM (GMSK) Mode

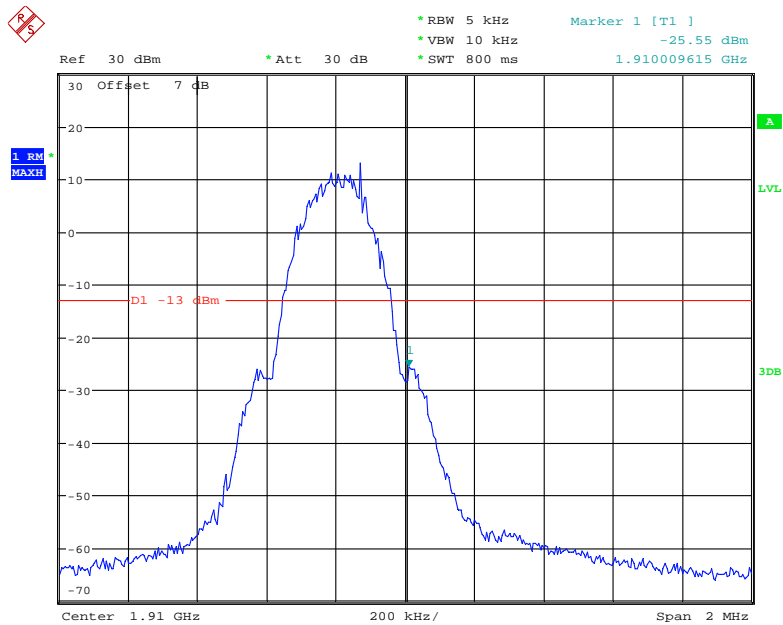

Date: 6.AUG.2021 23:34:04

PCS Band, Left Band Edge for EGPRS (8PSK) Mode

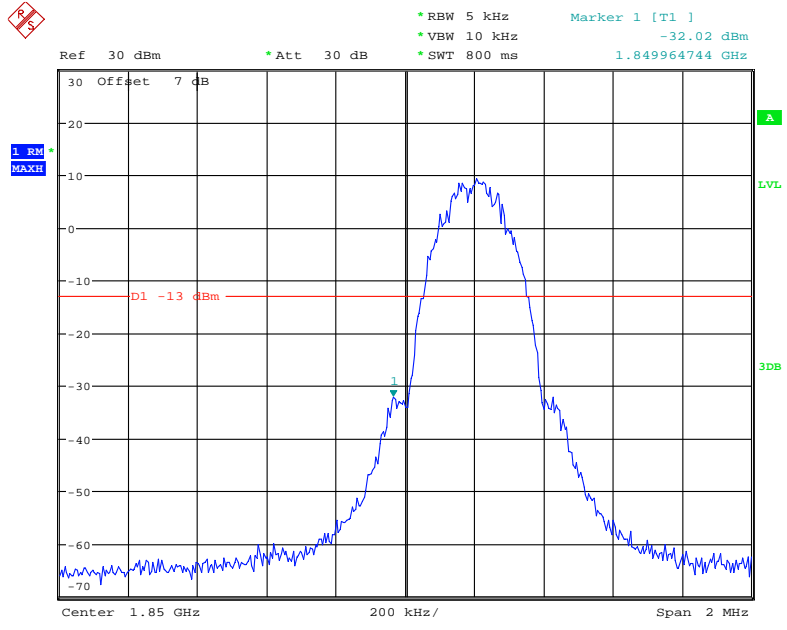

Date: 6.AUG.2021 23:48:48

PCS Band, Right Band Edge for EGPRS (8PSK) Mode

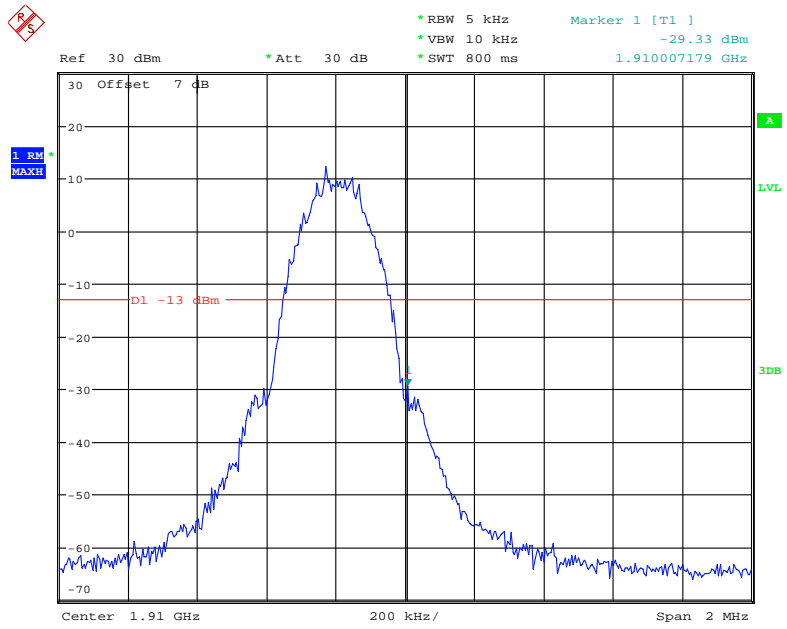

Date: 6.AUG.2021 23:48:07

PCS Band, Left Band Edge for RMC (BPSK) Mode

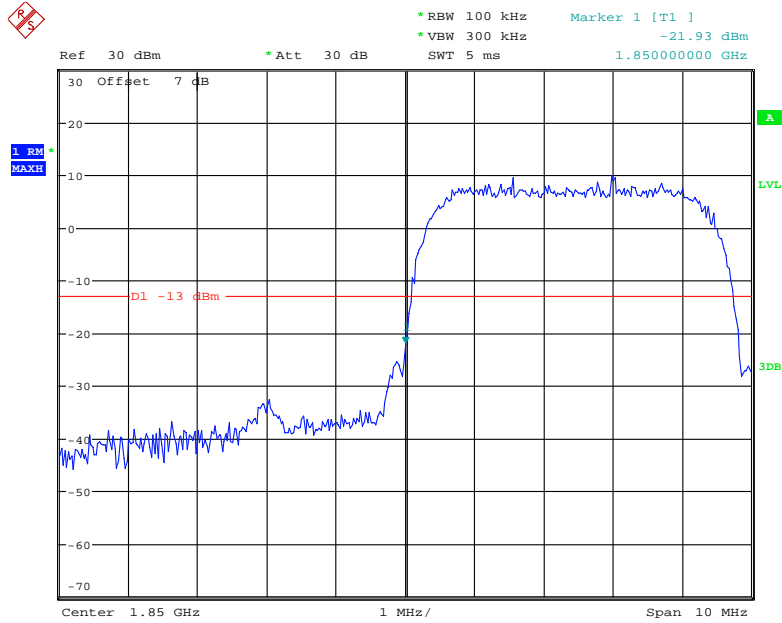

Date: 6.AUG.2021 20:57:33

PCS Band, Right Band Edge for RMC (BPSK) Mode

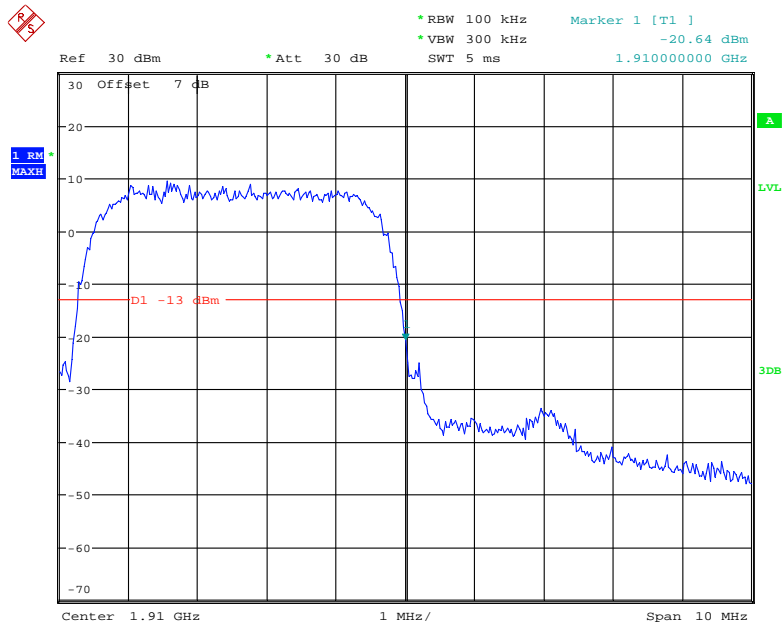

Date: 6.AUG.2021 20:58:49

PCS Band, Left Band Edge for HSDPA (16QAM) Mode

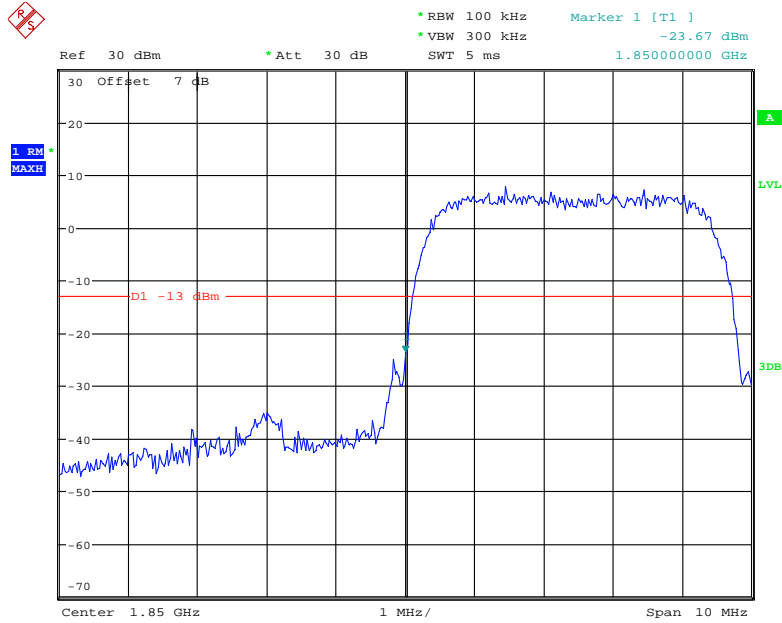

Date: 6.AUG.2021 22:00:21

PCS Band, Right Band Edge for HSDPA (16QAM) Mode

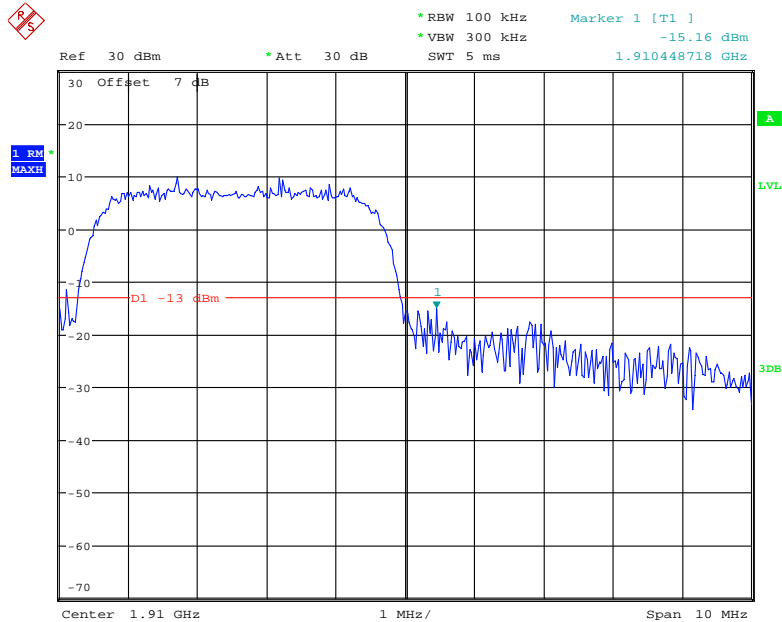

Date: 6.AUG.2021 21:55:52

PCS Band, Left Band Edge for HSUPA (BPSK) Mode

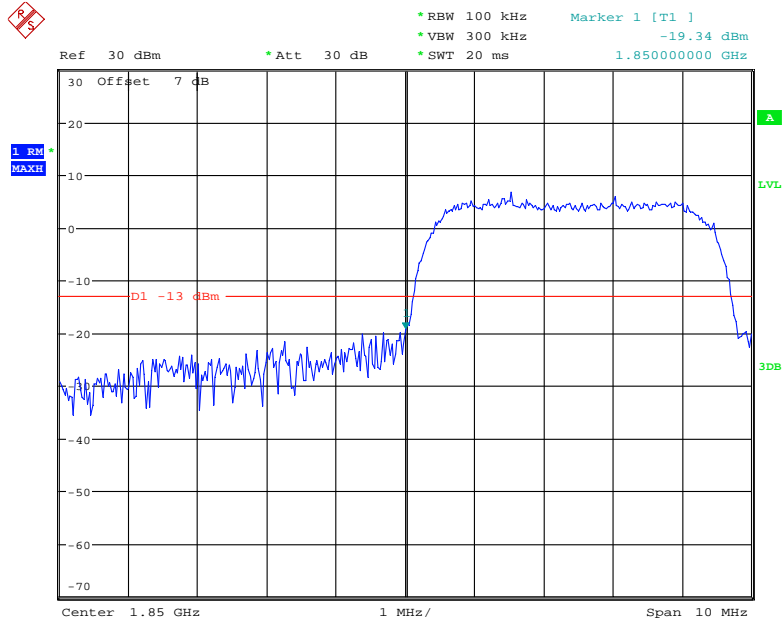

Date: 6.AUG.2021 23:03:08

PCS Band, Right Band Edge for HSUPA (BPSK) Mode

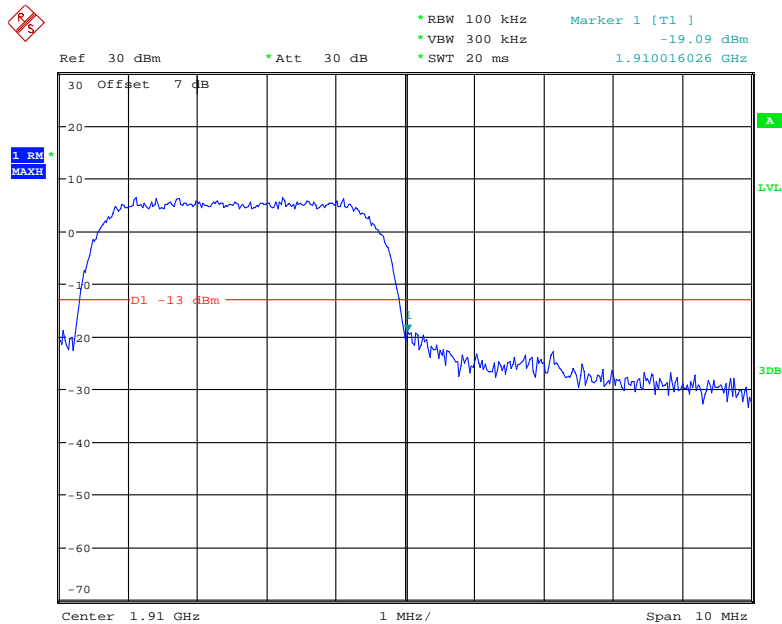

Date: 6.AUG.2021 23:04:45

AWS Band, Left Band Edge for RMC (BPSK) Mode

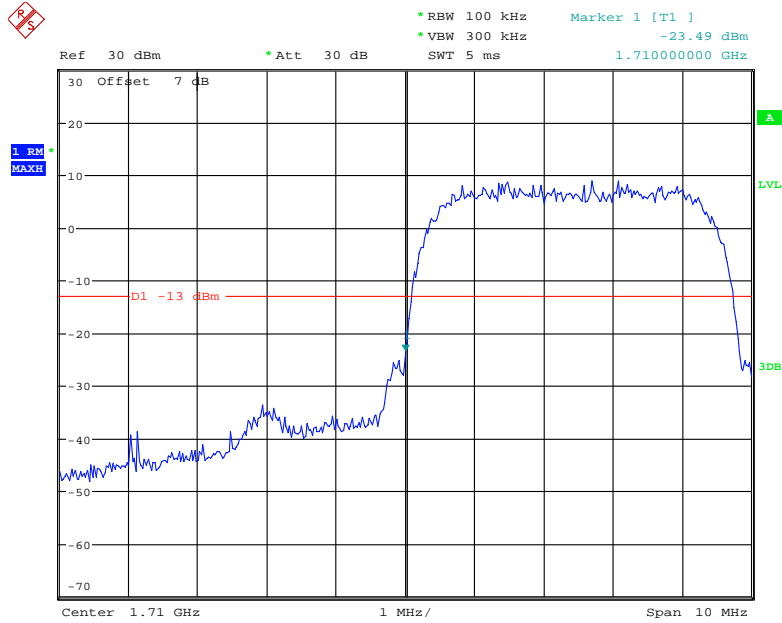

Date: 6.AUG.2021 21:00:06

AWS Band, Right Band Edge for RMC (BPSK) Mode

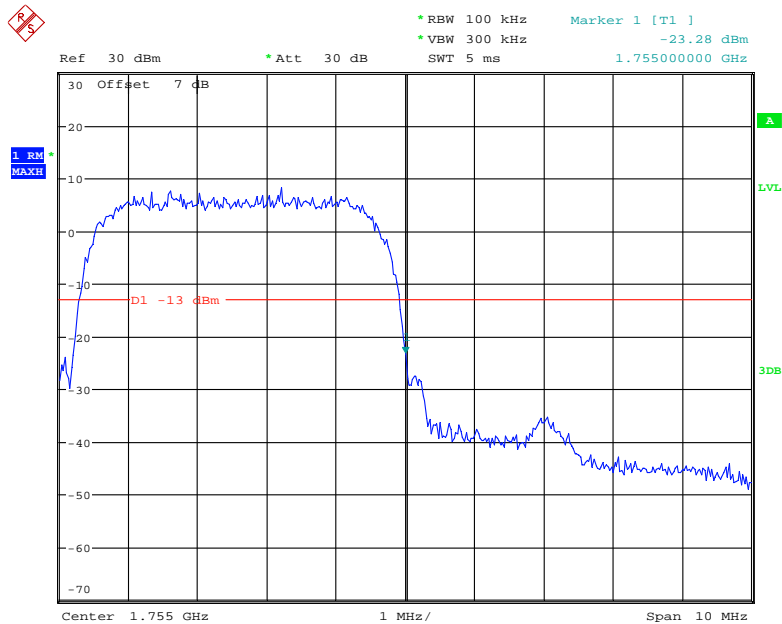

Date: 6.AUG.2021 20:59:36

AWS Band, Left Band Edge for HSDPA (16QAM) Mode

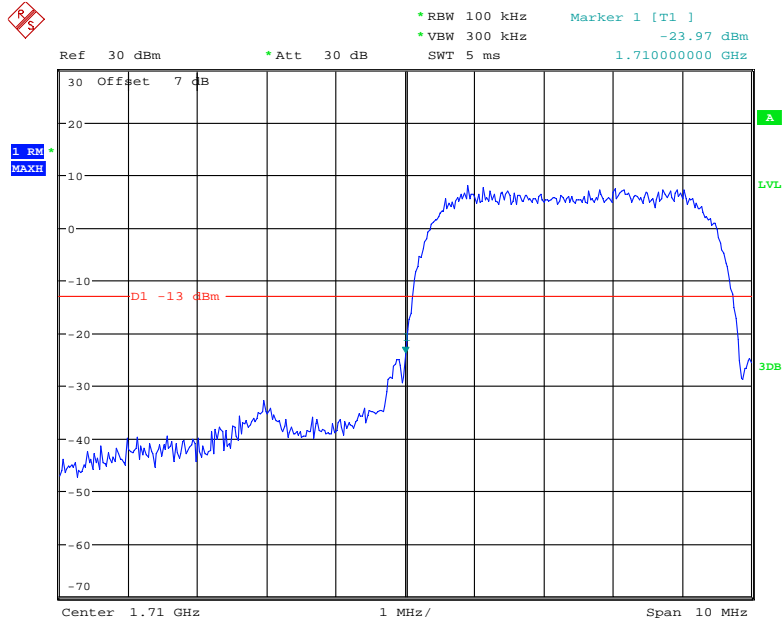

Date: 6.AUG.2021 22:01:29

AWS Band, Right Band Edge for HSDPA (16QAM) Mode

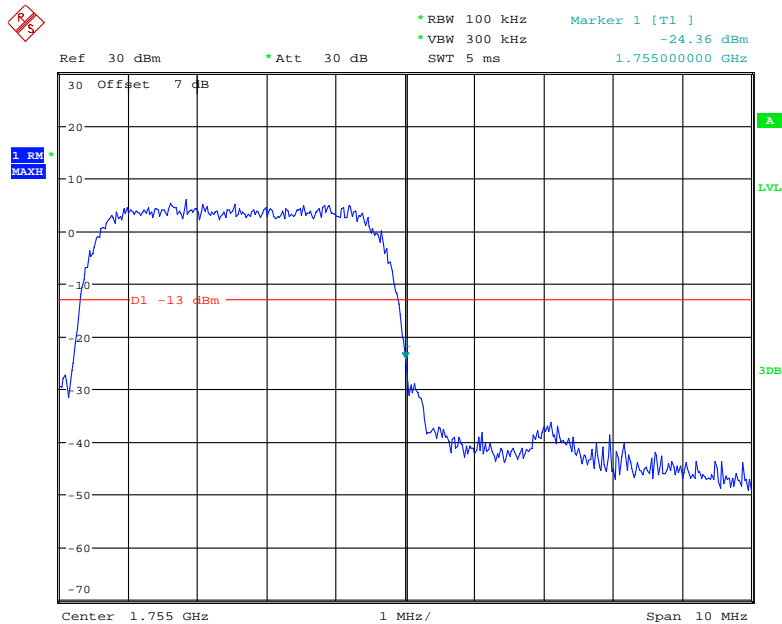

Date: 6.AUG.2021 22:02:01

AWS Band, Left Band Edge for HSUPA (BPSK) Mode

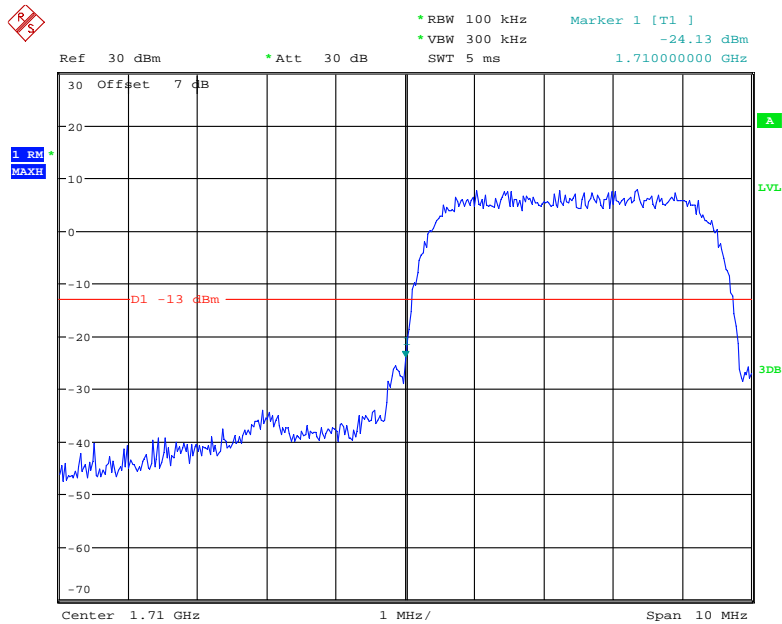

Date: 6.AUG.2021 23:01:22

AWS Band, Right Band Edge for HSUPA (BPSK) Mode

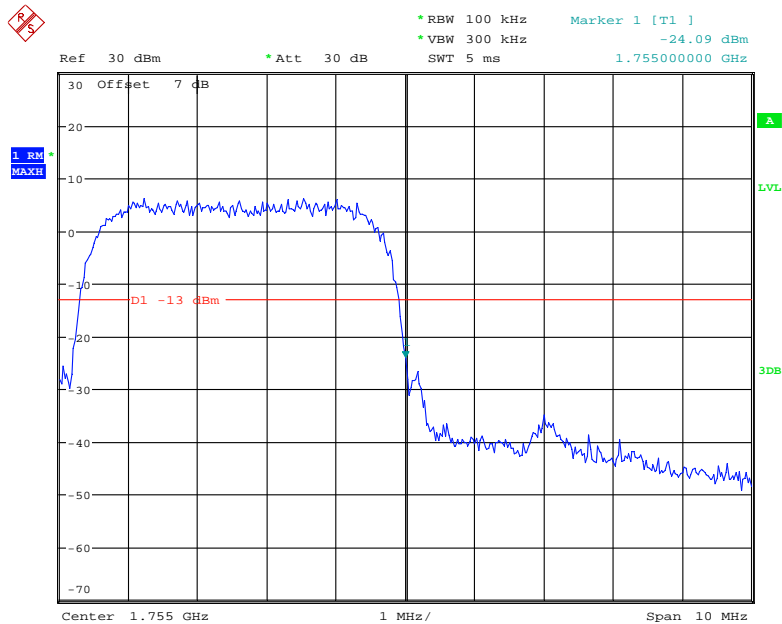

Date: 6.AUG.2021 23:00:53

The test plots of LTE bands please refer to the Appendix C.

FCC § 2.1055; § 22.355; § 24.235; §27.54 - FREQUENCY STABILITY

Applicable Standard

FCC § 2.1055, §22.355, §24.235 and & §27.54.

According to FCC §2.1055, the frequency stability shall be sufficient to ensure that the fundamental emissions stay within the authorized bands of operation.

According to §22.355, the carrier frequency of each transmitter in the Public Mobile Services must be maintained within the tolerances given in Table below:

Frequency Tolerance for Transmitters in the Public Mobile Services

Frequency Range (MHz)	Base, fixed (ppm)	Mobile ≤ 3 watts (ppm)	Mobile > 3 watts (ppm)
25 to 50	20.0	20.0	50.0
50 to 450	5.0	5.0	50.0
450 to 512	2.5	5.0	5.0
821 to 896	1.5	2.5	2.5
928 to 929.	5.0	N/A	N/A
929 to 960.	1.5	N/A	N/A
2110 to 2220	10.0	N/A	N/A

According to §24.235, the frequency stability shall be sufficient to ensure that the fundamental emissions stays within the authorized frequency block.

Test Procedure

Frequency Stability vs. Temperature: The equipment under test was connected to an external DC power supply and the RF output was connected to communication test set via feed-through attenuators. The EUT was placed inside the temperature chamber. The DC leads and RF output cable exited the chamber through an opening made for the purpose.

After the temperature stabilized for approximately 20 minutes, the frequency output was recorded from the communication test set.

Frequency Stability vs. Voltage: For hand carried, battery powered equipment; reduce primary supply voltage to the battery operating end point which shall be specified by the manufacturer.

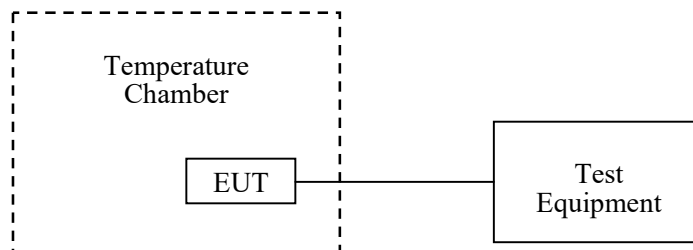

Test Data

Environmental Conditions

Temperature:	28.5~29.2 °C
Relative Humidity:	51~53 %
ATM Pressure:	101.0 kPa

The testing was performed by Pedro Yun from 2021-08-06 to 2021-08-18.

EUT operation mode: Transmitting

Test Result: Pass

Please refer to the following tables.

Cellular Band (Part 22H)

GSM Mode

Middle Channel, $f_0=836.6\text{MHz}$				
Temperature (°C)	Voltage Supplied (V _{DC})	Frequency Error (Hz)	Frequency Error (ppm)	Limit (ppm)
-30	3.87	-5	-0.0060	2.5
-20		-4	-0.0048	2.5
-10		-3	-0.0036	2.5
0		-2	-0.0024	2.5
10		-2	-0.0024	2.5
20		-4	-0.0048	2.5
30		4	0.0048	2.5
40		5	0.0060	2.5
50		-4	-0.0048	2.5
20		3.45	5	0.0060
	4.45	-3	-0.0036	2.5

EDGE Mode

Middle Channel, $f_0=836.6\text{MHz}$				
Temperature (°C)	Voltage Supplied (V _{DC})	Frequency Error (Hz)	Frequency Error (ppm)	Limit (ppm)
-30	3.87	4	0.0048	2.5
-20		5	0.0060	2.5
-10		7	0.0084	2.5
0		5	0.0060	2.5
10		8	0.0096	2.5
20		6	0.0072	2.5
30		9	0.0108	2.5
40		7	0.0084	2.5
50		6	0.0072	2.5
20	3.45	8	0.0096	2.5
	4.45	5	0.0060	2.5

WCDMA Mode

Middle Channel, $f_0=836.6\text{MHz}$				
Temperature (°C)	Voltage Supplied (V _{DC})	Frequency Error (Hz)	Frequency Error (ppm)	Limit (ppm)
-30	3.87	8	0.0096	2.5
-20		6	0.0072	2.5
-10		7	0.0084	2.5
0		4	0.0048	2.5
10		5	0.0060	2.5
20		6	0.0072	2.5
30		7	0.0084	2.5
40		4	0.0048	2.5
50		5	0.0060	2.5
20		3.45	6	0.0072
	4.45	7	0.0084	2.5

PCS Band (Part 24E)

GSM Mode

Middle Channel, $f_0 = 1880.0$ MHz				
Temperature (°C)	Voltage Supplied (V _{DC})	Frequency Error (Hz)	Frequency Error (ppm)	Result
-30	3.87	6	0.0032	Pass
-20		7	0.0037	Pass
-10		6	0.0032	Pass
0		3	0.0016	Pass
10		4	0.0021	Pass
20		5	0.0027	Pass
30		6	0.0032	Pass
40		8	0.0043	Pass
50		5	0.0027	Pass
20		3.45	4	0.0021
	4.45	5	0.0027	Pass

EDGE Mode

Middle Channel, $f_0 = 1880.0$ MHz				
Temperature (°C)	Voltage Supplied (V _{DC})	Frequency Error (Hz)	Frequency Error (ppm)	Result
-30	3.87	-4	-0.0021	Pass
-20		-2	-0.0011	Pass
-10		3	0.0016	Pass
0		2	0.0011	Pass
10		-4	-0.0021	Pass
20		2	0.0011	Pass
30		-3	-0.0016	Pass
40		2	0.0011	Pass
50		-4	-0.0021	Pass
20		3.45	2	0.0011
	4.45	3	0.0016	Pass

WCDMA Mode

Middle Channel, $f_0 = 1880.0$ MHz				
Temperature (°C)	Voltage Supplied (V _{DC})	Frequency Error (Hz)	Frequency Error (ppm)	Result
-30	3.87	-4	-0.0021	Pass
-20		-3	-0.0016	Pass
-10		6	0.0032	Pass
0		4	0.0021	Pass
10		5	0.0027	Pass
20		-4	-0.0021	Pass
30		-5	-0.0027	Pass
40		-4	-0.0021	Pass
50		-7	-0.0037	Pass
20		3.45	-6	-0.0032
	4.45	-5	-0.0027	Pass

AWS Band (Part 27)

Temperature (°C)	Power Supplied (V _{DC})	F _L (MHz)	F _H (MHz)	F _L Limit (MHz)	F _H Limit (MHz)
-30	3.87	1710.0475	1754.6716	1710	1755
-20		1710.0283	1754.3322	1710	1755
-10		1710.0395	1754.5403	1710	1755
0		1710.3763	1754.4425	1710	1755
10		1710.0419	1754.2533	1710	1755
20		1710.1085	1754.5881	1710	1755
30		1710.0518	1754.4473	1710	1755
40		1710.2347	1754.5685	1710	1755
50		1710.2800	1754.3375	1710	1755
20		3.45	1710.0278	1754.5930	1710
	4.45	1710.0198	1754.3809	1710	1755

LTE:
QPSK:

Band 2:

10.0 MHz Middle Channel, $f_0=1880\text{MHz}$				
Temperature (°C)	Voltage Supplied (V _{DC})	Frequency Error (Hz)	Frequency Error (ppm)	Result
-30	3.87	-4.81	-0.0026	Pass
-20		-9.97	-0.0053	Pass
-10		-6.13	-0.0033	Pass
0		6.17	0.0033	Pass
10		7.92	0.0042	Pass
20		6.46	0.0034	Pass
30		-6.52	-0.0035	Pass
40		7.18	0.0038	Pass
50		-9.69	-0.0052	Pass
20		3.45	-8.17	-0.0043
	4.45	-7.05	-0.0038	Pass

Band 4:

10 MHz Bandwidth					
Temperature (°C)	Power Supplied (V _{DC})	F _L (MHz)	F _H (MHz)	F _L Limit (MHz)	F _H Limit (MHz)
-30	3.87	1710.3128	1754.0718	1710	1755
-20		1710.0519	1754.0715	1710	1755
-10		1710.3975	1754.0281	1710	1755
0		1710.3333	1754.0623	1710	1755
10		1710.4430	1754.5951	1710	1755
20		1710.0723	1754.2535	1710	1755
30		1710.1327	1754.1306	1710	1755
40		1710.3029	1754.4006	1710	1755
50		1710.3472	1754.0327	1710	1755
20		3.45	1710.2835	1754.4537	1710
	4.45	1710.2460	1754.2222	1710	1755

Band 5:

10.0 MHz Middle Channel, $f_0=836.5\text{MHz}$				
Temperature (°C)	Voltage Supplied (V _{DC})	Frequency Error (Hz)	Frequency Error (ppm)	Limit (ppm)
-30	3.87	-5.88	-0.007	2.5
-20		-6.97	-0.0083	2.5
-10		-5.50	-0.0066	2.5
0		6.06	0.0072	2.5
10		9.80	0.0117	2.5
20		5.03	0.006	2.5
30		-6.62	-0.0079	2.5
40		-8.73	-0.0104	2.5
50		-7.05	-0.0084	2.5
20		3.45	8.99	0.0107
	4.45	-7.17	-0.0086	2.5

Band 7:

10 MHz Bandwidth					
Temperature (°C)	Power Supplied (V _{DC})	F _L (MHz)	F _H (MHz)	F _L Limit (MHz)	F _H Limit (MHz)
-30	3.87	2500.0864	2569.0839	2500	2570
-20		2500.5664	2569.0525	2500	2570
-10		2500.4729	2569.0763	2500	2570
0		2500.0483	2569.2082	2500	2570
10		2500.0614	2569.0683	2500	2570
20		2500.0881	2569.1044	2500	2570
30		2500.2511	2569.0154	2500	2570
40		2500.1806	2569.1223	2500	2570
50		2500.4674	2569.2134	2500	2570
20		3.45	2500.1777	2569.1365	2500
	4.45	2500.0196	2569.0397	2500	2570

Band 17:

10 MHz Bandwidth					
Temperature (°C)	Power Supplied (V _{DC})	F _L (MHz)	F _H (MHz)	F _L Limit (MHz)	F _H Limit (MHz)
-30	3.87	704.2343	715.2650	704	716
-20		704.0195	715.0560	704	716
-10		704.0721	715.0749	704	716
0		704.0220	715.3543	704	716
10		704.0070	715.3718	704	716
20		704.2318	715.4764	704	716
30		704.1424	715.2484	704	716
40		704.0737	715.3161	704	716
50		704.0809	715.0862	704	716
20		3.45	704.2015	715.0839	704
	4.45	704.0814	715.2184	704	716

Band 38

10 MHz Bandwidth					
Temperature (°C)	Power Supplied (V _{DC})	F _L (MHz)	F _H (MHz)	F _L Limit (MHz)	F _H Limit (MHz)
-30	3.87	2570.5313	2619.0779	2570	2620
-20		2570.2555	2619.1175	2570	2620
-10		2570.3385	2619.0296	2570	2620
0		2570.0330	2619.5748	2570	2620
10		2570.0916	2619.1268	2570	2620
20		2570.3478	2619.0859	2570	2620
30		2570.4097	2619.1286	2570	2620
40		2570.0820	2619.0898	2570	2620
50		2570.0658	2619.0489	2570	2620
20		3.45	2570.0145	2619.0317	2570
	4.45	2570.2015	2619.2170	2570	2620

Band 41

10 MHz Bandwidth					
Temperature (°C)	Power Supplied (V _{DC})	F _L (MHz)	F _H (MHz)	F _L Limit (MHz)	F _H Limit (MHz)
-30	3.87	2535.2009	2654.4608	2535	2655
-20		2535.5025	2654.2609	2535	2655
-10		2535.3385	2654.0296	2535	2655
0		2535.0636	2654.0668	2535	2655
10		2535.0109	2654.2483	2535	2655
20		2535.2318	2654.0369	2535	2655
30		2535.3743	2654.0129	2535	2655
40		2535.3561	2654.5027	2535	2655
50		2535.3267	2654.4322	2535	2655
20		3.45	2535.0637	2654.1349	2535
	4.45	2535.3333	2654.0391	2535	2655

Note: the frequency range 2535-2655MHz was declared by applicant.

Band 66

10 MHz Bandwidth					
Temperature (°C)	Power Supplied (V _{DC})	F _L (MHz)	F _H (MHz)	F _L Limit (MHz)	F _H Limit (MHz)
-30	3.87	1710.0718	1779.0179	1710	1780
-20		1710.0905	1779.0324	1710	1780
-10		1710.3595	1779.0306	1710	1780
0		1710.1135	1779.0730	1710	1780
10		1710.0401	1779.1221	1710	1780
20		1710.2891	1779.2955	1710	1780
30		1710.4138	1779.1326	1710	1780
40		1710.4006	1779.0836	1710	1780
50		1710.2809	1779.1735	1710	1780
20		3.45	1710.0152	1779.1089	1710
	4.45	1710.3794	1779.1945	1710	1780

16QAM:

Band 2:

10.0 MHz Middle Channel, $f_0 = 1880\text{MHz}$				
Temperature (°C)	Voltage Supplied (V _{DC})	Frequency Error (Hz)	Frequency Error (ppm)	Result
-30	3.87	-7.18	-0.0038	Pass
-20		-6.68	-0.0036	Pass
-10		9.77	0.0052	Pass
0		-7.62	-0.0041	Pass
10		-9.91	-0.0053	Pass
20		-9.82	-0.0052	Pass
30		-6.68	-0.0036	Pass
40		-8.85	-0.0047	Pass
50		5.67	0.003	Pass
20		3.45	6.05	0.0032
	4.45	7.52	0.004	Pass

Band 4:

10 MHz Bandwidth					
Temperature (°C)	Power Supplied (V _{DC})	F _L (MHz)	F _H (MHz)	F _L Limit (MHz)	F _H Limit (MHz)
-30	3.87	1710.1545	1754.3194	1710	1755
-20		1710.1909	1754.6251	1710	1755
-10		1710.5072	1754.0642	1710	1755
0		1710.3142	1754.0099	1710	1755
10		1710.2227	1754.1204	1710	1755
20		1710.2097	1754.7678	1710	1755
30		1710.3817	1754.1857	1710	1755
40		1710.0756	1754.0004	1710	1755
50		1710.0746	1754.1701	1710	1755
20		3.45	1710.2416	1754.0355	1710
	4.45	1710.5227	1754.4609	1710	1755

Band 5:

10.0 MHz Middle Channel, $f_0 = 836.5\text{MHz}$				
Temperature (°C)	Voltage Supplied (V _{DC})	Frequency Error (Hz)	Frequency Error (ppm)	Limit (ppm)
-30	3.87	-6.84	-0.0082	2.5
-20		8.10	0.0097	2.5
-10		-8.59	-0.0103	2.5
0		9.33	0.0112	2.5
10		-6.94	-0.0083	2.5
20		7.54	0.009	2.5
30		6.43	0.0077	2.5
40		-6.17	-0.0074	2.5
50		-6.44	-0.0077	2.5
20		3.45	6.34	0.0076
	4.45	-6.89	-0.0082	2.5

Band 7:

10 MHz Bandwidth					
Temperature (°C)	Power Supplied (V _{DC})	F _L (MHz)	F _H (MHz)	F _L Limit (MHz)	F _H Limit (MHz)
-30	3.87	2500.2495	2569.1818	2500	2570
-20		2500.0836	2569.4142	2500	2570
-10		2500.5102	2569.0386	2500	2570
0		2500.6399	2569.0952	2500	2570
10		2500.3311	2569.1004	2500	2570
20		2500.2113	2569.0595	2500	2570
30		2500.4929	2569.1503	2500	2570
40		2500.4339	2569.0060	2500	2570
50		2500.0616	2569.4748	2500	2570
20		3.45	2500.2252	2569.6343	2500
	4.45	2500.3309	2569.2400	2500	2570

Band 17:

10 MHz Bandwidth					
Temperature (°C)	Power Supplied (V _{DC})	F _L (MHz)	F _H (MHz)	F _L Limit (MHz)	F _H Limit (MHz)
-30	3.87	704.0763	715.1677	704	716
-20		704.4561	715.1868	704	716
-10		704.4721	715.0749	704	716
0		704.4393	715.2261	704	716
10		704.5019	715.1493	704	716
20		704.2955	715.8214	704	716
30		704.1982	715.2434	704	716
40		704.7212	715.0119	704	716
50		704.2321	715.5777	704	716
20		3.45	704.3589	715.2179	704
	4.45	704.3973	715.3657	704	716

Band 38

10 MHz Bandwidth					
Temperature (°C)	Power Supplied (V _{DC})	F _L (MHz)	F _H (MHz)	F _L Limit (MHz)	F _H Limit (MHz)
-30	3.87	2570.6385	2619.1768	2570	2620
-20		2570.4223	2619.4421	2570	2620
-10		2570.3385	2619.0096	2570	2620
0		2570.0853	2619.2111	2570	2620
10		2570.5123	2619.0737	2570	2620
20		2570.5572	2619.4643	2570	2620
30		2570.2153	2619.0722	2570	2620
40		2570.3883	2619.0569	2570	2620
50		2570.4868	2619.0685	2570	2620
20		3.45	2570.2458	2619.0024	2570
	4.45	2570.1970	2619.0475	2570	2620

Band 41

10 MHz Bandwidth					
Temperature (°C)	Power Supplied (V _{DC})	F _L (MHz)	F _H (MHz)	F _L Limit (MHz)	F _H Limit (MHz)
-30	3.87	2535.0413	2654.1480	2535	2655
-20		2535.3585	2654.0488	2535	2655
-10		2535.3385	2654.0096	2535	2655
0		2535.3213	2654.0956	2535	2655
10		2535.0642	2654.0729	2535	2655
20		2535.5516	2654.4876	2535	2655
30		2535.3458	2654.5668	2535	2655
40		2535.1535	2654.1115	2535	2655
50		2535.0419	2654.5533	2535	2655
20		3.45	2535.3771	2654.4598	2535
	4.45	2535.2686	2654.4432	2535	2655

Note: the frequency range 2535-2655MHz was declared by applicant.

Band 66

10 MHz Bandwidth					
Temperature (°C)	Power Supplied (V _{DC})	F _L (MHz)	F _H (MHz)	F _L Limit (MHz)	F _H Limit (MHz)
-30	3.87	1710.4209	1779.2800	1710	1780
-20		1710.1343	1779.3667	1710	1780
-10		1710.3595	1779.0306	1710	1780
0		1710.2871	1779.3339	1710	1780
10		1710.2011	1779.2226	1710	1780
20		1710.2671	1779.6774	1710	1780
30		1710.6085	1779.1065	1710	1780
40		1710.0802	1779.0769	1710	1780
50		1710.6234	1779.3800	1710	1780
20		3.45	1710.0198	1779.6581	1710
	4.45	1710.2882	1779.2009	1710	1780

***** END OF REPORT *****