



FCC PART 27
FCC PART 22H, PART 24E
TEST REPORT

For

TECNO MOBILE LIMITED

FLAT 39 8/F BLOCK D WAH LOK INDUSTRIAL CENTRE 31-35 SHAN MEI STREET
FOTAN NT Hong Kong

FCC ID: 2ADYY-KG6P

Report Type: Original Report	Product Type: Mobile Phone
Report Number: SZ1210901-45704E-RF-00D	
Report Date: 2021-10-25	
Reviewed By: RF Engineer	Candy Li 
Prepared By: Shenzhen Accurate Technology Co., Ltd. 1/F., Building A, Changyuan New Material Port, Science & Industry Park, Nanshan District, Shenzhen, Guangdong, P.R. China Tel: (0755) 26503290 Fax: (0755) 26503396 Http://www.atc-lab.com	

Note: This report may contain data that are not covered by the A2LA accreditation and are marked with an asterisk “★”.

Shenzhen Accurate Technology Co., Ltd. is not responsible for the authenticity of any test data provided by the applicant. Data included from the applicant that may affect test results are marked with an asterisk ‘*’. Customer model name, addresses, names, trademarks etc. are not considered data.

This report cannot be reproduced except in full, without prior written approval of the Company. Unless otherwise stated the results shown in this test report refer only to the sample(s) tested. This report is valid only with a valid digital signature. The digital signature may be available only under the Adobe software above version 7.0.

TABLE OF CONTENTS

GENERAL INFORMATION	3
PRODUCT DESCRIPTION FOR EQUIPMENT UNDER TEST (EUT).....	3
OBJECTIVE	3
TEST METHODOLOGY	4
MEASUREMENT UNCERTAINTY.....	4
SYSTEM TEST CONFIGURATION	5
DESCRIPTION OF TEST CONFIGURATION	5
EQUIPMENT MODIFICATIONS	6
SUPPORT EQUIPMENT LIST AND DETAILS	6
SUPPORT CABLE DESCRIPTION	6
BLOCK DIAGRAM OF TEST SETUP	7
SUMMARY OF TEST RESULTS	8
TEST EQUIPMENT LIST	9
FCC §1.1307(B) & §2.1093 - RF EXPOSURE INFORMATION	11
APPLICABLE STANDARD	11
TEST RESULT	11
FCC §2.1047 - MODULATION CHARACTERISTIC	12
FCC § 2.1046, § 22.913 (A) & § 24.232 (C); §27.50 (C) (D) (H) - RF OUTPUT POWER	13
APPLICABLE STANDARD	13
TEST PROCEDURE	13
TEST DATA	13
FCC §2.1049, §22.917, §22.905 & §24.238 & §27.53 - OCCUPIED BANDWIDTH	45
APPLICABLE STANDARD	45
TEST PROCEDURE	45
TEST DATA	45
FCC §2.1051, §22.917(A) & §24.238(A); §27.53 - SPURIOUS EMISSIONS AT ANTENNA TERMINALS	72
APPLICABLE STANDARD	72
TEST PROCEDURE	72
TEST DATA	72
FCC § 2.1053; § 22.917 (A);§ 24.238 (A); §27.53 SPURIOUS RADIATED EMISSIONS	90
APPLICABLE STANDARD	90
TEST PROCEDURE	90
TEST DATA	90
FCC § 22.917 (A);§ 24.238 (A); §27.53(C) (H)(M) - BAND EDGES	99
APPLICABLE STANDARD	99
TEST PROCEDURE	99
TEST DATA	99
FCC § 2.1055; § 22.355; § 24.235; §27.54 - FREQUENCY STABILITY	113
APPLICABLE STANDARD	113
TEST PROCEDURE	113
TEST DATA	114

GENERAL INFORMATION

Product Description for Equipment under Test (EUT)

Product	Mobile Phone
Tested Model	KG6p
Frequency Range	GSM 850: 824-849MHz(TX); 869-894MHz(RX) PCS 1900: 1850-1910MHz(TX); 1930-1990MHz(RX) WCDMA Band 2: 1850-1910MHz(TX); 1930-1990MHz(RX) WCDMA Band 4: 1710-1755MHz(TX); 2110-2155MHz(RX) WCDMA Band 5: 824-849MHz(TX); 869-894MHz(RX) LTE Band 2: 1850-1910MHz(TX); 1930-1990MHz(RX) LTE Band 4: 1710-1755MHz(TX); 2110-2155MHz(RX) LTE Band 5: 824-849MHz(TX); 869-894MHz(RX) LTE Band 7: 2500-2570MHz(TX); 2620-2690MHz(RX) LTE Band 17: 704-716MHz(TX); 734-746MHz(RX) LTE Band 38: 2570-2620MHz(TX/RX) LTE Band 41: 2535-2655MHz(TX/RX) LTE Band 66: 1710-1780MHz(TX); 2110-2180MHz(RX)
Modulation Technique	2G: GMSK, 8PSK 3G: BPSK, QPSK, 16QAM 4G: QPSK, 16QAM
Antenna Specification*	GSM850/WCDMA Band 5/LTE Band 5: -1.6dBi PCS1900/WCDMA Band 2/ LTE Band 2: -0.7dBi WCDMA Band 4/ LTE Band 4/ LTE Band 66: -0.7dBi LTE Band 7/LTE Band 38//LTE Band 41: -0.4dBi LTE Band 17: -1.9dBi (provided by the applicant)
Voltage Range	DC 3.85V From Battery or DC 5V From Adapter
Date of Test	2021-09-05 to 2021-09-08
Sample number	SZ1210901-45704E-RF-S1
Received date	2021-09-01
Sample/EUT Status	Good condition
Normal/Extreme Condition	L.V.: Low Voltage 3.45V _{DC} N.V.: Normal Voltage 3.85V _{DC} H.V.: High Voltage 4.4V _{DC} Note: The extreme condition was declared by the applicant
Adapter information	Model: U100TSA Input: AC 100-240V ~ 50/60Hz, 0.3A Output: DC 5.0V, 2.0A

Objective

This test report is in accordance with Part 2-Subpart J, Part 22-Subpart H and Part 24-Subpart E and Subpart 27 of the Federal Communication Commissions rules.

The objective is to determine the compliance of the EUT with FCC rules for output power, modulation characteristic, occupied bandwidth, and spurious emission at antenna terminal, spurious radiated emission, frequency stability and band edge.

Test Methodology

All tests and measurements indicated in this document were performed in accordance with the Code of Federal Regulations Title 47 Part 2-Subpart J as well as the following parts:

Part 22 Subpart H - Public Mobile Services
 Part 24 Subpart E - Personal Communication Services
 Part 27 – Miscellaneous wireless communications services

ANSI C63.26-2015: American National Standard for Compliance Testing of Transmitters Used in Licensed Radio Services

All emissions measurement was performed at Shenzhen Accurate Technology Co., Ltd. The radiated testing was performed at an antenna-to-EUT distance of 3 meters.
 Each test item follows test standards and with no deviation.

Measurement Uncertainty

Parameter		Uncertainty
Occupied Channel Bandwidth		±5%
RF output power, conducted		±0.73dB
Unwanted Emission, conducted		±1.6dB
RF Frequency		±0.082*10 ⁻⁷
Emissions, Radiated	30MHz - 1GHz	±4.28dB
	1GHz - 18GHz	±4.98dB
	18GHz - 26.5GHz	±5.06dB
Temperature		±1°C
Humidity		±6%
Supply voltages		±0.4%

Note: The extended uncertainty given in this report is obtained by combining the standard uncertainty times the coverage factor K with the 95% confidence interval. Otherwise required by the applicant or Product Regulations, Decision Rule in this report did not consider the uncertainty.

Test Facility

The test site used by Shenzhen Accurate Technology Co., Ltd. to collect test data is located on the 1/F., Building A, Changyuan New Material Port, Science & Industry Park, Nanshan District, Shenzhen, Guangdong, P.R. China.

The test site has been approved by the FCC under the KDB 974614 D01 and is listed in the FCC Public Access Link (PAL) database, FCC Registration No.: 708358, the FCC Designation No.: CN1189. Accredited by American Association for Laboratory Accreditation (A2LA) The Certificate Number is 429 7.01.

Listed by Innovation, Science and Economic Development Canada (ISED), the Registration Number is 5077A.

SYSTEM TEST CONFIGURATION

Description of Test Configuration

The final qualification test was performed with the EUT operating at normal mode.

Test was performed as below table:

Frequency band	Bandwidth (MHz)	Test Frequency(MHz)		
		Low	Middle	High
GSM850	0.25	824.2	836.6	848.8
DCS1900	0.25	1850.2	1880	1909.8
WCDMA B2	4.2	1852.4	1880	1907.6
WCDMA B4	4.2	1712.4	1732.6	1752.6
WCDMA B5	4.2	826.4	836.6	846.6
LTE B2	1.4	1850.7	1880	1909.3
	3	1851.5	1880	1908.5
	5	1852.5	1880	1907.5
	10	1855	1880	1905
	15	1857.5	1880	1902.5
	20	1860	1880	1900
LTE B4	1.4	1710.7	1732.5	1754.3
	3	1711.5	1732.5	1753.5
	5	1712.5	1732.5	1752.5
	10	1715	1732.5	1750
	15	1717.5	1732.5	1747.5
	20	1720	1732.5	1745
LTE B5	1.4	824.7	836.5	848.3
	3	825.5	836.5	847.5
	5	826.5	836.5	846.5
	10	829	836.5	844
LTE B7	5	2502.5	2535	2567.5
	10	2505	2535	2565
	15	2507.5	2535	2562.5
	20	2510	2535	2560
LTE B17	5	706.5	710	713.5
	10	709	710	711

Frequency band	Bandwidth (MHz)	Test Frequency(MHz)		
		Low	Middle	High
LTE B38	5	2572.5	2595	2617.5
	10	2575	2595	2615
	15	2577.5	2595	2612.5
	20	2580	2595	2610
LTE B41	5	2537.5	2595	2652.5
	10	2540	2595	2650
	15	2542.5	2595	2647.5
	20	2545	2595	2645
LTE B66	1.4	1710.7	1745	1779.3
	3	1711.5	1745	1778.5
	5	1712.5	1745	1777.5
	10	1715	1745	1775
	15	1717.5	1745	1772.5
	20	1720	1745	1770

Equipment Modifications

No modification was made to the EUT.

Support Equipment List and Details

Manufacturer	Description	Model	Serial Number
Rohde & Schwarz	Universal Radio Communication Tester	CMW500	1201.002K50-146520-wh

Support Cable Description

Cable Description	Length (m)	From / Port	To
/	/	/	/

Block Diagram of Test Setup

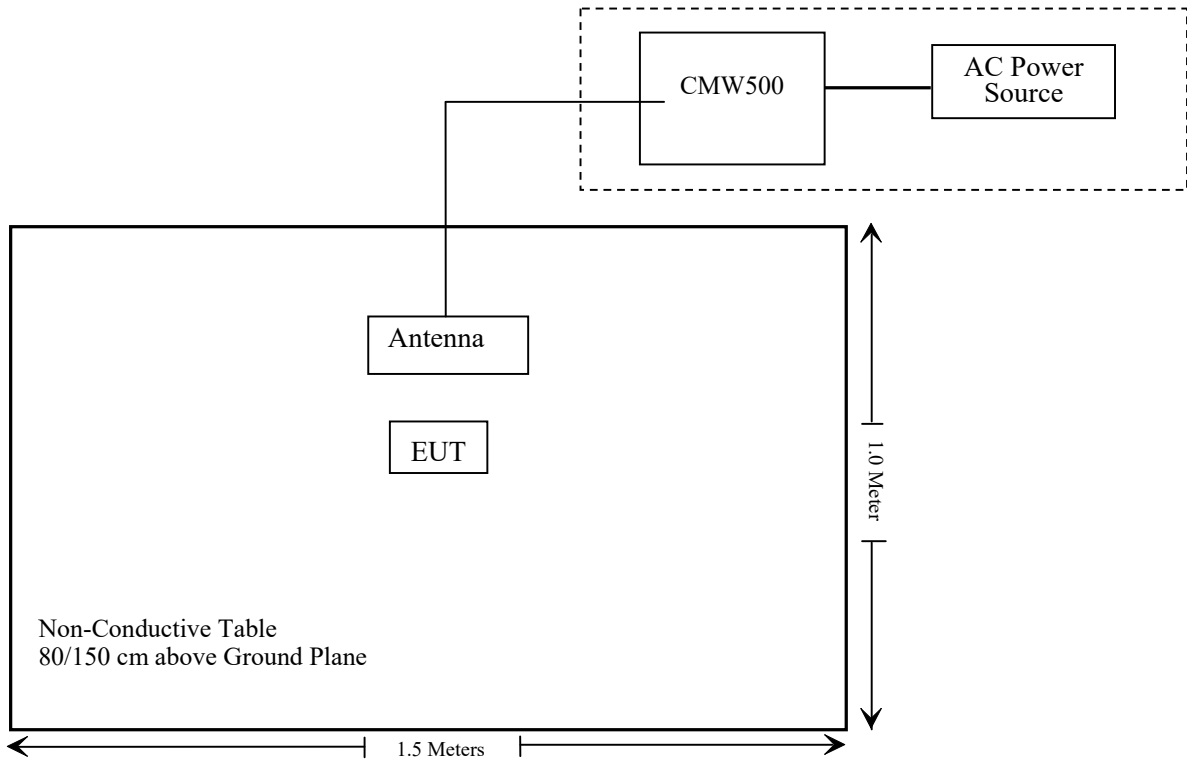

SUMMARY OF TEST RESULTS

FCC Rules	Description of Test	Result
§ 1.1307 , §2.1093	RF Exposure (SAR)	Compliant*
§2.1046; § 22.913 (a); § 24.232 (c); §27.50 (c) (d) (h)	RF Output Power	Compliant
§ 2.1047	Modulation Characteristics	Not Applicable
§ 2.1049; § 22.905; § 22.917; § 24.238; §27.53	Occupied Bandwidth	Compliant
§ 2.1051; § 22.917 (a); § 24.238 (a); §27.53	Spurious Emissions at Antenna Terminal	Compliant
§ 2.1053; § 22.917 (a); § 24.238 (a); §27.53	Field Strength of Spurious Radiation	Compliant
§ 22.917 (a); § 24.238 (a); §27.53(c)(h) (m)	Band Edge	Compliant
§ 2.1055; § 22.355; § 24.235; §27.54;	Frequency stability	Compliant

Note: * Please refer to SAR report released by ATC, report number: SZ1210901-45704E-20.

TEST EQUIPMENT LIST

Manufacturer	Description	Model	Serial Number	Calibration Date	Calibration Due Date
Radiated Emission Test					
Rohde& Schwarz	Test Receiver	ESR	101817	2020/12/24	2021/12/23
Rohde&Schwarz	Spectrum Analyzer	FSV40	101495	2020/12/24	2021/12/23
SONOMA INSTRUMENT	Amplifier	310 N	186131	2020/12/25	2021/12/24
A.H. Systems, inc.	Preamplifier	PAM-0118P	531	2021/07/08	2022/07/07
Quinstar	Amplifier	QLW-18405536-J0	15964001002	2020/11/28	2021/11/27
Anritsu Corp	50 Coaxial Switch	MP59B	6100237248	2020/12/25	2021/12/24
Schwarzbeck	Bilog Antenna	VULB9163	9163-194	2020/01/05	2023/01/04
Schwarzbeck	Bilog Antenna	VULB9163	9163-323	2020/01/05	2023/01/04
Schwarzbeck	Horn Antenna	BBHA9120D	9120D-655	2020/01/05	2023/01/04
Schwarzbeck	Horn Antenna	BBHA9120D	9120D-1067	2020/01/05	2023/01/04
PASTERNAK	Horn Antenn	PE9852/2F-20	1120	2020/01/05	2023/01/04
PASTERNAK	Horn Antenn	PE9852/2F-20	1120	2020/01/05	2023/01/04
OREGON SCIENTIFIC	Temperature & Humidity Meter	JB913R	GZ-WS004	2020/01/02	2023/01/01
Unknown	RF Coaxial Cable	N-5m	No.3	2020/12/25	2021/12/24
Unknown	RF Coaxial Cable	N-5m	No.4	2020/12/25	2021/12/24
Unknown	RF Coaxial Cable	N-1m	No.5	2020/12/25	2021/12/24
Unknown	RF Coaxial Cable	N-1m	No.6	2020/12/25	2021/12/24
Wainwright	High Pass Filter	WHKX3.6/18G-10SS	5	2020/12/25	2021/12/24
CD	High Pass Filter	HPM-1.2/18G-60	110	2020/12/25	2021/12/24
Anritsu	Signal Generator	68369B	004114	2021/7/31	2022/7/30

Manufacturer	Description	Model	Serial Number	Calibration Date	Calibration Due Date
RF Conducted Test					
Rohde & Schwarz	Spectrum Analyzer	FSV-40	101495	2020/12/24	2021/12/23
Rohde & Schwarz	Open Switch and Control Unit	OSP120 + OSP-B157	101244 + 100866	2020/12/24	2021/12/23
Rohde & Schwarz	Wideband Radio Communication Tester	CMW500	154606	2020/12/25	2021/12/24

* **Statement of Traceability:** Shenzhen Accurate Technology Co., Ltd. attests that all calibrations have been performed in accordance to requirements that traceable to National Primary Standards and International System of Units (SI)

FCC §1.1307(b) & §2.1093 - RF EXPOSURE INFORMATION

Applicable Standard

FCC§1.1310 and §2.1093.

Test Result

Compliance, please refer to the SAR report: SZ1210901-45704E-20.

FCC §2.1047 - MODULATION CHARACTERISTIC

According to FCC § 2.1047(d), Part 22H & 24E & 27 there is no specific requirement for digital modulation, therefore modulation characteristic is not presented.

FCC § 2.1046, § 22.913 (a) & § 24.232 (c); §27.50 (c) (d) (h) - RF OUTPUT POWER

Applicable Standard

According to FCC §2.1046 and §22.913 (a), the ERP of mobile transmitters and auxiliary test transmitters must not exceed 7 watts.

According to FCC §2.1046 and §24.232 (C), mobile and portable stations are limited to 2 watts EIRP and the equipment must employ a means for limiting power to the minimum necessary for successful communications.

The peak-to-average power ratio (PAPR) of the transmitter output power must not exceed 13 dB.

According to §27.50(c), Portable stations (hand-held devices) in the 600 MHz uplink band and the 698-746 MHz band, and fixed and mobile stations in the 600 MHz uplink band are limited to 3 watts ERP.

According to §27.50(d), the maximum EIRP must not exceed 1Watts (30dBm) for 1710-1780MHz.

According to §27.50(h), the maximum EIRP must not exceed 2Watts (33dBm) for 2500-2570MHz & 2496-2690MHz.

Test Procedure

Conducted method:

The RF output of the transmitter was connected to the CMW500/CMU200 through sufficient attenuation.

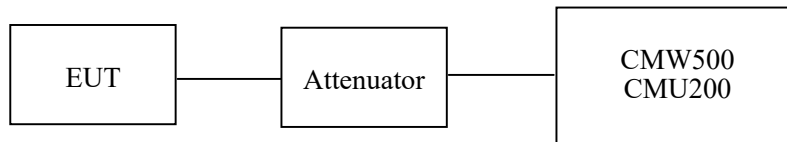

Test Data

Environmental Conditions

Temperature:	28 °C
Relative Humidity:	56 %
ATM Pressure:	101.0 kPa

The testing was performed by Ting Lü from 2021-09-05 to 2021-09-06.

Conducted Power**Cellular Band (Part 22H)**

Mode	Channel	Frequency (MHz)	Average Output Power (dBm)	ERP (dBm)	Limit (dBm)
GSM	128	824.2	30.08	26.33	38.45
	190	836.6	30.11	26.36	38.45
	251	848.8	30.25	26.50	38.45

Mode	Channel	Frequency (MHz)	Average Output Power (dBm)				ERP(dBm)				Limit (dBm)
			1 slot	2 slots	3 slots	4 slots	1 slot	2 slots	3 slots	4 slots	
GPRS	128	824.2	30.02	27.95	25.88	23.54	26.27	24.20	22.13	19.79	38.45
	190	836.6	30.16	27.96	25.87	23.45	26.41	24.21	22.12	19.70	38.45
	251	848.8	30.22	28.01	25.92	23.66	26.47	24.26	22.17	19.91	38.45

Mode	Channel	Frequency (MHz)	Average Output Power (dBm)				ERP(dBm)				Limit (dBm)
			1 slot	2 slots	3 slots	4 slots	1 slot	2 slots	3 slots	4 slots	
EGPRS	128	824.2	27.58	25.05	22.92	21.08	23.83	21.30	19.17	17.33	38.45
	190	836.6	27.23	25.02	22.97	21.13	23.48	21.27	19.22	17.38	38.45
	251	848.8	27.44	25.00	23.02	21.26	23.69	21.25	19.27	17.51	38.45

Mode	Test Mode	3GPP Sub Test	Average Output Power (dBm)			ERP(dBm)		
			Low	Mid	High	Low	Mid	High
WCDMA (Band 5)	RMC12.2k		18.05	18.27	18.31	14.30	14.52	14.56
	HSDPA	1	17.24	17.38	17.17	13.49	13.63	13.42
		2	16.94	17.30	17.09	13.19	13.55	13.34
		3	17.34	17.42	17.21	13.59	13.67	13.46
		4	17.15	17.27	17.04	13.40	13.52	13.29
	HSUPA	1	17.34	17.42	17.22	13.59	13.67	13.47
		2	17.04	17.33	17.14	13.29	13.58	13.39
		3	17.44	17.47	17.31	13.69	13.72	13.56
		4	17.29	17.36	17.10	13.54	13.61	13.35
		5	17.44	17.47	17.28	13.69	13.72	13.53
HSPA+	1	17.26	17.32	17.18	13.51	13.57	13.43	

Note: ERP(dBm) = Conducted Power(dBm) + Antenna Gain(dBd)

For GSM850/WCDMA Band 5: Antenna Gain = -1.6dBi = -3.75dBd (0dBd=2.15dBi)

The limit: ERP ≤ 38.45dBm

PCS Band (Part 24E)

Mode	Channel	Frequency (MHz)	Average Output Power (dBm)	EIRP(dBm)	Limit (dBm)
GSM	512	1850.2	26.38	25.68	33
	661	1880.0	26.26	25.56	33
	810	1909.8	26.69	25.99	33

Mode	Channel	Frequency (MHz)	Average Output Power (dBm)				EIRP(dBm)				Limit (dBm)
			1 slot	2 slots	3 slots	4 slots	1 slot	2 slots	3 slots	4 slots	
GPRS	512	1850.2	26.33	25.02	23.16	21.42	25.63	24.32	22.46	20.72	33
	661	1880.0	26.18	24.93	23.11	21.23	25.48	24.23	22.41	20.53	33
	810	1909.8	26.58	25.13	23.17	21.46	25.88	24.43	22.47	20.76	33

Mode	Channel	Frequency (MHz)	Average Output Power (dBm)				EIRP(dBm)				Limit (dBm)
			1 slot	2 slots	3 slots	4 slots	1 slot	2 slots	3 slots	4 slots	
EGPRS	512	1850.2	26.11	24.69	22.99	21.18	25.41	23.99	22.29	20.48	33
	661	1880.0	26.01	24.51	22.91	21.07	25.31	23.81	22.21	20.37	33
	810	1909.8	26.14	24.72	23.02	21.24	25.44	24.02	22.32	20.54	33

Mode	Test Mode	3GPP Sub Test	Average Output Power (dBm)			EIRP(dBm)		
			Low	Mid	High	Low	Mid	High
WCDMA (Band 2)	RMC12.2k		16.88	16.64	16.44	16.18	15.94	15.74
	HSDPA	1	15.42	15.33	15.39	14.72	14.63	14.69
		2	15.39	15.28	15.27	14.69	14.58	14.57
		3	15.50	15.37	15.46	14.80	14.67	14.76
		4	15.38	15.23	15.36	14.68	14.53	14.66
	HSUPA	1	15.54	15.44	15.43	14.84	14.74	14.73
		2	15.52	15.41	15.34	14.82	14.71	14.64
		3	15.59	15.55	15.52	14.89	14.85	14.82
		4	15.46	15.40	15.38	14.76	14.70	14.68
		5	15.57	15.54	15.55	14.87	14.84	14.85
	HSPA+	1	15.41	15.40	15.39	14.71	14.70	14.69

Note: EIRP(dBm) = Conducted Power(dBm) + Antenna Gain(dBi)
For PCS1900/WCDMA Band 2: Antenna Gain = -0.7dBi
The limit: EIRP ≤ 33dBm

AWS Band (Part 27)

Mode	Test Mode	3GPP Sub Test	Average Output Power (dBm)			EIRP(dBm)		
			Low	Mid	High	Low	Mid	High
WCDMA (Band 4)	RMC12.2k		16.99	17.03	17.22	16.29	16.33	16.52
	HSDPA	1	15.98	16.11	16.08	15.28	15.41	15.38
		2	15.74	15.99	16.04	15.04	15.29	15.34
		3	16.07	16.17	16.20	15.37	15.47	15.50
		4	15.86	16.03	16.02	15.16	15.33	15.32
	HSUPA	1	16.07	16.23	16.11	15.37	15.53	15.41
		2	15.96	16.10	16.01	15.26	15.40	15.31
		3	16.12	16.29	16.16	15.42	15.59	15.46
		4	16.02	16.17	16.06	15.32	15.47	15.36
		5	16.17	16.29	16.17	15.47	15.59	15.47
	HSPA+	1	16.11	16.30	16.22	15.41	15.60	15.52

Note: EIRP(dBm) = Conducted Power(dBm) + Antenna Gain(dBi)

For WCDMA Band 4: Antenna Gain = -0.7dBi

The limit: EIRP ≤ 30dBm

Peak-to-average ratio (PAR)**Cellular Band**

Mode	Channel	PAR (dB)	Limit (dB)
GSM	Low	3.61	13
	Middle	3.58	13
	High	3.52	13

Mode	Channel	PAR (dB)	Limit (dB)
EGPRS	Low	3.56	13
	Middle	3.53	13
	High	3.49	13

Mode	Channel	PAR (dB)	Limit (dB)
RMC (BPSK)	Low	4.77	13
	Middle	4.71	13
	High	4.69	13
HSDPA (16QAM)	Low	4.72	13
	Middle	4.68	13
	High	4.65	13
HSUPA (BPSK)	Low	4.69	13
	Middle	4.64	13
	High	4.62	13
HSPA+	Low	4.77	13
	Middle	4.71	13
	High	4.69	13

PCS Band

Mode	Channel	PAR (dB)	Limit (dB)
GSM	Low	3.97	13
	Middle	3.90	13
	High	3.89	13

Mode	Channel	PAR (dB)	Limit (dB)
EGPRS	Low	3.93	13
	Middle	3.88	13
	High	3.85	13

Mode	Channel	PAR (dB)	Limit (dB)
RMC (BPSK)	Low	4.31	13
	Middle	4.29	13
	High	4.25	13
HSDPA (16QAM)	Low	4.28	13
	Middle	4.25	13
	High	4.22	13
HSUPA (BPSK)	Low	4.25	13
	Middle	4.21	13
	High	4.20	13
HSPA+	Low	4.31	13
	Middle	4.29	13
	High	4.25	13

AWS Band

Mode	Channel	PAR (dB)	Limit (dB)
RMC (BPSK)	Low	4.61	13
	Middle	4.55	13
	High	4.51	13
HSDPA (16QAM)	Low	4.57	13
	Middle	4.53	13
	High	4.48	13
HSUPA (BPSK)	Low	4.54	13
	Middle	4.50	13
	High	4.45	13
HSPA+	Low	4.61	13
	Middle	4.55	13
	High	4.51	13

LTE Band 2:**Maximum Output Power**

Bandwidth (MHz)	Modulation	RB size/ RB Offset	Conducted Average Output Power (dBm)			EIRP(dBm)		
			Low	Mid	High	Low	Mid	High
1.4	QPSK	RB1#0	15.91	15.87	15.85	15.21	15.17	15.15
		RB1#3	16.03	16.01	15.99	15.33	15.31	15.29
		RB1#5	15.88	15.87	15.83	15.18	15.17	15.13
		RB3#0	16.00	16.03	15.94	15.30	15.33	15.24
		RB3#3	16.01	15.95	16.01	15.31	15.25	15.31
		RB6#0	14.97	14.92	14.90	14.27	14.22	14.20
	16QAM	RB1#0	15.02	14.89	14.85	14.32	14.19	14.15
		RB1#3	15.18	15.04	15.02	14.48	14.34	14.32
		RB1#5	15.02	14.91	14.88	14.32	14.21	14.18
		RB3#0	14.97	15.06	15.14	14.27	14.36	14.44
		RB3#3	14.97	15.04	15.16	14.27	14.34	14.46
		RB6#0	14.02	13.85	13.90	13.32	13.15	13.20
3.0	QPSK	RB1#0	15.98	16.02	15.93	15.28	15.32	15.23
		RB1#8	15.86	15.93	15.89	15.16	15.23	15.19
		RB1#14	15.94	15.96	15.90	15.24	15.26	15.20
		RB6#0	14.92	14.90	14.83	14.22	14.20	14.13
		RB6#9	14.91	14.91	14.89	14.21	14.21	14.19
		RB15#0	14.95	14.94	14.90	14.25	14.24	14.20
	16QAM	RB1#0	15.60	15.13	14.98	14.90	14.43	14.28
		RB1#8	15.52	15.08	14.90	14.82	14.38	14.20
		RB1#14	15.55	15.16	14.91	14.85	14.46	14.21
		RB6#0	14.02	13.94	13.79	13.32	13.24	13.09
		RB6#9	13.99	13.97	13.77	13.29	13.27	13.07
		RB15#0	14.06	13.89	13.93	13.36	13.19	13.23

Bandwidth (MHz)	Modulation	RB size/ RB Offset	Conducted Average Output Power (dBm)			EIRP(dBm)		
			Low	Mid	High	Low	Mid	High
5.0	QPSK	RB1#0	15.93	15.97	15.83	15.23	15.27	15.13
		RB1#13	15.97	15.96	15.90	15.27	15.26	15.20
		RB1#24	15.98	16.00	15.90	15.28	15.30	15.20
		RB15#0	14.97	14.91	14.91	14.27	14.21	14.21
		RB15#10	14.90	14.94	14.86	14.20	14.24	14.16
		RB25#0	14.91	14.96	14.84	14.21	14.26	14.14
	16QAM	RB1#0	14.87	15.28	14.93	14.17	14.58	14.23
		RB1#13	14.88	15.26	14.99	14.18	14.56	14.29
		RB1#24	14.85	15.30	15.01	14.15	14.60	14.31
		RB15#0	14.03	13.91	13.98	13.33	13.21	13.28
		RB15#10	13.96	13.92	13.95	13.26	13.22	13.25
		RB25#0	13.99	13.96	13.93	13.29	13.26	13.23
10.0	QPSK	RB1#0	15.94	15.95	15.97	15.24	15.25	15.27
		RB1#25	16.01	16.04	16.02	15.31	15.34	15.32
		RB1#49	15.96	15.97	15.97	15.26	15.27	15.27
		RB25#0	15.04	14.94	15.01	14.34	14.24	14.31
		RB25#25	14.91	14.99	14.89	14.21	14.29	14.19
		RB50#0	14.99	14.97	14.95	14.29	14.27	14.25
	16QAM	RB1#0	15.60	15.12	14.98	14.90	14.42	14.28
		RB1#25	15.69	15.22	15.07	14.99	14.52	14.37
		RB1#49	15.59	15.18	15.03	14.89	14.48	14.33
		RB25#0	14.09	14.02	14.09	13.39	13.32	13.39
		RB25#25	14.02	14.03	14.06	13.32	13.33	13.36
		RB50#0	14.01	14.03	14.03	13.31	13.33	13.33

Bandwidth (MHz)	Modulation	RB size/ RB Offset	Conducted Average Output Power (dBm)			EIRP(dBm)		
			Low	Mid	High	Low	Mid	High
15.0	QPSK	RB1#0	15.89	15.97	15.90	15.19	15.27	15.20
		RB1#38	15.94	15.99	15.93	15.24	15.29	15.23
		RB1#74	15.93	15.96	15.92	15.23	15.26	15.22
		RB36#0	15.05	15.09	15.04	14.35	14.39	14.34
		RB36#39	15.07	15.08	14.96	14.37	14.38	14.26
		RB75#0	15.03	15.05	14.96	14.33	14.35	14.26
	16QAM	RB1#0	15.56	15.12	15.30	14.86	14.42	14.60
		RB1#38	15.60	15.14	15.37	14.90	14.44	14.67
		RB1#74	15.62	15.13	15.35	14.92	14.43	14.65
		RB36#0	13.98	14.00	13.97	13.28	13.30	13.27
		RB36#39	14.02	14.06	13.93	13.32	13.36	13.23
		RB75#0	14.03	14.05	13.96	13.33	13.35	13.26
20.0	QPSK	RB1#0	15.84	15.89	15.77	15.14	15.19	15.07
		RB1#50	16.19	16.16	16.09	15.49	15.46	15.39
		RB1#99	15.90	15.90	15.83	15.20	15.20	15.13
		RB50#0	15.14	15.05	15.11	14.44	14.35	14.41
		RB50#50	15.01	15.00	14.97	14.31	14.30	14.27
		RB100#0	15.08	15.03	15.03	14.38	14.33	14.33
	16QAM	RB1#0	15.14	15.15	15.37	14.44	14.45	14.67
		RB1#50	15.43	15.39	15.67	14.73	14.69	14.97
		RB1#99	15.16	15.13	15.44	14.46	14.43	14.74
		RB50#0	14.15	14.10	14.11	13.45	13.40	13.41
		RB50#50	14.00	14.05	13.96	13.30	13.35	13.26
		RB100#0	14.10	14.04	14.03	13.40	13.34	13.33

Note: EIRP(dBm) = Conducted Power(dBm) + Antenna Gain(dBi)

For LTE Band2: Antenna Gain = -0.7dBi

The Limit: EIRP ≤ 33dBm

Peak-to-average ratio (PAR)**20MHz Bandwidth**

Modulation	Low channel (dB)	Middle channel (dB)	High channel (dB)	PAR Limit (dB)	Result
QPSK (1RB Size)	7.71	7.29	7.26	13	Pass
QPSK (100RB Size)	7.35	6.32	7.13	13	Pass
16QAM (1RB Size)	6.80	7.10	6.94	13	Pass
16QAM (100RB Size)	6.31	6.15	6.12	13	Pass

LTE Band 4**Maximum Output Power**

Bandwidth (MHz)	Modulation	RB size/ RB Offset	Conducted Average Output Power (dBm)			EIRP(dBm)		
			Low	Mid	High	Low	Mid	High
1.4	QPSK	RB1#0	16.11	16.06	15.97	15.41	15.36	15.27
		RB1#3	16.23	16.16	16.14	15.53	15.46	15.44
		RB1#5	16.08	16.04	15.99	15.38	15.34	15.29
		RB3#0	16.18	16.13	16.09	15.48	15.43	15.39
		RB3#3	16.22	16.09	16.10	15.52	15.39	15.40
		RB6#0	15.15	15.07	15.05	14.45	14.37	14.35
	16QAM	RB1#0	15.12	15.17	15.01	14.42	14.47	14.31
		RB1#3	15.24	15.34	15.12	14.54	14.64	14.42
		RB1#5	15.14	15.13	15.05	14.44	14.43	14.35
		RB3#0	15.42	15.10	15.20	14.72	14.40	14.50
		RB3#3	15.45	15.13	15.19	14.75	14.43	14.49
		RB6#0	14.13	14.09	14.00	13.43	13.39	13.30
3.0	QPSK	RB1#0	16.17	16.10	16.03	15.47	15.40	15.33
		RB1#8	16.09	16.07	15.99	15.39	15.37	15.29
		RB1#14	16.13	16.03	16.05	15.43	15.33	15.35
		RB6#0	15.13	15.03	14.99	14.43	14.33	14.29
		RB6#9	15.14	14.97	15.00	14.44	14.27	14.30
		RB15#0	15.13	15.08	15.02	14.43	14.38	14.32
	16QAM	RB1#0	15.87	15.30	15.11	15.17	14.60	14.41
		RB1#8	15.75	15.24	15.08	15.05	14.54	14.38
		RB1#14	15.81	15.25	15.07	15.11	14.55	14.37
		RB6#0	14.18	14.07	13.95	13.48	13.37	13.25
		RB6#9	14.21	14.09	13.96	13.51	13.39	13.26
		RB15#0	14.20	14.04	14.12	13.50	13.34	13.42

Bandwidth (MHz)	Modulation	RB size/ RB Offset	Conducted Average Output Power (dBm)			EIRP(dBm)		
			Low	Mid	High	Low	Mid	High
5.0	QPSK	RB1#0	16.19	16.15	16.06	15.49	15.45	15.36
		RB1#13	16.18	16.11	16.04	15.48	15.41	15.34
		RB1#24	16.19	16.15	16.11	15.49	15.45	15.41
		RB15#0	15.15	15.10	15.09	14.45	14.40	14.39
		RB15#10	15.20	15.10	15.07	14.50	14.40	14.37
		RB25#0	15.15	15.10	15.08	14.45	14.40	14.38
	16QAM	RB1#0	15.13	15.45	15.20	14.43	14.75	14.50
		RB1#13	15.09	15.43	15.14	14.39	14.73	14.44
		RB1#24	15.07	15.39	15.22	14.37	14.69	14.52
		RB15#0	14.21	14.11	14.14	13.51	13.41	13.44
		RB15#10	14.25	14.09	14.10	13.55	13.39	13.40
		RB25#0	14.23	14.12	14.12	13.53	13.42	13.42
10.0	QPSK	RB1#0	16.14	16.14	16.06	15.44	15.44	15.36
		RB1#25	16.26	16.22	16.15	15.56	15.52	15.45
		RB1#49	16.12	16.12	16.08	15.42	15.42	15.38
		RB25#0	15.15	15.19	15.11	14.45	14.49	14.41
		RB25#25	15.24	15.17	15.10	14.54	14.47	14.40
		RB50#0	15.23	15.18	15.12	14.53	14.48	14.42
	16QAM	RB1#0	15.86	15.28	15.09	15.16	14.58	14.39
		RB1#25	15.93	15.38	15.22	15.23	14.68	14.52
		RB1#49	15.81	15.23	15.12	15.11	14.53	14.42
		RB25#0	14.24	14.25	14.23	13.54	13.55	13.53
		RB25#25	14.32	14.26	14.22	13.62	13.56	13.52
		RB50#0	14.25	14.22	14.16	13.55	13.52	13.46

Bandwidth (MHz)	Modulation	RB size/ RB Offset	Conducted Average Output Power (dBm)			EIRP(dBm)		
			Low	Mid	High	Low	Mid	High
15.0	QPSK	RB1#0	16.14	16.16	16.04	15.44	15.46	15.34
		RB1#38	16.12	16.09	16.03	15.42	15.39	15.33
		RB1#74	16.09	16.07	16.04	15.39	15.37	15.34
		RB36#0	15.22	15.19	15.12	14.52	14.49	14.42
		RB36#39	15.21	15.17	15.06	14.51	14.47	14.36
		RB75#0	15.20	15.13	15.09	14.50	14.43	14.39
	16QAM	RB1#0	15.82	15.30	15.54	15.12	14.60	14.84
		RB1#38	15.81	15.27	15.53	15.11	14.57	14.83
		RB1#74	15.73	15.22	15.50	15.03	14.52	14.80
		RB36#0	14.15	14.18	14.11	13.45	13.48	13.41
		RB36#39	14.21	14.16	14.04	13.51	13.46	13.34
		RB75#0	14.19	14.15	14.07	13.49	13.45	13.37
20.0	QPSK	RB1#0	16.11	16.00	15.95	15.41	15.30	15.25
		RB1#50	16.29	16.26	16.14	15.59	15.56	15.44
		RB1#99	16.05	16.01	15.91	15.35	15.31	15.21
		RB50#0	15.18	15.22	15.15	14.48	14.52	14.45
		RB50#50	15.23	15.16	15.05	14.53	14.46	14.35
		RB100#0	15.21	15.19	15.13	14.51	14.49	14.43
	16QAM	RB1#0	15.39	15.25	15.59	14.69	14.55	14.89
		RB1#50	15.62	15.53	15.73	14.92	14.83	15.03
		RB1#99	15.36	15.22	15.57	14.66	14.52	14.87
		RB50#0	14.13	14.26	14.21	13.43	13.56	13.51
		RB50#50	14.23	14.21	14.11	13.53	13.51	13.41
		RB100#0	14.22	14.24	14.17	13.52	13.54	13.47

Note: EIRP(dBm) = Conducted Power(dBm) + Antenna Gain(dBi)

For LTE Band 4: Antenna Gain = -0.7dBi

The Limit: EIRP≤30dBm

Peak-to-average ratio (PAR)**20MHz Bandwidth**

Modulation	Low channel (dB)	Middle channel (dB)	High channel (dB)	PAR Limit (dB)	Result
QPSK (1RB Size)	6.91	6.68	6.42	13	Pass
QPSK (100RB Size)	6.26	6.32	6.22	13	Pass
16QAM (1RB Size)	7.71	7.61	7.32	13	Pass
16QAM (100RB Size)	6.09	6.15	6.12	13	Pass

LTE Band 5:**Maximum Output Power**

Bandwidth (MHz)	Modulation	RB size/ RB Offset	Conducted Average Output Power (dBm)			ERP(dBm)		
			Low	Mid	High	Low	Mid	High
1.4	QPSK	RB1#0	17.52	17.48	17.37	13.77	13.73	13.62
		RB1#3	17.70	17.59	17.56	13.95	13.84	13.81
		RB1#5	17.57	17.42	17.38	13.82	13.67	13.63
		RB3#0	17.63	17.61	17.50	13.88	13.86	13.75
		RB3#3	17.62	17.65	17.48	13.87	13.90	13.73
		RB6#0	16.60	16.58	16.52	12.85	12.83	12.77
	16QAM	RB1#0	16.61	16.52	16.45	12.86	12.77	12.70
		RB1#3	16.75	16.72	16.63	13.00	12.97	12.88
		RB1#5	16.62	16.71	16.49	12.87	12.96	12.74
		RB3#0	16.85	16.61	16.67	13.10	12.86	12.92
		RB3#3	16.90	16.76	16.65	13.15	13.01	12.90
		RB6#0	15.65	15.65	15.47	11.90	11.90	11.72
3.0	QPSK	RB1#0	17.56	17.55	17.46	13.81	13.80	13.71
		RB1#8	17.53	17.50	17.38	13.78	13.75	13.63
		RB1#14	17.52	17.54	17.47	13.77	13.79	13.72
		RB6#0	16.59	16.55	16.45	12.84	12.80	12.70
		RB6#9	16.62	16.58	16.46	12.87	12.83	12.71
		RB15#0	16.60	16.58	16.48	12.85	12.83	12.73
	16QAM	RB1#0	17.21	16.75	16.54	13.46	13.00	12.79
		RB1#8	17.14	16.54	16.48	13.39	12.79	12.73
		RB1#14	17.26	16.70	16.52	13.51	12.95	12.77
		RB6#0	15.66	15.58	15.41	11.91	11.83	11.66
		RB6#9	15.66	15.59	15.44	11.91	11.84	11.69
		RB15#0	15.67	15.52	15.51	11.92	11.77	11.76

Bandwidth (MHz)	Modulation	RB size/ RB Offset	Conducted Average Output Power (dBm)			ERP(dBm)		
			Low	Mid	High	Low	Mid	High
5.0	QPSK	RB1#0	17.61	17.57	17.44	13.86	13.82	13.69
		RB1#13	17.69	17.52	17.43	13.94	13.77	13.68
		RB1#24	17.64	17.54	17.46	13.89	13.79	13.71
		RB15#0	16.61	16.63	16.53	12.86	12.88	12.78
		RB15#10	16.64	16.56	16.48	12.89	12.81	12.73
		RB25#0	16.64	16.60	16.44	12.89	12.85	12.69
	16QAM	RB1#0	16.58	16.88	16.60	12.83	13.13	12.85
		RB1#13	16.53	16.89	16.60	12.78	13.14	12.85
		RB1#24	16.57	16.85	16.58	12.82	13.10	12.83
		RB15#0	15.66	15.60	15.56	11.91	11.85	11.81
		RB15#10	15.71	15.55	15.48	11.96	11.80	11.73
		RB25#0	15.65	15.59	15.49	11.90	11.84	11.74
10.0	QPSK	RB1#0	17.57	17.57	17.47	13.82	13.82	13.72
		RB1#25	17.67	17.65	17.56	13.92	13.90	13.81
		RB1#49	17.52	17.53	17.45	13.77	13.78	13.70
		RB25#0	16.59	16.63	16.62	12.84	12.88	12.87
		RB25#25	16.67	16.52	16.49	12.92	12.77	12.74
		RB50#0	16.62	16.54	16.57	12.87	12.79	12.82
	16QAM	RB1#0	17.24	16.76	16.53	13.49	13.01	12.78
		RB1#25	17.33	16.85	16.62	13.58	13.10	12.87
		RB1#49	17.18	16.70	16.52	13.43	12.95	12.77
		RB25#0	15.67	15.65	15.74	11.92	11.90	11.99
		RB25#25	15.72	15.54	15.55	11.97	11.79	11.80
		RB50#0	15.61	15.62	15.62	11.86	11.87	11.87

Note: ERP(dBm) = Conducted Power(dBm) + Antenna Gain(dBd)
For LTE Band 5: Antenna Gain = -1.6dBi = -3.75dBd (0dBd=2.15dBi)
Limit: ERP ≤ 38.45dBm

Peak-to-average ratio (PAR)**10MHz bandwidth**

Modulation	Low channel (dB)	Middle channel (dB)	High channel (dB)	PAR Limit (dB)	Result
QPSK (1RB Size)	4.59	4.84	5.46	13	Pass
QPSK (50RB Size)	5.35	5.16	5.29	13	Pass
16QAM (1RB Size)	4.29	5.80	4.13	13	Pass
16QAM (50RB Size)	6.22	6.22	6.12	13	Pass

LTE Band 7:**Maximum Output Power**

Bandwidth (MHz)	Modulation	RB size/ RB Offset	Conducted Average Output Power (dBm)			EIRP(dBm)		
			Low	Mid	High	Low	Mid	High
5.0	QPSK	RB1#0	15.50	15.64	15.69	15.10	15.24	15.29
		RB1#13	15.56	15.66	15.77	15.16	15.26	15.37
		RB1#24	15.53	15.66	15.76	15.13	15.26	15.36
		RB15#0	14.52	14.55	14.80	14.12	14.15	14.40
		RB15#10	14.50	14.70	14.73	14.10	14.30	14.33
		RB25#0	14.50	14.55	14.73	14.10	14.15	14.33
	16QAM	RB1#0	14.39	14.94	14.80	13.99	14.54	14.40
		RB1#13	14.44	14.97	14.85	14.04	14.57	14.45
		RB1#24	14.41	14.94	14.83	14.01	14.54	14.43
		RB15#0	13.64	13.58	13.92	13.24	13.18	13.52
		RB15#10	13.59	13.68	13.82	13.19	13.28	13.42
		RB25#0	13.62	13.72	13.82	13.22	13.32	13.42
10.0	QPSK	RB1#0	15.49	15.59	15.66	15.09	15.19	15.26
		RB1#25	15.64	15.74	15.76	15.24	15.34	15.36
		RB1#49	15.50	15.66	15.71	15.10	15.26	15.31
		RB25#0	14.54	14.63	14.72	14.14	14.23	14.32
		RB25#25	14.57	14.58	14.69	14.17	14.18	14.29
		RB50#0	14.58	14.63	14.72	14.18	14.23	14.32
	16QAM	RB1#0	15.18	14.72	14.68	14.78	14.32	14.28
		RB1#25	15.24	14.88	14.82	14.84	14.48	14.42
		RB1#49	15.19	14.79	14.73	14.79	14.39	14.33
		RB25#0	13.62	13.78	13.85	13.22	13.38	13.45
		RB25#25	13.76	13.71	13.86	13.36	13.31	13.46
		RB50#0	13.69	13.72	13.80	13.29	13.32	13.40

Bandwidth (MHz)	Modulation	RB size/ RB Offset	Conducted Average Output Power (dBm)			EIRP(dBm)		
			Low	Mid	High	Low	Mid	High
15.0	QPSK	RB1#0	15.42	15.59	15.62	15.02	15.19	15.22
		RB1#38	15.51	15.59	15.70	15.11	15.19	15.30
		RB1#74	15.49	15.57	15.71	15.09	15.17	15.31
		RB36#0	14.55	14.63	14.70	14.15	14.23	14.30
		RB36#39	14.64	14.63	14.71	14.24	14.23	14.31
		RB75#0	14.58	14.61	14.67	14.18	14.21	14.27
	16QAM	RB1#0	15.11	14.72	15.02	14.71	14.32	14.62
		RB1#38	15.19	14.74	15.11	14.79	14.34	14.71
		RB1#74	15.15	14.74	15.15	14.75	14.34	14.75
		RB36#0	13.58	13.69	13.71	13.18	13.29	13.31
		RB36#39	13.70	13.70	13.77	13.30	13.30	13.37
		RB75#0	13.64	13.73	13.72	13.24	13.33	13.32
20.0	QPSK	RB1#0	15.38	15.48	15.37	14.98	15.08	14.97
		RB1#50	15.66	15.80	15.76	15.26	15.40	15.36
		RB1#99	15.49	15.57	15.52	15.09	15.17	15.12
		RB50#0	14.54	14.64	14.65	14.14	14.24	14.25
		RB50#50	14.71	14.61	14.70	14.31	14.21	14.30
		RB100#0	14.62	14.67	14.71	14.22	14.27	14.31
	16QAM	RB1#0	14.69	14.68	15.04	14.29	14.28	14.64
		RB1#50	15.04	15.01	15.40	14.64	14.61	15.00
		RB1#99	14.78	14.75	15.20	14.38	14.35	14.80
		RB50#0	13.55	13.73	13.68	13.15	13.33	13.28
		RB50#50	13.80	13.68	13.78	13.40	13.28	13.38
		RB100#0	13.73	13.70	13.75	13.33	13.30	13.35

Note: EIRP(dBm) = Conducted Power(dBm) + Antenna Gain(dBi)

For LTE Band7: Antenna Gain = -0.4dBi

Limit: EIRP ≤ 33dBm

Peak-to-average ratio (PAR)**20MHz bandwidth**

Modulation	Low channel (dB)	Middle channel (dB)	High channel (dB)	PAR Limit (dB)	Result
QPSK (1RB Size)	5.21	6.33	6.49	13	Pass
QPSK (100RB Size)	5.72	5.53	5.38	13	Pass
16QAM (1RB Size)	4.66	5.21	5.33	13	Pass
16QAM (100RB Size)	6.38	6.26	6.43	13	Pass

LTE Band 17:**Maximum Output Power**

Bandwidth (MHz)	Modulation	RB size/ RB Offset	Conducted Average Output Power (dBm)			EIRP(dBm)		
			Low	Mid	High	Low	Mid	High
5.0	QPSK	RB1#0	23.57	23.64	23.59	19.52	19.59	19.54
		RB1#13	23.63	23.59	23.60	19.58	19.54	19.55
		RB1#24	23.59	23.60	23.56	19.54	19.55	19.51
		RB15#0	22.61	22.53	22.74	18.56	18.48	18.69
		RB15#10	22.67	22.65	22.53	18.62	18.60	18.48
		RB25#0	22.67	22.60	22.60	18.62	18.55	18.55
	16QAM	RB1#0	22.51	22.96	22.65	18.46	18.91	18.60
		RB1#13	22.54	22.86	22.65	18.49	18.81	18.60
		RB1#24	22.55	22.88	22.60	18.50	18.83	18.55
		RB15#0	21.74	21.50	21.76	17.69	17.45	17.71
		RB15#10	21.74	21.64	21.60	17.69	17.59	17.55
		RB25#0	21.76	21.60	21.64	17.71	17.55	17.59
10.0	QPSK	RB1#0	23.58	23.62	23.62	19.53	19.57	19.57
		RB1#25	23.67	23.65	23.77	19.62	19.60	19.72
		RB1#49	23.57	23.59	23.61	19.52	19.54	19.56
		RB25#0	22.59	22.52	22.55	18.54	18.47	18.50
		RB25#25	22.64	22.52	22.46	18.59	18.47	18.41
		RB50#0	22.67	22.53	22.54	18.62	18.48	18.49
	16QAM	RB1#0	23.19	22.79	22.65	19.14	18.74	18.60
		RB1#25	23.24	22.83	22.70	19.19	18.78	18.65
		RB1#49	23.09	22.73	22.59	19.04	18.68	18.54
		RB25#0	21.75	21.58	21.63	17.70	17.53	17.58
		RB25#25	21.68	21.53	21.51	17.63	17.48	17.46
		RB50#0	21.71	21.57	21.56	17.66	17.52	17.51

Note: ERP(dBm) = Conducted Power(dBm) + Antenna Gain(dBd))

For LTE Band17: Antenna Gain = -1.9dBi = -4.05dBd (0dBd=2.15dBi)

Limit: ERP ≤ 34.77dBm

Peak-to-average ratio (PAR)**10MHz bandwidth**

Modulation	Low channel (dB)	Middle channel (dB)	High channel (dB)	PAR Limit (dB)	Result
QPSK (1RB Size)	5.32	5.37	5.38	13	Pass
QPSK (50RB Size)	5.43	5.76	5.29	13	Pass
16QAM (1RB Size)	5.18	5.87	5.24	13	Pass
16QAM (50RB Size)	6.32	6.52	6.34	13	Pass

LTE Band 38:**Maximum Output Power**

Bandwidth (MHz)	Modulation	RB size/ RB Offset	Conducted Average Output Power (dBm)			EIRP(dBm)		
			Low	Mid	High	Low	Mid	High
5.0	QP SK	RB1#0	17.76	17.83	17.82	17.36	17.43	17.42
		RB1#13	17.77	17.81	17.80	17.37	17.41	17.40
		RB1#24	17.78	17.86	17.82	17.38	17.46	17.42
		RB15#0	16.74	16.78	16.83	16.34	16.38	16.43
		RB15#10	16.79	16.84	16.83	16.39	16.44	16.43
		RB25#0	16.78	16.83	16.84	16.38	16.43	16.44
	16QAM	RB1#0	17.06	16.85	16.90	16.66	16.45	16.50
		RB1#13	17.06	16.85	16.98	16.66	16.45	16.58
		RB1#24	17.09	16.88	16.93	16.69	16.48	16.53
		RB15#0	15.81	15.75	15.87	15.41	15.35	15.47
		RB15#10	15.84	15.78	15.90	15.44	15.38	15.50
		RB25#0	15.79	15.91	15.91	15.39	15.51	15.51
10.0	QPSK	RB1#0	17.75	17.81	17.84	17.35	17.41	17.44
		RB1#25	18.02	18.08	18.14	17.62	17.68	17.74
		RB1#49	17.85	17.85	17.86	17.45	17.45	17.46
		RB25#0	16.79	16.83	16.87	16.39	16.43	16.47
		RB25#25	16.82	16.83	16.84	16.42	16.43	16.44
		RB50#0	16.80	16.84	16.85	16.40	16.44	16.45
	16QAM	RB1#0	17.04	16.80	17.00	16.64	16.40	16.60
		RB1#25	17.31	17.05	17.29	16.91	16.65	16.89
		RB1#49	17.10	16.81	17.02	16.70	16.41	16.62
		RB25#0	15.81	15.91	15.95	15.41	15.51	15.55
		RB25#25	15.86	15.91	15.92	15.46	15.51	15.52
		RB50#0	15.84	15.90	15.93	15.44	15.50	15.53

Bandwidth (MHz)	Modulation	RB size/ RB Offset	Conducted Average Output Power (dBm)			EIRP(dBm)		
			Low	Mid	High	Low	Mid	High
15.0	QPSK	RB1#0	17.73	17.80	17.73	17.33	17.40	17.33
		RB1#38	17.78	17.80	17.86	17.38	17.40	17.46
		RB1#74	17.78	17.78	17.79	17.38	17.38	17.39
		RB36#0	16.76	16.80	16.84	16.36	16.40	16.44
		RB36#39	16.86	16.86	16.90	16.46	16.46	16.50
		RB75#0	16.81	16.84	16.84	16.41	16.44	16.44
	16QAM	RB1#0	16.98	16.80	17.01	16.58	16.40	16.61
		RB1#38	17.04	16.81	17.14	16.64	16.41	16.74
		RB1#74	17.04	16.81	17.14	16.64	16.41	16.74
		RB36#0	15.73	15.75	15.88	15.33	15.35	15.48
		RB36#39	15.84	15.80	15.93	15.44	15.40	15.53
		RB75#0	15.76	15.83	15.86	15.36	15.43	15.46
20.0	QPSK	RB1#0	17.56	17.61	17.73	17.16	17.21	17.33
		RB1#50	18.01	17.98	18.15	17.61	17.58	17.75
		RB1#99	17.72	17.65	17.80	17.32	17.25	17.40
		RB50#0	16.73	16.79	16.78	16.33	16.39	16.38
		RB50#50	16.81	16.81	16.86	16.41	16.41	16.46
		RB100#0	16.79	16.82	16.85	16.39	16.42	16.45
	16QAM	RB1#0	16.70	16.67	17.00	16.30	16.27	16.60
		RB1#50	17.15	17.02	17.40	16.75	16.62	17.00
		RB1#99	16.88	16.72	17.07	16.48	16.32	16.67
		RB50#0	15.75	15.88	15.84	15.35	15.48	15.44
		RB50#50	15.85	15.91	15.91	15.45	15.51	15.51
		RB100#0	15.81	15.86	15.88	15.41	15.46	15.48

Note: EIRP(dBm) = Conducted Power(dBm) + Antenna Gain(dBi)

For LTE Band38: Antenna Gain = -0.4dBi

Limit: EIRP ≤ 33dBm

Peak-to-average ratio (PAR)**20MHz bandwidth**

Modulation	Low channel (dB)	Middle channel (dB)	High channel (dB)	PAR Limit (dB)	Result
QPSK (1RB Size)	7.63	7.36	7.33	13	Pass
QPSK (100RB Size)	7.63	7.58	7.38	13	Pass
16QAM (1RB Size)	8.11	7.29	7.45	13	Pass
16QAM (100RB Size)	7.37	7.28	7.36	13	Pass

LTE Band 41:**Maximum Output Power**

Bandwidth (MHz)	Modulation	RB size/ RB Offset	Conducted Average Output Power (dBm)			EIRP(dBm)		
			Low	Mid	High	Low	Mid	High
5.0	QP SK	RB1#0	17.68	17.80	17.88	17.28	17.40	17.48
		RB1#13	17.71	17.83	17.89	17.31	17.43	17.49
		RB1#24	17.70	17.81	17.87	17.30	17.41	17.47
		RB15#0	16.70	16.83	16.91	16.30	16.43	16.51
		RB15#10	16.71	16.86	16.90	16.31	16.46	16.50
		RB25#0	16.71	16.83	16.91	16.31	16.43	16.51
	16QAM	RB1#0	16.74	16.94	17.15	16.34	16.54	16.75
		RB1#13	16.76	16.95	17.19	16.36	16.55	16.79
		RB1#24	16.75	16.94	17.17	16.35	16.54	16.77
		RB15#0	15.65	15.87	15.94	15.25	15.47	15.54
		RB15#10	15.65	15.88	15.94	15.25	15.48	15.54
		RB25#0	15.73	15.91	15.86	15.33	15.51	15.46
10.0	QPSK	RB1#0	17.69	17.81	17.94	17.29	17.41	17.54
		RB1#25	17.94	18.08	18.18	17.54	17.68	17.78
		RB1#49	17.74	17.86	17.93	17.34	17.46	17.53
		RB25#0	16.72	16.87	16.93	16.32	16.47	16.53
		RB25#25	16.71	16.84	16.94	16.31	16.44	16.54
		RB50#0	16.69	16.85	16.90	16.29	16.45	16.50
	16QAM	RB1#0	16.97	16.85	17.07	16.57	16.45	16.67
		RB1#25	17.20	17.07	17.32	16.80	16.67	16.92
		RB1#49	17.00	16.82	17.07	16.60	16.42	16.67
		RB25#0	15.71	15.92	15.94	15.31	15.52	15.54
		RB25#25	15.70	15.92	15.93	15.30	15.52	15.53
		RB50#0	15.71	15.89	15.91	15.31	15.49	15.51

Bandwidth (MHz)	Modulation	RB size/ RB Offset	Conducted Average Output Power (dBm)			EIRP(dBm)		
			Low	Mid	High	Low	Mid	High
15.0	QPSK	RB1#0	17.65	17.77	17.88	17.25	17.37	17.48
		RB1#38	17.74	17.85	17.91	17.34	17.45	17.51
		RB1#74	17.68	17.81	17.86	17.28	17.41	17.46
		RB36#0	16.72	16.80	16.94	16.32	16.40	16.54
		RB36#39	16.78	16.88	16.96	16.38	16.48	16.56
		RB75#0	16.73	16.83	16.95	16.33	16.43	16.55
	16QAM	RB1#0	16.90	16.77	17.15	16.50	16.37	16.75
		RB1#38	17.00	16.84	17.20	16.60	16.44	16.80
		RB1#74	16.93	16.80	17.12	16.53	16.40	16.72
		RB36#0	15.68	15.77	15.97	15.28	15.37	15.57
		RB36#39	15.73	15.85	15.98	15.33	15.45	15.58
		RB75#0	15.67	15.83	15.96	15.27	15.43	15.56
20.0	QPSK	RB1#0	17.49	17.56	17.81	17.09	17.16	17.41
		RB1#50	17.93	18.02	18.21	17.53	17.62	17.81
		RB1#99	17.58	17.65	17.84	17.18	17.25	17.44
		RB50#0	16.67	16.78	16.89	16.27	16.38	16.49
		RB50#50	16.74	16.86	16.92	16.34	16.46	16.52
		RB100#0	16.68	16.85	16.91	16.28	16.45	16.51
	16QAM	RB1#0	16.64	16.63	17.07	16.24	16.23	16.67
		RB1#50	17.05	17.07	17.48	16.65	16.67	17.08
		RB1#99	16.71	16.71	17.12	16.31	16.31	16.72
		RB50#0	15.68	15.89	15.92	15.28	15.49	15.52
		RB50#50	15.76	15.93	15.95	15.36	15.53	15.55
		RB100#0	15.73	15.87	15.93	15.33	15.47	15.53

Note: EIRP(dBm) = Conducted Power(dBm) + Antenna Gain(dBi)

For LTE Band38: Antenna Gain = -0.4dBi

Limit: EIRP ≤ 33dBm

Peak-to-average ratio (PAR)**20MHz bandwidth**

Modulation	Low channel (dB)	Middle channel (dB)	High channel (dB)	PAR Limit (dB)	Result
QPSK (1RB Size)	7.54	7.43	7.54	13	Pass
QPSK (100RB Size)	7.38	7.64	7.18	13	Pass
16QAM (1RB Size)	7.43	7.12	7.26	13	Pass
16QAM (100RB Size)	7.58	7.34	7.18	13	Pass

LTE Band 66:**Maximum Output Power**

Bandwidth (MHz)	Modulation	RB size/ RB Offset	Conducted Average Output Power (dBm)			EIRP(dBm)		
			Low	Mid	High	Low	Mid	High
1.4	QPSK	RB1#0	16.83	16.94	16.83	16.13	16.24	16.13
		RB1#3	17.13	17.00	17.00	16.43	16.30	16.30
		RB1#5	16.95	16.86	16.78	16.25	16.16	16.08
		RB3#0	17.06	16.97	16.95	16.36	16.27	16.25
		RB3#3	17.08	16.97	17.06	16.38	16.27	16.36
		RB6#0	16.03	15.94	15.87	15.33	15.24	15.17
	16QAM	RB1#0	15.97	16.01	15.84	15.27	15.31	15.14
		RB1#3	16.09	16.16	16.04	15.39	15.46	15.34
		RB1#5	15.97	16.04	15.92	15.27	15.34	15.22
		RB3#0	16.27	16.00	16.07	15.57	15.30	15.37
		RB3#3	16.30	16.02	16.07	15.60	15.32	15.37
		RB6#0	15.08	14.99	14.84	14.38	14.29	14.14
3.0	QPSK	RB1#0	17.06	16.95	16.92	16.36	16.25	16.22
		RB1#8	17.01	16.95	16.90	16.31	16.25	16.20
		RB1#14	16.99	16.94	16.87	16.29	16.24	16.17
		RB6#0	15.96	15.90	15.86	15.26	15.20	15.16
		RB6#9	15.97	15.86	15.87	15.27	15.16	15.17
		RB15#0	16.07	15.98	15.94	15.37	15.28	15.24
	16QAM	RB1#0	16.70	16.14	15.99	16.00	15.44	15.29
		RB1#8	16.66	16.13	15.92	15.96	15.43	15.22
		RB1#14	16.63	16.09	15.94	15.93	15.39	15.24
		RB6#0	15.10	14.96	14.83	14.40	14.26	14.13
		RB6#9	15.10	14.99	14.85	14.40	14.29	14.15
		RB15#0	15.17	14.96	14.98	14.47	14.26	14.28

Bandwidth (MHz)	Modulation	RB size/ RB Offset	Conducted Average Output Power (dBm)			EIRP(dBm)		
			Low	Mid	High	Low	Mid	High
5.0	QPSK	RB1#0	16.97	16.88	16.83	16.27	16.18	16.13
		RB1#13	17.08	17.02	16.97	16.38	16.32	16.27
		RB1#24	16.96	16.90	16.83	16.26	16.20	16.13
		RB15#0	16.02	15.98	15.96	15.32	15.28	15.26
		RB15#10	16.08	15.96	15.91	15.38	15.26	15.21
		RB25#0	16.05	15.94	15.91	15.35	15.24	15.21
	16QAM	RB1#0	15.89	16.22	15.94	15.19	15.52	15.24
		RB1#13	15.99	16.37	16.08	15.29	15.67	15.38
		RB1#24	15.89	16.18	15.93	15.19	15.48	15.23
		RB15#0	15.15	14.99	15.01	14.45	14.29	14.31
		RB15#10	15.18	14.95	14.96	14.48	14.25	14.26
		RB25#0	15.13	14.99	14.97	14.43	14.29	14.27
10.0	QPSK	RB1#0	17.02	16.98	16.89	16.32	16.28	16.19
		RB1#25	17.12	17.08	17.01	16.42	16.38	16.31
		RB1#49	16.99	16.96	16.88	16.29	16.26	16.18
		RB25#0	16.04	16.03	16.07	15.34	15.33	15.37
		RB25#25	16.14	16.00	15.91	15.44	15.30	15.21
		RB50#0	16.11	16.02	16.00	15.41	15.32	15.30
	16QAM	RB1#0	16.67	16.14	15.96	15.97	15.44	15.26
		RB1#25	16.84	16.29	16.09	16.14	15.59	15.39
		RB1#49	16.65	16.13	15.92	15.95	15.43	15.22
		RB25#0	15.11	15.07	15.20	14.41	14.37	14.50
		RB25#25	15.23	15.07	15.07	14.53	14.37	14.37
		RB50#0	15.12	15.05	15.08	14.42	14.35	14.38

Bandwidth (MHz)	Modulation	RB size/ RB Offset	Conducted Average Output Power (dBm)			EIRP(dBm)		
			Low	Mid	High	Low	Mid	High
15.0	QPSK	RB1#0	16.88	16.89	16.84	16.18	16.19	16.14
		RB1#38	17.01	16.97	16.96	16.31	16.27	16.26
		RB1#74	16.97	16.90	16.84	16.27	16.20	16.14
		RB36#0	16.03	16.01	15.99	15.33	15.31	15.29
		RB36#39	16.09	15.96	15.94	15.39	15.26	15.24
		RB75#0	16.04	15.96	15.98	15.34	15.26	15.28
	16QAM	RB1#0	16.60	16.06	16.27	15.90	15.36	15.57
		RB1#38	16.72	16.16	16.38	16.02	15.46	15.68
		RB1#74	16.62	16.04	16.28	15.92	15.34	15.58
		RB36#0	15.02	15.04	15.00	14.32	14.34	14.30
		RB36#39	15.10	15.00	14.91	14.40	14.30	14.21
		RB75#0	15.06	14.99	14.94	14.36	14.29	14.24
20.0	QPSK	RB1#0	16.79	16.76	16.60	16.09	16.06	15.90
		RB1#50	17.15	17.13	16.97	16.45	16.43	16.27
		RB1#99	16.77	16.74	16.59	16.07	16.04	15.89
		RB50#0	15.96	16.02	16.07	15.26	15.32	15.37
		RB50#50	16.03	15.91	15.85	15.33	15.21	15.15
		RB100#0	16.02	15.99	16.02	15.32	15.29	15.32
	16QAM	RB1#0	16.09	16.04	16.25	15.39	15.34	15.55
		RB1#50	16.53	16.41	16.61	15.83	15.71	15.91
		RB1#99	16.13	15.98	16.22	15.43	15.28	15.52
		RB50#0	15.02	15.04	15.11	14.32	14.34	14.41
		RB50#50	15.09	14.97	14.89	14.39	14.27	14.19
		RB100#0	15.06	15.03	15.03	14.36	14.33	14.33

Note: EIRP(dBm) = Conducted Power(dBm) + Antenna Gain(dBi)

For LTE Band 66: Antenna Gain = -0.7dBi

Limit: EIRP ≤ 30dBm

Peak-to-average ratio (PAR)**20MHz bandwidth**

Modulation	Low channel (dB)	Middle channel (dB)	High channel (dB)	PAR Limit (dB)	Result
QPSK (1RB Size)	5.83	5.54	5.63	13	Pass
QPSK (100RB Size)	5.73	5.37	5.18	13	Pass
16QAM (1RB Size)	6.31	6.21	6.27	13	Pass
16QAM (100RB Size)	6.11	6.46	6.35	13	Pass

FCC §2.1049, §22.917, §22.905 & §24.238 & §27.53 - OCCUPIED BANDWIDTH

Applicable Standard

FCC 47 §2.1049, §22.917, §22.905, §24.238 and §27.53.

Test Procedure

The RF output of the transmitter was connected to the simulator and the spectrum analyzer through sufficient attenuation.

The resolution bandwidth of the spectrum analyzer was set at 1% to 5% of the anticipated emission bandwidth and the 26 dB & 99% bandwidth was recorded.

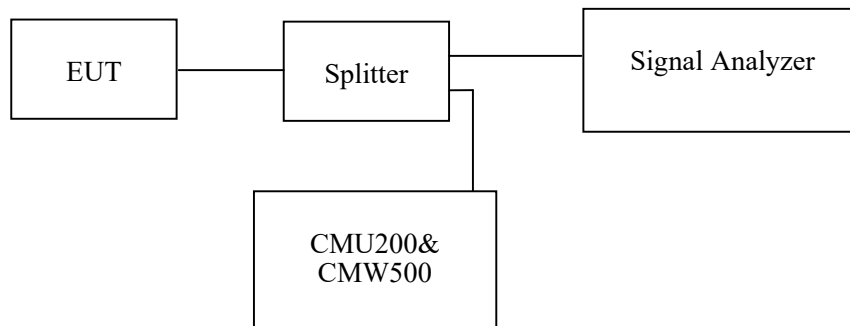

Test Data

Environmental Conditions

Temperature:	28 °C
Relative Humidity:	56 %
ATM Pressure:	101.0 kPa

The testing was performed by Ting Lü from 2021-09-05 to 2021-09-06.

EUT operation mode: Transmitting

Test Result: Pass

Please refer to the following tables and plots.

Cellular Band (Part 22H)

Mode	Channel	Frequency (MHz)	99% Occupied Bandwidth (kHz)	26 dB Emission Bandwidth (kHz)
GSM(GMSK)	128	824.2	246.79	319.23
	190	836.6	248.40	312.82
	251	848.8	248.40	319.23
EGPRS(8PSK)	128	824.2	248.40	317.63
	190	836.6	245.19	320.19
	251	848.8	246.79	322.44

	Frequency (MHz)	Occupied Bandwidth (MHz)	26dB Bandwidth (MHz)
RMC	826.4	4.17	4.75
	836.6	4.18	4.74
	846.6	4.18	4.75
HSDPA	826.4	4.20	4.89
	836.6	4.20	4.72
	846.6	4.20	4.87
HSUPA	826.4	4.20	4.74
	836.6	4.20	4.79
	846.6	4.20	4.82

PCS Band (Part 24E)

Mode	Channel	Frequency (MHz)	99% Occupied Bandwidth (kHz)	26 dB Emission Bandwidth (kHz)
GSM(GMSK)	512	1850.2	243.59	313.78
	661	1880.0	245.19	315.71
	810	1909.8	243.59	319.23
EGPRS(8PSK)	512	1850.2	250.00	321.15
	661	1880.0	246.79	320.83
	810	1909.8	250.00	332.05

	Frequency (MHz)	Occupied Bandwidth (MHz)	26dB Bandwidth (MHz)
RMC	1852.4	4.17	4.73
	1880.0	4.17	4.75
	1907.6	4.18	4.74
HSDPA	1852.4	4.18	4.74
	1880.0	4.20	4.74
	1907.6	4.20	4.73
HSUPA	1852.4	4.18	4.72
	1880.0	4.16	4.75
	1907.6	4.18	4.74

AWS Band (Part 27)

	Frequency (MHz)	Occupied Bandwidth (MHz)	26dB Bandwidth (MHz)
RMC	1712.4	4.18	4.71
	1732.6	4.17	4.74
	1752.6	4.18	4.73
HSDPA	1712.4	4.20	4.71
	1732.6	4.18	4.73
	1752.6	4.20	4.74
HSUPA	1712.4	4.20	4.73
	1732.6	4.20	4.71
	1752.6	4.20	4.73

Cellular Band (Part 22H)

26 dB Emissions & 99% Occupied Bandwidth for GSM (GMSK) Mode, Low channel

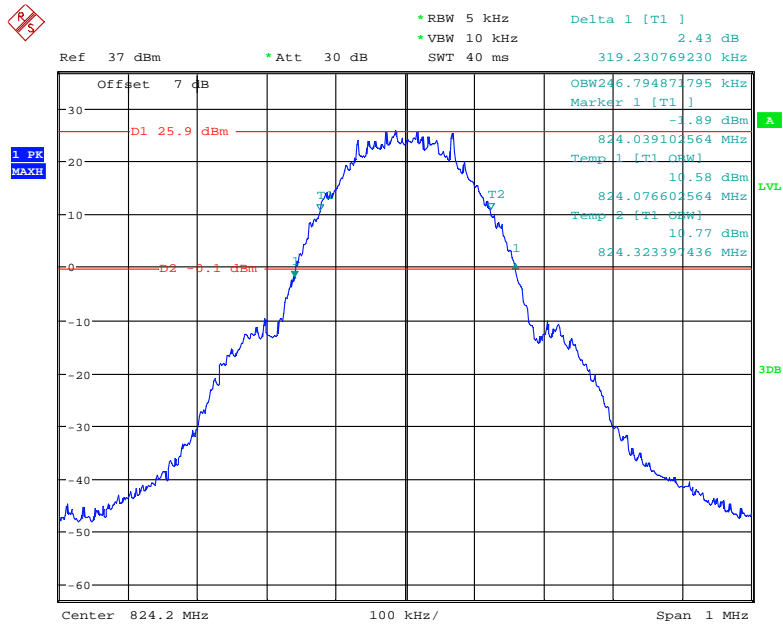

Date: 6.SEP.2021 15:39:59

26 dB Emissions & 99% Occupied Bandwidth for GSM (GMSK) Mode, Middle channel

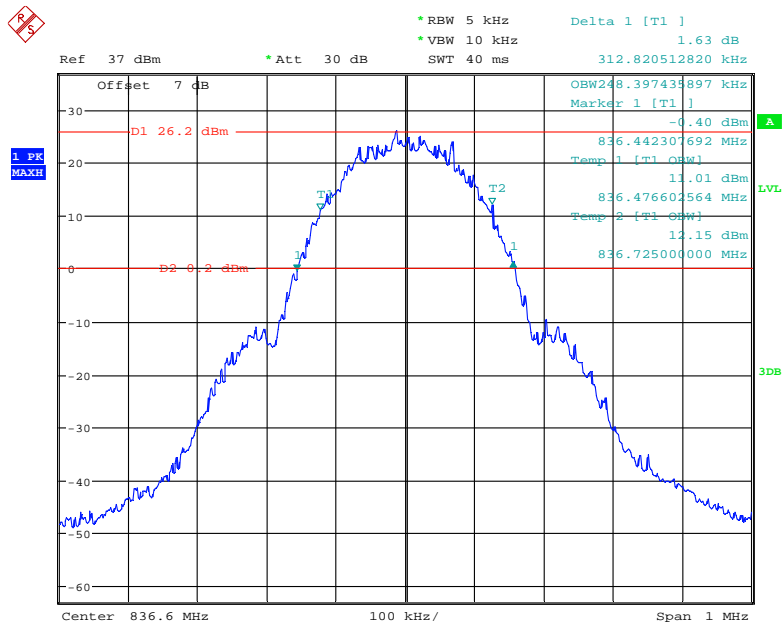

Date: 6.SEP.2021 15:42:20

26 dB Emissions & 99% Occupied Bandwidth for GSM (GMSK) Mode, High channel

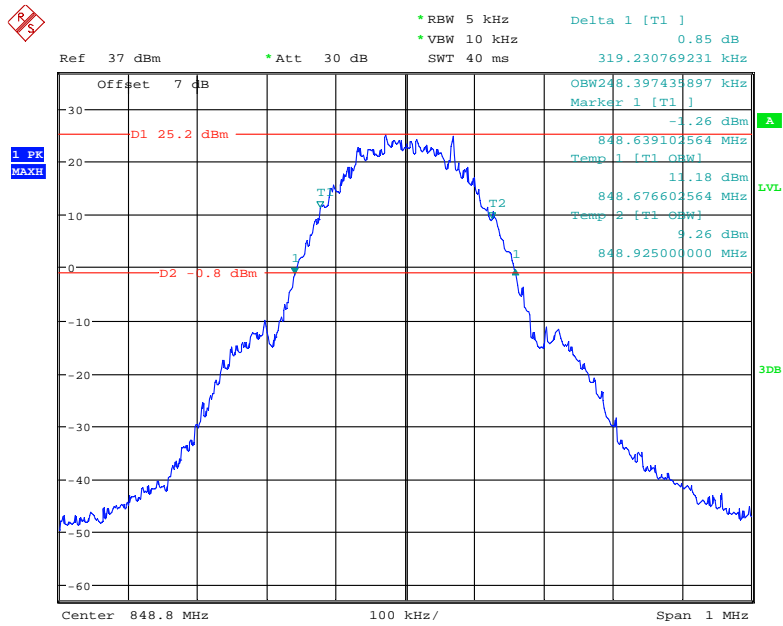

Date: 6.SEP.2021 15:43:44

26 dB Emissions & 99% Occupied Bandwidth for EGPRS (8PSK) Mode, Low channel

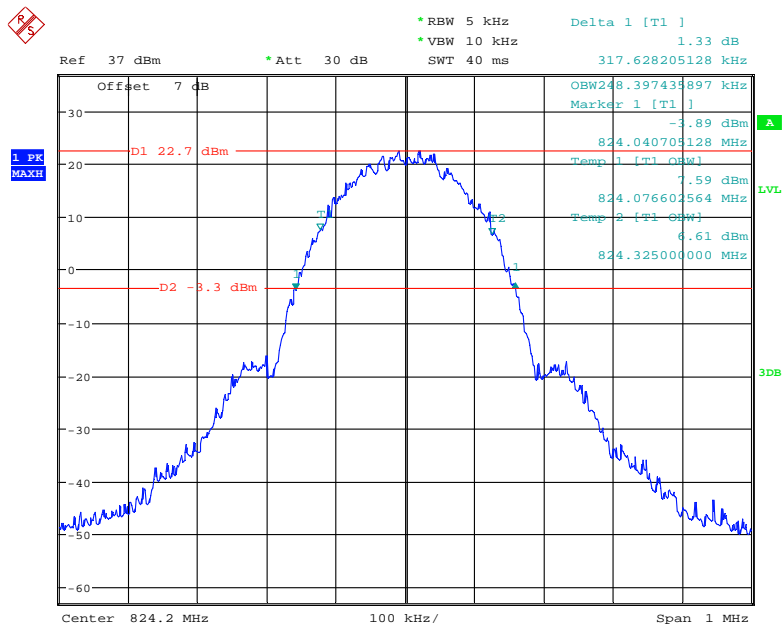

Date: 6.SEP.2021 16:01:52

26 dB Emissions & 99% Occupied Bandwidth for EGPRS (8PSK) Mode, Middle channel

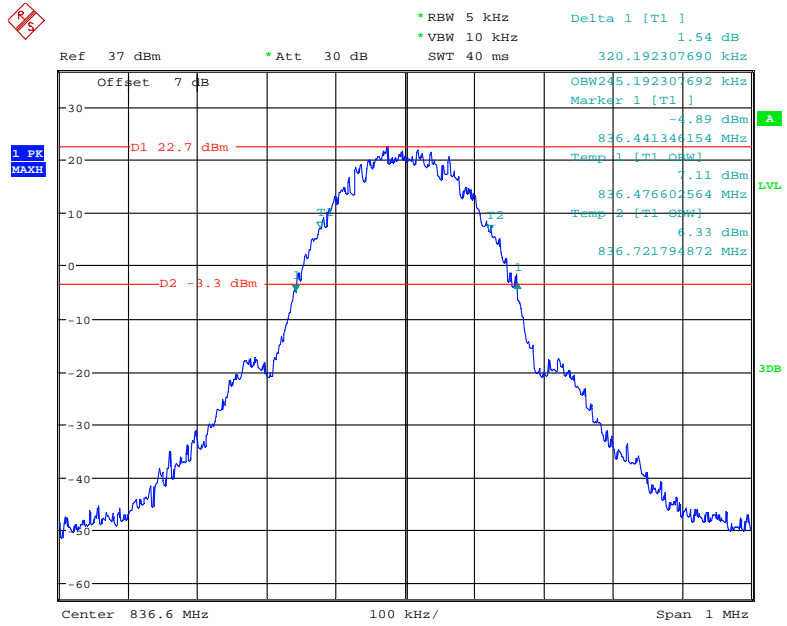

Date: 6.SEP.2021 16:02:54

26 dB Emissions & 99% Occupied Bandwidth for EGPRS (8PSK) Mode, High channel

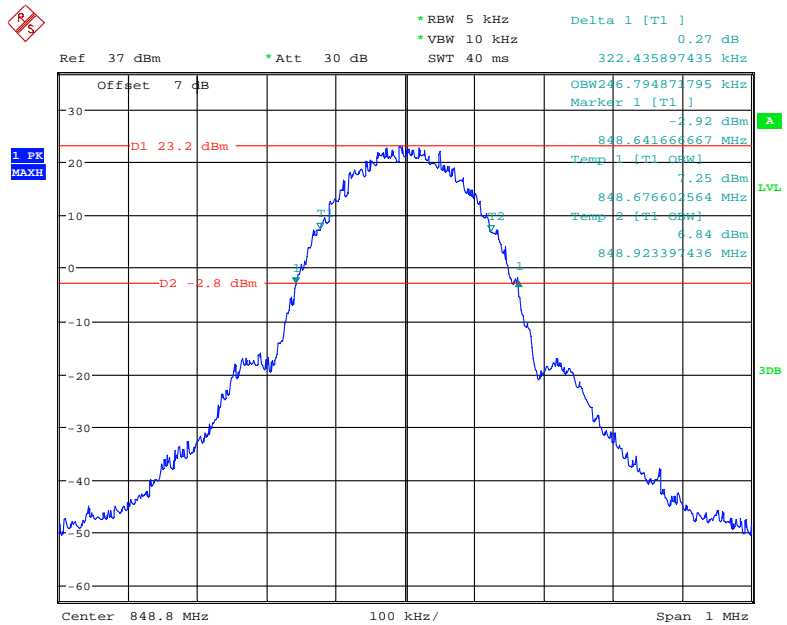

Date: 6.SEP.2021 16:04:25

26 dB Emissions & 99% Occupied Bandwidth for RMC (BPSK) Mode, Low channel

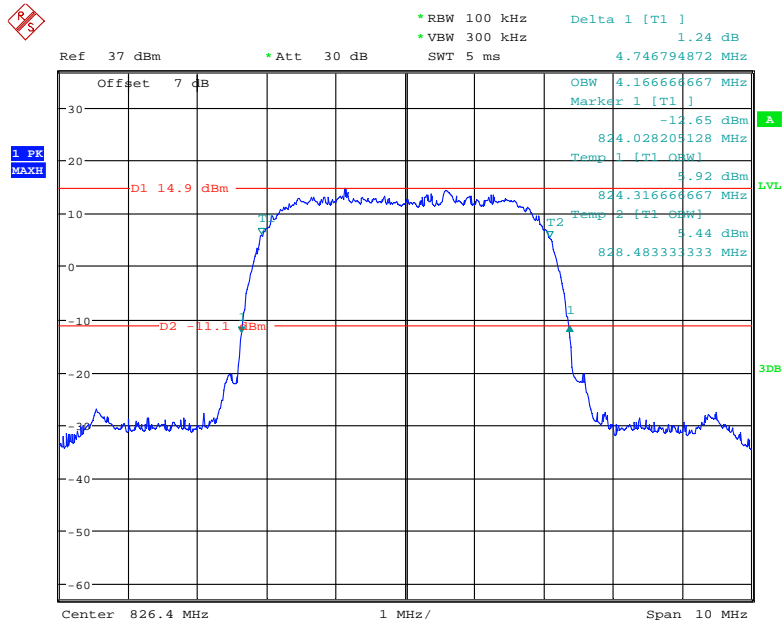

Date: 6.SEP.2021 00:03:43

26 dB Emissions & 99% Occupied Bandwidth for RMC (BPSK) Mode, Middle channel

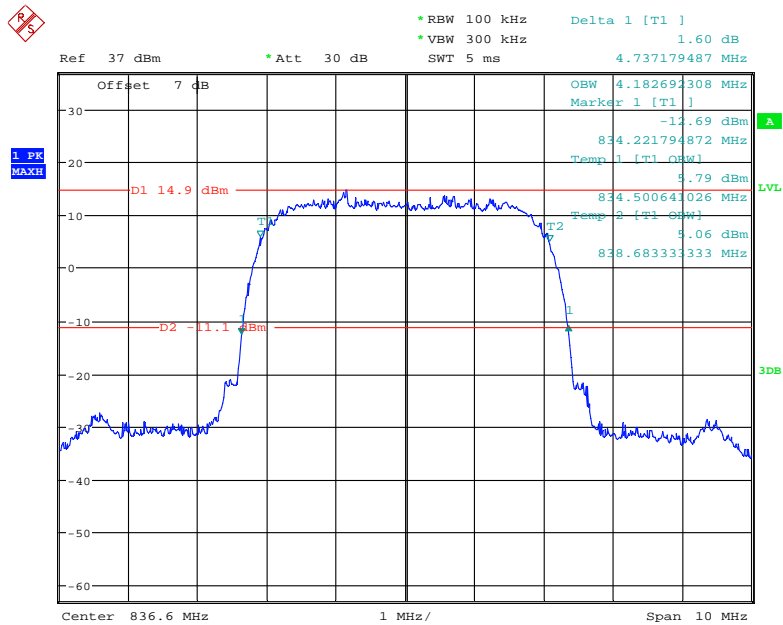

Date: 6.SEP.2021 00:01:25

26 dB Emissions & 99% Occupied Bandwidth for RMC (BPSK) Mode, High channel

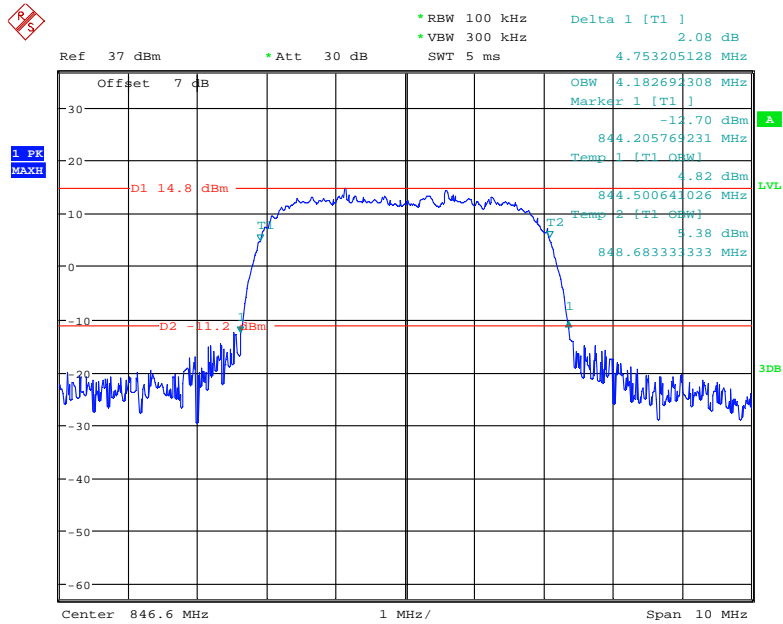

Date: 5.SEP.2021 23:58:52

26 dB Emissions & 99% Occupied Bandwidth for HSUPA (BPSK) Mode, Low channel

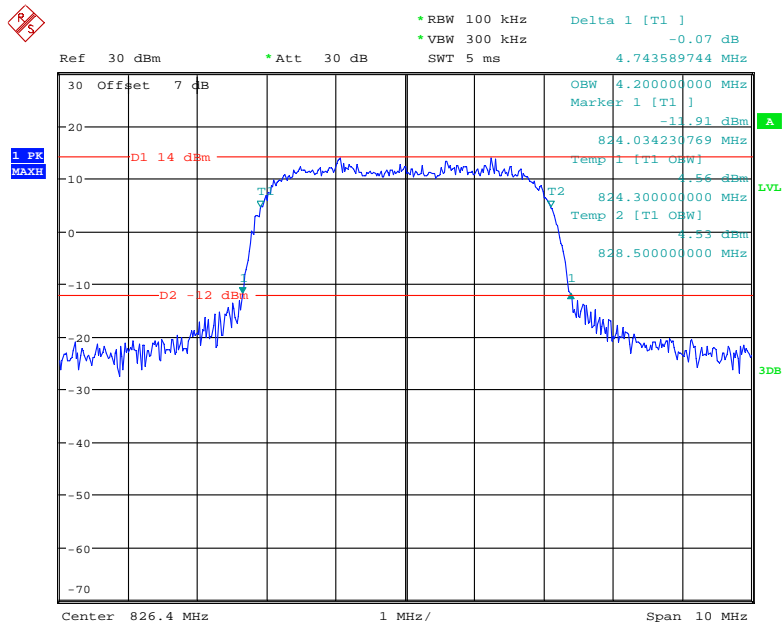

Date: 6.SEP.2021 15:28:08

26 dB Emissions & 99% Occupied Bandwidth for HSUPA (BPSK) Mode, Middle channel

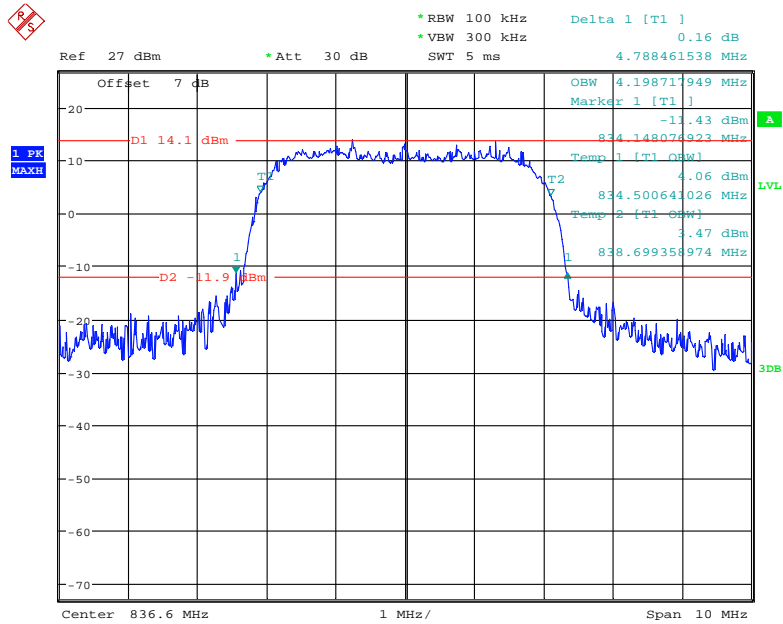

Date: 5.SEP.2021 23:18:52

26 dB Emissions & 99% Occupied Bandwidth for HSUPA (BPSK) Mode, High channel

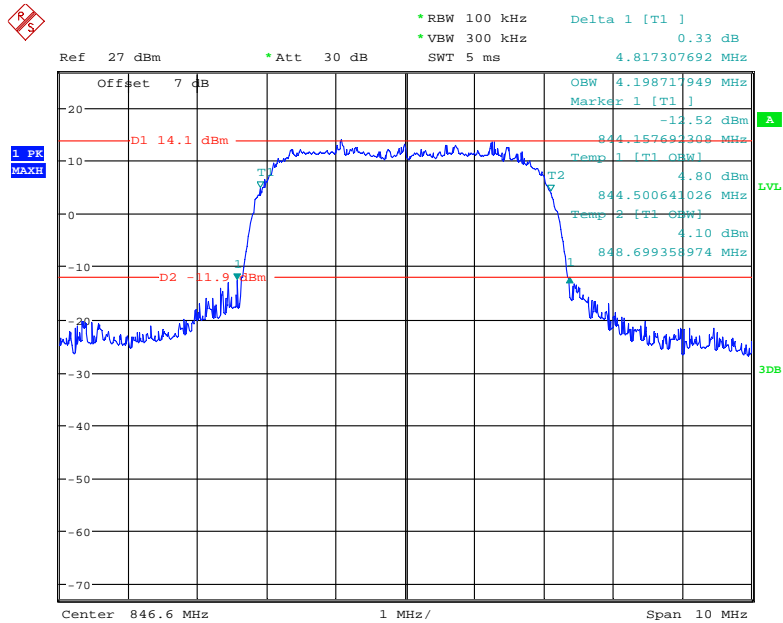

Date: 5.SEP.2021 23:16:42

26 dB Emissions & 99% Occupied Bandwidth for HSDPA (16QAM) Mode, Low channel

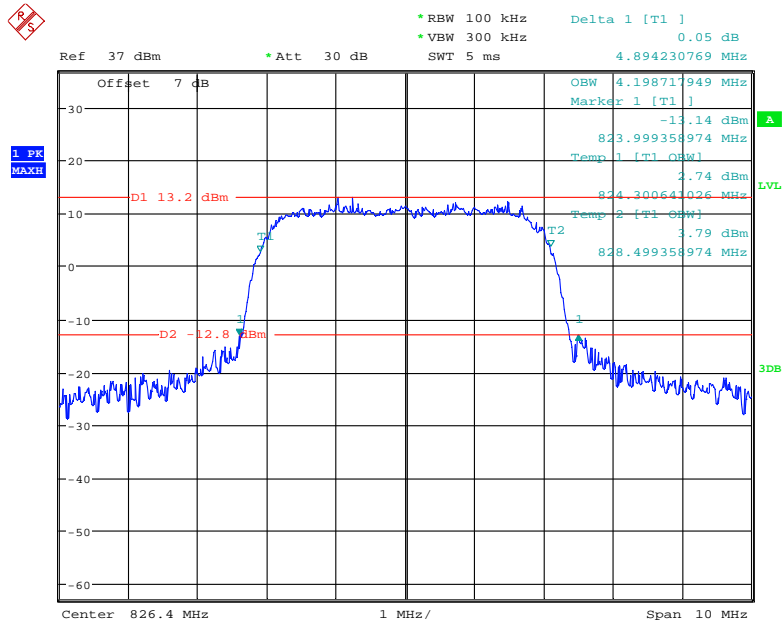

Date: 5.SEP.2021 23:51:57

26 dB Emissions & 99% Occupied Bandwidth for HSDPA (16QAM) Mode, Middle channel

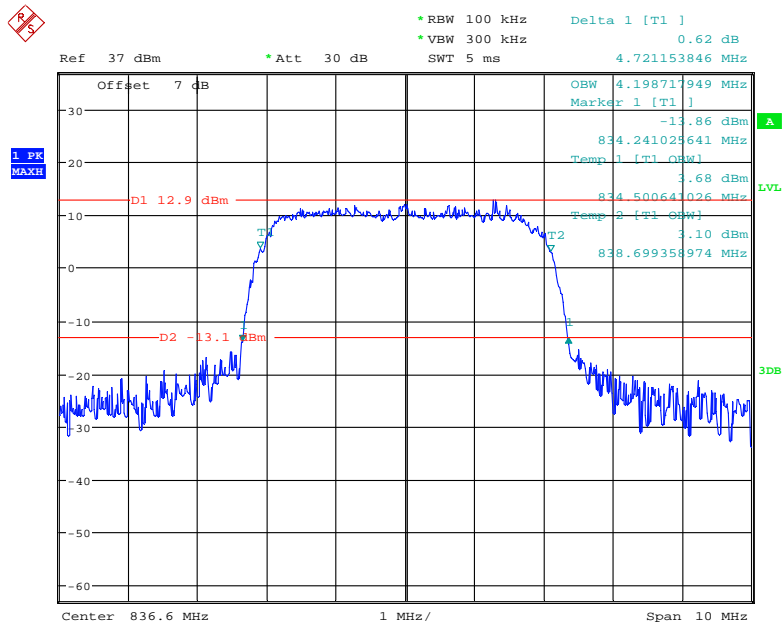

Date: 5.SEP.2021 23:53:45

26 dB Emissions & 99% Occupied Bandwidth for HSDPA (16QAM) Mode, High channel

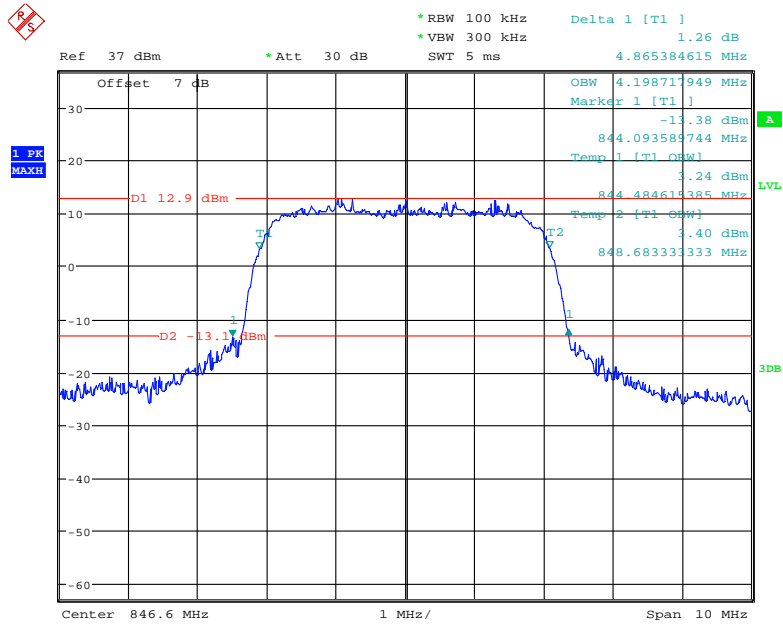

Date: 5.SEP.2021 23:55:52

PCS Band (Part 24E)

26 dB Emissions & 99% Occupied Bandwidth for GSM (GMSK) Mode, Low channel

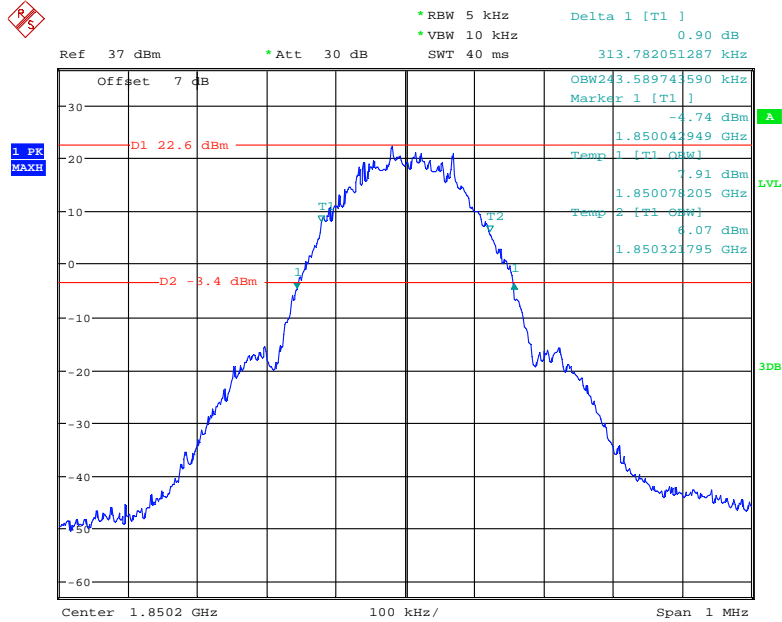

Date: 6.SEP.2021 16:17:00

26 dB Emissions & 99% Occupied Bandwidth for GSM (GMSK) Mode, Middle channel

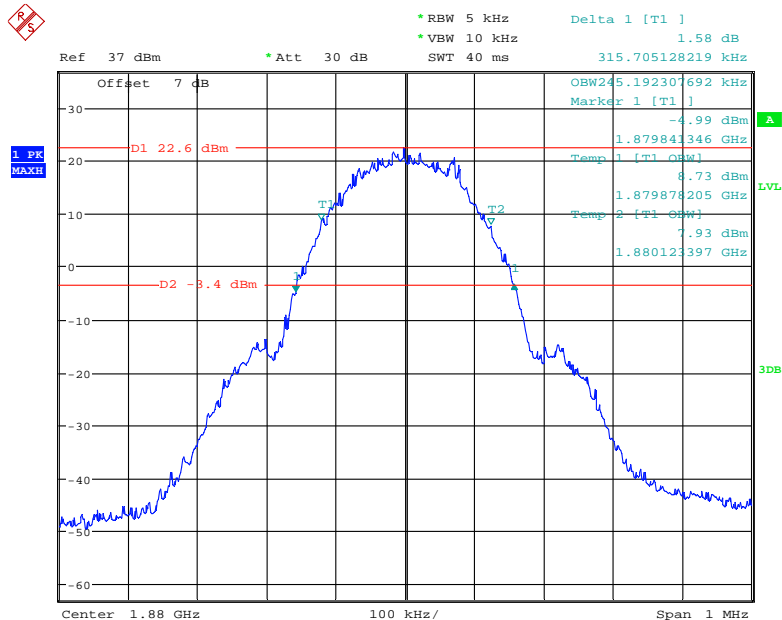

Date: 6.SEP.2021 16:15:03

26 dB Emissions & 99% Occupied Bandwidth for GSM (GMSK) Mode, High channel

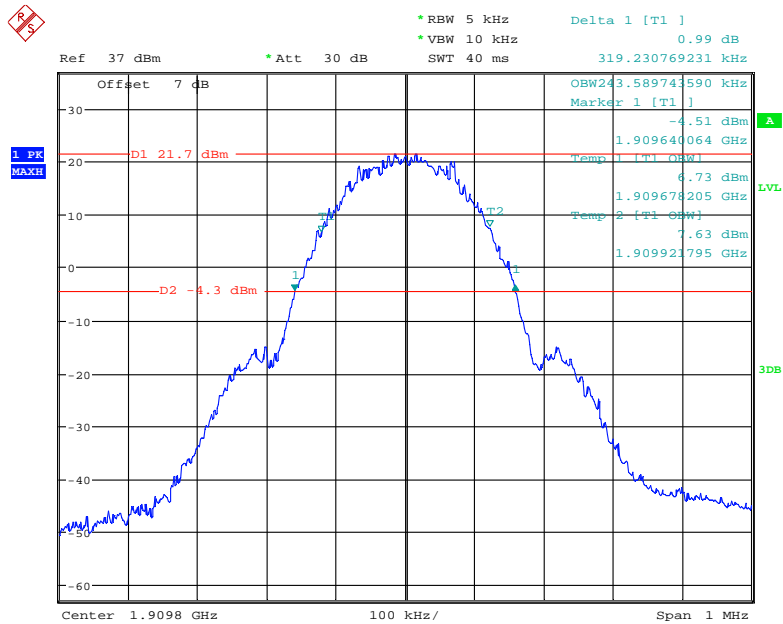

Date: 6.SEP.2021 16:19:29

26 dB Emissions & 99% Occupied Bandwidth for EGPRS (8PSK) Mode, Low channel

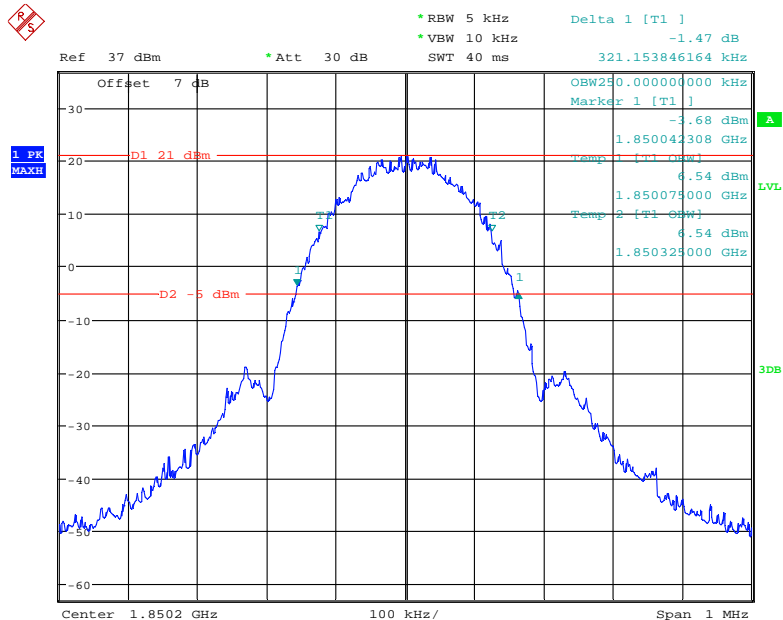

Date: 6.SEP.2021 16:27:39

26 dB Emissions & 99% Occupied Bandwidth for EGPRS (8PSK) Mode, Middle channel

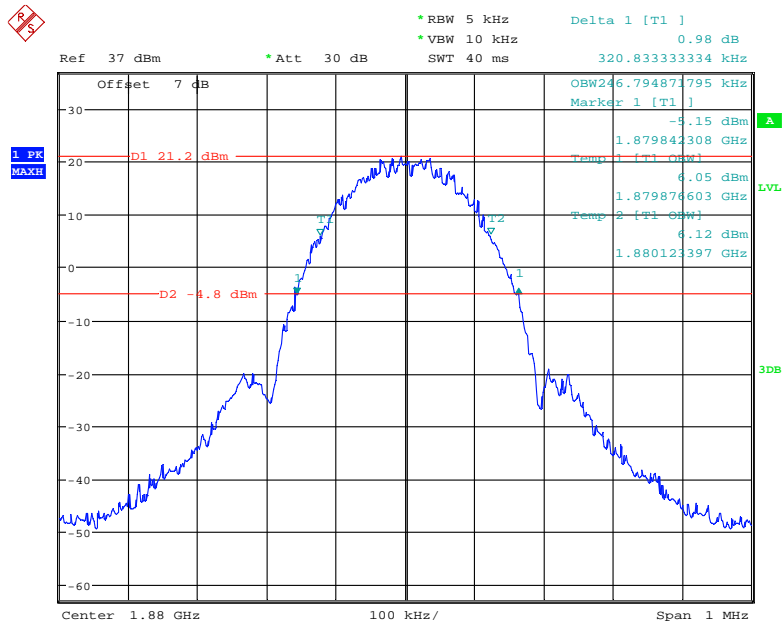

Date: 6.SEP.2021 16:29:59

26 dB Emissions & 99% Occupied Bandwidth for EGPRS (8PSK) Mode, High channel

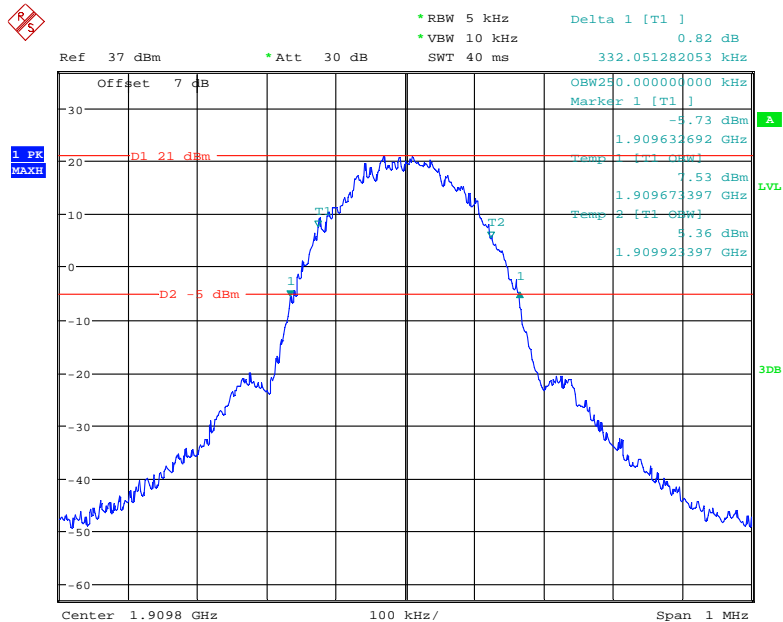

Date: 6.SEP.2021 16:32:08

26 dB Emissions & 99% Occupied Bandwidth for RMC (BPSK) Mode, Low channel

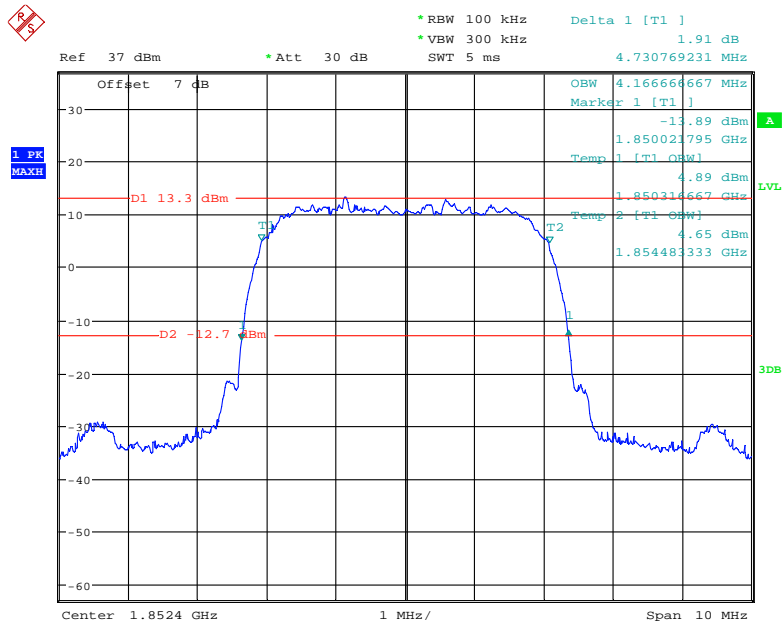

Date: 6.SEP.2021 00:12:50

26 dB Emissions & 99% Occupied Bandwidth for RMC (BPSK) Mode, Middle channel

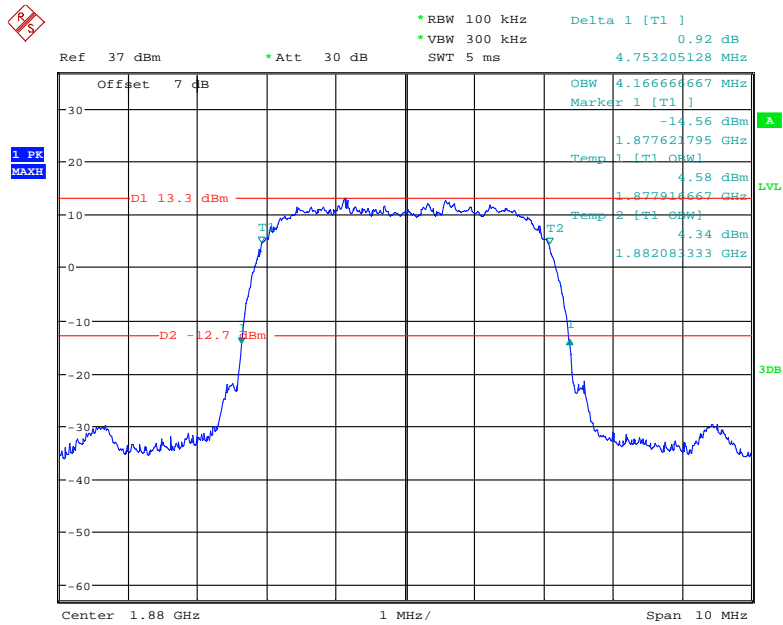

Date: 6.SEP.2021 00:14:07

26 dB Emissions & 99% Occupied Bandwidth for RMC (BPSK) Mode, High channel

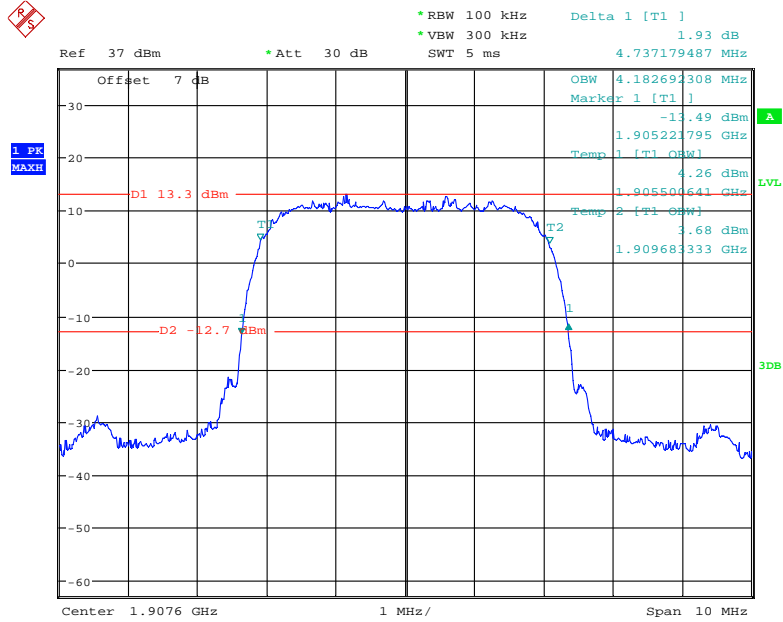

Date: 6.SEP.2021 00:16:18

26 dB Emissions & 99% Occupied Bandwidth for HSUPA (BPSK) Mode, Low channel

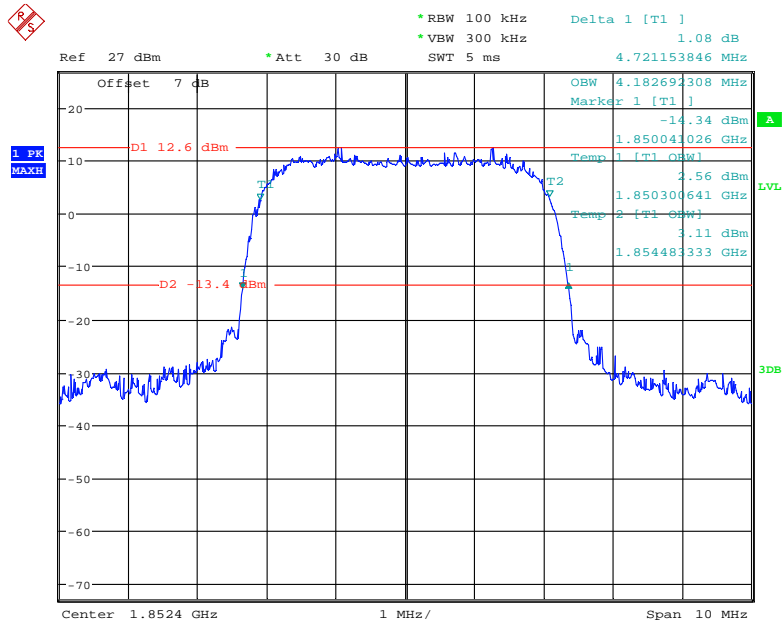

Date: 5.SEP.2021 23:28:53

26 dB Emissions & 99% Occupied Bandwidth for HSUPA (BPSK) Mode, Middle channel

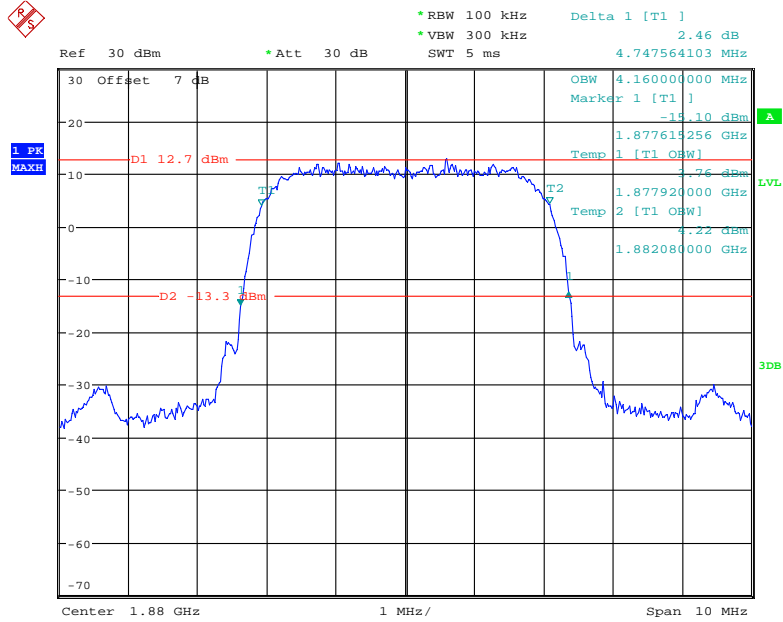

Date: 6.SEP.2021 15:03:46

26 dB Emissions & 99% Occupied Bandwidth for HSUPA (BPSK) Mode, High channel

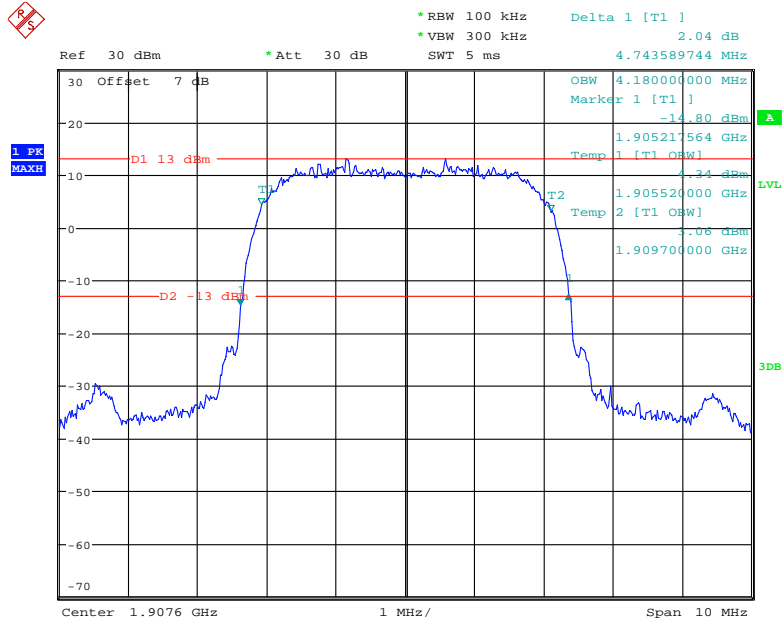

Date: 6.SEP.2021 15:02:41

26 dB Emissions & 99% Occupied Bandwidth for HSDPA (16QAM) Mode, Low channel

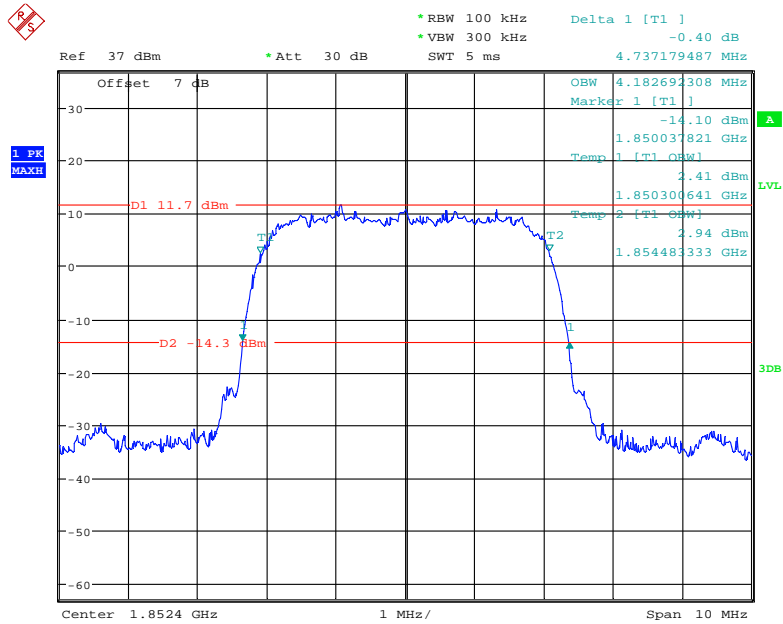

Date: 5.SEP.2021 23:46:15

26 dB Emissions & 99% Occupied Bandwidth for HSDPA (16QAM) Mode, Middle channel

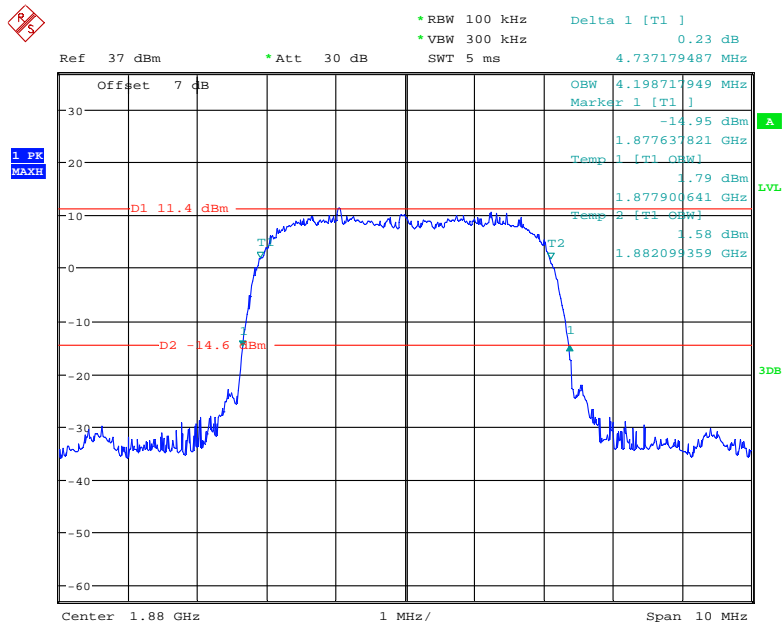

Date: 5.SEP.2021 23:44:25

26 dB Emissions & 99% Occupied Bandwidth for HSDPA (16QAM) Mode, High channel

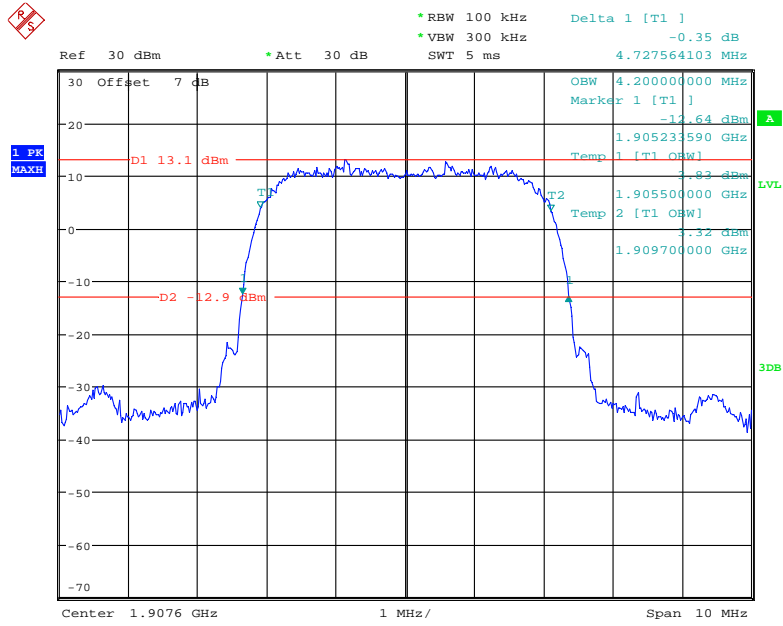

Date: 6.SEP.2021 15:01:37

AWS Band (Part 27)

26 dB Emissions & 99% Occupied Bandwidth for RMC (BPSK) Mode, Low channel

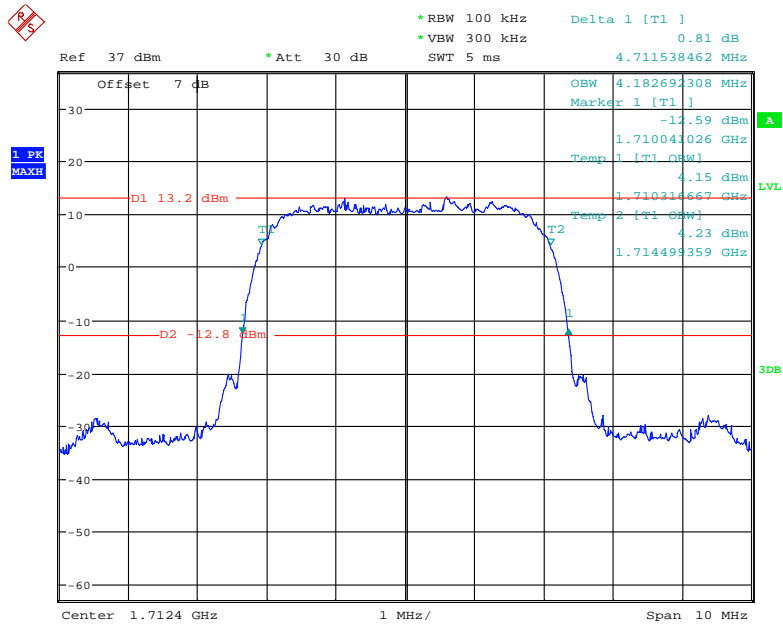

Date: 6.SEP.2021 00:06:18

26 dB Emissions & 99% Occupied Bandwidth for RMC (BPSK) Mode, Middle channel

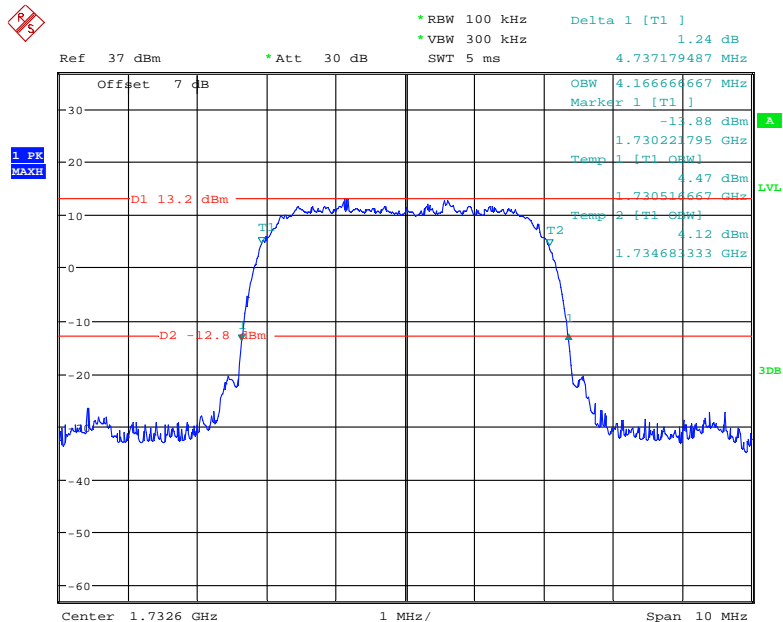

Date: 6.SEP.2021 00:07:41

26 dB Emissions & 99% Occupied Bandwidth for RMC (BPSK) Mode, High channel

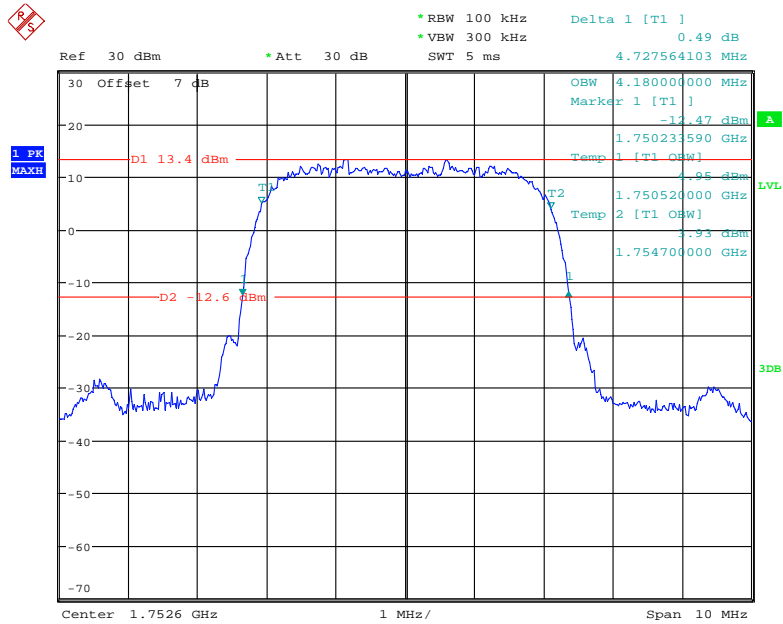

Date: 6.SEP.2021 14:56:18

26 dB Emissions & 99% Occupied Bandwidth for HSUPA (BPSK) Mode, Low channel

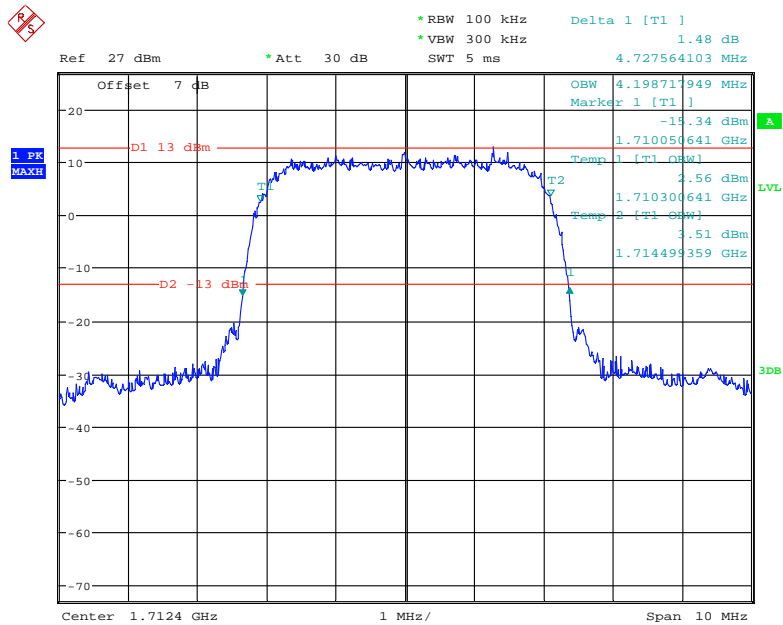

Date: 5.SEP.2021 23:23:14

26 dB Emissions & 99% Occupied Bandwidth for HSUPA (BPSK) Mode, Middle channel

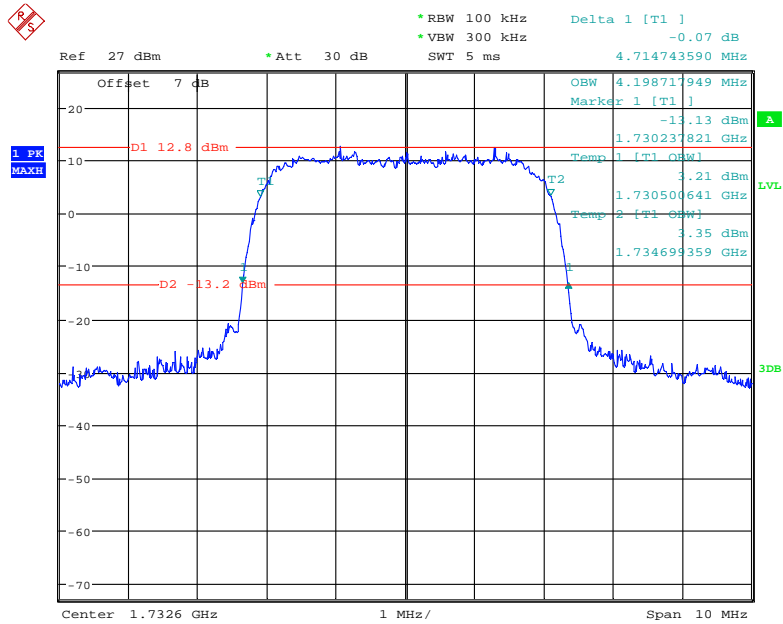

Date: 5.SEP.2021 23:25:07

26 dB Emissions & 99% Occupied Bandwidth for HSUPA (BPSK) Mode, High channel

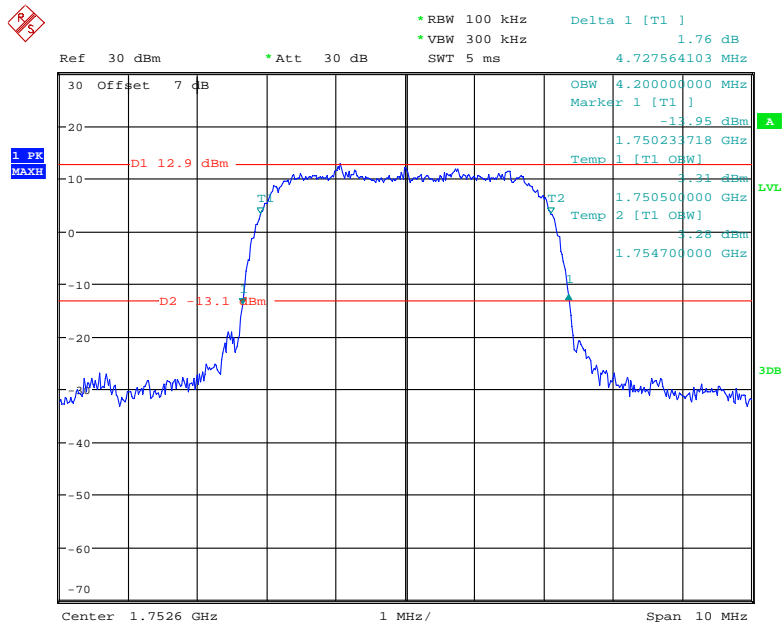

Date: 6.SEP.2021 15:24:06

26 dB Emissions & 99% Occupied Bandwidth for HSDPA (16QAM) Mode, Low channel

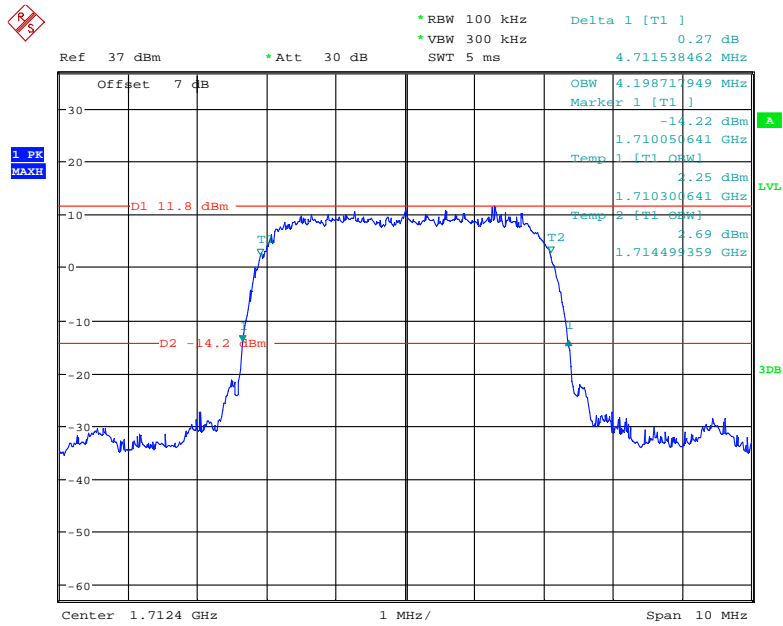

Date: 5.SEP.2021 23:50:33

26 dB Emissions & 99% Occupied Bandwidth for HSDPA (16QAM) Mode, Middle channel

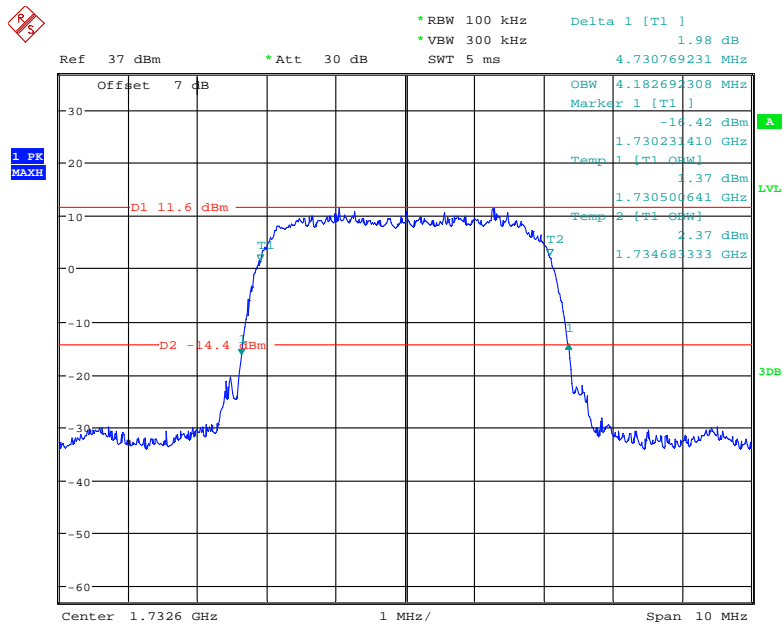

Date: 5.SEP.2021 23:48:48

26 dB Emissions & 99% Occupied Bandwidth for HSDPA (16QAM) Mode, High channel

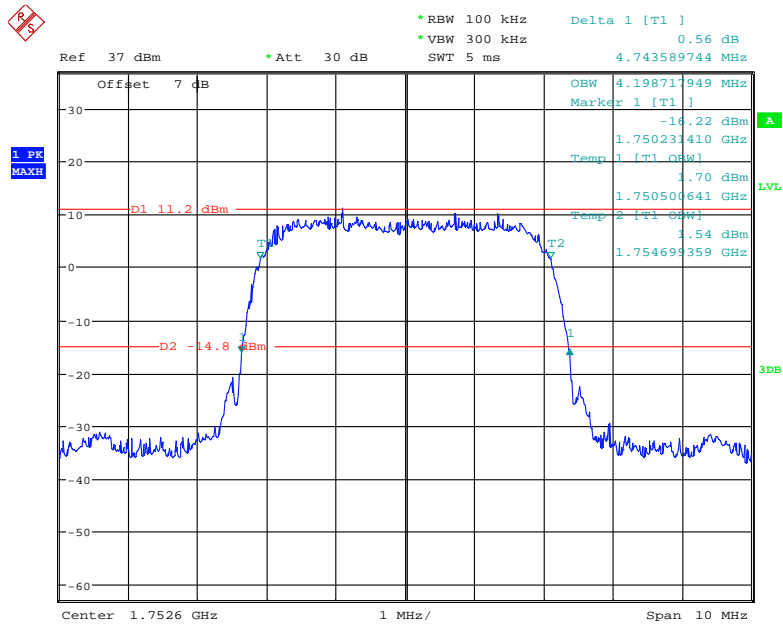

Date: 5.SEP.2021 23:47:31

LTE Band 2:

Bandwidth	Modulation	Low channel		Middle channel		High channel	
		OBW (MHz)	26dB EBW (MHz)	OBW (MHz)	26dB EBW (MHz)	OBW (MHz)	26dB EBW (MHz)
1.4 MHz	QPSK	1.110	1.302	1.098	1.308	1.104	1.326
	16QAM	1.098	1.302	1.110	1.314	1.098	1.290
3 MHz	QPSK	2.688	2.880	2.700	2.880	2.688	2.880
	16QAM	2.688	2.892	2.688	2.880	2.688	2.880
5 MHz	QPSK	4.520	4.960	4.520	4.940	4.500	4.920
	16QAM	4.500	4.920	4.520	4.960	4.500	4.940
10 MHz	QPSK	8.960	9.680	8.960	9.560	8.960	9.560
	16QAM	8.960	9.520	8.960	9.520	8.960	9.560
15 MHz	QPSK	13.560	14.760	13.500	14.820	13.500	14.760
	16QAM	13.500	14.820	13.560	14.700	13.560	14.820
20 MHz	QPSK	18.000	19.200	18.000	19.280	17.920	19.360
	16QAM	17.920	19.280	18.000	19.520	18.000	19.440

LTE Band 4:

Bandwidth	Modulation	Low channel		Middle channel		High channel	
		OBW (MHz)	26dB EBW (MHz)	OBW (MHz)	26dB EBW (MHz)	OBW (MHz)	26dB EBW (MHz)
1.4 MHz	QPSK	1.092	1.302	1.098	1.308	1.104	1.296
	16QAM	1.098	1.326	1.092	1.290	1.098	1.302
3 MHz	QPSK	2.688	2.880	2.700	2.880	2.688	2.892
	16QAM	2.688	2.880	2.688	2.880	2.688	2.892
5 MHz	QPSK	4.540	4.940	4.520	4.940	4.500	4.900
	16QAM	4.500	4.920	4.520	4.940	4.520	4.940
10 MHz	QPSK	9.000	9.560	8.960	9.600	8.960	9.640
	16QAM	8.960	9.600	8.960	9.720	8.960	9.640
15 MHz	QPSK	13.560	14.760	13.500	14.760	13.500	14.760
	16QAM	13.560	14.700	13.560	14.820	13.500	14.640
20 MHz	QPSK	18.000	19.280	18.000	19.200	18.000	19.440
	16QAM	18.000	19.280	18.000	19.280	18.000	19.360

LTE Band 5:

Bandwidth	Modulation	Low channel		Middle channel		High channel	
		OBW (MHz)	26dB EBW (MHz)	OBW (MHz)	26dB EBW (MHz)	OBW (MHz)	26dB EBW (MHz)
1.4 MHz	QPSK	1.092	1.308	1.104	1.314	1.110	1.296
	16QAM	1.098	1.320	1.098	1.290	1.098	1.296
3 MHz	QPSK	2.688	2.892	2.688	2.880	2.688	2.892
	16QAM	2.688	2.892	2.688	2.880	2.688	2.868
5 MHz	QPSK	4.520	4.960	4.500	4.920	4.500	4.900
	16QAM	4.500	4.920	4.520	4.880	4.500	4.960
10 MHz	QPSK	8.960	9.600	8.960	9.520	8.960	9.560
	16QAM	8.960	9.520	8.960	9.600	9.000	9.640

LTE Band 7:

Bandwidth	Modulation	Low channel		Middle channel		High channel	
		OBW (MHz)	26dB EBW (MHz)	OBW (MHz)	26dB EBW (MHz)	OBW (MHz)	26dB EBW (MHz)
5 MHz	QPSK	4.520	4.920	4.520	4.920	4.500	4.900
	16QAM	4.500	4.940	4.500	4.940	4.500	4.920
10 MHz	QPSK	9.000	9.640	8.960	9.560	8.960	9.640
	16QAM	8.960	9.520	8.960	9.640	8.960	9.560
15 MHz	QPSK	13.560	14.700	13.500	14.700	13.500	14.760
	16QAM	13.560	14.760	13.560	14.700	13.500	14.700
20 MHz	QPSK	17.920	19.360	18.000	19.360	18.000	19.520
	16QAM	17.920	19.360	18.000	19.280	18.000	19.280

LTE Band 17

Bandwidth	Modulation	Low channel		Middle channel		High channel	
		OBW (MHz)	26dB EBW (MHz)	OBW (MHz)	26dB EBW (MHz)	OBW (MHz)	26dB EBW (MHz)
5 MHz	QPSK	4.560	5.220	4.540	5.180	4.520	5.140
	16QAM	4.540	5.180	4.540	5.200	4.540	5.220
10 MHz	QPSK	8.960	9.920	8.960	9.760	8.960	9.840
	16QAM	8.960	9.760	8.960	9.840	8.960	9.880

LTE Band 38

Bandwidth	Modulation	Low channel		Middle channel		High channel	
		OBW (MHz)	26dB EBW (MHz)	OBW (MHz)	26dB EBW (MHz)	OBW (MHz)	26dB EBW (MHz)
5 MHz	QPSK	4.500	4.920	4.500	4.920	4.520	5.128
	16QAM	4.500	4.980	4.500	5.120	4.500	4.920
10 MHz	QPSK	8.960	9.600	9.000	9.600	8.960	9.520
	16QAM	9.000	9.795	8.960	9.480	8.960	9.960
15 MHz	QPSK	13.500	15.120	13.440	14.820	13.500	15.300
	16QAM	13.620	16.537	13.560	15.780	13.560	16.800
20 MHz	QPSK	18.000	19.360	18.000	19.280	18.000	19.440
	16QAM	17.920	19.360	18.000	19.520	17.920	19.280

LTE Band 41

Bandwidth	Modulation	Low channel		Middle channel		High channel	
		OBW (MHz)	26dB EBW (MHz)	OBW (MHz)	26dB EBW (MHz)	OBW (MHz)	26dB EBW (MHz)
5 MHz	QPSK	4.500	4.960	4.500	4.900	4.520	5.040
	16QAM	4.520	4.958	4.500	5.140	4.500	4.960
10 MHz	QPSK	9.000	9.640	8.960	9.680	8.960	9.680
	16QAM	9.000	9.560	8.960	9.480	8.960	10.040
15 MHz	QPSK	13.620	15.962	13.560	15.577	13.500	15.095
	16QAM	13.500	15.764	13.560	15.300	13.620	16.440
20 MHz	QPSK	17.920	19.440	18.000	19.280	18.000	20.080
	16QAM	18.000	19.600	18.000	19.936	18.000	19.360

LTE Band 66:

Bandwidth	Modulation	Low channel		Middle channel		High channel	
		OBW (MHz)	26dB EBW (MHz)	OBW (MHz)	26dB EBW (MHz)	OBW (MHz)	26dB EBW (MHz)
1.4 MHz	QPSK	1.110	1.320	1.104	1.296	1.098	1.302
	16QAM	1.092	1.290	1.098	1.302	1.104	1.326
3 MHz	QPSK	2.700	2.880	2.688	2.880	2.688	2.880
	16QAM	2.688	2.892	2.688	2.880	2.688	2.880
5 MHz	QPSK	4.520	5.120	4.520	5.180	4.520	5.120
	16QAM	4.520	5.100	4.540	5.200	4.540	5.200
10 MHz	QPSK	9.000	10.000	8.960	9.800	8.960	9.840
	16QAM	9.000	9.760	8.960	9.920	8.960	9.840
15 MHz	QPSK	13.560	14.940	13.500	15.060	13.560	15.300
	16QAM	13.500	15.120	13.500	15.060	13.560	15.000
20 MHz	QPSK	17.920	19.600	18.000	19.600	18.080	20.000
	16QAM	18.000	19.440	18.000	19.760	18.000	19.600

The test plots of LTE band please refer to the Appendix A.

FCC §2.1051, §22.917(a) & §24.238(a); §27.53 - SPURIOUS EMISSIONS AT ANTENNA TERMINALS

Applicable Standard

FCC §2.1051, §22.917(a) and §24.238(a) and §27.53.

The spectrum was to be investigated to the tenth harmonics of the highest fundamental frequency as specified in § 2.1051.

Test Procedure

The RF output of the transceiver was connected to a spectrum analyzer and simulator through appropriate attenuation. The resolution bandwidth of the spectrum analyzer was set at 1MHz. Sufficient scans were taken to show any out of band emissions up to 10th harmonic.

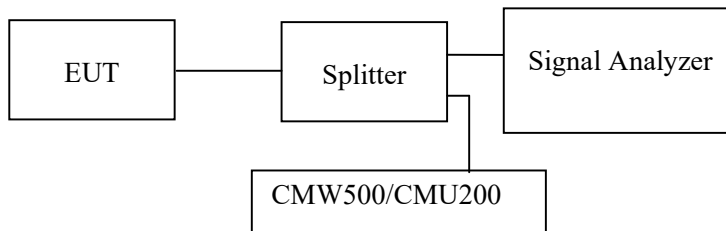

Test Data

Environmental Conditions

Temperature:	28 °C
Relative Humidity:	56 %
ATM Pressure:	101.0 kPa

The testing was performed by Ting Lü from 2021-09-05 to 2021-09-06.

EUT operation mode: Transmitting

Test result: Pass

Please refer to the following plots.

**Cellular Band (Part 22H)
Low Channel:**

30 MHz – 1 GHz (GSM Mode)

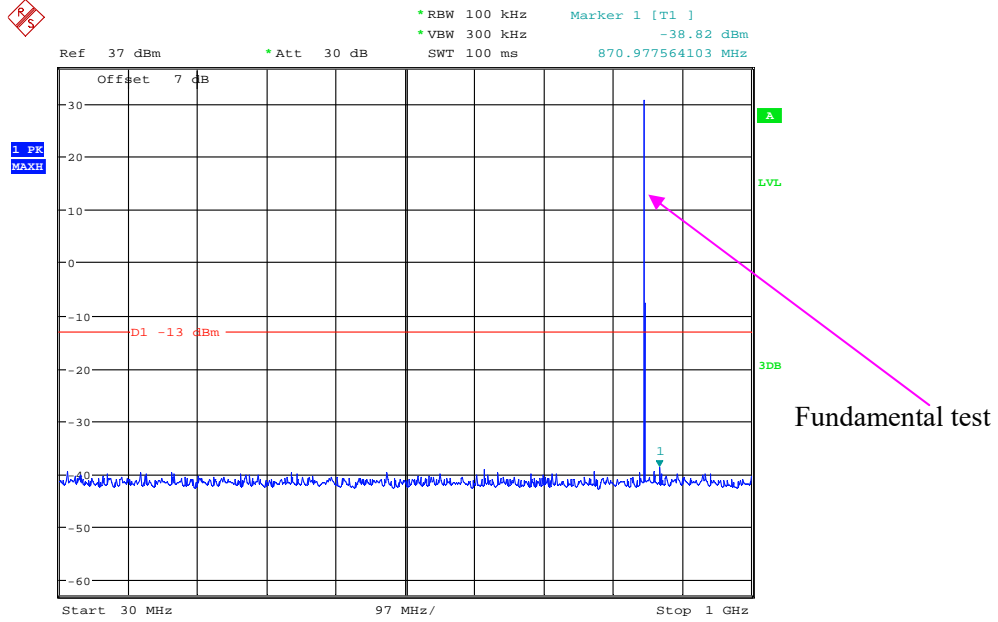

Date: 6.SEP.2021 15:50:24

1 GHz – 10 GHz (GSM Mode)

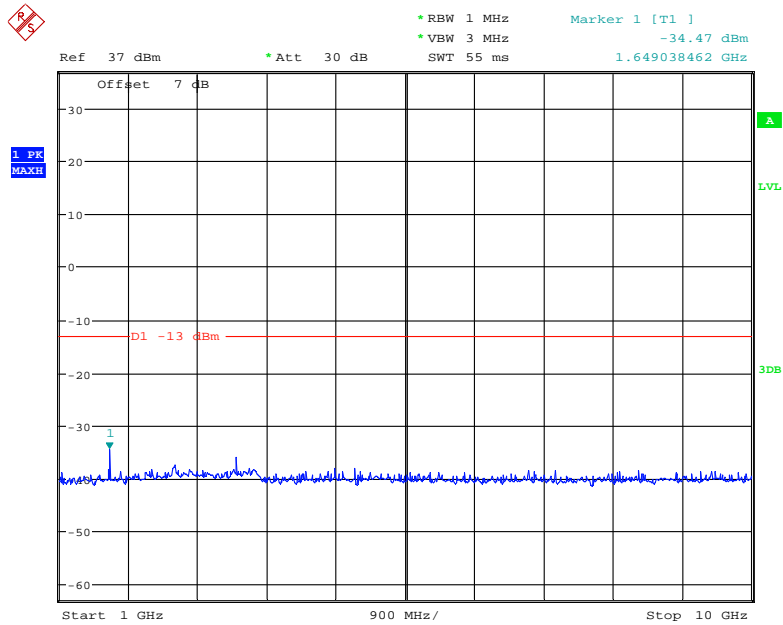

Date: 6.SEP.2021 15:51:51

30 MHz – 1 GHz (WCDMA Mode)

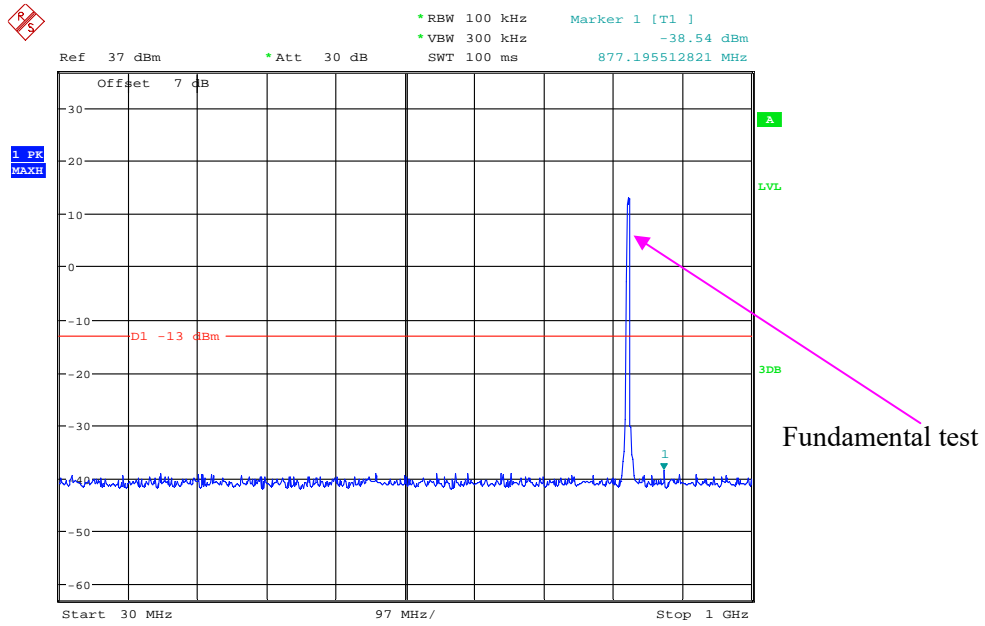

Date: 6.SEP.2021 00:26:38

1 GHz – 10 GHz (WCDMA Mode)

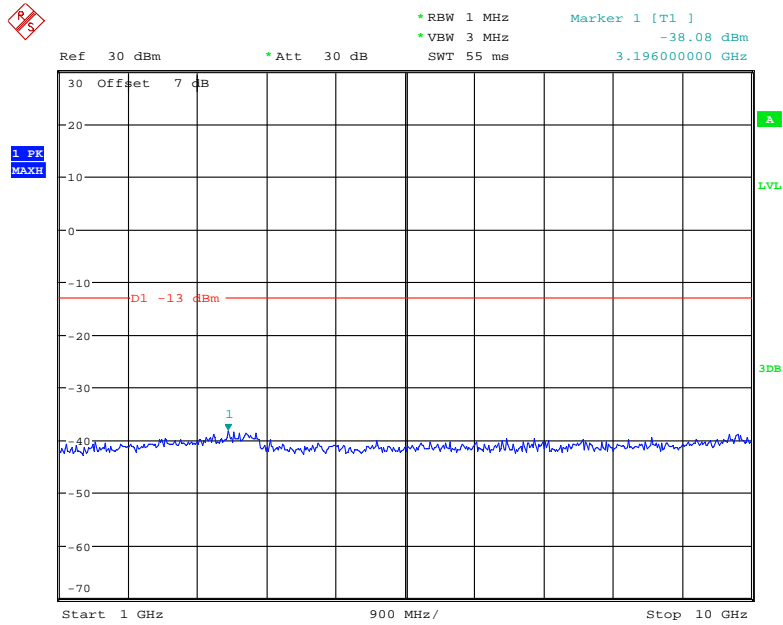

Date: 6.SEP.2021 14:45:22

Middle Channel:

30 MHz – 1 GHz (GSM Mode)

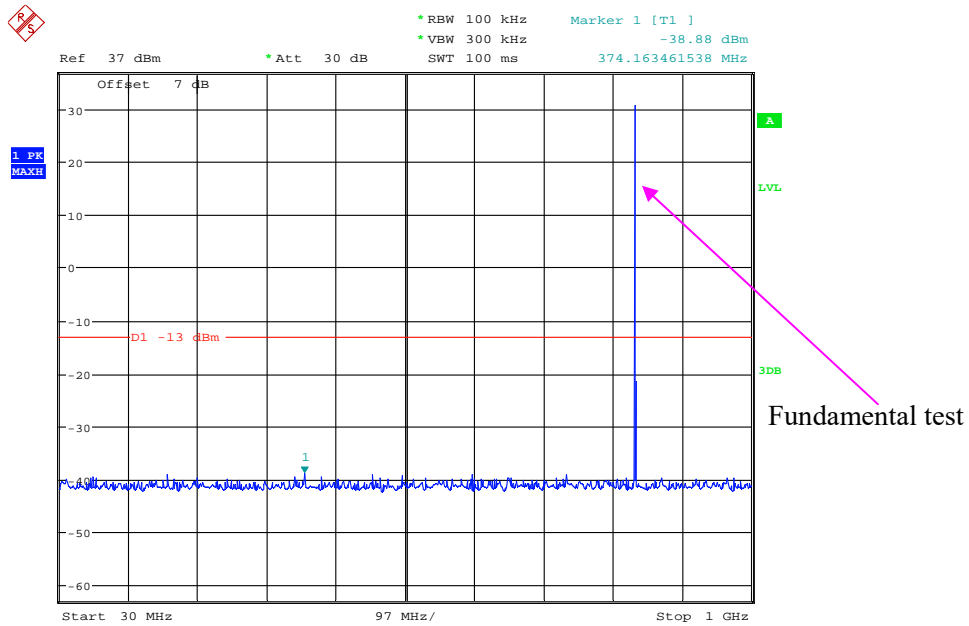

Date: 6.SEP.2021 15:50:04

1 GHz – 10 GHz (GSM Mode)

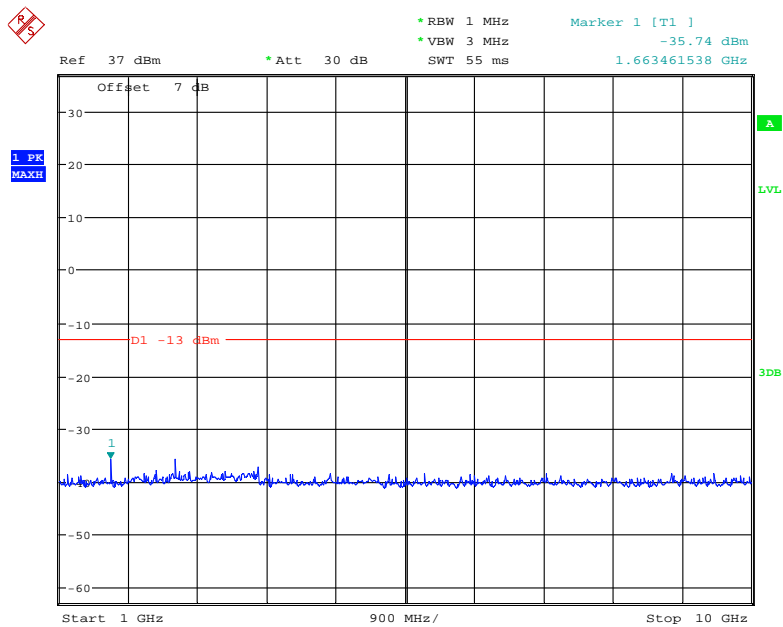

Date: 6.SEP.2021 15:51:28

30 MHz – 1 GHz (WCDMA Mode)

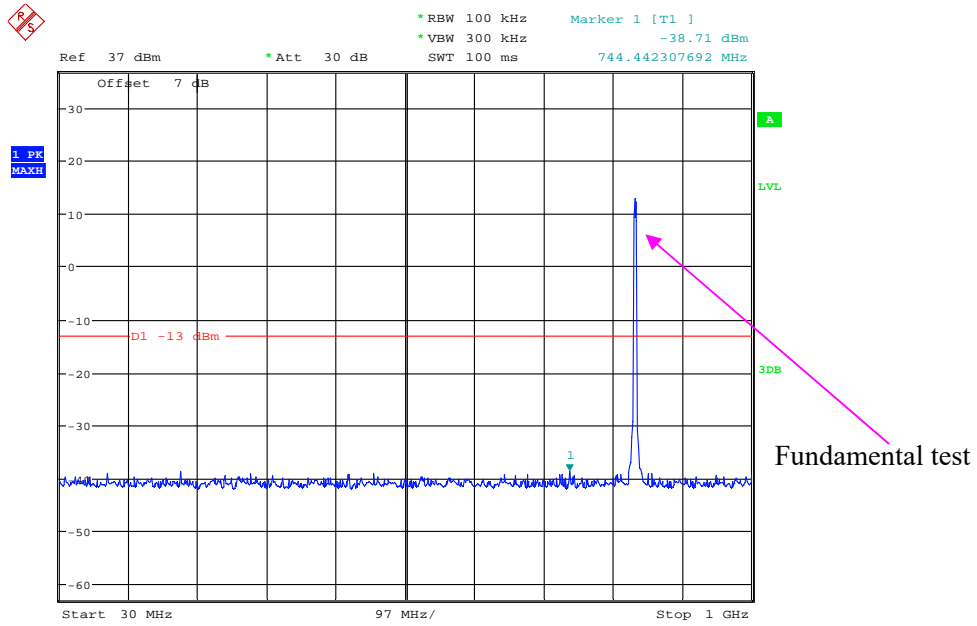

Date: 6.SEP.2021 00:25:52

1 GHz – 10 GHz (WCDMA Mode)

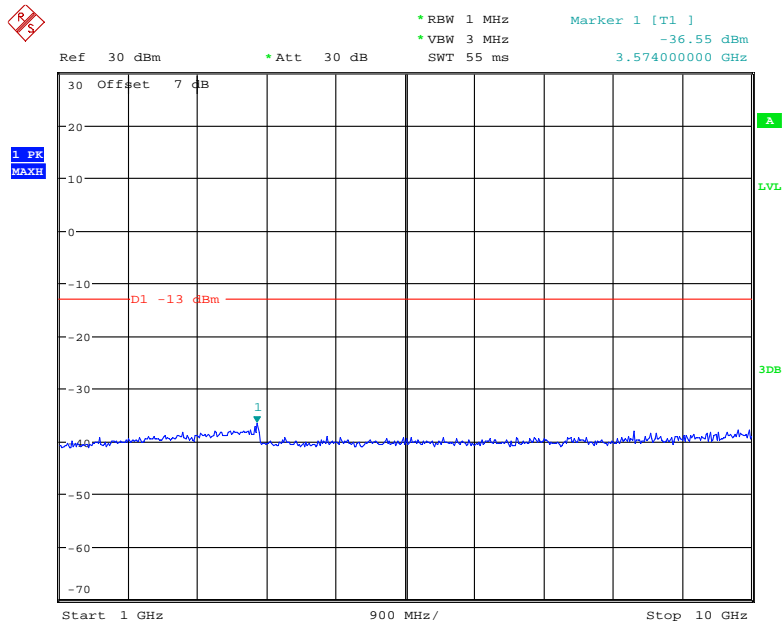

Date: 6.SEP.2021 14:49:14

High Channel:

30 MHz – 1 GHz (GSM Mode)

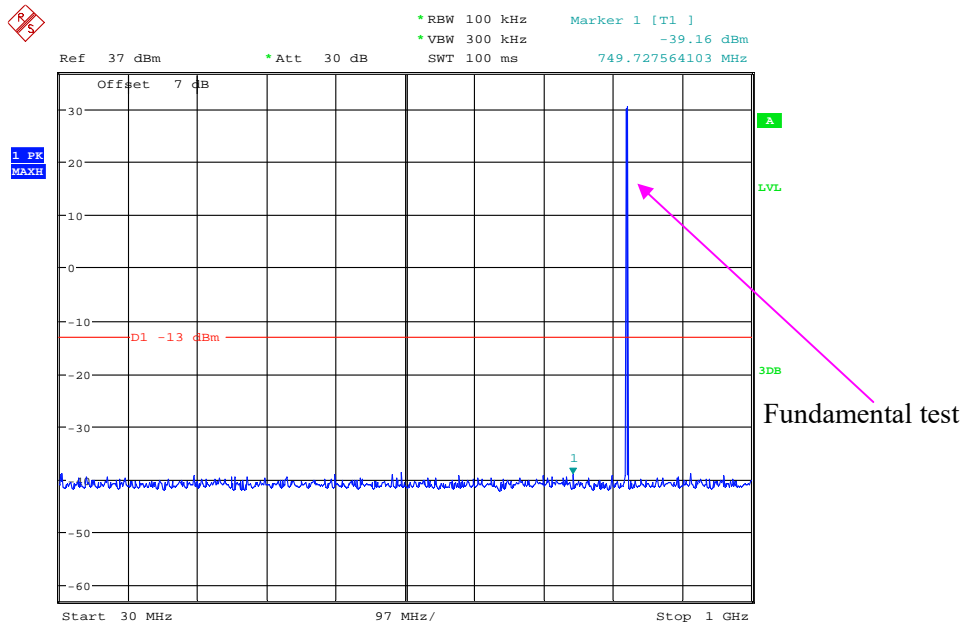

Date: 6.SEP.2021 15:49:08

1 GHz – 10 GHz (GSM Mode)

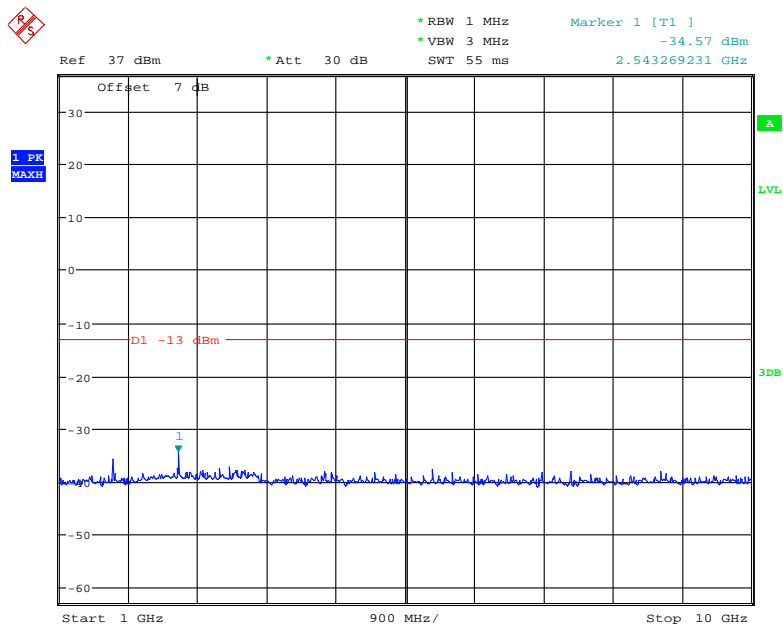

Date: 6.SEP.2021 15:51:07

30 MHz – 1 GHz (WCDMA Mode)

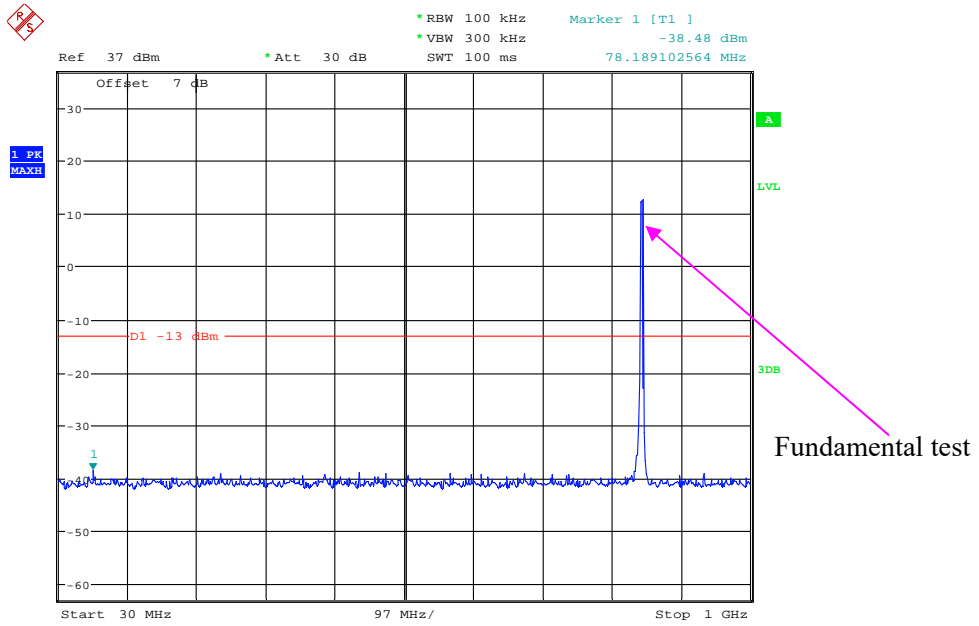

Date: 6.SEP.2021 00:25:16

1 GHz – 10 GHz (WCDMA Mode)

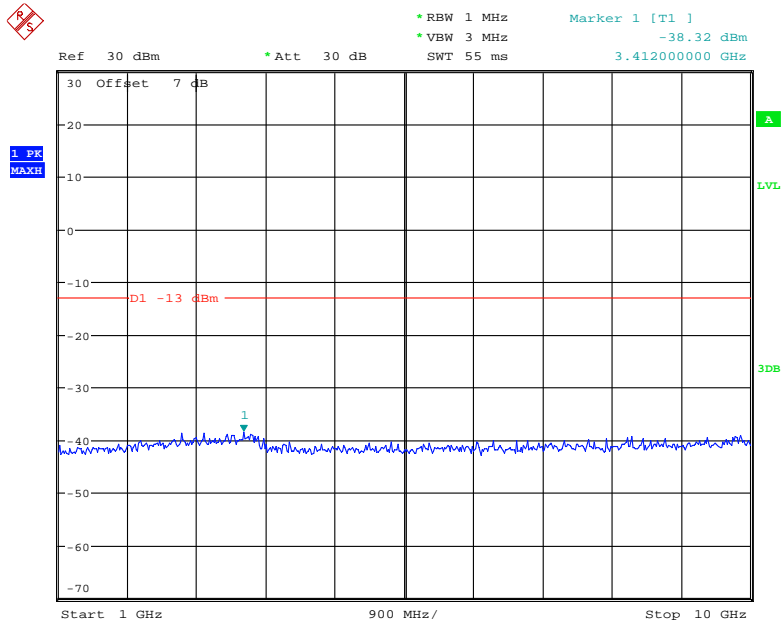

Date: 6.SEP.2021 14:50:16

PCS Band (Part 24E) Low Channel:

30 MHz – 1 GHz (GSM Mode)

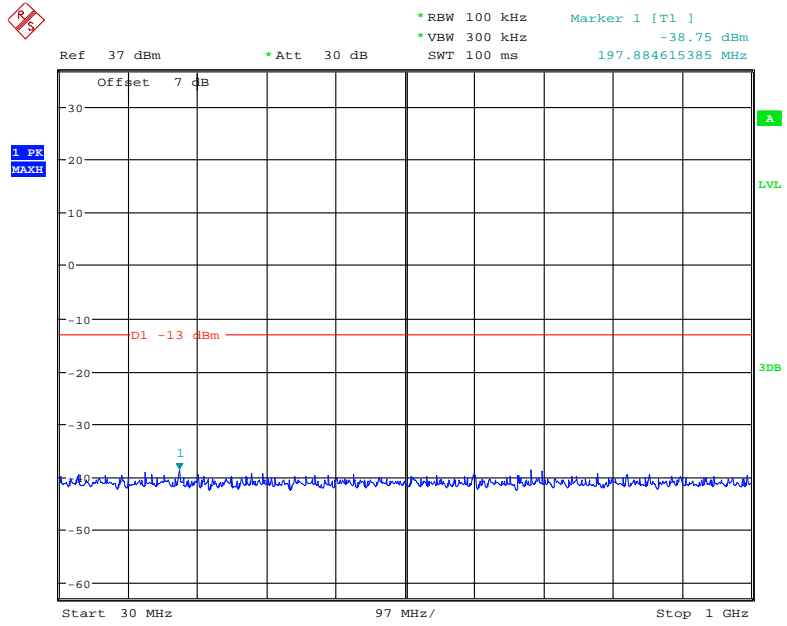

Date: 6.SEP.2021 16:21:12

1 GHz – 2 GHz (GSM Mode)

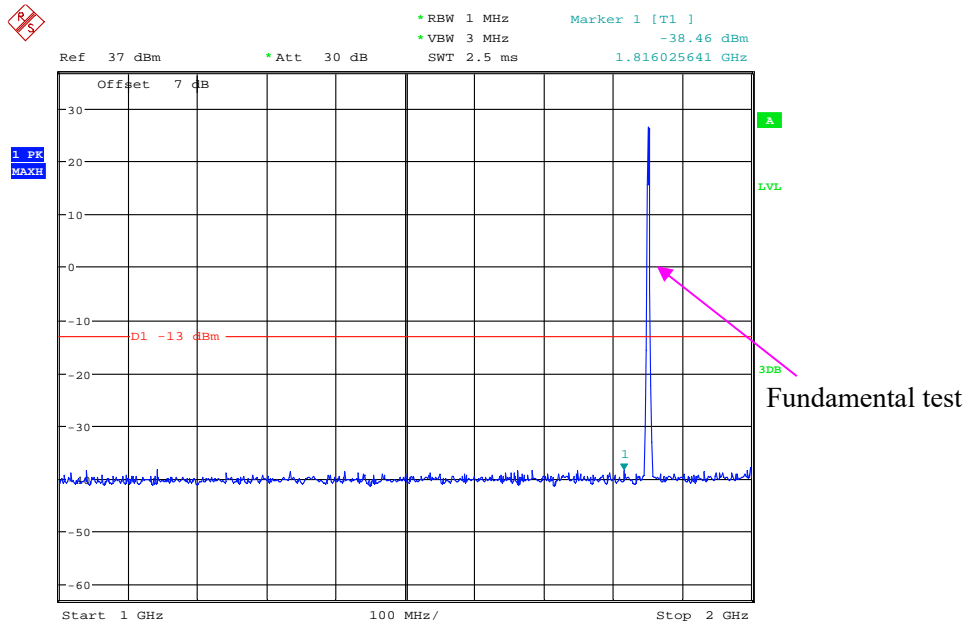

Date: 6.SEP.2021 16:22:14

2 GHz – 20 GHz (GSM Mode)

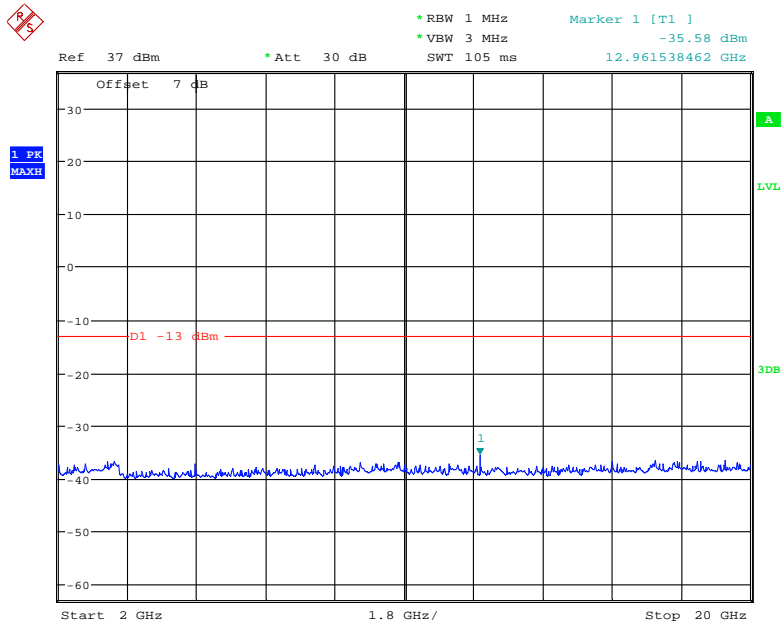

Date: 6.SEP.2021 09:58:57

30 MHz – 1 GHz (WCDMA Mode)

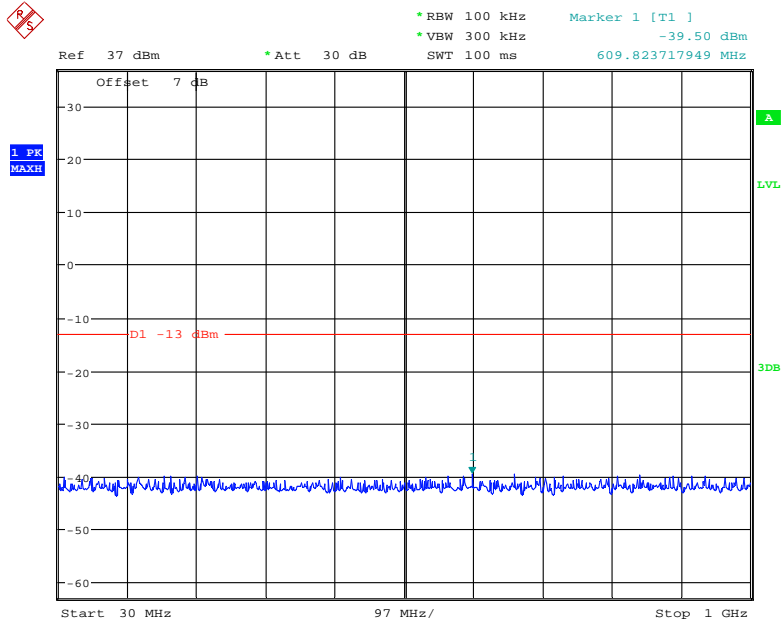

Date: 6.SEP.2021 00:28:30

1 GHz – 20 GHz (WCDMA Mode)

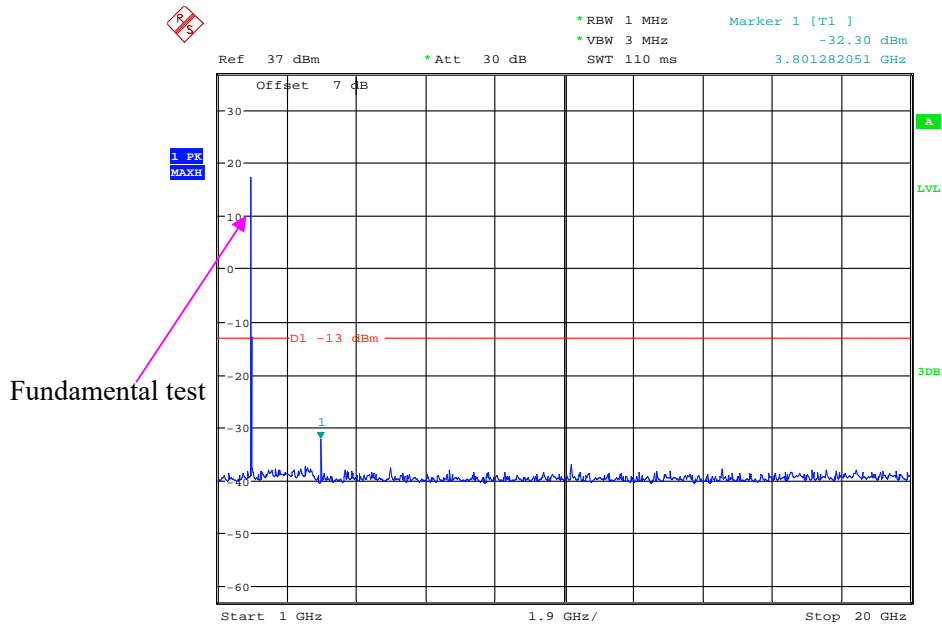

Date: 6.SEP.2021 00:20:08

Middle Channel:

30 MHz – 1 GHz (GSM Mode)

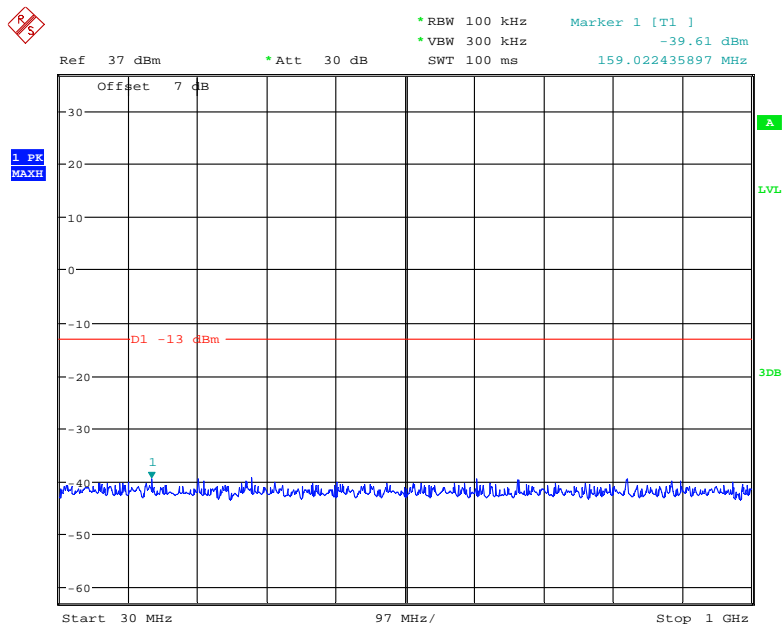

Date: 6.SEP.2021 16:21:03

1 GHz – 2 GHz (GSM Mode)

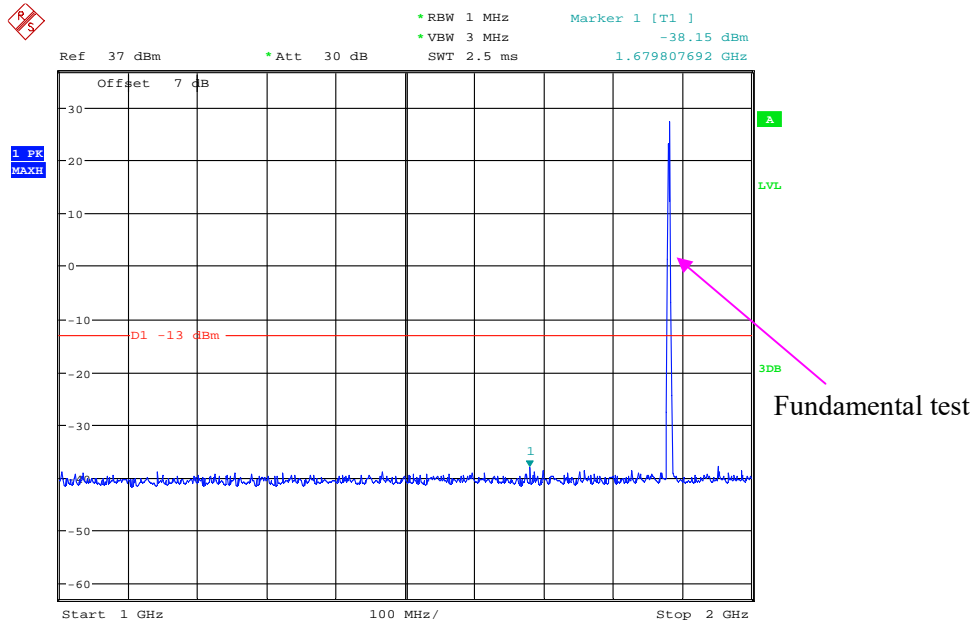

Date: 6.SEP.2021 16:22:39

2 GHz – 20 GHz (GSM Mode)

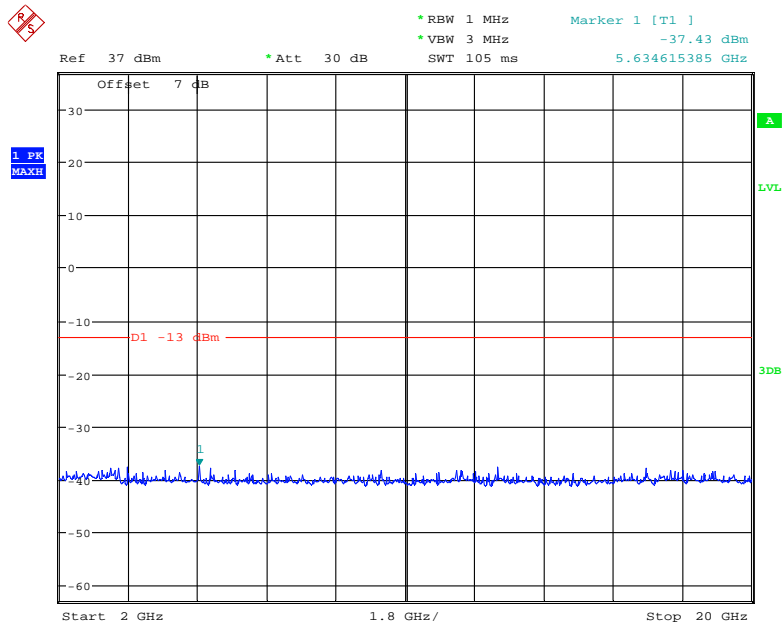

Date: 6.SEP.2021 16:24:15

30 MHz – 1 GHz (WCDMA Mode)

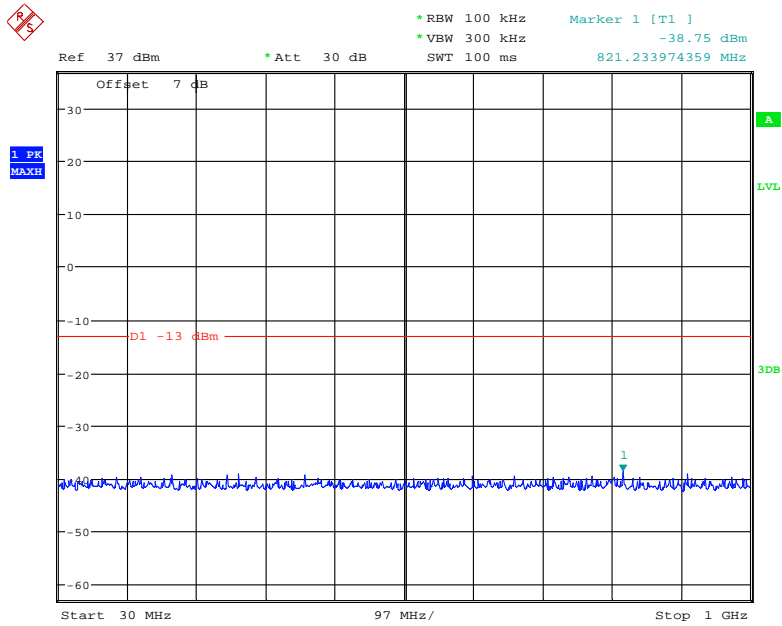

Date: 6.SEP.2021 00:28:38

1 GHz – 20 GHz (WCDMA Mode)

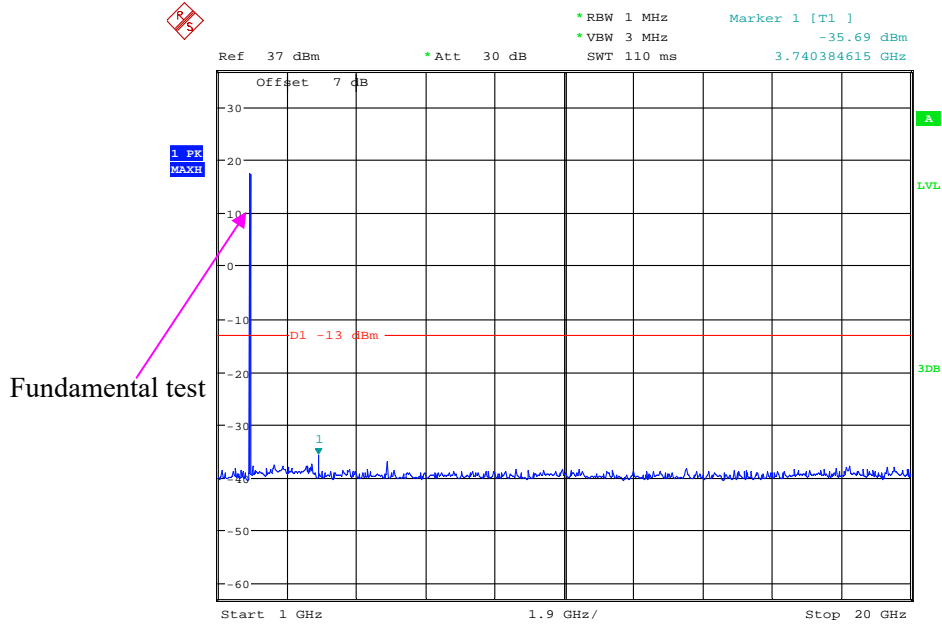

Date: 6.SEP.2021 00:19:41

High Channel:

30 MHz – 1 GHz (GSM Mode)

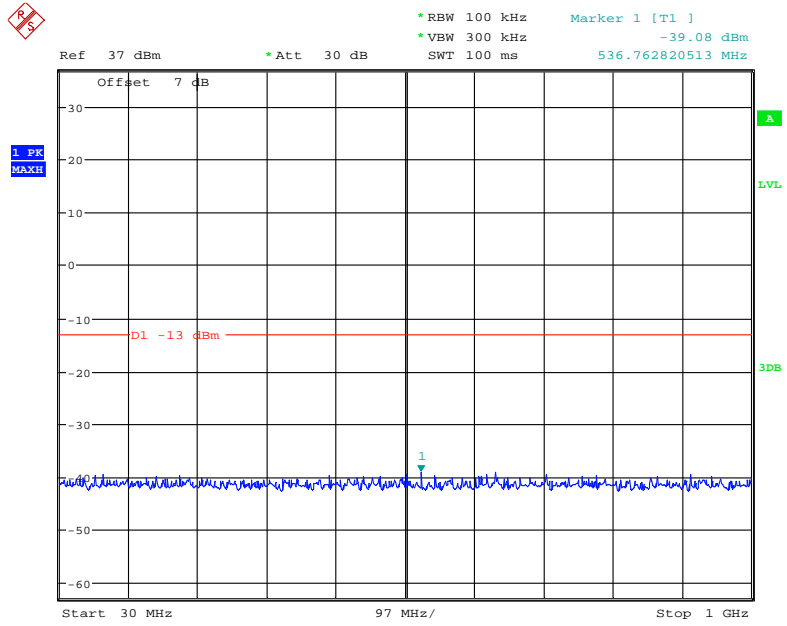

Date: 6.SEP.2021 16:20:37

1 GHz – 2 GHz (GSM Mode)

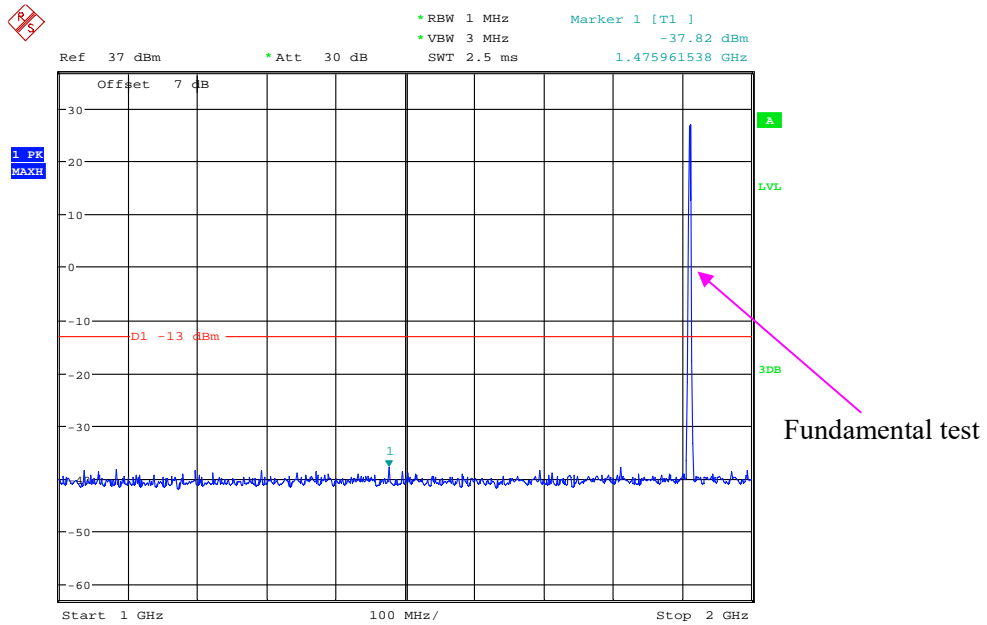

Date: 6.SEP.2021 16:23:00

2 GHz – 20 GHz (GSM Mode)

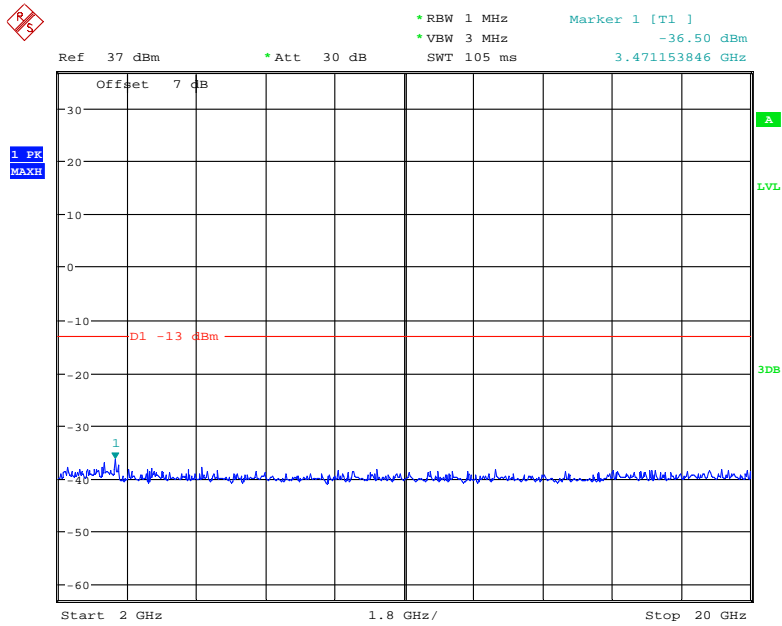

Date: 6.SEP.2021 16:23:59

30 MHz – 1 GHz (WCDMA Mode)

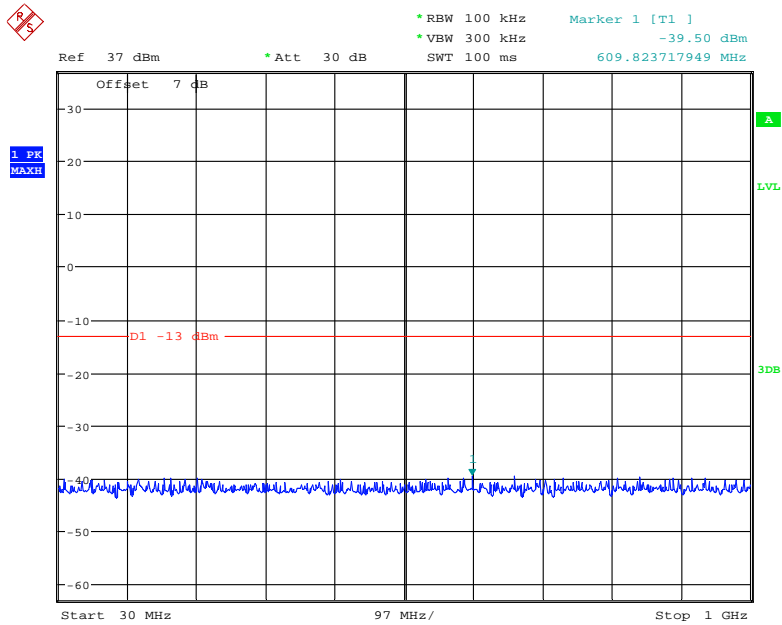

Date: 6.SEP.2021 00:28:30

1 GHz – 20 GHz (WCDMA Mode)

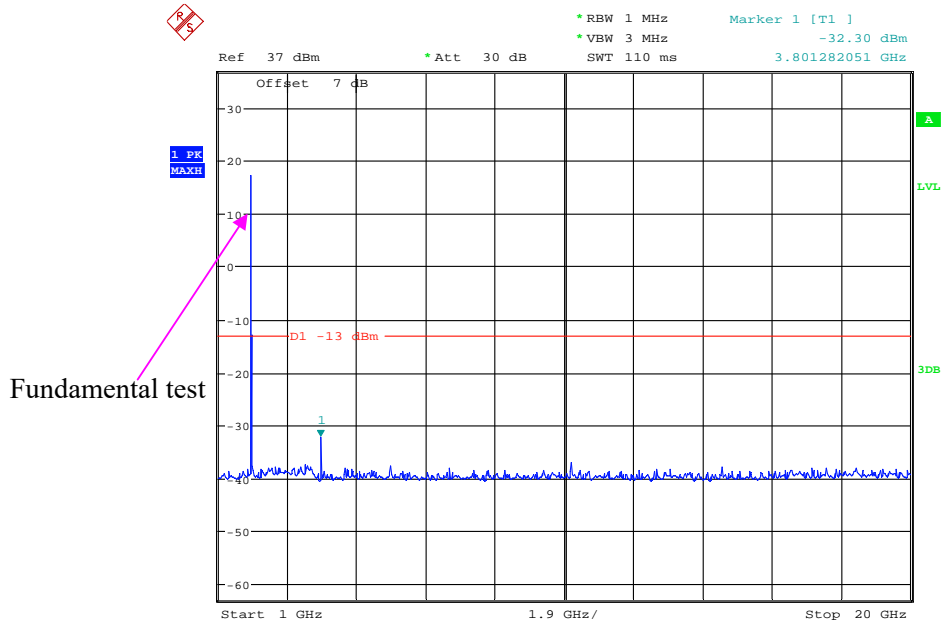

Date: 6.SEP.2021 00:20:08

**AWS Band (Part 27)
Low Channel:**

30 MHz – 1 GHz (WCDMA Mode)

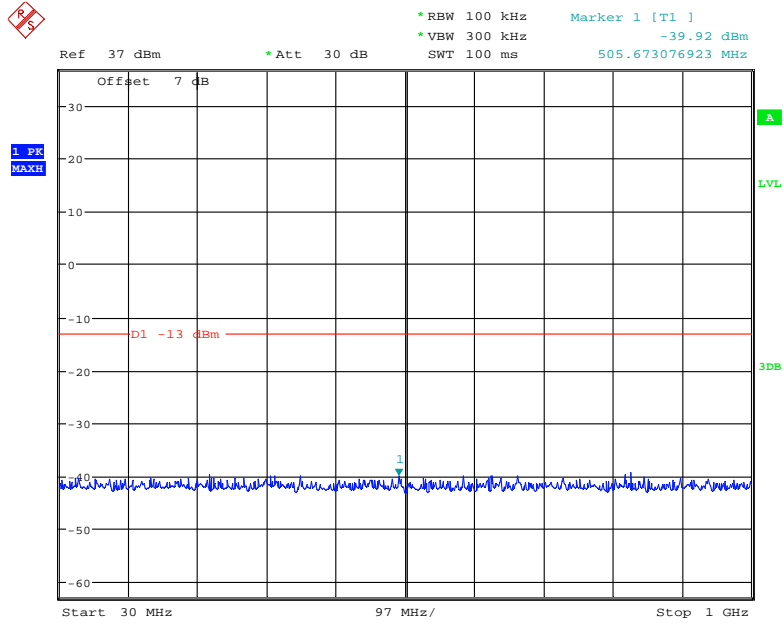

Date: 6.SEP.2021 00:27:47

1 GHz – 20 GHz (WCDMA Mode)

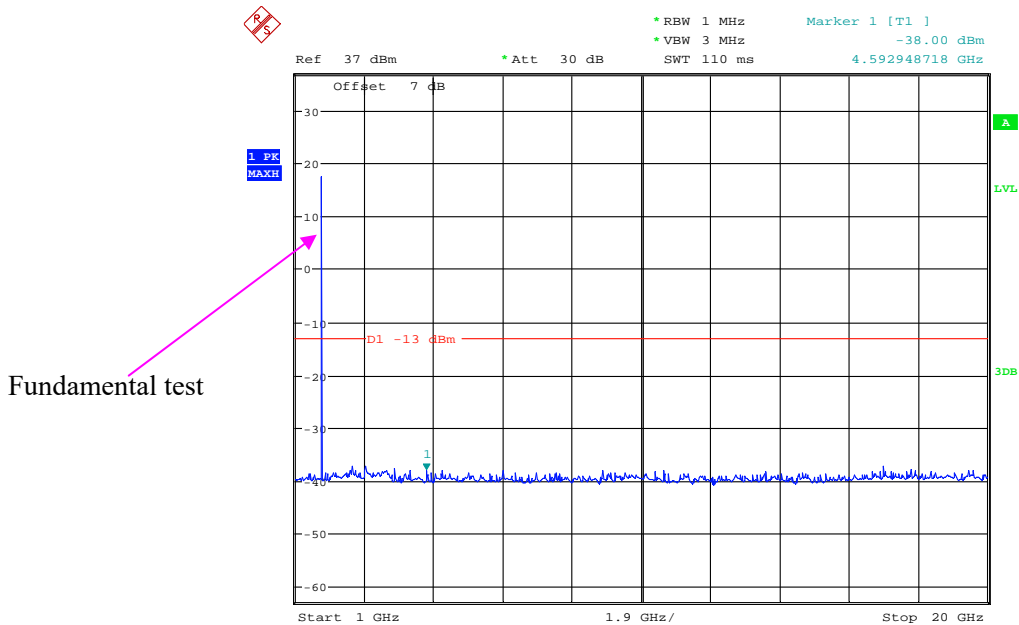

Date: 6.SEP.2021 00:22:15

Middle Channel

30 MHz – 1 GHz (WCDMA Mode)

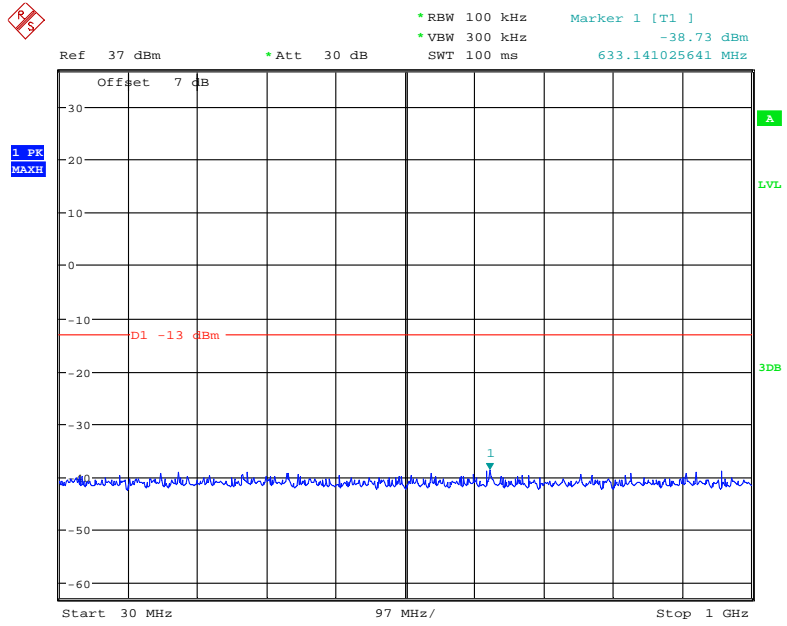

Date: 6.SEP.2021 00:27:57

1 GHz – 20 GHz (WCDMA Mode)

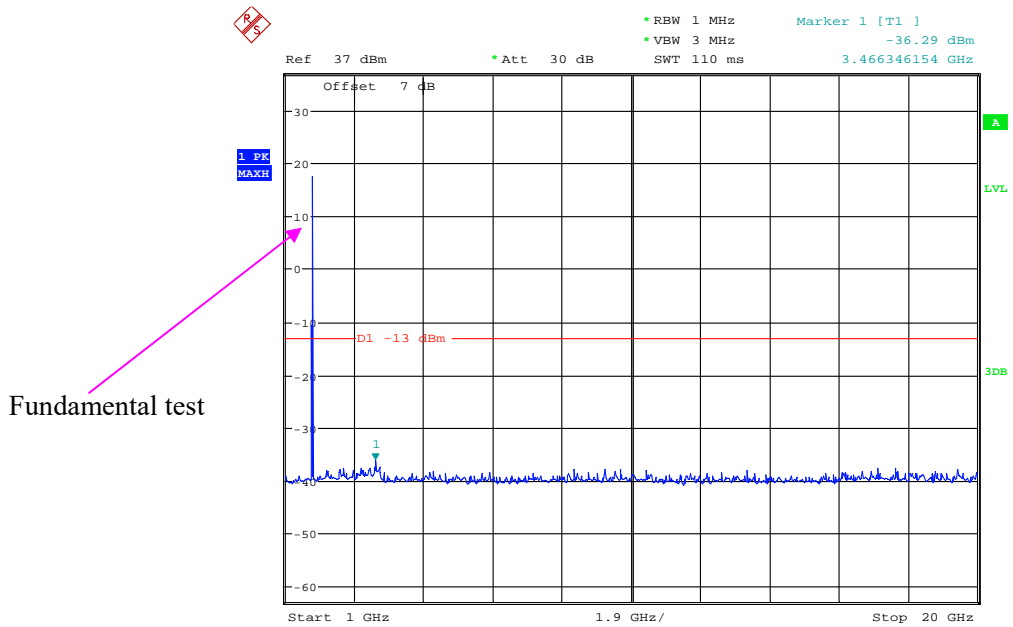

Date: 6.SEP.2021 00:21:49

High Channel:

30 MHz – 1 GHz (WCDMA Mode)

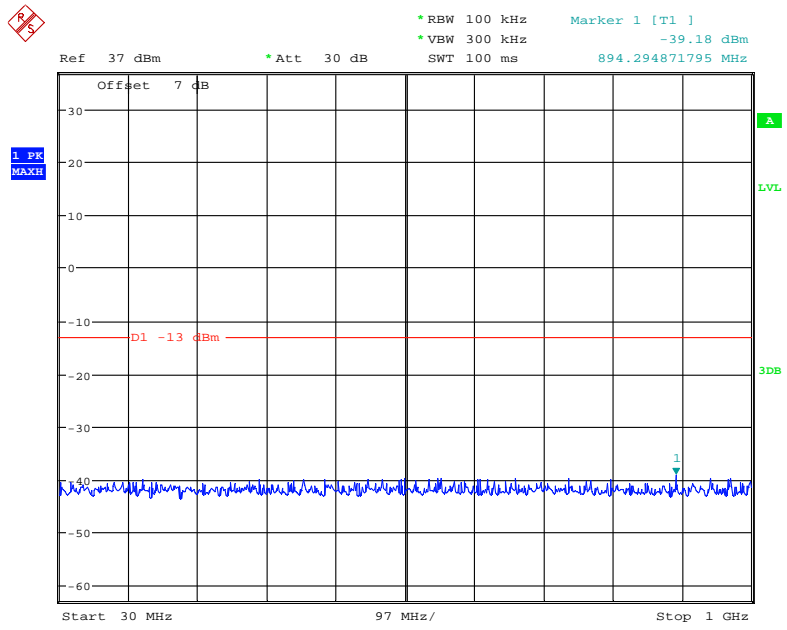

Date: 6.SEP.2021 00:28:11

1 GHz – 20 GHz (WCDMA Mode)

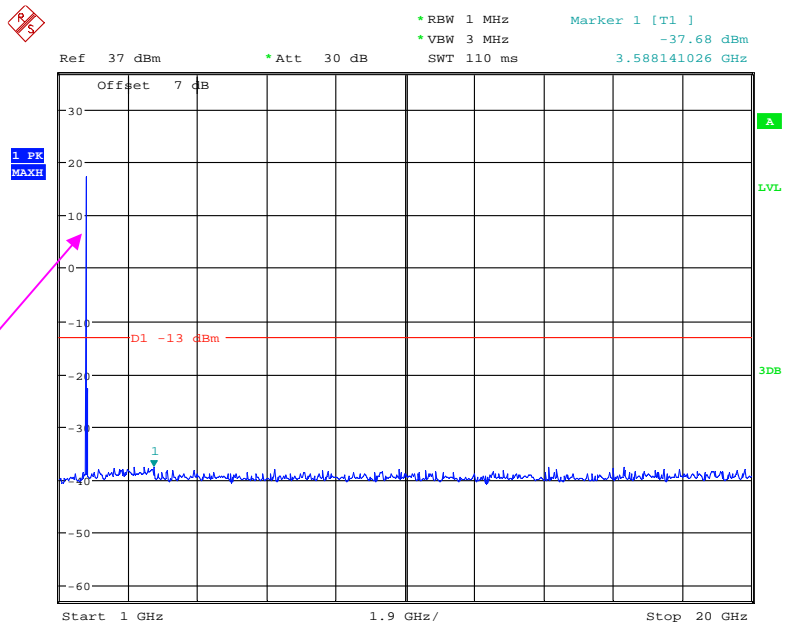

Fundamental test

Date: 6.SEP.2021 00:21:12

The test plots of LTE band please refer to the Appendix B.

FCC § 2.1053; § 22.917 (a); § 24.238 (a); §27.53 SPURIOUS RADIATED EMISSIONS

Applicable Standard

FCC § 2.1053, §22.917(a) and § 24.238(a) and § 27.53

Test Procedure

The transmitter was placed on a wooden turntable, and it was transmitting into a non-radiating load which was also placed on the turntable.

The measurement antenna was placed at a distance of 3 meters from the EUT. During the tests, the receiving antenna height and polarization as well as EUT azimuth were varied in order to identify the maximum level of emissions from the EUT. The test was performed by placing the EUT on 3-orthogonal axis.

The frequency range up to tenth harmonic of the fundamental frequency was investigated.

Test Data**Environmental Conditions**

Temperature:	27 °C
Relative Humidity:	56 %
ATM Pressure:	101.0 kPa

The testing was performed by Caro hu on 2021-09-07 for below 1GHz and BiuDeng on 2021-09-08 for above 1GHz.

EUT operation mode: Transmitting

30 MHz ~ 10 GHz:**Cellular Band (Part 22H)**

Frequency (MHz)	Receiver Reading (dBm)	Turntable Degree	Rx Antenna		Substituted Factor (dB)	Absolute Level (dBm)	FCC Part 22H	
			Height (m)	Polar (H/V)			Limit (dBm)	Margin (dB)
GSM Mode								
Low Channel								
95.43	-65.86	72	1.6	H	-2.65	-68.51	-13	55.51
95.43	-64.93	250	1.5	V	-3.32	-68.25	-13	55.25
1648.4	-51.98	157	2	H	-2.32	-54.30	-13	41.30
1648.4	-51.01	242	1.9	V	-2.29	-53.30	-13	40.30
2472.6	-44.26	51	1.7	H	1.16	-43.10	-13	30.10
2472.6	-47.59	64	1.8	V	1.09	-46.50	-13	33.50
3296.8	-50.75	13	1.5	H	3.25	-47.50	-13	34.50
3296.8	-50.06	193	1.2	V	3.16	-46.90	-13	33.90
Middle Channel								
95.43	-65.04	8	1.6	H	-2.65	-67.69	-13	54.69
95.43	-64.26	135	1.1	V	-3.32	-67.58	-13	54.58
1673.2	-43.62	111	2.1	H	-2.38	-46.00	-13	33.00
1673.2	-46.59	279	2.2	V	-2.31	-48.90	-13	35.90
2509.8	-41.24	317	1.2	H	1.34	-39.90	-13	26.90
2509.8	-45.97	6	1.6	V	1.37	-44.60	-13	31.60
3346.4	-49.82	169	2.1	H	3.32	-46.50	-13	33.50
3346.4	-50.04	293	1.9	V	3.24	-46.80	-13	33.80
High Channel								
95.43	-65.20	55	2.2	H	-2.65	-67.85	-13	54.85
95.43	-63.94	83	2.1	V	-3.32	-67.26	-13	54.26
1697.6	-46.52	307	2.1	H	-2.38	-48.90	-13	35.90
1697.6	-47.36	145	1.5	V	-2.34	-49.70	-13	36.70
2546.4	-40.58	81	2	H	1.38	-39.20	-13	26.20
2546.4	-45.12	157	1.4	V	1.42	-43.70	-13	30.70
3395.2	-53.72	259	2.1	H	6.32	-47.40	-13	34.40
3395.2	-53.71	354	1.5	V	6.21	-47.50	-13	34.50

Frequency (MHz)	Receiver Reading (dBm)	Turntable Degree	Rx Antenna		Substituted Factor (dB)	Absolute Level (dBm)	FCC Part 22H	
			Height (m)	Polar (H/V)			Limit (dBm)	Margin (dB)
WCDMA Mode								
Low Channel								
95.43	-65.77	354	2.1	H	-2.65	-68.42	-13	55.42
95.43	-64.91	182	1.7	V	-3.32	-68.23	-13	55.23
1652.8	-48.78	210	2.1	H	-2.32	-51.10	-13	38.10
1652.8	-50.31	289	1.8	V	-2.29	-52.60	-13	39.60
Middle Channel								
95.43	-65.04	180	1.4	H	-2.65	-67.69	-13	54.69
95.43	-64.1	111	1.7	V	-3.32	-67.42	-13	54.42
1673.2	-45.86	76	1.9	H	-2.34	-48.20	-13	35.20
1673.2	-46.99	354	1.8	V	-2.31	-49.30	-13	36.30
High Channel								
95.43	-65	61	1.5	H	-2.65	-67.65	-13	54.65
95.43	-64.05	270	1.2	V	-3.32	-67.37	-13	54.37
1693.2	-47.12	37	1.7	H	-2.38	-49.50	-13	36.50
1693.2	-50.56	71	1.1	V	-2.34	-52.90	-13	39.90

30 MHz ~ 20 GHz:

PCS Band (Part 24E)

Frequency (MHz)	Receiver Reading (dBm)	Turntable Degree	Rx Antenna		Substituted Factor (dB)	Absolute Level (dBm)	FCC Part 24E	
			Height (m)	Polar (H/V)			Limit (dBm)	Margin (dB)
GSM Mode								
Low Channel								
95.43	-65.71	331	1.6	H	-2.65	-68.36	-13	55.36
95.43	-64.86	305	2	V	-3.32	-68.18	-13	55.18
3700.4	-50.82	247	1.5	H	4.72	-46.10	-13	33.10
3700.4	-50.01	209	1.7	V	4.61	-45.40	-13	32.40
Middle Channel								
95.43	-65.04	187	1.1	H	-2.65	-67.69	-13	54.69
95.43	-64.22	44	1.9	V	-3.32	-67.54	-13	54.54
3760	-50.34	287	1.8	H	4.94	-45.40	-13	32.40
3760	-47.75	187	1.9	V	4.85	-42.90	-13	29.90
High Channel								
95.43	-65.71	343	1.5	H	-2.65	-68.36	-13	55.36
95.43	-64.80	205	1.7	V	-3.32	-68.12	-13	55.12
3819.6	-49.35	65	1.2	H	5.25	-44.10	-13	31.10
3819.6	-47.48	258	2	V	5.08	-42.40	-13	29.40

Frequency (MHz)	Receiver Reading (dBm)	Turntable Degree	Rx Antenna		Substituted Factor (dB)	Absolute Level (dBm)	FCC Part 2E	
			Height (m)	Polar (H/V)			Limit (dBm)	Margin (dB)
WCDMA Mode								
Low Channel								
95.43	-64.7	358	1.4	H	-2.65	-67.35	-13	54.35
95.43	-63.94	23	1.3	V	-3.32	-67.26	-13	54.26
3704.8	-37.55	130	2.2	H	4.75	-32.80	-13	19.80
3704.8	-42.42	352	2.2	V	4.62	-37.80	-13	24.80
Middle Channel								
95.43	-65.04	348	2.1	H	-2.65	-67.69	-13	54.69
95.43	-64.13	142	1.7	V	-3.32	-67.45	-13	54.45
3760	-39.24	230	1.4	H	4.94	-34.30	-13	21.30
3760	-43.05	324	1.3	V	4.85	-38.20	-13	25.20
High Channel								
95.43	-65.09	325	2.1	H	-2.65	-67.74	-13	54.74
95.43	-64.07	224	1.4	V	-3.32	-67.39	-13	54.39
3815.2	-37.92	120	2	H	5.22	-32.70	-13	19.70
3815.2	-41.15	236	1.1	V	5.05	-36.10	-13	23.10

30 MHz ~ 20 GHz:

AWS Band

Frequency (MHz)	Receiver Reading (dBm)	Turntable Degree	Rx Antenna		Substituted Factor (dB)	Absolute Level (dBm)	FCC Part 27	
			Height (m)	Polar (H/V)			Limit (dBm)	Margin (dB)
WCDMA Mode								
Low Channel								
95.43	-65.71	331	1.6	H	-2.65	-68.36	-13	55.36
95.43	-64.86	305	2	V	-3.32	-68.18	-13	55.18
3424.8	-36.66	197	2	H	3.26	-33.40	-13	20.40
3424.8	-44.23	209	2.1	V	3.23	-41.00	-13	28.00
Middle Channel								
95.43	-65.04	187	1.1	H	-2.65	-67.69	-13	54.69
95.43	-64.22	44	1.9	V	-3.32	-67.54	-13	54.54
3465.2	-37.35	193	1.3	H	3.35	-34.00	-13	21.00
3465.2	-45.02	280	1.8	V	3.32	-41.70	-13	28.70
High Channel								
95.43	-65.71	343	1.5	H	-2.65	-68.36	-13	55.36
95.43	-64.80	205	1.7	V	-3.32	-68.12	-13	55.12
3505.2	-40.36	223	2	H	3.56	-36.80	-13	23.80
3505.2	-46.68	27	1.4	V	3.48	-43.20	-13	30.20

LTE Band: (Pre-scan with all the bandwidth, and worst case as below)

Frequency (MHz)	Receiver Reading (dBm)	Turntable Degree	Rx Antenna		Substituted Factor (dB)	Absolute Level (dBm)	Limit (dBm)	Margin (dB)
			Height (m)	Polar (H/V)				
Band 2								
Test frequency range: 30 MHz ~ 20 GHz								
1.4MHz, Low channel								
95.43	-64.71	148	1.2	H	-2.65	-67.36	-13	54.36
95.43	-63.73	123	1	V	-3.32	-67.05	-13	54.05
3701.4	-35.52	227	1.3	H	4.72	-30.80	-13	17.80
3701.4	-42.11	324	1.9	V	4.61	-37.50	-13	24.50
1.4MHz, Middle channel								
95.43	-64.93	101	2	H	-2.65	-67.58	-13	54.58
95.43	-63.97	82	1.6	V	-3.32	-67.29	-13	54.29
3760	-36.94	58	1.9	H	4.94	-32.00	-13	19.00
3760	-43.95	309	2.1	V	4.85	-39.10	-13	26.10
1.4MHz, High Channel								
95.43	-64.91	252	1.9	H	-2.65	-67.56	-13	54.56
95.43	-63.84	359	2.1	V	-3.32	-67.16	-13	54.16
3818.6	-35.85	194	2.2	H	5.25	-30.60	-13	17.60
3818.6	-40.38	64	1.3	V	5.08	-35.30	-13	22.30
Band 4								
Test frequency range:30 MHz ~ 20 GHz								
1.4MHz, Low channel								
95.43	-65.77	93	1.4	H	-2.65	-68.42	-13	55.42
95.43	-64.91	77	1.5	V	-3.32	-68.23	-13	55.23
3421.4	-36.92	339	1.4	H	2.72	-34.20	-13	21.20
3421.4	-42.99	14	2.1	V	2.59	-40.40	-13	27.40
1.4MHz, Middle channel								
95.43	-65.2	321	1.6	H	-2.65	-67.85	-13	54.85
95.43	-64.3	158	1.6	V	-3.32	-67.62	-13	54.62
3465	-36.09	120	1.2	H	3.09	-33.00	-13	20.00
3465	-43.87	223	1.4	V	2.97	-40.90	-13	27.90
1.4MHz, High Channel								
95.43	-65.09	255	2.1	H	-2.65	-67.74	-13	54.74
95.43	-64.04	280	2.1	V	-3.32	-67.36	-13	54.36
3508.6	-36.64	262	1.6	H	3.44	-33.20	-13	20.20
3508.6	-46.11	103	1.4	V	3.31	-42.80	-13	29.80

Frequency (MHz)	Receiver Reading (dBm)	Turntable Degree	Rx Antenna		Substituted Factor (dB)	Absolute Level (dBm)	Limit (dBm)	Margin (dB)
			Height (m)	Polar (H/V)				
Band 5								
Test frequency range: 30 MHz ~ 10 GHz								
1.4MHz, Low channel								
95.43	-64.91	78	1.4	H	-2.65	-67.56	-13	54.56
95.43	-63.99	355	1.8	V	-3.32	-67.31	-13	54.31
1649.4	-51.11	183	1.2	H	-2.79	-53.90	-13	40.90
1649.4	-52.37	137	1.1	V	-2.73	-55.10	-13	42.10
1.4MHz, Middle channel								
95.43	-65.14	55	1.5	H	-2.65	-67.79	-13	54.79
95.43	-64.09	13	1.5	V	-3.32	-67.41	-13	54.41
1673	-45.16	86	1.1	H	-2.74	-47.90	-13	34.90
1673	-48.41	28	1.4	V	-2.69	-51.10	-13	38.10
1.4MHz, High Channel								
95.43	-65.17	150	1.5	H	-2.65	-67.82	-13	54.82
95.43	-63.96	138	1.2	V	-3.32	-67.28	-13	54.28
1696.6	-44.9	137	1.2	H	-2.70	-47.60	-13	34.60
1696.6	-50.45	343	1.2	V	-2.65	-53.10	-13	40.10
Band 7								
Test frequency range: 30 MHz ~ 26.5 GHz								
5MHz, Low channel								
95.43	-65	267	1.3	H	-2.65	-67.65	-25	42.65
95.43	-64	96	1.4	V	-3.32	-67.32	-25	42.32
5005	-41.94	309	1.5	H	9.54	-32.40	-25	7.40
5005	-38.53	209	1.5	V	8.33	-30.20	-25	5.20
5MHz, Middle channel								
95.43	-64.93	245	1.6	H	-2.65	-67.58	-25	42.58
95.43	-63.94	242	2.1	V	-3.32	-67.26	-25	42.26
5070	-42.37	50	2.2	H	9.67	-32.70	-25	7.70
5070	-39.75	42	1.4	V	8.35	-31.40	-25	6.40
5MHz, High Channel								
95.43	-65.2	156	1.2	H	-2.65	-67.85	-25	42.85
95.43	-64.02	243	1.7	V	-3.32	-67.34	-25	42.34
5135	-42.94	31	1.7	H	9.84	-33.10	-25	8.10
5135	-39.86	151	1.7	V	8.36	-31.50	-25	6.50

Frequency (MHz)	Receiver Reading (dBm)	Turntable Degree	Rx Antenna		Substituted Factor (dB)	Absolute Level (dBm)	Limit (dBm)	Margin (dB)
			Height (m)	Polar (H/V)				
Band 17								
Test frequency range: 30 MHz ~ 10 GHz								
5MHz, Low channel								
95.43	-64.77	191	2.2	H	-2.65	-67.42	-13	54.42
95.43	-63.89	206	1.4	V	-3.32	-67.21	-13	54.21
1413	-50.75	39	1.4	H	-0.65	-51.40	-13	38.40
1413	-52.53	110	1.7	V	-0.87	-53.40	-13	40.40
5MHz, Middle channel								
95.43	-65.76	173	1.7	H	-2.65	-68.41	-13	55.41
95.43	-64.8	289	1.5	V	-3.32	-68.12	-13	55.12
1420	-49.83	305	1.7	H	-0.67	-50.50	-13	37.50
1420	-51.49	173	2.1	V	-0.91	-52.40	-13	39.40
5MHz, High Channel								
95.43	-65.47	293	1.8	H	-2.65	-68.12	-13	55.12
95.43	-64.72	189	1.2	V	-3.32	-68.04	-13	55.04
1427	-48.99	182	1.8	H	-0.71	-49.70	-13	36.70
1427	-51.06	231	1.4	V	-0.94	-52.00	-13	39.00
Band 38								
Test frequency range: 30 MHz ~ 26.5GHz								
5MHz, Low channel								
95.43	-65.11	128	2.1	H	-2.65	-67.76	-25	42.76
95.43	-64.08	51	1	V	-3.32	-67.4	-25	42.40
5145	-42.32	352	1	H	9.92	-32.40	-25	7.40
5145	-40.08	208	2	V	8.38	-31.70	-25	6.70
5MHz, Middle channel								
95.43	-65.04	180	1.4	H	-2.65	-67.69	-25	42.69
95.43	-63.93	208	1.7	V	-3.32	-67.25	-25	42.25
5190	-41.08	317	2.1	H	9.98	-31.10	-25	6.10
5190	-38.79	309	1.6	V	8.39	-30.40	-25	5.40
5MHz, High Channel								
95.43	-65.11	136	2	H	-2.65	-67.76	-25	42.76
95.43	-63.91	217	1.4	V	-3.32	-67.23	-25	42.23
5235	-41.16	168	2	H	10.06	-31.10	-25	6.10
5235	-39.05	228	2	V	8.45	-30.60	-25	5.60

Frequency (MHz)	Receiver Reading (dBm)	Turntable Degree	Rx Antenna		Substituted Factor (dB)	Absolute Level (dBm)	Limit (dBm)	Margin (dB)
			Height (m)	Polar (H/V)				
Band 41								
Test frequency range: 30 MHz ~ 26.5GHz								
5MHz, Low channel								
95.43	-65.03	66	1.5	H	-2.65	-67.68	-25	42.68
95.43	-63.95	140	1.8	V	-3.32	-67.27	-25	42.27
5075	-41.27	187	1	H	9.67	-31.60	-25	6.60
5075	-40.65	329	1.4	V	8.35	-32.30	-25	7.30
5MHz, Middle channel								
95.43	-65.13	221	1.7	H	-2.65	-67.78	-25	42.78
95.43	-64	76	1.4	V	-3.32	-67.32	-25	42.32
5190	-41.18	312	1.7	H	9.98	-31.20	-25	6.20
5190	-39.79	267	1.4	V	8.39	-31.40	-25	6.40
5MHz, High Channel								
95.43	-65.17	349	1.7	H	-2.65	-67.82	-25	42.82
95.43	-64.12	211	1.5	V	-3.32	-67.44	-25	42.44
5305	-39.02	39	2	H	10.12	-28.90	-25	3.90
5305	-37.51	2	1.5	V	8.51	-29.00	-25	4.00
Band 66								
Test frequency range: 30 MHz ~ 20GHz								
1.4MHz, Low channel								
95.43	-64.93	312	1.8	H	-2.65	-67.58	-13	54.58
95.43	-63.91	230	1.1	V	-3.32	-67.23	-13	54.23
3421.4	-37.32	43	1.2	H	2.72	-34.60	-13	21.60
3421.4	-44.59	286	1.2	V	2.59	-42.00	-13	29.00
1.4MHz, Middle channel								
95.43	-65.09	44	1.8	H	-2.65	-67.74	-13	54.74
95.43	-63.96	281	2.2	V	-3.32	-67.28	-13	54.28
3490	-37.02	67	1.3	H	3.12	-33.90	-13	20.90
3490	-45.09	326	1.3	V	2.99	-42.10	-13	29.10
1.4MHz, High Channel								
95.43	-65.04	24	1.1	H	-2.65	-67.69	-13	54.69
95.43	-63.92	117	1.8	V	-3.32	-67.24	-13	54.24
3558.6	-38.04	131	1.6	H	3.64	-34.40	-13	21.40
3558.6	-45.72	257	2.1	V	3.52	-42.20	-13	29.20

Note:

Absolute Level = Substituted Level - Cable loss + Antenna Gain

Margin = Limit- Absolute Level

dBd is for the ERP, dBi is for EIRP.

FCC § 22.917 (a); § 24.238 (a); §27.53(c) (h)(m) - BAND EDGES

Applicable Standard

According to § 22.917(a), the power of any emissions outside of the authorized operating frequency ranges must be attenuated below the transmitting power (P) by a factor of at least $43 + 10 \log(P)$ dB.

According to §24.238(a), the power of any emissions outside of the authorized operating frequency ranges must be attenuated below the transmitting power (P) by a factor of at least $43 + 10 \log(P)$ dB.

According to FCC §27.53 (c)(h)(m), the power of any emission outside of the authorized operating frequency ranges must be attenuated below the transmitting power (P) by a factor of at least $43 + 10 \log(P)$ dB.

Test Procedure

The RF output of the transmitter was connected to the input of the spectrum analyzer through sufficient attenuation.

The center of the spectrum analyzer was set to block edge frequency

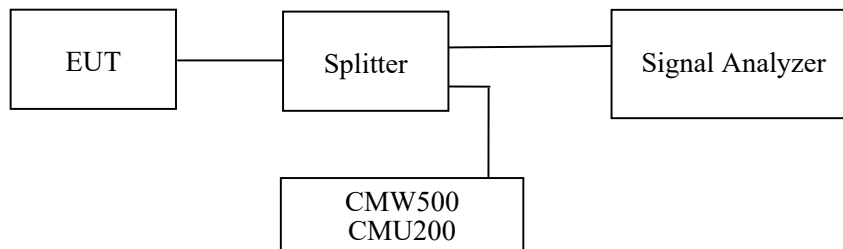

Test Data

Environmental Conditions

Temperature:	28 °C
Relative Humidity:	56 %
ATM Pressure:	101.0 kPa

The testing was performed by Ting Lü from 2021-09-05 to 2021-09-06.

EUT operation mode: Transmitting (Worst case)

Test Result: Pass

Please refer to the following plots.

Cellular Band, Left Band Edge for GSM (GMSK) Mode

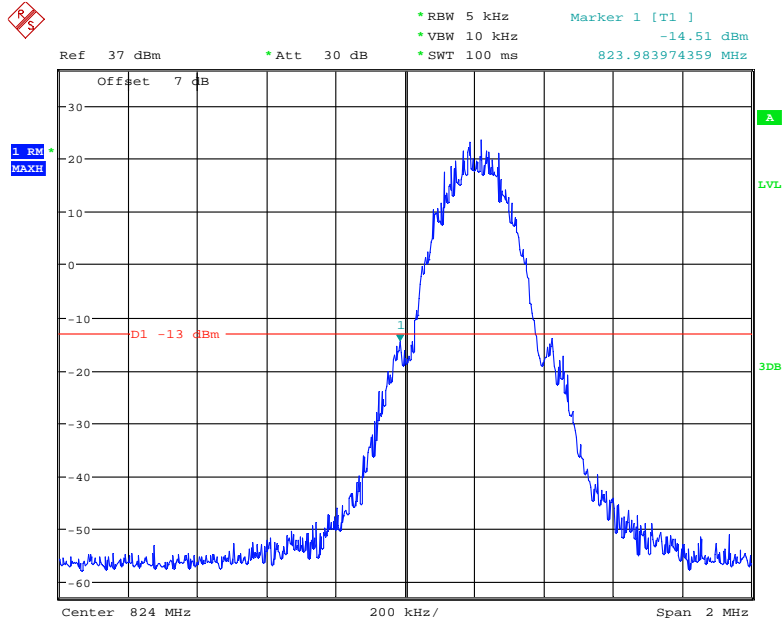

Date: 6.SEP.2021 16:45:05

Cellular Band, Right Band Edge for GSM (GMSK) Mode

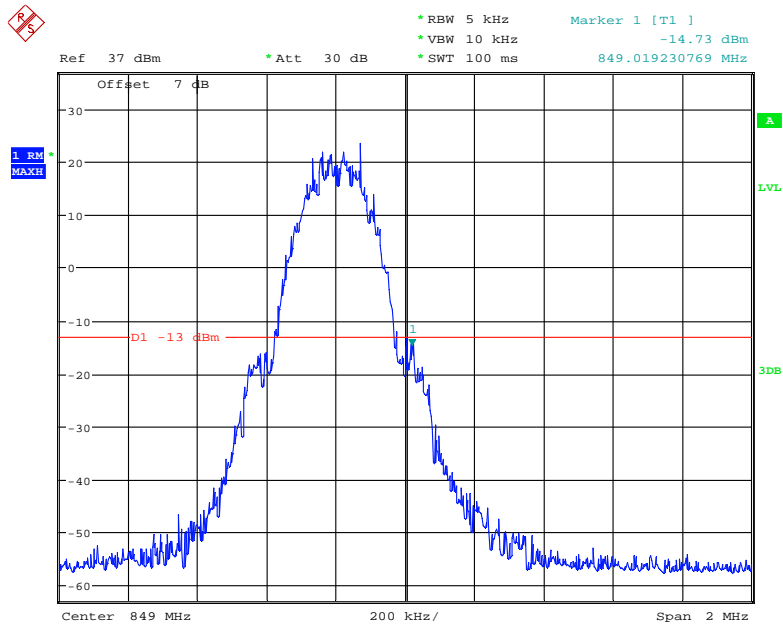

Date: 6.SEP.2021 16:46:44

Cellular Band, Left Band Edge for EGPRS (8PSK) Mode

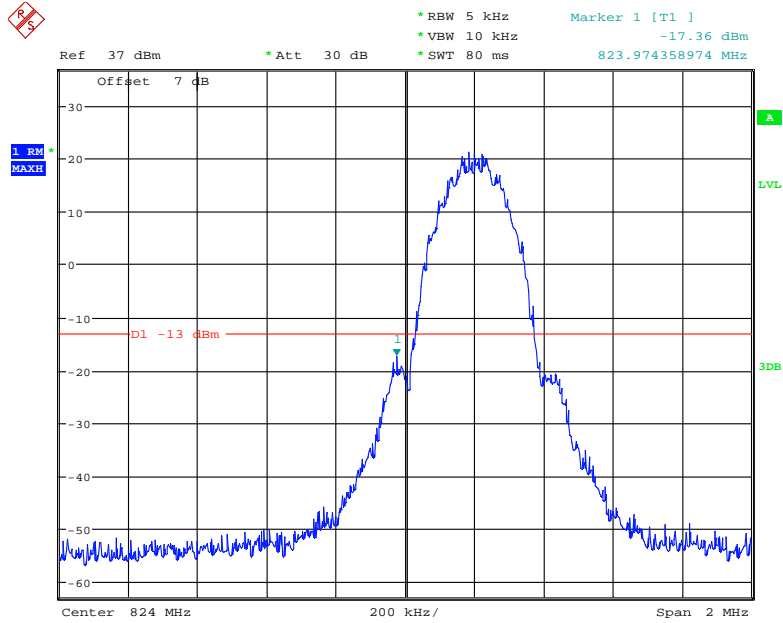

Date: 6.SEP.2021 16:06:47

Cellular Band, Right Band Edge for EGPRS (8PSK) Mode

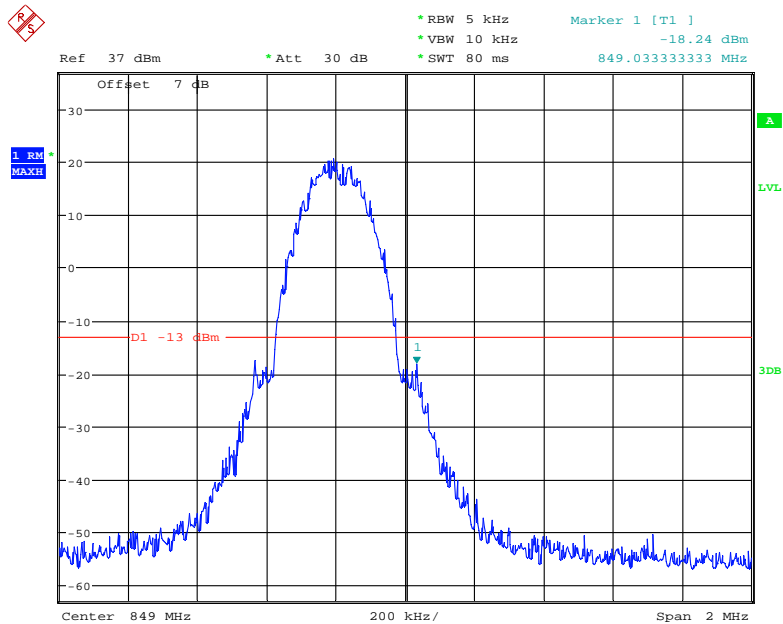

Date: 6.SEP.2021 16:07:40

Cellular Band, Left Band Edge for RMC (BPSK) Mode

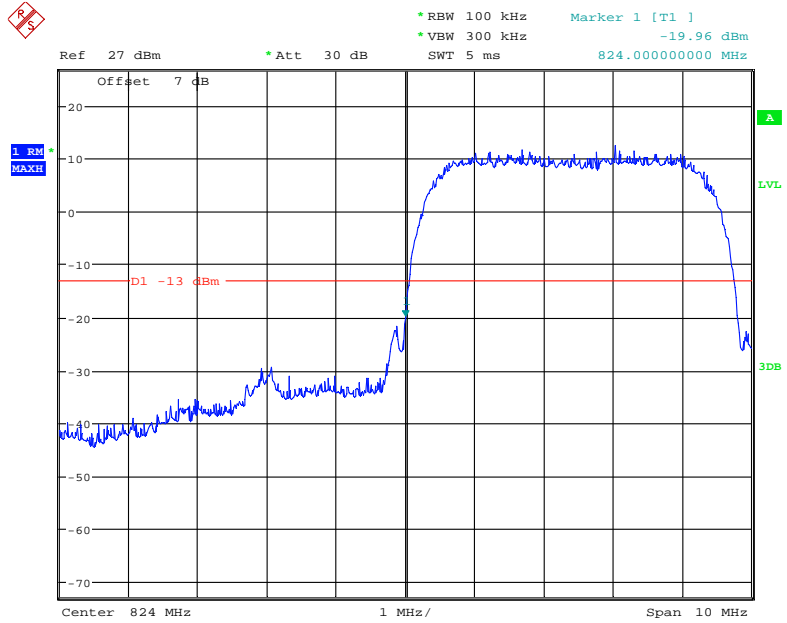

Date: 5.SEP.2021 22:29:41

Cellular Band, Right Band Edge for RMC (BPSK) Mode

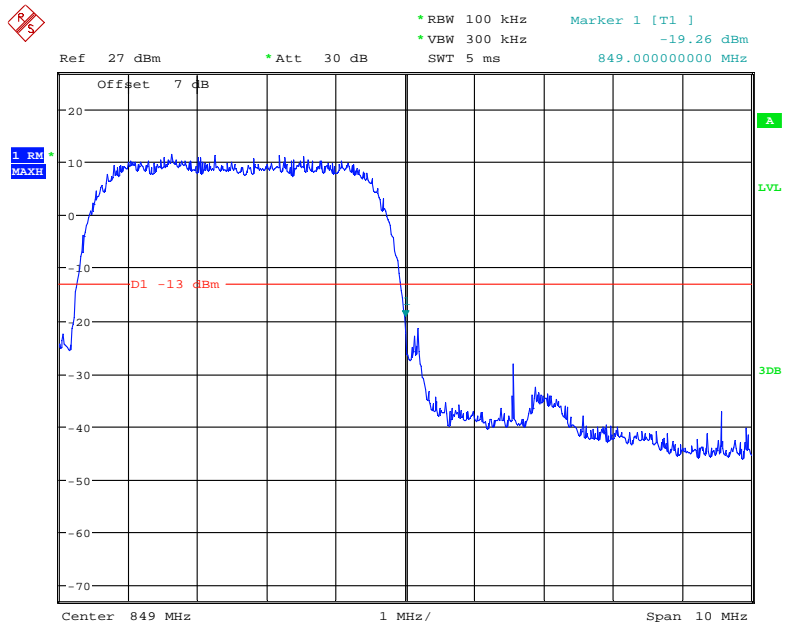

Date: 5.SEP.2021 22:30:08

Cellular Band, Left Band Edge for HSDPA (16QAM) Mode

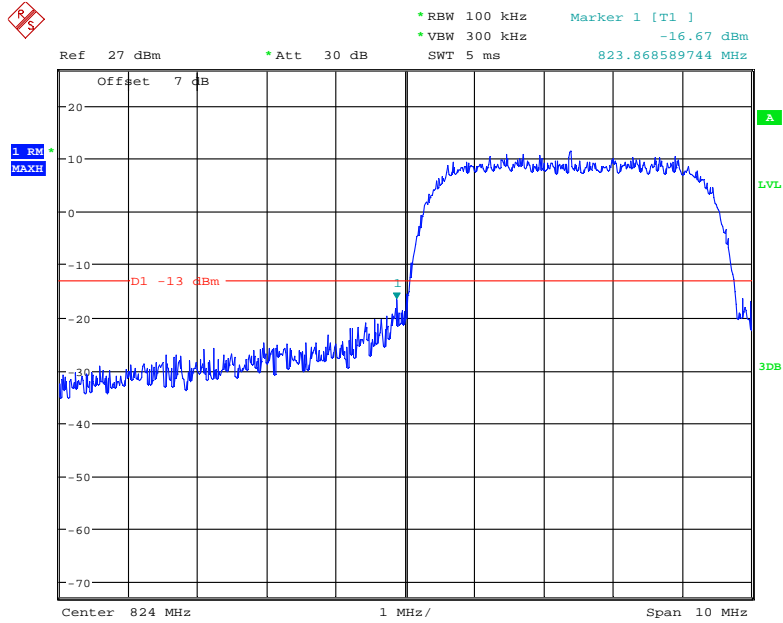

Date: 5.SEP.2021 22:36:37

Cellular Band, Right Band Edge for HSDPA (16QAM) Mode

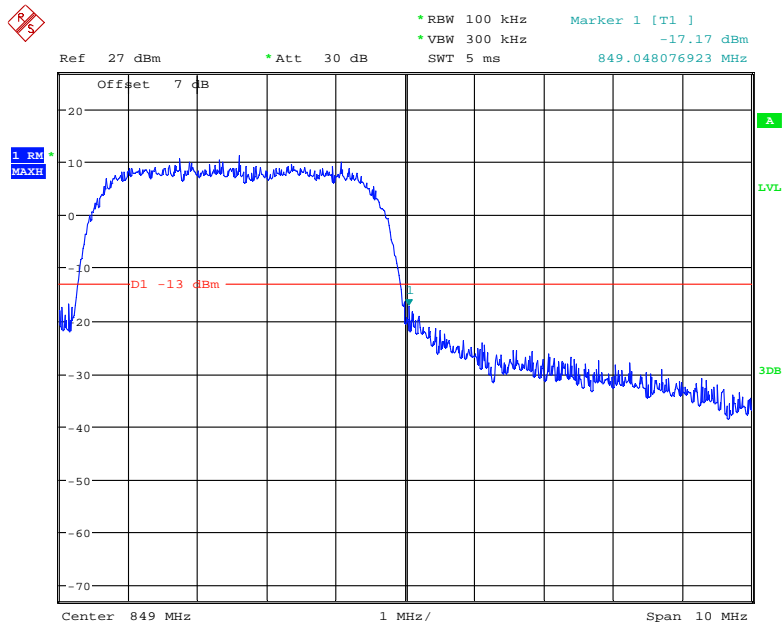

Date: 5.SEP.2021 22:35:42

Cellular Band, Left Band Edge for HSUPA (BPSK) Mode

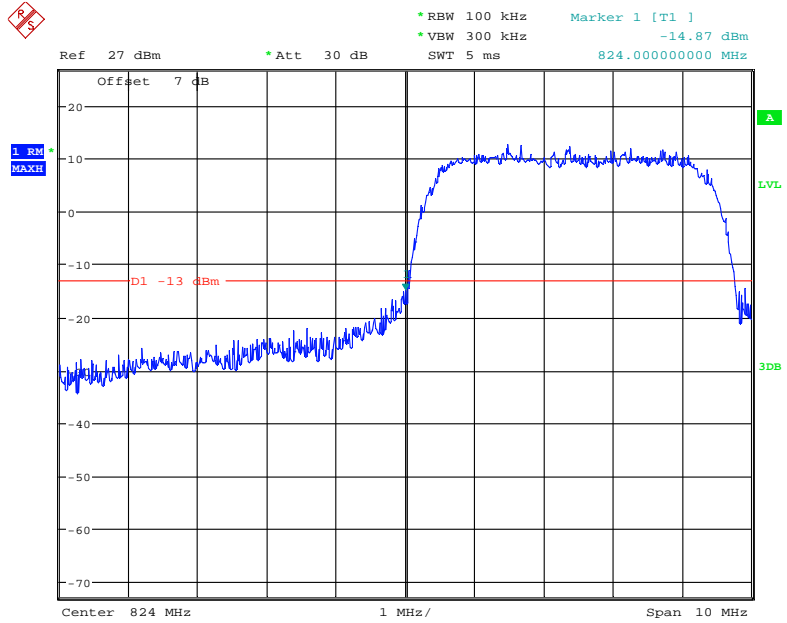

Date: 5.SEP.2021 23:08:42

Cellular Band, Right Band Edge for HSUPA (BPSK) Mode

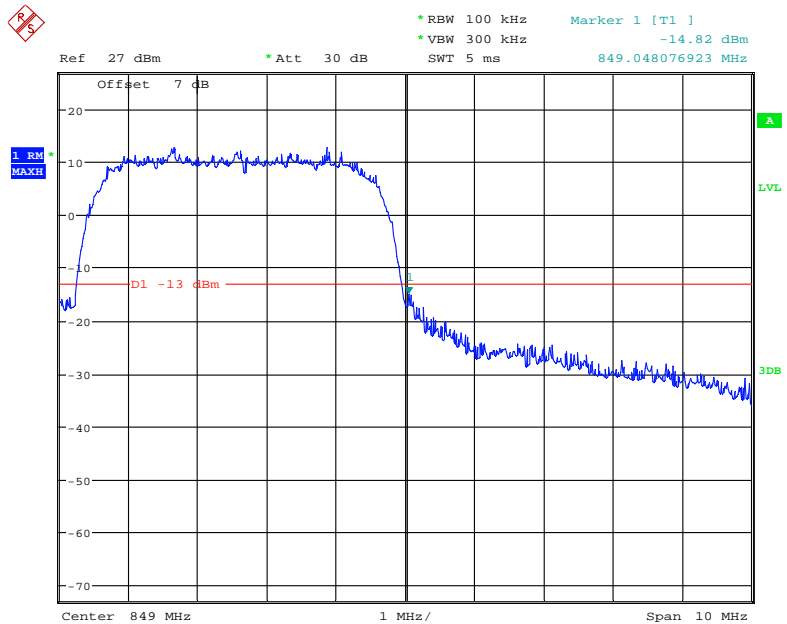

Date: 5.SEP.2021 23:12:54

PCS Band, Left Band Edge for GSM (GMSK) Mode

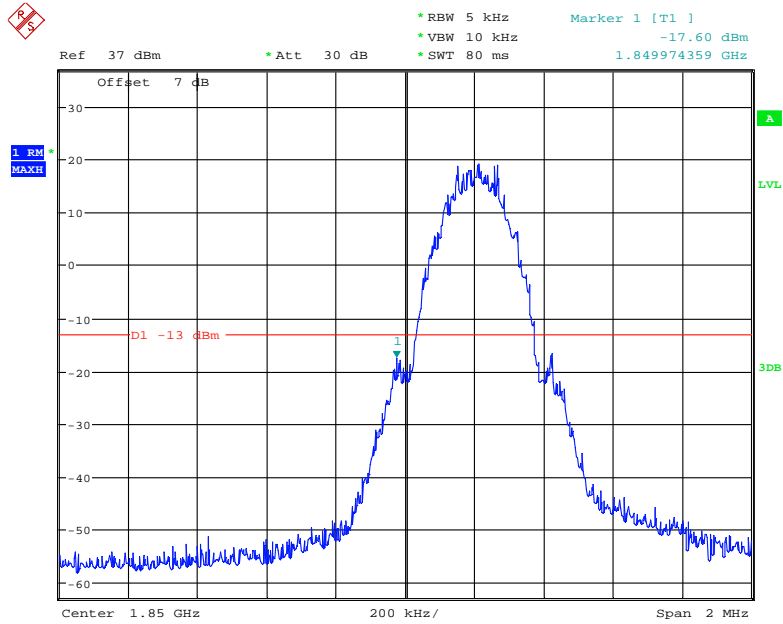

Date: 6.SEP.2021 16:09:57

PCS Band, Right Band Edge for GSM (GMSK) Mode

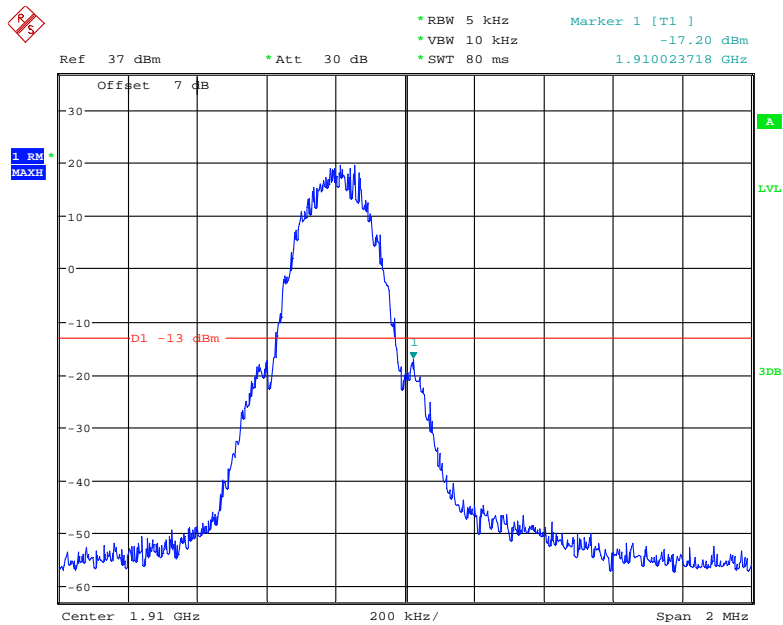

Date: 6.SEP.2021 16:10:47

PCS Band, Left Band Edge for EGPRS (8PSK) Mode

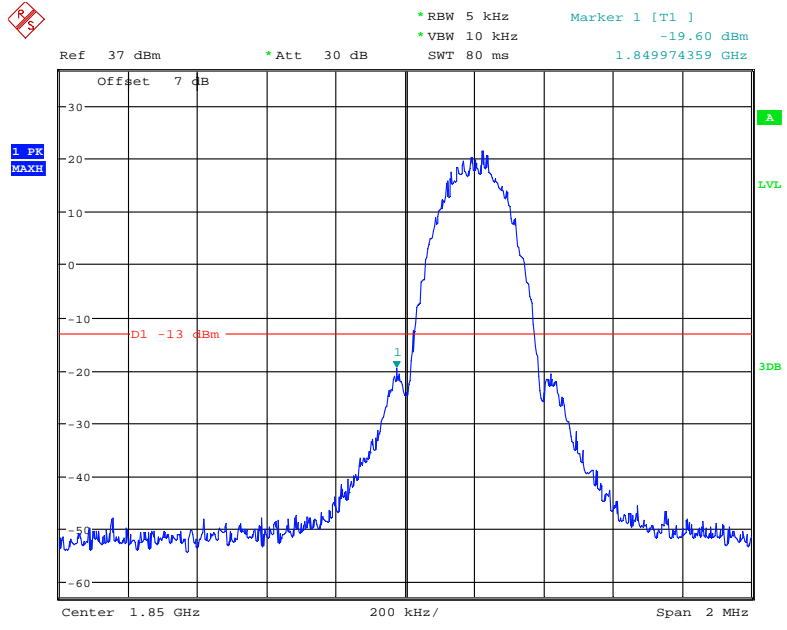

Date: 6.SEP.2021 16:34:05

PCS Band, Right Band Edge for EGPRS (8PSK) Mode

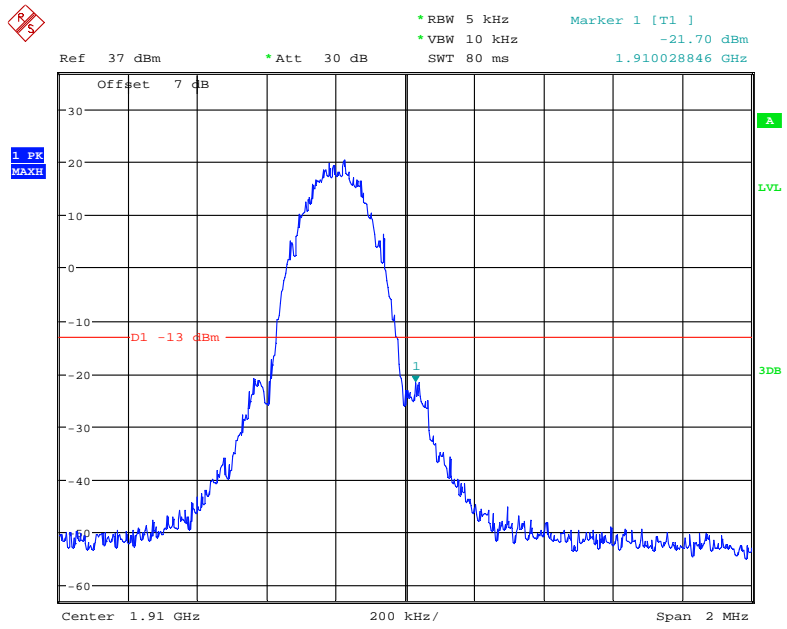

Date: 6.SEP.2021 16:33:04

PCS Band, Left Band Edge for RMC (BPSK) Mode

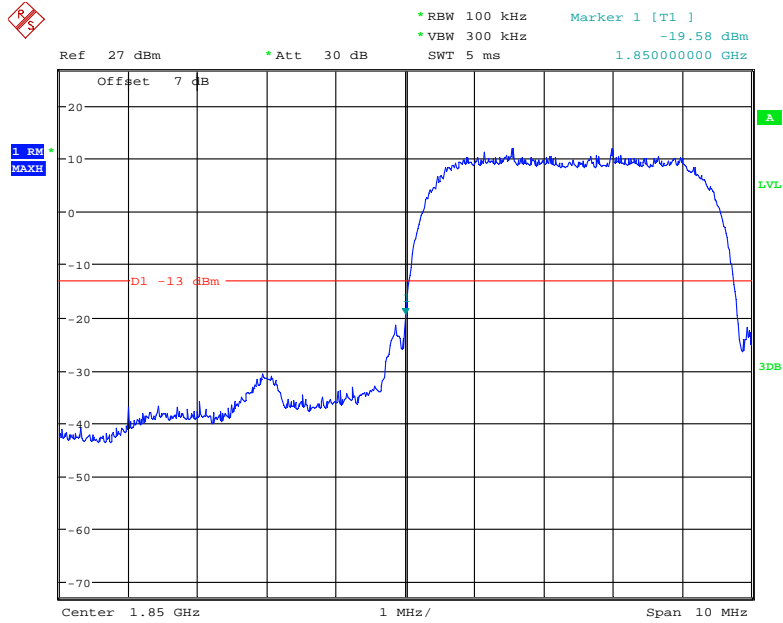

Date: 5.SEP.2021 22:25:05

PCS Band, Right Band Edge for RMC (BPSK) Mode

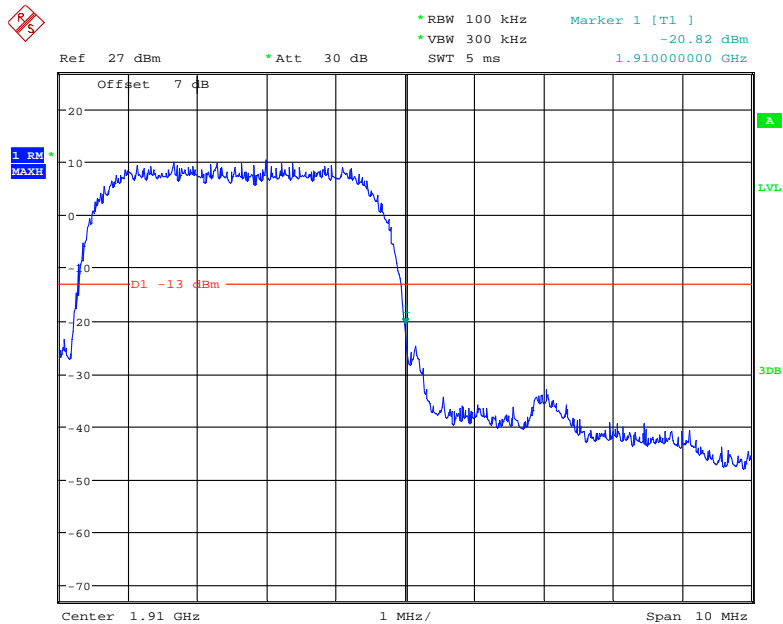

Date: 5.SEP.2021 22:26:50

PCS Band, Left Band Edge for HSDPA (16QAM) Mode

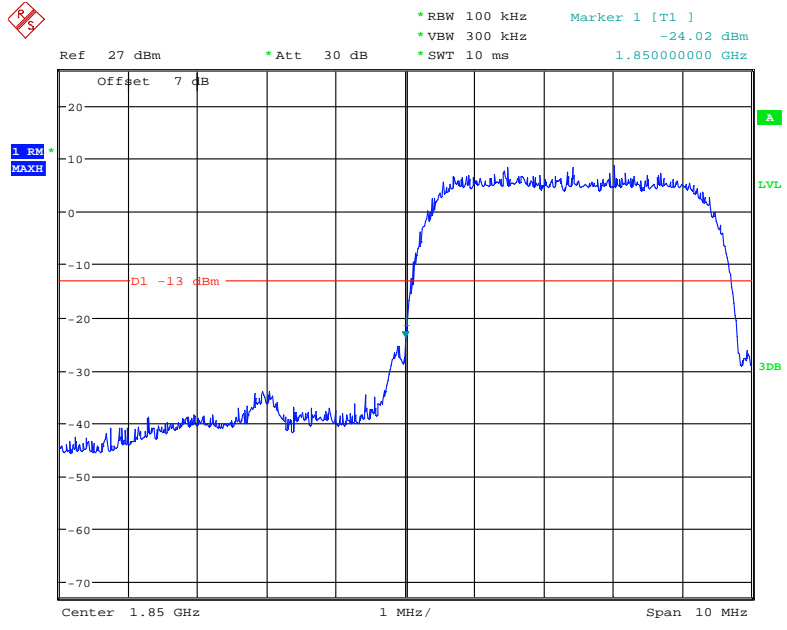

Date: 5.SEP.2021 22:44:21

PCS Band, Right Band Edge for HSDPA (16QAM) Mode

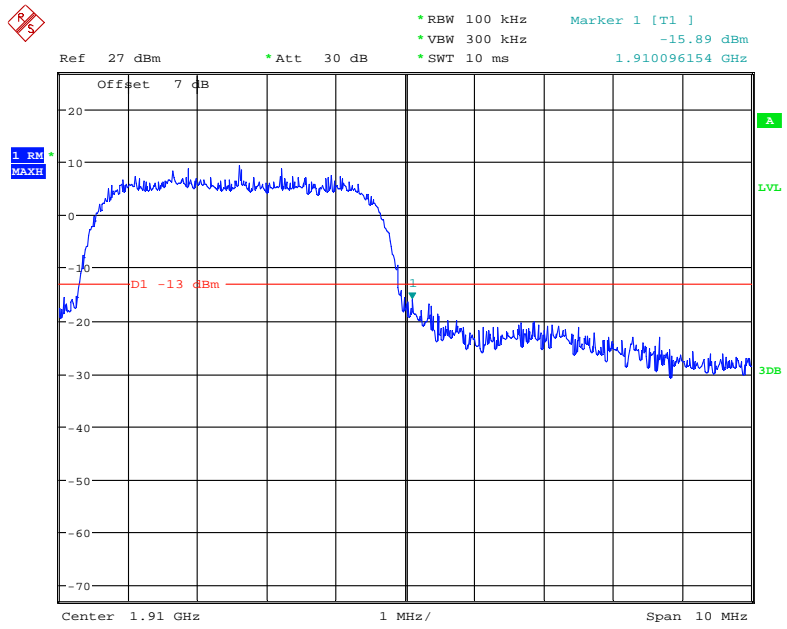

Date: 5.SEP.2021 22:41:35

PCS Band, Left Band Edge for HSUPA (BPSK) Mode

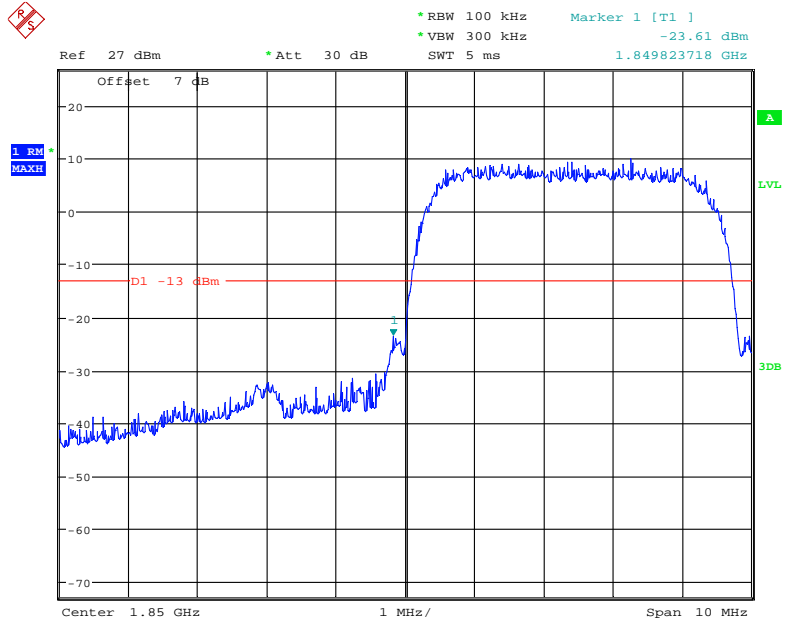

Date: 5.SEP.2021 22:47:35

PCS Band, Right Band Edge for HSUPA (BPSK) Mode

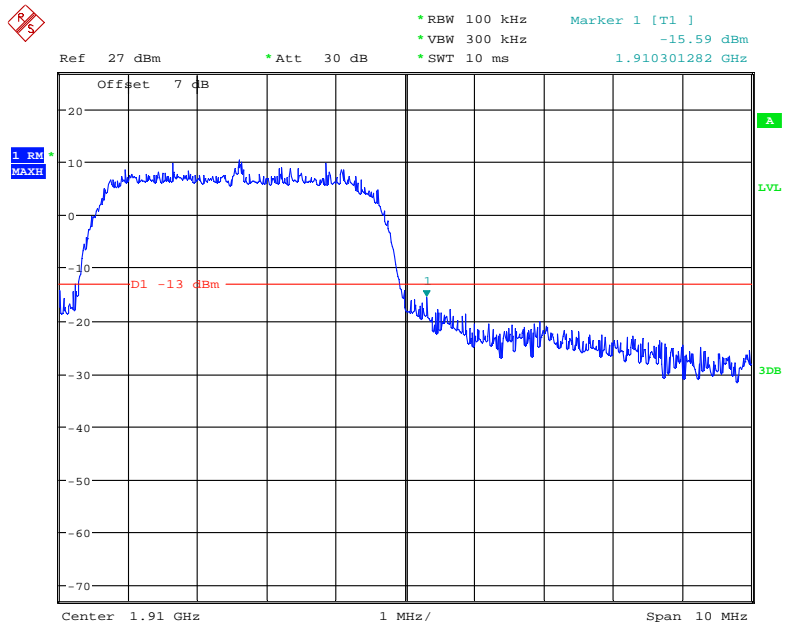

Date: 5.SEP.2021 22:50:15

AWS Band, Left Band Edge for RMC (BPSK) Mode

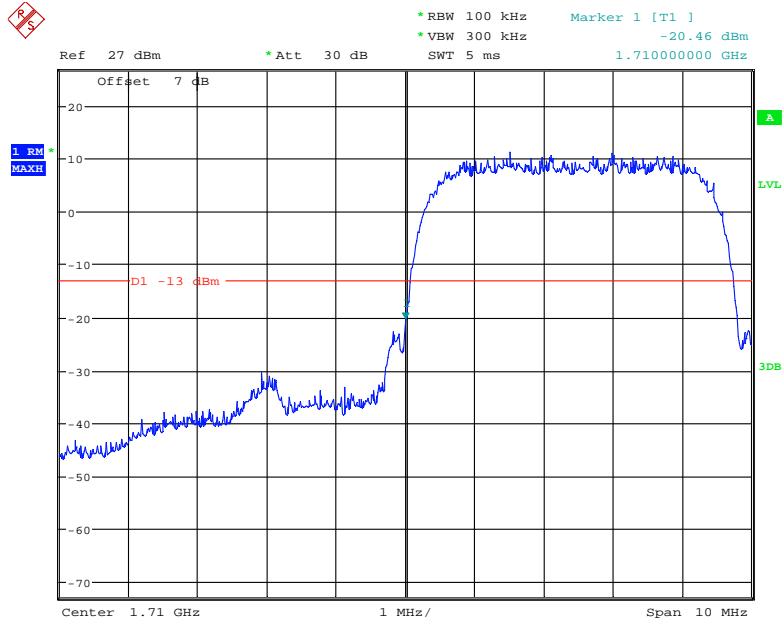

Date: 5.SEP.2021 22:27:33

AWS Band, Right Band Edge for RMC (BPSK) Mode

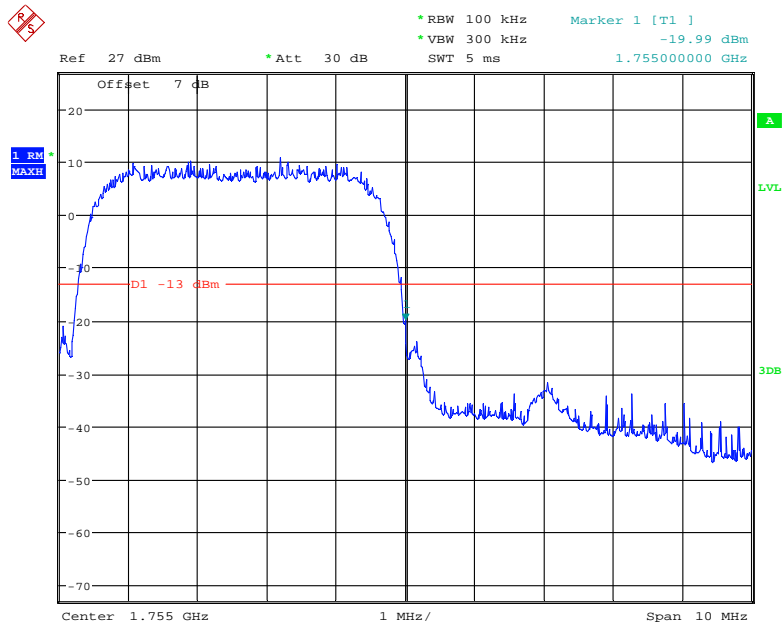

Date: 5.SEP.2021 22:28:35

AWS Band, Left Band Edge for HSDPA (16QAM) Mode

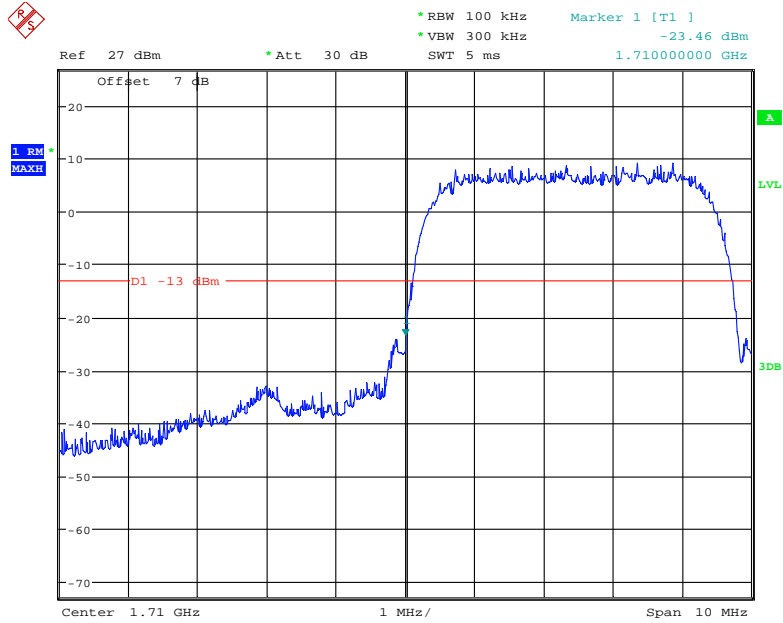

Date: 5.SEP.2021 22:37:59

AWS Band, Right Band Edge for HSDPA (16QAM) Mode

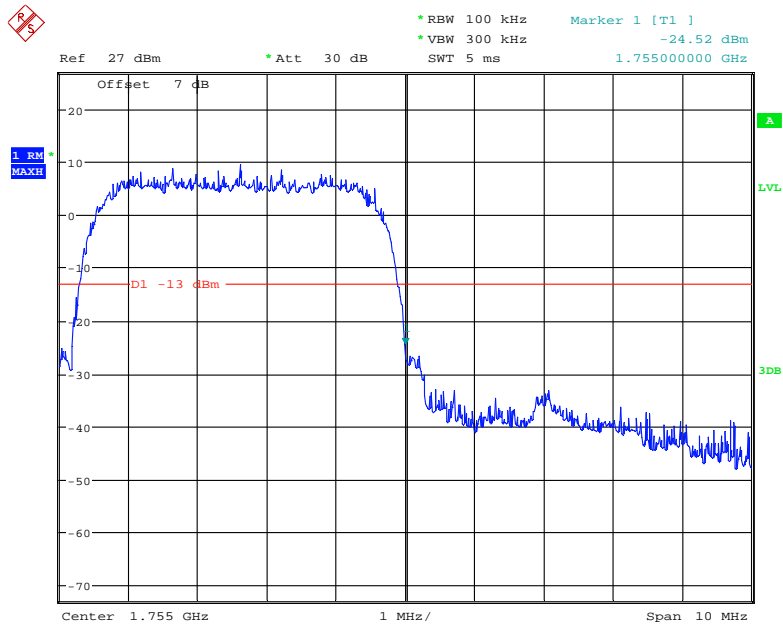

Date: 5.SEP.2021 22:37:10

AWS Band, Left Band Edge for HSUPA (BPSK) Mode

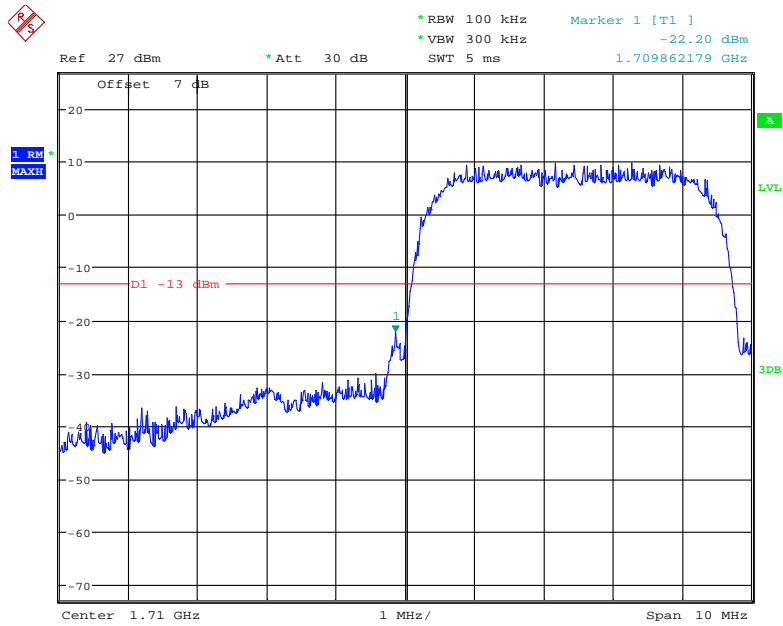

Date: 5.SEP.2021 23:07:12

AWS Band, Right Band Edge for HSUPA (BPSK) Mode

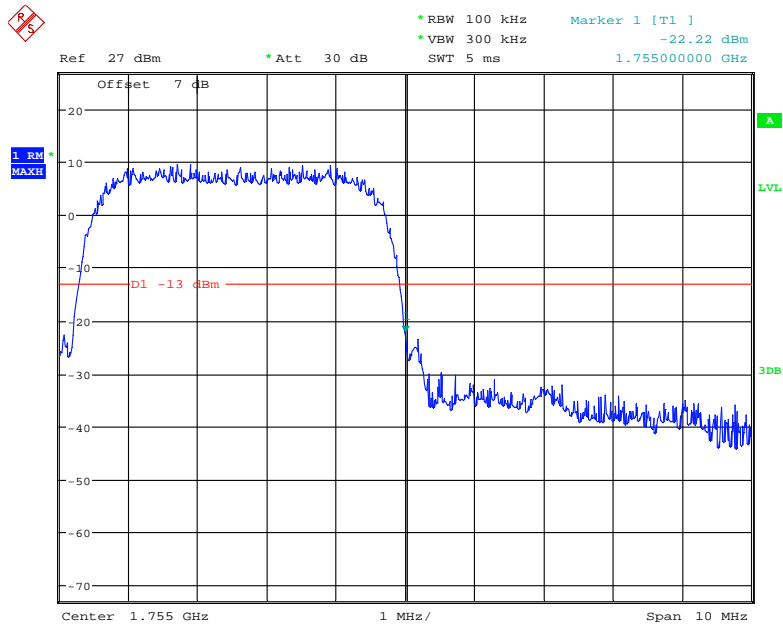

Date: 5.SEP.2021 23:06:14

The test plots of LTE bands please refer to the Appendix C.

FCC § 2.1055; § 22.355; § 24.235; §27.54 - FREQUENCY STABILITY

Applicable Standard

FCC § 2.1055, §22.355, §24.235 and & §27.54.

According to FCC §2.1055, the frequency stability shall be sufficient to ensure that the fundamental emissions stay within the authorized bands of operation.

According to §22.355, the carrier frequency of each transmitter in the Public Mobile Services must be maintained within the tolerances given in Table below:

Frequency Tolerance for Transmitters in the Public Mobile Services

Frequency Range (MHz)	Base, fixed (ppm)	Mobile ≤ 3 watts (ppm)	Mobile > 3 watts (ppm)
25 to 50	20.0	20.0	50.0
50 to 450	5.0	5.0	50.0
450 to 512	2.5	5.0	5.0
821 to 896	1.5	2.5	2.5
928 to 929.	5.0	N/A	N/A
929 to 960.	1.5	N/A	N/A
2110 to 2220	10.0	N/A	N/A

According to §24.235, the frequency stability shall be sufficient to ensure that the fundamental emissions stays within the authorized frequency block.

Test Procedure

Frequency Stability vs. Temperature: The equipment under test was connected to an external DC power supply and the RF output was connected to communication test set via feed-through attenuators. The EUT was placed inside the temperature chamber. The DC leads and RF output cable exited the chamber through an opening made for the purpose.

After the temperature stabilized for approximately 20 minutes, the frequency output was recorded from the communication test set.

Frequency Stability vs. Voltage: For hand carried, battery powered equipment; reduce primary supply voltage to the battery operating end point which shall be specified by the manufacturer.

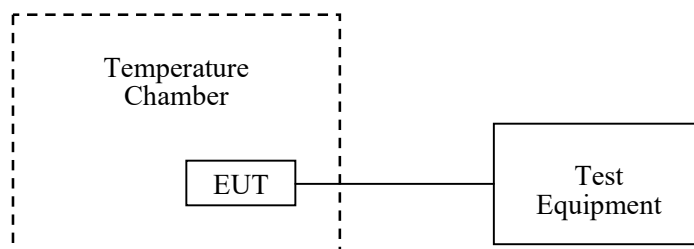

Test Data**Environmental Conditions**

Temperature:	28 °C
Relative Humidity:	56 %
ATM Pressure:	101.0 kPa

The testing was performed by Ting Lü from 2021-09-05 to 2021-09-06.

EUT operation mode: Transmitting

Test Result: Pass

Please refer to the following tables.

Cellular Band (Part 22H)**GSM Mode**

Middle Channel, $f_0=836.6\text{MHz}$				
Temperature (°C)	Voltage Supplied (V_{DC})	Frequency Error (Hz)	Frequency Error (ppm)	Limit (ppm)
-30	NV	-11	-0.0131	2.5
-20		-7	-0.0084	2.5
-10		-5	-0.0060	2.5
0		-6	-0.0072	2.5
10		-2	-0.0024	2.5
20		-3	-0.0036	2.5
30		-4	-0.0048	2.5
40		-2	-0.0024	2.5
50		-1	-0.0012	2.5
20	LV	-2	-0.0024	2.5
	HV	3	0.0036	2.5

EDGE Mode

Middle Channel, $f_0=836.6\text{MHz}$				
Temperature (°C)	Voltage Supplied (V_{DC})	Frequency Error (Hz)	Frequency Error (ppm)	Limit (ppm)
-30	NV	-7	-0.0084	2.5
-20		-4	-0.0048	2.5
-10		-2	-0.0024	2.5
0		-8	-0.0096	2.5
10		-6	-0.0072	2.5
20		-5	-0.0060	2.5
30		-2	-0.0024	2.5
40		-4	-0.0048	2.5
50		-3	-0.0036	2.5
20	LV	-1	-0.0012	2.5
	HV	-4	-0.0048	2.5

WCDMA Mode

Middle Channel, $f_0=836.6\text{MHz}$				
Temperature (°C)	Voltage Supplied (V_{DC})	Frequency Error (Hz)	Frequency Error (ppm)	Limit (ppm)
-30	NV	-9	-0.0108	2.5
-20		-6	-0.0072	2.5
-10		-5	-0.0060	2.5
0		-2	-0.0024	2.5
10		-7	-0.0084	2.5
20		-4	-0.0048	2.5
30		-3	-0.0036	2.5
40		-4	-0.0048	2.5
50		-6	-0.0072	2.5
20		LV	-8	-0.0096
	HV	-9	-0.0108	2.5

PCS Band (Part 24E)**GSM Mode**

Middle Channel, $f_0 = 1880.0$ MHz				
Temperature (°C)	Voltage Supplied (V _{DC})	Frequency Error (Hz)	Frequency Error (ppm)	Result
-30	NV	-5	-0.0027	pass
-20		4	0.0021	pass
-10		2	0.0011	pass
0		-4	-0.0021	pass
10		-2	-0.0011	pass
20		-6	-0.0032	pass
30		-7	-0.0037	pass
40		-6	-0.0032	pass
50		-3	-0.0016	pass
20		LV	-4	-0.0021
	HV	-5	-0.0027	pass

EDGE Mode

Middle Channel, $f_0 = 1880.0$ MHz				
Temperature (°C)	Voltage Supplied (V _{DC})	Frequency Error (Hz)	Frequency Error (ppm)	Result
-30	NV	-2	-0.0011	Pass
-20		-5	-0.0027	Pass
-10		-6	-0.0032	Pass
0		-1	-0.0005	Pass
10		-3	-0.0016	Pass
20		-2	-0.0011	Pass
30		-5	-0.0027	Pass
40		-4	-0.0021	Pass
50		-1	-0.0005	Pass
20		LV	1	0.0005
	HV	2	0.0011	Pass

WCDMA Mode

Middle Channel, $f_0 = 1880.0$ MHz				
Temperature (°C)	Voltage Supplied (V_{DC})	Frequency Error (Hz)	Frequency Error (ppm)	Result
-30	NV	7	0.0037	Pass
-20		10	0.0053	Pass
-10		12	0.0064	Pass
0		6	0.0032	Pass
10		8	0.0043	Pass
20		11	0.0059	Pass
30		13	0.0069	Pass
40		10	0.0053	Pass
50		9	0.0048	Pass
20		LV	7	0.0037
	HV	6	0.0032	Pass

AWS Band (Part 27)

Temperature (°C)	Power Supplied (V_{DC})	F_L (MHz)	F_H (MHz)	F_L Limit (MHz)	F_H Limit (MHz)
-30	NV	1710.3191	1754.6817	1710	1755
-20		1710.3131	1754.6828	1710	1755
-10		1710.3176	1754.6840	1710	1755
0		1710.3182	1754.6833	1710	1755
10		1710.3148	1754.6832	1710	1755
20		1710.3157	1754.6877	1710	1755
30		1710.3148	1754.6817	1710	1755
40		1710.3196	1754.6815	1710	1755
50		1710.3130	1754.6862	1710	1755
20		LV	1710.3123	1754.6870	1710
	HV	1710.3151	1754.6869	1710	1755

LTE:
QPSK:

Band 2:

10.0 MHz Middle Channel, $f_0=1880\text{MHz}$				
Temperature (°C)	Voltage Supplied (V _{DC})	Frequency Error (Hz)	Frequency Error (ppm)	Result
-30	NV	-7.08	-0.0038	Pass
-20		-9.97	-0.0053	Pass
-10		-6.13	-0.0033	Pass
0		6.17	0.0033	Pass
10		7.92	0.0042	Pass
20		6.46	0.0034	Pass
30		-6.52	-0.0035	Pass
40		7.18	0.0038	Pass
50		-9.69	-0.0052	Pass
20		LV	-8.17	-0.0043
	HV	-7.05	-0.0038	Pass

Band 4:

10 MHz Bandwidth					
Temperature (°C)	Power Supplied (V _{DC})	F _L (MHz)	F _H (MHz)	F _L Limit (MHz)	F _H Limit (MHz)
-30	NV	1710.5201	1754.4847	1710	1755
-20		1710.5179	1754.4853	1710	1755
-10		1710.5190	1754.4810	1710	1755
0		1710.5157	1754.4802	1710	1755
10		1710.5186	1754.4827	1710	1755
20		1710.5227	1754.4802	1710	1755
30		1710.5231	1754.4810	1710	1755
40		1710.5169	1754.4839	1710	1755
50		1710.5174	1754.4797	1710	1755
20		LV	1710.5179	1754.4867	1710
	HV	1710.5172	1754.4804	1710	1755

Band 5:

10.0 MHz Middle Channel, $f_0=836.5\text{MHz}$				
Temperature (°C)	Voltage Supplied (V _{DC})	Frequency Error (Hz)	Frequency Error (ppm)	Limit (ppm)
-30	NV	-5.94	-0.0071	2.5
-20		9.11	0.0109	2.5
-10		8.51	0.0102	2.5
0		-7.15	-0.0085	2.5
10		-5.29	-0.0063	2.5
20		7.24	0.0087	2.5
30		-5.81	-0.0069	2.5
40		5.59	0.0067	2.5
50		6.87	0.0082	2.5
20		LV	9.94	0.0119
	HV	9.99	0.0119	2.5

Band 7:

10 MHz Bandwidth					
Temperature (°C)	Power Supplied (V _{DC})	F _L (MHz)	F _H (MHz)	F _L Limit (MHz)	F _H Limit (MHz)
-30	NV	2500.5113	2569.4900	2500	2570
-20		2500.5116	2569.4888	2500	2570
-10		2500.5180	2569.4850	2500	2570
0		2500.5162	2569.4837	2500	2570
10		2500.5114	2569.4853	2500	2570
20		2500.5128	2569.4906	2500	2570
30		2500.5126	2569.4871	2500	2570
40		2500.5131	2569.4908	2500	2570
50		2500.5164	2569.4892	2500	2570
20		LV	2500.5182	2569.4842	2500
	HV	2500.5176	2569.4862	2500	2570

Band 17:

10 MHz Bandwidth					
Temperature (°C)	Power Supplied (V _{DC})	F _L (MHz)	F _H (MHz)	F _L Limit (MHz)	F _H Limit (MHz)
-30	NV	704.5097	715.4813	704	716
-20		704.5126	715.4820	704	716
-10		704.5133	715.4854	704	716
0		704.5157	715.4861	704	716
10		704.5126	715.4812	704	716
20		704.5135	715.4799	704	716
30		704.5123	715.4831	704	716
40		704.5111	715.4846	704	716
50		704.5162	715.4824	704	716
20		LV	704.5105	715.4792	704
	HV	704.5135	715.4795	704	716

Band 38

10 MHz Bandwidth					
Temperature (°C)	Power Supplied (V _{DC})	F _L (MHz)	F _H (MHz)	F _L Limit (MHz)	F _H Limit (MHz)
-30	NV	2570.5130	2619.4893	2570	2620
-20		2570.5110	2619.4858	2570	2620
-10		2570.5114	2619.4845	2570	2620
0		2570.5157	2619.4838	2570	2620
10		2570.5108	2619.4906	2570	2620
20		2570.5182	2619.4899	2570	2620
30		2570.5105	2619.4912	2570	2620
40		2570.5107	2619.4915	2570	2620
50		2570.5116	2619.4906	2570	2620
20		LV	2570.5162	2619.4909	2570
	HV	2570.5108	2619.4862	2570	2620

Band 41

10 MHz Bandwidth					
Temperature (°C)	Power Supplied (V _{DC})	F _L (MHz)	F _H (MHz)	F _L Limit (MHz)	F _H Limit (MHz)
-30	NV	2535.5135	2654.4906	2535	2655
-20		2535.5134	2654.4915	2535	2655
-10		2535.5154	2654.4865	2535	2655
0		2535.5118	2654.4891	2535	2655
10		2535.5128	2654.4866	2535	2655
20		2535.5143	2654.4847	2535	2655
30		2535.5141	2654.4857	2535	2655
40		2535.5141	2654.4861	2535	2655
50		2535.5101	2654.4865	2535	2655
20	LV	2535.5104	2654.4889	2535	2655
	HV	2535.5126	2654.4863	2535	2655

Note: the frequency range 2535-2655MHz was declared by applicant.

Band 66

10 MHz Bandwidth					
Temperature (°C)	Power Supplied (V _{DC})	F _L (MHz)	F _H (MHz)	F _L Limit (MHz)	F _H Limit (MHz)
-30	NV	1710.5123	1779.4857	1710	1780
-20		1710.5158	1779.4863	1710	1780
-10		1710.5150	1779.4815	1710	1780
0		1710.5149	1779.4823	1710	1780
10		1710.5146	1779.4837	1710	1780
20		1710.5137	1779.4871	1710	1780
30		1710.5188	1779.4821	1710	1780
40		1710.5122	1779.4855	1710	1780
50		1710.5163	1779.4871	1710	1780
20	LV	1710.5189	1779.4819	1710	1780
	HV	1710.5149	1779.4861	1710	1780

16QAM:**Band 2:**

10.0 MHz Middle Channel, $f_0 = 1880\text{MHz}$				
Temperature (°C)	Voltage Supplied (V _{DC})	Frequency Error (Hz)	Frequency Error (ppm)	Result
-30	NV	-8.10	-0.0043	Pass
-20		-6.68	-0.0036	Pass
-10		9.77	0.0052	Pass
0		-7.62	-0.0041	Pass
10		-9.91	-0.0053	Pass
20		-9.82	-0.0052	Pass
30		-6.68	-0.0036	Pass
40		-8.85	-0.0047	Pass
50		5.67	0.0030	Pass
20		LV	6.05	0.0032
	HV	7.52	0.0040	Pass

Band 4:

10 MHz Bandwidth					
Temperature (°C)	Power Supplied (V _{DC})	F _L (MHz)	F _H (MHz)	F _L Limit (MHz)	F _H Limit (MHz)
-30	NV	1710.5210	1754.4844	1710	1755
-20		1710.5190	1754.4835	1710	1755
-10		1710.5223	1754.4840	1710	1755
0		1710.5173	1754.4808	1710	1755
10		1710.5161	1754.4822	1710	1755
20		1710.5217	1754.4821	1710	1755
30		1710.5236	1754.4876	1710	1755
40		1710.5222	1754.4857	1710	1755
50		1710.5157	1754.4805	1710	1755
20		LV	1710.5229	1754.4803	1710
	HV	1710.5164	1754.4809	1710	1755

Band 5:

10.0 MHz Middle Channel, $f_0=836.5\text{MHz}$				
Temperature (°C)	Voltage Supplied (V_{DC})	Frequency Error (Hz)	Frequency Error (ppm)	Limit (ppm)
-30	NV	-9.86	-0.0118	2.5
-20		6.80	0.0081	2.5
-10		-9.52	-0.0114	2.5
0		-8.15	-0.0097	2.5
10		-8.88	-0.0106	2.5
20		-9.82	-0.0117	2.5
30		8.38	0.0100	2.5
40		6.75	0.0081	2.5
50		-5.89	-0.0070	2.5
20	LV	8.98	0.0107	2.5
	HV	-7.83	-0.0094	2.5

Band 7:

10 MHz Bandwidth					
Temperature (°C)	Power Supplied (V_{DC})	F_L (MHz)	F_H (MHz)	F_L Limit (MHz)	F_H Limit (MHz)
-30	NV	2500.5169	2569.4859	2500	2570
-20		2500.5112	2569.4895	2500	2570
-10		2500.5137	2569.4833	2500	2570
0		2500.5139	2569.4899	2500	2570
10		2500.5133	2569.4863	2500	2570
20		2500.5153	2569.4861	2500	2570
30		2500.5132	2569.4845	2500	2570
40		2500.5111	2569.4891	2500	2570
50		2500.5135	2569.4845	2500	2570
20	LV	2500.5123	2569.4837	2500	2570
	HV	2500.5134	2569.4910	2500	2570

Band 17:

10 MHz Bandwidth					
Temperature (°C)	Power Supplied (V _{DC})	F _L (MHz)	F _H (MHz)	F _L Limit (MHz)	F _H Limit (MHz)
-30	NV	704.5153	715.4809	704	716
-20		704.5138	715.4830	704	716
-10		704.5142	715.4839	704	716
0		704.5118	715.4789	704	716
10		704.5174	715.4804	704	716
20		704.5156	715.4846	704	716
30		704.5131	715.4801	704	716
40		704.5160	715.4788	704	716
50		704.5156	715.4831	704	716
20	LV	704.5118	715.4785	704	716
	HV	704.5148	715.4823	704	716

Band 38

10 MHz Bandwidth					
Temperature (°C)	Power Supplied (V _{DC})	F _L (MHz)	F _H (MHz)	F _L Limit (MHz)	F _H Limit (MHz)
-30	NV	2570.5127	2619.4890	2570	2620
-20		2570.5182	2619.4877	2570	2620
-10		2570.5134	2619.4898	2570	2620
0		2570.5154	2619.4877	2570	2620
10		2570.5133	2619.4867	2570	2620
20		2570.5111	2619.4862	2570	2620
30		2570.5134	2619.4888	2570	2620
40		2570.5112	2619.4895	2570	2620
50		2570.5162	2619.4914	2570	2620
20	LV	2570.5157	2619.4855	2570	2620
	HV	2570.5131	2619.4911	2570	2620

Band 41

10 MHz Bandwidth					
Temperature (°C)	Power Supplied (V _{DC})	F _L (MHz)	F _H (MHz)	F _L Limit (MHz)	F _H Limit (MHz)
-30	NV	2535.5158	2654.4889	2535	2655
-20		2535.5147	2654.4894	2535	2655
-10		2535.5175	2654.4897	2535	2655
0		2535.5169	2654.4905	2535	2655
10		2535.5119	2654.4865	2535	2655
20		2535.5102	2654.4913	2535	2655
30		2535.5150	2654.4857	2535	2655
40		2535.5125	2654.4845	2535	2655
50		2535.5145	2654.4882	2535	2655
20		LV	2535.5147	2654.4869	2535
	HV	2535.5150	2654.4846	2535	2655

Note: the frequency range 2535-2655MHz was declared by applicant.

Band 66

10 MHz Bandwidth					
Temperature (°C)	Power Supplied (V _{DC})	F _L (MHz)	F _H (MHz)	F _L Limit (MHz)	F _H Limit (MHz)
-30	NV	1710.5130	1779.4872	1710	1780
-20		1710.5185	1779.4851	1710	1780
-10		1710.5112	1779.4866	1710	1780
0		1710.5178	1779.4870	1710	1780
10		1710.5138	1779.4856	1710	1780
20		1710.5135	1779.4860	1710	1780
30		1710.5164	1779.4855	1710	1780
40		1710.5168	1779.4857	1710	1780
50		1710.5111	1779.4843	1710	1780
20		LV	1710.5108	1779.4844	1710
	HV	1710.5173	1779.4843	1710	1780

***** END OF REPORT *****