



FCC PART 27
FCC PART 22H, PART 24E
TEST REPORT

For

TECNO MOBILE LIMITED

FLAT 39 8/F BLOCK D WAH LOK INDUSTRIAL CENTRE 31-35 SHAN MEI STREET
FOTAN NT Hong Kong

FCC ID: 2ADYY-KG5

Report Type: Original Report	Product Type: Mobile Phone
Report Number: SZ1210825-36524E-RF-00D	
Report Date: 2021-11-08	
Reviewed By: RF Engineer	Candy Li 
Prepared By: Shenzhen Accurate Technology Co., Ltd. 1/F., Building A, Changyuan New Material Port, Science & Industry Park, Nanshan District, Shenzhen, Guangdong, P.R. China Tel: (0755) 26503290 Fax: (0755) 26503396 Http://www.atc-lab.com	

Note: This report may contain data that are not covered by the A2LA accreditation and are marked with an asterisk “★”.

Shenzhen Accurate Technology Co., Ltd. is not responsible for the authenticity of any test data provided by the applicant. Data included from the applicant that may affect test results are marked with an asterisk ‘*’. Customer model name, addresses, names, trademarks etc. are not considered data.

This report cannot be reproduced except in full, without prior written approval of the Company. Unless otherwise stated the results shown in this test report refer only to the sample(s) tested. This report is valid only with a valid digital signature. The digital signature may be available only under the Adobe software above version 7.0.

TABLE OF CONTENTS

GENERAL INFORMATION	3
PRODUCT DESCRIPTION FOR EQUIPMENT UNDER TEST (EUT).....	3
OBJECTIVE	3
TEST METHODOLOGY	4
MEASUREMENT UNCERTAINTY.....	4
SYSTEM TEST CONFIGURATION	5
DESCRIPTION OF TEST CONFIGURATION	5
EQUIPMENT MODIFICATIONS	6
SUPPORT EQUIPMENT LIST AND DETAILS	6
SUPPORT CABLE DESCRIPTION	6
BLOCK DIAGRAM OF TEST SETUP	7
SUMMARY OF TEST RESULTS	8
TEST EQUIPMENT LIST	9
FCC §1.1307(B) & §2.1093 - RF EXPOSURE INFORMATION	11
APPLICABLE STANDARD	11
TEST RESULT	11
FCC §2.1047 - MODULATION CHARACTERISTIC	12
FCC § 2.1046, § 22.913 (A) & § 24.232 (C); §27.50 (C) (D) (H) - RF OUTPUT POWER	13
APPLICABLE STANDARD	13
TEST PROCEDURE	13
TEST DATA	13
FCC §2.1049, §22.917, §22.905 & §24.238 & §27.53 - OCCUPIED BANDWIDTH	45
APPLICABLE STANDARD	45
TEST PROCEDURE	45
TEST DATA	45
FCC §2.1051, §22.917(A) & §24.238(A); §27.53 - SPURIOUS EMISSIONS AT ANTENNA TERMINALS	72
APPLICABLE STANDARD	72
TEST PROCEDURE	72
TEST DATA	72
FCC § 2.1053; § 22.917 (A);§ 24.238 (A); §27.53 SPURIOUS RADIATED EMISSIONS	93
APPLICABLE STANDARD	93
TEST PROCEDURE	93
TEST DATA	93
FCC § 22.917 (A);§ 24.238 (A); §27.53(C) (H)(M) - BAND EDGES	102
APPLICABLE STANDARD	102
TEST PROCEDURE	102
TEST DATA	102
FCC § 2.1055; § 22.355; § 24.235; §27.54 - FREQUENCY STABILITY	116
APPLICABLE STANDARD	116
TEST PROCEDURE	116
TEST DATA	117

GENERAL INFORMATION

Product Description for Equipment under Test (EUT)

Product	Mobile Phone
Tested Model	KG5
Frequency Range	GSM 850: 824-849MHz(TX); 869-894MHz(RX) PCS 1900: 1850-1910MHz(TX); 1930-1990MHz(RX) WCDMA Band 2: 1850-1910MHz(TX); 1930-1990MHz(RX) WCDMA Band 4: 1710-1755MHz(TX); 2110-2155MHz(RX) WCDMA Band 5: 824-849MHz(TX); 869-894MHz(RX) LTE Band 2: 1850-1910MHz(TX); 1930-1990MHz(RX) LTE Band 4: 1710-1755MHz(TX); 2110-2155MHz(RX) LTE Band 5: 824-849MHz(TX); 869-894MHz(RX) LTE Band 7: 2500-2570MHz(TX); 2620-2690MHz(RX) LTE Band 17: 704-716MHz(TX); 734-746MHz(RX) LTE Band 38: 2570-2620MHz(TX/RX) LTE Band 41: 2535-2655MHz(TX/RX) LTE Band 66: 1710-1780MHz(TX); 2110-2180MHz(RX)
Modulation Technique	2G: GMSK, 8PSK 3G: BPSK, QPSK, 16QAM 4G: QPSK, 16QAM
Antenna Specification*	GSM850/WCDMA Band 5/LTE Band 5: -2.9dBi PCS1900/WCDMA Band 2/ LTE Band 2: -0.9dBi WCDMA Band 4/ LTE Band 4/ LTE Band 66: -2.4dBi LTE Band 7/LTE Band 38//LTE Band 41: -0.1dBi LTE Band 17: -3.0dBi (provided by the applicant)
Voltage Range	DC 3.85V from battery or DC 5.0 from adapter
Date of Test	2021-08-31 to 2021-11-08
Sample serial number	SZ1210825-36524E-RF-S1
Received date	2021-08-25
Sample/EUT Status	Good condition
Normal/Extreme Condition	L.V.: Low Voltage 3.45V _{DC} N.V.: Normal Voltage 3.85V _{DC} H.V.: High Voltage 4.4V _{DC} Note: The extreme condition was declared by the applicant
Adapter information	Model: U100TSA Input: AC 100-240V ~ 50/60Hz, 0.3A Output: DC 5.0V, 2.0A

Objective

This test report is in accordance with Part 2-Subpart J, Part 22-Subpart H and Part 24-Subpart E and Subpart 27 of the Federal Communication Commissions rules.

The objective is to determine the compliance of the EUT with FCC rules for output power, modulation characteristic, occupied bandwidth, and spurious emission at antenna terminal, spurious radiated emission, frequency stability and band edge.

Test Methodology

All tests and measurements indicated in this document were performed in accordance with the Code of Federal Regulations Title 47 Part 2-Subpart J as well as the following parts:

Part 22 Subpart H - Public Mobile Services
 Part 24 Subpart E - Personal Communication Services
 Part 27 – Miscellaneous wireless communications services

ANSI C63.26-2015: American National Standard for Compliance Testing of Transmitters Used in Licensed Radio Services

All emissions measurement was performed at Shenzhen Accurate Technology Co., Ltd. The radiated testing was performed at an antenna-to-EUT distance of 3 meters.
 Each test item follows test standards and with no deviation.

Measurement Uncertainty

Parameter		Uncertainty
Occupied Channel Bandwidth		±5%
RF output power, conducted		±0.73dB
Unwanted Emission, conducted		±1.6dB
RF Frequency		±0.082*10 ⁻⁷
Emissions, Radiated	30MHz - 1GHz	±4.28dB
	1GHz - 18GHz	±4.98dB
	18GHz - 26.5GHz	±5.06dB
Temperature		±1°C
Humidity		±6%
Supply voltages		±0.4%

Note: The extended uncertainty given in this report is obtained by combining the standard uncertainty times the coverage factor K with the 95% confidence interval. Otherwise required by the applicant or Product Regulations, Decision Rule in this report did not consider the uncertainty.

Test Facility

The test site used by Shenzhen Accurate Technology Co., Ltd. to collect test data is located on the 1/F., Building A, Changyuan New Material Port, Science & Industry Park, Nanshan District, Shenzhen, Guangdong, P.R. China.

The test site has been approved by the FCC under the KDB 974614 D01 and is listed in the FCC Public Access Link (PAL) database, FCC Registration No.: 708358, the FCC Designation No.: CN1189. Accredited by American Association for Laboratory Accreditation (A2LA) The Certificate Number is 429 7.01.

Listed by Innovation, Science and Economic Development Canada (ISED), the Registration Number is 5077A.

SYSTEM TEST CONFIGURATION

Description of Test Configuration

The final qualification test was performed with the EUT operating at normal mode.

Test was performed as below table:

Frequency band	Bandwidth (MHz)	Test Frequency(MHz)		
		Low	Middle	High
GSM850	0.25	824.2	836.6	848.8
DCS1900	0.25	1850.2	1880	1909.8
WCDMA B2	4.2	1852.4	1880	1907.6
WCDMA B4	4.2	1712.4	1732.6	1752.6
WCDMA B5	4.2	826.4	836.6	846.6
LTE B2	1.4	1850.7	1880	1909.3
	3	1851.5	1880	1908.5
	5	1852.5	1880	1907.5
	10	1855	1880	1905
	15	1857.5	1880	1902.5
	20	1860	1880	1900
LTE B4	1.4	1710.7	1732.5	1754.3
	3	1711.5	1732.5	1753.5
	5	1712.5	1732.5	1752.5
	10	1715	1732.5	1750
	15	1717.5	1732.5	1747.5
	20	1720	1732.5	1745
LTE B5	1.4	824.7	836.5	848.3
	3	825.5	836.5	847.5
	5	826.5	836.5	846.5
	10	829	836.5	844
LTE B7	5	2502.5	2535	2567.5
	10	2505	2535	2565
	15	2507.5	2535	2562.5
	20	2510	2535	2560
LTE B17	5	706.5	710	713.5
	10	709	710	711

Frequency band	Bandwidth (MHz)	Test Frequency(MHz)		
		Low	Middle	High
LTE B38	5	2572.5	2595	2617.5
	10	2575	2595	2615
	15	2577.5	2595	2612.5
	20	2580	2595	2610
LTE B41	5	2537.5	2595	2652.5
	10	2540	2595	2650
	15	2542.5	2595	2647.5
	20	2545	2595	2645
LTE B66	1.4	1710.7	1745	1779.3
	3	1711.5	1745	1778.5
	5	1712.5	1745	1777.5
	10	1715	1745	1775
	15	1717.5	1745	1772.5
	20	1720	1745	1770

Equipment Modifications

No modification was made to the EUT.

Support Equipment List and Details

Manufacturer	Description	Model	Serial Number
Rohde & Schwarz	Wideband Radio Communication Tester	CMW500	154606

Support Cable Description

Cable Description	Length (m)	From / Port	To
Un-Shielded Un-Detachable AC Cable	1.2	AC Power	CMW500

Block Diagram of Test Setup

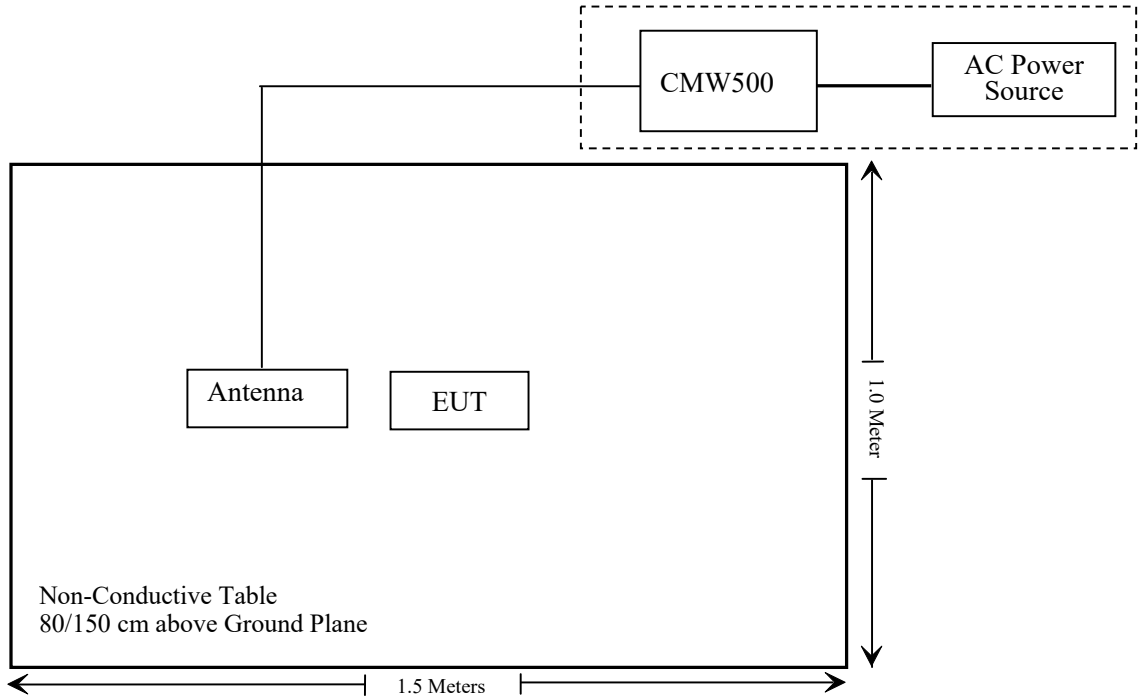

SUMMARY OF TEST RESULTS

FCC Rules	Description of Test	Result
§ 1.1307 , §2.1093	RF Exposure (SAR)	Compliant*
§2.1046; § 22.913 (a); § 24.232 (c); §27.50 (c) (d) (h)	RF Output Power	Compliant
§ 2.1047	Modulation Characteristics	Not Applicable
§ 2.1049; § 22.905; § 22.917; § 24.238; §27.53	Occupied Bandwidth	Compliant
§ 2.1051; § 22.917 (a); § 24.238 (a); §27.53	Spurious Emissions at Antenna Terminal	Compliant
§ 2.1053; § 22.917 (a); § 24.238 (a); §27.53	Field Strength of Spurious Radiation	Compliant
§ 22.917 (a); § 24.238 (a); §27.53(c)(h) (m)	Band Edge	Compliant
§ 2.1055; § 22.355; § 24.235; §27.54;	Frequency stability	Compliant

Note: * Please refer to SAR report released by ATC, report number: SZ1210825-36524E-SA.

TEST EQUIPMENT LIST

Manufacturer	Description	Model	Serial Number	Calibration Date	Calibration Due Date
Radiated Emission Test					
Rohde& Schwarz	Test Receiver	ESR	101817	2020/12/24	2021/12/23
Rohde&Schwarz	Spectrum Analyzer	FSV40	101495	2020/12/24	2021/12/23
SONOMA INSTRUMENT	Amplifier	310 N	186131	2020/12/25	2021/12/24
A.H. Systems, inc.	Preamplifier	PAM-0118P	531	2021/07/08	2022/07/07
Quinstar	Amplifier	QLW-18405536-J0	15964001002	2020/11/28	2021/11/27
Anritsu Corp	50 Coaxial Switch	MP59B	6100237248	2020/12/25	2021/12/24
Schwarzbeck	Bilog Antenna	VULB9163	9163-194	2020/01/05	2023/01/04
Schwarzbeck	Bilog Antenna	VULB9163	9163-323	2020/01/05	2023/01/04
Schwarzbeck	Horn Antenna	BBHA9120D	9120D-655	2020/01/05	2023/01/04
Schwarzbeck	Horn Antenna	BBHA9120D	9120D-1067	2020/01/05	2023/01/04
PASTERNAK	Horn Antenn	PE9852/2F-20	1120	2020/01/05	2023/01/04
PASTERNAK	Horn Antenn	PE9852/2F-20	1120	2020/01/05	2023/01/04
OREGON SCIENTIFIC	Temperature & Humidity Meter	JB913R	GZ-WS004	2020/01/02	2023/01/01
Unknown	RF Coaxial Cable	N-5m	No.3	2020/12/25	2021/12/24
Unknown	RF Coaxial Cable	N-5m	No.4	2020/12/25	2021/12/24
Unknown	RF Coaxial Cable	N-1m	No.5	2020/12/25	2021/12/24
Unknown	RF Coaxial Cable	N-1m	No.6	2020/12/25	2021/12/24
Wainwright	High Pass Filter	WHKX3.6/18G-10SS	5	2020/12/25	2021/12/24
CD	High Pass Filter	HPM-1.2/18G-60	110	2020/12/25	2021/12/24
Anritsu	Signal Generator	68369B	004114	2021/7/31	2022/7/30

Manufacturer	Description	Model	Serial Number	Calibration Date	Calibration Due Date
RF Conducted Test					
Rohde & Schwarz	Spectrum Analyzer	FSV-40	101495	2020/12/24	2021/12/23
Rohde & Schwarz	Open Switch and Control Unit	OSP120 + OSP-B157	101244 + 100866	2020/12/24	2021/12/23
Rohde & Schwarz	Spectrum Analyzer	FSU26	200982	2021/07/06	2022/07/05
Rohde & Schwarz	Wideband Radio Communication Tester	CMW500	154606	2020/12/25	2021/12/24
Gongwen	Temperature & Humidity Chamber	HSD-500	109	2020/12/25	2021/12/24

* **Statement of Traceability:** Shenzhen Accurate Technology Co., Ltd. attests that all calibrations have been performed in accordance to requirements that traceable to National Primary Standards and International System of Units (SI)

FCC §1.1307(b) & §2.1093 - RF EXPOSURE INFORMATION

Applicable Standard

FCC§1.1310 and §2.1093.

Test Result

Compliance, please refer to the SAR report: SZ1210825-36524E-SA.

FCC §2.1047 - MODULATION CHARACTERISTIC

According to FCC § 2.1047(d), Part 22H & 24E & 27 there is no specific requirement for digital modulation, therefore modulation characteristic is not presented.

FCC § 2.1046, § 22.913 (a) & § 24.232 (c); §27.50 (c) (d) (h) - RF OUTPUT POWER

Applicable Standard

According to FCC §2.1046 and §22.913 (a), the ERP of mobile transmitters and auxiliary test transmitters must not exceed 7 watts.

According to FCC §2.1046 and §24.232 (C), mobile and portable stations are limited to 2 watts EIRP and the equipment must employ a means for limiting power to the minimum necessary for successful communications.

The peak-to-average power ratio (PAPR) of the transmitter output power must not exceed 13 dB.

According to §27.50(c), Portable stations (hand-held devices) in the 600 MHz uplink band and the 698-746 MHz band, and fixed and mobile stations in the 600 MHz uplink band are limited to 3 watts ERP.

According to §27.50(d), the maximum EIRP must not exceed 1Watts (30dBm) for 1710-1780MHz.

According to §27.50(h), the maximum EIRP must not exceed 2Watts (33dBm) for 2500-2570MHz & 2496-2690MHz.

Test Procedure

Conducted method:

The RF output of the transmitter was connected to the CMW500 through sufficient attenuation.

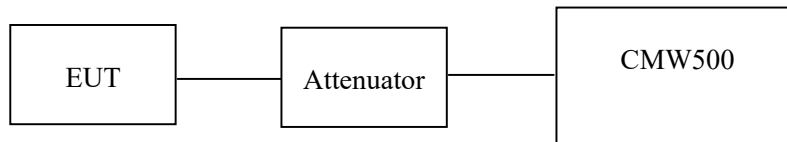

Test Data

Environmental Conditions

Temperature:	27 °C
Relative Humidity:	58 %
ATM Pressure:	101.0 kPa

The testing was performed by Ting Lv from 2021-09-06 to 2021-09-10.

Conducted Power**Cellular Band (Part 22H)**

Mode	Channel	Frequency (MHz)	Average Output Power (dBm)	ERP (dBm)	Limit (dBm)
GSM	128	824.2	33.58	28.53	38.45
	190	836.6	33.65	28.60	38.45
	251	848.8	33.50	28.45	38.45

Mode	Channel	Frequency (MHz)	Average Output Power (dBm)				ERP(dBm)				Limit (dBm)
			1 slot	2 slots	3 slots	4 slots	1 slot	2 slots	3 slots	4 slots	
GPRS	128	824.2	33.64	32.50	30.44	29.24	28.59	27.45	25.39	24.19	38.45
	190	836.6	33.70	32.49	30.43	29.30	28.65	27.44	25.38	24.25	38.45
	251	848.8	33.54	32.39	30.38	29.22	28.49	27.34	25.33	24.17	38.45

Mode	Channel	Frequency (MHz)	Average Output Power (dBm)				ERP(dBm)				Limit (dBm)
			1 slot	2 slots	3 slots	4 slots	1 slot	2 slots	3 slots	4 slots	
EGPRS	128	824.2	27.14	25.70	23.29	21.80	22.09	20.65	18.24	16.75	38.45
	190	836.6	27.34	25.78	23.37	21.95	22.29	20.73	18.32	16.90	38.45
	251	848.8	27.56	26.00	23.57	22.17	22.51	20.95	18.52	17.12	38.45

Mode	Test Mode	3GPP Sub Test	Average Output Power (dBm)			ERP(dBm)		
			Low	Mid	High	Low	Mid	High
WCDMA (Band 5)	RMC12.2k		23.27	23.33	23.23	18.22	18.28	18.18
	HSDPA	1	22.26	22.30	22.19	17.21	17.25	17.14
		2	22.21	22.31	22.55	17.16	17.26	17.5
		3	22.23	22.28	22.36	17.18	17.23	17.31
		4	22.27	22.35	22.37	17.22	17.30	17.32
	HSUPA	1	22.10	22.07	21.95	17.05	17.02	16.90
		2	22.11	22.11	21.98	17.06	17.06	16.93
		3	22.13	22.07	21.96	17.08	17.02	16.91
		4	22.15	22.08	21.99	17.10	17.03	16.94
		5	22.10	22.09	22.00	17.05	17.04	16.95
HSPA+	1	22.12	22.18	22.17	17.07	17.13	17.12	

Note: ERP(dBm) = Conducted Power(dBm) + Antenna Gain(dBd)

For GSM850/WCDMA Band 5: Antenna Gain = -2.9dBi = -5.05dBd (0dBd=2.15dBi)

The limit: ERP ≤ 38.45dBm

PCS Band (Part 24E)

Mode	Channel	Frequency (MHz)	Average Output Power (dBm)	EIRP(dBm)	Limit (dBm)
GSM	512	1850.2	30.51	29.61	33
	661	1880.0	30.73	29.83	33
	810	1909.8	30.24	29.34	33

Mode	Channel	Frequency (MHz)	Average Output Power (dBm)				EIRP(dBm)				Limit (dBm)
			1 slot	2 slots	3 slots	4 slots	1 slot	2 slots	3 slots	4 slots	
GPRS	512	1850.2	30.53	29.44	27.54	26.34	29.63	28.54	26.64	25.44	33
	661	1880.0	30.74	29.61	27.70	26.56	29.84	28.71	26.80	25.66	33
	810	1909.8	30.26	29.05	27.28	26.23	29.36	28.15	26.38	25.33	33

Mode	Channel	Frequency (MHz)	Average Output Power (dBm)				EIRP(dBm)				Limit (dBm)
			1 slot	2 slots	3 slots	4 slots	1 slot	2 slots	3 slots	4 slots	
EGPRS	512	1850.2	25.25	24.06	22.12	20.98	24.35	23.16	21.22	20.08	33
	661	1880.0	25.22	24.08	22.10	21.01	24.32	23.18	21.20	20.11	33
	810	1909.8	25.76	24.67	22.68	21.55	24.86	23.77	21.78	20.65	33

Mode	Test Mode	3GPP Sub Test	Average Output Power (dBm)			EIRP(dBm)		
			Low	Mid	High	Low	Mid	High
WCDMA (Band 2)	RMC12.2k		22.46	22.56	22.71	21.56	21.66	21.81
	HSDPA	1	22.42	22.47	22.65	21.52	21.57	21.75
		2	22.48	22.38	22.61	21.58	21.48	21.71
		3	22.45	22.36	22.59	21.55	21.46	21.69
		4	22.39	22.44	22.38	21.49	21.54	21.48
	HSUPA	1	21.98	22.06	22.22	21.08	21.16	21.32
		2	21.99	22.07	22.35	21.09	21.17	21.45
		3	21.97	22.10	22.28	21.07	21.20	21.38
		4	21.94	22.09	22.27	21.04	21.19	21.37
		5	22.01	22.05	22.21	21.11	21.15	21.31
	HSPA+	1	22.08	22.09	22.11	21.18	21.19	21.21

Note: EIRP(dBm) = Conducted Power(dBm) + Antenna Gain(dBi)
 For PCS1900/WCDMA Band 2: Antenna Gain = -0.9dBi
 The limit: EIRP ≤ 33dBm

AWS Band (Part 27)

Mode	Test Mode	3GPP Sub Test	Average Output Power (dBm)			EIRP(dBm)		
			Low	Mid	High	Low	Mid	High
WCDMA (Band 4)	RMC12.2k		22.82	22.68	22.53	20.42	20.28	20.13
	HSDPA	1	22.47	22.29	22.11	20.07	19.89	19.71
		2	22.56	22.21	22.13	20.16	19.81	19.73
		3	22.48	22.27	22.14	20.08	19.87	19.74
		4	22.79	22.30	22.21	20.39	19.90	19.81
	HSUPA	1	22.05	22.09	21.90	19.65	19.69	19.50
		2	22.05	22.04	21.95	19.65	19.64	19.55
		3	22.01	22.05	21.87	19.61	19.65	19.47
		4	22.07	22.10	21.91	19.67	19.70	19.51
		5	22.04	22.07	21.95	19.64	19.67	19.55
	HSPA+	1	22.05	22.06	21.98	19.65	19.66	19.58

Note: EIRP(dBm) = Conducted Power(dBm) + Antenna Gain(dBi)

For WCDMA Band 4: Antenna Gain = -2.4dBi

The limit: EIRP ≤ 30dBm

Peak-to-average ratio (PAR)**Cellular Band**

Mode	Channel	PAR (dB)	Limit (dB)
GSM	Low	3.29	13
	Middle	3.17	13
	High	3.42	13

Mode	Channel	PAR (dB)	Limit (dB)
EGPRS	Low	3.28	13
	Middle	3.15	13
	High	3.41	13

Mode	Channel	PAR (dB)	Limit (dB)
RMC (BPSK)	Low	3.18	13
	Middle	3.17	13
	High	3.25	13
HSDPA (16QAM)	Low	4.21	13
	Middle	3.97	13
	High	3.85	13
HSUPA (BPSK)	Low	3.58	13
	Middle	3.67	13
	High	3.77	13
HSPA+	Low	3.67	13
	Middle	3.65	13
	High	3.68	13

PCS Band

Mode	Channel	PAR (dB)	Limit (dB)
GSM	Low	3.34	13
	Middle	3.36	13
	High	3.18	13

Mode	Channel	PAR (dB)	Limit (dB)
EGPRS	Low	3.33	13
	Middle	3.38	13
	High	3.39	13

Mode	Channel	PAR (dB)	Limit (dB)
RMC (BPSK)	Low	3.26	13
	Middle	3.28	13
	High	3.11	13
HSDPA (16QAM)	Low	3.55	13
	Middle	4.11	13
	High	4.35	13
HSUPA (BPSK)	Low	3.68	13
	Middle	3.67	13
	High	3.72	13
HSPA+	Low	3.78	13
	Middle	3.68	13
	High	3.71	13

AWS Band

Mode	Channel	PAR (dB)	Limit (dB)
RMC (BPSK)	Low	3.16	13
	Middle	3.15	13
	High	2.96	13
HSDPA (16QAM)	Low	3.86	13
	Middle	4.13	13
	High	4.45	13
HSUPA (BPSK)	Low	3.75	13
	Middle	3.62	13
	High	3.97	13
HSPA+	Low	3.65	13
	Middle	3.92	13
	High	3.76	13

LTE Band 2:**Maximum Output Power**

Bandwidth (MHz)	Modulation	RB size/ RB Offset	Conducted Average Output Power (dBm)			EIRP(dBm)		
			Low	Mid	High	Low	Mid	High
1.4	QPSK	RB1#0	23.37	22.90	22.99	22.47	22.00	22.09
		RB1#3	23.06	23.02	23.05	22.16	22.12	22.15
		RB1#5	22.95	22.91	22.96	22.05	22.01	22.06
		RB3#0	23.01	22.98	23.03	22.11	22.08	22.13
		RB3#3	23.00	22.95	23.04	22.10	22.05	22.14
		RB6#0	22.01	21.97	22.06	21.11	21.07	21.16
	16QAM	RB1#0	21.92	21.98	21.93	21.02	21.08	21.03
		RB1#3	22.12	22.18	22.19	21.22	21.28	21.29
		RB1#5	21.93	21.97	21.96	21.03	21.07	21.06
		RB3#0	22.17	21.87	22.09	21.27	20.97	21.19
		RB3#3	22.18	21.94	22.06	21.28	21.04	21.16
		RB6#0	21.00	20.99	21.00	20.10	20.09	20.10
3.0	QPSK	RB1#0	22.97	22.93	23.02	22.07	22.03	22.12
		RB1#8	22.93	22.93	23.05	22.03	22.03	22.15
		RB1#14	22.93	22.93	23.05	22.03	22.03	22.15
		RB6#0	21.96	21.91	21.96	21.06	21.01	21.06
		RB6#9	21.97	21.89	21.99	21.07	20.99	21.09
		RB15#0	21.97	21.91	22.02	21.07	21.01	21.12
	16QAM	RB1#0	22.53	22.07	22.02	21.63	21.17	21.12
		RB1#8	22.49	22.04	21.99	21.59	21.14	21.09
		RB1#14	22.44	22.05	21.99	21.54	21.15	21.09
		RB6#0	20.99	20.89	20.92	20.09	19.99	20.02
		RB6#9	20.99	20.94	20.94	20.09	20.04	20.04
		RB15#0	21.01	20.89	21.02	20.11	19.99	20.12

Bandwidth (MHz)	Modulation	RB size/ RB Offset	Conducted Average Output Power (dBm)			EIRP(dBm)		
			Low	Mid	High	Low	Mid	High
5.0	QPSK	RB1#0	22.89	22.86	22.88	21.99	21.96	21.98
		RB1#13	22.99	22.95	23.03	22.09	22.05	22.13
		RB1#24	22.89	22.84	22.92	21.99	21.94	22.02
		RB15#0	21.98	21.94	22.04	21.08	21.04	21.14
		RB15#10	22.01	21.92	22.02	21.11	21.02	21.12
		RB25#0	21.96	21.91	21.96	21.06	21.01	21.06
	16QAM	RB1#0	21.76	22.10	21.93	20.86	21.20	21.03
		RB1#13	21.86	22.21	22.07	20.96	21.31	21.17
		RB1#24	21.75	22.10	21.98	20.85	21.20	21.08
		RB15#0	21.04	21.00	21.04	20.14	20.10	20.14
		RB15#10	21.06	20.92	21.01	20.16	20.02	20.11
		RB25#0	21.01	20.87	21.00	20.11	19.97	20.10
10.0	QPSK	RB1#0	22.97	22.98	22.97	22.07	22.08	22.07
		RB1#25	23.11	23.12	23.14	22.21	22.22	22.24
		RB1#49	22.95	22.91	23.01	22.05	22.01	22.11
		RB25#0	22.01	22.01	22.09	21.11	21.11	21.19
		RB25#25	22.03	21.96	21.98	21.13	21.06	21.08
		RB50#0	22.02	22.00	22.03	21.12	21.10	21.13
	16QAM	RB1#0	22.50	22.05	21.89	21.60	21.15	20.99
		RB1#25	22.67	22.23	22.08	21.77	21.33	21.18
		RB1#49	22.45	22.02	21.95	21.55	21.12	21.05
		RB25#0	21.08	21.03	21.17	20.18	20.13	20.27
		RB25#25	21.07	21.01	21.04	20.17	20.11	20.14
		RB50#0	21.07	20.97	21.06	20.17	20.07	20.16

Bandwidth (MHz)	Modulation	RB size/ RB Offset	Conducted Average Output Power (dBm)			EIRP(dBm)		
			Low	Mid	High	Low	Mid	High
15.0	QPSK	RB1#0	22.84	22.82	22.84	21.94	21.92	21.94
		RB1#38	22.97	22.92	22.95	22.07	22.02	22.05
		RB1#74	22.77	22.79	22.89	21.87	21.89	21.99
		RB36#0	21.98	22.01	22.08	21.08	21.11	21.18
		RB36#39	21.98	22.04	22.03	21.08	21.14	21.13
		RB75#0	21.98	21.98	22.09	21.08	21.08	21.19
	16QAM	RB1#0	22.43	21.91	22.14	21.53	21.01	21.24
		RB1#38	22.46	22.07	22.26	21.56	21.17	21.36
		RB1#74	22.32	21.93	22.26	21.42	21.03	21.36
		RB36#0	20.95	20.98	21.03	20.05	20.08	20.13
		RB36#39	20.97	20.95	20.97	20.07	20.05	20.07
		RB75#0	20.95	20.94	21.00	20.05	20.04	20.10
20.0	QPSK	RB1#0	22.72	22.69	22.64	21.82	21.79	21.74
		RB1#50	23.18	23.17	23.10	22.28	22.27	22.20
		RB1#99	22.67	22.64	22.70	21.77	21.74	21.80
		RB50#0	21.93	21.94	22.02	21.03	21.04	21.12
		RB50#50	21.94	21.96	21.86	21.04	21.06	20.96
		RB100#0	21.93	21.98	21.94	21.03	21.08	21.04
	16QAM	RB1#0	22.00	21.83	22.16	21.10	20.93	21.26
		RB1#50	22.40	22.28	22.57	21.50	21.38	21.67
		RB1#99	21.92	21.79	22.24	21.02	20.89	21.34
		RB50#0	20.94	20.94	20.99	20.04	20.04	20.09
		RB50#50	20.89	20.98	20.84	19.99	20.08	19.94
		RB100#0	20.97	20.95	20.97	20.07	20.05	20.07

Note: EIRP(dBm) = Conducted Power(dBm) + Antenna Gain(dBi)

For LTE Band2: Antenna Gain = -0.9dBi

The Limit: EIRP ≤ 33dBm

Peak-to-average ratio (PAR)**20MHz Bandwidth**

Modulation	Low channel (dB)	Middle channel (dB)	High channel (dB)	PAR Limit (dB)	Result
QPSK (1RB Size)	5.34	4.98	4.21	13	Pass
QPSK (100RB Size)	6.53	6.37	6.87	13	Pass
16QAM (1RB Size)	5.95	5.66	5.22	13	Pass
16QAM (100RB Size)	7.79	7.23	7.37	13	Pass

LTE Band 4

Maximum Output Power

Bandwidth (MHz)	Modulation	RB size/ RB Offset	Conducted Average Output Power (dBm)			EIRP(dBm)		
			Low	Mid	High	Low	Mid	High
1.4	QPSK	RB1#0	22.59	22.57	22.49	20.19	20.17	20.09
		RB1#3	22.76	22.80	22.72	20.36	20.4	20.32
		RB1#5	22.59	22.58	22.49	20.19	20.18	20.09
		RB3#0	22.72	22.67	22.61	20.32	20.27	20.21
		RB3#3	22.67	22.64	22.62	20.27	20.24	20.22
		RB6#0	21.68	21.65	21.59	19.28	19.25	19.19
	16QAM	RB1#0	21.64	21.70	21.49	19.24	19.30	19.09
		RB1#3	21.80	21.93	21.70	19.40	19.53	19.30
		RB1#5	21.61	21.72	21.58	19.21	19.32	19.18
		RB3#0	21.89	21.65	21.66	19.49	19.25	19.26
		RB3#3	21.89	21.65	21.66	19.49	19.25	19.26
		RB6#0	20.68	20.66	20.49	18.28	18.26	18.09
3.0	QPSK	RB1#0	22.60	22.60	22.53	20.20	20.20	20.13
		RB1#8	22.63	22.59	22.51	20.23	20.19	20.11
		RB1#14	22.58	22.57	22.52	20.18	20.17	20.12
		RB6#0	21.59	21.57	21.51	19.19	19.17	19.11
		RB6#9	21.62	21.53	21.50	19.22	19.13	19.10
		RB15#0	21.65	21.63	21.53	19.25	19.23	19.13
	16QAM	RB1#0	22.17	21.73	21.54	19.77	19.33	19.14
		RB1#8	22.19	21.75	21.54	19.79	19.35	19.14
		RB1#14	22.17	21.76	21.48	19.77	19.36	19.08
		RB6#0	20.63	20.57	20.41	18.23	18.17	18.01
		RB6#9	20.72	20.60	20.43	18.32	18.20	18.03
		RB15#0	20.68	20.58	20.60	18.28	18.18	18.20

Bandwidth (MHz)	Modulation	RB size/ RB Offset	Conducted Average Output Power (dBm)			EIRP(dBm)		
			Low	Mid	High	Low	Mid	High
5.0	QPSK	RB1#0	22.48	22.52	22.42	20.08	20.12	20.02
		RB1#13	22.68	22.62	22.54	20.28	20.22	20.14
		RB1#24	22.54	22.50	22.42	20.14	20.10	20.02
		RB15#0	21.62	21.63	21.62	19.22	19.23	19.22
		RB15#10	21.69	21.64	21.53	19.29	19.24	19.13
		RB25#0	21.60	21.60	21.50	19.20	19.20	19.10
	16QAM	RB1#0	21.40	21.82	21.46	19.00	19.42	19.06
		RB1#13	21.57	21.93	21.62	19.17	19.53	19.22
		RB1#24	21.45	21.78	21.48	19.05	19.38	19.08
		RB15#0	20.64	20.62	20.64	18.24	18.22	18.24
		RB15#10	20.70	20.60	20.55	18.30	18.20	18.15
		RB25#0	20.66	20.62	20.58	18.26	18.22	18.18
10.0	QPSK	RB1#0	22.58	22.59	22.65	20.18	20.19	20.25
		RB1#25	22.77	22.77	22.75	20.37	20.37	20.35
		RB1#49	22.60	22.53	22.56	20.20	20.13	20.16
		RB25#0	21.62	21.61	21.64	19.22	19.21	19.24
		RB25#25	21.70	21.61	21.49	19.30	19.21	19.09
		RB50#0	21.64	21.65	21.59	19.24	19.25	19.19
	16QAM	RB1#0	22.17	21.79	21.57	19.77	19.39	19.17
		RB1#25	22.38	21.94	21.75	19.98	19.54	19.35
		RB1#49	22.23	21.85	21.54	19.83	19.45	19.14
		RB25#0	20.66	20.67	20.73	18.26	18.27	18.33
		RB25#25	20.68	20.71	20.61	18.28	18.31	18.21
		RB50#0	20.70	20.66	20.62	18.30	18.26	18.22

Bandwidth (MHz)	Modulation	RB size/ RB Offset	Conducted Average Output Power (dBm)			EIRP(dBm)		
			Low	Mid	High	Low	Mid	High
15.0	QPSK	RB1#0	22.49	22.46	22.45	20.09	20.06	20.05
		RB1#38	22.57	22.59	22.62	20.17	20.19	20.22
		RB1#74	22.53	22.40	22.46	20.13	20.00	20.06
		RB36#0	21.70	21.64	21.70	19.30	19.24	19.30
		RB36#39	21.67	21.69	21.64	19.27	19.29	19.24
		RB75#0	21.65	21.66	21.65	19.25	19.26	19.25
	16QAM	RB1#0	22.08	21.65	21.84	19.68	19.25	19.44
		RB1#38	22.20	21.79	21.99	19.80	19.39	19.59
		RB1#74	22.20	21.65	21.87	19.80	19.25	19.47
		RB36#0	20.65	20.63	20.62	18.25	18.23	18.22
		RB36#39	20.68	20.68	20.52	18.28	18.28	18.12
		RB75#0	20.66	20.68	20.57	18.26	18.28	18.17
20.0	QPSK	RB1#0	22.37	22.36	22.29	19.97	19.96	19.89
		RB1#50	22.81	22.79	22.69	20.41	20.39	20.29
		RB1#99	22.39	22.38	22.26	19.99	19.98	19.86
		RB50#0	21.63	21.64	21.60	19.23	19.24	19.20
		RB50#50	21.67	21.62	21.51	19.27	19.22	19.11
		RB100#0	21.66	21.66	21.57	19.26	19.26	19.17
	16QAM	RB1#0	21.67	21.59	21.92	19.27	19.19	19.52
		RB1#50	22.12	21.99	22.26	19.72	19.59	19.86
		RB1#99	21.74	21.58	21.84	19.34	19.18	19.44
		RB50#0	20.65	20.64	20.63	18.25	18.24	18.23
		RB50#50	20.66	20.65	20.55	18.26	18.25	18.15
		RB100#0	20.70	20.69	20.60	18.30	18.29	18.20

Note: EIRP(dBm) = Conducted Power(dBm) + Antenna Gain(dBi)

For LTE Band 4: Antenna Gain = -2.4dBi

The Limit: EIRP≤30dBm

Peak-to-average ratio (PAR)**20MHz Bandwidth**

Modulation	Low channel (dB)	Middle channel (dB)	High channel (dB)	PAR Limit (dB)	Result
QPSK (1RB Size)	5.26	5.56	4.92	13	Pass
QPSK (100RB Size)	6.63	6.63	6.14	13	Pass
16QAM (1RB Size)	6.10	6.57	5.47	13	Pass
16QAM (100RB Size)	7.52	7.39	7.25	13	Pass

LTE Band 5:**Maximum Output Power**

Bandwidth (MHz)	Modulation	RB size/ RB Offset	Conducted Average Output Power (dBm)			ERP(dBm)		
			Low	Mid	High	Low	Mid	High
1.4	QPSK	RB1#0	23.36	23.42	23.26	18.31	18.37	18.21
		RB1#3	23.56	23.55	23.51	18.51	18.50	18.46
		RB1#5	23.42	23.42	23.29	18.37	18.37	18.24
		RB3#0	23.45	23.49	23.46	18.40	18.44	18.41
		RB3#3	23.45	23.48	23.43	18.40	18.43	18.38
		RB6#0	22.48	22.51	22.41	17.43	17.46	17.36
	16QAM	RB1#0	22.38	22.51	22.31	17.33	17.46	17.26
		RB1#3	22.55	22.72	22.53	17.50	17.67	17.48
		RB1#5	22.39	22.52	22.37	17.34	17.47	17.32
		RB3#0	22.59	22.39	22.47	17.54	17.34	17.42
		RB3#3	22.59	22.43	22.47	17.54	17.38	17.42
		RB6#0	21.50	21.58	21.38	16.45	16.53	16.33
3.0	QPSK	RB1#0	23.46	23.46	23.38	18.41	18.41	18.33
		RB1#8	23.44	23.47	23.34	18.39	18.42	18.29
		RB1#14	23.41	23.45	23.39	18.36	18.4	18.34
		RB6#0	22.45	22.41	22.32	17.40	17.36	17.27
		RB6#9	22.45	22.39	22.36	17.40	17.34	17.31
		RB15#0	22.45	22.45	22.37	17.40	17.40	17.32
	16QAM	RB1#0	22.94	22.55	22.40	17.89	17.5	17.35
		RB1#8	22.92	22.58	22.36	17.87	17.53	17.31
		RB1#14	22.93	22.56	22.36	17.88	17.51	17.31
		RB6#0	21.50	21.47	21.32	16.45	16.42	16.27
		RB6#9	21.53	21.46	21.30	16.48	16.41	16.25
		RB15#0	21.52	21.41	21.47	16.47	16.36	16.42

Bandwidth (MHz)	Modulation	RB size/ RB Offset	Conducted Average Output Power (dBm)			ERP(dBm)		
			Low	Mid	High	Low	Mid	High
5.0	QPSK	RB1#0	23.34	23.38	23.29	18.29	18.33	18.24
		RB1#13	23.52	23.53	23.41	18.47	18.48	18.36
		RB1#24	23.41	23.34	23.26	18.36	18.29	18.21
		RB15#0	22.47	22.44	22.43	17.42	17.39	17.38
		RB15#10	22.50	22.43	22.42	17.45	17.38	17.37
		RB25#0	22.46	22.42	22.41	17.41	17.37	17.36
	16QAM	RB1#0	22.23	22.59	22.40	17.18	17.54	17.35
		RB1#13	22.40	22.74	22.45	17.35	17.69	17.40
		RB1#24	22.28	22.61	22.37	17.23	17.56	17.32
		RB15#0	21.53	21.45	21.46	16.48	16.40	16.41
		RB15#10	21.57	21.42	21.49	16.52	16.37	16.44
		RB25#0	21.58	21.44	21.44	16.53	16.39	16.39
10.0	QPSK	RB1#0	23.44	23.49	23.41	18.39	18.44	18.36
		RB1#25	23.67	23.61	23.58	18.62	18.56	18.53
		RB1#49	23.43	23.38	23.39	18.38	18.33	18.34
		RB25#0	22.46	22.54	22.52	17.41	17.49	17.47
		RB25#25	22.57	22.42	22.44	17.52	17.37	17.39
		RB50#0	22.51	22.47	22.51	17.46	17.42	17.46
	16QAM	RB1#0	22.95	22.58	22.38	17.90	17.53	17.33
		RB1#25	23.19	22.73	22.57	18.14	17.68	17.52
		RB1#49	22.91	22.54	22.36	17.86	17.49	17.31
		RB25#0	21.59	21.56	21.61	16.54	16.51	16.56
		RB25#25	21.65	21.46	21.59	16.60	16.41	16.54
		RB50#0	21.58	21.45	21.55	16.53	16.40	16.50

Note: ERP(dBm) = Conducted Power(dBm) + Antenna Gain(dBd)
For LTE Band 5: Antenna Gain = -2.9dBi = -5.05dBd (0dBd=2.15dBi)
Limit: ERP ≤ 38.45dBm

Peak-to-average ratio (PAR)**10MHz bandwidth**

Modulation	Low channel (dB)	Middle channel (dB)	High channel (dB)	PAR Limit (dB)	Result
QPSK (1RB Size)	4.40	4.19	4.09	13	Pass
QPSK (50RB Size)	6.36	6.51	6.45	13	Pass
16QAM (1RB Size)	5.16	5.15	5.06	13	Pass
16QAM (50RB Size)	7.21	7.57	7.68	13	Pass

LTE Band 7:**Maximum Output Power**

Bandwidth (MHz)	Modulation	RB size/ RB Offset	Conducted Average Output Power (dBm)			EIRP(dBm)		
			Low	Mid	High	Low	Mid	High
5.0	QPSK	RB1#0	22.29	22.32	22.17	22.19	22.22	22.07
		RB1#13	22.47	22.44	22.30	22.37	22.34	22.20
		RB1#24	22.30	22.26	22.18	22.20	22.16	22.08
		RB15#0	21.49	21.45	21.44	21.39	21.35	21.34
		RB15#10	21.58	21.45	21.32	21.48	21.35	21.22
		RB25#0	21.45	21.41	21.34	21.35	21.31	21.24
	16QAM	RB1#0	21.28	21.61	21.30	21.18	21.51	21.20
		RB1#13	21.40	21.76	21.45	21.30	21.66	21.35
		RB1#24	21.24	21.56	21.31	21.14	21.46	21.21
		RB15#0	20.56	20.42	20.48	20.46	20.32	20.38
		RB15#10	20.60	20.47	20.42	20.50	20.37	20.32
		RB25#0	20.60	20.46	20.44	20.50	20.36	20.34
10.0	QPSK	RB1#0	22.41	22.37	22.28	22.31	22.27	22.18
		RB1#25	22.59	22.55	22.48	22.49	22.45	22.38
		RB1#49	22.44	22.34	22.31	22.34	22.24	22.21
		RB25#0	21.48	21.46	21.40	21.38	21.36	21.30
		RB25#25	21.54	21.50	21.34	21.44	21.40	21.24
		RB50#0	21.55	21.48	21.37	21.45	21.38	21.27
	16QAM	RB1#0	22.02	21.58	21.35	21.92	21.48	21.25
		RB1#25	22.18	21.71	21.49	22.08	21.61	21.39
		RB1#49	22.06	21.53	21.32	21.96	21.43	21.22
		RB25#0	20.57	20.52	20.52	20.47	20.42	20.42
		RB25#25	20.59	20.57	20.47	20.49	20.47	20.37
		RB50#0	20.53	20.53	20.44	20.43	20.43	20.34

Bandwidth (MHz)	Modulation	RB size/ RB Offset	Conducted Average Output Power (dBm)			EIRP(dBm)		
			Low	Mid	High	Low	Mid	High
15.0	QPSK	RB1#0	22.32	22.31	22.17	22.22	22.21	22.07
		RB1#38	22.45	22.41	22.31	22.35	22.31	22.21
		RB1#74	22.34	22.25	22.20	22.24	22.15	22.10
		RB36#0	21.53	21.53	21.42	21.43	21.43	21.32
		RB36#39	21.60	21.54	21.44	21.50	21.44	21.34
		RB75#0	21.56	21.54	21.42	21.46	21.44	21.32
	16QAM	RB1#0	21.91	21.48	21.59	21.81	21.38	21.49
		RB1#38	22.04	21.55	21.70	21.94	21.45	21.60
		RB1#74	21.96	21.45	21.63	21.86	21.35	21.53
		RB36#0	20.50	20.50	20.38	20.40	20.40	20.28
		RB36#39	20.55	20.53	20.41	20.45	20.43	20.31
		RB75#0	20.53	20.54	20.41	20.43	20.44	20.31
20.0	QPSK	RB1#0	22.15	22.21	21.96	22.05	22.11	21.86
		RB1#50	22.56	22.53	22.39	22.46	22.43	22.29
		RB1#99	22.15	22.05	21.96	22.05	21.95	21.86
		RB50#0	21.36	21.37	21.29	21.26	21.27	21.19
		RB50#50	21.48	21.41	21.23	21.38	21.31	21.13
		RB100#0	21.43	21.39	21.29	21.33	21.29	21.19
	16QAM	RB1#0	21.49	21.41	21.60	21.39	21.31	21.50
		RB1#50	21.92	21.72	21.95	21.82	21.62	21.85
		RB1#99	21.48	21.28	21.60	21.38	21.18	21.50
		RB50#0	20.37	20.37	20.34	20.27	20.27	20.24
		RB50#50	20.47	20.42	20.29	20.37	20.32	20.19
		RB100#0	20.45	20.43	20.31	20.35	20.33	20.21

Note: EIRP(dBm) = Conducted Power(dBm) + Antenna Gain(dBi)

For LTE Band7: Antenna Gain = -0.1dBi

Limit: EIRP ≤ 33dBm

Peak-to-average ratio (PAR)**20MHz bandwidth**

Modulation	Low channel (dB)	Middle channel (dB)	High channel (dB)	PAR Limit (dB)	Result
QPSK (1RB Size)	4.32	4.18	4.72	13	Pass
QPSK (100RB Size)	6.16	6.07	6.62	13	Pass
16QAM (1RB Size)	5.24	5.03	5.57	13	Pass
16QAM (100RB Size)	7.48	7.11	7.94	13	Pass

LTE Band 17:**Maximum Output Power**

Bandwidth (MHz)	Modulation	RB size/ RB Offset	Conducted Average Output Power (dBm)			ERP(dBm)		
			Low	Mid	High	Low	Mid	High
5.0	QPSK	RB1#0	23.31	23.35	23.30	18.16	18.20	18.15
		RB1#13	23.40	23.42	23.43	18.25	18.27	18.28
		RB1#24	23.31	23.31	23.31	18.16	18.16	18.16
		RB15#0	22.41	22.44	22.59	17.26	17.29	17.44
		RB15#10	22.56	22.42	22.48	17.41	17.27	17.33
		RB25#0	22.43	22.39	22.48	17.28	17.24	17.33
	16QAM	RB1#0	22.29	22.70	22.41	17.14	17.55	17.26
		RB1#13	22.37	22.77	22.54	17.22	17.62	17.39
		RB1#24	22.31	22.68	22.46	17.16	17.53	17.31
		RB15#0	21.50	21.48	21.62	16.35	16.33	16.47
		RB15#10	21.59	21.41	21.53	16.44	16.26	16.38
		RB25#0	21.50	21.38	21.55	16.35	16.23	16.40
10.0	QPSK	RB1#0	23.31	23.42	23.34	18.16	18.27	18.19
		RB1#25	23.55	23.53	23.56	18.40	18.38	18.41
		RB1#49	23.33	23.38	23.44	18.18	18.23	18.29
		RB25#0	22.37	22.44	22.46	17.22	17.29	17.31
		RB25#25	22.37	22.37	22.41	17.22	17.22	17.26
		RB50#0	22.37	22.39	22.47	17.22	17.24	17.32
	16QAM	RB1#0	23.03	22.61	22.44	17.88	17.46	17.29
		RB1#25	23.14	22.75	22.62	17.99	17.60	17.47
		RB1#49	23.02	22.59	22.50	17.87	17.44	17.35
		RB25#0	21.46	21.47	21.60	16.31	16.32	16.45
		RB25#25	21.49	21.40	21.53	16.34	16.25	16.38
		RB50#0	21.41	21.46	21.53	16.26	16.31	16.38

Note: ERP(dBm) = Conducted Power(dBm) + Antenna Gain(dBd))
For LTE Band17: Antenna Gain = -3.0dBi = -5.15dBd (0dBd=2.15dBi)
Limit: ERP ≤ 34.77dBm

Peak-to-average ratio (PAR)**10MHz bandwidth**

Modulation	Low channel (dB)	Middle channel (dB)	High channel (dB)	PAR Limit (dB)	Result
QPSK (1RB Size)	5.78	5.60	5.28	13	Pass
QPSK (50RB Size)	6.96	6.44	6.54	13	Pass
16QAM (1RB Size)	6.56	6.50	5.93	13	Pass
16QAM (50RB Size)	8.21	7.45	7.81	13	Pass

LTE Band 38:**Maximum Output Power**

Bandwidth (MHz)	Modulation	RB size/ RB Offset	Conducted Average Output Power (dBm)			EIRP(dBm)		
			Low	Mid	High	Low	Mid	High
5.0	QPSK	RB1#0	21.80	21.84	21.80	21.70	21.74	21.70
		RB1#13	21.93	22.01	21.93	21.83	21.91	21.83
		RB1#24	21.78	21.86	21.82	21.68	21.76	21.72
		RB15#0	20.87	20.89	20.89	20.77	20.79	20.79
		RB15#10	20.85	20.93	20.89	20.75	20.83	20.79
		RB25#0	20.86	20.93	20.87	20.76	20.83	20.77
	16QAM	RB1#0	21.09	20.84	20.83	20.99	20.74	20.73
		RB1#13	21.18	21.00	20.96	21.08	20.90	20.86
		RB1#24	21.08	20.85	20.85	20.98	20.75	20.75
		RB15#0	19.89	19.88	19.94	19.79	19.78	19.84
		RB15#10	19.88	19.90	19.93	19.78	19.80	19.83
		RB25#0	19.84	19.98	19.95	19.74	19.88	19.85
10.0	QPSK	RB1#0	21.90	22.00	22.04	21.80	21.90	21.94
		RB1#25	22.16	22.26	22.17	22.06	22.16	22.07
		RB1#49	21.89	21.95	21.97	21.79	21.85	21.87
		RB25#0	20.95	20.97	20.94	20.85	20.87	20.84
		RB25#25	20.95	20.98	20.96	20.85	20.88	20.86
		RB50#0	20.92	20.97	20.92	20.82	20.87	20.82
	16QAM	RB1#0	21.16	20.87	21.08	21.06	20.77	20.98
		RB1#25	21.38	21.14	21.26	21.28	21.04	21.16
		RB1#49	21.16	20.85	21.07	21.06	20.75	20.97
		RB25#0	19.91	20.03	20.00	19.81	19.93	19.90
		RB25#25	19.95	20.07	19.99	19.85	19.97	19.89
		RB50#0	19.91	19.99	19.94	19.81	19.89	19.84

Bandwidth (MHz)	Modulation	RB size/ RB Offset	Conducted Average Output Power (dBm)			EIRP(dBm)		
			Low	Mid	High	Low	Mid	High
15.0	QPSK	RB1#0	21.84	21.89	21.92	21.74	21.79	21.82
		RB1#38	21.89	22.00	21.98	21.79	21.90	21.88
		RB1#74	21.92	21.92	21.87	21.82	21.82	21.77
		RB36#0	20.92	20.96	20.97	20.82	20.86	20.87
		RB36#39	21.00	21.03	20.95	20.90	20.93	20.85
		RB75#0	20.92	20.98	21.03	20.82	20.88	20.93
	16QAM	RB1#0	21.06	20.83	21.07	20.96	20.73	20.97
		RB1#38	21.15	20.90	21.14	21.05	20.80	21.04
		RB1#74	21.06	20.82	21.05	20.96	20.72	20.95
		RB36#0	19.86	19.91	20.02	19.76	19.81	19.92
		RB36#39	19.93	19.95	20.01	19.83	19.85	19.91
		RB75#0	19.85	20.06	20.01	19.75	19.96	19.91
20.0	QPSK	RB1#0	21.65	21.63	21.80	21.55	21.53	21.70
		RB1#50	22.21	22.17	22.30	22.11	22.07	22.20
		RB1#99	21.74	21.72	21.76	21.64	21.62	21.66
		RB50#0	20.85	20.91	20.84	20.75	20.81	20.74
		RB50#50	20.92	20.95	20.94	20.82	20.85	20.84
		RB100#0	20.88	20.93	20.87	20.78	20.83	20.77
	16QAM	RB1#0	20.73	20.62	20.98	20.63	20.52	20.88
		RB1#50	21.29	21.14	21.49	21.19	21.04	21.39
		RB1#99	20.76	20.70	20.95	20.66	20.60	20.85
		RB50#0	19.79	19.91	19.89	19.69	19.81	19.79
		RB50#50	19.96	20.04	20.00	19.86	19.94	19.90
		RB100#0	19.92	19.97	19.91	19.82	19.87	19.81

Note: EIRP(dBm) = Conducted Power(dBm) + Antenna Gain(dBi)

For LTE Band38: Antenna Gain = -0.1dBi

Limit: EIRP ≤ 33dBm

Peak-to-average ratio (PAR)**20MHz bandwidth**

Modulation	Low channel (dB)	Middle channel (dB)	High channel (dB)	PAR Limit (dB)	Result
QPSK (1RB Size)	6.03	5.54	5.24	13	Pass
QPSK (100RB Size)	6.94	6.59	6.27	13	Pass
16QAM (1RB Size)	7.80	7.28	7.60	13	Pass
16QAM (100RB Size)	8.31	8.51	7.94	13	Pass

LTE Band 41:**Maximum Output Power**

Bandwidth (MHz)	Modulation	RB size/ RB Offset	Conducted Average Output Power (dBm)			EIRP(dBm)		
			Low	Mid	High	Low	Mid	High
5.0	QPSK	RB1#0	22.17	22.26	21.88	22.07	22.16	21.78
		RB1#13	22.29	22.39	21.96	22.19	22.29	21.86
		RB1#24	22.17	22.24	21.86	22.07	22.14	21.76
		RB15#0	21.24	21.26	20.92	21.14	21.16	20.82
		RB15#10	21.27	21.32	20.90	21.17	21.22	20.80
		RB25#0	21.24	21.31	20.89	21.14	21.21	20.79
	16QAM	RB1#0	21.25	21.47	20.85	21.15	21.37	20.75
		RB1#13	21.40	21.59	20.98	21.30	21.49	20.88
		RB1#24	21.26	21.49	20.84	21.16	21.39	20.74
		RB15#0	20.27	20.32	19.90	20.17	20.22	19.80
		RB15#10	20.27	20.37	19.89	20.17	20.27	19.79
		RB25#0	20.31	20.32	19.96	20.21	20.22	19.86
10.0	QPSK	RB1#0	22.31	22.39	22.05	22.21	22.29	21.95
		RB1#25	22.55	22.66	22.31	22.45	22.56	22.21
		RB1#49	22.28	22.36	22.03	22.18	22.26	21.93
		RB25#0	21.30	21.37	21.01	21.20	21.27	20.91
		RB25#25	21.34	21.41	20.97	21.24	21.31	20.87
		RB50#0	21.29	21.40	21.00	21.19	21.30	20.90
	16QAM	RB1#0	21.56	21.28	21.16	21.46	21.18	21.06
		RB1#25	21.79	21.56	21.35	21.69	21.46	21.25
		RB1#49	21.53	21.27	21.02	21.43	21.17	20.92
		RB25#0	20.28	20.44	20.08	20.18	20.34	19.98
		RB25#25	20.30	20.46	20.04	20.20	20.36	19.94
		RB50#0	20.28	20.40	20.05	20.18	20.30	19.95

Bandwidth (MHz)	Modulation	RB size/ RB Offset	Conducted Average Output Power (dBm)			EIRP(dBm)		
			Low	Mid	High	Low	Mid	High
15.0	QPSK	RB1#0	22.15	22.29	21.97	22.05	22.19	21.87
		RB1#38	22.25	22.40	22.04	22.15	22.30	21.94
		RB1#74	22.18	22.31	21.91	22.08	22.21	21.81
		RB36#0	21.27	21.31	21.04	21.17	21.21	20.94
		RB36#39	21.30	21.39	20.99	21.20	21.29	20.89
		RB75#0	21.33	21.35	21.07	21.23	21.25	20.97
	16QAM	RB1#0	21.46	21.21	21.17	21.36	21.11	21.07
		RB1#38	21.52	21.28	21.20	21.42	21.18	21.10
		RB1#74	21.41	21.18	21.09	21.31	21.08	20.99
		RB36#0	20.24	20.27	20.07	20.14	20.17	19.97
		RB36#39	20.22	20.37	20.08	20.12	20.27	19.98
		RB75#0	20.21	20.38	20.03	20.11	20.28	19.93
20.0	QPSK	RB1#0	21.98	22.03	21.94	21.88	21.93	21.84
		RB1#50	22.46	22.53	22.34	22.36	22.43	22.24
		RB1#99	21.88	22.06	21.81	21.78	21.96	21.71
		RB50#0	21.16	21.17	21.02	21.06	21.07	20.92
		RB50#50	21.22	21.32	20.92	21.12	21.22	20.82
		RB100#0	21.19	21.28	20.94	21.09	21.18	20.84
	16QAM	RB1#0	21.13	21.04	21.15	21.03	20.94	21.05
		RB1#50	21.55	21.52	21.56	21.45	21.42	21.46
		RB1#99	21.03	21.04	20.99	20.93	20.94	20.89
		RB50#0	20.17	20.29	20.07	20.07	20.19	19.97
		RB50#50	20.17	20.45	19.99	20.07	20.35	19.89
		RB100#0	20.17	20.27	20.01	20.07	20.17	19.91

Note: EIRP(dBm) = Conducted Power(dBm) + Antenna Gain(dBi)

For LTE Band41: Antenna Gain = -0.1dBi

Limit: EIRP ≤ 33dBm

Peak-to-average ratio (PAR)**20MHz bandwidth**

Modulation	Low channel (dB)	Middle channel (dB)	High channel (dB)	PAR Limit (dB)	Result
QPSK (1RB Size)	5.21	5.77	5.70	13	Pass
QPSK (100RB Size)	6.95	6.38	6.03	13	Pass
16QAM (1RB Size)	6.81	6.99	6.94	13	Pass
16QAM (100RB Size)	8.78	8.55	8.08	13	Pass

LTE Band 66:**Maximum Output Power**

Bandwidth (MHz)	Modulation	RB size/ RB Offset	Conducted Average Output Power (dBm)			EIRP(dBm)		
			Low	Mid	High	Low	Mid	High
1.4	QPSK	RB1#0	23.26	23.23	23.09	20.86	20.83	20.69
		RB1#3	23.44	23.32	23.25	21.04	20.92	20.85
		RB1#5	23.27	23.21	23.11	20.87	20.81	20.71
		RB3#0	23.37	23.27	23.17	20.97	20.87	20.77
		RB3#3	23.33	23.28	23.22	20.93	20.88	20.82
		RB6#0	22.35	22.29	22.17	19.95	19.89	19.77
	16QAM	RB1#0	22.25	22.28	22.07	19.85	19.88	19.67
		RB1#3	22.42	22.47	22.25	20.02	20.07	19.85
		RB1#5	22.25	22.27	22.10	19.85	19.87	19.70
		RB3#0	22.46	22.18	22.19	20.06	19.78	19.79
		RB3#3	22.52	22.23	22.26	20.12	19.83	19.86
		RB6#0	21.32	21.29	21.10	18.92	18.89	18.70
3.0	QPSK	RB1#0	23.36	23.25	23.21	20.96	20.85	20.81
		RB1#8	23.33	23.26	23.16	20.93	20.86	20.76
		RB1#14	23.29	23.24	23.21	20.89	20.84	20.81
		RB6#0	22.31	22.21	22.12	19.91	19.81	19.72
		RB6#9	22.29	22.25	22.13	19.89	19.85	19.73
		RB15#0	22.31	22.24	22.18	19.91	19.84	19.78
	16QAM	RB1#0	22.86	22.33	22.18	20.46	19.93	19.78
		RB1#8	22.87	22.34	22.15	20.47	19.94	19.75
		RB1#14	22.78	22.35	22.10	20.38	19.95	19.70
		RB6#0	21.35	21.24	21.08	18.95	18.84	18.68
		RB6#9	21.34	21.26	21.08	18.94	18.86	18.68
		RB15#0	21.36	21.18	21.21	18.96	18.78	18.81

Bandwidth (MHz)	Modulation	RB size/ RB Offset	Conducted Average Output Power (dBm)			EIRP(dBm)		
			Low	Mid	High	Low	Mid	High
5.0	QP SK	RB1#0	23.24	23.15	23.05	20.84	20.75	20.65
		RB1#13	23.35	23.28	23.20	20.95	20.88	20.80
		RB1#24	23.21	23.15	23.06	20.81	20.75	20.66
		RB15#0	22.32	22.26	22.27	19.92	19.86	19.87
		RB15#10	22.37	22.20	22.18	19.97	19.80	19.78
		RB25#0	22.25	22.20	22.17	19.85	19.80	19.77
	16QAM	RB1#0	22.10	22.40	22.10	19.70	20.00	19.70
		RB1#13	22.23	22.53	22.24	19.83	20.13	19.84
		RB1#24	22.07	22.40	22.08	19.67	20.00	19.68
		RB15#0	21.36	21.23	21.25	18.96	18.83	18.85
		RB15#10	21.38	21.22	21.17	18.98	18.82	18.77
		RB25#0	21.35	21.19	21.20	18.95	18.79	18.80
10.0	QPSK	RB1#0	23.26	23.23	23.16	20.86	20.83	20.76
		RB1#25	23.40	23.35	23.35	21.00	20.95	20.95
		RB1#49	23.22	23.17	23.14	20.82	20.77	20.74
		RB25#0	22.20	22.20	22.21	19.80	19.80	19.81
		RB25#25	22.25	22.18	22.10	19.85	19.78	19.70
		RB50#0	22.23	22.18	22.17	19.83	19.78	19.77
	16QAM	RB1#0	22.82	22.35	22.16	20.42	19.95	19.76
		RB1#25	22.97	22.44	22.28	20.57	20.04	19.88
		RB1#49	22.79	22.32	22.11	20.39	19.92	19.71
		RB25#0	21.28	21.28	21.34	18.88	18.88	18.94
		RB25#25	21.29	21.18	21.16	18.89	18.78	18.76
		RB50#0	21.24	21.21	21.21	18.84	18.81	18.81

Bandwidth (MHz)	Modulation	RB size/ RB Offset	Conducted Average Output Power (dBm)			EIRP(dBm)		
			Low	Mid	High	Low	Mid	High
15.0	QPSK	RB1#0	23.19	23.16	23.00	20.79	20.76	20.6
		RB1#38	23.30	23.24	23.21	20.90	20.84	20.81
		RB1#74	23.22	23.14	23.05	20.82	20.74	20.65
		RB36#0	22.31	22.38	22.28	19.91	19.98	19.88
		RB36#39	22.39	22.27	22.19	19.99	19.87	19.79
		RB75#0	22.33	22.32	22.27	19.93	19.92	19.87
	16QAM	RB1#0	22.71	22.30	22.39	20.31	19.90	19.99
		RB1#38	22.86	22.37	22.58	20.46	19.97	20.18
		RB1#74	22.81	22.24	22.40	20.41	19.84	20.00
		RB36#0	21.31	21.29	21.22	18.91	18.89	18.82
		RB36#39	21.34	21.23	21.18	18.94	18.83	18.78
		RB75#0	21.31	21.25	21.19	18.91	18.85	18.79
20.0	QPSK	RB1#0	23.02	23.02	22.81	20.62	20.62	20.41
		RB1#50	23.46	23.44	23.23	21.06	21.04	20.83
		RB1#99	23.06	22.94	22.84	20.66	20.54	20.44
		RB50#0	22.25	22.26	22.29	19.85	19.86	19.89
		RB50#50	22.26	22.14	22.07	19.86	19.74	19.67
		RB100#0	22.26	22.21	22.16	19.86	19.81	19.76
	16QAM	RB1#0	22.32	22.18	22.40	19.92	19.78	20.00
		RB1#50	22.72	22.59	22.84	20.32	20.19	20.44
		RB1#99	22.34	22.15	22.37	19.94	19.75	19.97
		RB50#0	21.28	21.29	21.30	18.88	18.89	18.90
		RB50#50	21.28	21.14	21.10	18.88	18.74	18.70
		RB100#0	21.35	21.24	21.21	18.95	18.84	18.81

Note: EIRP(dBm) = Conducted Power(dBm) + Antenna Gain(dBi)

For LTE Band 66: Antenna Gain = -2.4dBi

Limit: EIRP ≤ 30dBm

Peak-to-average ratio (PAR)**20MHz bandwidth**

Modulation	Low channel (dB)	Middle channel (dB)	High channel (dB)	PAR Limit (dB)	Result
QPSK (1RB Size)	4.63	4.73	4.98	13	Pass
QPSK (100RB Size)	6.62	6.47	6.46	13	Pass
16QAM (1RB Size)	5.32	5.69	5.92	13	Pass
16QAM (100RB Size)	7.37	7.74	7.43	13	Pass

FCC §2.1049, §22.917, §22.905 & §24.238 & §27.53 - OCCUPIED BANDWIDTH

Applicable Standard

FCC 47 §2.1049, §22.917, §22.905, §24.238 and §27.53.

Test Procedure

The RF output of the transmitter was connected to the simulator and the spectrum analyzer through sufficient attenuation.

The resolution bandwidth of the spectrum analyzer was set at 1% to 5% of the anticipated emission bandwidth and the 26 dB & 99% bandwidth was recorded.

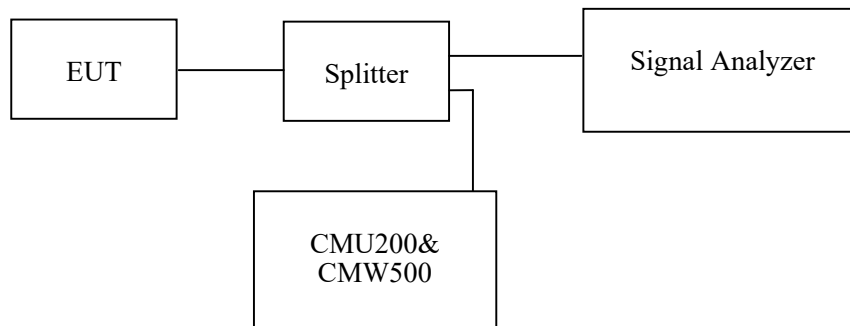

Test Data

Environmental Conditions

Temperature:	27 °C
Relative Humidity:	58 %
ATM Pressure:	101.0 kPa

The testing was performed by Ting Lv from 2021-09-07 to 2021-11-08.

EUT operation mode: Transmitting

Test Result: Pass

Please refer to the following tables and plots.

Cellular Band (Part 22H)

Mode	Channel	Frequency (MHz)	99% Occupied Bandwidth (kHz)	26 dB Emission Bandwidth (kHz)
GSM(GMSK)	128	824.2	245.19	317.31
	190	836.6	248.40	315.71
	251	848.8	245.19	312.50
EGPRS(8PSK)	128	824.2	254.81	315.71
	190	836.6	251.60	315.71
	251	848.8	248.40	317.31

	Frequency (MHz)	Occupied Bandwidth (MHz)	26dB Bandwidth (MHz)
RMC	826.4	4.16	4.71
	836.6	4.18	4.72
	846.6	4.16	4.73
HSDPA	826.4	4.18	4.72
	836.6	4.18	4.71
	846.6	4.20	5.01
HSUPA	826.4	4.21	4.86
	836.6	4.20	4.82
	846.6	4.20	5.32

PCS Band (Part 24E)

Mode	Channel	Frequency (MHz)	99% Occupied Bandwidth (kHz)	26 dB Emission Bandwidth (kHz)
GSM(GMSK)	512	1850.2	245.19	309.29
	661	1880.0	245.19	314.10
	810	1909.8	245.19	317.31
EGPRS(8PSK)	512	1850.2	253.21	318.91
	661	1880.0	250.00	317.31
	810	1909.8	250.00	314.10

	Frequency (MHz)	Occupied Bandwidth (MHz)	26dB Bandwidth (MHz)
RMC	1852.4	4.20	4.73
	1880.0	4.18	4.73
	1907.6	4.18	4.76
HSDPA	1852.4	4.20	4.78
	1880.0	4.20	4.82
	1907.6	4.22	5.02
HSUPA	1852.4	4.20	4.89
	1880.0	4.20	4.84
	1907.6	4.21	4.94

AWS Band (Part 27)

	Frequency (MHz)	Occupied Bandwidth (MHz)	26dB Bandwidth (MHz)
RMC	1712.4	4.18	4.73
	1732.6	4.20	4.72
	1752.6	4.18	4.73
HSDPA	1712.4	4.20	4.76
	1732.6	4.20	4.73
	1752.6	4.20	4.95
HSUPA	1712.4	4.20	4.89
	1732.6	4.18	4.73
	1752.6	4.20	5.32

Cellular Band (Part 22H)

26 dB Emissions & 99% Occupied Bandwidth for GSM (GMSK) Mode, Low channel

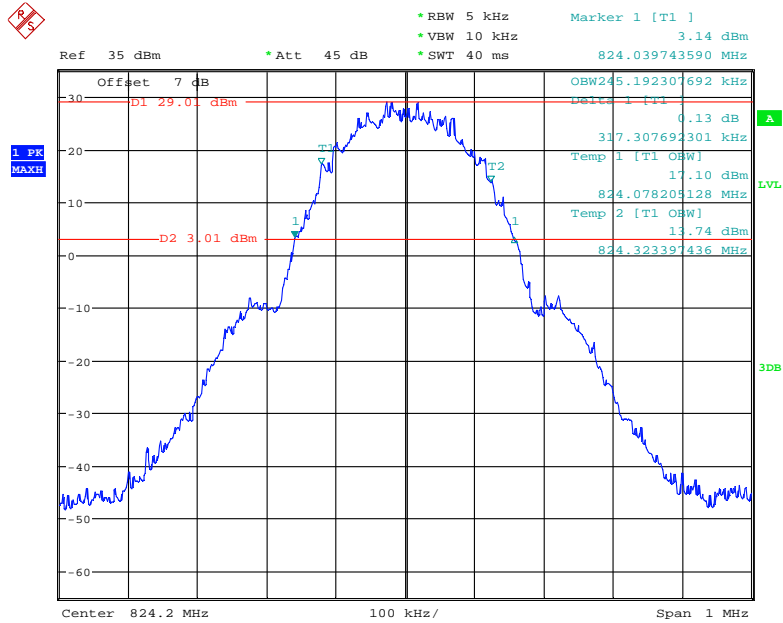

Date: 7.SEP.2021 13:27:53

26 dB Emissions & 99% Occupied Bandwidth for GSM (GMSK) Mode, Middle channel

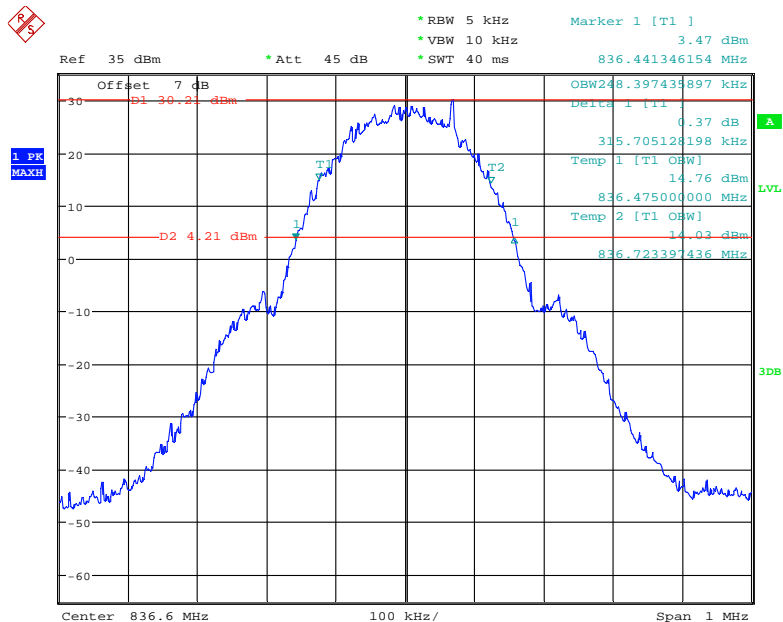

Date: 7.SEP.2021 13:30:16

26 dB Emissions & 99% Occupied Bandwidth for GSM (GMSK) Mode, High channel

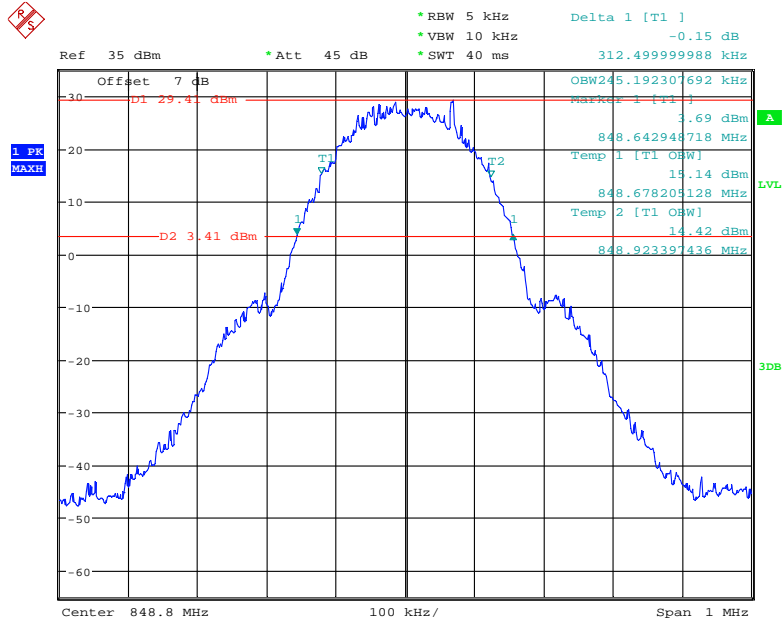

Date: 7.SEP.2021 13:31:56

26 dB Emissions & 99% Occupied Bandwidth for EGPRS (8PSK) Mode, Low channel

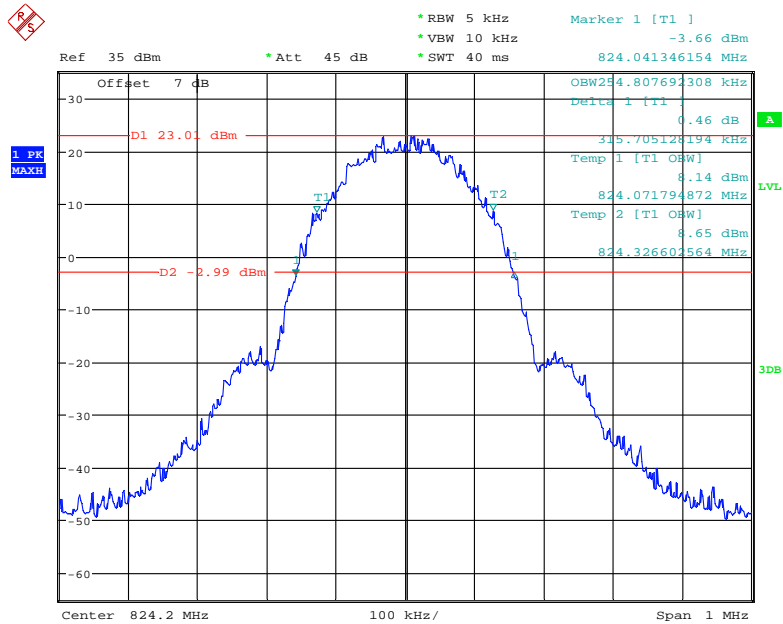

Date: 7.SEP.2021 14:08:58

26 dB Emissions & 99% Occupied Bandwidth for EGPRS (8PSK) Mode, Middle channel

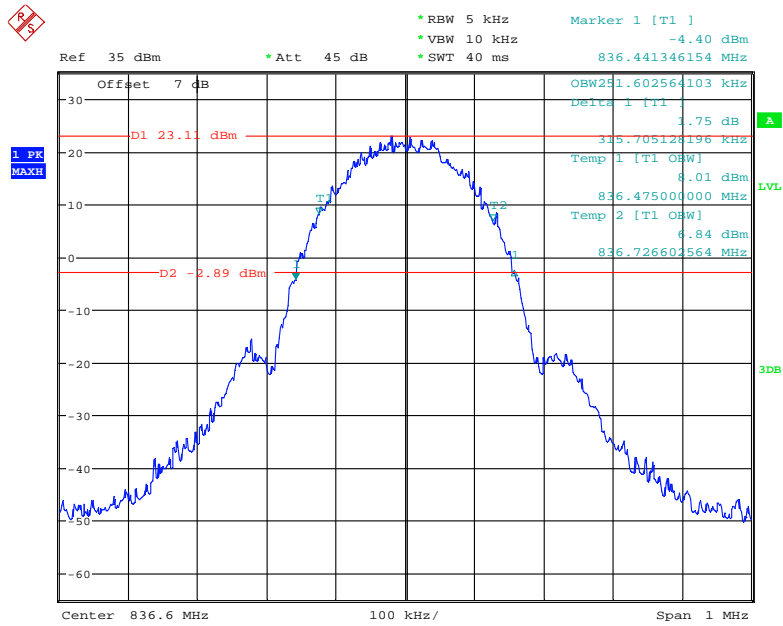

Date: 7.SEP.2021 14:10:37

26 dB Emissions & 99% Occupied Bandwidth for EGPRS (8PSK) Mode, High channel

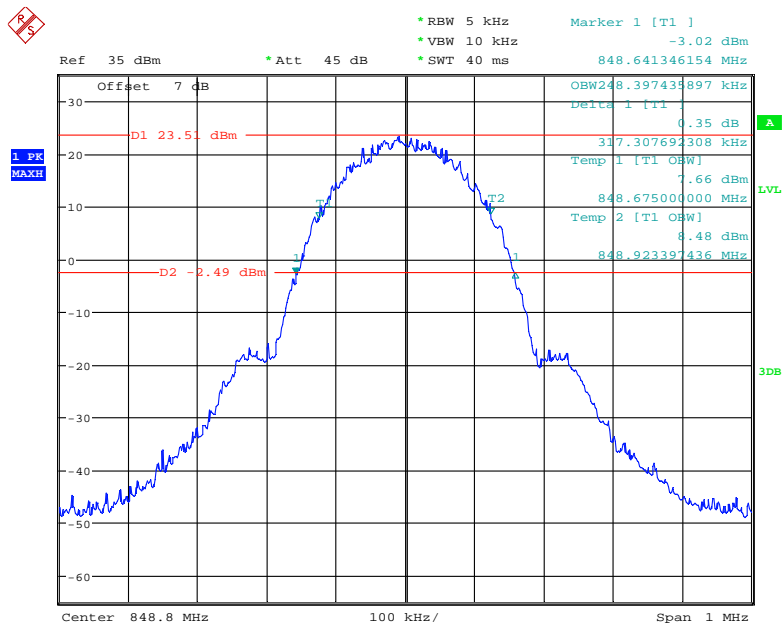

Date: 7.SEP.2021 14:13:21

26 dB Emissions & 99% Occupied Bandwidth for RMC (BPSK) Mode, Low channel

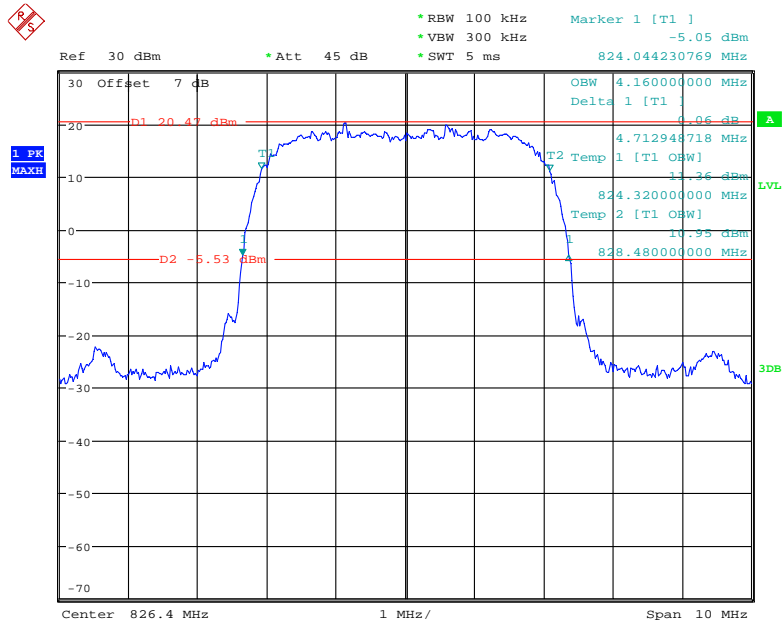

Date: 7.SEP.2021 08:56:49

26 dB Emissions & 99% Occupied Bandwidth for RMC (BPSK) Mode, Middle channel

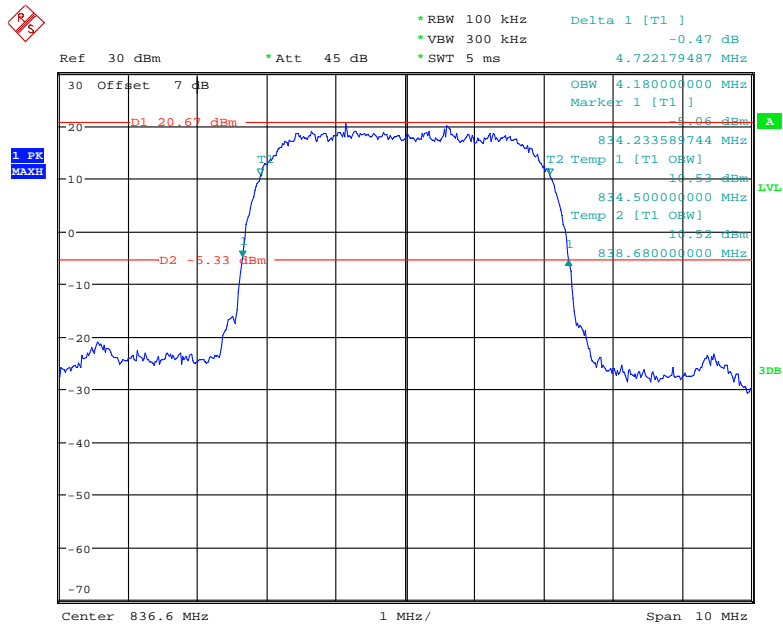

Date: 7.SEP.2021 08:59:05

26 dB Emissions & 99% Occupied Bandwidth for RMC (BPSK) Mode, High channel

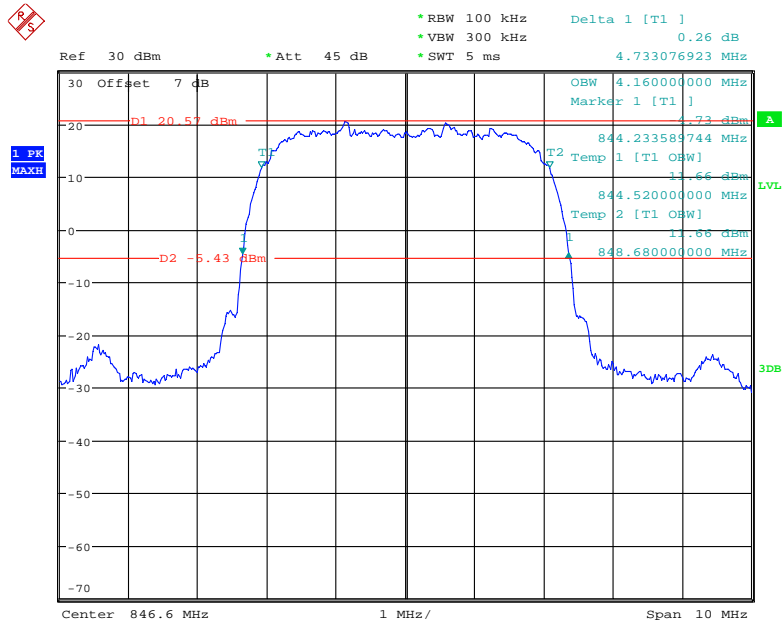

Date: 7.SEP.2021 09:03:37

26 dB Emissions & 99% Occupied Bandwidth for HSUPA (BPSK) Mode, Low channel

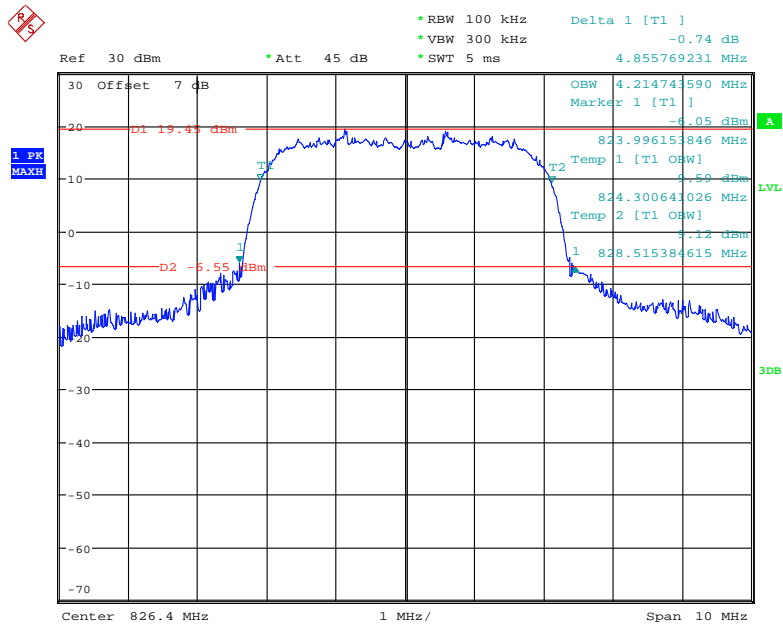

Date: 7.SEP.2021 10:12:55

26 dB Emissions & 99% Occupied Bandwidth for HSUPA (BPSK) Mode, Middle channel

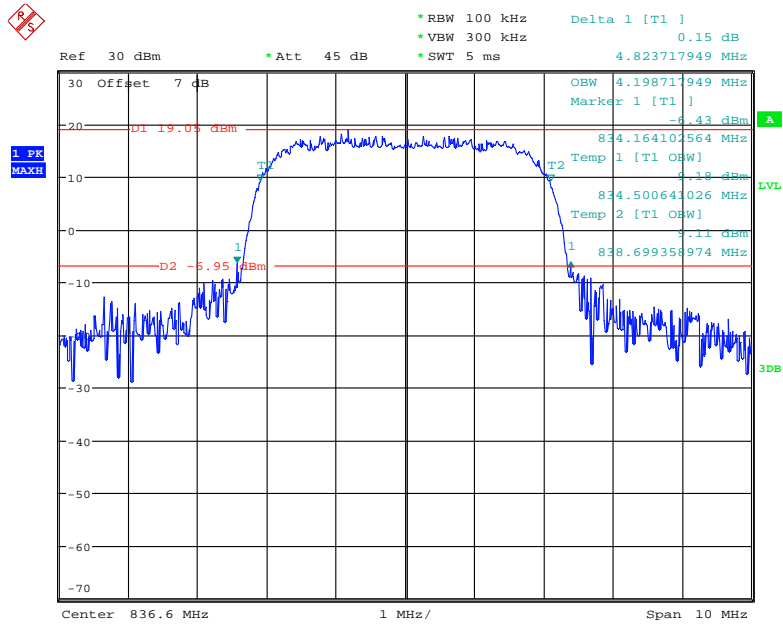

Date: 7.SEP.2021 10:14:32

26 dB Emissions & 99% Occupied Bandwidth for HSUPA (BPSK) Mode, High channel

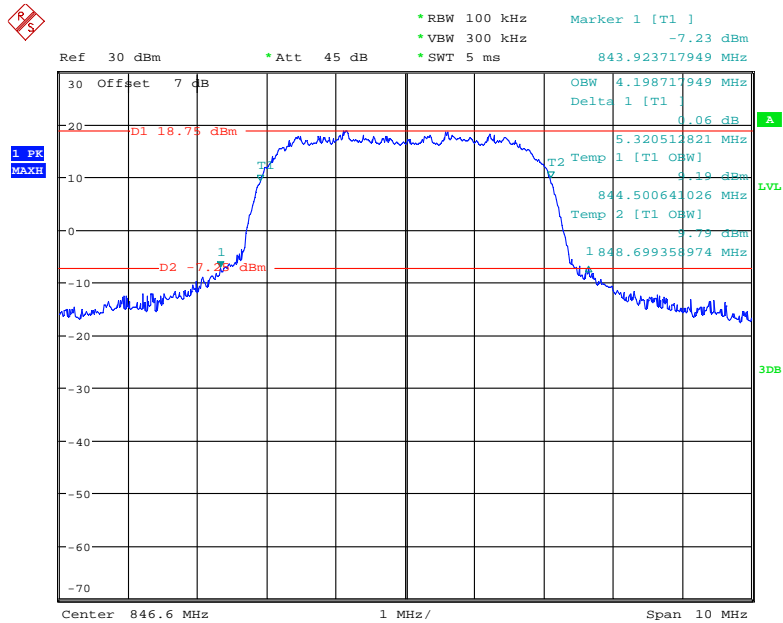

Date: 7.SEP.2021 10:18:50

26 dB Emissions & 99% Occupied Bandwidth for HSDPA (16QAM) Mode, Low channel

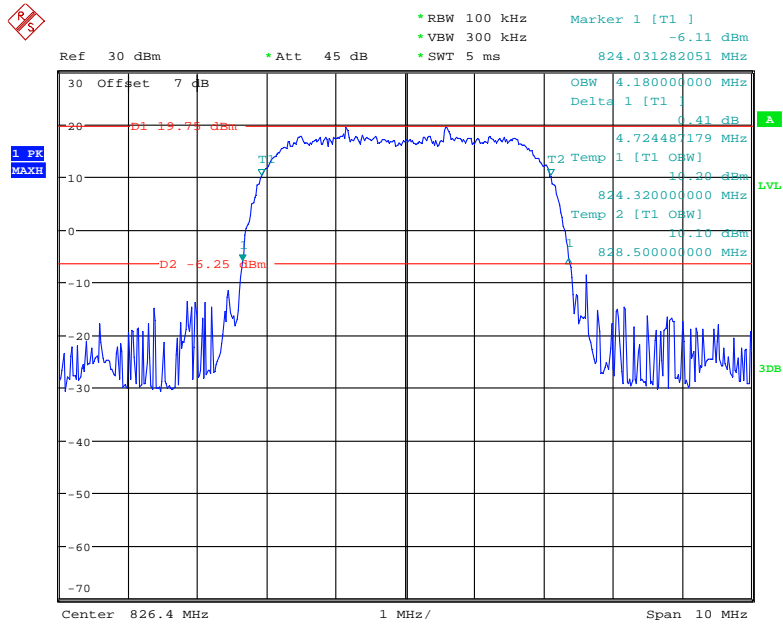

Date: 7.SEP.2021 09:24:59

26 dB Emissions & 99% Occupied Bandwidth for HSDPA (16QAM) Mode, Middle channel

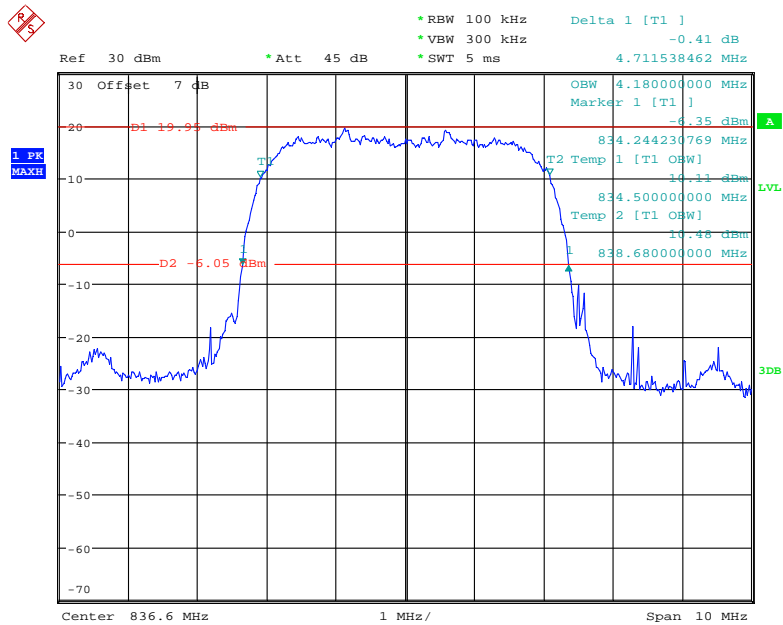

Date: 7.SEP.2021 09:29:02

26 dB Emissions & 99% Occupied Bandwidth for HSDPA (16QAM) Mode, High channel

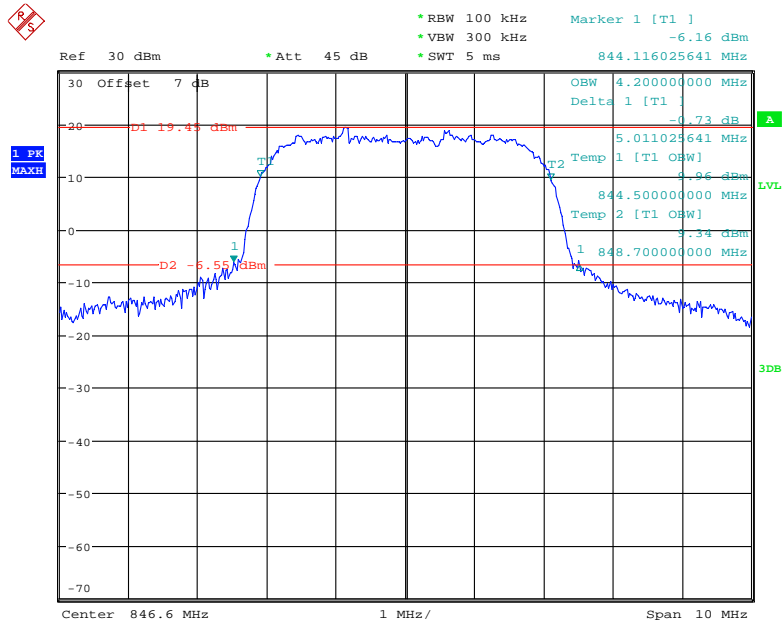

Date: 7.SEP.2021 09:31:27

PCS Band (Part 24E)

26 dB Emissions & 99% Occupied Bandwidth for GSM (GMSK) Mode, Low channel

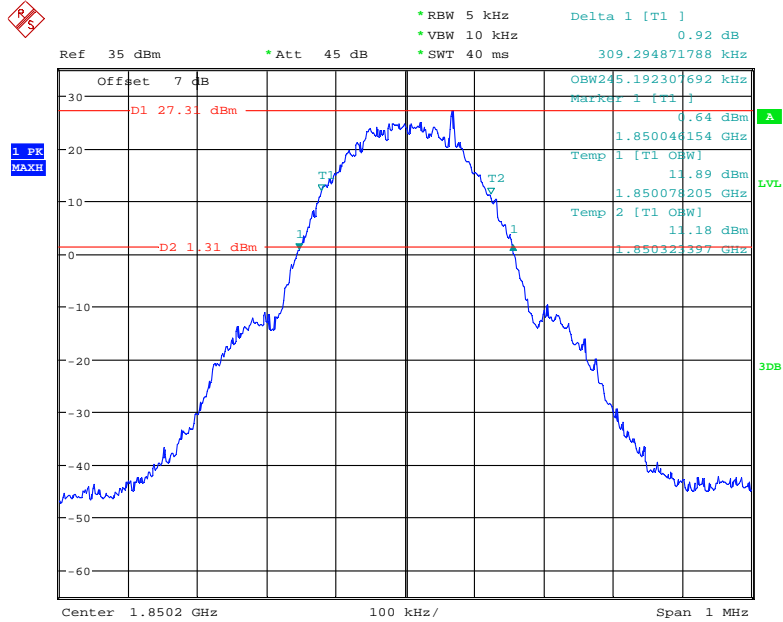

Date: 7.SEP.2021 13:46:34

26 dB Emissions & 99% Occupied Bandwidth for GSM (GMSK) Mode, Middle channel

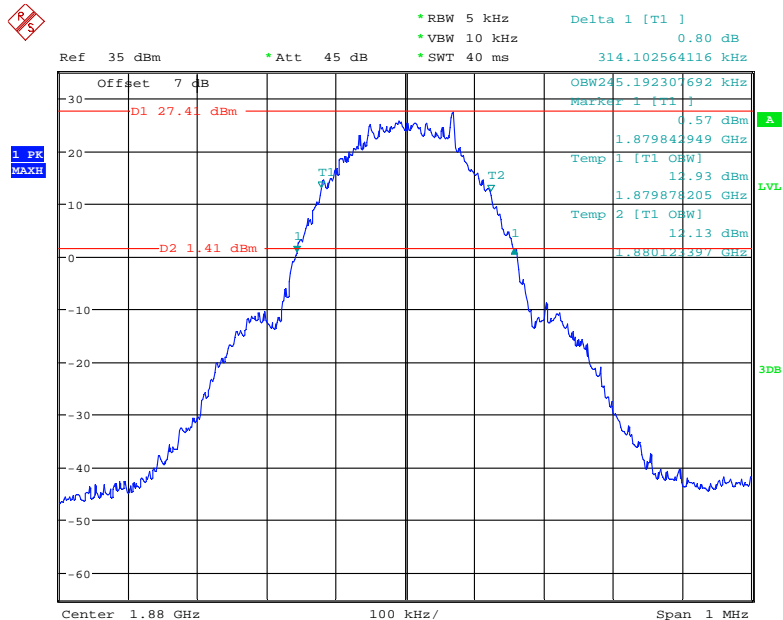

Date: 7.SEP.2021 13:48:49

26 dB Emissions & 99% Occupied Bandwidth for GSM (GMSK) Mode, High channel

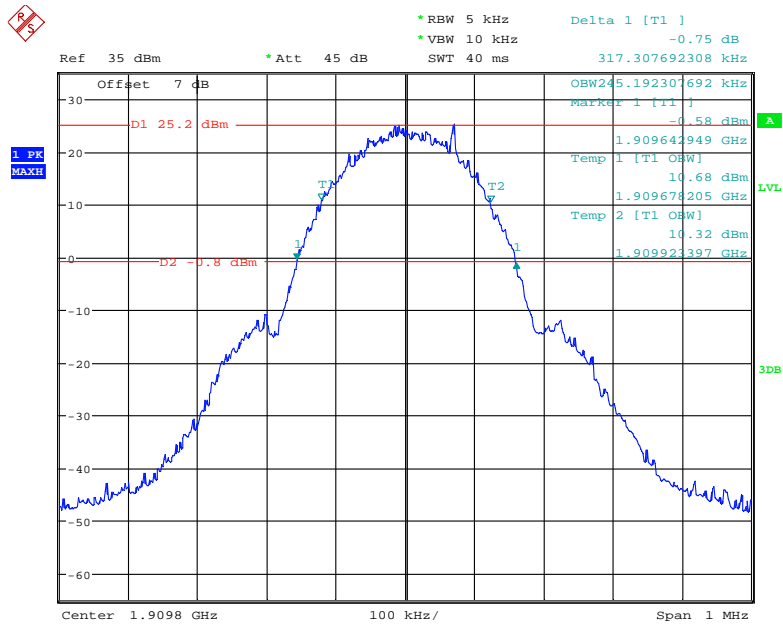

Date: 8.NOV.2021 09:27:34

26 dB Emissions & 99% Occupied Bandwidth for EGPRS (8PSK) Mode, Low channel

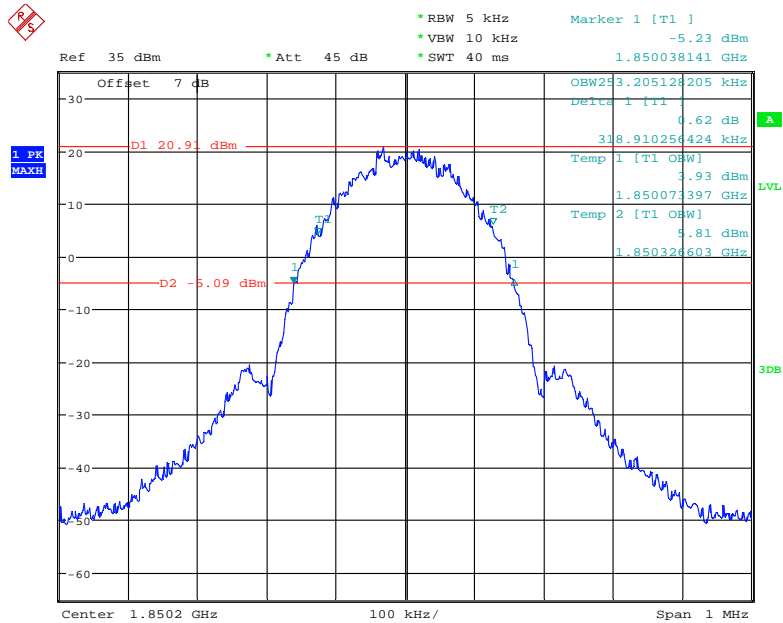

Date: 7.SEP.2021 14:00:53

26 dB Emissions & 99% Occupied Bandwidth for EGPRS (8PSK) Mode, Middle channel

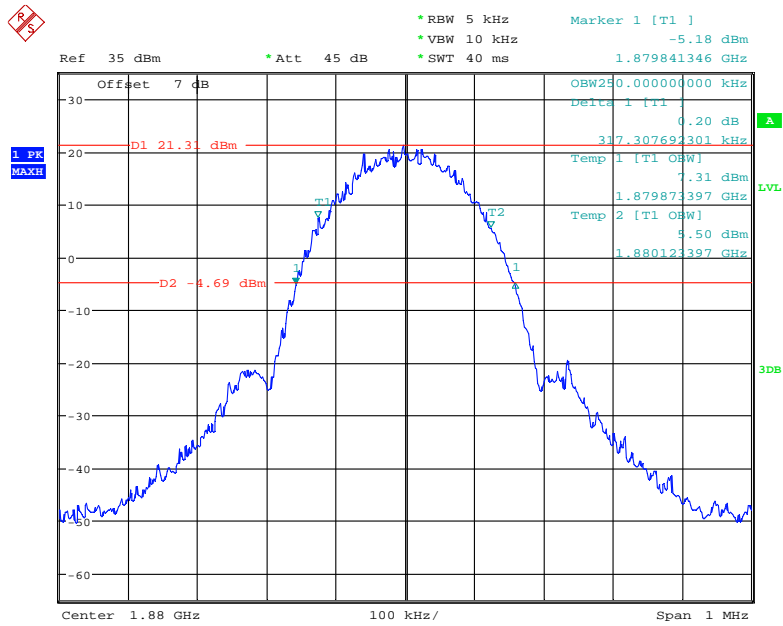

Date: 7.SEP.2021 14:04:03

26 dB Emissions & 99% Occupied Bandwidth for EGPRS (8PSK) Mode, High channel

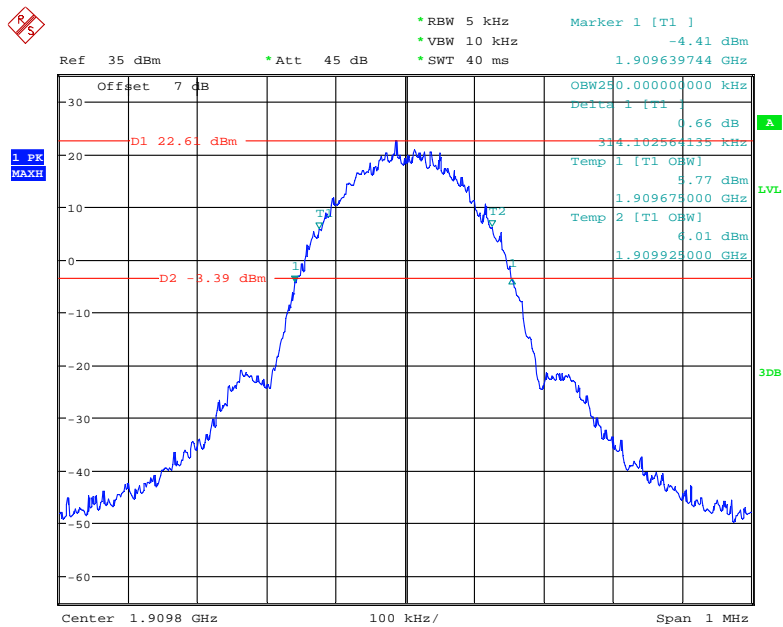

Date: 7.SEP.2021 14:05:29

26 dB Emissions & 99% Occupied Bandwidth for RMC (BPSK) Mode, Low channel

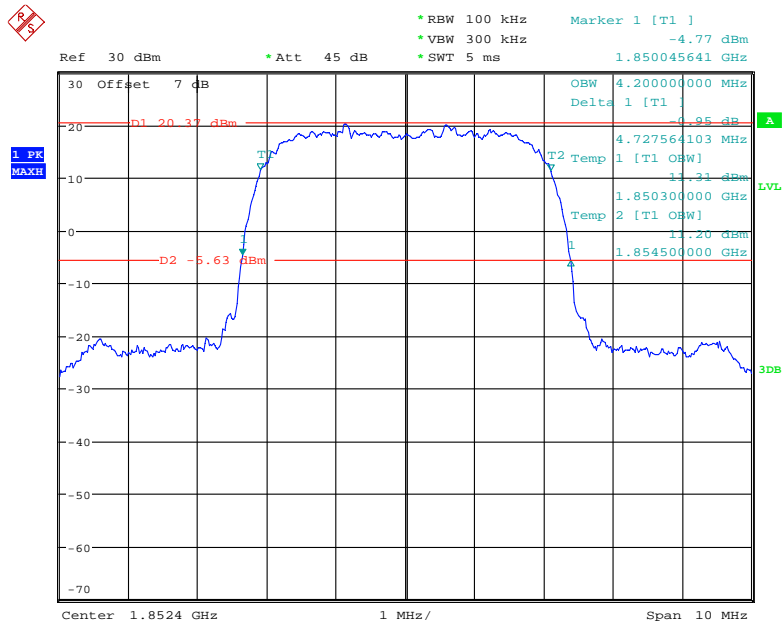

Date: 7.SEP.2021 08:38:57

26 dB Emissions & 99% Occupied Bandwidth for RMC (BPSK) Mode, Middle channel

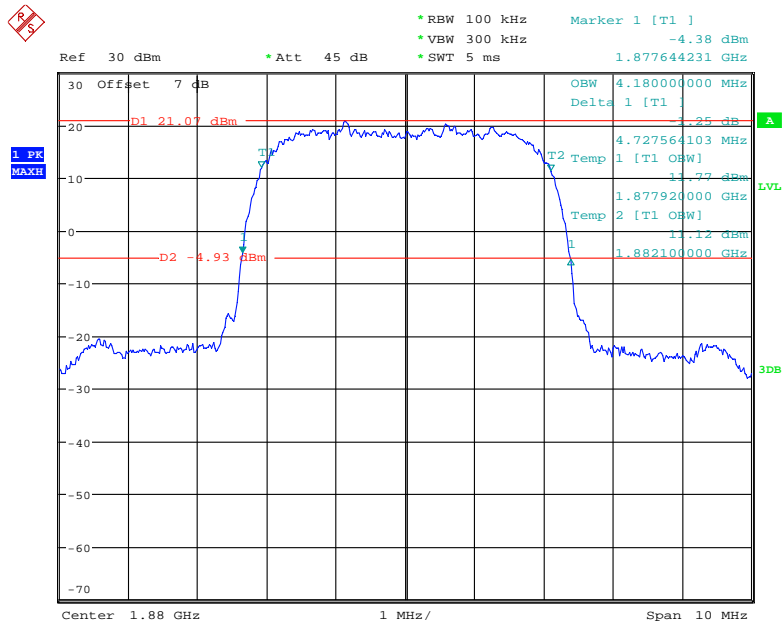

Date: 7.SEP.2021 08:46:59

26 dB Emissions & 99% Occupied Bandwidth for RMC (BPSK) Mode, High channel

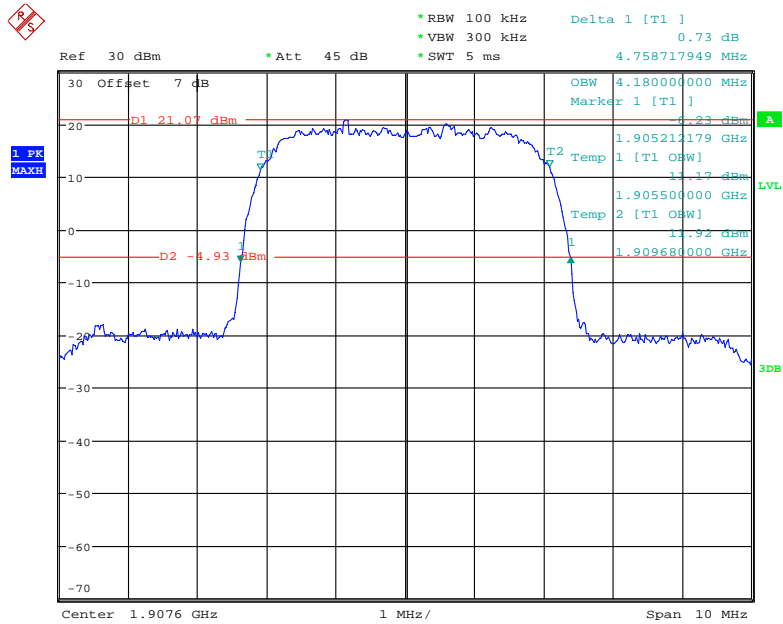

Date: 7.SEP.2021 08:45:26

26 dB Emissions & 99% Occupied Bandwidth for HSUPA (BPSK) Mode, Low channel

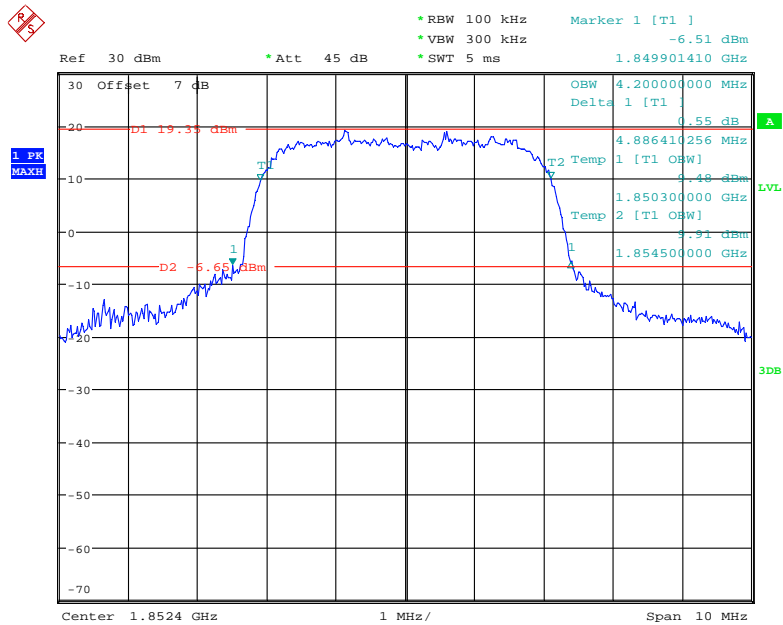

Date: 7.SEP.2021 09:36:44

26 dB Emissions & 99% Occupied Bandwidth for HSUPA (BPSK) Mode, Middle channel

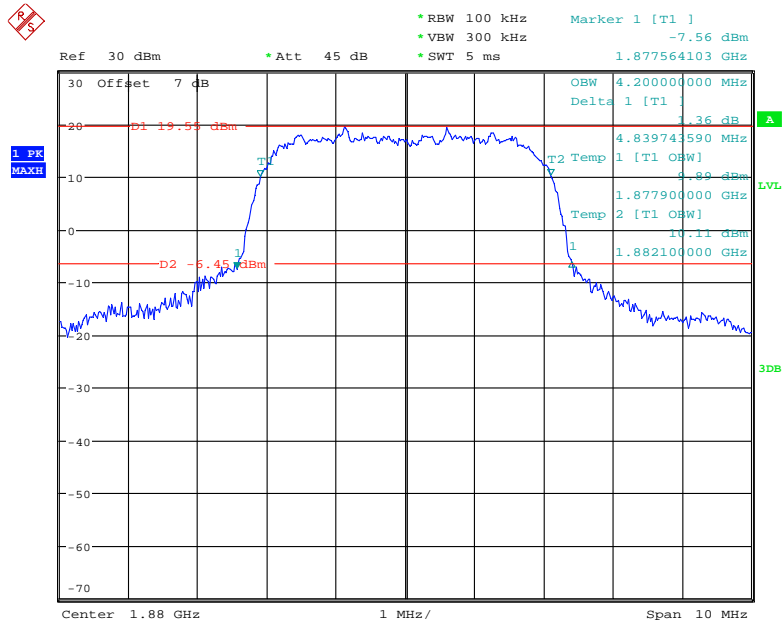

Date: 7.SEP.2021 09:38:52

26 dB Emissions & 99% Occupied Bandwidth for HSUPA (BPSK) Mode, High channel

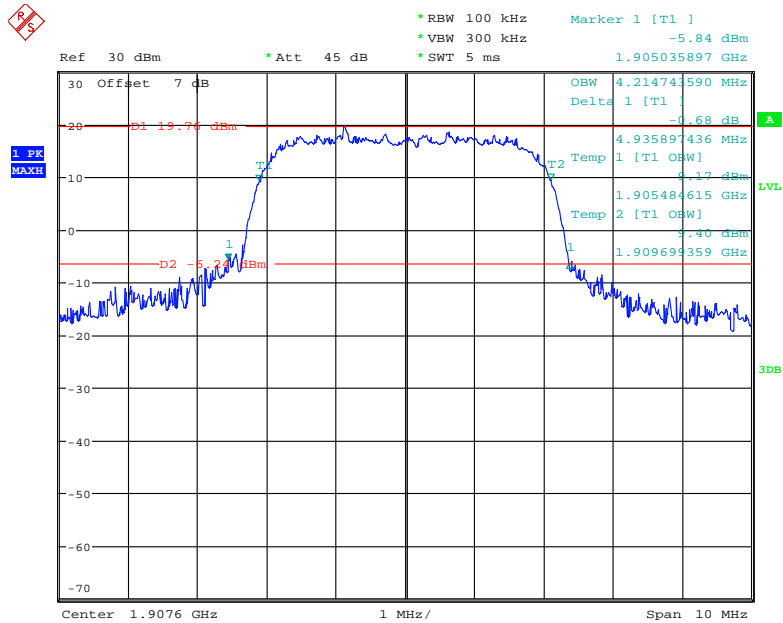

Date: 7.SEP.2021 09:45:52

26 dB Emissions & 99% Occupied Bandwidth for HSDPA (16QAM) Mode, Low channel

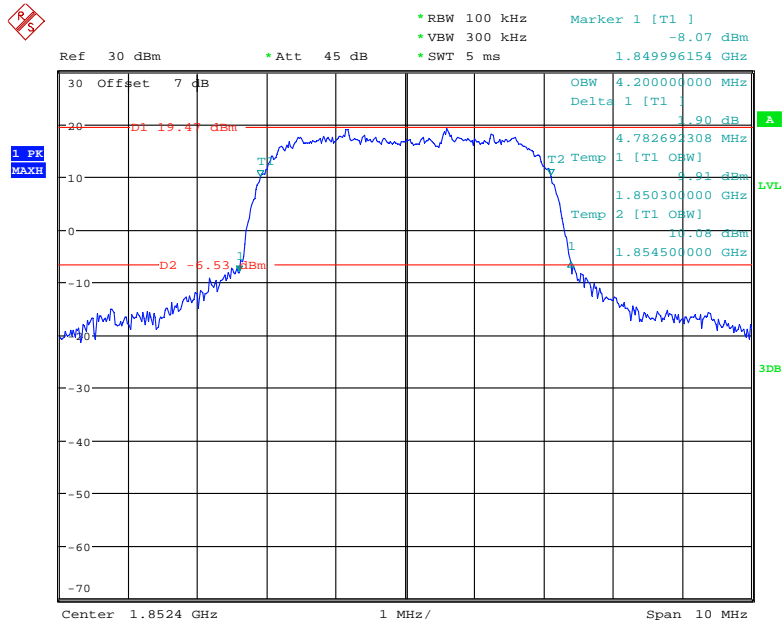

Date: 7.SEP.2021 09:07:25

26 dB Emissions & 99% Occupied Bandwidth for HSDPA (16QAM) Mode, Middle channel

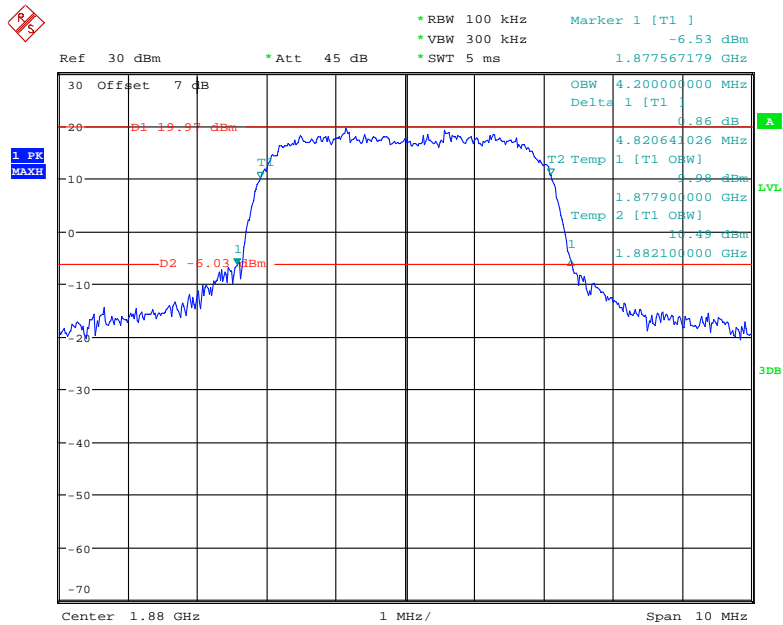

Date: 7.SEP.2021 09:09:23

26 dB Emissions & 99% Occupied Bandwidth for HSDPA (16QAM) Mode, High channel

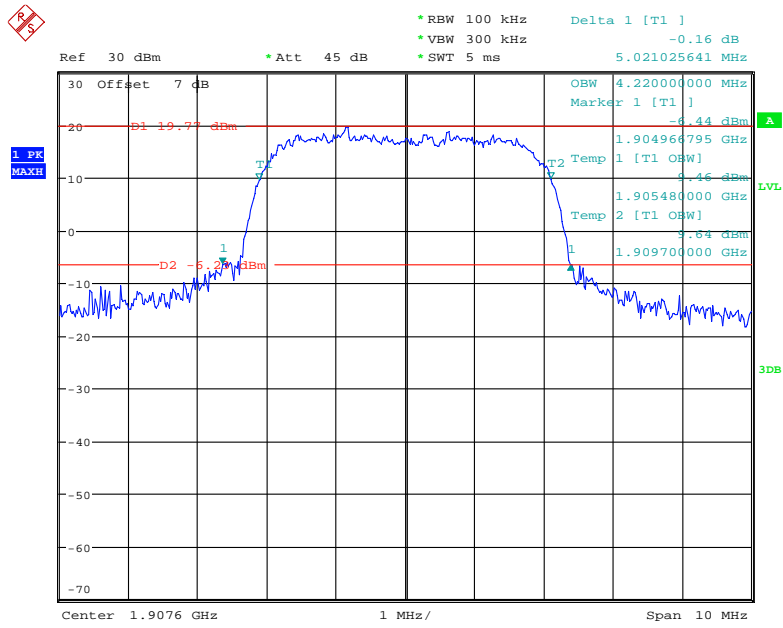

Date: 7.SEP.2021 09:12:25

AWS Band (Part 27)

26 dB Emissions & 99% Occupied Bandwidth for RMC (BPSK) Mode, Low channel

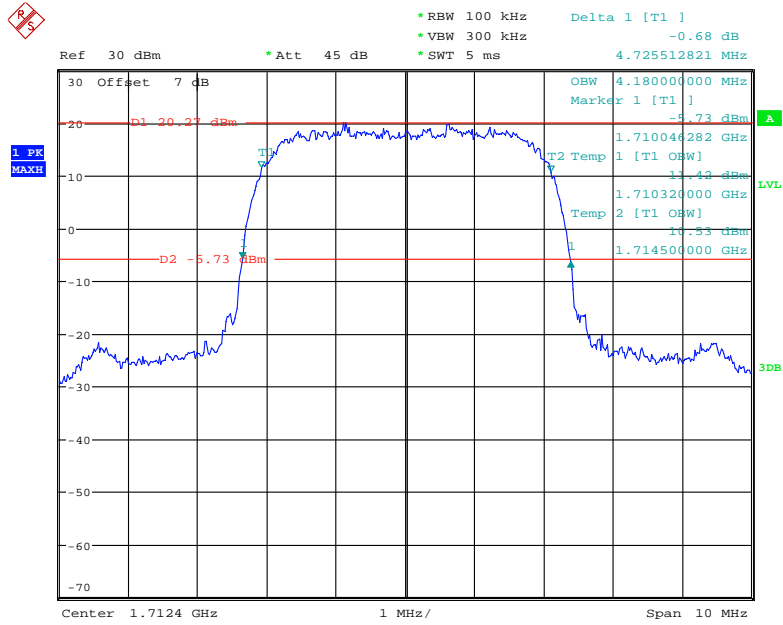

Date: 7.SEP.2021 08:50:44

26 dB Emissions & 99% Occupied Bandwidth for RMC (BPSK) Mode, Middle channel

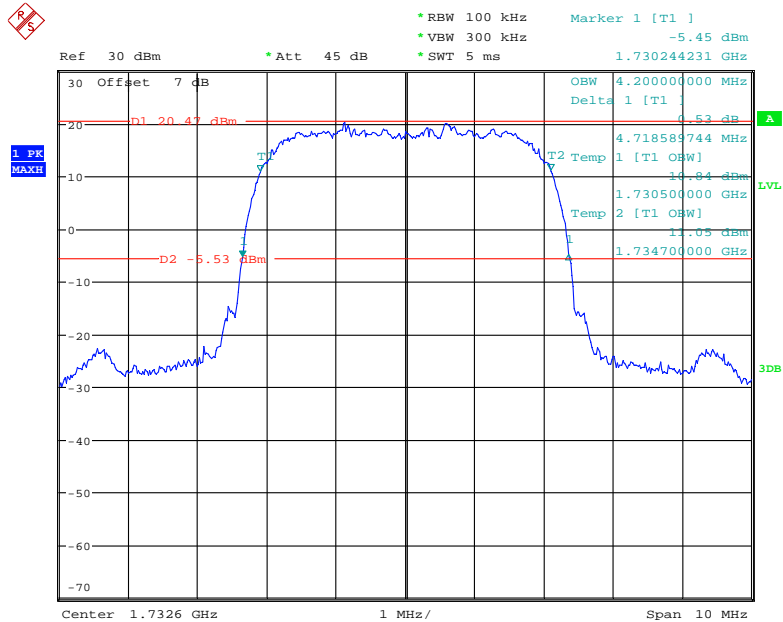

Date: 7.SEP.2021 08:52:37

26 dB Emissions & 99% Occupied Bandwidth for RMC (BPSK) Mode, High channel

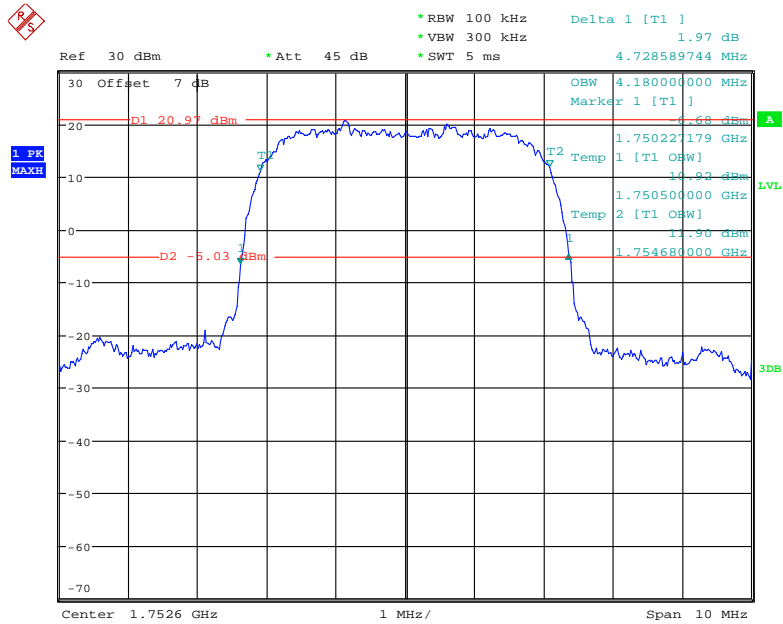

Date: 7.SEP.2021 08:54:33

26 dB Emissions & 99% Occupied Bandwidth for HSUPA (BPSK) Mode, Low channel

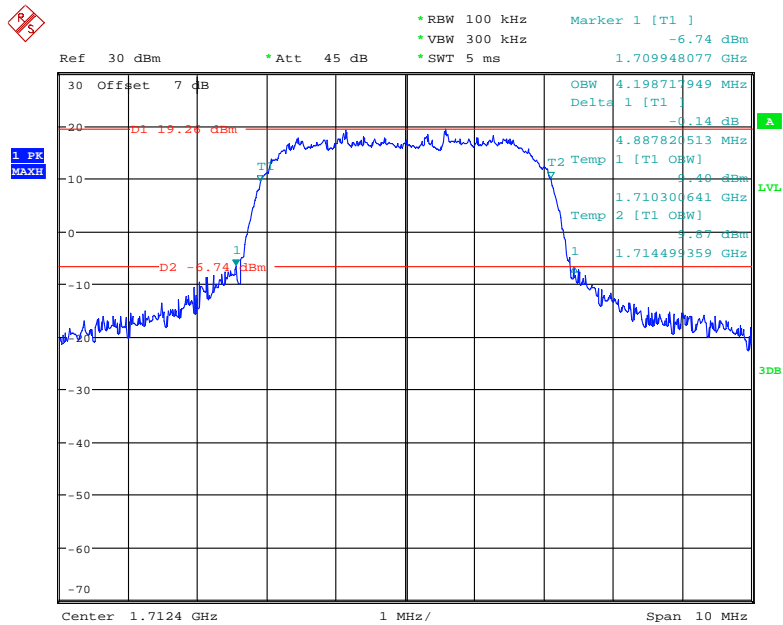

Date: 7.SEP.2021 10:00:57

26 dB Emissions & 99% Occupied Bandwidth for HSUPA (BPSK) Mode, Middle channel

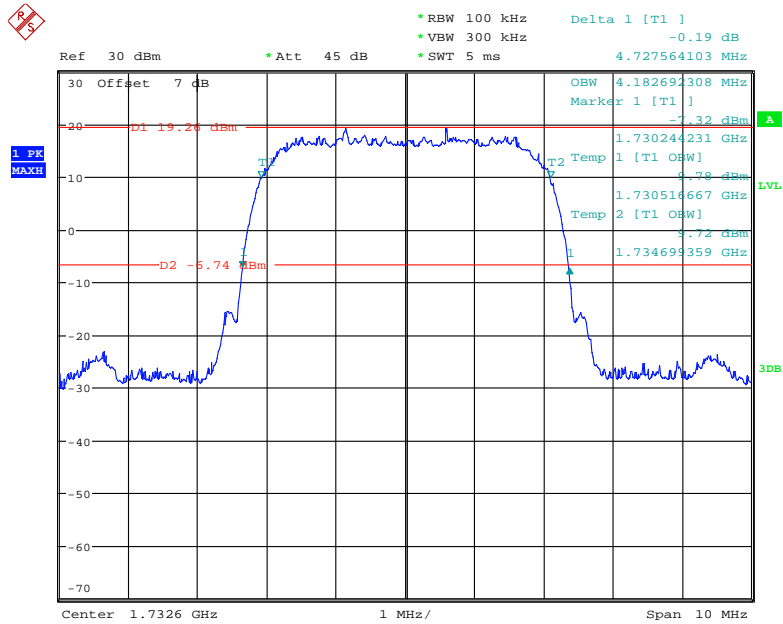

Date: 7.SEP.2021 10:02:48

26 dB Emissions & 99% Occupied Bandwidth for HSUPA (BPSK) Mode, High channel

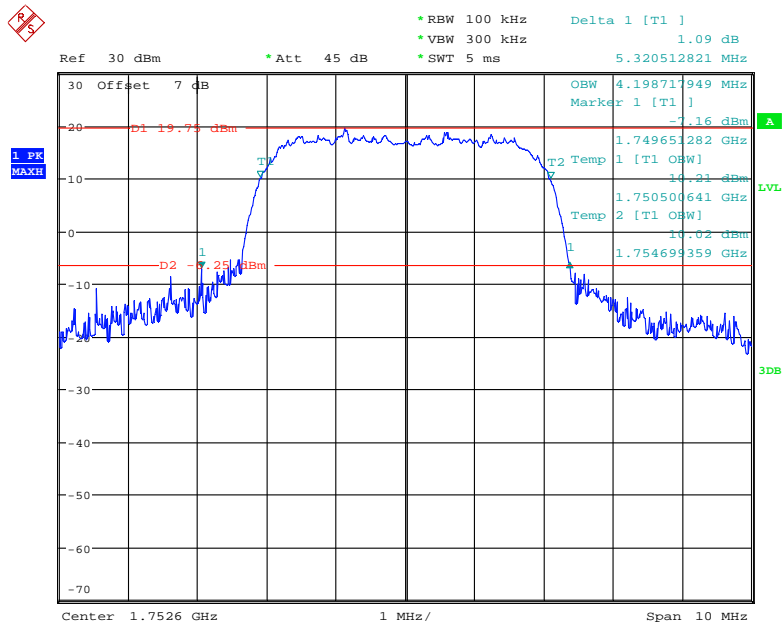

Date: 7.SEP.2021 10:08:32

26 dB Emissions & 99% Occupied Bandwidth for HSDPA (16QAM) Mode, Low channel

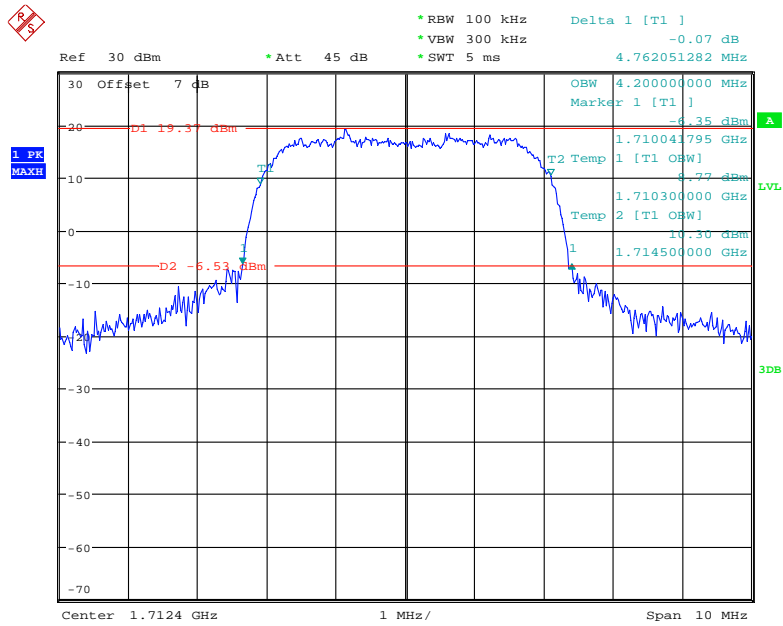

Date: 7.SEP.2021 09:15:17

26 dB Emissions & 99% Occupied Bandwidth for HSDPA (16QAM) Mode, Middle channel

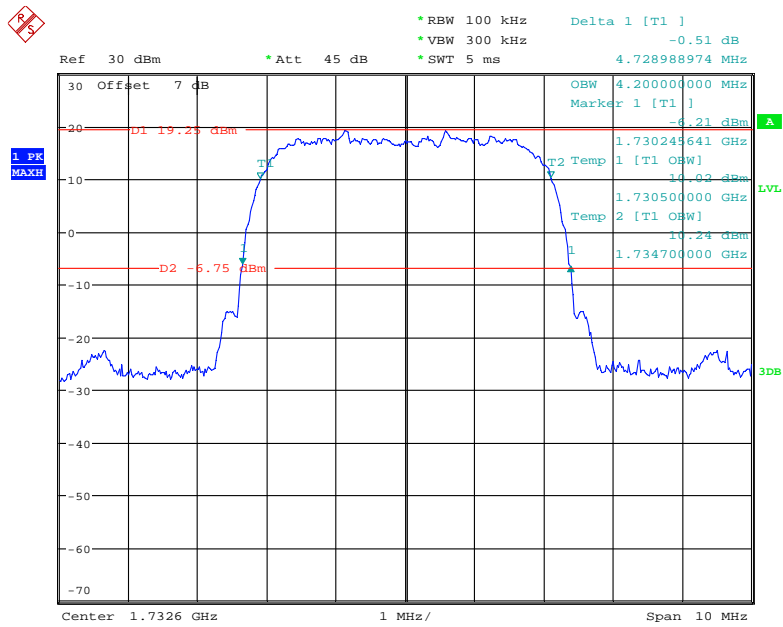

Date: 7.SEP.2021 09:20:38

26 dB Emissions & 99% Occupied Bandwidth for HSDPA (16QAM) Mode, High channel

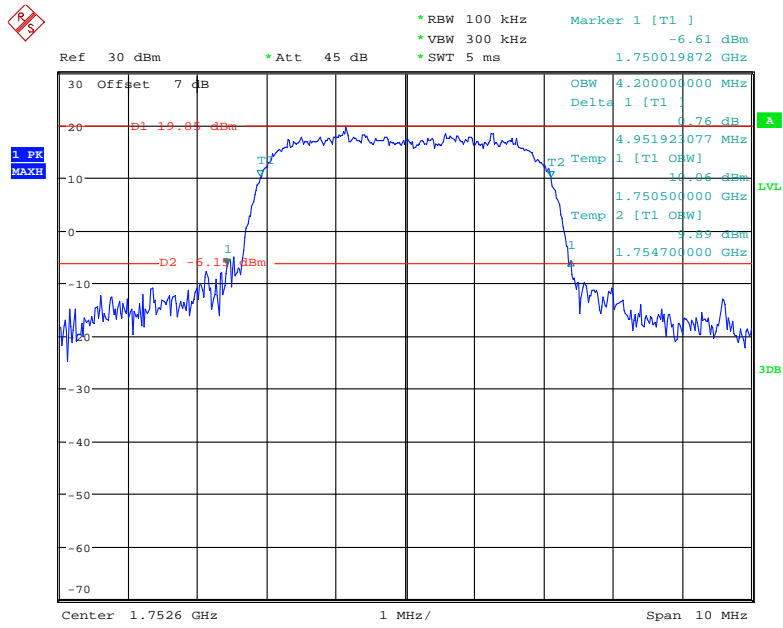

Date: 7.SEP.2021 09:22:16

LTE Band 2:

Bandwidth	Modulation	Low channel		Middle channel		High channel	
		OBW (MHz)	26dB EBW (MHz)	OBW (MHz)	26dB EBW (MHz)	OBW (MHz)	26dB EBW (MHz)
1.4 MHz	QPSK	1.111	1.298	1.104	1.296	1.098	1.308
	16QAM	1.098	1.290	1.098	1.302	1.110	1.326
3 MHz	QPSK	2.688	2.868	2.700	2.892	2.688	2.892
	16QAM	2.688	2.892	2.688	2.880	2.688	2.880
5 MHz	QPSK	4.540	4.940	4.520	5.600	4.500	4.940
	16QAM	4.520	4.960	4.540	5.640	4.520	4.920
10 MHz	QPSK	9.000	9.680	8.960	9.600	8.960	9.600
	16QAM	8.960	9.520	8.960	9.640	8.960	9.600
15 MHz	QPSK	13.560	15.060	13.500	14.820	13.560	14.820
	16QAM	13.510	14.808	13.510	14.856	13.560	14.700
20 MHz	QPSK	18.000	20.000	18.080	19.360	17.920	19.520
	16QAM	18.080	19.360	18.000	19.360	17.920	19.360

LTE Band 4:

Bandwidth	Modulation	Low channel		Middle channel		High channel	
		OBW (MHz)	26dB EBW (MHz)	OBW (MHz)	26dB EBW (MHz)	OBW (MHz)	26dB EBW (MHz)
1.4 MHz	QPSK	1.098	1.308	1.104	1.308	1.098	1.290
	16QAM	1.104	1.320	1.098	1.284	1.104	1.296
3 MHz	QPSK	2.688	2.880	2.688	2.880	2.688	2.892
	16QAM	2.688	2.892	2.688	2.880	2.688	2.892
5 MHz	QPSK	4.520	4.940	4.520	4.940	4.520	4.920
	16QAM	4.500	4.900	4.520	4.960	4.520	4.960
10 MHz	QPSK	8.960	9.640	8.960	9.600	8.960	9.640
	16QAM	8.960	9.520	8.960	9.600	8.960	9.600
15 MHz	QPSK	13.500	14.820	13.500	14.760	13.560	14.760
	16QAM	13.500	14.820	13.560	14.760	13.560	14.880
20 MHz	QPSK	18.012	19.615	18.000	19.440	17.949	19.423
	16QAM	18.000	19.360	18.000	19.360	18.000	19.280

LTE Band 5:

Bandwidth	Modulation	Low channel		Middle channel		High channel	
		OBW (MHz)	26dB EBW (MHz)	OBW (MHz)	26dB EBW (MHz)	OBW (MHz)	26dB EBW (MHz)
1.4 MHz	QPSK	1.115	1.649	1.104	1.308	1.104	1.290
	16QAM	1.110	1.344	1.098	1.290	1.098	1.296
3 MHz	QPSK	2.688	2.868	2.688	2.880	2.688	2.892
	16QAM	2.688	2.892	2.688	2.880	2.676	2.892
5 MHz	QPSK	4.503	5.641	4.520	4.940	4.500	4.920
	16QAM	4.500	5.120	4.520	4.940	4.500	4.980
10 MHz	QPSK	8.960	9.640	9.000	11.240	8.960	9.600
	16QAM	8.960	9.520	8.960	9.520	8.960	9.600

LTE Band 7:

Bandwidth	Modulation	Low channel		Middle channel		High channel	
		OBW (MHz)	26dB EBW (MHz)	OBW (MHz)	26dB EBW (MHz)	OBW (MHz)	26dB EBW (MHz)
5 MHz	QPSK	4.540	4.940	4.520	4.920	4.500	4.920
	16QAM	4.500	4.900	4.520	4.940	4.520	4.960
10 MHz	QPSK	8.960	9.600	8.960	9.600	8.960	9.520
	16QAM	8.960	9.560	8.960	9.600	8.960	9.560
15 MHz	QPSK	13.560	14.880	13.500	14.760	13.500	14.820
	16QAM	13.560	14.760	13.560	14.760	13.500	14.820
20 MHz	QPSK	17.920	19.280	17.920	19.440	17.949	19.359
	16QAM	18.000	19.360	18.000	19.360	18.000	19.360

LTE Band 17

Bandwidth	Modulation	Low channel		Middle channel		High channel	
		OBW (MHz)	26dB EBW (MHz)	OBW (MHz)	26dB EBW (MHz)	OBW (MHz)	26dB EBW (MHz)
5 MHz	QPSK	4.520	5.100	4.520	5.220	4.520	5.200
	16QAM	4.500	5.060	4.567	5.609	4.535	5.154
10 MHz	QPSK	8.960	9.880	8.960	9.640	8.960	9.840
	16QAM	8.960	9.840	8.960	9.720	9.000	9.840

LTE Band 38

Bandwidth	Modulation	Low channel		Middle channel		High channel	
		OBW (MHz)	26dB EBW (MHz)	OBW (MHz)	26dB EBW (MHz)	OBW (MHz)	26dB EBW (MHz)
5 MHz	QPSK	4.515	5.297	4.520	5.260	4.515	5.210
	16QAM	4.520	5.200	4.515	5.239	4.500	5.060
10 MHz	QPSK	8.960	9.680	8.973	9.899	8.960	9.560
	16QAM	8.960	9.560	8.960	9.560	8.960	10.120
15 MHz	QPSK	13.620	15.780	13.502	15.586	13.500	15.240
	16QAM	13.500	16.380	13.560	16.020	13.620	15.840
20 MHz	QPSK	18.000	19.920	17.945	19.501	18.003	19.392
	16QAM	17.945	19.855	17.887	19.797	17.920	19.520

LTE Band 41

Bandwidth	Modulation	Low channel		Middle channel		High channel	
		OBW (MHz)	26dB EBW (MHz)	OBW (MHz)	26dB EBW (MHz)	OBW (MHz)	26dB EBW (MHz)
5 MHz	QPSK	4.520	5.300	4.500	4.940	4.520	4.940
	16QAM	4.500	4.940	4.520	5.140	4.520	5.100
10 MHz	QPSK	8.960	9.600	9.000	9.600	8.960	9.880
	16QAM	8.960	9.480	8.960	9.520	8.960	10.120
15 MHz	QPSK	13.560	15.480	13.560	15.720	13.500	15.540
	16QAM	13.620	15.900	13.560	15.420	13.620	16.800
20 MHz	QPSK	18.000	19.840	18.000	19.680	18.000	20.400
	16QAM	18.000	19.600	18.000	20.640	18.000	19.280

LTE Band 66:

Bandwidth	Modulation	Low channel		Middle channel		High channel	
		OBW (MHz)	26dB EBW (MHz)	OBW (MHz)	26dB EBW (MHz)	OBW (MHz)	26dB EBW (MHz)
1.4 MHz	QPSK	1.098	1.308	1.104	1.302	1.110	1.290
	16QAM	1.104	1.320	1.098	1.290	1.104	1.296
3 MHz	QPSK	2.683	2.875	2.688	2.880	2.688	2.892
	16QAM	2.688	2.892	2.688	2.892	2.688	2.868
5 MHz	QPSK	4.540	5.180	4.520	5.200	4.520	5.140
	16QAM	4.540	5.160	4.560	5.160	4.551	5.256
10 MHz	QPSK	9.000	9.880	8.960	9.840	8.960	9.760
	16QAM	9.000	10.000	8.974	9.872	9.000	9.880
15 MHz	QPSK	13.560	15.780	13.500	15.120	13.560	15.240
	16QAM	13.560	15.060	13.500	15.060	13.560	15.180
20 MHz	QPSK	18.000	19.680	17.949	19.679	18.077	18.872
	16QAM	18.000	19.680	18.013	19.936	18.000	19.600

The test plots of LTE band please refer to the Appendix A.

FCC §2.1051, §22.917(a) & §24.238(a); §27.53 - SPURIOUS EMISSIONS AT ANTENNA TERMINALS

Applicable Standard

FCC §2.1051, §22.917(a) and §24.238(a) and §27.53.

The spectrum was to be investigated to the tenth harmonics of the highest fundamental frequency as specified in § 2.1051.

Test Procedure

The RF output of the transceiver was connected to a spectrum analyzer and simulator through appropriate attenuation. The resolution bandwidth of the spectrum analyzer was set at 1MHz. Sufficient scans were taken to show any out of band emissions up to 10th harmonic.

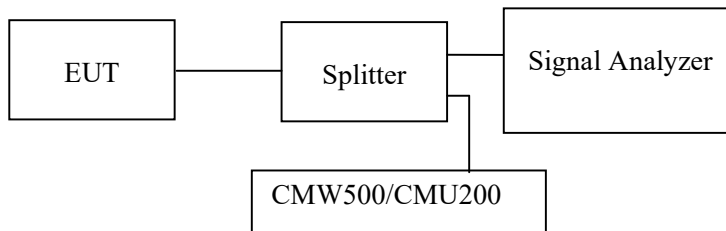

Test Data

Environmental Conditions

Temperature:	27 °C
Relative Humidity:	58 %
ATM Pressure:	101.0 kPa

The testing was performed by Ting Lv from 2021-09-07 to 2021-09-09.

EUT operation mode: Transmitting

Test result: Pass

Please refer to the following plots.

**Cellular Band (Part 22H)
Low Channel:**

30 MHz – 1 GHz (GSM Mode)

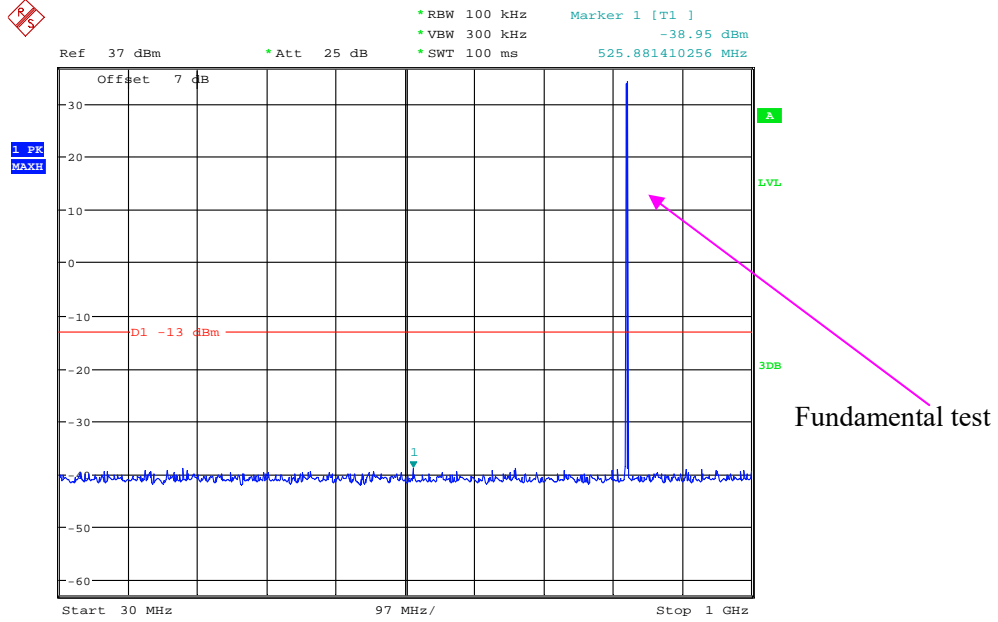

Date: 7.SEP.2021 16:00:43

1 GHz – 10 GHz (GSM Mode)

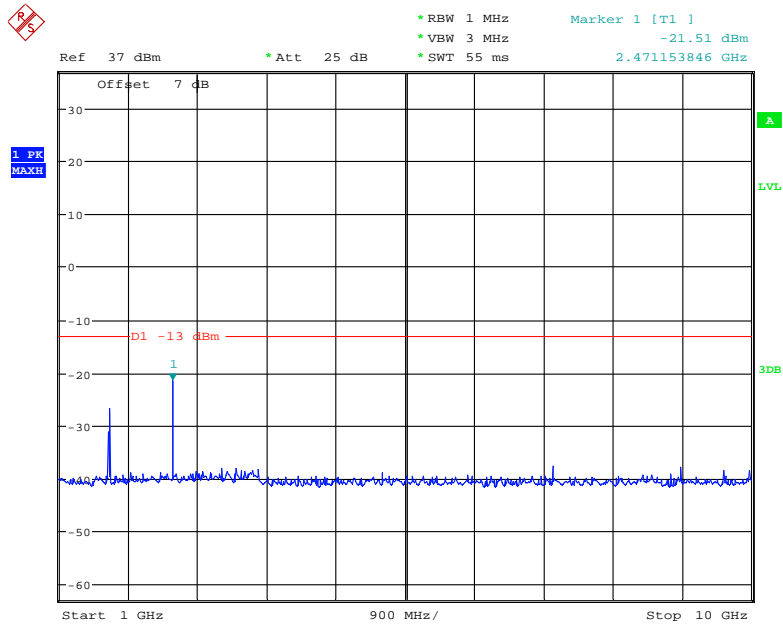

Date: 7.SEP.2021 15:57:07

30 MHz – 1 GHz (WCDMA Mode)

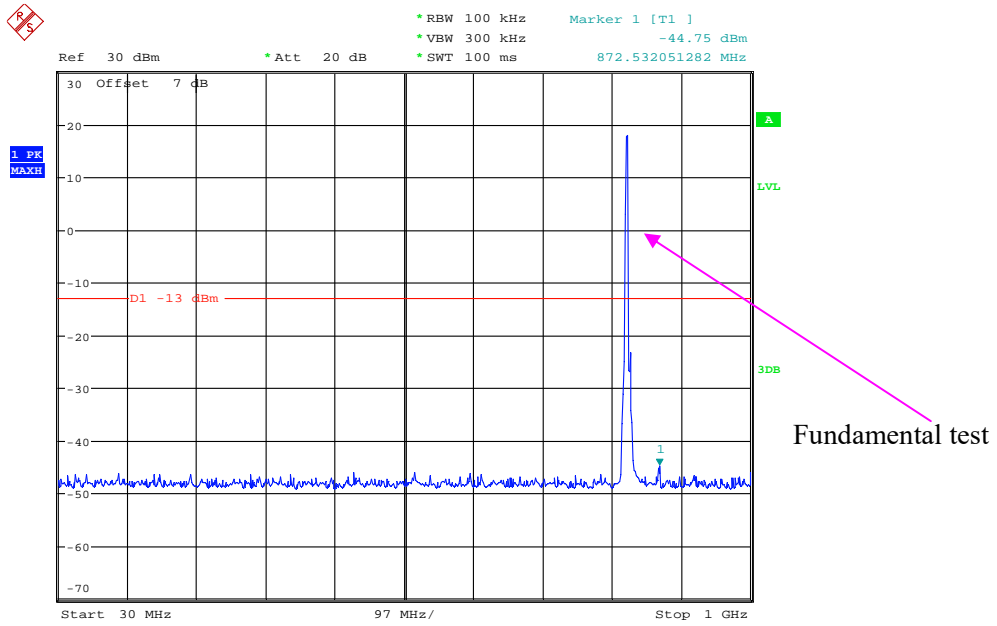

Date: 7.SEP.2021 11:22:11

1 GHz – 10 GHz (WCDMA Mode)

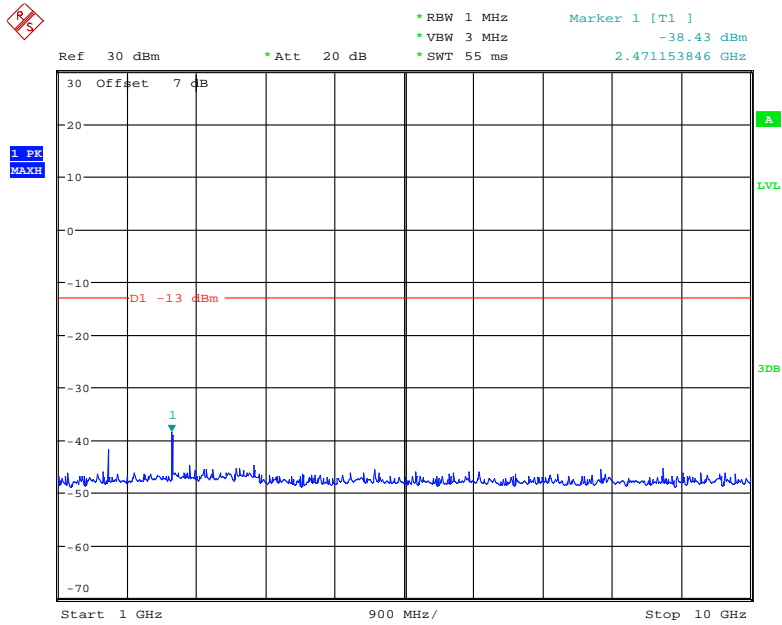

Date: 7.SEP.2021 11:25:44

Middle Channel:

30 MHz – 1 GHz (GSM Mode)

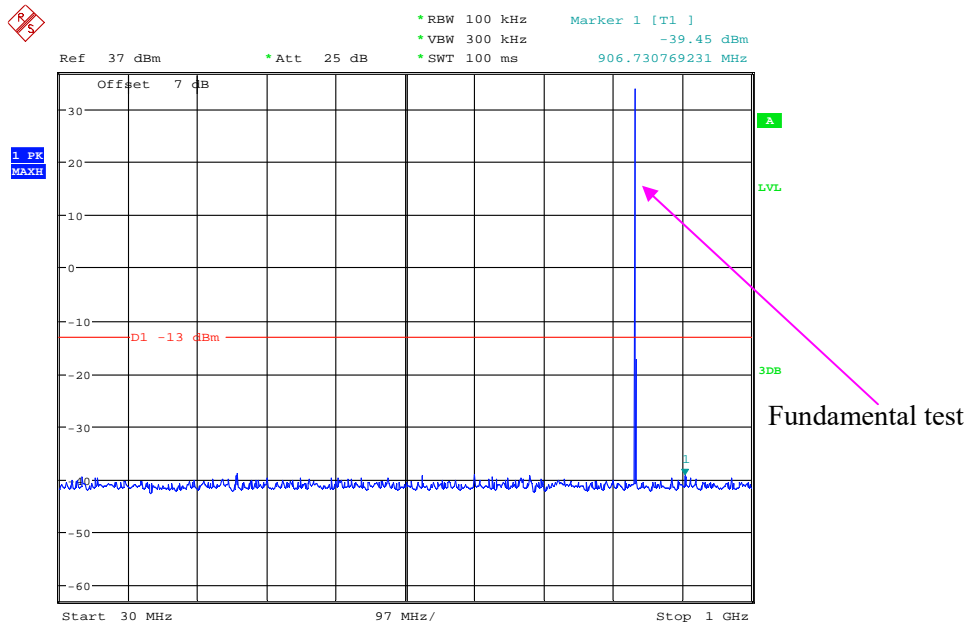

Date: 7.SEP.2021 16:00:05

1 GHz – 10 GHz (GSM Mode)

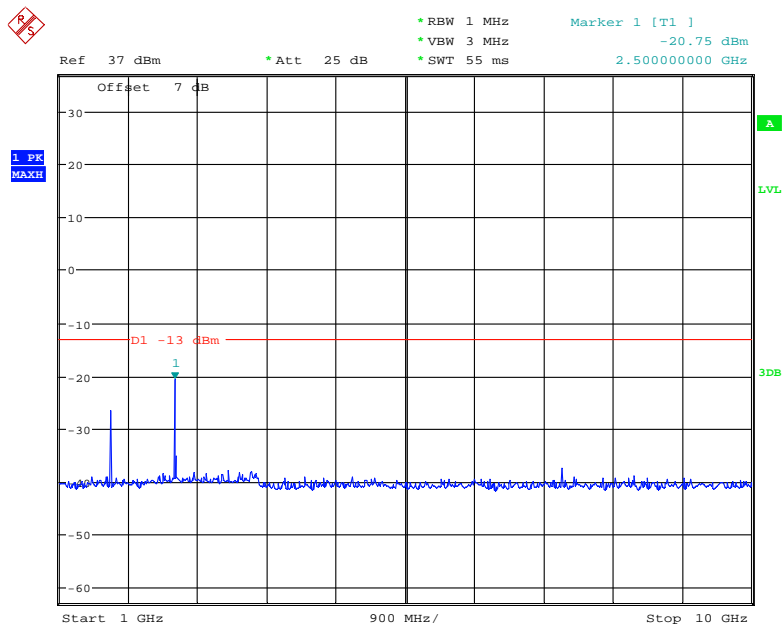

Date: 7.SEP.2021 15:58:00

30 MHz – 1 GHz (WCDMA Mode)

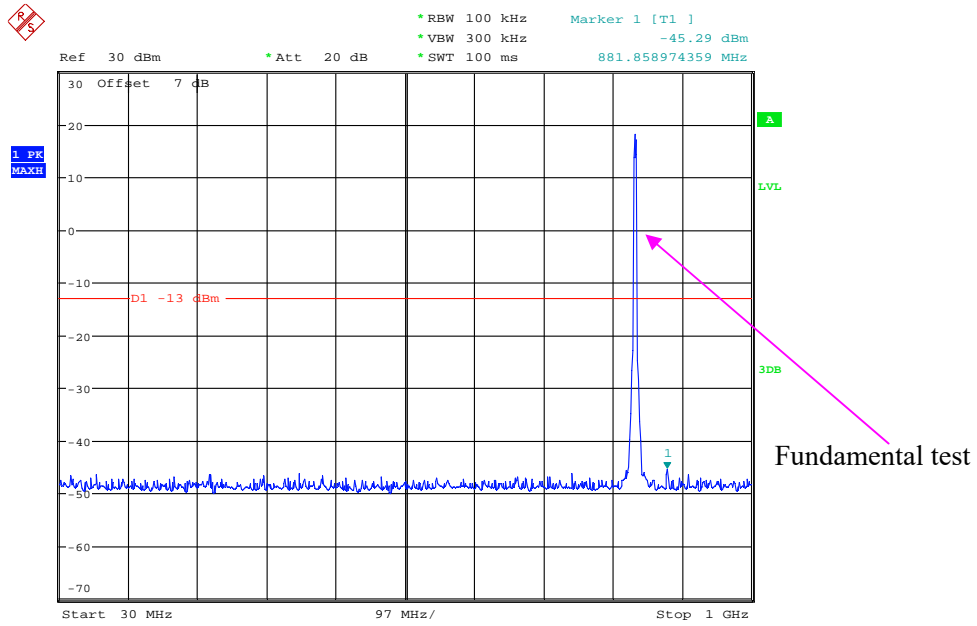

Date: 7.SEP.2021 11:22:47

1 GHz – 10 GHz (WCDMA Mode)

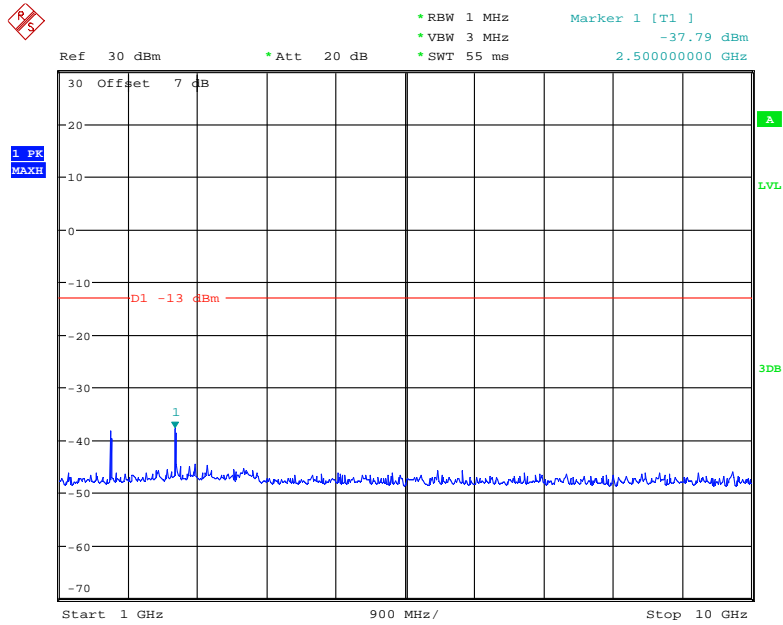

Date: 7.SEP.2021 11:25:27

High Channel:

30 MHz – 1 GHz (GSM Mode)

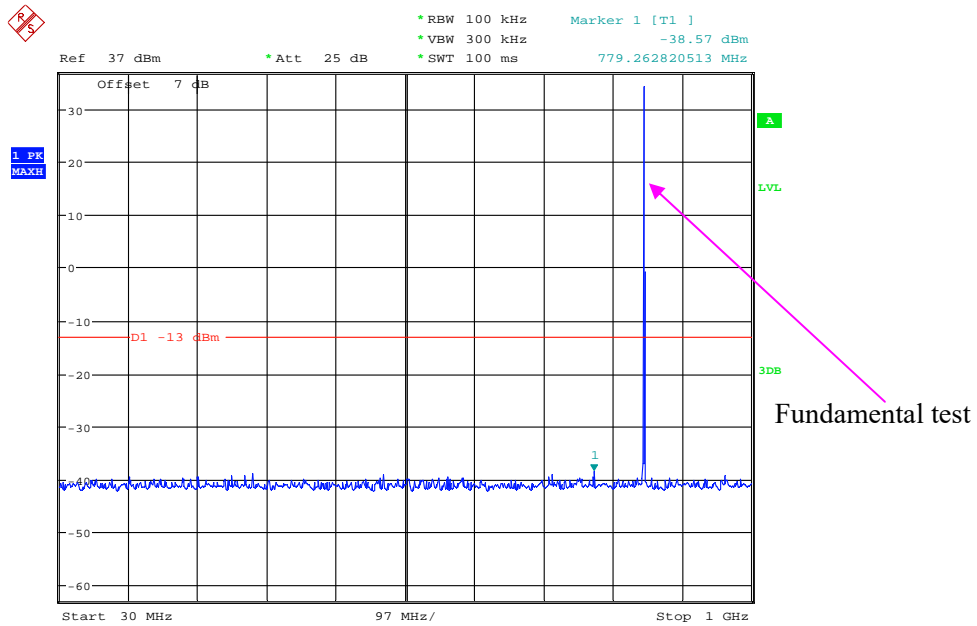

Date: 7.SEP.2021 15:59:21

1 GHz – 10 GHz (GSM Mode)

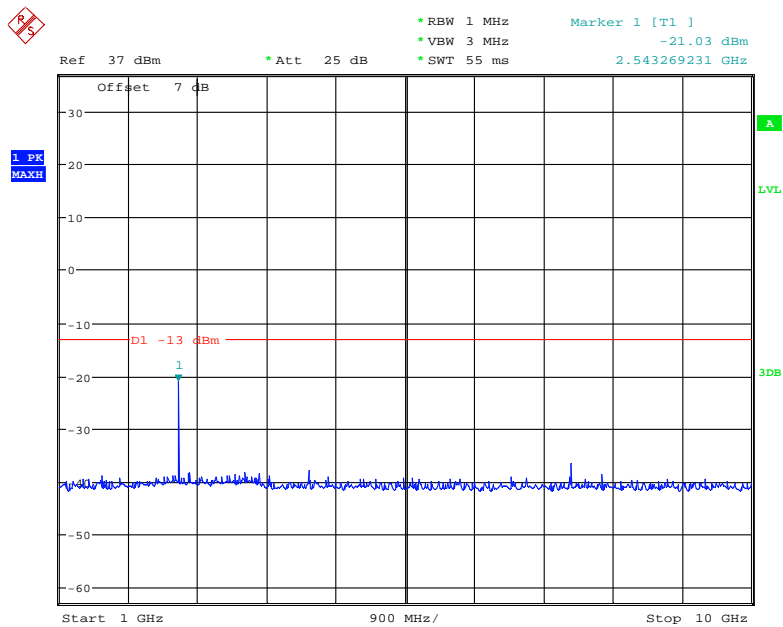

Date: 7.SEP.2021 15:58:17

30 MHz – 1 GHz (WCDMA Mode)

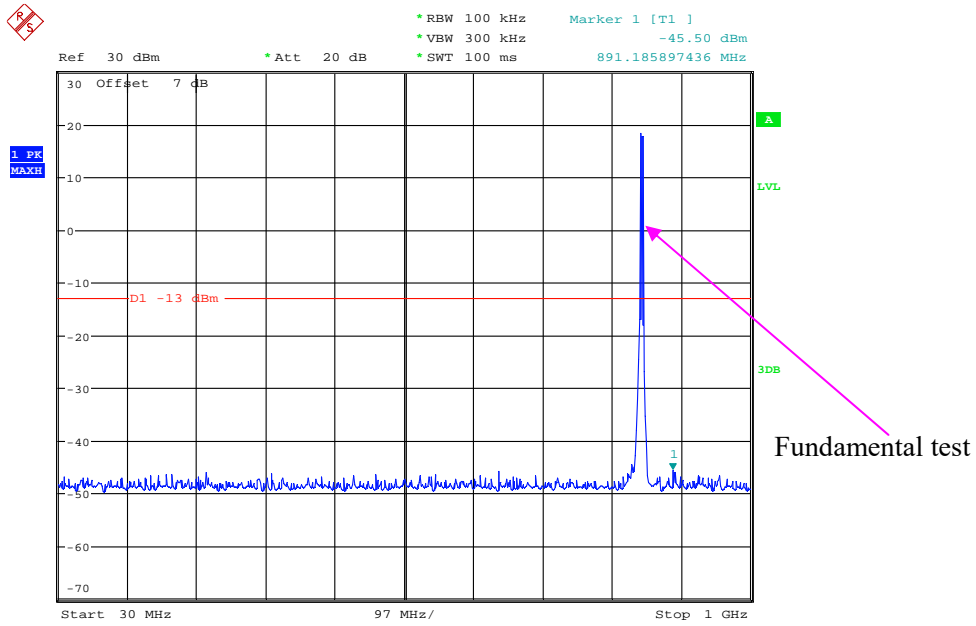

Date: 7.SEP.2021 11:23:06

1 GHz – 10 GHz (WCDMA Mode)

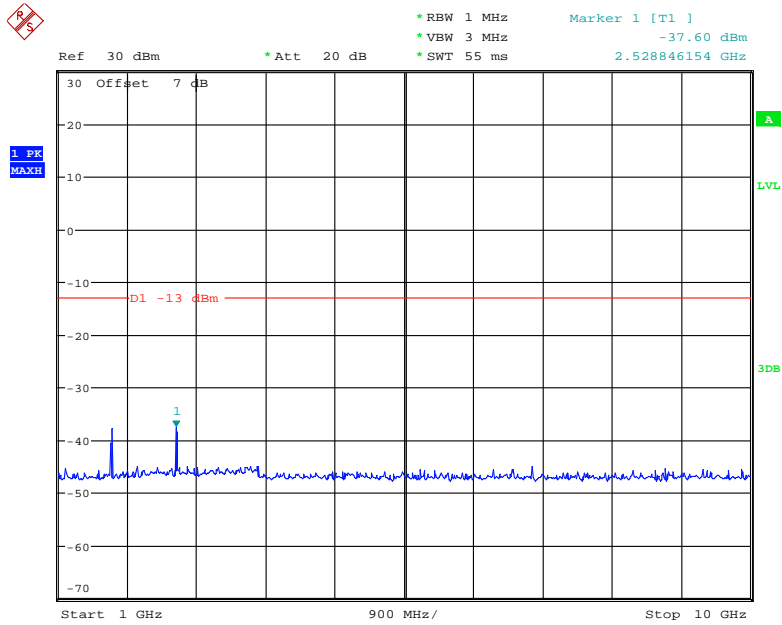

Date: 7.SEP.2021 11:25:05

2 GHz – 20 GHz (GSM Mode)

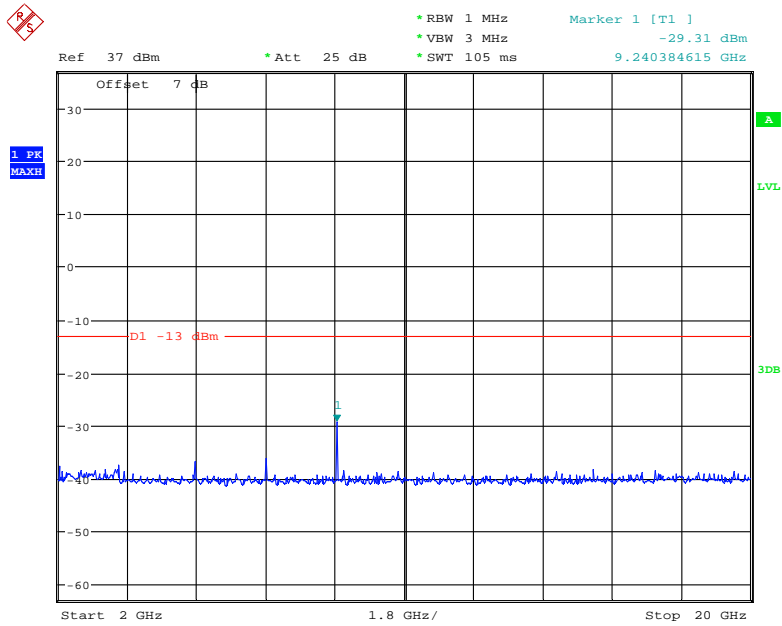

Date: 7.SEP.2021 15:53:51

30 MHz – 1 GHz (WCDMA Mode)

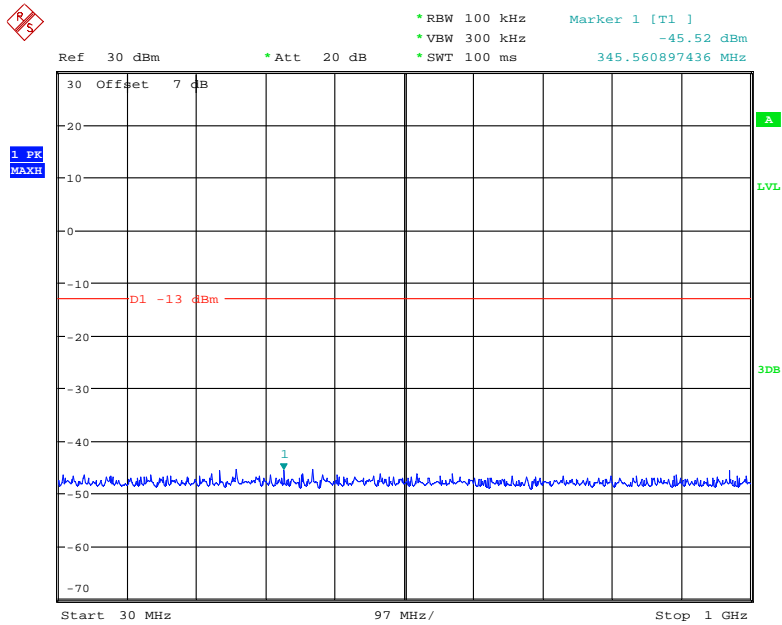

Date: 7.SEP.2021 11:01:27

1 GHz – 2 GHz (WCDMA Mode)

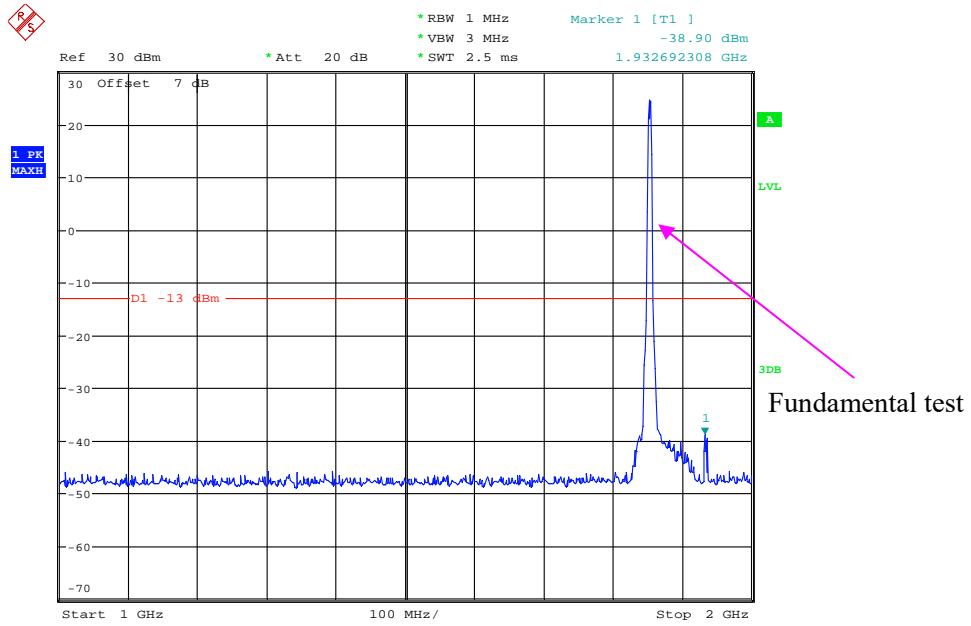

Date: 7.SEP.2021 11:05:33

2 GHz – 20 GHz (WCDMA Mode)

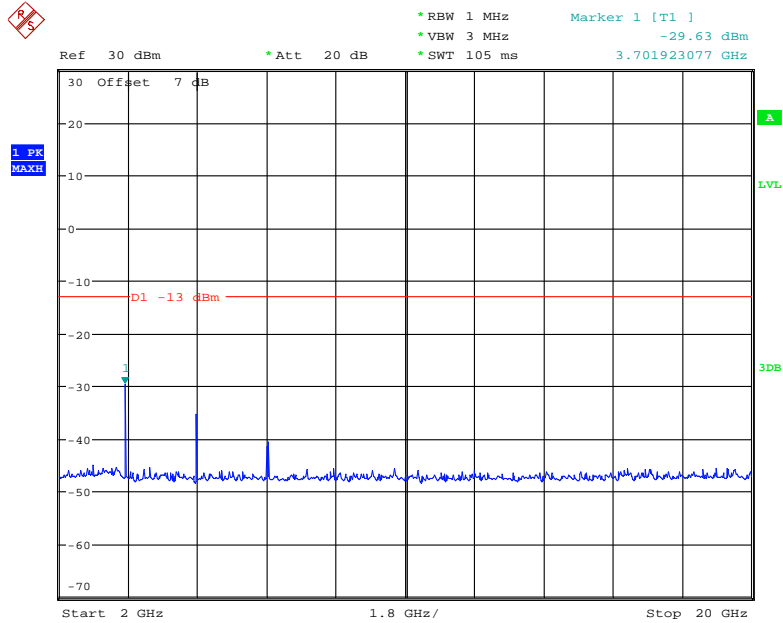

Date: 7.SEP.2021 11:07:55

Middle Channel:

30 MHz – 1 GHz (GSM Mode)

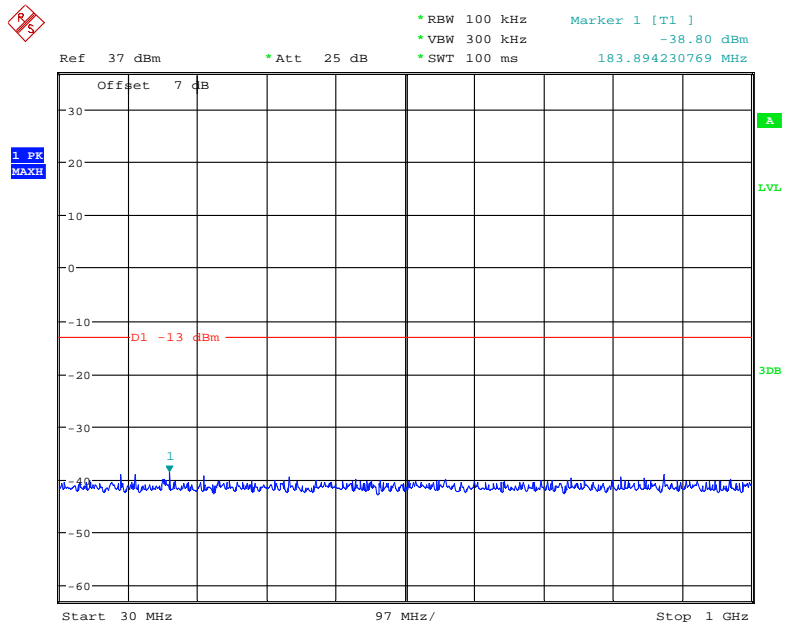

Date: 7.SEP.2021 15:49:13

1 GHz – 2 GHz (GSM Mode)

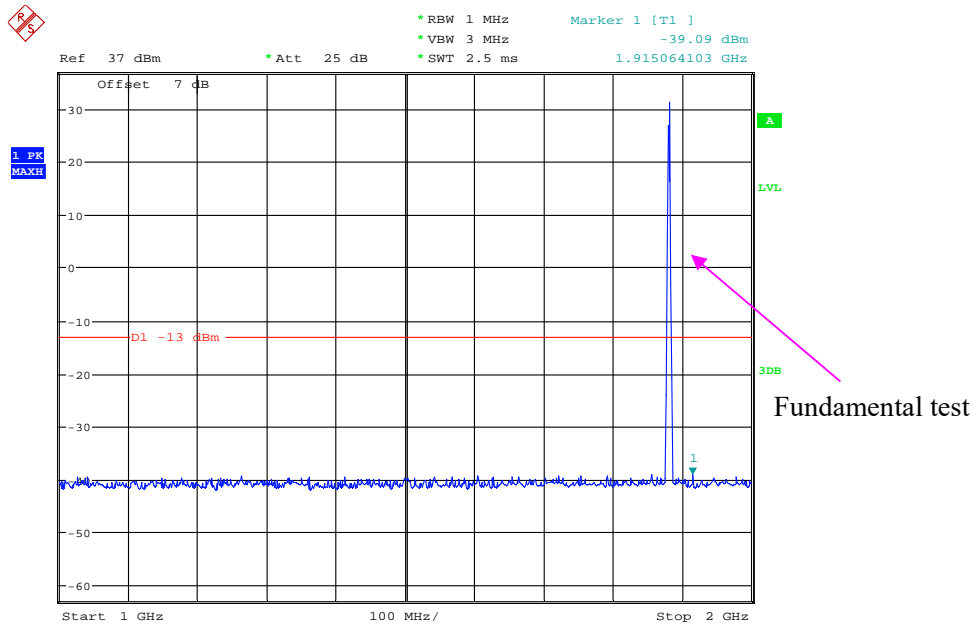

Date: 7.SEP.2021 15:52:25

2 GHz – 20 GHz (GSM Mode)

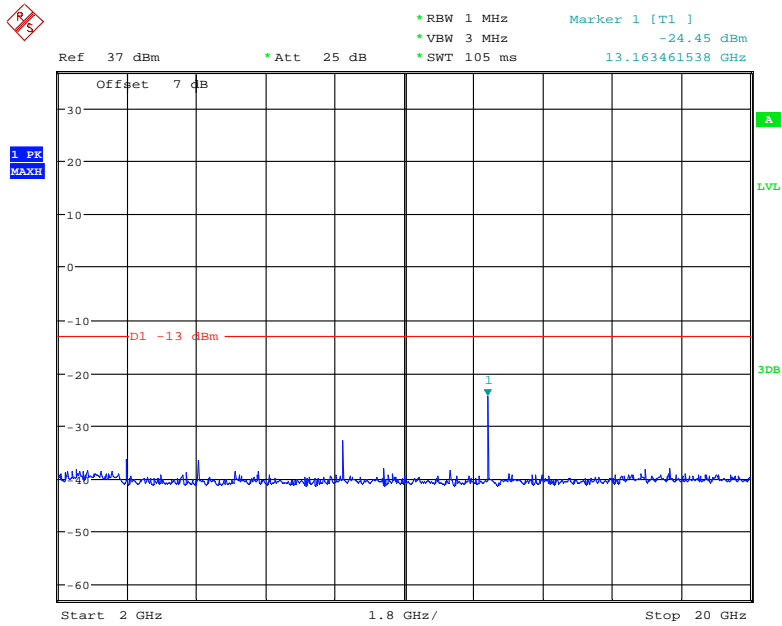

Date: 7.SEP.2021 15:54:36

30 MHz – 1 GHz (WCDMA Mode)

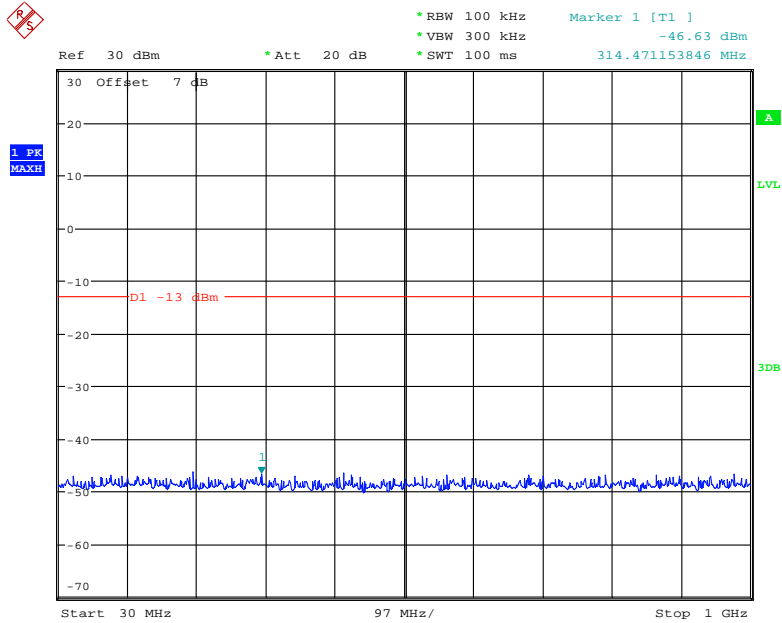

Date: 7.SEP.2021 11:02:31

1 GHz – 2 GHz (WCDMA Mode)

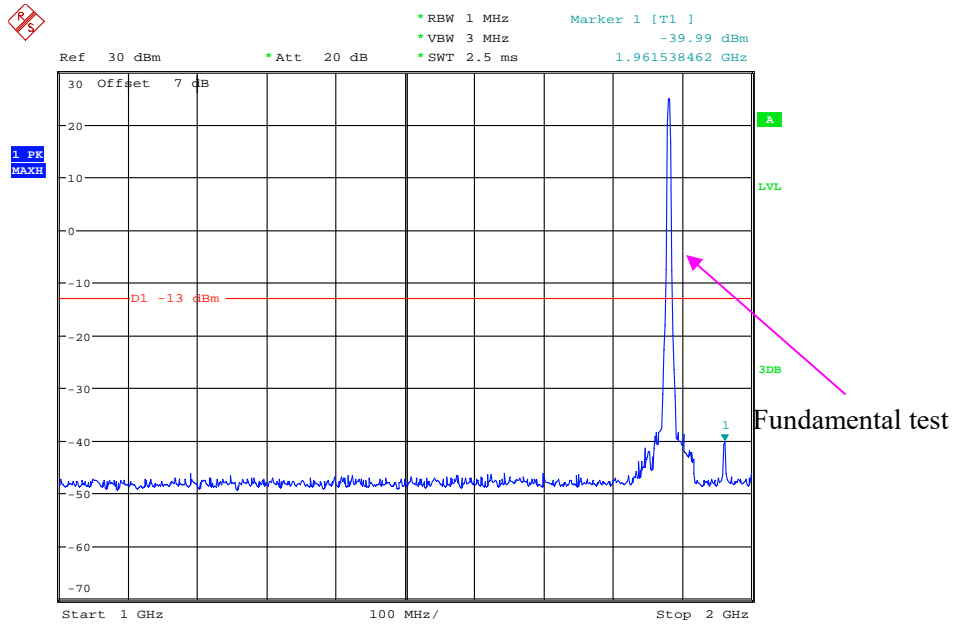

Date: 7.SEP.2021 11:06:23

2 GHz – 20 GHz (WCDMA Mode)

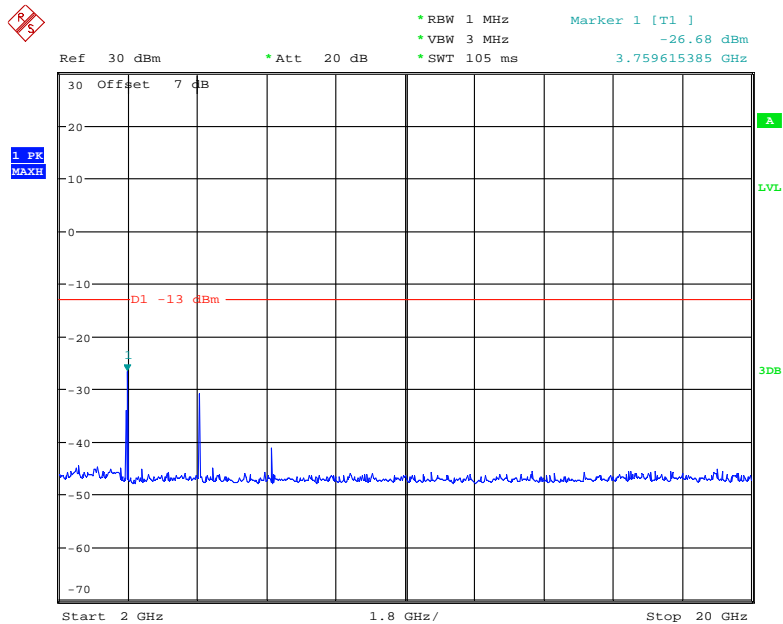

Date: 7.SEP.2021 11:08:32

2 GHz – 20 GHz (GSM Mode)

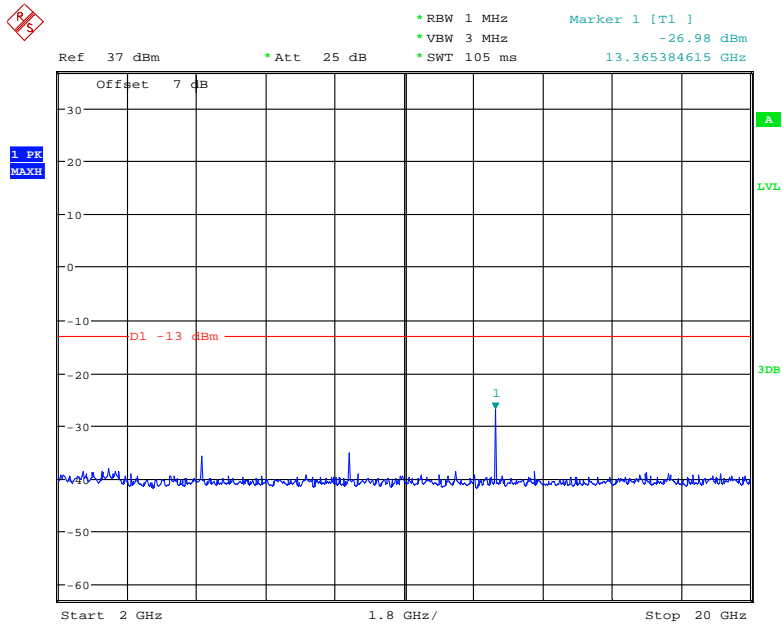

Date: 7.SEP.2021 15:54:58

30 MHz – 1 GHz (WCDMA Mode)

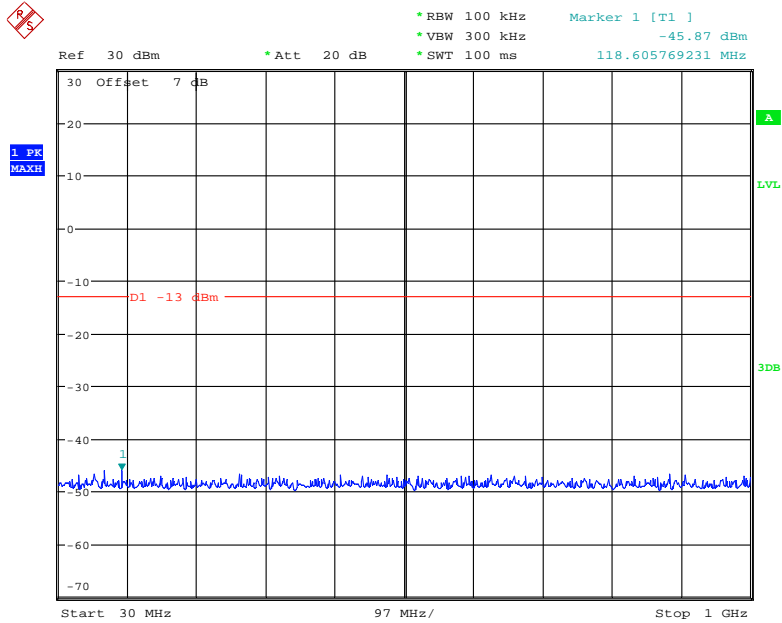

Date: 7.SEP.2021 11:03:09

1 GHz – 2 GHz (WCDMA Mode)

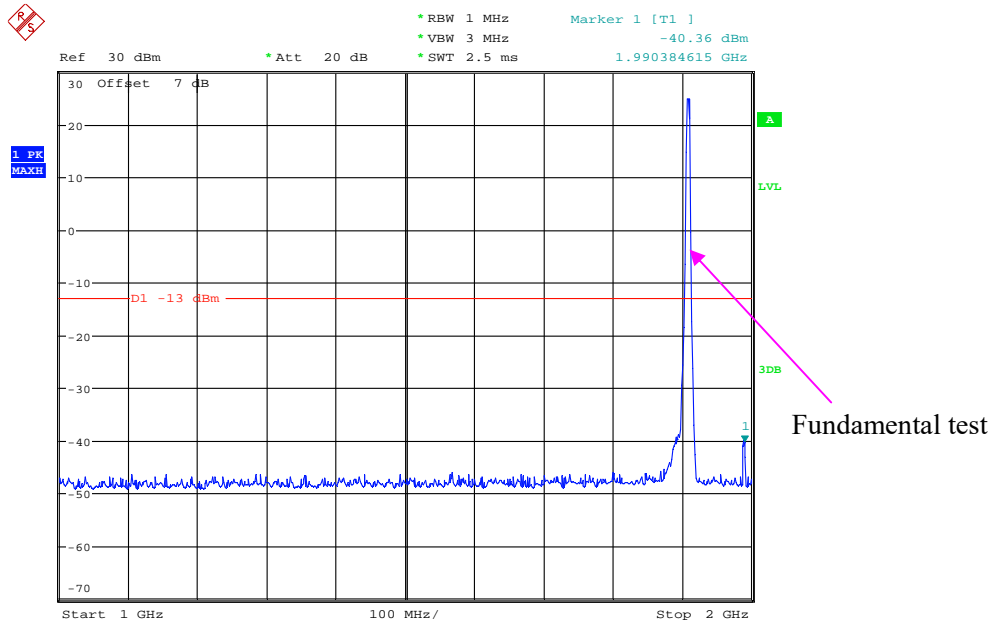

Date: 7.SEP.2021 11:06:43

2 GHz – 20 GHz (WCDMA Mode)

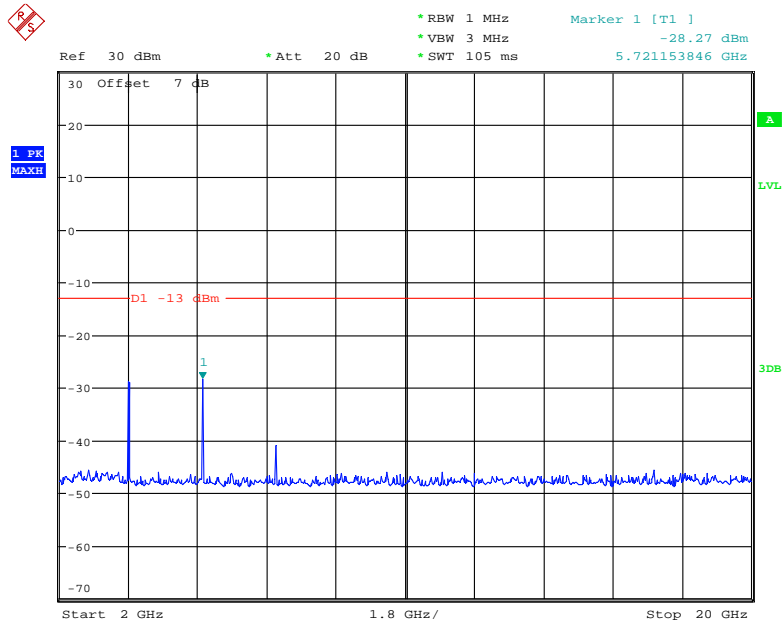

Date: 7.SEP.2021 11:09:10

2 GHz – 20 GHz (WCDMA Mode)

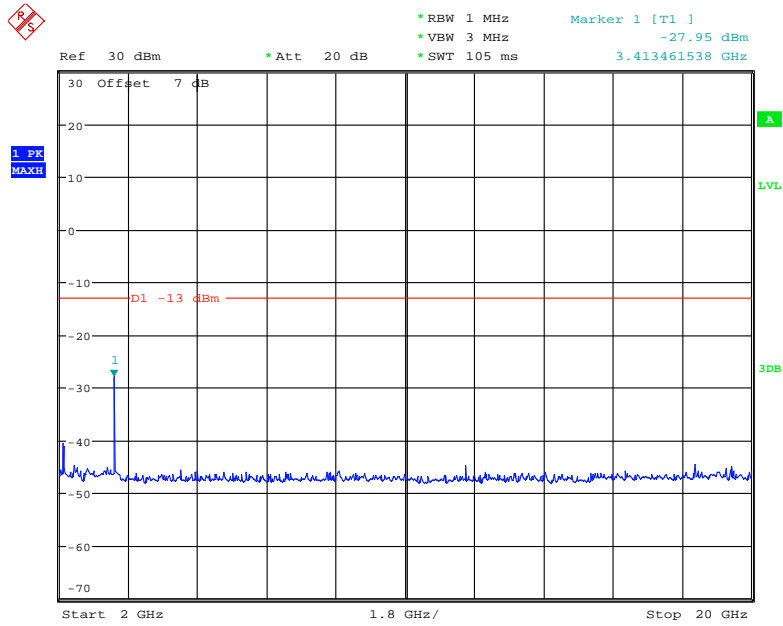

Date: 7.SEP.2021 11:17:52

Middle Channel

30 MHz – 1 GHz (WCDMA Mode)

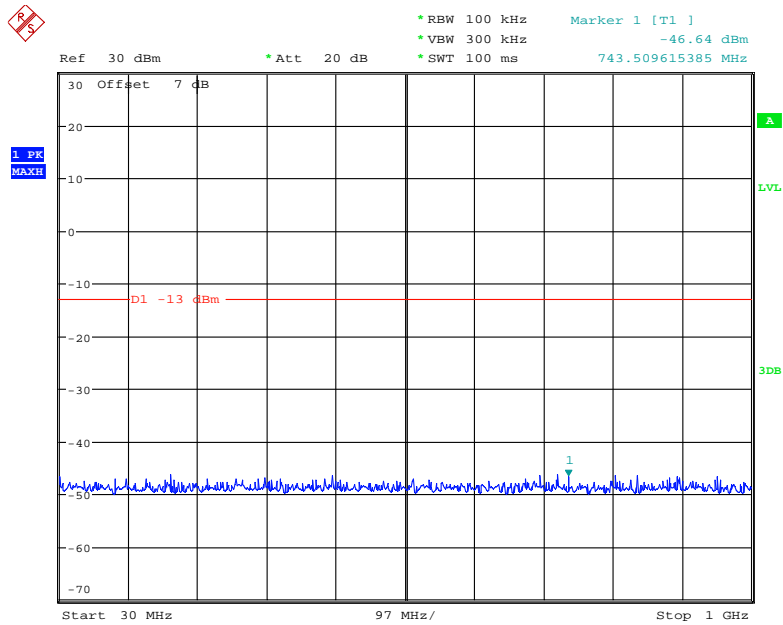

Date: 7.SEP.2021 11:12:36

1 GHz – 2 GHz (WCDMA Mode)

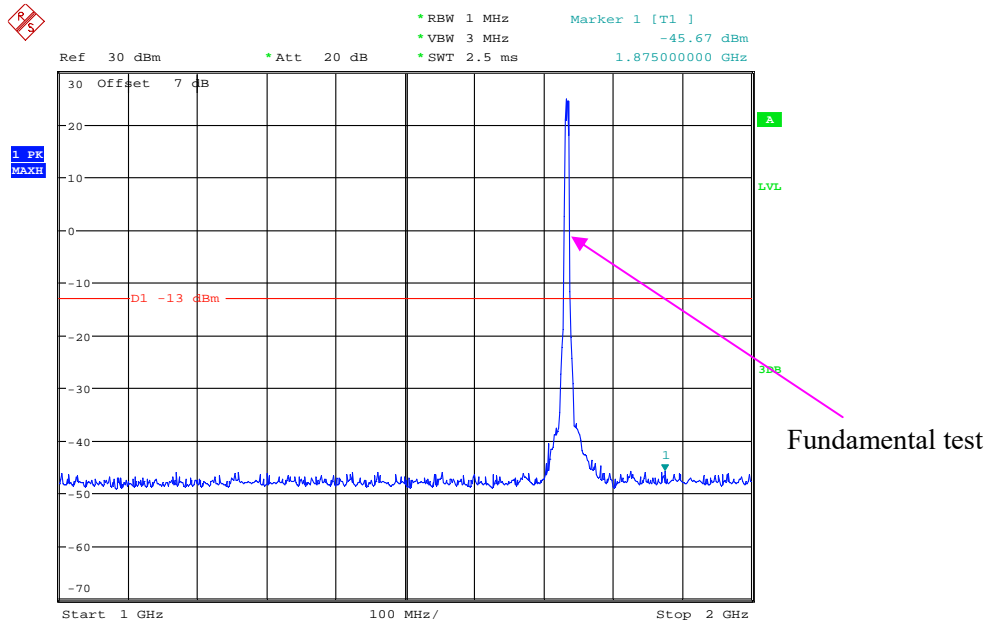

Date: 7.SEP.2021 11:16:26

2 GHz – 20 GHz (WCDMA Mode)

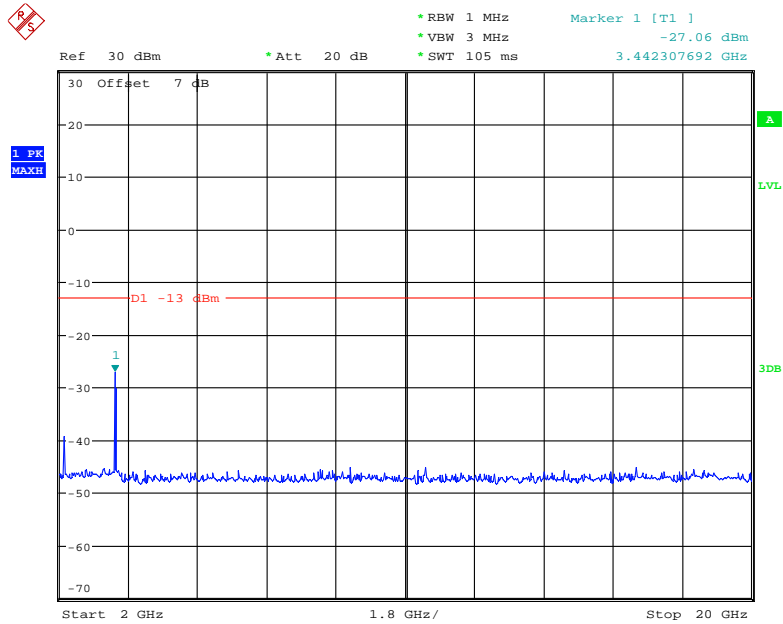

Date: 7.SEP.2021 11:18:25

2 GHz – 20 GHz (WCDMA Mode)

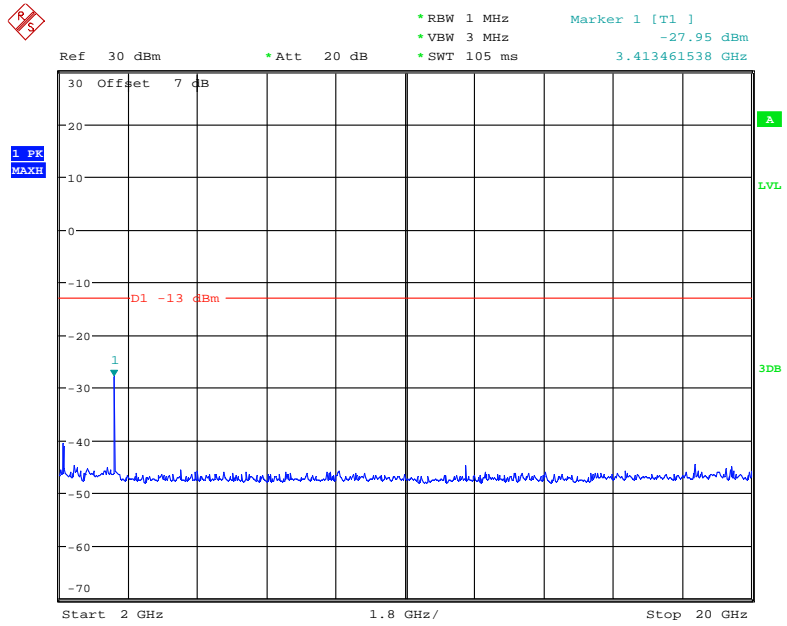

Date: 7.SEP.2021 11:17:52

The test plots of LTE band please refer to the Appendix B.

FCC § 2.1053; § 22.917 (a); § 24.238 (a); § 27.53 SPURIOUS RADIATED EMISSIONS

Applicable Standard

FCC § 2.1053, § 22.917(a) and § 24.238(a) and § 27.53

Test Procedure

The transmitter was placed on a wooden turntable, and it was transmitting into a non-radiating load which was also placed on the turntable.

The measurement antenna was placed at a distance of 3 meters from the EUT. During the tests, the receiving antenna height and polarization as well as EUT azimuth were varied in order to identify the maximum level of emissions from the EUT. The test was performed by placing the EUT on 3-orthogonal axis.

The frequency range up to tenth harmonic of the fundamental frequency was investigated.

Test Data**Environmental Conditions**

Temperature:	26~27.7 °C
Relative Humidity:	54~56 %
ATM Pressure:	101.0 kPa

The testing was performed by Caro Hu on 2021-08-31 for below 1GHz on 2021-09-03 for above 1GHz.

EUT operation mode: Transmitting

30 MHz ~ 10 GHz:**Cellular Band (Part 22H)**

Frequency (MHz)	Receiver Reading (dBm)	Turntable Degree	Rx Antenna		Substituted Factor (dB)	Absolute Level (dBm)	FCC Part 22H	
			Height (m)	Polar (H/V)			Limit (dBm)	Margin (dB)
GSM Mode								
Low Channel								
949.06	-75.12	278	1	H	11.79	-63.33	-13	50.33
949.06	-75.65	57	1.7	V	12.48	-63.17	-13	50.17
1648.4	-44.28	328	1.1	H	-2.32	-46.6	-13	33.6
1648.4	-47.01	41	2.1	V	-2.29	-49.3	-13	36.3
2472.6	-43.86	357	1.8	H	1.16	-42.7	-13	29.7
2472.6	-44.69	265	1.7	V	1.09	-43.6	-13	30.6
3296.8	-49.85	24	1.7	H	3.25	-46.6	-13	33.6
3296.8	-49.96	157	1.7	V	3.16	-46.8	-13	33.8
Middle Channel								
949.1	-74.23	245	1.3	H	11.79	-62.44	-13	49.44
949.1	-76.58	146	1.1	V	12.48	-64.1	-13	51.1
1673.2	-39.62	346	1.3	H	-2.38	-42	-13	29
1673.2	-40.99	329	1.8	V	-2.31	-43.3	-13	30.3
2509.8	-46.64	269	1.4	H	1.34	-45.3	-13	32.3
2509.8	-48.47	327	2.2	V	1.37	-47.1	-13	34.1
3346.4	-50.02	307	1	H	3.32	-46.7	-13	33.7
3346.4	-50.34	341	1.1	V	3.24	-47.1	-13	34.1
High Channel								
950.96	-75.26	139	1	H	11.79	-63.47	-13	50.47
950.96	-76.44	60	1.2	V	12.48	-63.96	-13	50.96
1697.6	-36.62	247	1.1	H	-2.38	-39	-13	26
1697.6	-39.06	297	1.5	V	-2.34	-41.4	-13	28.4
2546.4	-38.48	71	1.1	H	1.38	-37.1	-13	24.1
2546.4	-48.42	197	1.6	V	1.42	-47	-13	34
3395.2	-49.62	184	1.9	H	3.32	-46.3	-13	33.3
3395.2	-49.71	233	1.5	V	3.21	-46.5	-13	33.5

Frequency (MHz)	Receiver Reading (dBm)	Turntable Degree	Rx Antenna		Substituted Factor (dB)	Absolute Level (dBm)	FCC Part 22H	
			Height (m)	Polar (H/V)			Limit (dBm)	Margin (dB)
WCDMA Mode								
Low Channel								
950.64	-73.87	89	2.1	H	11.79	-62.08	-13	49.08
950.64	-76.87	265	1.6	V	12.48	-64.39	-13	51.39
1652.8	-49.28	117	2	H	-2.32	-51.6	-13	38.6
1652.8	-51.51	132	2	V	-2.29	-53.8	-13	40.8
Middle Channel								
950.88	-74.51	54	1.3	H	11.79	-62.72	-13	49.72
950.88	-76.15	226	1.3	V	12.48	-63.67	-13	50.67
1673.2	-47.16	132	1.1	H	-2.34	-49.5	-13	36.5
1673.2	-49.69	315	1.4	V	-2.31	-52	-13	39
High Channel								
950.85	-74.16	50	2	H	11.79	-62.37	-13	49.37
950.85	-75.49	345	1.8	V	12.48	-63.01	-13	50.01
1693.2	-45.72	334	1.9	H	-2.38	-48.1	-13	35.1
1693.2	-49.36	221	1.7	V	-2.34	-51.7	-13	38.7

30 MHz ~ 20 GHz:**PCS Band (Part 24E)**

Frequency (MHz)	Receiver Reading (dBm)	Turntable Degree	Rx Antenna		Substituted Factor (dB)	Absolute Level (dBm)	FCC Part 24E	
			Height (m)	Polar (H/V)			Limit (dBm)	Margin (dB)
GSM Mode								
Low Channel								
951.22	-73.81	12	1.2	H	11.79	-62.02	-13	49.02
951.22	-76.53	230	1.6	V	12.48	-64.05	-13	51.05
3700.4	-51.92	288	1.4	H	4.72	-47.2	-13	34.2
3700.4	-51.41	113	1.2	V	4.61	-46.8	-13	33.8
Middle Channel								
951.28	-75.12	191	2	H	11.79	-63.33	-13	50.33
951.28	-76.5	322	2.1	V	12.48	-64.02	-13	51.02
3760	-52.24	91	1.7	H	4.94	-47.3	-13	34.3
3760	-52.35	91	1.3	V	4.85	-47.5	-13	34.5
High Channel								
949.88	-74.19	327	1.7	H	11.79	-62.4	-13	49.4
949.88	-76.24	181	1.5	V	12.48	-63.76	-13	50.76
3819.6	-52.55	331	1.3	H	5.25	-47.3	-13	34.3
3819.6	-52.18	176	2.1	V	5.08	-47.1	-13	34.1
WCDMA Mode								
Low Channel								
950.22	-74.99	340	2.1	H	11.79	-63.2	-13	50.2
950.22	-76	11	1.4	V	12.48	-63.52	-13	50.52
3704.8	-44.85	140	1.1	H	4.75	-40.1	-13	27.1
3704.8	-44.52	33	1.6	V	4.62	-39.9	-13	26.9
Middle Channel								
949.12	-75.24	358	1.4	H	11.79	-63.45	-13	50.45
949.12	-76.86	322	1.4	V	12.48	-64.38	-13	51.38
3760	-46.44	294	1.6	H	4.94	-41.5	-13	28.5
3760	-46.75	199	2.1	V	4.85	-41.9	-13	28.9
High Channel								
949.26	-75.14	119	1	H	11.79	-63.35	-13	50.35
949.26	-75.64	81	1.9	V	12.48	-63.16	-13	50.16
3815.2	-45.42	282	1.1	H	5.22	-40.2	-13	27.2
3815.2	-44.95	347	1.1	V	5.05	-39.9	-13	26.9

30 MHz ~ 20 GHz:**AWS Band**

Frequency (MHz)	Receiver Reading (dBm)	Turntable Degree	Rx Antenna		Substituted Factor (dB)	Absolute Level (dBm)	FCC Part 27	
			Height (m)	Polar (H/V)			Limit (dBm)	Margin (dB)
WCDMA Mode								
Low Channel								
951.42	-74.2	59	2.1	H	11.79	-62.41	-13	49.41
951.42	-76.71	59	1.9	V	12.48	-64.23	-13	51.23
3815.2	-45.42	282	1.1	H	5.22	-40.2	-13	27.2
3815.2	-44.95	347	1.1	V	5.05	-39.9	-13	26.9
Middle Channel								
951.25	-75.09	277	1.2	H	11.79	-63.3	-13	50.3
951.25	-75.53	207	1.4	V	12.48	-63.05	-13	50.05
3465.2	-49.95	127	1.8	H	3.35	-46.6	-13	33.6
3465.2	-50.42	99	1.5	V	3.32	-47.1	-13	34.1
High Channel								
949.54	-73.83	227	1.8	H	11.79	-62.04	-13	49.04
949.54	-76.33	327	1.1	V	12.48	-63.85	-13	50.85
3505.2	-49.96	32	2	H	3.56	-46.4	-13	33.4
3505.2	-50.88	225	1.4	V	3.48	-47.4	-13	34.4

LTE Band: (Pre-scan with all the bandwidth, and worst case as below)

Frequency (MHz)	Receiver Reading (dBm)	Turntable Degree	Rx Antenna		Substituted Factor (dB)	Absolute Level (dBm)	Limit (dBm)	Margin (dB)
			Height (m)	Polar (H/V)				
Band 2								
Test frequency range: 30 MHz ~ 20 GHz								
1.4MHz, Low channel								
955.16	-71.29	10	2	H	11.79	-59.5	-13	46.5
955.16	-76.88	207	2	V	12.48	-64.4	-13	51.4
3701.40	-42.72	74	1.4	H	4.72	-38	-13	25
3701.40	-43.41	85	1	V	4.61	-38.8	-13	25.8
1.4MHz, Middle channel								
949.78	-74.56	72	1.6	H	11.79	-62.77	-13	49.77
949.78	-76.58	292	1.5	V	12.48	-64.1	-13	51.1
3760.00	-44.64	166	1.2	H	4.94	-39.7	-13	26.7
3760.00	-44.45	125	1.2	V	4.85	-39.6	-13	26.6
1.4MHz, High Channel								
950.14	-74.68	103	2.1	H	11.79	-62.89	-13	49.89
950.14	-76.59	167	1.1	V	12.48	-64.11	-13	51.11
3818.60	-44.95	314	2.2	H	5.25	-39.7	-13	26.7
3818.60	-44.68	318	1.4	V	5.08	-39.6	-13	26.6
Band 4								
Test frequency range:30 MHz ~ 20 GHz								
1.4MHz, Low channel								
949.31	-74.49	355	1.9	H	11.79	-62.7	-13	49.7
949.31	-76.45	250	1.3	V	12.48	-63.97	-13	50.97
3421.4	-48.32	96	1	H	2.72	-45.6	-13	32.6
3421.4	-48.19	111	2.2	V	2.59	-45.6	-13	32.6
1.4MHz, Middle channel								
949.74	-74.43	335	1.1	H	11.79	-62.64	-13	49.64
949.74	-75.82	101	1.9	V	12.48	-63.34	-13	50.34
3465	-48.99	142	1.6	H	3.09	-45.9	-13	32.9
3465	-49.97	125	2.1	V	2.97	-47	-13	34
1.4MHz, High Channel								
949.96	-75.22	63	1.8	H	11.79	-63.43	-13	50.43
949.96	-76.92	205	2.1	V	12.48	-64.44	-13	51.44
3508.6	-49.54	354	1.3	H	3.44	-46.1	-13	33.1
3508.6	-50.71	330	1.6	V	3.31	-47.4	-13	34.4

Frequency (MHz)	Receiver Reading (dBm)	Turntable Degree	Rx Antenna		Substituted Factor (dB)	Absolute Level (dBm)	Limit (dBm)	Margin (dB)
			Height (m)	Polar (H/V)				
Band 5								
Test frequency range: 30 MHz ~ 10 GHz								
1.4MHz, Low channel								
949.96	-74.92	8	1.2	H	11.79	-63.13	-13	50.13
949.96	-76.58	29	1.6	V	12.48	-64.1	-13	51.1
1649.40	-54.41	129	1.2	H	-2.79	-57.2	-13	44.2
1649.40	-54.37	35	1	V	-2.73	-57.1	-13	44.1
1.4MHz, Middle channel								
949.83	-74.33	359	1.2	H	11.79	-62.54	-13	49.54
949.83	-75.79	191	1.5	V	12.48	-63.31	-13	50.31
1673.00	-44.96	84	1.7	H	-2.74	-47.7	-13	34.7
1673.00	-47.21	149	1.3	V	-2.69	-49.9	-13	36.9
1.4MHz, High Channel								
955.16	-74.66	165	1.8	H	11.79	-62.87	-13	49.87
955.16	-76.83	72	1.3	V	12.48	-64.35	-13	51.35
1696.6	-46.4	59	2.2	H	-2.7	-49.1	-13	36.1
1696.6	-49.35	215	2	V	-2.65	-52	-13	39
Band 7								
Test frequency range: 30 MHz ~ 26.5 GHz								
5MHz, Low channel								
949.81	-74.4	92	1.6	H	11.79	-62.61	-25	37.61
949.81	-76.19	341	2.2	V	12.48	-63.71	-25	38.71
5005	-54.44	11	1.9	H	9.54	-44.9	-25	19.9
5005	-54.03	186	2.1	V	8.33	-45.7	-25	20.7
7507.5	-40.58	6	1.1	H	14.38	-26.2	-25	1.2
7507.5	-46.95	141	2.1	V	15.15	-31.8	-25	6.8
5MHz, Middle channel								
949.48	-73.98	281	1.6	H	11.79	-62.19	-25	37.19
949.48	-76.27	65	1.7	V	12.48	-63.79	-25	38.79
5070	-55.17	317	2.2	H	9.67	-45.5	-25	20.5
5070	-54.45	11	1.2	V	8.35	-46.1	-25	21.1
5MHz, High Channel								
949.88	-74.97	287	1	H	11.79	-63.18	-25	38.18
949.88	-76.38	237	1.7	V	12.48	-63.9	-25	38.90
5135	-55.24	270	1.8	H	9.84	-45.4	-25	20.4
5135	-52.66	291	1.4	V	8.36	-44.3	-25	19.3

Frequency (MHz)	Receiver Reading (dBm)	Turntable Degree	Rx Antenna		Substituted Factor (dB)	Absolute Level (dBm)	Limit (dBm)	Margin (dB)
			Height (m)	Polar (H/V)				
Band 17								
Test frequency range: 30 MHz ~ 10 GHz								
5MHz, Low channel								
949.57	-74.58	270	1.6	H	11.79	-62.79	-13	49.79
949.57	-76.58	259	1	V	12.48	-64.1	-13	51.1
1413	-51.35	221	1.1	H	-0.65	-52	-13	39
1413	-48.53	79	1.8	V	-0.87	-49.4	-13	36.4
5MHz, Middle channel								
949.13	-75.27	341	1.5	H	11.79	-63.48	-13	50.48
949.13	-76.52	170	1.3	V	12.48	-64.04	-13	51.04
1420	-48.63	319	1.8	H	-0.67	-49.3	-13	36.3
1420	-50.29	303	1.8	V	-0.91	-51.2	-13	38.2
5MHz, High Channel								
950.3	-74.78	253	1.2	H	11.79	-62.99	-13	49.99
950.3	-76.36	90	1.3	V	12.48	-63.88	-13	50.88
1427	-48.19	227	1.5	H	-0.71	-48.9	-13	35.9
1427	-49.56	323	1.2	V	-0.94	-50.5	-13	37.5
Band 38								
Test frequency range: 30 MHz ~ 26.5GHz								
5MHz, Low channel								
950.36	-73.9	70	1.7	H	11.79	-62.11	-25	37.11
950.36	-76.86	20	1.6	V	12.48	-64.38	-25	39.38
5145	-50.22	171	2.1	H	9.92	-40.3	-25	15.3
5145	-46.08	330	1.5	V	8.38	-37.7	-25	12.7
5MHz, Middle channel								
949.56	-74.42	226	1.7	H	11.79	-62.63	-25	37.63
949.56	-75.78	39	1.8	V	12.48	-63.3	-25	38.30
5190	-48.78	118	2.1	H	9.98	-38.8	-25	13.8
5190	-47.89	227	1.4	V	8.39	-39.5	-25	14.5
5MHz, High Channel								
950.32	-74.85	147	2.1	H	11.79	-63.06	-25	38.06
950.32	-75.5	198	1.9	V	12.48	-63.02	-25	38.02
5235	-53.36	342	1.9	H	10.06	-43.3	-25	18.3
5235	-50.55	231	1.2	V	8.45	-42.1	-25	17.1

Frequency (MHz)	Receiver Reading (dBm)	Turntable Degree	Rx Antenna		Substituted Factor (dB)	Absolute Level (dBm)	Limit (dBm)	Margin (dB)
			Height (m)	Polar (H/V)				
Band 41								
Test frequency range: 30 MHz ~ 26.5GHz								
5MHz, Low channel								
949.45	-74.27	57	1.6	H	11.79	-62.48	-25	37.48
949.45	-76.26	119	1.1	V	12.48	-63.78	-25	38.78
5075	-46.32	272	1.9	H	9.62	-36.7	-25	11.7
5075	-47.15	187	2.2	V	8.35	-38.8	-25	13.8
5MHz, Middle channel								
949.28	-74.24	14	1.1	H	11.79	-62.45	-25	37.45
949.28	-76.45	2	1.2	V	12.48	-63.97	-25	38.97
5186	-48.78	261	2	H	9.98	-38.8	-25	13.8
5186	-48.19	314	1.3	V	8.39	-39.8	-25	14.8
5MHz, High Channel								
950.41	-74.78	353	1.2	H	11.79	-62.99	-25	37.99
950.41	-76.83	194	2.2	V	12.48	-64.35	-25	39.35
5305	-50.92	258	2	H	10.12	-40.8	-25	15.8
5305	-48.01	104	1	V	8.51	-39.5	-25	14.5
Band 66								
Test frequency range: 30 MHz ~ 20GHz								
1.4MHz, Low channel								
949.14	-74.38	284	2.2	H	11.79	-62.59	-13	49.59
949.14	-76.86	267	1.2	V	12.48	-64.38	-13	51.38
3421.4	-47.72	277	1.9	H	2.72	-45	-13	32
3421.4	-49.19	196	1.5	V	2.59	-46.6	-13	33.6
1.4MHz, Middle channel								
949.15	-73.96	134	2	H	11.79	-62.17	-13	49.17
949.15	-76.3	243	1.2	V	12.48	-63.82	-13	50.82
3490	-48.62	197	2	H	3.12	-45.5	-13	32.5
3490	-49.8	328	1.7	V	2.9	-46.9	-13	33.9
1.4MHz, High Channel								
950.11	-74.96	269	2.2	H	11.79	-63.17	-13	50.17
950.11	-75.89	87	2.1	V	12.48	-63.41	-13	50.41
3558.6	-50.74	103	2	H	3.64	-47.1	-13	34.1
3558.6	-49.32	176	1.4	V	3.52	-45.8	-13	32.8

Note:

Absolute Level = Substituted Level - Cable loss + Antenna Gain

Margin = Limit - Absolute Level

dBd is for the ERP, dBi is for EIRP.

FCC § 22.917 (a); § 24.238 (a); §27.53(c) (h)(m) - BAND EDGES

Applicable Standard

According to § 22.917(a), the power of any emissions outside of the authorized operating frequency ranges must be attenuated below the transmitting power (P) by a factor of at least $43 + 10 \log(P)$ dB.

According to §24.238(a), the power of any emissions outside of the authorized operating frequency ranges must be attenuated below the transmitting power (P) by a factor of at least $43 + 10 \log(P)$ dB.

According to FCC §27.53 (c)(h)(m), the power of any emission outside of the authorized operating frequency ranges must be attenuated below the transmitting power (P) by a factor of at least $43 + 10 \log(P)$ dB.

Test Procedure

The RF output of the transmitter was connected to the input of the spectrum analyzer through sufficient attenuation.

The center of the spectrum analyzer was set to block edge frequency

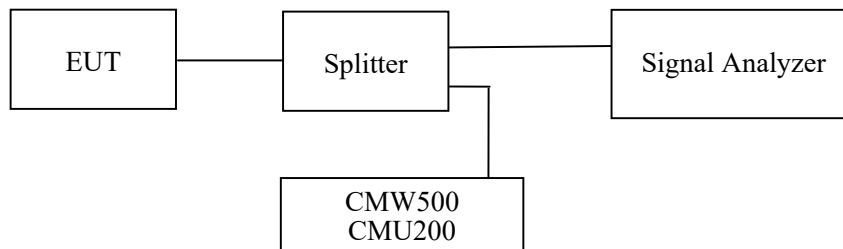

Test Data

Environmental Conditions

Temperature:	27 °C
Relative Humidity:	58 %
ATM Pressure:	101.0 kPa

The testing was performed by Ting Lv from 2021-09-07 to 2021-11-08.

EUT operation mode: Transmitting (Worst case)

Test Result: Pass

Please refer to the following plots.

Cellular Band, Left Band Edge for GSM (GMSK) Mode

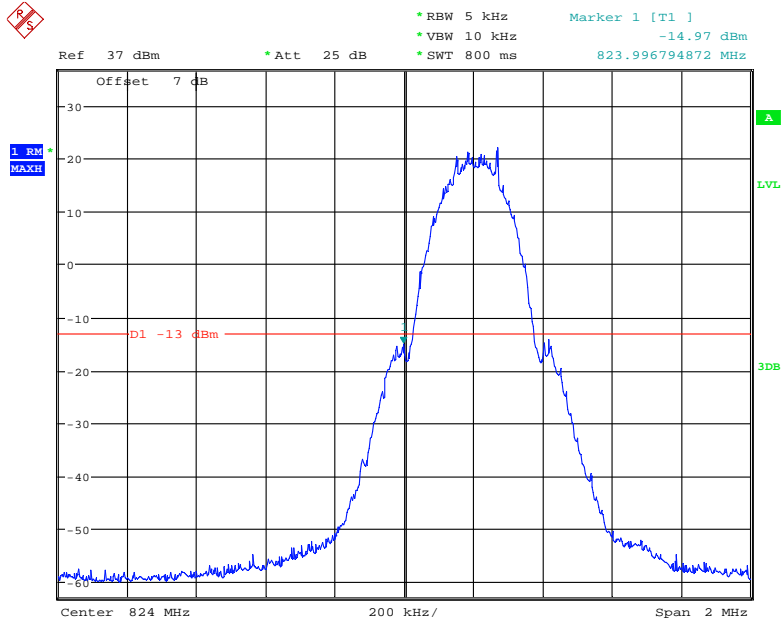

Date: 7.SEP.2021 15:22:48

Cellular Band, Right Band Edge for GSM (GMSK) Mode

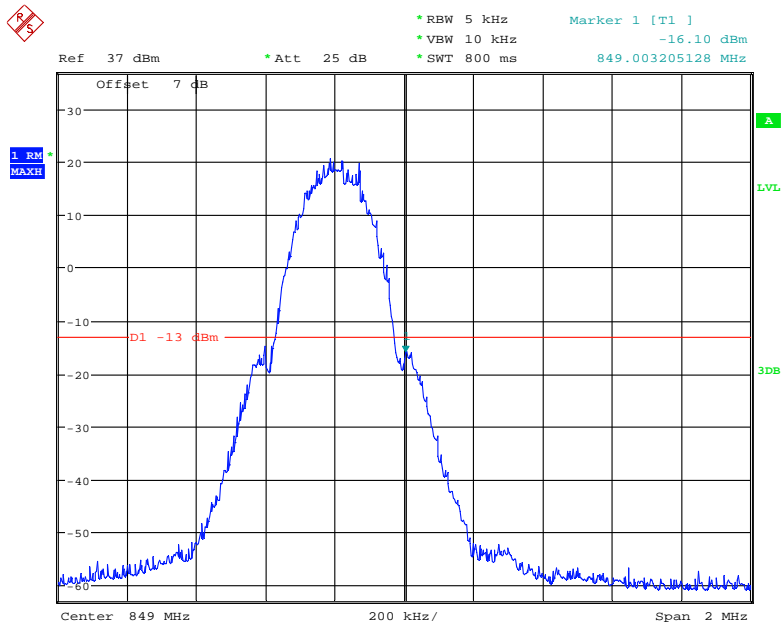

Date: 7.SEP.2021 15:30:42

Cellular Band, Left Band Edge for EGPRS (8PSK) Mode

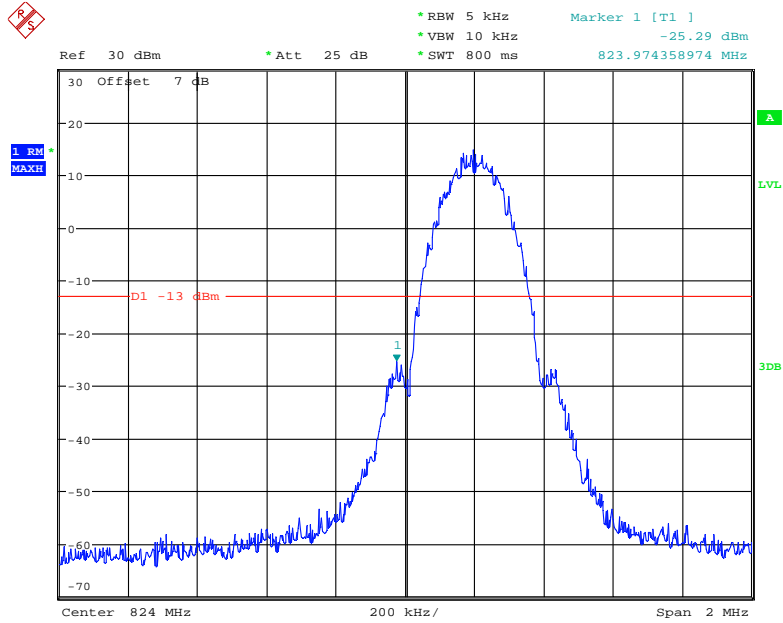

Date: 7.SEP.2021 15:36:59

Cellular Band, Right Band Edge for EGPRS (8PSK) Mode

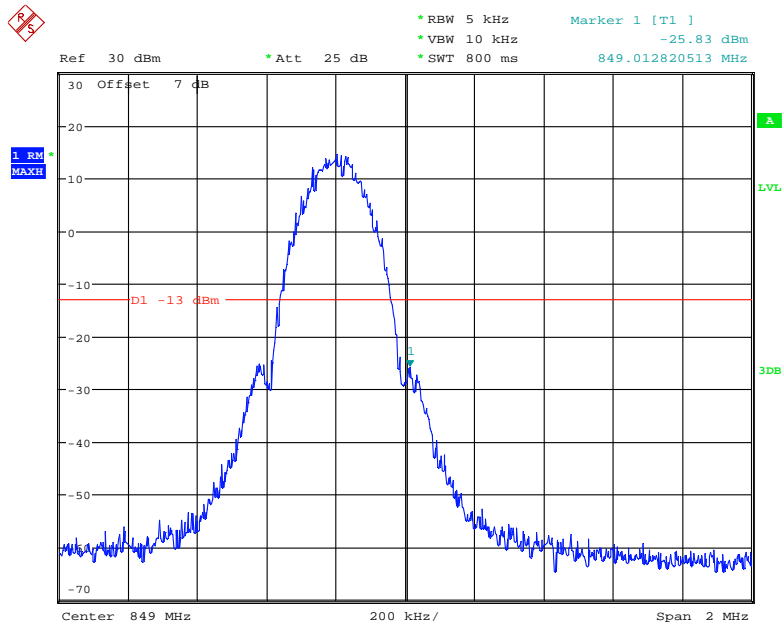

Date: 7.SEP.2021 15:38:00

Cellular Band, Left Band Edge for RMC (BPSK) Mode

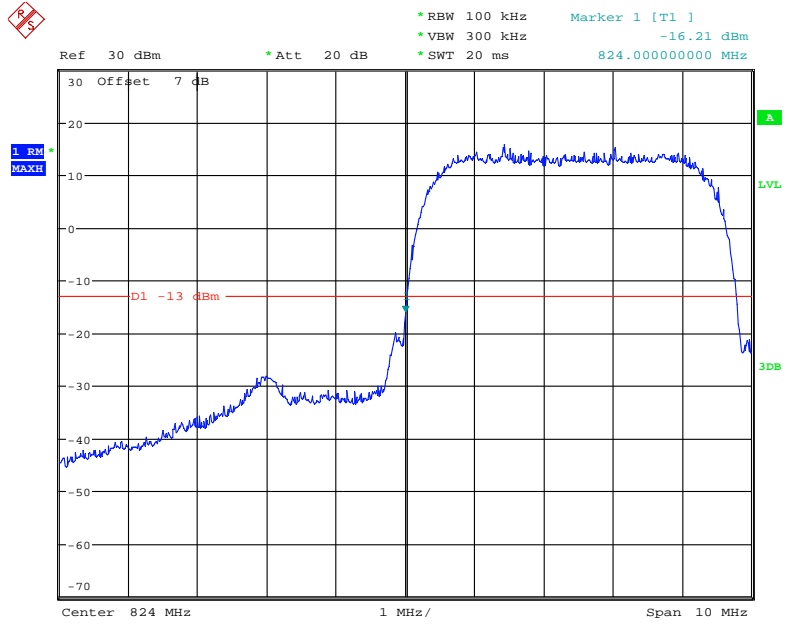

Date: 7.SEP.2021 10:35:50

Cellular Band, Right Band Edge for RMC (BPSK) Mode

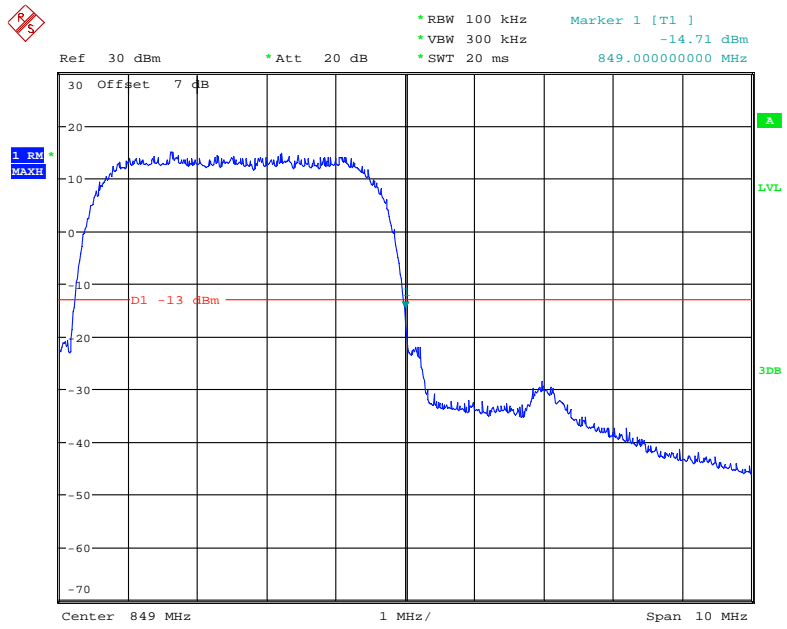

Date: 7.SEP.2021 10:36:27

Cellular Band, Left Band Edge for HSDPA (16QAM) Mode

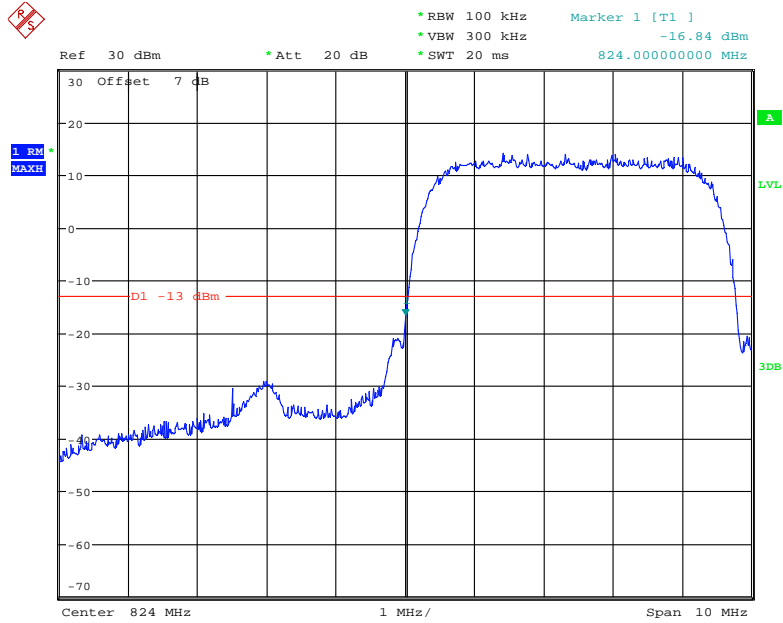

Date: 7.SEP.2021 10:31:36

Cellular Band, Right Band Edge for HSDPA (16QAM) Mode

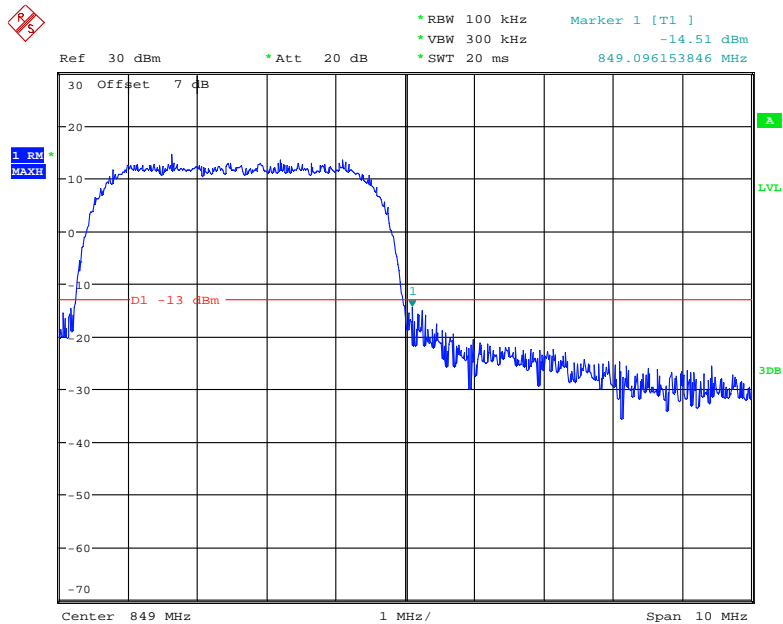

Date: 7.SEP.2021 10:33:45

Cellular Band, Left Band Edge for HSUPA (BPSK) Mode

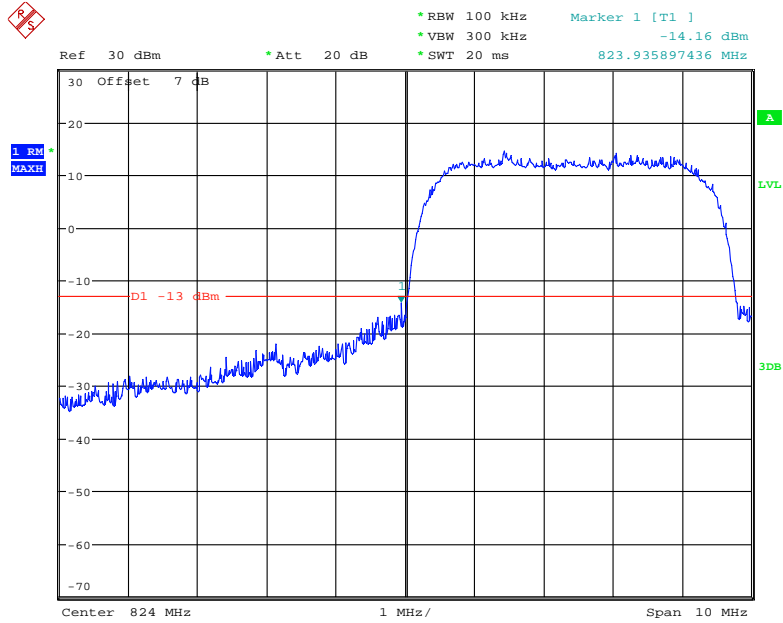

Date: 7.SEP.2021 10:28:40

Cellular Band, Right Band Edge for HSUPA (BPSK) Mode

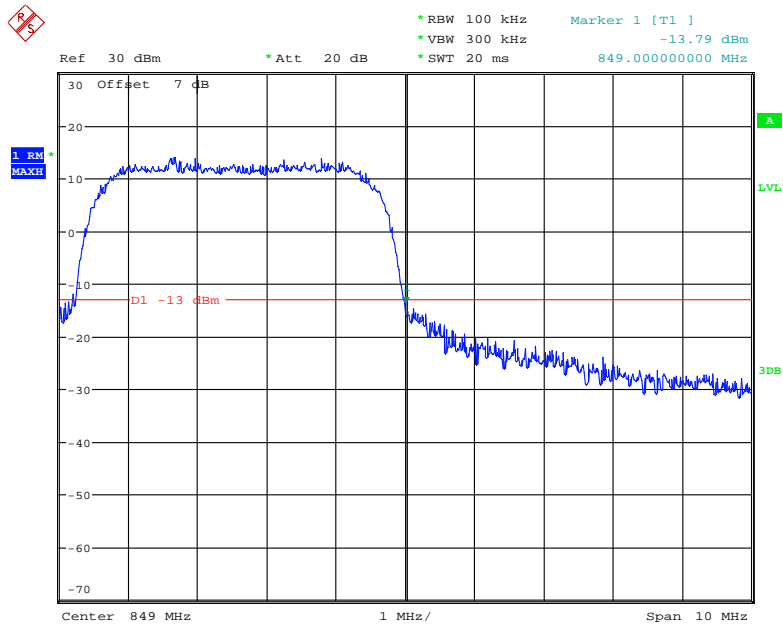

Date: 7.SEP.2021 10:26:52

PCS Band, Left Band Edge for GSM (GMSK) Mode

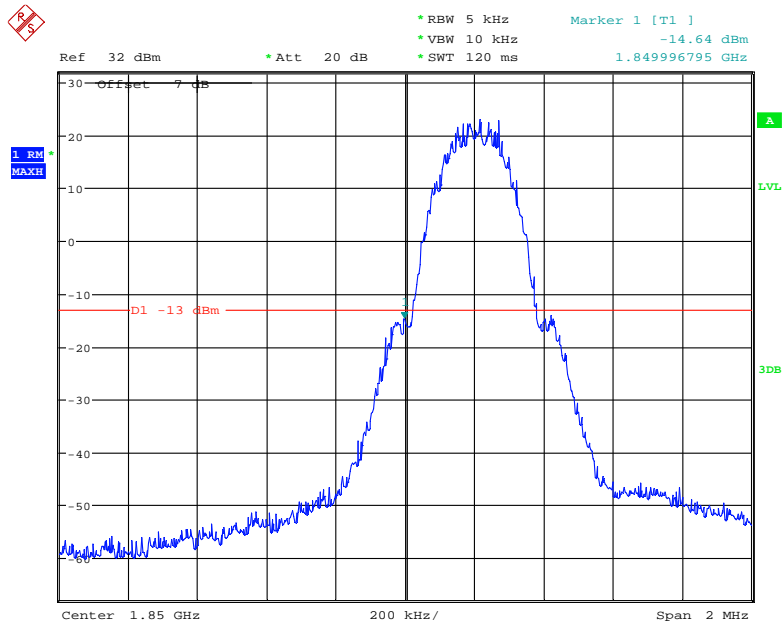

Date: 7.SEP.2021 14:58:40

PCS Band, Right Band Edge for GSM (GMSK) Mode

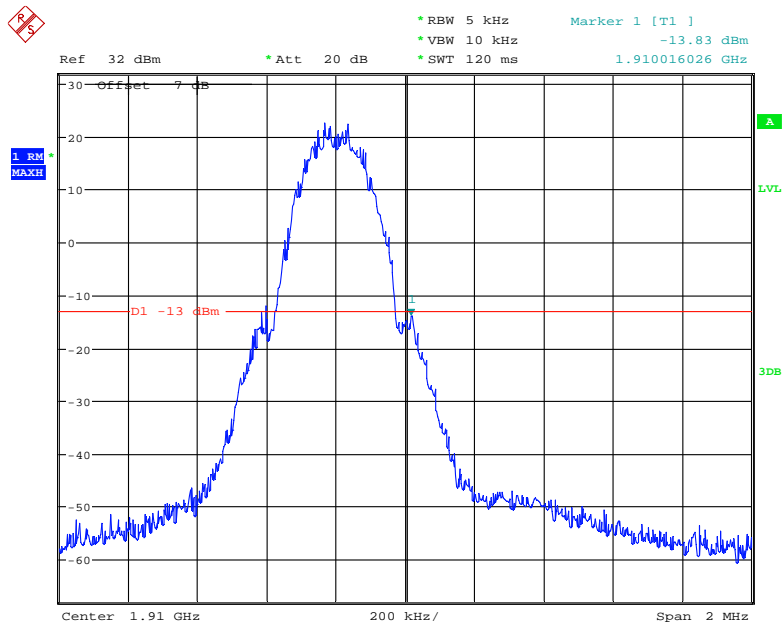

Date: 7.SEP.2021 15:00:43

PCS Band, Left Band Edge for EGPRS (8PSK) Mode

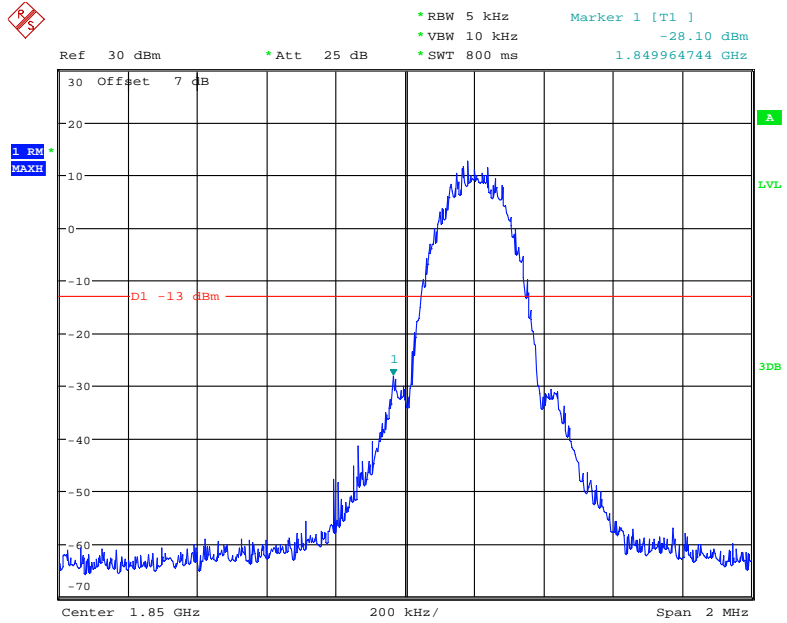

Date: 7.SEP.2021 15:41:44

PCS Band, Right Band Edge for EGPRS (8PSK) Mode

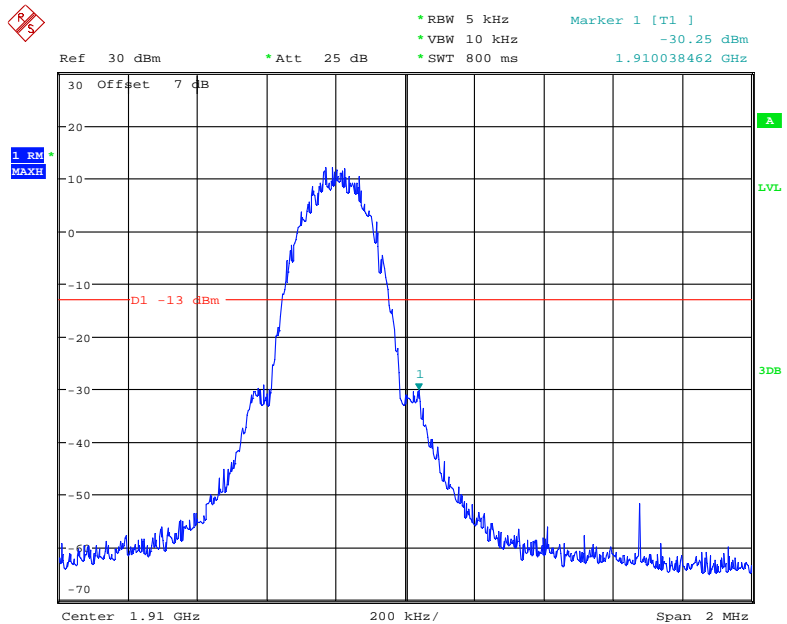

Date: 7.SEP.2021 15:42:33

PCS Band, Left Band Edge for RMC (BPSK) Mode

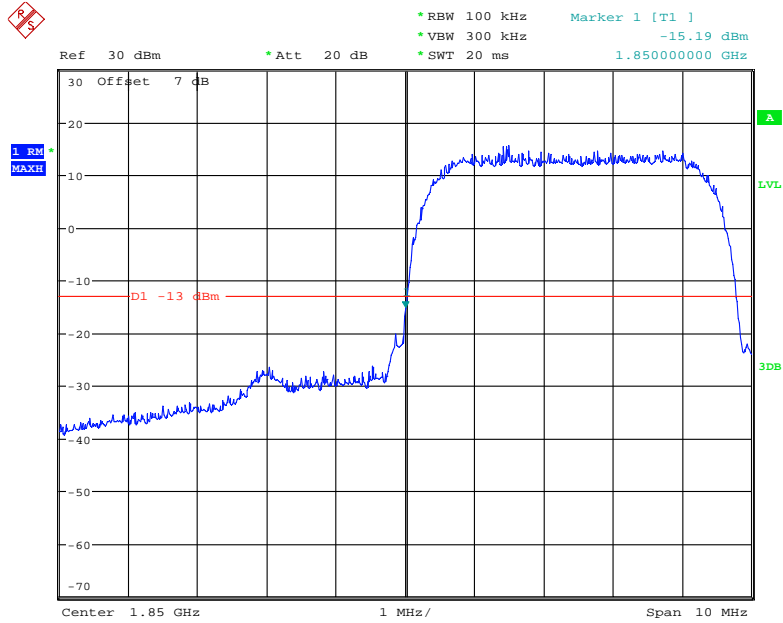

Date: 7.SEP.2021 10:47:22

PCS Band, Right Band Edge for RMC (BPSK) Mode

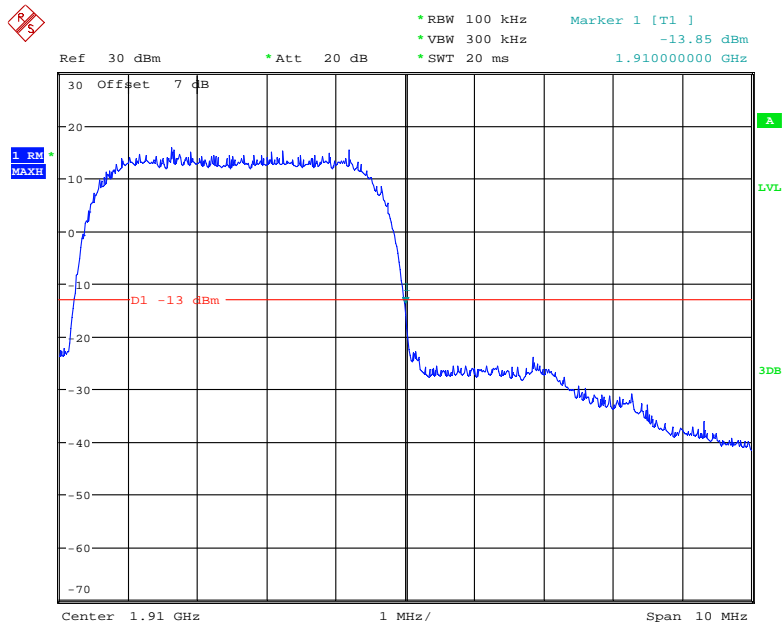

Date: 7.SEP.2021 10:49:38

PCS Band, Left Band Edge for HSDPA (16QAM) Mode

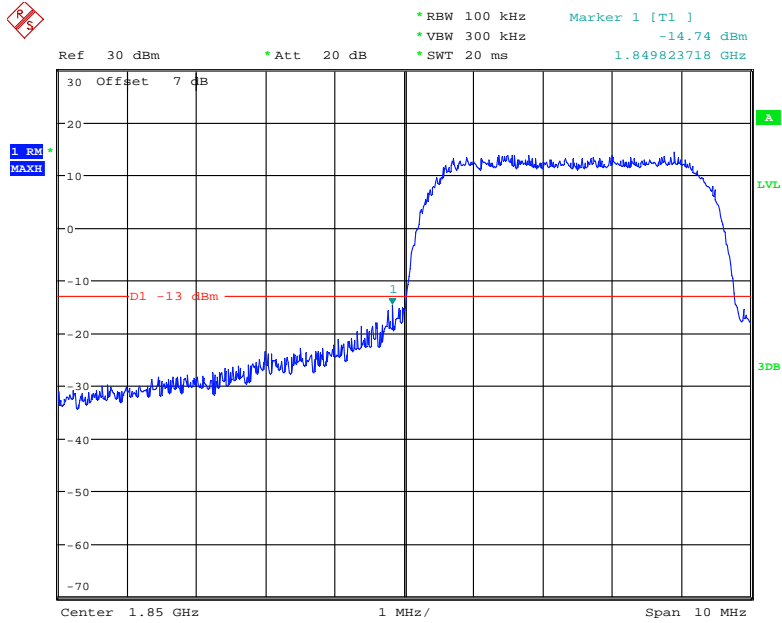

Date: 7.SEP.2021 10:53:59

PCS Band, Right Band Edge for HSDPA (16QAM) Mode

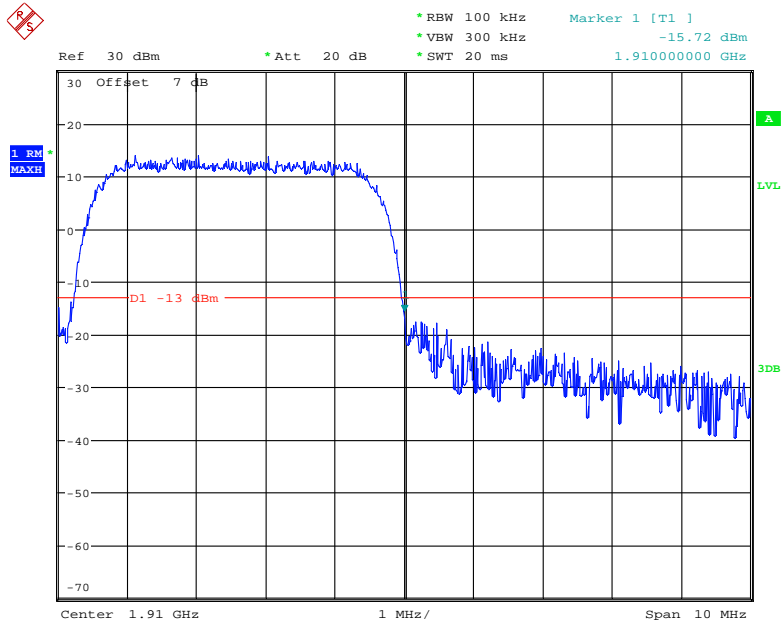

Date: 7.SEP.2021 10:55:24

PCS Band, Left Band Edge for HSUPA (BPSK) Mode

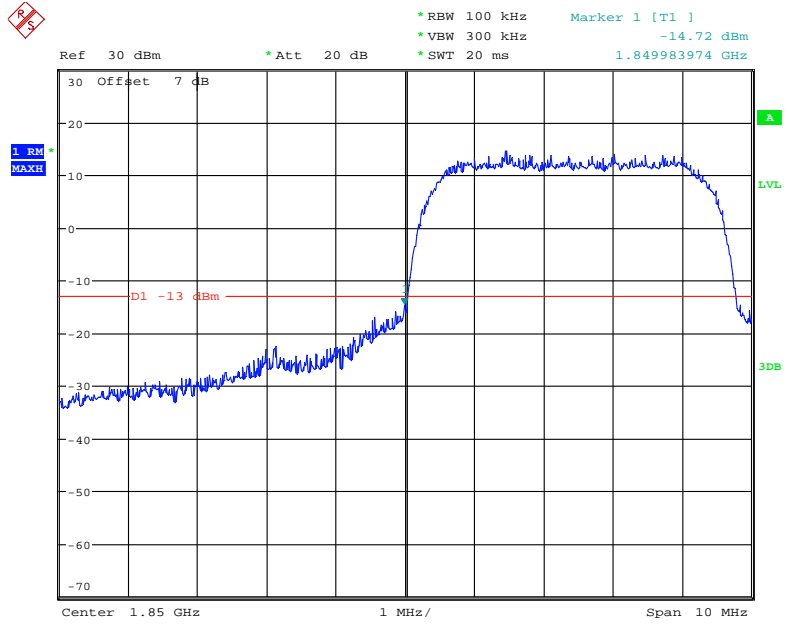

Date: 7.SEP.2021 10:52:10

PCS Band, Right Band Edge for HSUPA (BPSK) Mode

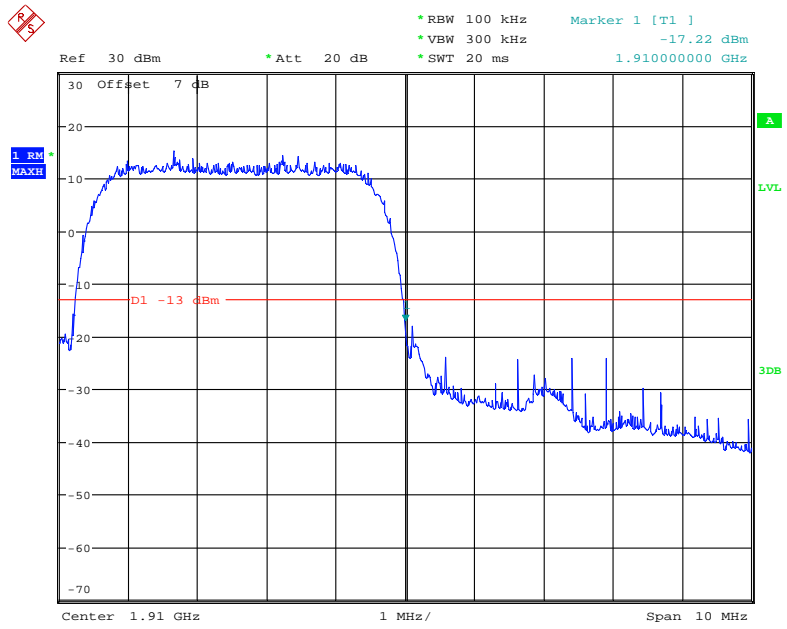

Date: 7.SEP.2021 10:51:02

AWS Band, Left Band Edge for RMC (BPSK) Mode

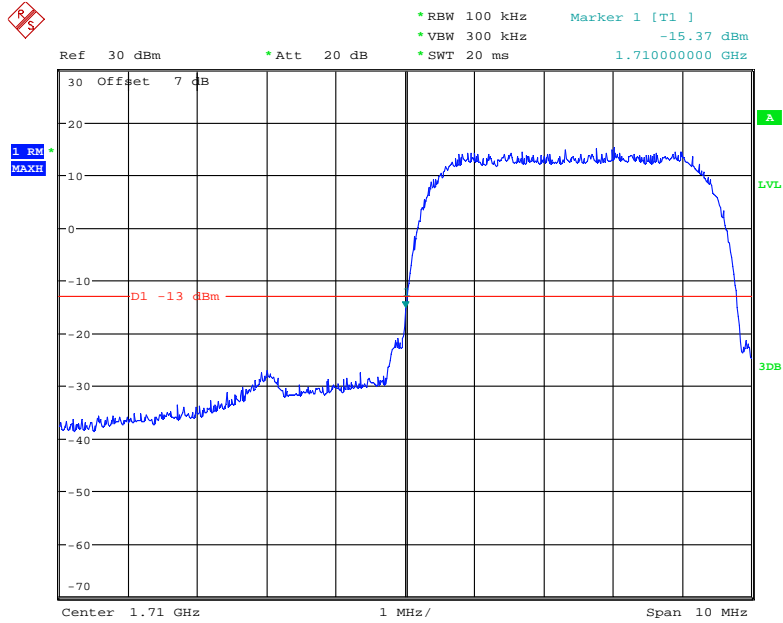

Date: 7.SEP.2021 10:38:59

AWS Band, Right Band Edge for RMC (BPSK) Mode

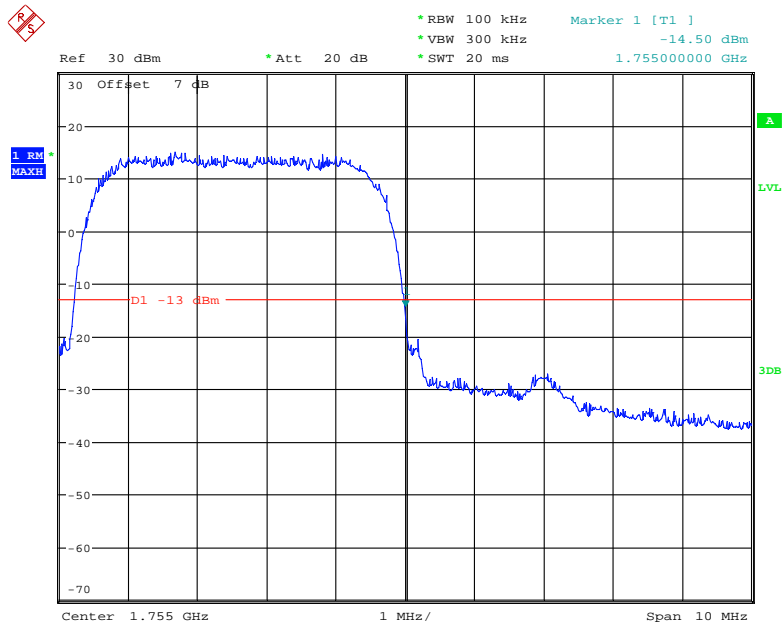

Date: 7.SEP.2021 10:39:49

AWS Band, Left Band Edge for HSDPA (16QAM) Mode

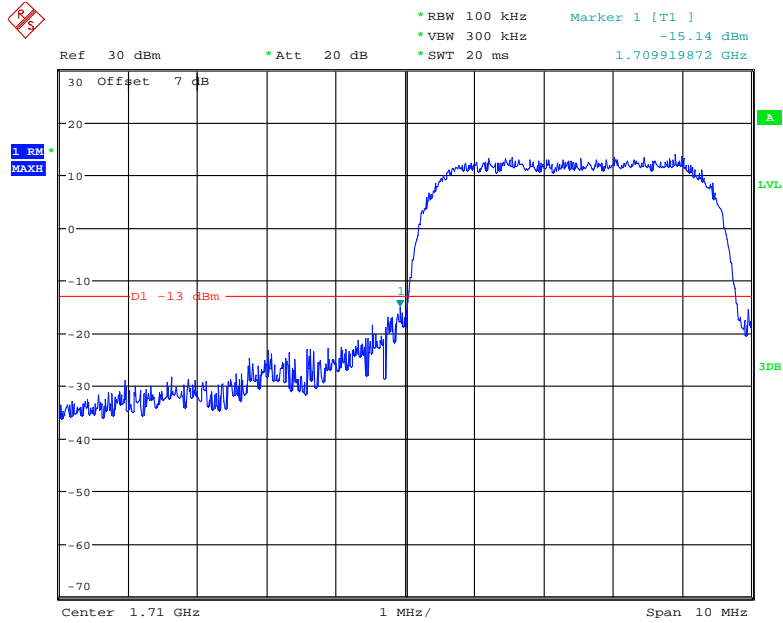

AWS Band, Right Band Edge for HSDPA (16QAM) Mode

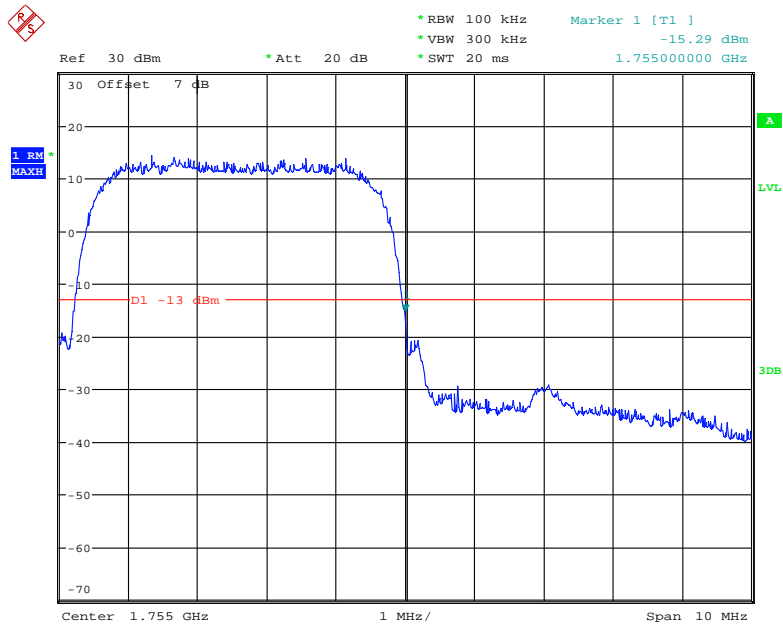

AWS Band, Left Band Edge for HSUPA (BPSK) Mode

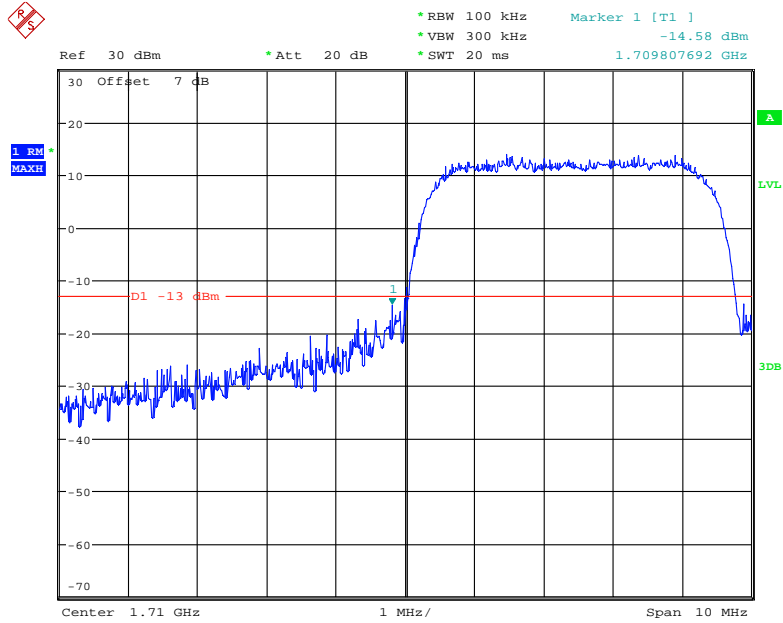

Date: 7.SEP.2021 10:44:45

AWS Band, Right Band Edge for HSUPA (BPSK) Mode

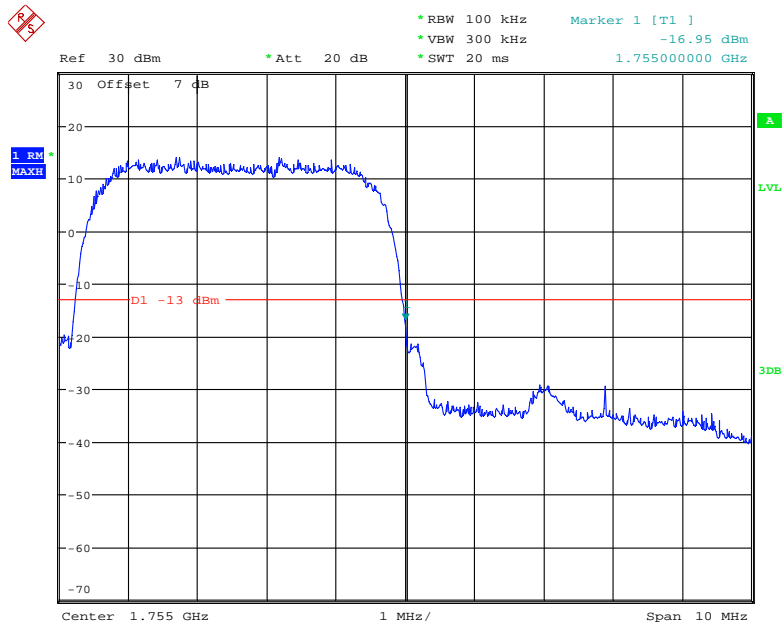

Date: 7.SEP.2021 10:45:35

The test plots of LTE bands please refer to the Appendix C.

FCC § 2.1055; § 22.355; § 24.235; §27.54 - FREQUENCY STABILITY

Applicable Standard

FCC § 2.1055, §22.355, §24.235 and & §27.54.

According to FCC §2.1055, the frequency stability shall be sufficient to ensure that the fundamental emissions stay within the authorized bands of operation.

According to §22.355, the carrier frequency of each transmitter in the Public Mobile Services must be maintained within the tolerances given in Table below:

Frequency Tolerance for Transmitters in the Public Mobile Services

Frequency Range (MHz)	Base, fixed (ppm)	Mobile ≤ 3 watts (ppm)	Mobile > 3 watts (ppm)
25 to 50	20.0	20.0	50.0
50 to 450	5.0	5.0	50.0
450 to 512	2.5	5.0	5.0
821 to 896	1.5	2.5	2.5
928 to 929.	5.0	N/A	N/A
929 to 960.	1.5	N/A	N/A
2110 to 2220	10.0	N/A	N/A

According to §24.235, the frequency stability shall be sufficient to ensure that the fundamental emissions stays within the authorized frequency block.

Test Procedure

Frequency Stability vs. Temperature: The equipment under test was connected to an external DC power supply and the RF output was connected to communication test set via feed-through attenuators. The EUT was placed inside the temperature chamber. The DC leads and RF output cable exited the chamber through an opening made for the purpose.

After the temperature stabilized for approximately 20 minutes, the frequency output was recorded from the communication test set.

Frequency Stability vs. Voltage: For hand carried, battery powered equipment; reduce primary supply voltage to the battery operating end point which shall be specified by the manufacturer.

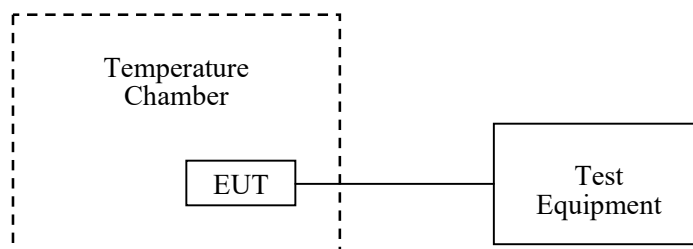

Test Data**Environmental Conditions**

Temperature:	27 °C
Relative Humidity:	58 %
ATM Pressure:	101.0 kPa

The testing was performed by Ting Lv from 2021-09-06 to 2021-09-10.

EUT operation mode: Transmitting

Test Result: Pass

Please refer to the following tables.

Cellular Band (Part 22H)**GSM Mode**

Middle Channel, $f_0=836.6\text{MHz}$				
Temperature (°C)	Voltage Supplied (V _{DC})	Frequency Error (Hz)	Frequency Error (ppm)	Limit (ppm)
-30	N.V.	4	0.0048	2.5
-20		2	0.0024	2.5
-10		3	0.0036	2.5
0		2	0.0024	2.5
10		1	0.0012	2.5
20		-4	0.0048	2.5
30		6	0.0072	2.5
40		4	0.0048	2.5
50		1	0.0012	2.5
20		L.V.	2	0.0024
	H.V.	10	0.0120	2.5

WCDMA Mode

Middle Channel, $f_0=836.6\text{MHz}$				
Temperature (°C)	Voltage Supplied (V_{DC})	Frequency Error (Hz)	Frequency Error (ppm)	Limit (ppm)
-30	N.V.	-2	-0.0024	2.5
-20		8	0.0096	2.5
-10		3	0.0036	2.5
0		-4	-0.0048	2.5
10		3	0.0036	2.5
20		-13	0.0155	2.5
30		10	0.0120	2.5
40		-7	-0.0084	2.5
50		-6	-0.0072	2.5
20	L.V.	2	0.0024	2.5
	H.V.	1	0.0012	2.5

PCS Band (Part 24E)**GSM Mode**

Middle Channel, $f_0=1880.0\text{ MHz}$				
Temperature (°C)	Voltage Supplied (V_{DC})	Frequency Error (Hz)	Frequency Error (ppm)	Result
-30	N.V.	6	0.0032	Pass
-20		10	0.0053	Pass
-10		5	0.0027	Pass
0		3	0.0016	Pass
10		1	0.0005	Pass
20		26	0.0138	Pass
30		-3	-0.0016	Pass
40		-6	-0.0032	Pass
50		-5	-0.0027	Pass
20	L.V.	1	0.0005	Pass
	H.V.	-3	-0.0016	Pass

WCDMA Mode

Middle Channel, $f_0=1880.0$ MHz				
Temperature (°C)	Voltage Supplied (V_{DC})	Frequency Error (Hz)	Frequency Error (ppm)	Result
-30	N.V.	-12	-0.0064	Pass
-20		15	0.0080	Pass
-10		17	0.0090	Pass
0		-18	-0.0096	Pass
10		-12	-0.0064	Pass
20		-16	0.0085	Pass
30		12	0.0064	Pass
40		-18	-0.0096	Pass
50		-13	-0.0069	Pass
20	L.V.	14	0.0074	Pass
	H.V.	-15	-0.0080	Pass

AWS Band (Part 27)

Temperature (°C)	Power Supplied (V_{DC})	F_L (MHz)	F_H (MHz)	F_L Limit (MHz)	F_H Limit (MHz)
-30	N.V.	1710.6134	1754.4196	1710	1755
-20		1710.7230	1754.3968	1710	1755
-10		1710.6326	1754.4473	1710	1755
0		1710.5647	1754.3859	1710	1755
10		1710.6627	1754.4140	1710	1755
20		1710.6140	1754.4160	1710	1755
30		1710.6277	1754.3501	1710	1755
40		1710.6392	1754.3711	1710	1755
50		1710.6222	1754.4264	1710	1755
20	L.V.	1710.6172	1754.4268	1710	1755
	H.V.	1710.6543	1754.4231	1710	1755

LTE:
QPSK:
Band 2:

10.0 MHz Middle Channel, $f_0=1880\text{MHz}$				
Temperature (°C)	Voltage Supplied (V _{DC})	Frequency Error (Hz)	Frequency Error (ppm)	Result
-30	N.V.	15	-0.0080	Pass
-20		-11	-0.0059	Pass
-10		-7	-0.0037	Pass
0		5	0.0027	Pass
10		8	0.0043	Pass
20		7	0.0037	Pass
30		-4	-0.0021	Pass
40		3	0.0016	Pass
50		11	0.0059	Pass
20		L.V.	-5	-0.0027
	H.V.	10	0.0053	Pass

Band 4:

10 MHz Bandwidth					
Temperature (°C)	Power Supplied (V _{DC})	F _L (MHz)	F _H (MHz)	F _L Limit (MHz)	F _H Limit (MHz)
-30	N.V.	1710.1374	1754.9859	1710	1755
-20		1710.0703	1754.9227	1710	1755
-10		1710.1138	1754.9598	1710	1755
0		1710.0775	1754.8984	1710	1755
10		1710.1196	1754.9019	1710	1755
20		1710.0732	1754.8917	1710	1755
30		1710.0768	1754.9355	1710	1755
40		1710.1234	1754.9024	1710	1755
50		1710.0475	1754.9291	1710	1755
20		L.V.	1710.0716	1754.9761	1710
	H.V.	1710.1379	1754.9864	1710	1755

Band 5:

10.0 MHz Middle Channel, $f_0=836.5\text{MHz}$				
Temperature (°C)	Voltage Supplied (V_{DC})	Frequency Error (Hz)	Frequency Error (ppm)	Limit (ppm)
-30	N.V.	2	0.0024	2.5
-20		-2	-0.0024	2.5
-10		7	-0.0084	2.5
0		6	0.0072	2.5
10		5	0.0060	2.5
20		4	0.0048	2.5
30		-6	-0.0072	2.5
40		-8	-0.0096	2.5
50		-7	-0.0084	2.5
20		L.V.	9	0.0108
	H.V.	-4	-0.0048	2.5

Band 7:

10 MHz Bandwidth					
Temperature (°C)	Power Supplied (V_{DC})	F_L (MHz)	F_H (MHz)	F_L Limit (MHz)	F_H Limit (MHz)
-30	N.V.	2500.4412	2569.1154	2500	2570
-20		2500.4675	2569.1337	2500	2570
-10		2500.4913	2569.1539	2500	2570
0		2500.4542	2569.1745	2500	2570
10		2500.4432	2569.1927	2500	2570
20		2500.4657	2569.2112	2500	2570
30		2500.4895	2569.2315	2500	2570
40		2500.5134	2569.2514	2500	2570
50		2500.5378	2569.2713	2500	2570
20		L.V.	2500.5624	2569.2913	2500
	H.V.	2500.5875	2569.3095	2500	2570

Band 17:

10 MHz Bandwidth					
Temperature (°C)	Power Supplied (V _{DC})	F _L (MHz)	F _H (MHz)	F _L Limit (MHz)	F _H Limit (MHz)
-30	N.V.	704.7298	715.0942	704	716
-20		704.7554	715.1124	704	716
-10		704.7797	715.1321	704	716
0		704.8029	715.1529	704	716
10		704.8285	715.1713	704	716
20		704.8541	715.1897	704	716
30		704.8773	715.2105	704	716
40		704.9017	715.2301	704	716
50		704.9261	715.2497	704	716
20		L.V.	704.9505	715.2693	704
	H.V.	704.9761	715.2877	704	716

Band 38:

10 MHz Bandwidth					
Temperature (°C)	Power Supplied (V _{DC})	F _L (MHz)	F _H (MHz)	F _L Limit (MHz)	F _H Limit (MHz)
-30	N.V.	2570.1673	2619.8600	2570	2620
-20		2570.2096	2619.8558	2570	2620
-10		2570.1413	2619.8541	2570	2620
0		2570.1764	2619.8792	2570	2620
10		2570.2860	2619.8813	2570	2620
20		2570.1799	2619.8212	2570	2620
30		2570.2356	2619.8776	2570	2620
40		2570.2508	2619.8626	2570	2620
50		2570.2160	2619.8962	2570	2620
20		L.V.	2570.2509	2619.8995	2570
	H.V.	2570.2458	2619.8721	2570	2620

Band 41:

10 MHz Bandwidth					
Temperature (°C)	Power Supplied (V _{DC})	F _L (MHz)	F _H (MHz)	F _L Limit (MHz)	F _H Limit (MHz)
-30	N.V.	2535.2186	2654.8684	2535	2655
-20		2535.2672	2654.9092	2535	2655
-10		2535.2902	2654.8877	2535	2655
0		2535.2238	2654.8971	2535	2655
10		2535.2135	2654.8606	2535	2655
20		2535.2600	2654.8796	2535	2655
30		2535.2722	2654.8859	2535	2655
40		2535.2377	2654.9204	2535	2655
50		2535.2470	2654.8585	2535	2655
20	L.V.	2535.2771	2654.8660	2535	2655
	H.V.	2535.2375	2654.9329	2535	2655

Note: the frequency range 2535-2655MHz was declared by applicant.

Band 66:

10 MHz Bandwidth					
Temperature (°C)	Power Supplied (V _{DC})	F _L (MHz)	F _H (MHz)	F _L Limit (MHz)	F _H Limit (MHz)
-30	N.V.	1710.3412	1779.1234	1710	1780
-20		1710.3675	1779.1413	1710	1780
-10		1710.3914	1779.1615	1710	1780
0		1710.4147	1779.1824	1710	1780
10		1710.4423	1779.2213	1710	1780
20		1710.4654	1779.2184	1710	1780
30		1710.4887	1779.2396	1710	1780
40		1710.5138	1779.2594	1710	1780
50		1710.5375	1779.2785	1710	1780
20	L.V.	1710.5624	1779.2985	1710	1780
	H.V.	1710.5874	1779.3164	1710	1780

16QAM:**Band 2:**

10.0 MHz Middle Channel, $f_0 = 1880\text{MHz}$				
Temperature (°C)	Voltage Supplied (V _{DC})	Frequency Error (Hz)	Frequency Error (ppm)	Result
-30	N.V.	9	0.0048	Pass
-20		-6	-0.0032	Pass
-10		10	0.0053	Pass
0		5	-0.0027	Pass
10		10	0.0053	Pass
20		-10	-0.0053	Pass
30		-7	-0.0037	Pass
40		-9	-0.0048	Pass
50		6	0.0032	Pass
20		L.V.	6	0.0032
	H.V.	4	0.0021	Pass

Band 4:

10 MHz Bandwidth					
Temperature (°C)	Power Supplied (V _{DC})	F _L (MHz)	F _H (MHz)	F _L Limit (MHz)	F _H Limit (MHz)
-30	N.V.	1710.2119	1754.8498	1710	1755
-20		1710.2716	1754.8248	1710	1755
-10		1710.2465	1754.8875	1710	1755
0		1710.2570	1754.9016	1710	1755
10		1710.2766	1754.8815	1710	1755
20		1710.2104	1754.9258	1710	1755
30		1710.2459	1754.8616	1710	1755
40		1710.2472	1754.9080	1710	1755
50		1710.2616	1754.8445	1710	1755
20		L.V.	1710.1907	1754.8865	1710
	H.V.	1710.2228	1754.9038	1710	1755

Band 5:

10.0 MHz Middle Channel, $f_0=836.5\text{MHz}$				
Temperature (°C)	Voltage Supplied (V_{DC})	Frequency Error (Hz)	Frequency Error (ppm)	Limit (ppm)
-30	N.V.	-4	-0.0048	2.5
-20		3	0.0036	2.5
-10		8	0.0096	2.5
0		9	0.0108	2.5
10		-7	-0.0084	2.5
20		-10	-0.0120	2.5
30		6	0.0072	2.5
40		2	0.0024	2.5
50		7	0.0084	2.5
20		L.V.	6	0.0072
	H.V.	-7	-0.0084	2.5

Band 7:

10 MHz Bandwidth					
Temperature (°C)	Power Supplied (V_{DC})	F_L (MHz)	F_H (MHz)	F_L Limit (MHz)	F_H Limit (MHz)
-30	N.V.	2500.3345	2569.4337	2500	2570
-20		2500.3594	2569.4512	2500	2570
-10		2500.3848	2569.4715	2500	2570
0		2500.4073	2569.4924	2500	2570
10		2500.4334	2569.5123	2500	2570
20		2500.4585	2569.5295	2500	2570
30		2500.4812	2569.5497	2500	2570
40		2500.5067	2569.5694	2500	2570
50		2500.5313	2569.5896	2500	2570
20		L.V.	2500.5552	2569.6081	2500
	H.V.	2500.5816	2569.6275	2500	2570

Band 17:

10 MHz Bandwidth					
Temperature (°C)	Power Supplied (V _{DC})	F _L (MHz)	F _H (MHz)	F _L Limit (MHz)	F _H Limit (MHz)
-30	N.V.	704.5517	715.2238	704	716
-20		704.5773	715.2422	704	716
-10		704.6016	715.2619	704	716
0		704.6248	715.2827	704	716
10		704.6504	715.3011	704	716
20		704.6767	715.3195	704	716
30		704.6992	715.3403	704	716
40		704.7236	715.3599	704	716
50		704.7482	715.3795	704	716
20	L.V.	704.7724	715.3991	704	716
	H.V.	704.7981	715.4175	704	716

Band 38:

10 MHz Bandwidth					
Temperature (°C)	Power Supplied (V _{DC})	F _L (MHz)	F _H (MHz)	F _L Limit (MHz)	F _H Limit (MHz)
-30	N.V.	2570.2286	2619.8633	2570	2620
-20		2570.2593	2619.8363	2570	2620
-10		2570.2607	2619.9075	2570	2620
0		2570.2346	2619.8417	2570	2620
10		2570.2117	2619.9101	2570	2620
20		2570.2404	2619.8727	2570	2620
30		2570.2485	2619.8881	2570	2620
40		2570.2306	2619.9065	2570	2620
50		2570.2747	2619.8908	2570	2620
20	L.V.	2570.2621	2619.8320	2570	2620
	H.V.	2570.2014	2619.9164	2570	2620

Band 41:

10 MHz Bandwidth					
Temperature (°C)	Power Supplied (V _{DC})	F _L (MHz)	F _H (MHz)	F _L Limit (MHz)	F _H Limit (MHz)
-30	N.V.	2535.2057	2654.8898	2535	2655
-20		2535.1955	2654.9013	2535	2655
-10		2535.2274	2654.8942	2535	2655
0		2535.2166	2654.8736	2535	2655
10		2535.2047	2654.8845	2535	2655
20		2535.2399	2654.8930	2535	2655
30		2535.2196	2654.9115	2535	2655
40		2535.1732	2654.9296	2535	2655
50		2535.2299	2654.9016	2535	2655
20	L.V.	2535.1933	2654.8725	2535	2655
	H.V.	2535.2355	2654.8842	2535	2655

Note: the frequency range 2535-2655MHz was declared by applicant.

Band 66:

10 MHz Bandwidth					
Temperature (°C)	Power Supplied (V _{DC})	F _L (MHz)	F _H (MHz)	F _L Limit (MHz)	F _H Limit (MHz)
-30	N.V.	1710.7323	1779.3245	1710	1780
-20		1710.7554	1779.3435	1710	1780
-10		1710.7812	1779.3626	1710	1780
0		1710.8035	1779.3837	1710	1780
10		1710.8287	1779.4021	1710	1780
20		1710.8545	1779.4215	1710	1780
30		1710.8771	1779.4412	1710	1780
40		1710.9025	1779.4612	1710	1780
50		1710.9265	1779.4854	1710	1780
20	L.V.	1710.9542	1779.5451	1710	1780
	H.V.	1710.9765	1779.5189	1710	1780

***** END OF REPORT *****