



FCC PART 27  
FCC PART 22H, PART 24E  
TEST REPORT

For

**TECNO MOBILE LIMITED**

FLAT 39 8/F BLOCK D WAH LOK INDUSTRIAL CENTRE 31-35 SHAN MEI STREET  
FOTAN NT Hong Kong

**FCC ID: 2ADYY-KF6P**

<b>Report Type:</b> Original Report	<b>Product Type:</b> Mobile phone
<b>Report Number:</b> <u>SZ1210604-21497E-RF-00A</u>	
<b>Report Date:</b> <u>2021-07-24</u>	
<b>Reviewed By:</b> <u>RF Engineer</u>	<i>Jacob Kong</i>
<b>Prepared By:</b> Bay Area Compliance Laboratories Corp. (Shenzhen) 5F(B-West) ,6F,7F,the 3rd Phase of Wan Li Industrial Building D,Shihua Rd, FuTian Free Trade Zone, Shenzhen, China Tel: +86-755-33320018 Fax: +86-755-33320008 <a href="http://www.baclcorp.com.cn">www.baclcorp.com.cn</a>	

**Note:** This report may contain data that are not covered by the A2LA accreditation and are marked with an asterisk “★”.

BACL is not responsible for the authenticity of any test data provided by the applicant. Data included from the applicant that may affect test results are marked with an asterisk “\*”. Customer model name, addresses, names, trademarks etc. are not considered data.

This report cannot be reproduced except in full, without prior written approval of the Company. Unless otherwise stated the results shown in this test report refer only to the sample(s) tested. This report is valid only with a valid digital signature. The digital signature may be available only under the Adobe software above version 7.0.

## TABLE OF CONTENTS

<b>GENERAL INFORMATION.....</b>	<b>3</b>
PRODUCT DESCRIPTION FOR EQUIPMENT UNDER TEST (EUT).....	3
OBJECTIVE.....	3
TEST METHODOLOGY.....	4
MEASUREMENT UNCERTAINTY.....	4
TEST FACILITY.....	4
<b>SYSTEM TEST CONFIGURATION.....</b>	<b>5</b>
DESCRIPTION OF TEST CONFIGURATION.....	5
EQUIPMENT MODIFICATIONS.....	6
SUPPORT EQUIPMENT LIST AND DETAILS.....	6
SUPPORT CABLE DESCRIPTION.....	6
BLOCK DIAGRAM OF TEST SETUP.....	7
<b>SUMMARY OF TEST RESULTS.....</b>	<b>8</b>
<b>TEST EQUIPMENT LIST.....</b>	<b>9</b>
<b>FCC §1.1307(B) &amp; §2.1093 - RF EXPOSURE INFORMATION.....</b>	<b>11</b>
APPLICABLE STANDARD.....	11
TEST RESULT.....	11
<b>FCC §2.1047 - MODULATION CHARACTERISTIC.....</b>	<b>12</b>
<b>FCC § 2.1046, § 22.913 (A) &amp; § 24.232 (C); §27.50 (C) (D) (H) - RF OUTPUT POWER.....</b>	<b>13</b>
APPLICABLE STANDARD.....	13
TEST PROCEDURE.....	13
TEST DATA.....	13
<b>FCC §2.1049, §22.917, §22.905 &amp; §24.238 &amp; §27.53 - OCCUPIED BANDWIDTH.....</b>	<b>41</b>
APPLICABLE STANDARD.....	41
TEST PROCEDURE.....	41
TEST DATA.....	41
<b>FCC §2.1051, §22.917(A) &amp; §24.238(A); §27.53 - SPURIOUS EMISSIONS AT ANTENNA TERMINALS.....</b>	<b>72</b>
APPLICABLE STANDARD.....	72
TEST PROCEDURE.....	72
TEST DATA.....	72
<b>FCC § 2.1053; § 22.917 (A);§ 24.238 (A); §27.53 SPURIOUS RADIATED EMISSIONS.....</b>	<b>90</b>
APPLICABLE STANDARD.....	90
TEST PROCEDURE.....	90
TEST DATA.....	90
<b>FCC § 22.917 (A);§ 24.238 (A); §27.53(C) (H)(M) - BAND EDGES.....</b>	<b>102</b>
APPLICABLE STANDARD.....	102
TEST PROCEDURE.....	102
TEST DATA.....	102
<b>FCC § 2.1055; § 22.355; § 24.235; §27.54 - FREQUENCY STABILITY.....</b>	<b>116</b>
APPLICABLE STANDARD.....	116
TEST PROCEDURE.....	116
TEST DATA.....	117

## GENERAL INFORMATION

### Product Description for Equipment under Test (EUT)

Product	Mobile Phone
Tested Model	KF6p
Frequency Range	GSM 850: 824-849MHz(TX); 869-894MHz(RX) PCS 1900: 1850-1910MHz(TX); 1930-1990MHz(RX) WCDMA Band 2: 1850-1910MHz(TX); 1930-1990MHz(RX) WCDMA Band 4: 1710-1755MHz(TX); 2110-2155MHz(RX) WCDMA Band 5: 824-849MHz(TX); 869-894MHz(RX) LTE Band 2: 1850-1910MHz(TX); 1930-1990MHz(RX) LTE Band 4: 1710-1755MHz(TX); 2110-2155MHz(RX) LTE Band 5: 824-849MHz(TX); 869-894MHz(RX) LTE Band 7: 2500-2570MHz(TX); 2620-2690MHz(RX) LTE Band 17: 704-716MHz(TX); 734-746MHz(RX) LTE Band 38: 2570-2620MHz(TX/RX) LTE Band 41: 2535-2655MHz(TX/RX)
Modulation Technique	2G: GMSK, 8PSK 3G: BPSK, QPSK, 16QAM 4G: QPSK, 16QAM
Antenna Specification*	EGSM850/WCDMA Band 5/LTE Band 5: -1.6dBi PCS1900/WCDMA Band 2/ LTE Band 2: -0.7dBi WCDMA Band 4/ LTE Band 4: -0.7dBi LTE Band 7: -0.4dBi LTE Band 17: -1.9dBi LTE Band 38/41: -0.7dBi (provided by the applicant)
Voltage Range	DC 3.87V from battery or DC 5V from adapter
Date of Test	2021-06-08 to 2021-07-24
Sample number	SZ1210604-21497E-RF-S_8LI; RE&CE: SZ1210604-21497E-RF-S_8LM (Assigned by BAACL, Shenzhen)
Received date	2021-06-04
Sample/EUT Status	Good condition
Normal/Extreme Condition	L.V.: Low Voltage 3.45V <sub>DC</sub> N.V.: Normal Voltage 3.87V <sub>DC</sub> H.V.: High Voltage 4.45V <sub>DC</sub> The extreme condition was declared by the applicant
Adapter information	Model: U100TSA Input: AC 100-240V ~ 50/60Hz, 0.3A Output: DC 5.0V, 2.0A

### Objective

This test report is in accordance with Part 2-Subpart J, Part 22-Subpart H and Part 24-Subpart E and Subpart 27 of the Federal Communication Commissions rules.

The objective is to determine the compliance of the EUT with FCC rules for output power, modulation characteristic, occupied bandwidth, and spurious emission at antenna terminal, spurious radiated emission, frequency stability and band edge.

## Test Methodology

All tests and measurements indicated in this document were performed in accordance with the Code of Federal Regulations Title 47 Part 2-Subpart J as well as the following parts:

Part 22 Subpart H - Public Mobile Services  
 Part 24 Subpart E - Personal Communication Services  
 Part 27 – Miscellaneous wireless communications services

ANSI C63.26-2015: American National Standard for Compliance Testing of Transmitters Used in Licensed Radio Services

All emissions measurement was performed at Bay Area Compliance Laboratories Corp. (Shenzhen). The radiated testing was performed at an antenna-to-EUT distance of 3 meters. Each test item follows test standards and with no deviation.

## Measurement Uncertainty

Parameter		Uncertainty
Occupied Channel Bandwidth		±5%
RF output power, conducted		±0.73dB
Unwanted Emission, conducted		±1.6dB
Emissions, Radiated	Below 1GHz	±4.75dB
	Above 1GHz	±4.88dB
Temperature		±1°C
Humidity		±6%
Supply voltages		±0.4%

*Note: The extended uncertainty given in this report is obtained by combining the standard uncertainty times the coverage factor K with the 95% confidence interval. Otherwise required by the applicant or Product Regulations, Decision Rule in this report did not consider the uncertainty.*

## Test Facility

The Test site used by Bay Area Compliance Laboratories Corp. (Shenzhen) to collect test data is located on the 5F(B-West) ,6F,7F,the 3rd Phase of Wan Li Industrial Building D,Shihua Rd, FuTian Free Trade Zone, Shenzhen, China.

The test site has been approved by the FCC under the KDB 974614 D01 and is listed in the FCC Public Access Link (PAL) database, FCC Registration No.: 342867, the FCC Designation No.: CN1221.

The test site has been registered with ISED Canada under ISED Canada Registration Number 3062B.

## SYSTEM TEST CONFIGURATION

### Description of Test Configuration

The final qualification test was performed with the EUT operating at normal mode.

Test was performed as below table:

Frequency band	Bandwidth (MHz)	Test Frequency(MHz)		
		Low	Middle	High
EGSM850	0.25	824.2	836.6	848.8
DCS1900	0.25	1850.2	1880	1909.8
WCDMA B2	4.2	1852.4	1880	1907.6
WCDMA B4	4.2	1712.4	1732.6	1752.6
WCDMA B5	4.2	826.4	836.6	846.6
LTE B2	1.4	1850.7	1880	1909.3
	3	1851.5	1880	1908.5
	5	1852.5	1880	1907.5
	10	1855	1880	1905
	15	1857.5	1880	1902.5
	20	1860	1880	1900
LTE B4	1.4	1710.7	1732.5	1754.3
	3	1711.5	1732.5	1753.5
	5	1712.5	1732.5	1752.5
	10	1715	1732.5	1750
	15	1717.5	1732.5	1747.5
	20	1720	1732.5	1745
LTE B5	1.4	824.7	836.5	848.3
	3	825.5	836.5	847.5
	5	826.5	836.5	846.5
	10	829	836.5	844
LTE B7	5	2502.5	2535	2567.5
	10	2505	2535	2565
	15	2507.5	2535	2562.5
	20	2510	2535	2560
LTE B17	5	706.5	710	713.5
	10	709	710	711

Frequency band	Bandwidth (MHz)	Test Frequency(MHz)		
		Low	Middle	High
LTE B38	5	2572.5	2595	2617.5
	10	2575	2595	2615
	15	2577.5	2595	2612.5
	20	2580	2595	2610
LTE B41	5	2537.5	2595	2652.5
	10	2540	2595	2650
	15	2542.5	2595	2647.5
	20	2545	2595	2645

**Equipment Modifications**

No modification was made to the EUT.

**Support Equipment List and Details**

Manufacturer	Description	Model	Serial Number
Rohde & Schwarz	Wideband Radio Communication Tester	CMW500	1201.002K50-116218-UY
Rohde & Schwarz	Universal Radio Communication Tester	CMU200	110605

**Support Cable Description**

Cable Description	Length (m)	From / Port	To
Unshielded Un-detachable AC cable	1.2	AC Power	CMW500/ CMU200

**Block Diagram of Test Setup**

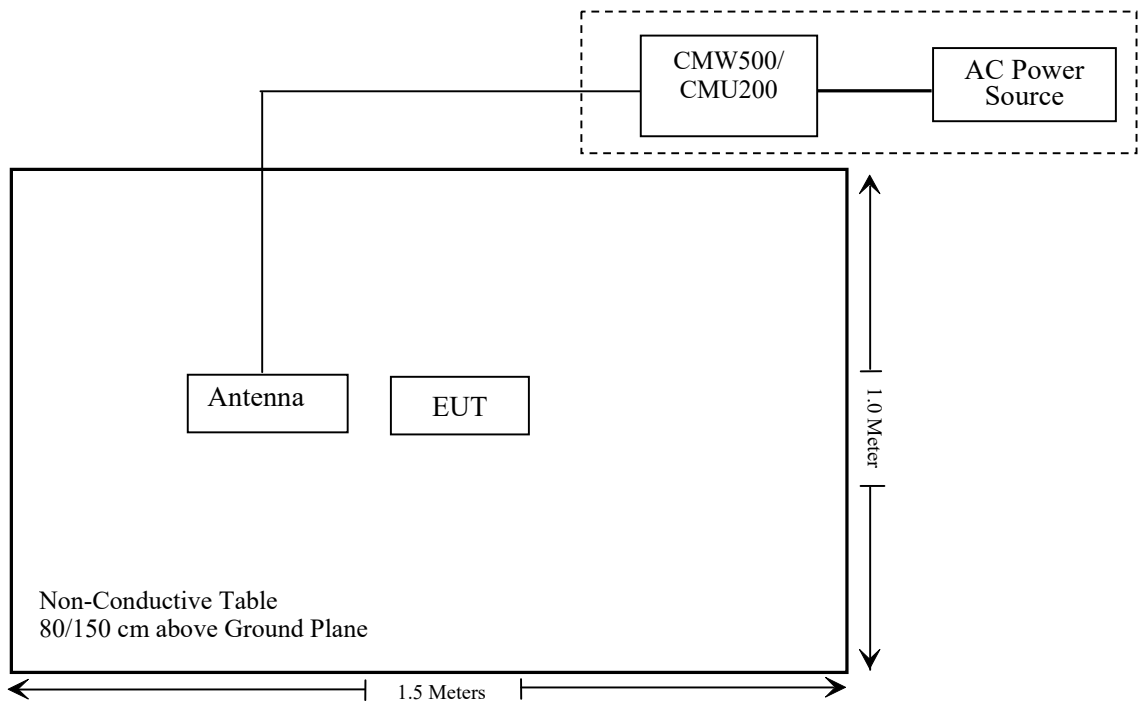

**SUMMARY OF TEST RESULTS**

<b>FCC Rules</b>	<b>Description of Test</b>	<b>Result</b>
§ 1.1307 , §2.1093	RF Exposure (SAR)	Compliant*
§2.1046; § 22.913 (a); § 24.232 (c); §27.50 (c) (d) (h)	RF Output Power	Compliant
§ 2.1047	Modulation Characteristics	Not Applicable
§ 2.1049; § 22.905; § 22.917; § 24.238; §27.53	Occupied Bandwidth	Compliant
§ 2.1051; § 22.917 (a); § 24.238 (a); §27.53	Spurious Emissions at Antenna Terminal	Compliant
§ 2.1053; § 22.917 (a); § 24.238 (a); §27.53	Field Strength of Spurious Radiation	Compliant
§ 22.917 (a); § 24.238 (a); §27.53(c)(h) (m)	Band Edge	Compliant
§ 2.1055; § 22.355; § 24.235; §27.54;	Frequency stability	Compliant

Note: \* Please refer to SAR report released by BACL, report number: SZ1210604-21497E-20.



**TEST EQUIPMENT LIST**

Manufacturer	Description	Model	Serial Number	Calibration Date	Calibration Due Date
<b>Radiated Emission Test</b>					
R&S	EMI Test Receiver	ESR3	102455	2020/08/04	2021/08/03
Sonoma instrument	Pre-amplifier	310 N	186238	2020/08/04	2021/08/03
Sunol Sciences	Broadband Antenna	JB1	A040904-2	2020/12/22	2023/12/21
COM-POWER	Dipole Antenna	AD-100	721027	NCR	NCR
Unknown	Cable 2	RF Cable 2	F-03-EM197	2020/11/29	2021/11/28
Unknown	Cable	Chamber Cable 1	F-03-EM236	2020/11/29	2021/11/28
Rohde & Schwarz	Spectrum Analyzer	FSV40-N	102259	2020/08/04	2021/08/03
COM-POWER	Pre-amplifier	PA-122	181919	2020/11/29	2021/11/28
Quinstar	Amplifier	QLW-18405536-J0	15964001002	2020/11/29	2021/11/28
Sunol Sciences	Horn Antenna	3115	9107-3694	2021/01/15	2024/01/14
A.H.System	Horn Antenna	SAS-200/571	135	2018/09/01	2021/08/31
Insulted Wire Inc.	RF Cable	SPS-2503-3150	02222010	2020/11/29	2021/11/28
Unknown	RF Cable	W1101-EQ1 OUT	F-19-EM005	2020/11/29	2021/11/28
MICRO-TRONICS	Passband filter	HPM50111	F-19-EM006	2021/04/20	2022/04/19
Unknown	High Pass filter	1.3GHz	101120	2021/04/20	2022/04/19
Ducommun Technologies	Horn antenna	ARH-4223-02	1007726-01 1304	2020/12/06	2023/12/05
Ducommun Technologies	Horn antenna	ARH-4223-02	1007726-02 1304	2020/12/06	2023/12/05
Agilent	Signal Generator	N5183A	MY51040755	2020/12/29	2021/12/28
Rohde & Schwarz	Wideband Radio Communication Tester	CMW500	1201.002K50-146520-wh	2020/08/04	2021/08/03
Rohde & Schwarz	Universal Radio Communication Tester	CMU200	115500	2020/07/31	2021/07/30

Manufacturer	Description	Model	Serial Number	Calibration Date	Calibration Due Date
<b>RF Conducted Test</b>					
Rohde & Schwarz	Signal and Spectrum Analyzer	FSV40	101473	2020/08/04	2021/08/03
Rohde & Schwarz	Wideband Radio Communication Tester	CMW500	1201.002K50-146520-wh	2020/08/04	2021/08/03
Unknown	RF Cable	Unknown	2301 276	2020/11/29	2021/11/28
Unknown	RF Cable	Unknown	DLO J5/W6102	2020/11/29	2021/11/28
Weinschel	Power divider	1515	MY628	2020/11/29	2021/11/28
Rohde & Schwarz	Universal Radio Communication Tester	CMU200	115500	2020/07/31	2021/07/30
instek	DC Power Supply	GPS-3030DD	EM832096	NCR	NCR
ESPEC	Temperature & Humidity Chamber	EL-10KA	9107726	2021/01/05	2022/01/05
Fluke	Digital Multimeter	287	19000011	2020/07/23	2021/07/22

\* Statement of Traceability: Bay Area Compliance Laboratories Corp. (Shenzhen) attests that all calibrations have been performed in accordance to requirements that traceable to National Primary Standards and International System of Units (SI).

---

## **FCC §1.1307(b) & §2.1093 - RF EXPOSURE INFORMATION**

---

### **Applicable Standard**

FCC§1.1310 and §2.1093.

### **Test Result**

Compliance, please refer to the SAR report: SZ1210604-21497E-20.

## **FCC §2.1047 - MODULATION CHARACTERISTIC**

---

According to FCC § 2.1047(d), Part 22H & 24E & 27 there is no specific requirement for digital modulation, therefore modulation characteristic is not presented.

**FCC § 2.1046, § 22.913 (a) & § 24.232 (c); §27.50 (c) (d) (h) - RF OUTPUT POWER**

**Applicable Standard**

According to FCC §2.1046 and §22.913 (a), the ERP of mobile transmitters and auxiliary test transmitters must not exceed 7 watts.

According to FCC §2.1046 and §24.232 (C), mobile and portable stations are limited to 2 watts EIRP and the equipment must employ a means for limiting power to the minimum necessary for successful communications.

The peak-to-average power ratio (PAPR) of the transmitter output power must not exceed 13 dB.

According to §27.50(c), Portable stations (hand-held devices) in the 600 MHz uplink band and the 698-746 MHz band, and fixed and mobile stations in the 600 MHz uplink band are limited to 3 watts ERP.

According to §27.50(d), the maximum EIRP must not exceed 1Watts (30dBm) for 1710-1780MHz.

According to §27.50(h), the maximum EIRP must not exceed 2Watts (33dBm) for 2500-2570MHz & 2496-2690MHz.

**Test Procedure**

*Conducted method:*

The RF output of the transmitter was connected to the CMW500/CMU200 through sufficient attenuation.

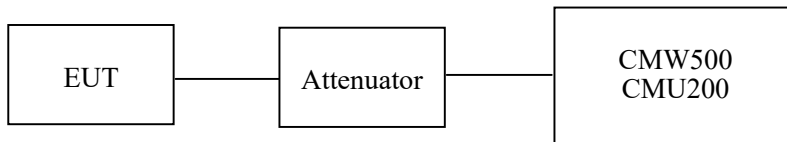

**Test Data**

**Environmental Conditions**

<b>Temperature:</b>	25~28.5 °C
<b>Relative Humidity:</b>	47 ~62 %
<b>ATM Pressure:</b>	101.0 kPa

*The testing was performed by Pedro Yun from 2021-07-09 to 2021-07-19.*

**Conducted Power**

**Cellular Band (Part 22H)**

Mode	Channel	Frequency (MHz)	Average Output Power (dBm)	ERP (dBm)	Limit (dBm)
GSM	128	824.2	32.4	28.65	38.45
	190	836.6	32.5	28.75	38.45
	251	848.8	32.5	28.75	38.45

Mode	Channel	Frequency (MHz)	Average Output Power (dBm)				ERP(dBm)				Limit (dBm)
			1 slot	2 slots	3 slots	4 slots	1 slot	2 slots	3 slots	4 slots	
GPRS	128	824.2	32.36	31.22	29.19	27.98	28.61	27.47	25.44	24.23	38.45
	190	836.6	32.48	31.29	29.23	28.01	28.73	27.54	25.48	24.26	38.45
	251	848.8	32.44	31.24	29.13	27.85	28.69	27.49	25.38	24.10	38.45

Mode	Channel	Frequency (MHz)	Average Output Power (dBm)				ERP(dBm)				Limit (dBm)
			1 slot	2 slots	3 slots	4 slots	1 slot	2 slots	3 slots	4 slots	
EGPRS	128	824.2	26.36	24.97	22.61	21.00	22.61	21.22	18.86	17.25	38.45
	190	836.6	26.23	24.81	22.45	20.81	22.48	21.06	18.70	17.06	38.45
	251	848.8	26.19	24.82	22.39	21.01	22.44	21.07	18.64	17.26	38.45

Mode	Test Mode	3GPP Sub Test	Average Output Power (dBm)			ERP(dBm)		
			Low	Mid	High	Low	Mid	High
WCDMA (Band 5)	RMC12.2k		23.34	23.36	23.23	19.59	19.61	19.48
	HSDPA	1	22.40	22.43	22.41	18.65	18.68	18.66
		2	22.89	22.90	22.83	19.14	19.15	19.08
		3	22.43	22.55	22.54	18.68	18.80	18.79
		4	22.33	22.35	22.30	18.58	18.60	18.55
	HSUPA	1	22.93	22.98	22.94	19.18	19.23	19.19
		2	22.89	22.90	22.83	19.14	19.15	19.08
		3	22.05	23.09	22.07	18.30	19.34	18.32
		4	22.83	22.94	22.89	19.08	19.19	19.14
		5	22.99	22.07	22.00	19.24	18.32	18.25
	HSPA+	/	22.68	22.34	22.75	18.93	18.59	19.00

Note: ERP(dBm) = Conducted Power(dBm) + Antenna Gain(dBd)  
 For GSM850/WCDMA Band 5: Antenna Gain = -1.6dBi = -3.75dBd (0dBd=2.15dBi)  
 The limit: ERP ≤ 38.45dBm

**PCS Band (Part 24E)**

Mode	Channel	Frequency (MHz)	Average Output Power (dBm)	EIRP(dBm)	Limit (dBm)
GSM	512	1850.2	26.7	26.0	33
	661	1880.0	27.2	26.5	33
	810	1909.8	27.5	26.8	33

Mode	Channel	Frequency (MHz)	Average Output Power (dBm)				EIRP(dBm)				Limit (dBm)
			1 slot	2 slots	3 slots	4 slots	1 slot	2 slots	3 slots	4 slots	
GPRS	512	1850.2	26.32	25.47	24.41	24.23	25.62	24.77	23.71	23.53	33
	661	1880.0	26.01	25.19	24.09	23.83	25.31	24.49	23.39	23.13	33
	810	1909.8	26.07	25.53	24.15	24.00	25.37	24.83	23.45	23.30	33

Mode	Channel	Frequency (MHz)	Average Output Power (dBm)				EIRP(dBm)				Limit (dBm)
			1 slot	2 slots	3 slots	4 slots	1 slot	2 slots	3 slots	4 slots	
EGPRS	512	1850.2	26.46	25.55	23.45	22.36	25.76	24.85	22.75	21.66	33
	661	1880.0	26.11	25.17	23.07	21.91	25.41	24.47	22.37	21.21	33
	810	1909.8	26.01	25.01	22.89	21.71	25.31	24.31	22.19	21.01	33

Mode	Test Mode	3GPP Sub Test	Average Output Power (dBm)			EIRP(dBm)		
			Low	Mid	High	Low	Mid	High
WCDMA (Band 2)	RMC12.2k		15.81	15.93	16.22	15.11	15.23	15.52
	HSDPA	1	15.07	15.06	15.56	14.37	14.36	14.86
		2	15.04	15.09	15.32	14.34	14.39	14.62
		3	15.01	15.01	15.38	14.31	14.31	14.68
		4	15.07	15.16	15.26	14.37	14.46	14.56
	HSUPA	1	14.72	14.84	15.04	14.02	14.14	14.34
		2	14.78	14.89	15.11	14.08	14.19	14.41
		3	14.82	14.94	15.17	14.12	14.24	14.47
		4	14.85	15.01	15.23	14.15	14.31	14.53
		5	14.88	15.03	15.29	14.18	14.33	14.59
	HSPA+	\	14.90	15.06	15.35	14.20	14.36	14.65

Note: EIRP(dBm) = Conducted Power(dBm) + Antenna Gain(dBi)  
 For PCS1900/WCDMA Band 2: Antenna Gain = -0.7dBi  
 The limit: EIRP ≤ 33dBm

**AWS Band (Part 27)**

Mode	Test Mode	3GPP Sub Test	Average Output Power (dBm)			EIRP(dBm)		
			Low	Mid	High	Low	Mid	High
WCDMA (Band 4)	RMC12.2k		17.78	17.71	17.53	17.08	17.01	16.83
	HSDPA	1	16.80	16.74	16.56	16.10	16.04	15.86
		2	16.84	16.82	16.61	16.14	16.12	15.91
		3	16.87	16.86	16.67	16.17	16.16	15.97
		4	16.80	16.74	16.56	16.10	16.04	15.86
	HSUPA	1	16.75	16.68	16.58	16.05	15.98	15.88
		2	16.78	16.75	16.60	16.08	16.05	15.90
		3	16.85	16.82	16.64	16.15	16.12	15.94
		4	16.88	16.84	16.67	16.18	16.14	15.97
		5	16.90	16.92	16.71	16.20	16.22	16.01
	HSPA+	\	16.92	16.97	16.76	16.22	16.27	16.06

Note: EIRP(dBm) = Conducted Power(dBm) + Antenna Gain(dBi)  
 For WCDMA Band 4: Antenna Gain = -0.7dBi  
 The limit: EIRP ≤ 30dBm



**Peak-to-average ratio (PAR)**

**Cellular Band**

Mode	Channel	PAR (dB)	Limit (dB)
GSM	Low	3.26	13
	Middle	3.35	13
	High	3.44	13

Mode	Channel	PAR (dB)	Limit (dB)
EGPRS	Low	3.24	13
	Middle	3.14	13
	High	3.31	13

Mode	Channel	PAR (dB)	Limit (dB)
RMC (BPSK)	Low	3.24	13
	Middle	3.29	13
	High	3.44	13
HSDPA (16QAM)	Low	3.24	13
	Middle	3.45	13
	High	3.65	13
HSUPA (BPSK)	Low	3.24	13
	Middle	3.24	13
	High	3.44	13
HSPA+	Low	3.25	13
	Middle	3.25	13
	High	3.43	13

**PCS Band**

Mode	Channel	PAR (dB)	Limit (dB)
GSM	Low	3.32	13
	Middle	3.18	13
	High	3.35	13

Mode	Channel	PAR (dB)	Limit (dB)
EGPRS	Low	3.14	13
	Middle	3.24	13
	High	3.51	13

Mode	Channel	PAR (dB)	Limit (dB)
RMC (BPSK)	Low	3.63	13
	Middle	3.22	13
	High	3.52	13
HSDPA (16QAM)	Low	3.42	13
	Middle	3.31	13
	High	3.62	13
HSUPA (BPSK)	Low	3.02	13
	Middle	3.34	13
	High	3.71	13
HSPA+	Low	3.21	13
	Middle	3.29	13
	High	3.42	13

**AWS Band**

Mode	Channel	PAR (dB)	Limit (dB)
RMC (BPSK)	Low	3.66	13
	Middle	3.22	13
	High	3.52	13
HSDPA (16QAM)	Low	3.41	13
	Middle	3.32	13
	High	3.64	13
HSUPA (BPSK)	Low	3.05	13
	Middle	3.34	13
	High	3.75	13
HSPA+	Low	3.25	13
	Middle	3.28	13
	High	3.44	13

**LTE Band 2:**

**Maximum Output Power**

Bandwidth (MHz)	Modulation	RB size/ RB Offset	Conducted Average Output Power (dBm)			EIRP(dBm)		
			Low	Mid	High	Low	Mid	High
1.4	QPSK	RB1#0	18.04	18.01	18.01	17.34	17.31	17.31
		RB1#3	18.18	18.14	18.19	17.48	17.44	17.49
		RB1#5	18.00	17.99	18.00	17.30	17.29	17.30
		RB3#0	18.15	18.09	18.12	17.45	17.39	17.42
		RB3#3	18.18	18.04	18.15	17.48	17.34	17.45
		RB6#0	17.04	17.04	17.08	16.34	16.34	16.38
	16QAM	RB1#0	17.05	17.14	17.05	16.35	16.44	16.35
		RB1#3	17.23	17.27	17.21	16.53	16.57	16.51
		RB1#5	17.04	17.11	17.13	16.34	16.41	16.43
		RB3#0	17.32	17.04	17.18	16.62	16.34	16.48
		RB3#3	17.35	17.07	17.18	16.65	16.37	16.48
		RB6#0	16.07	16.07	16.02	15.37	15.37	15.32
3.0	QPSK	RB1#0	18.03	18.04	18.08	17.33	17.34	17.38
		RB1#8	18.00	17.99	18.04	17.30	17.29	17.34
		RB1#14	17.98	17.98	18.10	17.28	17.28	17.40
		RB6#0	16.97	16.95	17.02	16.27	16.25	16.32
		RB6#9	17.01	16.96	17.03	16.31	16.26	16.33
		RB15#0	17.05	16.98	17.08	16.35	16.28	16.38
	16QAM	RB1#0	17.75	17.20	17.14	17.05	16.50	16.44
		RB1#8	17.63	17.11	17.01	16.93	16.41	16.31
		RB1#14	17.63	17.19	17.08	16.93	16.49	16.38
		RB6#0	16.08	16.01	16.01	15.38	15.31	15.31
		RB6#9	16.09	16.00	15.98	15.39	15.30	15.28
		RB15#0	16.12	15.94	16.13	15.42	15.24	15.43

Bandwidth (MHz)	Modulation	RB size/ RB Offset	Conducted Average Output Power (dBm)			EIRP(dBm)		
			Low	Mid	High	Low	Mid	High
5.0	QPSK	RB1#0	18.07	17.99	18.04	17.37	17.29	17.34
		RB1#13	18.09	18.04	18.11	17.39	17.34	17.41
		RB1#24	18.05	18.04	18.04	17.35	17.34	17.34
		RB15#0	17.05	17.04	17.15	16.35	16.34	16.45
		RB15#10	17.02	16.97	16.96	16.32	16.27	16.26
		RB25#0	17.03	17.00	17.06	16.33	16.30	16.36
	16QAM	RB1#0	17.01	17.32	17.16	16.31	16.62	16.46
		RB1#13	16.98	17.33	17.18	16.28	16.63	16.48
		RB1#24	16.97	17.30	17.18	16.27	16.60	16.48
		RB15#0	16.12	16.03	16.22	15.42	15.33	15.52
		RB15#10	16.13	15.96	16.02	15.43	15.26	15.32
		RB25#0	16.10	15.99	16.11	15.40	15.29	15.41
10.0	QPSK	RB1#0	18.08	18.04	18.04	17.38	17.34	17.34
		RB1#25	18.14	18.15	18.23	17.44	17.45	<b>17.53</b>
		RB1#49	18.02	18.01	18.17	17.32	17.31	17.47
		RB25#0	17.07	17.05	17.05	16.37	16.35	16.35
		RB25#25	17.08	16.93	16.90	16.38	16.23	16.20
		RB50#0	17.08	17.03	17.00	16.38	16.33	16.30
	16QAM	RB1#0	17.68	17.13	17.01	16.98	16.43	16.31
		RB1#25	17.83	17.28	17.14	17.13	16.58	16.44
		RB1#49	17.65	17.16	17.06	16.95	16.46	16.36
		RB25#0	16.14	16.10	16.16	15.44	15.40	15.46
		RB25#25	16.16	15.95	15.98	15.46	15.25	15.28
		RB50#0	16.12	16.00	16.01	15.42	15.30	15.31

Bandwidth (MHz)	Modulation	RB size/ RB Offset	Conducted Average Output Power (dBm)			EIRP(dBm)		
			Low	Mid	High	Low	Mid	High
15.0	QPSK	RB1#0	18.01	18.02	17.95	17.31	17.32	17.25
		RB1#38	17.98	17.98	18.02	17.28	17.28	17.32
		RB1#74	17.98	17.97	18.16	17.28	17.27	17.46
		RB36#0	17.04	17.08	17.03	16.34	16.38	16.33
		RB36#39	17.04	16.94	17.01	16.34	16.24	16.31
		RB75#0	17.05	17.03	16.96	16.35	16.33	16.26
	16QAM	RB1#0	17.64	17.15	17.37	16.94	16.45	16.67
		RB1#38	17.64	17.16	17.47	16.94	16.46	16.77
		RB1#74	17.64	17.12	17.48	16.94	16.42	16.78
		RB36#0	16.04	16.10	16.00	15.34	15.40	15.30
		RB36#39	16.07	15.97	15.97	15.37	15.27	15.27
		RB75#0	16.08	16.04	15.97	15.38	15.34	15.27
20.0	QPSK	RB1#0	17.99	17.97	17.83	17.29	17.27	17.13
		RB1#50	18.17	18.14	18.09	17.47	17.44	17.39
		RB1#99	17.93	17.91	17.91	17.23	17.21	17.21
		RB50#0	17.06	17.21	16.97	16.36	16.51	16.27
		RB50#50	17.01	16.93	16.92	16.31	16.23	16.22
		RB100#0	17.05	17.07	16.96	16.35	16.37	16.26
	16QAM	RB1#0	17.29	17.19	17.45	16.59	16.49	16.75
		RB1#50	17.48	17.39	17.73	16.78	16.69	17.03
		RB1#99	17.25	17.13	17.55	16.55	16.43	16.85
		RB50#0	16.06	16.18	16.01	15.36	15.48	15.31
		RB50#50	16.03	15.94	15.93	15.33	15.24	15.23
		RB100#0	16.12	16.10	15.94	15.42	15.40	15.24

Note: EIRP(dBm) = Conducted Power(dBm) + Antenna Gain(dBi)  
 For LTE Band2: Antenna Gain = -0.7dBi  
 The Limit: EIRP ≤ 33dBm

**Peak-to-average ratio (PAR)****20MHz Bandwidth**

<b>Modulation</b>	<b>Low channel (dB)</b>	<b>Middle channel (dB)</b>	<b>High channel (dB)</b>	<b>PAR Limit (dB)</b>	<b>Result</b>
QPSK (1RB Size)	5.54	5.77	5.74	13	Pass
QPSK (100RB Size)	5.74	5.77	5.61	13	Pass
16QAM (1RB Size)	6.19	6.63	7.08	13	Pass
16QAM (100RB Size)	6.63	6.44	6.54	13	Pass

**LTE Band 4**

**Maximum Output Power**

Bandwidth (MHz)	Modulation	RB size/ RB Offset	Conducted Average Output Power (dBm)			EIRP(dBm)		
			Low	Mid	High	Low	Mid	High
1.4	QPSK	RB1#0	16.79	16.81	16.68	16.09	16.11	15.98
		RB1#3	16.95	16.86	16.83	16.25	16.16	16.13
		RB1#5	16.76	16.79	16.69	16.06	16.09	15.99
		RB3#0	16.93	16.90	16.82	16.23	16.20	16.12
		RB3#3	16.90	16.88	16.83	16.20	16.18	16.13
		RB6#0	15.83	15.85	15.81	15.13	15.15	15.11
	16QAM	RB1#0	15.89	15.99	15.79	15.19	15.29	15.09
		RB1#3	16.00	16.05	15.91	15.30	15.35	15.21
		RB1#5	15.89	16.00	15.77	15.19	15.30	15.07
		RB3#0	16.13	15.90	15.93	15.43	15.20	15.23
		RB3#3	16.12	15.99	15.91	15.42	15.29	15.21
		RB6#0	14.89	14.89	14.72	14.19	14.19	14.02
3.0	QPSK	RB1#0	16.86	16.84	16.76	16.16	16.14	16.06
		RB1#8	16.74	16.84	16.70	16.04	16.14	16.00
		RB1#14	16.79	16.84	16.71	16.09	16.14	16.01
		RB6#0	15.80	15.82	15.67	15.10	15.12	14.97
		RB6#9	15.84	15.76	15.72	15.14	15.06	15.02
		RB15#0	15.87	15.85	15.75	15.17	15.15	15.05
	16QAM	RB1#0	16.58	16.08	15.84	15.88	15.38	15.14
		RB1#8	16.51	16.00	15.79	15.81	15.30	15.09
		RB1#14	16.49	16.05	15.77	15.79	15.35	15.07
		RB6#0	14.85	14.83	14.72	14.15	14.13	14.02
		RB6#9	14.88	14.88	14.70	14.18	14.18	14.00
		RB15#0	14.95	14.87	14.82	14.25	14.17	14.12

Bandwidth (MHz)	Modulation	RB size/ RB Offset	Conducted Average Output Power (dBm)			EIRP(dBm)		
			Low	Mid	High	Low	Mid	High
5.0	QPSK	RB1#0	16.83	17.11	16.96	16.13	16.41	16.26
		RB1#13	16.87	17.12	16.94	16.17	16.42	16.24
		RB1#24	16.84	17.03	16.98	16.14	16.33	16.28
		RB15#0	15.87	16.09	15.96	15.17	15.39	15.26
		RB15#10	15.85	16.10	16.03	15.15	15.40	15.33
		RB25#0	15.83	16.08	16.00	15.13	15.38	15.30
	16QAM	RB1#0	15.84	16.39	16.02	15.14	15.69	15.32
		RB1#13	15.81	16.34	16.03	15.11	15.64	15.33
		RB1#24	15.81	16.33	16.00	15.11	15.63	15.30
		RB15#0	14.94	15.06	14.96	14.24	14.36	14.26
		RB15#10	14.90	15.09	15.03	14.20	14.39	14.33
		RB25#0	14.93	15.11	15.06	14.23	14.41	14.36
10.0	QPSK	RB1#0	17.06	17.10	16.95	16.36	16.40	16.25
		RB1#25	16.90	17.10	16.92	16.20	16.40	16.22
		RB1#49	16.58	17.03	16.96	15.88	16.33	16.26
		RB25#0	15.61	16.08	15.96	14.91	15.38	15.26
		RB25#25	15.77	16.10	16.03	15.07	15.40	15.33
		RB50#0	15.77	16.09	15.99	15.07	15.39	15.29
	16QAM	RB1#0	15.41	16.37	16.01	14.71	15.67	15.31
		RB1#25	15.55	16.34	16.01	14.85	15.64	15.31
		RB1#49	15.46	16.33	16.01	14.76	15.63	15.31
		RB25#0	14.90	15.06	14.97	14.20	14.36	14.27
		RB25#25	15.16	15.09	15.03	14.46	14.39	14.33
		RB50#0	15.16	15.11	15.05	14.46	14.41	14.35



Bandwidth (MHz)	Modulation	RB size/ RB Offset	Conducted Average Output Power (dBm)			EIRP(dBm)		
			Low	Mid	High	Low	Mid	High
15.0	QPSK	RB1#0	17.02	17.14	17.05	16.32	<b>16.44</b>	16.35
		RB1#38	16.67	16.98	17.01	15.97	16.28	16.31
		RB1#74	16.82	16.97	16.96	16.12	16.27	16.26
		RB36#0	15.91	16.17	16.11	15.21	15.47	15.41
		RB36#39	16.22	16.19	16.07	15.52	15.49	15.37
		RB75#0	16.19	16.19	16.12	15.49	15.49	15.42
	16QAM	RB1#0	16.08	16.23	16.37	15.38	15.53	15.67
		RB1#38	16.18	16.18	16.33	15.48	15.48	15.63
		RB1#74	16.48	16.16	16.25	15.78	15.46	15.55
		RB36#0	15.04	15.17	15.05	14.34	14.47	14.35
		RB36#39	15.22	15.19	14.99	14.52	14.49	14.29
		RB75#0	15.20	15.14	15.08	14.50	14.44	14.38
20.0	QPSK	RB1#0	16.92	16.47	16.56	16.22	15.77	15.86
		RB1#50	17.03	16.75	16.77	16.33	16.05	16.07
		RB1#99	16.50	16.52	16.32	15.80	15.82	15.62
		RB50#0	15.50	15.77	15.84	14.80	15.07	15.14
		RB50#50	15.70	15.63	15.90	15.00	14.93	15.20
		RB100#0	15.62	15.79	15.91	14.92	15.09	15.21
	16QAM	RB1#0	15.74	15.71	16.12	15.04	15.01	15.42
		RB1#50	16.03	15.98	16.43	15.33	15.28	15.73
		RB1#99	15.82	15.79	16.07	15.12	15.09	15.37
		RB50#0	14.55	15.00	15.11	13.85	14.30	14.41
		RB50#50	14.90	15.14	15.05	14.20	14.44	14.35
		RB100#0	14.74	15.14	15.11	14.04	14.44	14.41

Note: EIRP(dBm) = Conducted Power(dBm) + Antenna Gain(dBi)  
 For LTE Band 4: Antenna Gain = -0.7dBi  
 The Limit: EIRP ≤ 30dBm

**Peak-to-average ratio (PAR)**

**20MHz Bandwidth**

<b>Modulation</b>	<b>Low channel (dB)</b>	<b>Middle channel (dB)</b>	<b>High channel (dB)</b>	<b>PAR Limit (dB)</b>	<b>Result</b>
QPSK (1RB Size)	5.83	5.77	5.87	13	Pass
QPSK (100RB Size)	5.67	5.80	5.83	13	Pass
16QAM (1RB Size)	7.50	6.47	7.47	13	Pass
16QAM (100RB Size)	6.54	6.70	6.63	13	Pass

**LTE Band 5:**

**Maximum Output Power**

Bandwidth (MHz)	Modulation	RB size/ RB Offset	Conducted Average Output Power (dBm)			ERP(dBm)		
			Low	Mid	High	Low	Mid	High
1.4	QPSK	RB1#0	23.39	23.43	23.32	19.64	19.68	19.57
		RB1#3	23.53	23.56	23.57	19.78	19.81	19.82
		RB1#5	23.40	23.45	23.37	19.65	19.70	19.62
		RB3#0	23.48	23.50	23.47	19.73	19.75	19.72
		RB3#3	23.43	23.47	23.46	19.68	19.72	19.71
		RB6#0	22.51	22.50	22.49	18.76	18.75	18.74
	16QAM	RB1#0	22.39	22.56	22.40	18.64	18.81	18.65
		RB1#3	22.54	22.73	22.57	18.79	18.98	18.82
		RB1#5	22.44	22.55	22.45	18.69	18.80	18.70
		RB3#0	22.62	22.43	22.56	18.87	18.68	18.81
		RB3#3	22.64	22.47	22.51	18.89	18.72	18.76
		RB6#0	21.48	21.51	21.42	17.73	17.76	17.67
3.0	QPSK	RB1#0	23.45	23.51	23.47	19.70	19.76	19.72
		RB1#8	23.41	23.48	23.40	19.66	19.73	19.65
		RB1#14	23.41	23.47	23.45	19.66	19.72	19.70
		RB6#0	22.42	22.42	22.41	18.67	18.67	18.66
		RB6#9	22.49	22.44	22.39	18.74	18.69	18.64
		RB15#0	22.47	22.47	22.48	18.72	18.72	18.73
	16QAM	RB1#0	23.01	22.64	22.50	19.26	18.89	18.75
		RB1#8	22.95	22.61	22.44	19.20	18.86	18.69
		RB1#14	22.96	22.61	22.47	19.21	18.86	18.72
		RB6#0	21.51	21.46	21.40	17.76	17.71	17.65
		RB6#9	21.52	21.53	21.38	17.77	17.78	17.63
		RB15#0	21.53	21.47	21.51	17.78	17.72	17.76

Bandwidth (MHz)	Modulation	RB size/ RB Offset	Conducted Average Output Power (dBm)			ERP(dBm)		
			Low	Mid	High	Low	Mid	High
5.0	QPSK	RB1#0	23.43	23.50	23.40	19.68	19.75	19.65
		RB1#13	23.47	23.50	23.43	19.72	19.75	19.68
		RB1#24	23.47	23.48	23.44	19.72	19.73	19.69
		RB15#0	22.51	22.48	22.57	18.76	18.73	18.82
		RB15#10	22.49	22.53	22.48	18.74	18.78	18.73
		RB25#0	22.48	22.51	22.51	18.73	18.76	18.76
	16QAM	RB1#0	22.36	22.78	22.53	18.61	19.03	18.78
		RB1#13	22.40	22.79	22.53	18.65	19.04	18.78
		RB1#24	22.38	22.75	22.55	18.63	19.00	18.80
		RB15#0	21.54	21.46	21.59	17.79	17.71	17.84
		RB15#10	21.53	21.50	21.51	17.78	17.75	17.76
		RB25#0	21.54	21.54	21.55	17.79	17.79	17.80
10.0	QPSK	RB1#0	23.49	23.51	23.48	19.74	19.76	19.73
		RB1#25	23.60	23.59	23.57	<b>19.85</b>	19.84	19.82
		RB1#49	23.49	23.49	23.47	19.74	19.74	19.72
		RB25#0	22.54	22.52	22.63	18.79	18.77	18.88
		RB25#25	22.60	22.52	22.40	18.85	18.77	18.65
		RB50#0	22.55	22.58	22.55	18.80	18.83	18.80
	16QAM	RB1#0	22.99	22.68	22.46	19.24	18.93	18.71
		RB1#25	23.12	22.76	22.57	19.37	19.01	18.82
		RB1#49	23.10	22.63	22.49	19.35	18.88	18.74
		RB25#0	21.62	21.60	21.70	17.87	17.85	17.95
		RB25#25	21.64	21.55	21.53	17.89	17.80	17.78
		RB50#0	21.61	21.58	21.54	17.86	17.83	17.79

Note: ERP(dBm) = Conducted Power(dBm) + Antenna Gain(dBd)  
 For LTE Band 5: Antenna Gain = -1.6dBi = -3.75dBd (0dBd=2.15dBi)  
 Limit: ERP ≤ 38.45dBm

**Peak-to-average ratio (PAR)****10MHz bandwidth**

<b>Modulation</b>	<b>Low channel (dB)</b>	<b>Middle channel (dB)</b>	<b>High channel (dB)</b>	<b>PAR Limit (dB)</b>	<b>Result</b>
QPSK (1RB Size)	5.10	5.22	4.46	13	Pass
QPSK (50RB Size)	5.71	5.51	5.54	13	Pass
16QAM (1RB Size)	5.99	6.51	5.35	13	Pass
16QAM (50RB Size)	6.38	6.35	6.44	13	Pass

**LTE Band 7:**

**Maximum Output Power**

Bandwidth (MHz)	Modulation	RB size/ RB Offset	Conducted Average Output Power (dBm)			EIRP(dBm)		
			Low	Mid	High	Low	Mid	High
5.0	QPSK	RB1#0	16.95	16.71	16.36	16.55	16.31	15.96
		RB1#13	16.87	16.64	16.35	16.47	16.24	15.95
		RB1#24	16.87	16.63	16.35	16.47	16.23	15.95
		RB15#0	15.93	15.72	15.38	15.53	15.32	14.98
		RB15#10	15.95	15.69	15.39	15.55	15.29	14.99
		RB25#0	15.90	15.68	15.38	15.50	15.28	14.98
	16QAM	RB1#0	16.27	15.91	15.33	15.87	15.51	14.93
		RB1#13	16.27	15.76	15.31	15.87	15.36	14.91
		RB1#24	16.21	15.84	15.32	15.81	15.44	14.92
		RB15#0	14.88	14.74	14.45	14.48	14.34	14.05
		RB15#10	14.91	14.73	14.41	14.51	14.33	14.01
		RB25#0	14.93	14.71	14.42	14.53	14.31	14.02
10.0	QPSK	RB1#0	16.89	16.77	16.41	16.49	16.37	16.01
		RB1#25	16.98	16.78	16.45	<b>16.58</b>	16.38	16.05
		RB1#49	16.81	16.67	16.32	16.41	16.27	15.92
		RB25#0	15.92	15.75	15.41	15.52	15.35	15.01
		RB25#25	15.97	15.74	15.44	15.57	15.34	15.04
		RB50#0	15.99	15.71	15.43	15.59	15.31	15.03
	16QAM	RB1#0	16.61	15.96	15.51	16.21	15.56	15.11
		RB1#25	16.66	16.01	15.54	16.26	15.61	15.14
		RB1#49	16.53	15.86	15.43	16.13	15.46	15.03
		RB25#0	15.01	14.76	14.55	14.61	14.36	14.15
		RB25#25	15.05	14.70	14.57	14.65	14.30	14.17
		RB50#0	15.02	14.69	14.50	14.62	14.29	14.10

Bandwidth (MHz)	Modulation	RB size/ RB Offset	Conducted Average Output Power (dBm)			EIRP(dBm)		
			Low	Mid	High	Low	Mid	High
15.0	QPSK	RB1#0	16.83	16.73	16.45	16.43	16.33	16.05
		RB1#38	16.77	16.64	16.35	16.37	16.24	15.95
		RB1#74	16.70	16.57	16.28	16.30	16.17	15.88
		RB36#0	15.91	15.80	15.47	15.51	15.40	15.07
		RB36#39	15.92	15.69	15.49	15.52	15.29	15.09
		RB75#0	15.87	15.72	15.43	15.47	15.32	15.03
	16QAM	RB1#0	16.60	15.92	15.94	16.20	15.52	15.54
		RB1#38	16.48	15.83	15.82	16.08	15.43	15.42
		RB1#74	16.43	15.77	15.73	16.03	15.37	15.33
		RB36#0	14.89	14.77	14.44	14.49	14.37	14.04
		RB36#39	14.90	14.67	14.42	14.50	14.27	14.02
		RB75#0	14.90	14.70	14.42	14.50	14.30	14.02
20.0	QPSK	RB1#0	16.80	16.68	16.38	16.40	16.28	15.98
		RB1#50	16.88	16.85	16.47	16.48	16.45	16.07
		RB1#99	16.64	16.53	16.19	16.24	16.13	15.79
		RB50#0	15.85	15.84	15.44	15.45	15.44	15.04
		RB50#50	15.92	15.64	15.48	15.52	15.24	15.08
		RB100#0	15.92	15.76	15.46	15.52	15.36	15.06
	16QAM	RB1#0	16.16	15.95	16.06	15.76	15.55	15.66
		RB1#50	16.33	16.16	16.10	15.93	15.76	15.70
		RB1#99	16.02	15.83	15.83	15.62	15.43	15.43
		RB50#0	14.82	14.81	14.49	14.42	14.41	14.09
		RB50#50	14.92	14.65	14.54	14.52	14.25	14.14
		RB100#0	14.95	14.74	14.49	14.55	14.34	14.09

Note: ERP(dBm) = Conducted Power(dBm) + Antenna Gain(dBi)  
 For LTE Band7: Antenna Gain = -0.4dBi  
 Limit: EIRP ≤ 33dBm

**Peak-to-average ratio (PAR)****20MHz bandwidth**

<b>Modulation</b>	<b>Low channel (dB)</b>	<b>Middle channel (dB)</b>	<b>High channel (dB)</b>	<b>PAR Limit (dB)</b>	<b>Result</b>
QPSK (1RB Size)	3.91	4.20	4.52	13	Pass
QPSK (100RB Size)	5.35	5.42	5.45	13	Pass
16QAM (1RB Size)	4.74	4.84	5.61	13	Pass
16QAM (100RB Size)	6.25	6.19	6.38	13	Pass



**LTE Band 17:**

**Maximum Output Power**

Bandwidth (MHz)	Modulation	RB size/ RB Offset	Conducted Average Output Power (dBm)			ERP(dBm)		
			Low	Mid	High	Low	Mid	High
5.0	QPSK	RB1#0	23.32	23.54	23.47	19.27	19.49	19.42
		RB1#13	23.52	23.47	23.44	19.47	19.42	19.39
		RB1#24	23.35	23.52	23.45	19.30	19.47	19.40
		RB15#0	22.56	22.47	22.53	18.51	18.42	18.48
		RB15#10	22.55	22.53	22.45	18.50	18.48	18.40
		RB25#0	22.50	22.54	22.46	18.45	18.49	18.41
	16QAM	RB1#0	22.38	22.82	22.55	18.33	18.77	18.50
		RB1#13	22.39	22.78	22.54	18.34	18.73	18.49
		RB1#24	22.45	22.84	22.58	18.40	18.79	18.53
		RB15#0	21.58	21.50	21.60	17.53	17.45	17.55
		RB15#10	21.57	21.53	21.51	17.52	17.48	17.46
		RB25#0	21.58	21.52	21.55	17.53	17.47	17.50
10.0	QPSK	RB1#0	23.45	23.47	23.52	19.40	19.42	19.47
		RB1#25	23.65	23.66	23.56	19.60	<b>19.61</b>	19.51
		RB1#49	23.47	23.48	23.51	19.42	19.43	19.46
		RB25#0	22.55	22.51	22.49	18.50	18.46	18.44
		RB25#25	22.61	22.56	22.50	18.56	18.51	18.45
		RB50#0	22.60	22.54	22.49	18.55	18.49	18.44
	16QAM	RB1#0	23.03	22.66	22.56	18.98	18.61	18.51
		RB1#25	23.24	22.83	22.64	19.19	18.78	18.59
		RB1#49	23.11	22.67	22.52	19.06	18.62	18.47
		RB25#0	21.58	21.55	21.60	17.53	17.50	17.55
		RB25#25	21.67	21.58	21.56	17.62	17.53	17.51
		RB50#0	21.61	21.54	21.51	17.56	17.49	17.46

Note: ERP(dBm) = Conducted Power(dBm) + Antenna Gain(dBd)  
 For LTE Band17: Antenna Gain = -1.9dBi = -4.05dBd (0dBd=2.15dBi)  
 Limit: ERP ≤ 34.77dBm

**Peak-to-average ratio (PAR)****10MHz bandwidth**

<b>Modulation</b>	<b>Low channel (dB)</b>	<b>Middle channel (dB)</b>	<b>High channel (dB)</b>	<b>PAR Limit (dB)</b>	<b>Result</b>
QPSK (1RB Size)	5.42	5.61	5.51	13	Pass
QPSK (50RB Size)	5.80	5.67	5.64	13	Pass
16QAM (1RB Size)	6.19	6.19	6.89	13	Pass
16QAM (50RB Size)	6.60	6.60	6.57	13	Pass

**LTE Band 38:**

**Maximum Output Power**

Bandwidth (MHz)	Modulation	RB size/ RB Offset	Conducted Average Output Power (dBm)			EIRP(dBm)		
			Low	Mid	High	Low	Mid	High
5.0	QPSK	RB1#0	16.97	16.70	16.55	16.27	16.00	15.85
		RB1#13	16.88	16.65	16.49	16.18	15.95	15.79
		RB1#24	16.88	16.66	16.51	16.18	15.96	15.81
		RB15#0	15.90	15.60	15.43	15.20	14.90	14.73
		RB15#10	15.82	15.60	15.47	15.12	14.90	14.77
		RB25#0	15.90	15.62	15.46	15.20	14.92	14.76
	16QAM	RB1#0	16.03	15.96	15.54	15.33	15.26	14.84
		RB1#13	15.94	15.89	15.50	15.24	15.19	14.80
		RB1#24	15.95	15.90	15.49	15.25	15.20	14.79
		RB15#0	14.99	14.76	14.45	14.29	14.06	13.75
		RB15#10	14.96	14.73	14.46	14.26	14.03	13.76
		RB25#0	15.02	14.72	14.52	14.32	14.02	13.82
10.0	QPSK	RB1#0	16.97	16.76	16.57	16.27	16.06	15.87
		RB1#25	17.14	16.94	16.82	<b>16.44</b>	16.24	16.12
		RB1#49	16.84	16.65	16.53	16.14	15.95	15.83
		RB25#0	15.96	15.71	15.52	15.26	15.01	14.82
		RB25#25	15.85	15.63	15.53	15.15	14.93	14.83
		RB50#0	15.90	15.69	15.53	15.20	14.99	14.83
	16QAM	RB1#0	16.22	15.68	15.65	15.52	14.98	14.95
		RB1#25	16.35	15.87	15.92	15.65	15.17	15.22
		RB1#49	16.07	15.57	15.61	15.37	14.87	14.91
		RB25#0	15.02	14.84	14.61	14.32	14.14	13.91
		RB25#25	14.94	14.76	14.62	14.24	14.06	13.92
		RB50#0	15.00	14.77	14.60	14.30	14.07	13.90

Bandwidth (MHz)	Modulation	RB size/ RB Offset	Conducted Average Output Power (dBm)			EIRP(dBm)		
			Low	Mid	High	Low	Mid	High
15.0	QP SK	RB1#0	16.98	16.77	16.58	16.28	16.07	15.88
		RB1#38	16.84	16.70	16.55	16.14	16.00	15.85
		RB1#74	16.74	16.61	16.47	16.04	15.91	15.77
		RB36#0	15.92	15.72	15.56	15.22	15.02	14.86
		RB36#39	15.81	15.61	15.56	15.11	14.91	14.86
		RB75#0	15.86	15.66	15.56	15.16	14.96	14.86
	16QAM	RB1#0	16.22	15.71	15.80	15.52	15.01	15.10
		RB1#38	16.09	15.56	15.77	15.39	14.86	15.07
		RB1#74	15.96	15.54	15.71	15.26	14.84	15.01
		RB36#0	14.95	14.76	14.66	14.25	14.06	13.96
		RB36#39	14.84	14.62	14.66	14.14	13.92	13.96
		RB75#0	14.91	14.74	14.62	14.21	14.04	13.92
20.0	QPSK	RB1#0	16.86	16.64	16.56	16.16	15.94	15.86
		RB1#50	17.03	16.88	16.90	16.33	16.18	16.20
		RB1#99	16.62	16.48	16.48	15.92	15.78	15.78
		RB50#0	15.91	15.75	15.53	15.21	15.05	14.83
		RB50#50	15.74	15.59	15.53	15.04	14.89	14.83
		RB100#0	15.81	15.67	15.57	15.11	14.97	14.87
	16QAM	RB1#0	15.96	15.63	15.79	15.26	14.93	15.09
		RB1#50	16.12	15.87	16.06	15.42	15.17	15.36
		RB1#99	15.74	15.49	15.70	15.04	14.79	15.00
		RB50#0	14.97	14.90	14.62	14.27	14.20	13.92
		RB50#50	14.79	14.73	14.63	14.09	14.03	13.93
		RB100#0	14.87	14.79	14.62	14.17	14.09	13.92

Note: ERP(dBm) = Conducted Power(dBm) + Antenna Gain(dBi)  
 For LTE Band38: Antenna Gain = -0.7dBi  
 Limit: EIRP ≤ 33dBm

**Peak-to-average ratio (PAR)****20MHz bandwidth**

<b>Modulation</b>	<b>Low channel (dB)</b>	<b>Middle channel (dB)</b>	<b>High channel (dB)</b>	<b>PAR Limit (dB)</b>	<b>Result</b>
QPSK (1RB Size)	4.56	5.12	5.23	13	Pass
QPSK (100RB Size)	5.08	5.11	5.18	13	Pass
16QAM (1RB Size)	6.12	6.21	6.54	13	Pass
16QAM (100RB Size)	6.25	6.43	6.69	13	Pass

**LTE Band 41:**

**Maximum Output Power**

Bandwidth (MHz)	Modulation	RB size/ RB Offset	Conducted Average Output Power (dBm)			EIRP(dBm)		
			Low	Mid	High	Low	Mid	High
5.0	QPSK	RB1#0	17.49	16.86	16.53	16.79	16.16	15.83
		RB1#13	17.46	16.88	16.50	16.76	16.18	15.80
		RB1#24	17.44	16.80	16.48	16.74	16.10	15.78
		RB15#0	16.40	15.80	15.50	15.70	15.10	14.80
		RB15#10	16.41	15.76	15.40	15.71	15.06	14.70
		RB25#0	16.43	15.81	15.46	15.73	15.11	14.76
	16QAM	RB1#0	16.50	15.91	15.78	15.80	15.21	15.08
		RB1#13	16.46	15.89	15.73	15.76	15.19	15.03
		RB1#24	16.46	15.90	15.73	15.76	15.20	15.03
		RB15#0	15.40	14.91	14.60	14.70	14.21	13.90
		RB15#10	15.43	14.86	14.49	14.73	14.16	13.79
		RB25#0	15.52	14.90	14.50	14.82	14.20	13.80
10.0	QPSK	RB1#0	17.50	16.93	16.56	16.80	16.23	15.86
		RB1#25	17.70	17.12	16.79	<b>17.00</b>	16.42	16.09
		RB1#49	17.45	16.81	16.51	16.75	16.11	15.81
		RB25#0	16.44	15.89	15.60	15.74	15.19	14.90
		RB25#25	16.47	15.80	15.42	15.77	15.10	14.72
		RB50#0	16.47	15.83	15.50	15.77	15.13	14.80
	16QAM	RB1#0	16.74	15.86	15.64	16.04	15.16	14.94
		RB1#25	16.93	16.07	15.86	16.23	15.37	15.16
		RB1#49	16.68	15.76	15.61	15.98	15.06	14.91
		RB25#0	15.51	14.98	14.66	14.81	14.28	13.96
		RB25#25	15.53	14.88	14.50	14.83	14.18	13.80
		RB50#0	15.54	14.92	14.59	14.84	14.22	13.89

Bandwidth (MHz)	Modulation	RB size/ RB Offset	Conducted Average Output Power (dBm)			EIRP(dBm)		
			Low	Mid	High	Low	Mid	High
15.0	QPSK	RB1#0	17.49	16.91	16.59	16.79	16.21	15.89
		RB1#38	17.46	16.82	16.52	16.76	16.12	15.82
		RB1#74	17.35	16.78	16.46	16.65	16.08	15.76
		RB36#0	16.50	15.89	15.57	15.80	15.19	14.87
		RB36#39	16.49	15.80	15.47	15.79	15.10	14.77
		RB75#0	16.47	15.87	15.55	15.77	15.17	14.85
	16QAM	RB1#0	16.73	15.87	15.79	16.03	15.17	15.09
		RB1#38	16.68	15.73	15.74	15.98	15.03	15.04
		RB1#74	16.56	15.72	15.67	15.86	15.02	14.97
		RB36#0	15.49	14.89	14.67	14.79	14.19	13.97
		RB36#39	15.50	14.81	14.54	14.80	14.11	13.84
		RB75#0	15.46	14.91	14.56	14.76	14.21	13.86
20.0	QPSK	RB1#0	17.37	16.77	16.55	16.67	16.07	15.85
		RB1#50	17.65	17.04	16.85	16.95	16.34	16.15
		RB1#99	17.17	16.62	16.48	16.47	15.92	15.78
		RB50#0	16.37	15.87	15.52	15.67	15.17	14.82
		RB50#50	16.44	15.77	15.38	15.74	15.07	14.68
		RB100#0	16.41	15.86	15.45	15.71	15.16	14.75
	16QAM	RB1#0	16.47	15.77	15.73	15.77	15.07	15.03
		RB1#50	16.71	16.03	16.06	16.01	15.33	15.36
		RB1#99	16.26	15.62	15.69	15.56	14.92	14.99
		RB50#0	15.43	15.02	14.58	14.73	14.32	13.88
		RB50#50	15.52	14.88	14.44	14.82	14.18	13.74
		RB100#0	15.48	14.95	14.49	14.78	14.25	13.79

Note: ERP(dBm) = Conducted Power(dBm) + Antenna Gain(dBi)  
 For LTE Band 41: Antenna Gain = -0.7dBi  
 Limit: EIRP ≤ 33dBm

**Peak-to-average ratio (PAR)****20MHz bandwidth**

<b>Modulation</b>	<b>Low channel (dB)</b>	<b>Middle channel (dB)</b>	<b>High channel (dB)</b>	<b>PAR Limit (dB)</b>	<b>Result</b>
QPSK (1RB Size)	5.12	4.97	5.23	13	Pass
QPSK (100RB Size)	5.69	5.52	5.36	13	Pass
16QAM (1RB Size)	6.16	5.89	5.65	13	Pass
16QAM (100RB Size)	6.57	6.33	6.49	13	Pass



**FCC §2.1049, §22.917, §22.905 & §24.238 & §27.53 - OCCUPIED BANDWIDTH**

**Applicable Standard**

FCC 47 §2.1049, §22.917, §22.905, §24.238 and §27.53.

**Test Procedure**

The RF output of the transmitter was connected to the simulator and the spectrum analyzer through sufficient attenuation.

The resolution bandwidth of the spectrum analyzer was set at 1% to 5% of the anticipated emission bandwidth and the 26 dB & 99% bandwidth was recorded.

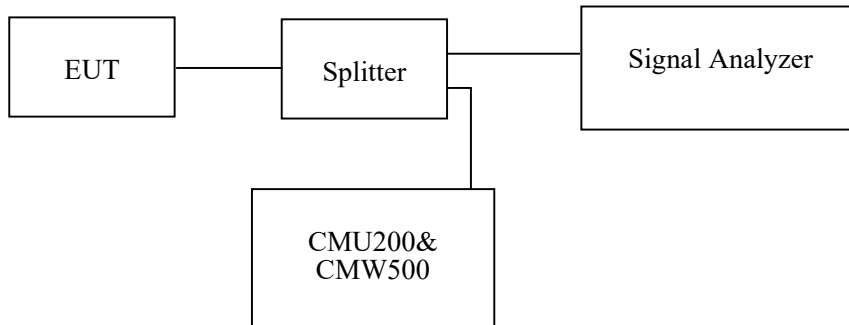

**Test Data**

**Environmental Conditions**

<b>Temperature:</b>	25~28.5 °C
<b>Relative Humidity:</b>	47 ~62 %
<b>ATM Pressure:</b>	101.0 kPa

*The testing was performed by Pedro Yun from 2021-06-08 to 2021-07-24.*

*EUT operation mode: Transmitting*

**Test Result: Pass**

*Please refer to the following tables and plots.*

**Cellular Band (Part 22H)**

Mode	Channel	Frequency (MHz)	99% Occupied Bandwidth (kHz)	26 dB Emission Bandwidth (kHz)
GSM(GMSK)	128	824.2	246.79	316.03
	190	836.6	243.59	311.22
	251	848.8	243.59	312.18
EGPRS(8PSK)	128	824.2	250.00	316.67
	190	836.6	246.79	319.23
	251	848.8	250.00	316.03

	Frequency (MHz)	Occupied Bandwidth (MHz)	26dB Bandwidth (MHz)
RMC	826.4	4.17	4.72
	836.6	4.17	4.72
	846.6	4.17	4.71
HSDPA	826.4	4.20	5.11
	836.6	4.23	5.31
	846.6	4.18	4.71
HSUPA	826.4	4.20	4.73
	836.6	4.20	4.73
	846.6	4.18	4.72

**PCS Band (Part 24E)**

Mode	Channel	Frequency (MHz)	99% Occupied Bandwidth (kHz)	26 dB Emission Bandwidth (kHz)
GSM(GMSK)	512	1850.2	243.59	318.59
	661	1880.0	243.59	321.47
	810	1909.8	245.19	316.67
EGPRS(8PSK)	512	1850.2	248.40	325.64
	661	1880.0	250.00	324.04
	810	1909.8	248.40	319.87

Frequency (MHz)		Occupied Bandwidth (MHz)	26dB Bandwidth (MHz)
RMC	1852.4	4.17	4.71
	1880.0	4.18	4.74
	1907.6	4.17	4.71
HSDPA	1852.4	4.18	4.72
	1880.0	4.20	4.73
	1907.6	4.18	4.71
HSUPA	1852.4	4.17	4.73
	1880.0	4.18	4.71
	1907.6	4.18	4.72

**AWS Band (Part 27)**

Frequency (MHz)		Occupied Bandwidth (MHz)	26dB Bandwidth (MHz)
RMC	1712.4	4.18	4.72
	1732.6	4.18	4.71
	1752.6	4.18	4.72
HSDPA	1712.4	4.18	4.72
	1732.6	4.18	4.71
	1752.6	4.20	4.71
HSUPA	1712.4	4.17	4.72
	1732.6	4.18	4.71
	1752.6	4.18	4.72

**Cellular Band (Part 22H)**

**26 dB Emissions & 99% Occupied Bandwidth for GSM (GMSK) Mode, Low channel**

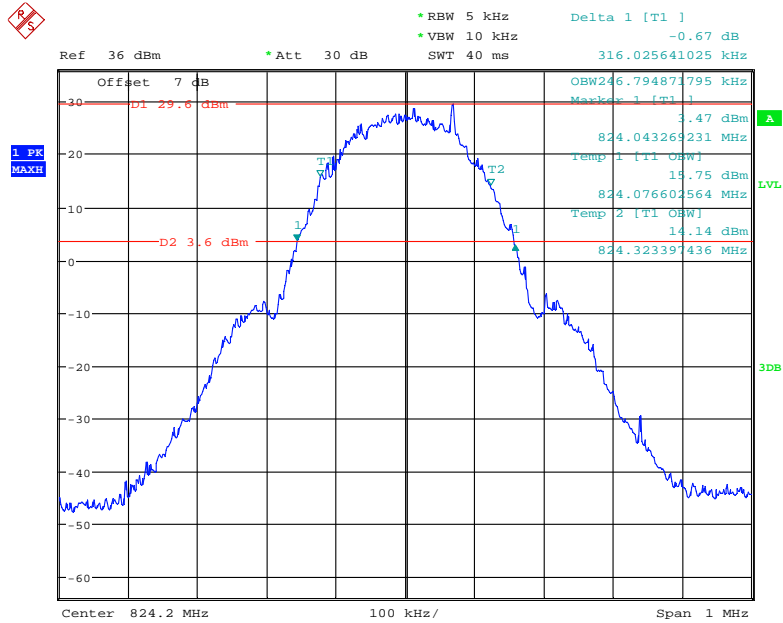

Date: 9.JUL.2021 23:57:02

**26 dB Emissions & 99% Occupied Bandwidth for GSM (GMSK) Mode, Middle channel**

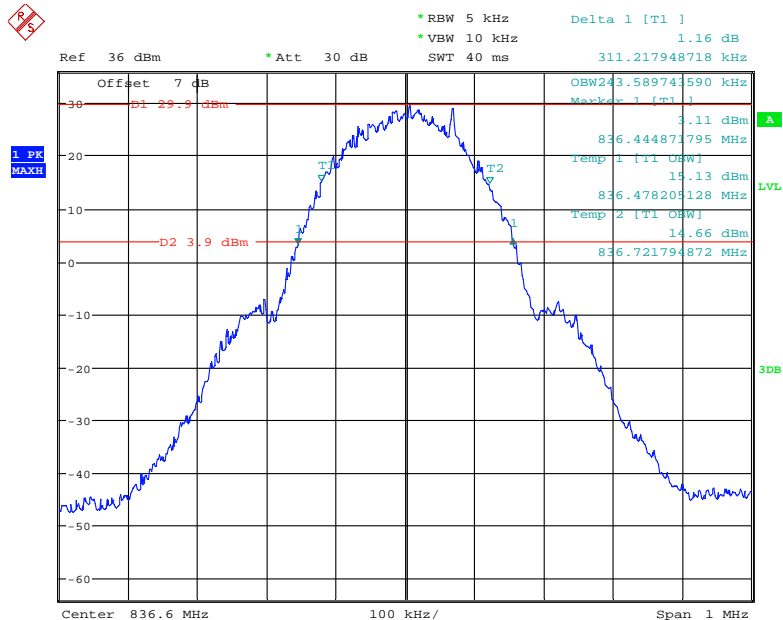

Date: 9.JUL.2021 23:59:43

26 dB Emissions & 99% Occupied Bandwidth for GSM (GMSK) Mode, High channel

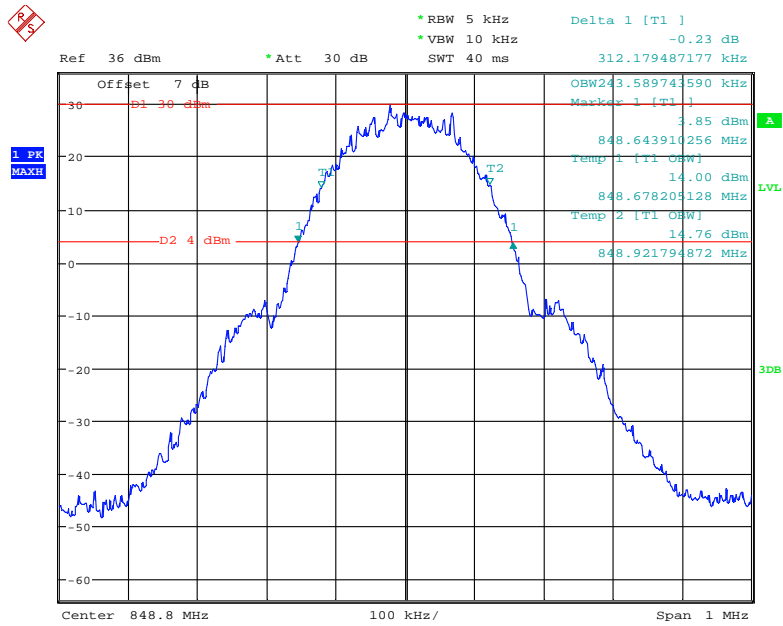

Date: 10.JUL.2021 00:01:15

26 dB Emissions & 99% Occupied Bandwidth for EGPRS (8PSK) Mode, Low channel

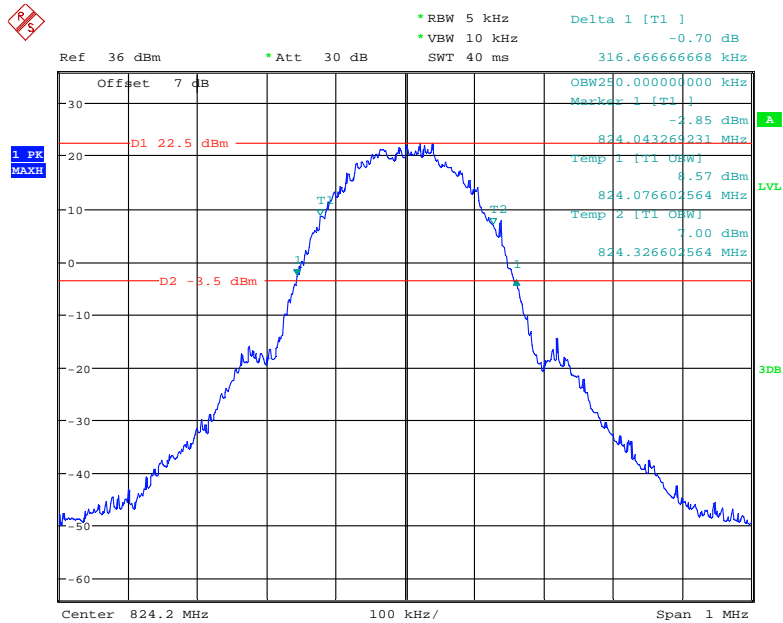

Date: 10.JUL.2021 00:05:20

**26 dB Emissions & 99% Occupied Bandwidth for EGPRS (8PSK) Mode, Middle channel**

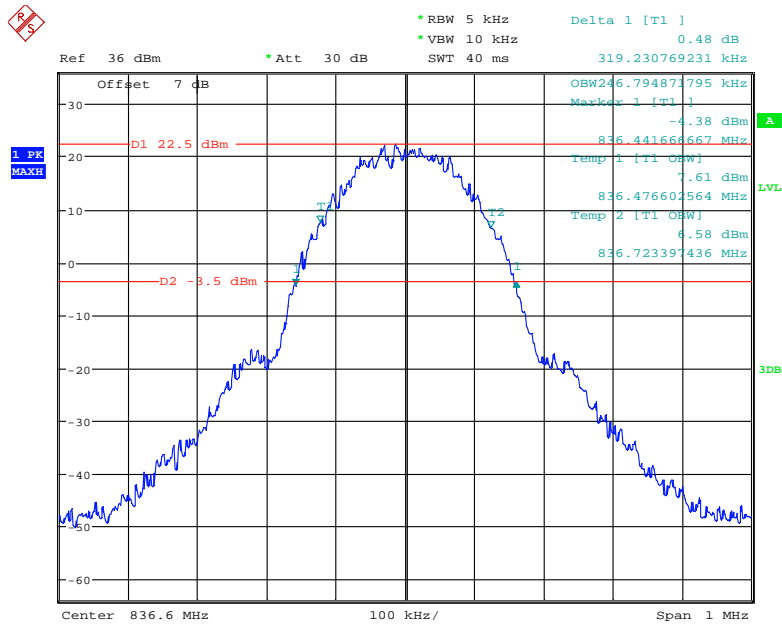

Date: 10.JUL.2021 00:06:43

**26 dB Emissions & 99% Occupied Bandwidth for EGPRS (8PSK) Mode, High channel**

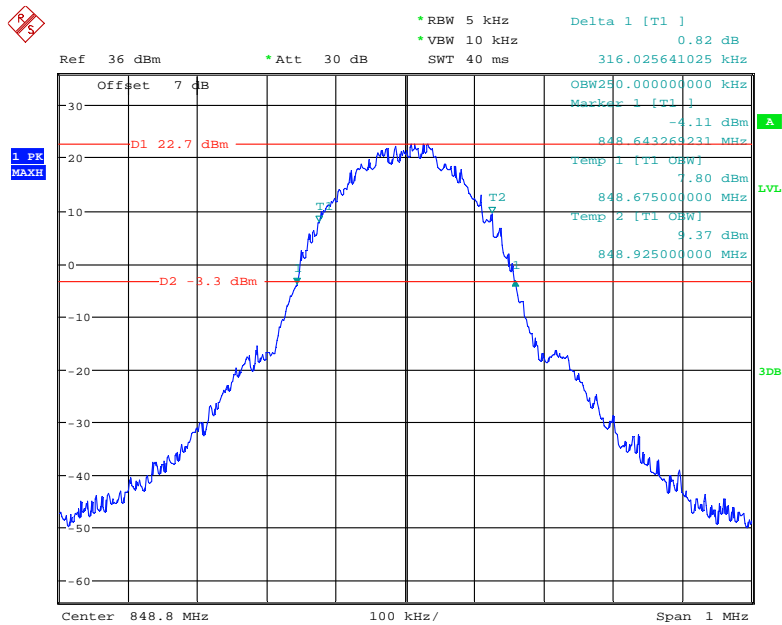

Date: 10.JUL.2021 00:33:57

26 dB Emissions & 99% Occupied Bandwidth for RMC (BPSK) Mode, Low channel

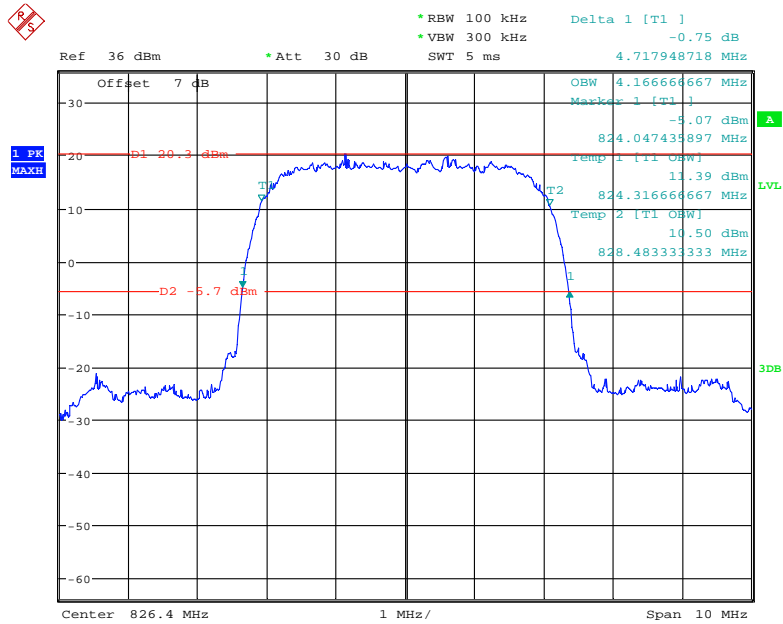

Date: 10.JUL.2021 01:35:14

26 dB Emissions & 99% Occupied Bandwidth for RMC (BPSK) Mode, Middle channel

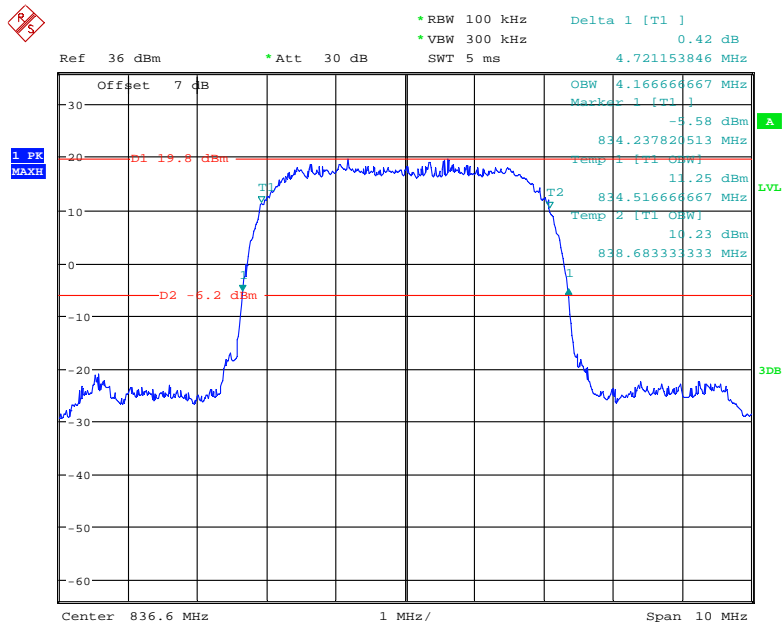

Date: 10.JUL.2021 01:36:19

**26 dB Emissions & 99% Occupied Bandwidth for RMC (BPSK) Mode, High channel**

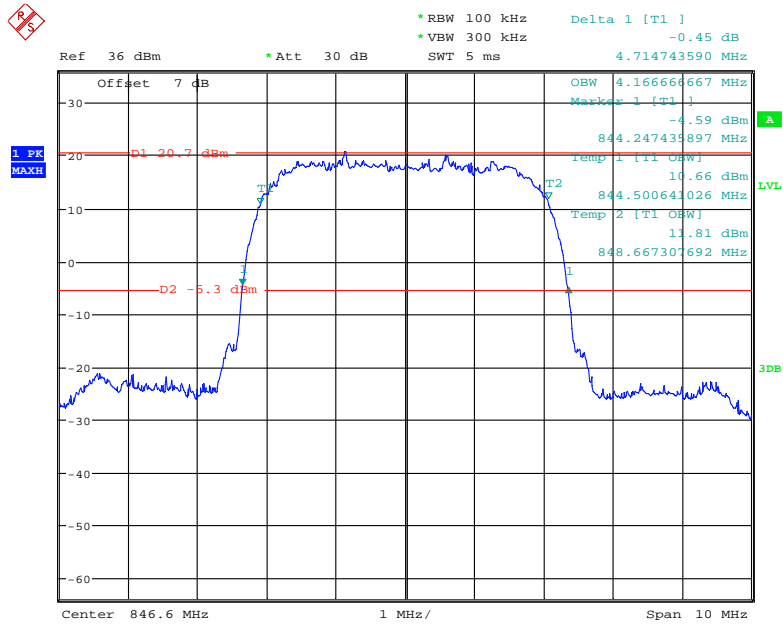

Date: 10.JUL.2021 01:37:42

**26 dB Emissions & 99% Occupied Bandwidth for HSUPA (BPSK) Mode, Low channel**

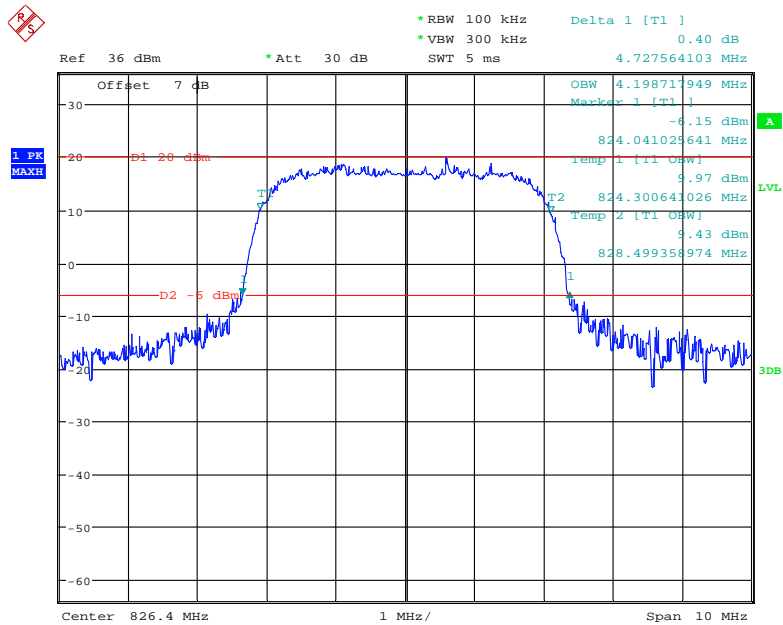

Date: 11.JUL.2021 16:00:50



**26 dB Emissions & 99% Occupied Bandwidth for HSUPA (BPSK) Mode, Middle channel**

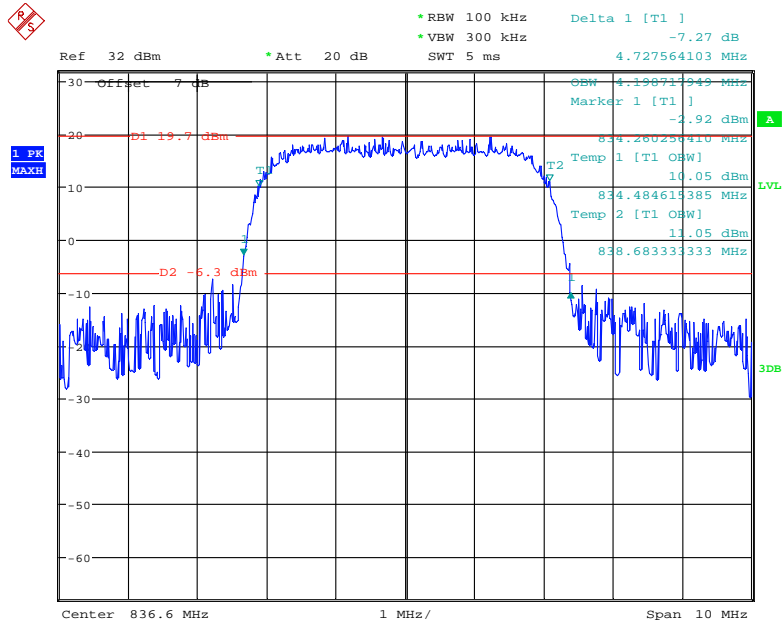

Date: 21.JUL.2021 18:22:09

**26 dB Emissions & 99% Occupied Bandwidth for HSUPA (BPSK) Mode, High channel**

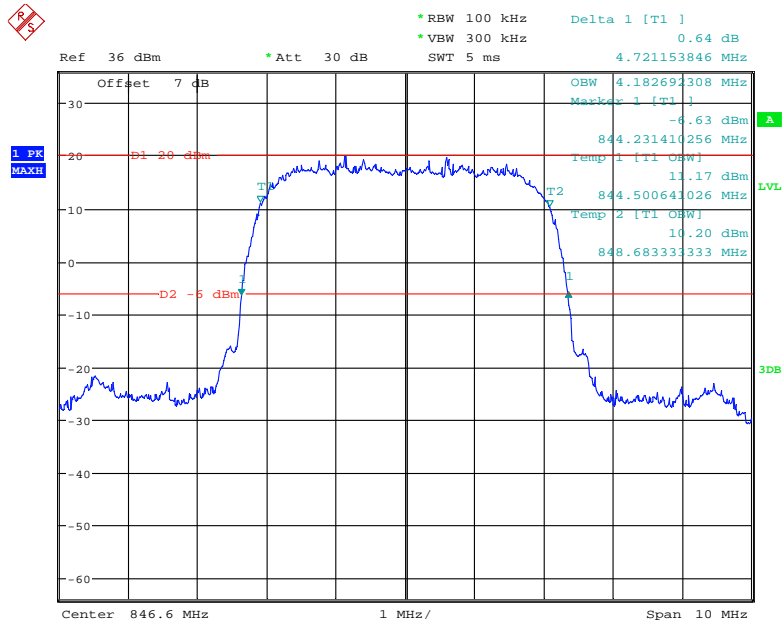

Date: 11.JUL.2021 16:05:46

**26 dB Emissions & 99% Occupied Bandwidth for HSDPA (16QAM) Mode, Low channel**

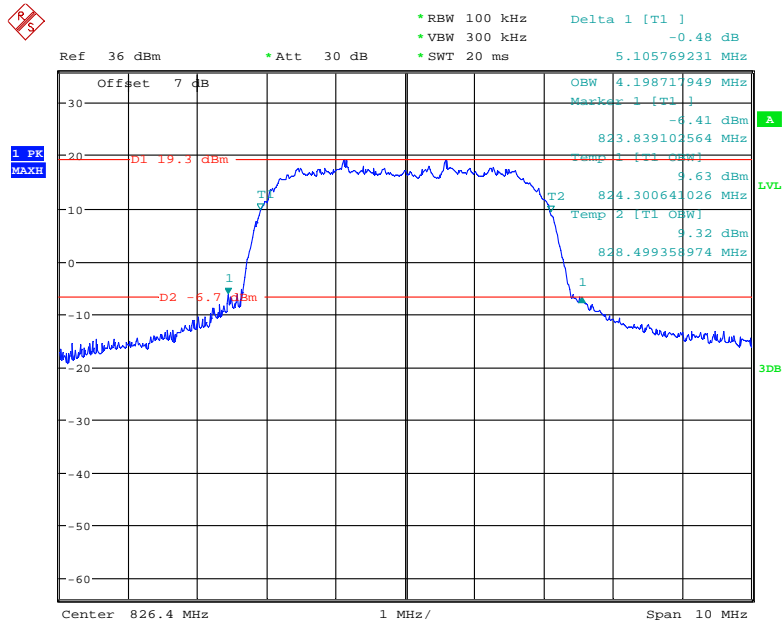

Date: 11.JUL.2021 15:41:39

**26 dB Emissions & 99% Occupied Bandwidth for HSDPA (16QAM) Mode, Middle channel**

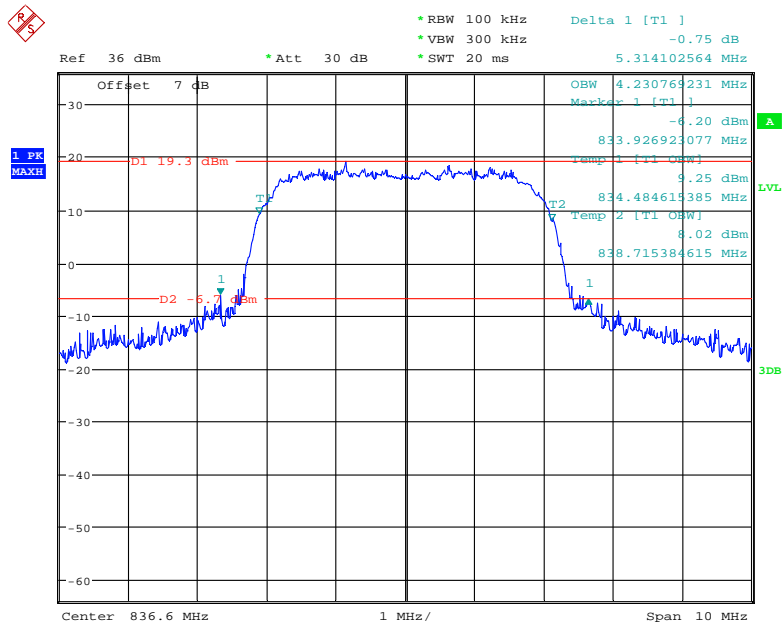

Date: 11.JUL.2021 15:42:56

26 dB Emissions & 99% Occupied Bandwidth for HSDPA (16QAM) Mode, High channel

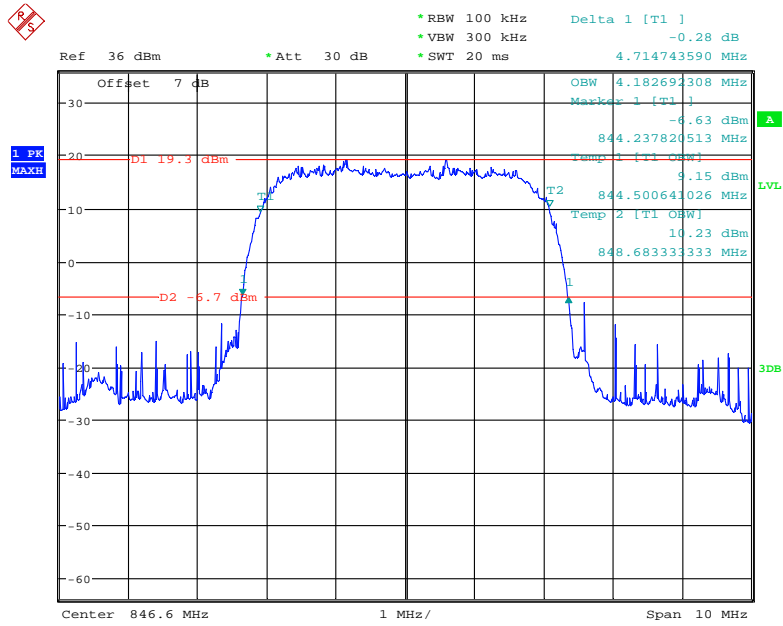

Date: 11.JUL.2021 15:44:09

PCS Band (Part 24E)

26 dB Emissions & 99% Occupied Bandwidth for GSM (GMSK) Mode, Low channel

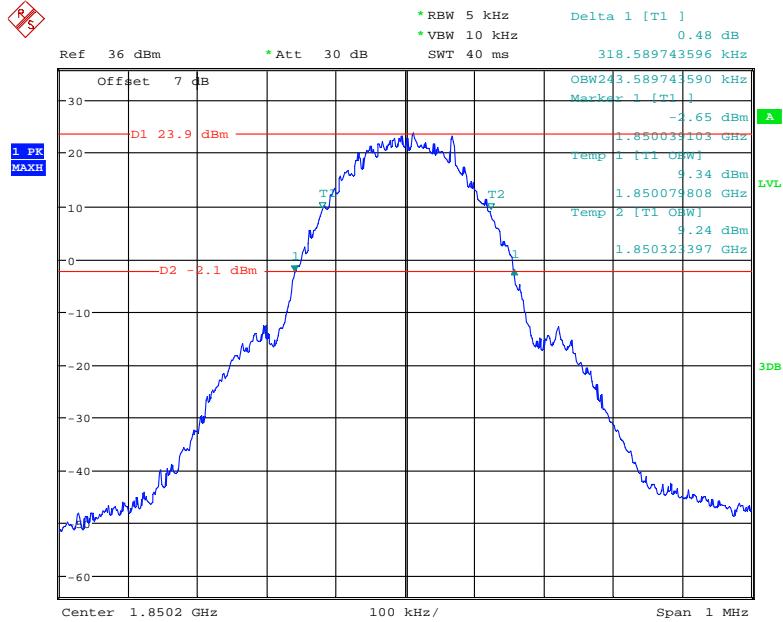

Date: 10.JUL.2021 00:13:42

26 dB Emissions & 99% Occupied Bandwidth for GSM (GMSK) Mode, Middle channel

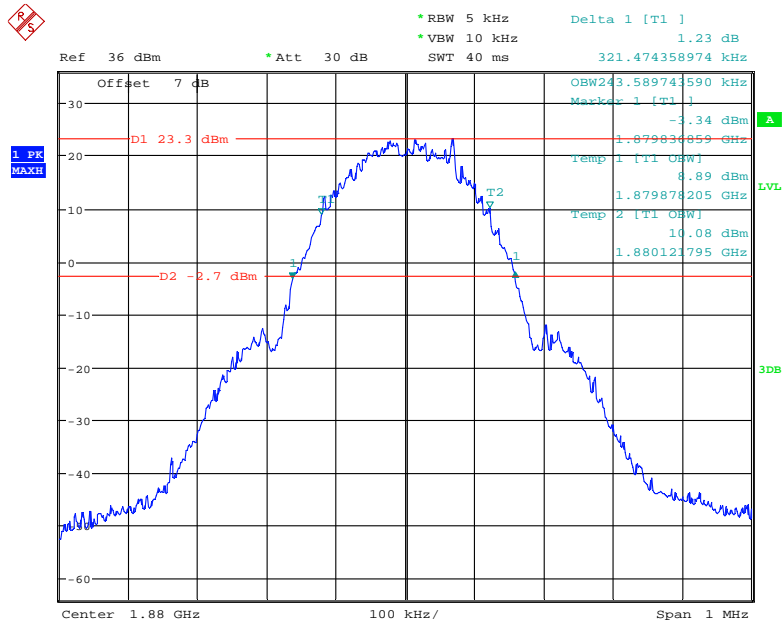

Date: 10.JUL.2021 00:15:08

**26 dB Emissions & 99% Occupied Bandwidth for GSM (GMSK) Mode, High channel**

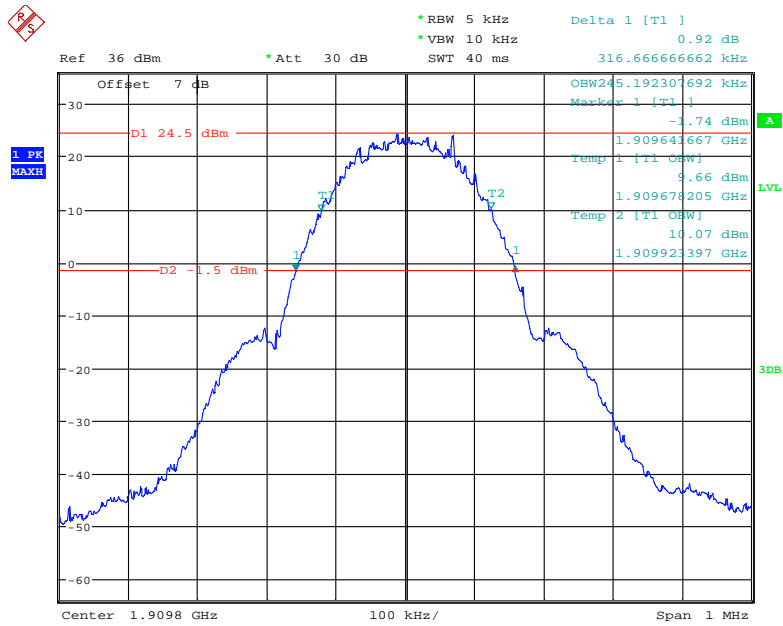

Date: 10.JUL.2021 00:25:24

**26 dB Emissions & 99% Occupied Bandwidth for EGPRS (8PSK) Mode, Low channel**

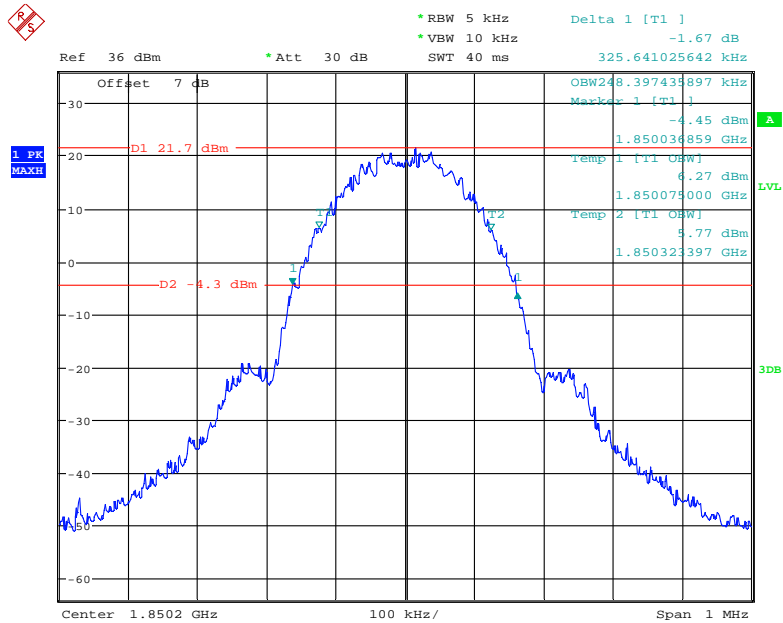

Date: 10.JUL.2021 00:30:52

**26 dB Emissions & 99% Occupied Bandwidth for EGPRS (8PSK) Mode, Middle channel**

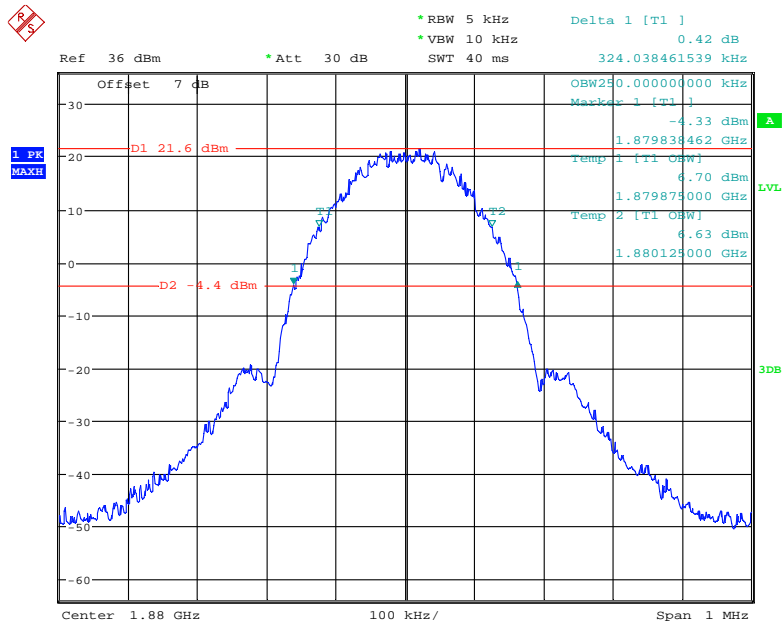

Date: 10.JUL.2021 00:29:49

**26 dB Emissions & 99% Occupied Bandwidth for EGPRS (8PSK) Mode, High channel**

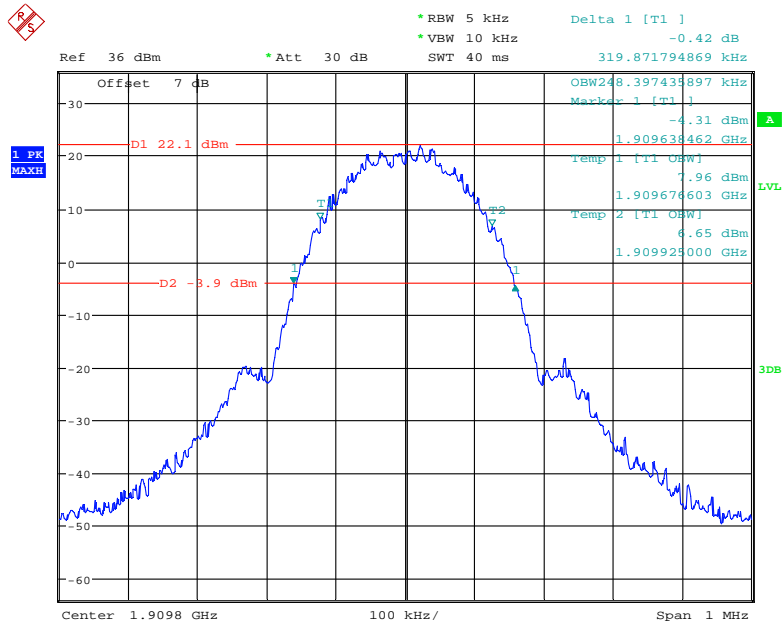

Date: 10.JUL.2021 00:28:10

**26 dB Emissions & 99% Occupied Bandwidth for RMC (BPSK) Mode, Low channel**

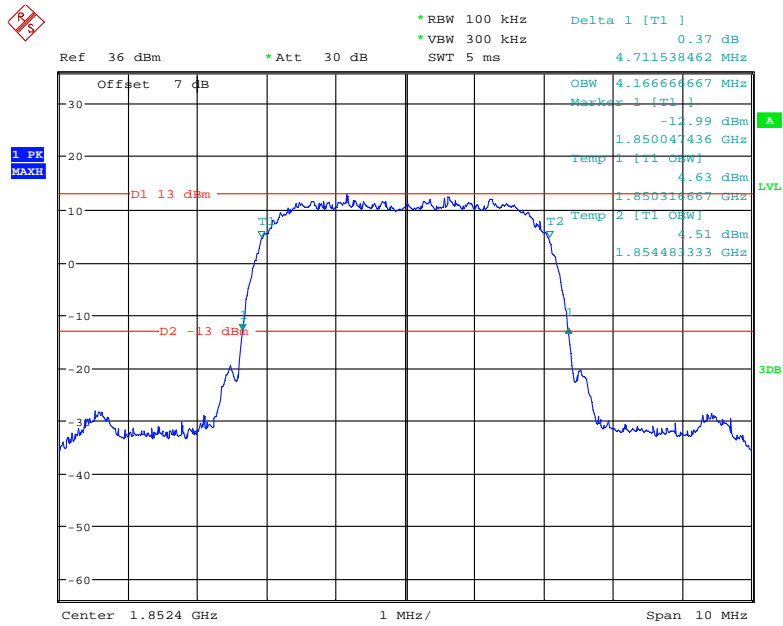

Date: 10.JUL.2021 01:24:22

**26 dB Emissions & 99% Occupied Bandwidth for RMC (BPSK) Mode, Middle channel**

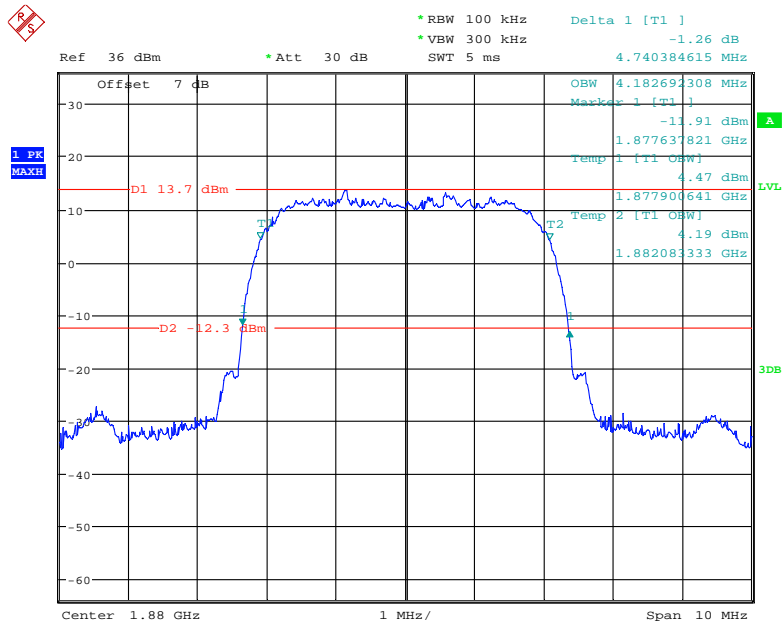

Date: 10.JUL.2021 01:25:55

**26 dB Emissions & 99% Occupied Bandwidth for RMC (BPSK) Mode, High channel**

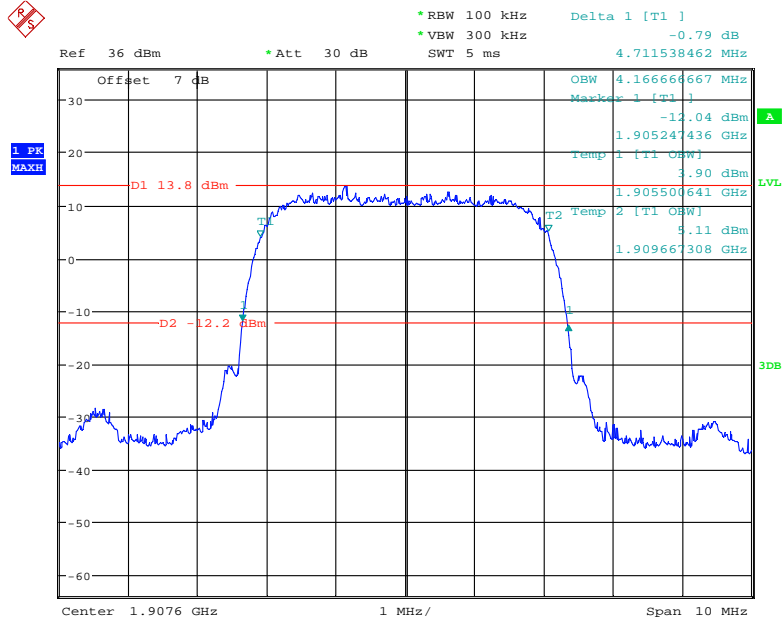

Date: 10.JUL.2021 01:27:43

**26 dB Emissions & 99% Occupied Bandwidth for HSUPA (BPSK) Mode, Low channel**

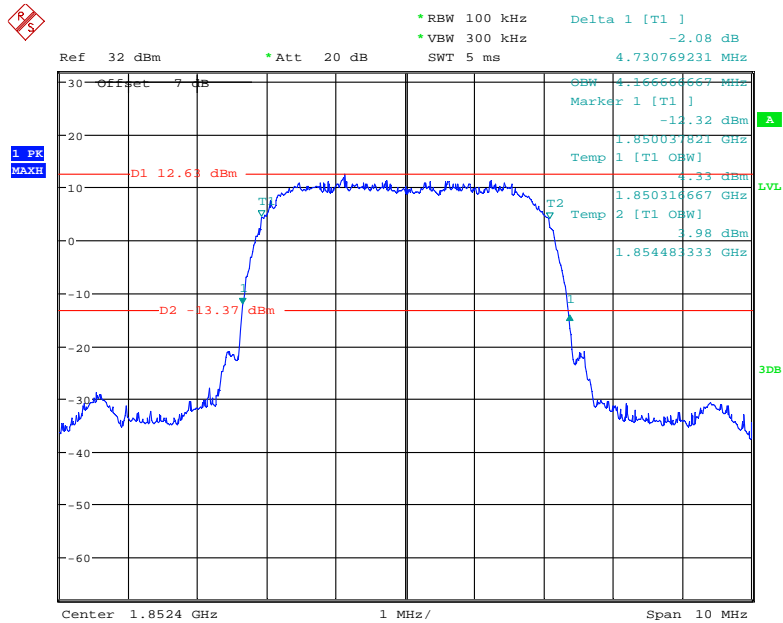

Date: 21.JUL.2021 18:34:19



**26 dB Emissions & 99% Occupied Bandwidth for HSUPA (BPSK) Mode, Middle channel**

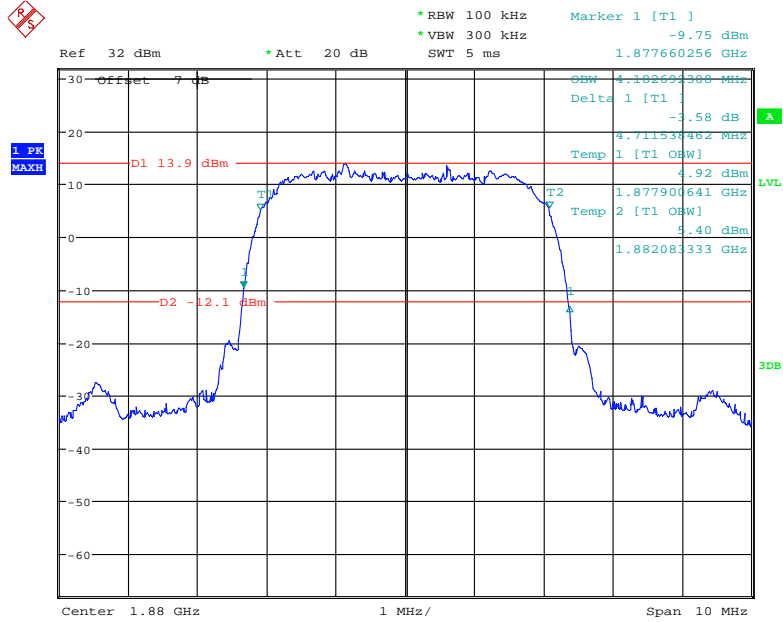

Date: 24.JUL.2021 16:34:30

**26 dB Emissions & 99% Occupied Bandwidth for HSUPA (BPSK) Mode, High channel**

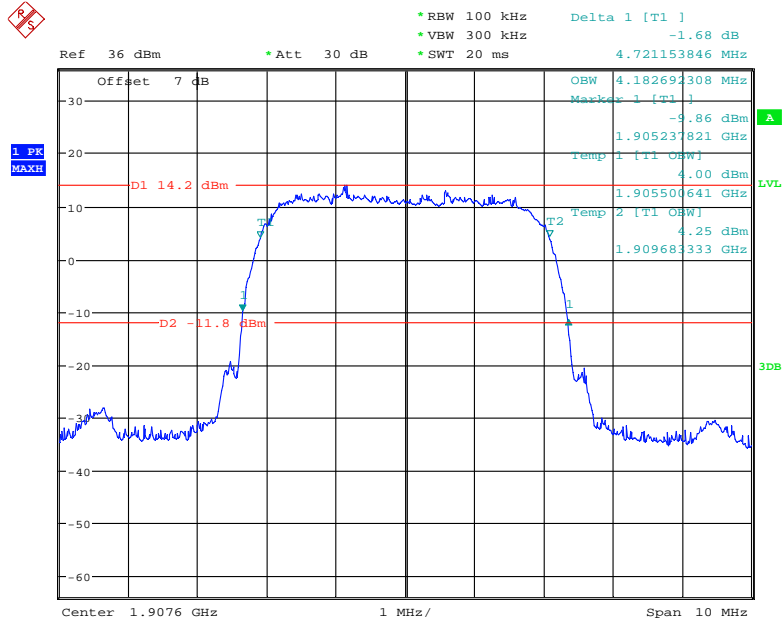

Date: 11.JUL.2021 15:51:35

**26 dB Emissions & 99% Occupied Bandwidth for HSDPA (16QAM) Mode, Low channel**

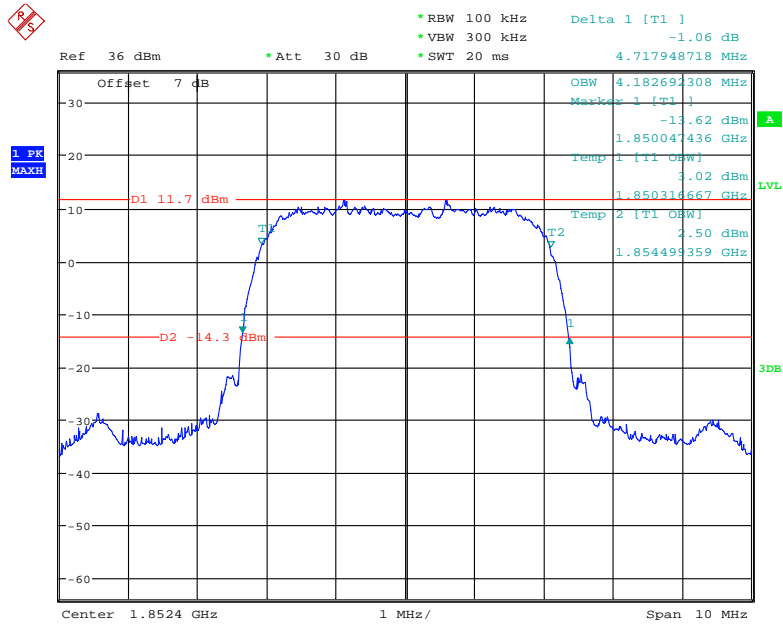

Date: 11.JUL.2021 15:32:52

**26 dB Emissions & 99% Occupied Bandwidth for HSDPA (16QAM) Mode, Middle channel**

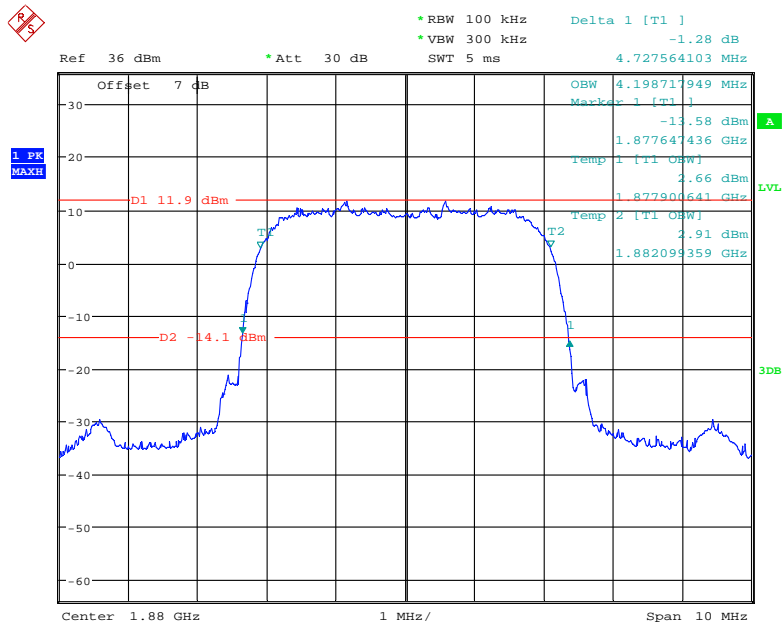

Date: 11.JUL.2021 14:11:45

26 dB Emissions & 99% Occupied Bandwidth for HSDPA (16QAM) Mode, High channel

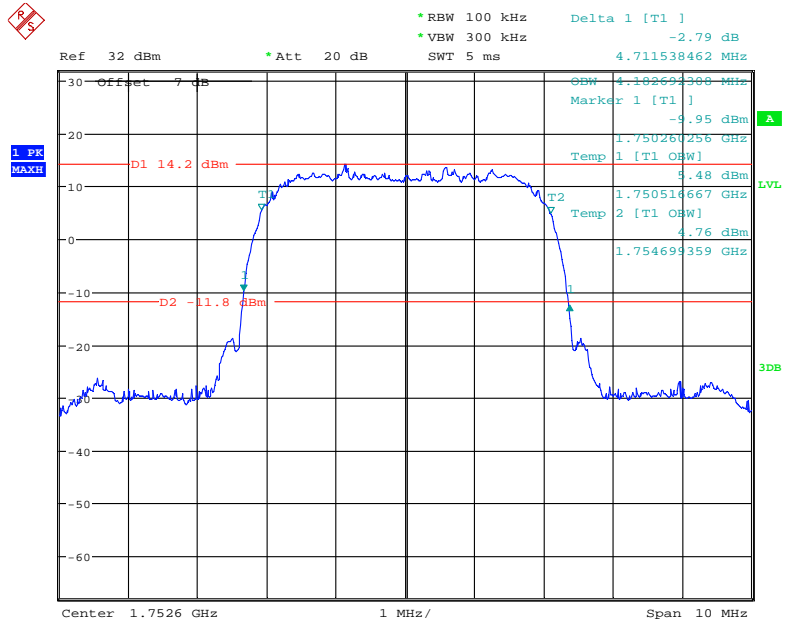

Date: 21.JUL.2021 18:26:07

**AWS Band (Part 27)**

**26 dB Emissions & 99% Occupied Bandwidth for RMC (BPSK) Mode, Low channel**

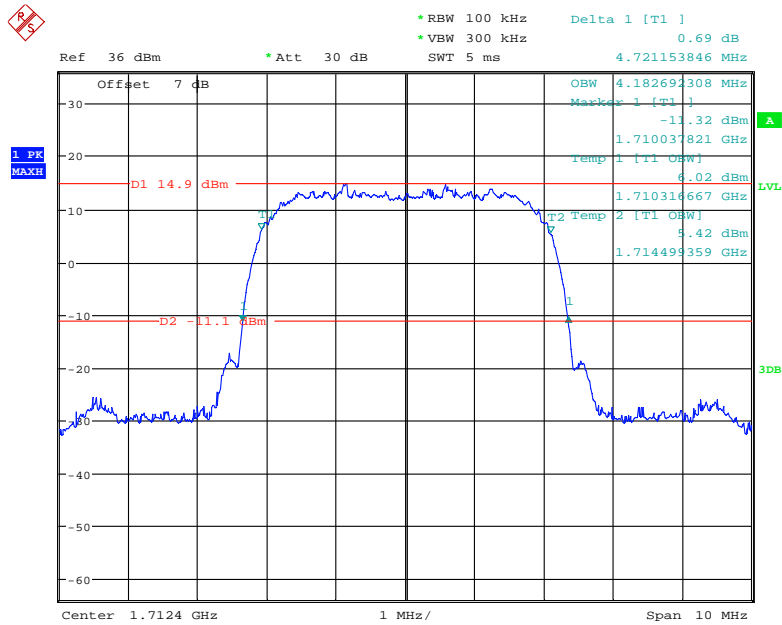

Date: 10.JUL.2021 01:30:28

**26 dB Emissions & 99% Occupied Bandwidth for RMC (BPSK) Mode, Middle channel**

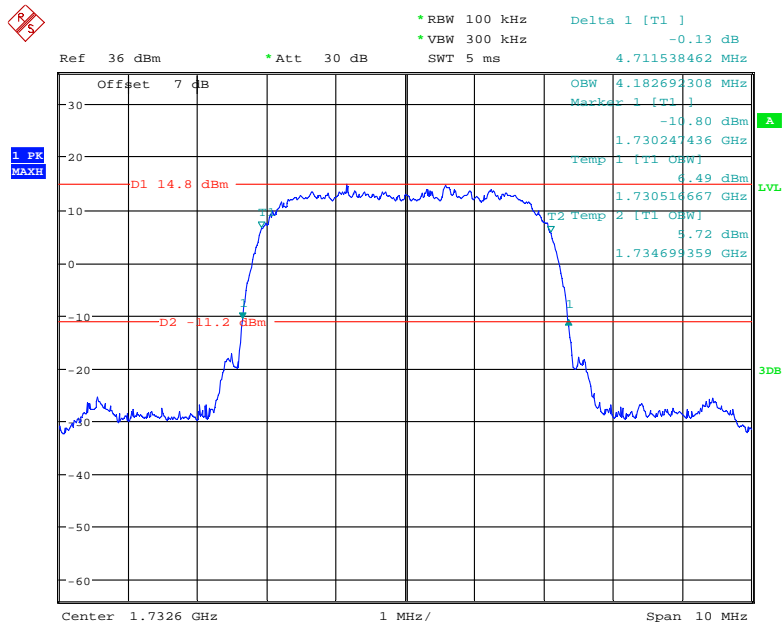

Date: 10.JUL.2021 01:32:09

**26 dB Emissions & 99% Occupied Bandwidth for RMC (BPSK) Mode, High channel**

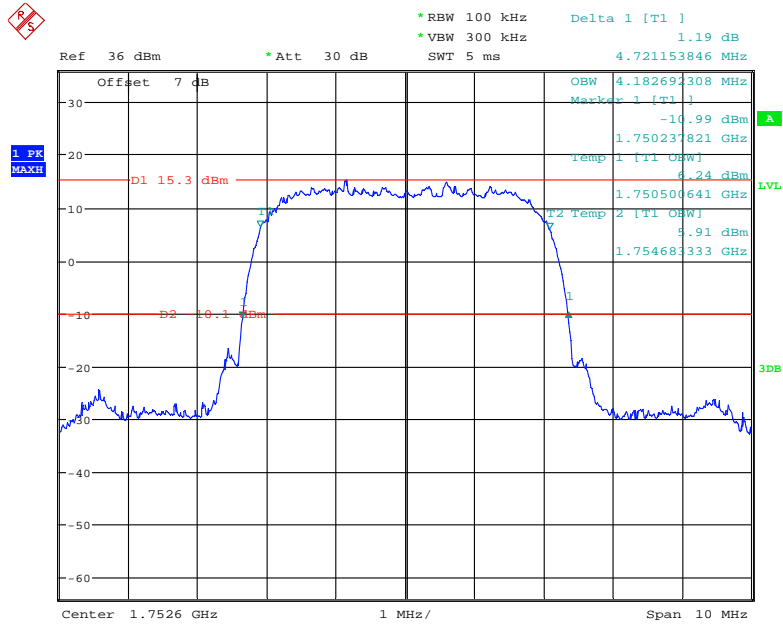

Date: 10.JUL.2021 01:33:28

**26 dB Emissions & 99% Occupied Bandwidth for HSUPA (BPSK) Mode, Low channel**

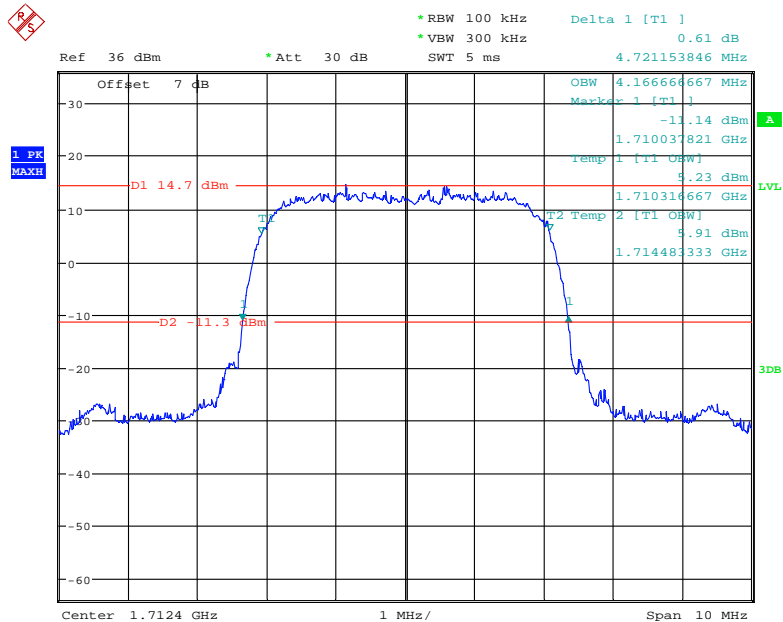

Date: 11.JUL.2021 15:54:27

**26 dB Emissions & 99% Occupied Bandwidth for HSUPA (BPSK) Mode, Middle channel**

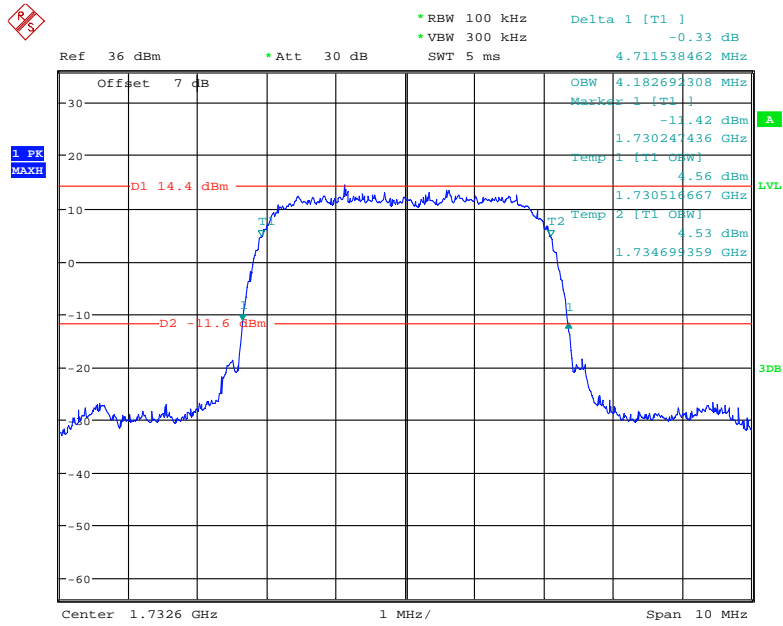

Date: 11.JUL.2021 15:55:49

**26 dB Emissions & 99% Occupied Bandwidth for HSUPA (BPSK) Mode, High channel**

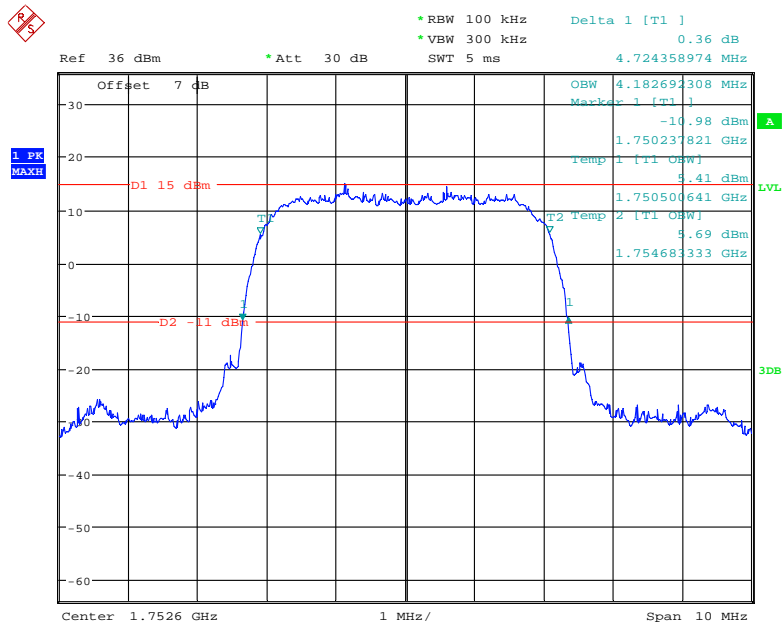

Date: 11.JUL.2021 15:57:19

26 dB Emissions & 99% Occupied Bandwidth for HSDPA (16QAM) Mode, Low channel

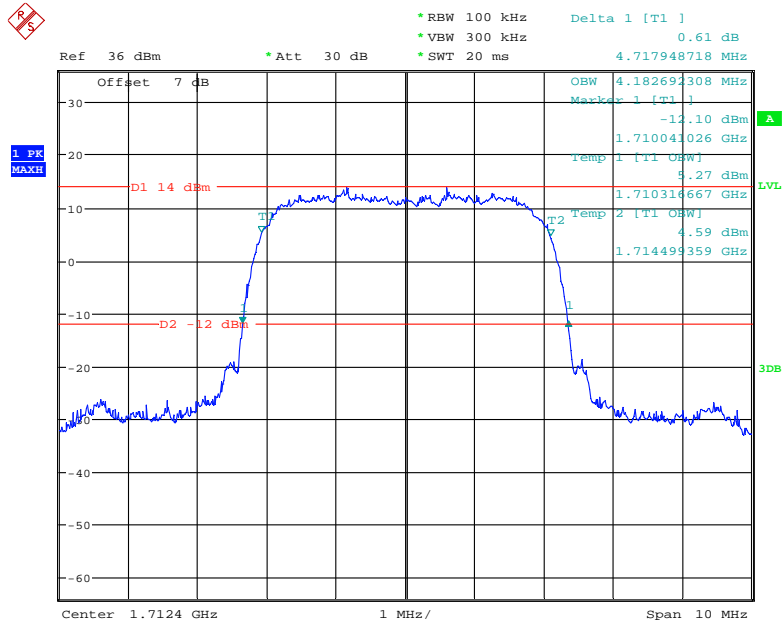

Date: 11.JUL.2021 15:34:13

26 dB Emissions & 99% Occupied Bandwidth for HSDPA (16QAM) Mode, Middle channel

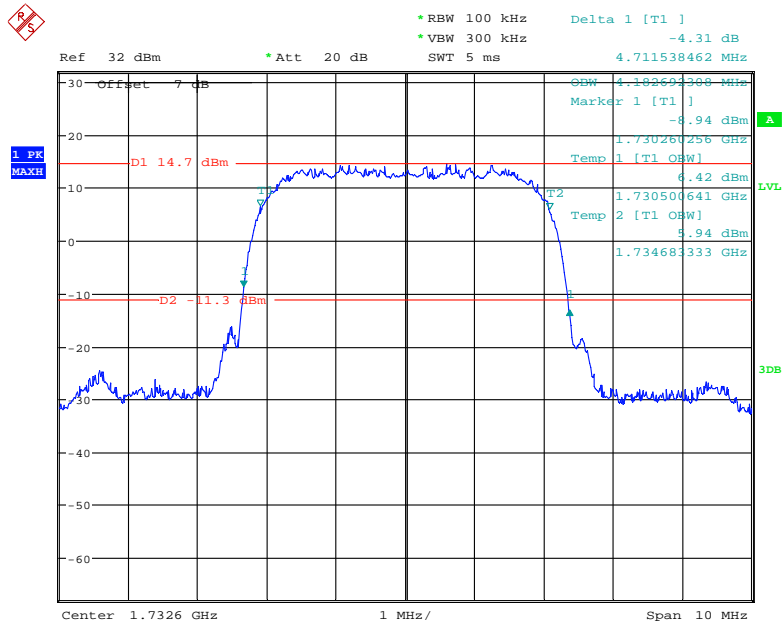

Date: 24.JUL.2021 16:31:09

26 dB Emissions & 99% Occupied Bandwidth for HSDPA (16QAM) Mode, High channel

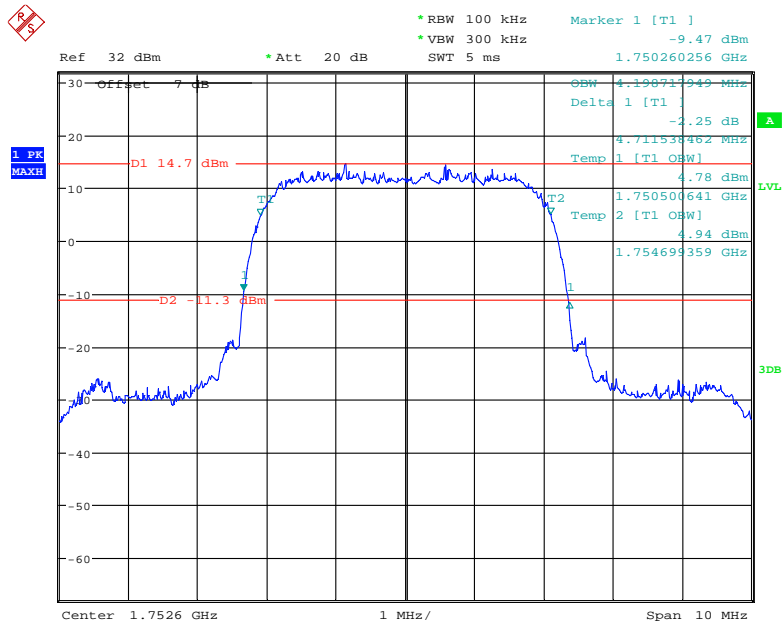

Date: 24.JUL.2021 16:23:53



**LTE Band 2:**

Bandwidth (MHz)	Modulation	Channel	99% Occupied Bandwidth (MHz)	26 dB Emission Bandwidth (MHz)
1.4	QPSK	Low	1.104	1.296
		Middle	1.098	1.302
		High	1.104	1.320
	16QAM	Low	1.104	1.296
		Middle	1.104	1.320
		High	1.098	1.284
3	QPSK	Low	2.688	2.880
		Middle	2.688	2.880
		High	2.688	2.892
	16QAM	Low	2.688	2.880
		Middle	2.688	2.880
		High	2.688	2.892
5	QPSK	Low	4.520	4.940
		Middle	4.520	4.960
		High	4.520	4.900
	16QAM	Low	4.500	4.920
		Middle	4.520	4.960
		High	4.520	5.000
10	QPSK	Low	8.960	9.640
		Middle	8.960	9.560
		High	8.960	9.600
	16QAM	Low	8.960	9.600
		Middle	8.960	9.600
		High	8.960	9.560
15	QPSK	Low	13.560	14.820
		Middle	13.500	14.700
		High	13.560	14.760
	16QAM	Low	13.560	14.760
		Middle	13.500	14.880
		High	13.560	14.760
20	QPSK	Low	18.000	19.280
		Middle	18.000	19.360
		High	17.920	19.360
	16QAM	Low	17.920	19.440
		Middle	18.080	19.600
		High	18.000	19.440

**LTE Band 4:**

Bandwidth (MHz)	Modulation	Channel	99% Occupied Bandwidth (MHz)	26 dB Emission Bandwidth (MHz)
1.4	QPSK	Low	1.104	1.392
		Middle	1.104	1.326
		High	1.104	1.296
	16QAM	Low	1.110	1.320
		Middle	1.098	1.290
		High	1.104	1.302
3	QPSK	Low	2.688	2.880
		Middle	2.700	2.880
		High	2.688	2.892
	16QAM	Low	2.688	2.868
		Middle	2.688	2.880
		High	2.688	2.880
5	QPSK	Low	4.520	4.920
		Middle	4.520	4.940
		High	4.500	4.960
	16QAM	Low	4.500	4.940
		Middle	4.520	5.000
		High	4.520	4.980
10	QPSK	Low	8.960	9.640
		Middle	9.000	9.600
		High	8.960	9.600
	16QAM	Low	8.960	9.520
		Middle	8.960	9.640
		High	8.960	9.640
15	QPSK	Low	13.560	14.880
		Middle	13.500	14.820
		High	13.560	14.820
	16QAM	Low	13.560	14.820
		Middle	13.500	14.820
		High	13.500	14.820
20	QPSK	Low	18.000	19.280
		Middle	18.000	19.360
		High	18.000	19.600
	16QAM	Low	18.000	19.440
		Middle	18.000	19.440
		High	18.000	19.280

**LTE Band 5:**

Bandwidth (MHz)	Modulation	Channel	99% Occupied Bandwidth (MHz)	26 dB Emission Bandwidth (MHz)
1.4	QPSK	Low	1.098	1.284
		Middle	1.098	1.320
		High	1.110	1.296
	16QAM	Low	1.110	1.314
		Middle	1.098	1.284
		High	1.104	1.313
3	QPSK	Low	2.688	2.880
		Middle	2.688	2.880
		High	2.688	2.892
	16QAM	Low	2.688	2.892
		Middle	2.688	2.880
		High	2.688	2.880
5	QPSK	Low	4.520	4.920
		Middle	4.520	4.920
		High	4.500	4.940
	16QAM	Low	4.500	4.940
		Middle	4.500	4.940
		High	4.500	4.960
10	QPSK	Low	8.960	9.600
		Middle	8.960	9.520
		High	9.000	10.200
	16QAM	Low	8.960	9.520
		Middle	8.960	9.600
		High	8.960	10.000

**LTE Band 7:**

Bandwidth (MHz)	Modulation	Channel	99% Occupied Bandwidth (MHz)	26 dB Emission Bandwidth (MHz)
5	QPSK	Low	4.500	4.920
		Middle	4.500	4.960
		High	4.520	4.920
	16QAM	Low	4.500	4.980
		Middle	4.500	4.920
		High	4.520	4.900
10	QPSK	Low	9.000	9.640
		Middle	8.960	9.640
		High	8.960	9.600
	16QAM	Low	8.960	9.520
		Middle	8.960	9.520
		High	8.960	9.640
15	QPSK	Low	13.560	14.880
		Middle	13.500	14.700
		High	13.500	14.820
	16QAM	Low	13.500	14.760
		Middle	13.500	14.760
		High	13.500	14.820
20	QPSK	Low	17.920	19.280
		Middle	18.000	19.440
		High	18.000	19.440
	16QAM	Low	18.000	19.200
		Middle	18.000	19.360
		High	18.000	19.280

**LTE Band 17**

Bandwidth (MHz)	Modulation	Channel	99% Occupied Bandwidth (MHz)	26 dB Emission Bandwidth (MHz)
5	QPSK	Low	4.560	5.180
		Middle	4.520	5.140
		High	4.520	5.160
	16QAM	Low	4.520	5.160
		Middle	4.540	5.320
		High	4.560	5.220
10	QPSK	Low	9.000	10.000
		Middle	8.960	9.840
		High	8.960	9.880
	16QAM	Low	9.000	9.968
		Middle	8.960	9.880
		High	8.960	9.840

**LTE Band 38**

Bandwidth (MHz)	Modulation	Channel	99% Occupied Bandwidth (MHz)	26 dB Emission Bandwidth (MHz)
5	QPSK	Low	4.520	5.180
		Middle	4.500	4.920
		High	4.525	4.984
	16QAM	Low	4.500	4.940
		Middle	4.525	5.000
		High	4.500	5.200
10	QPSK	Low	9.000	9.880
		Middle	9.000	9.840
		High	8.960	9.640
	16QAM	Low	8.960	9.480
		Middle	8.960	9.480
		High	8.960	9.960
15	QPSK	Low	13.500	15.300
		Middle	13.500	14.700
		High	13.500	15.060
	16QAM	Low	13.500	16.140
		Middle	13.560	14.700
		High	13.560	16.620
20	QPSK	Low	18.000	19.760
		Middle	18.000	19.600
		High	18.000	19.680
	16QAM	Low	18.000	19.680
		Middle	18.000	19.519
		High	18.000	19.280

**LTE Band 41**

Bandwidth (MHz)	Modulation	Channel	99% Occupied Bandwidth (MHz)	26 dB Emission Bandwidth (MHz)
5	QPSK	Low	4.500	4.920
		Middle	4.520	4.920
		High	4.520	5.080
	16QAM	Low	4.500	5.100
		Middle	4.500	5.080
		High	4.520	4.920
10	QPSK	Low	9.000	9.640
		Middle	8.960	9.680
		High	8.960	9.600
	16QAM	Low	8.960	9.440
		Middle	8.960	9.440
		High	8.960	9.840
15	QPSK	Low	13.560	15.000
		Middle	13.575	15.529
		High	13.500	15.120
	16QAM	Low	13.560	16.440
		Middle	13.500	15.360
		High	13.575	15.817
20	QPSK	Low	17.920	19.520
		Middle	18.000	19.200
		High	17.920	19.600
	16QAM	Low	18.000	19.360
		Middle	18.000	19.520
		High	17.920	19.200

The test plots of LTE band please refer to the Appendix A.

**FCC §2.1051, §22.917(a) & §24.238(a); §27.53 - SPURIOUS EMISSIONS AT ANTENNA TERMINALS**

**Applicable Standard**

FCC §2.1051, §22.917(a) and §24.238(a) and §27.53.

The spectrum was to be investigated to the tenth harmonics of the highest fundamental frequency as specified in § 2.1051.

**Test Procedure**

The RF output of the transceiver was connected to a spectrum analyzer and simulator through appropriate attenuation. The resolution bandwidth of the spectrum analyzer was set at 1MHz. Sufficient scans were taken to show any out of band emissions up to 10<sup>th</sup> harmonic.

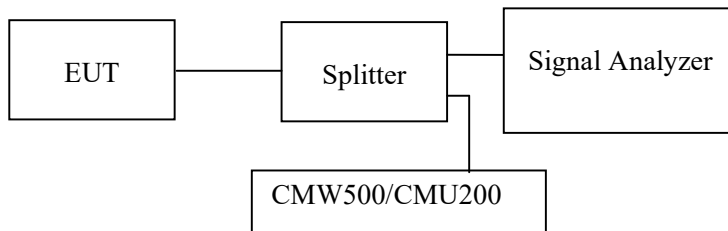

**Test Data**

**Environmental Conditions**

<b>Temperature:</b>	25~28.5 °C
<b>Relative Humidity:</b>	47 ~62 %
<b>ATM Pressure:</b>	101.0 kPa

*The testing was performed by Pedro Yun from 2021-06-08 to 2021-07-19.*

*EUT operation mode: Transmitting*

**Test result: Pass**

*Please refer to the following plots.*



**Cellular Band (Part 22H)**  
**Low Channel:**

**30 MHz – 1 GHz (GSM Mode)**

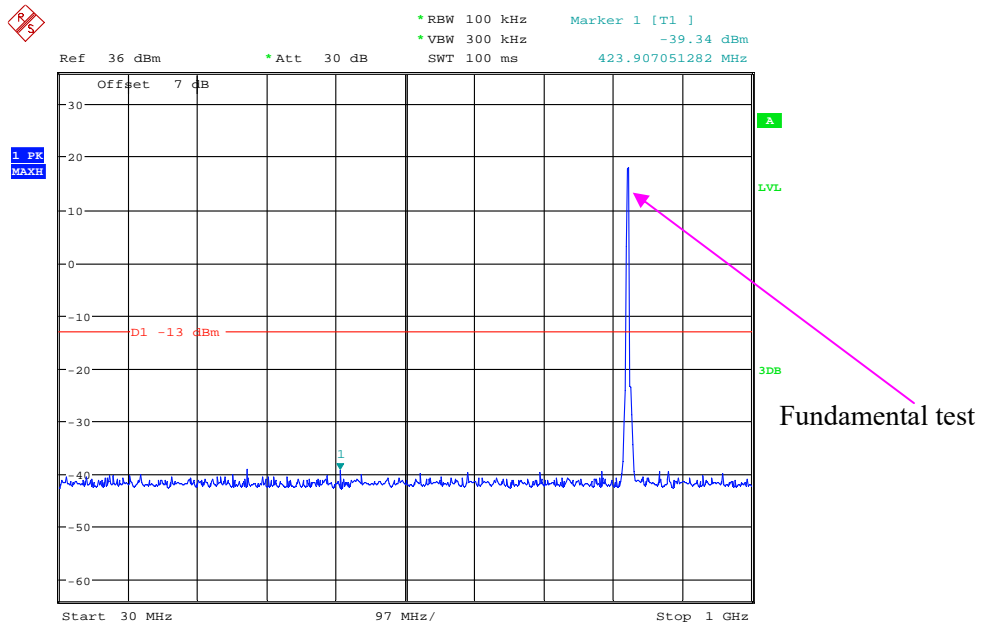

Date: 11.JUL.2021 17:21:47

**1 GHz – 10 GHz (GSM Mode)**

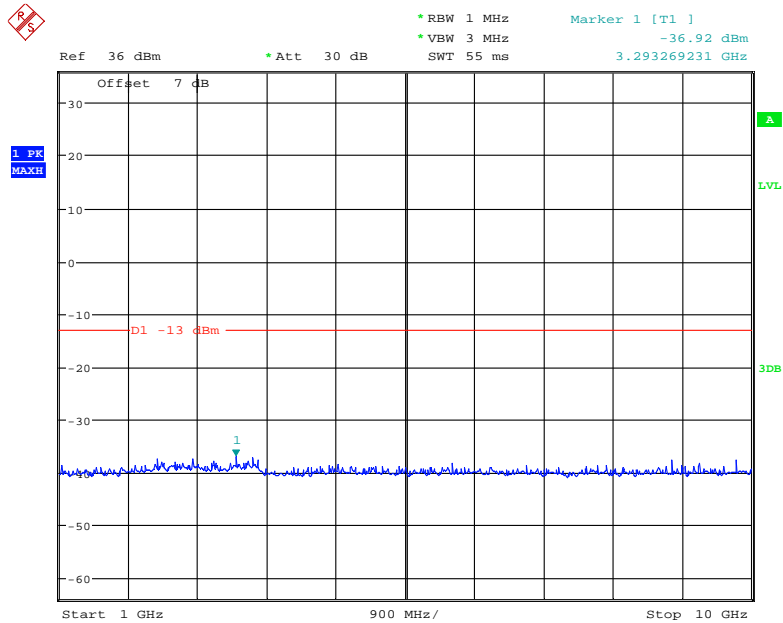

Date: 11.JUL.2021 17:38:26

### 30 MHz – 1 GHz (WCDMA Mode)

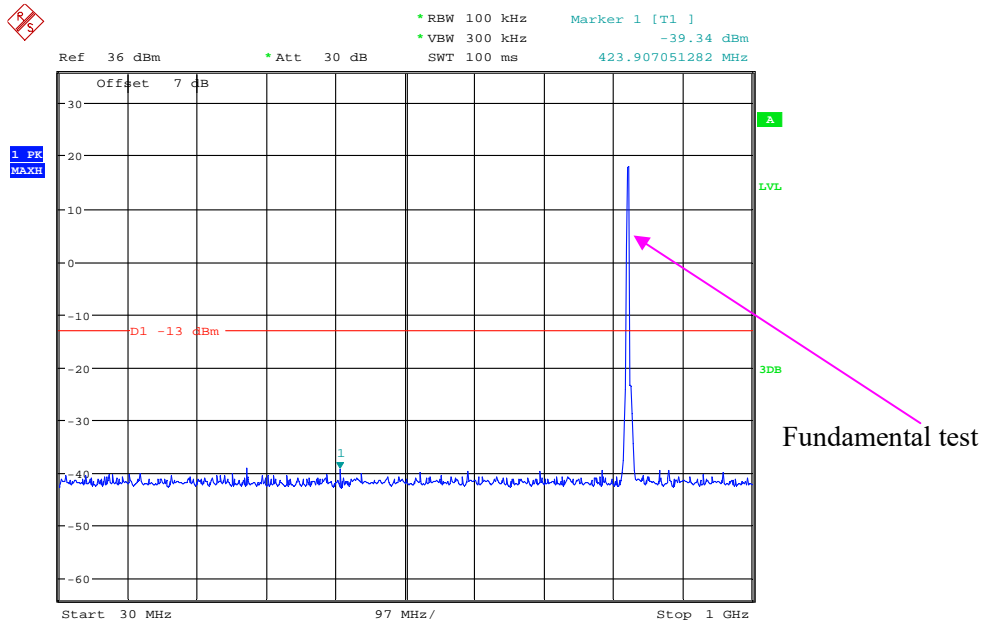

Date: 11.JUL.2021 17:21:47

### 1 GHz – 10 GHz (WCDMA Mode)

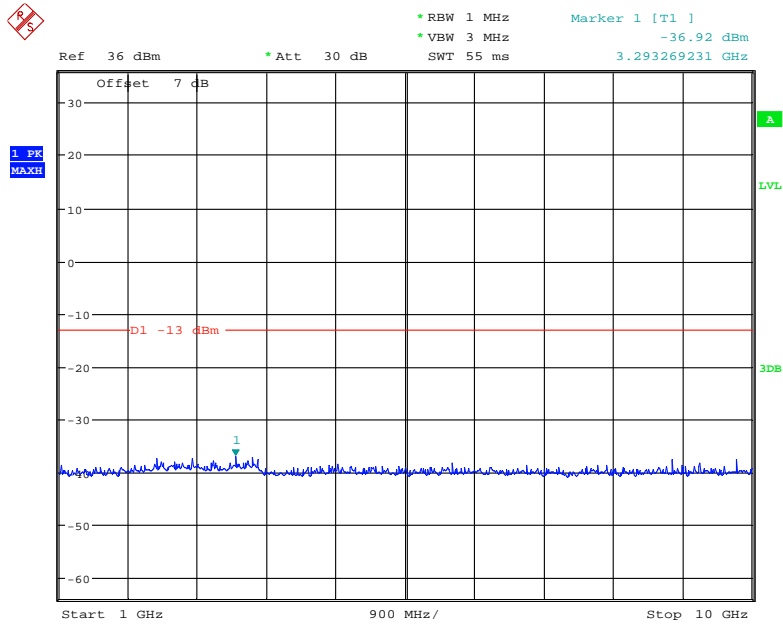

Date: 11.JUL.2021 17:38:26

Middle Channel:

30 MHz – 1 GHz (GSM Mode)

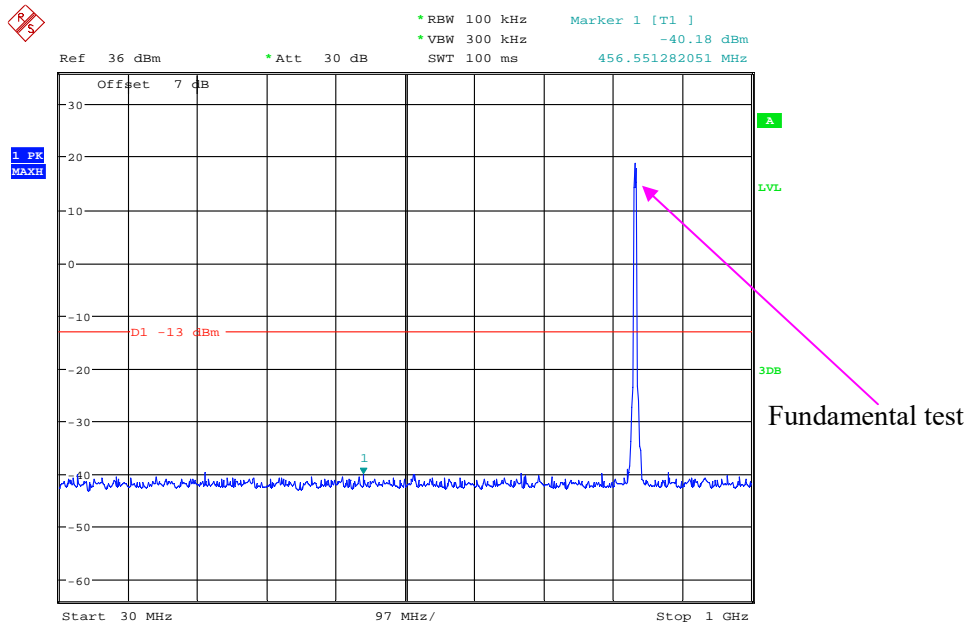

Date: 11.JUL.2021 17:22:24

1 GHz – 10 GHz (GSM Mode)

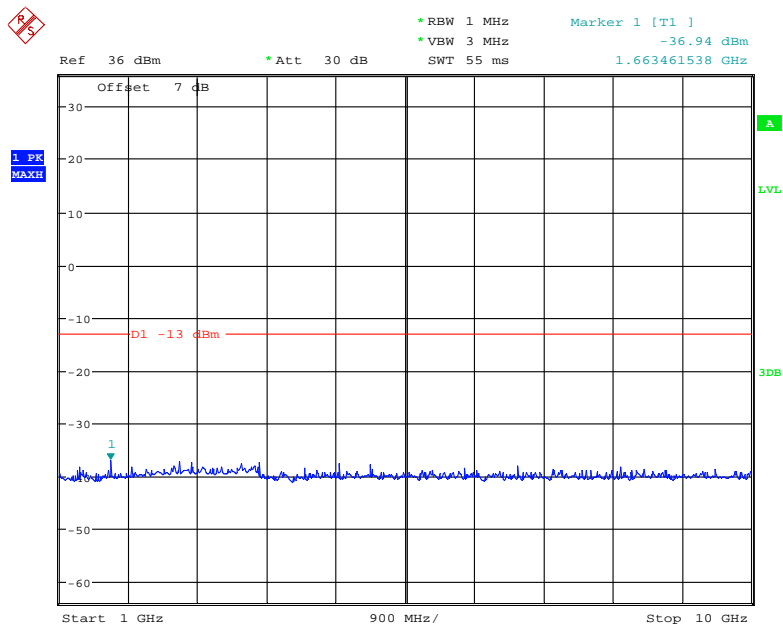

Date: 11.JUL.2021 17:37:42

### 30 MHz – 1 GHz (WCDMA Mode)

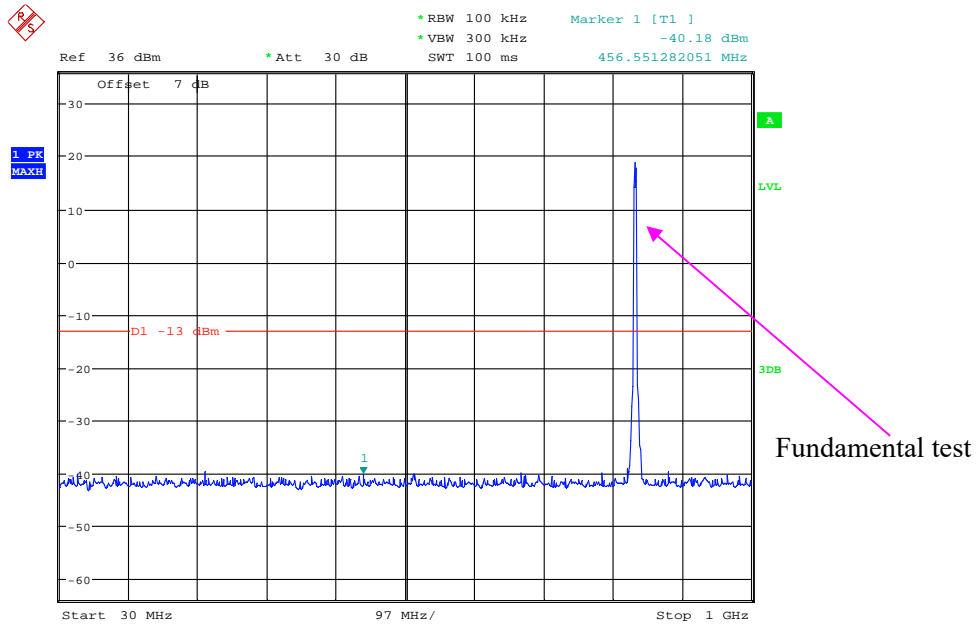

Date: 11.JUL.2021 17:22:24

### 1 GHz – 20 GHz (WCDMA Mode)

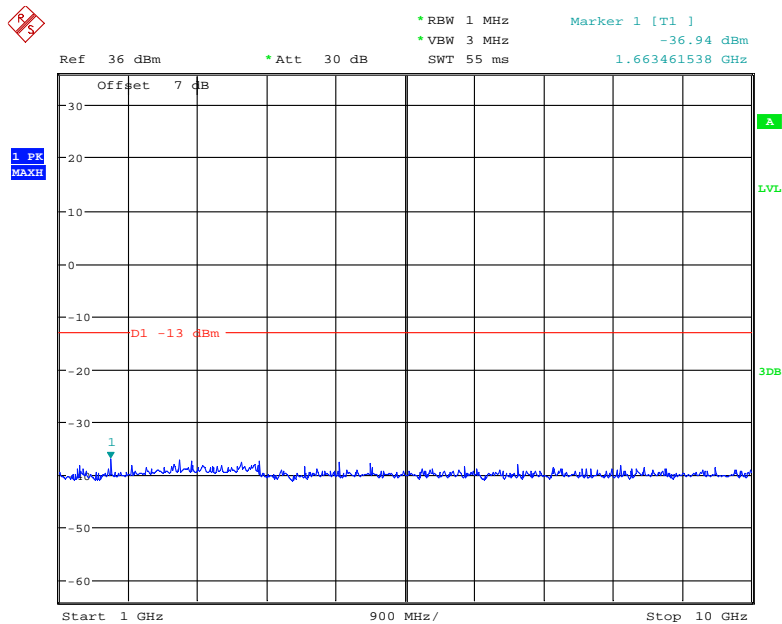

Date: 11.JUL.2021 17:37:42

High Channel:

30 MHz – 1 GHz (GSM Mode)

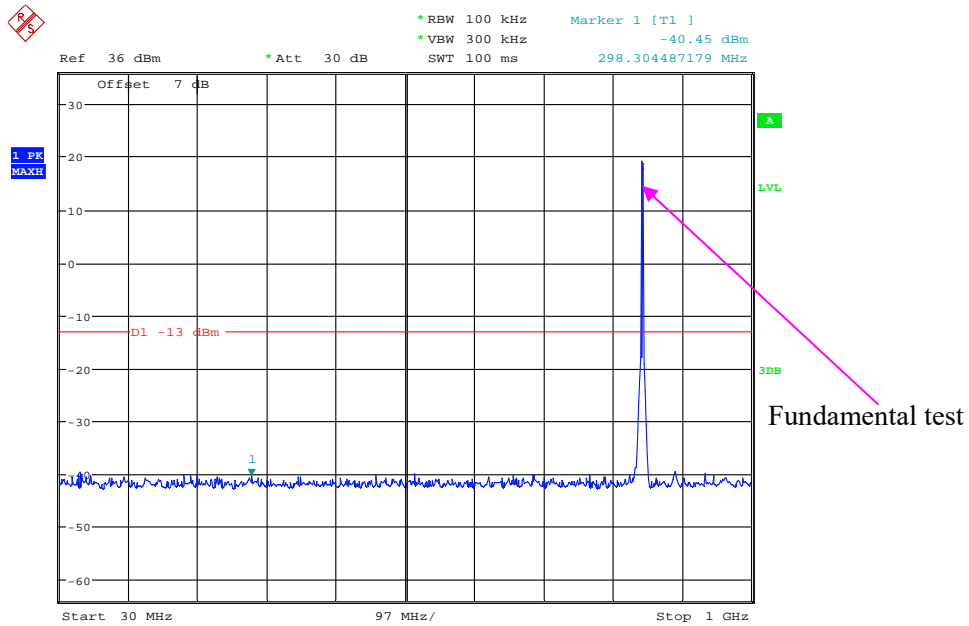

Date: 11.JUL.2021 17:23:16

1 GHz – 10 GHz (GSM Mode)

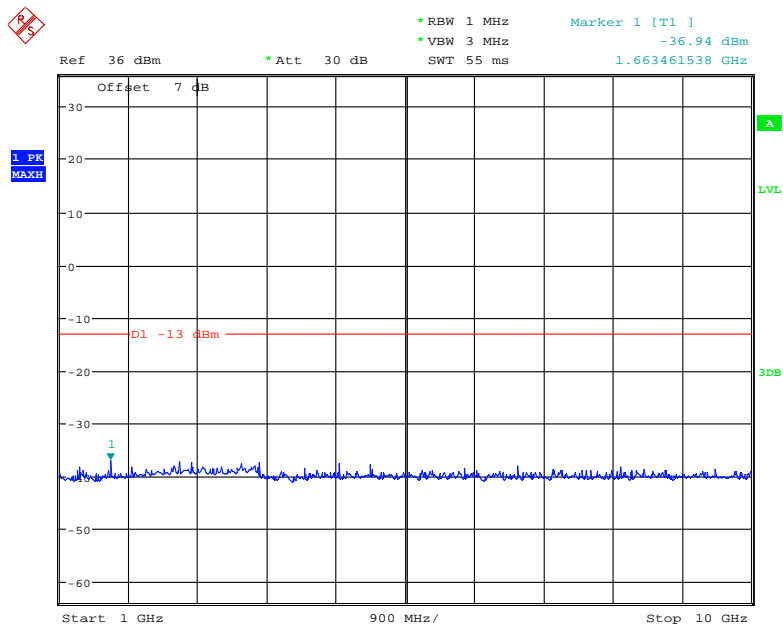

Date: 11.JUL.2021 17:37:42

### 30 MHz – 1 GHz (WCDMA Mode)

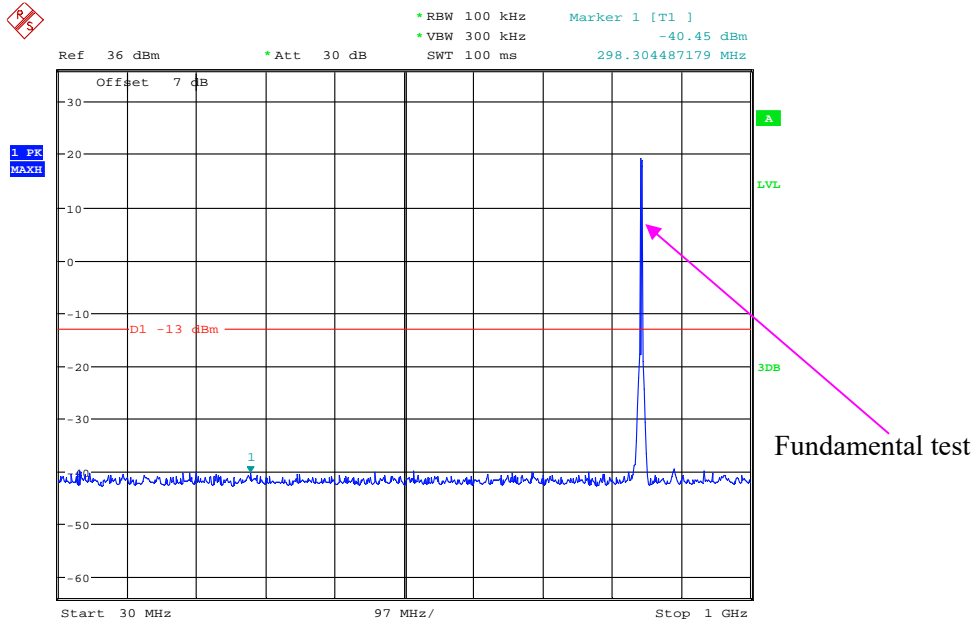

Date: 11.JUL.2021 17:23:16

### 1 GHz – 20 GHz (WCDMA Mode)

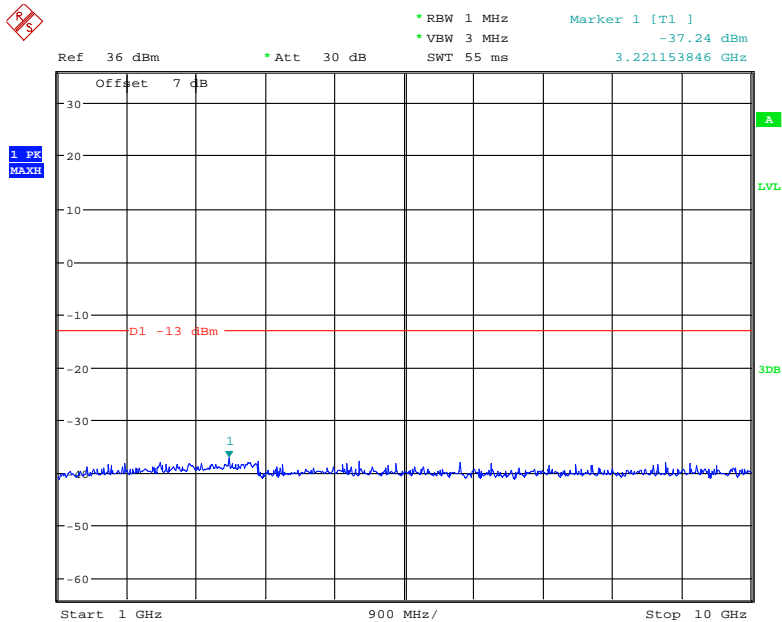

Date: 11.JUL.2021 17:36:49

PCS Band (Part 24E) Low Channel:

30 MHz – 1 GHz (GSM Mode)

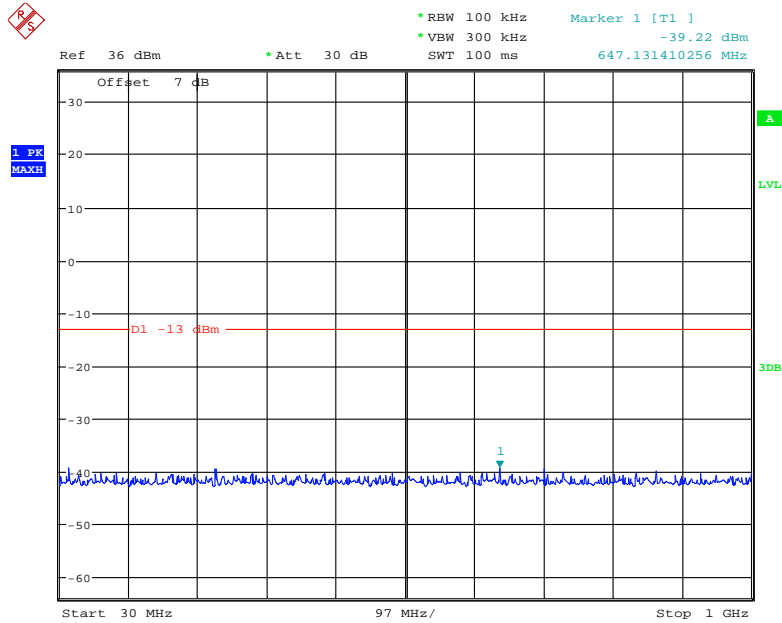

Date: 10.JUL.2021 00:58:25

1 GHz – 2 GHz (GSM Mode)

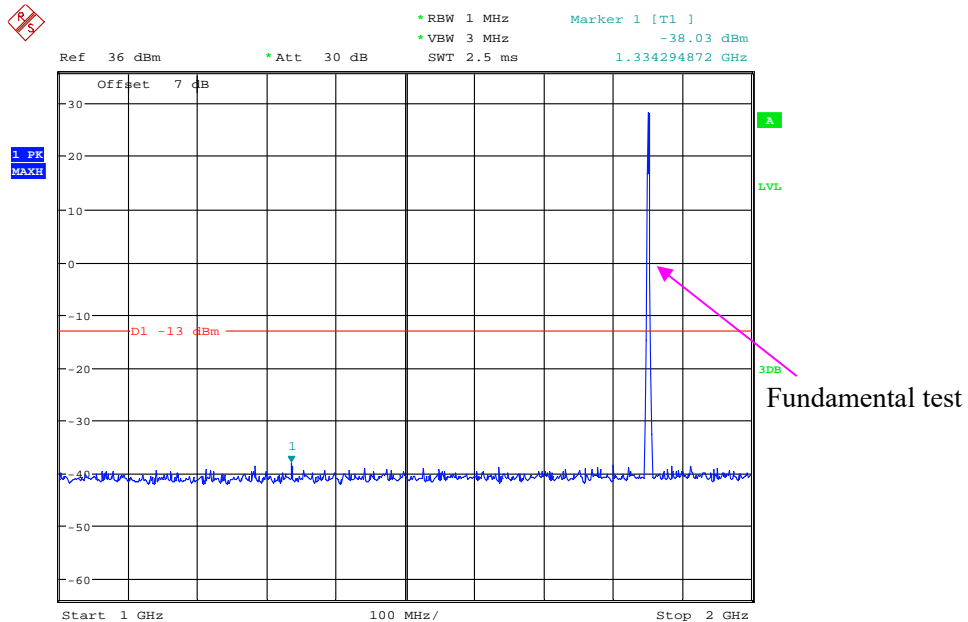

Date: 10.JUL.2021 00:55:05

### 2 GHz – 20 GHz (GSM Mode)

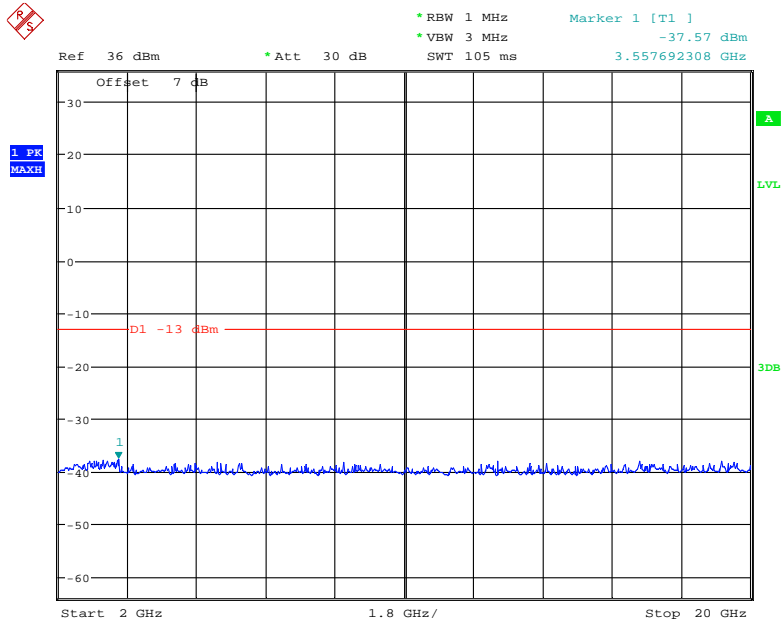

Date: 10.JUL.2021 00:57:40

### 30 MHz – 1 GHz (WCDMA Mode)

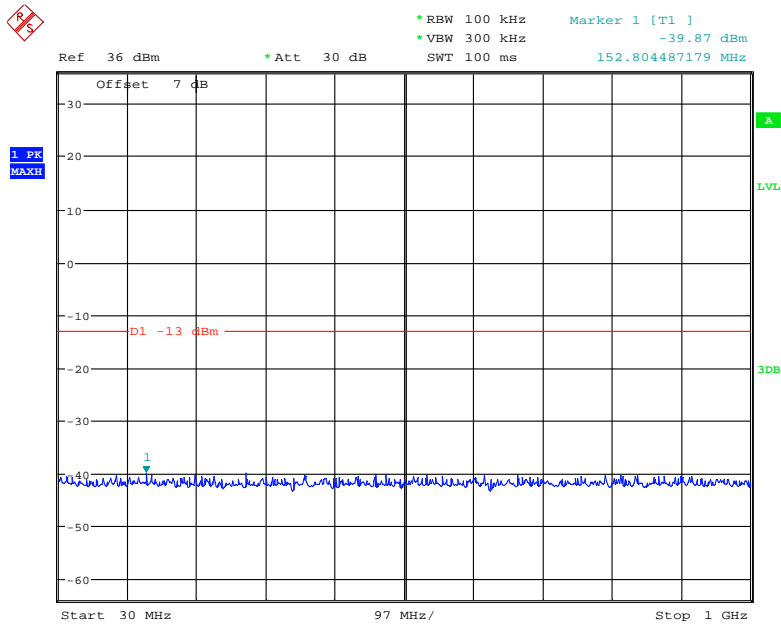

Date: 11.JUL.2021 17:17:04



### 1 GHz – 20 GHz (WCDMA Mode)

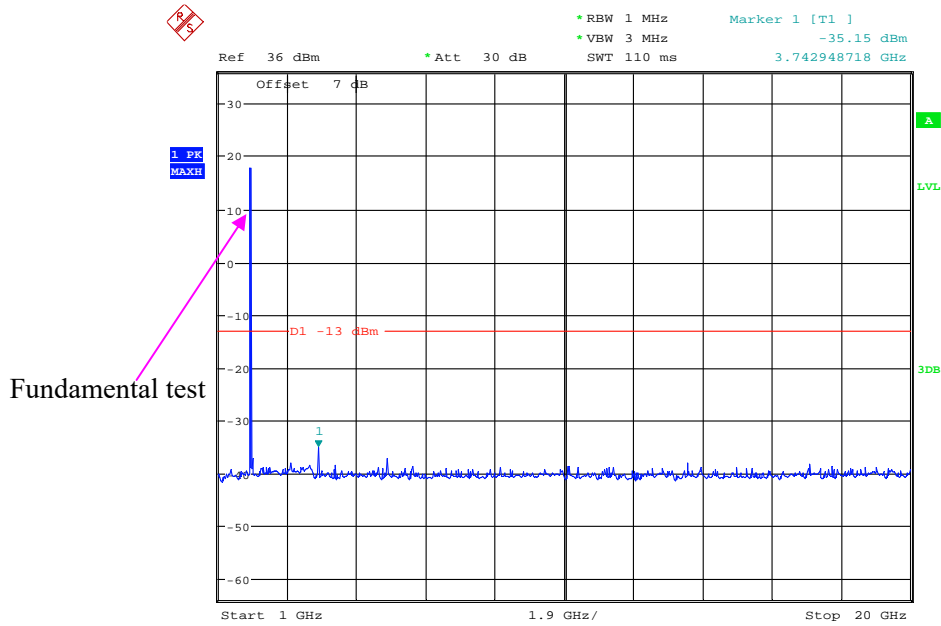

Date: 11.JUL.2021 17:49:06

### Middle Channel:

### 30 MHz – 1 GHz (GSM Mode)

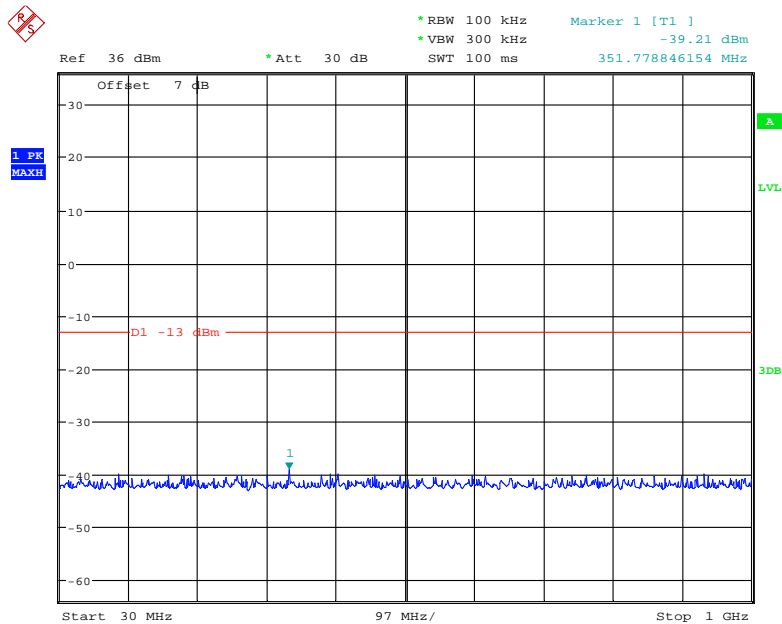

Date: 10.JUL.2021 00:59:05

### 1 GHz – 2 GHz (GSM Mode)

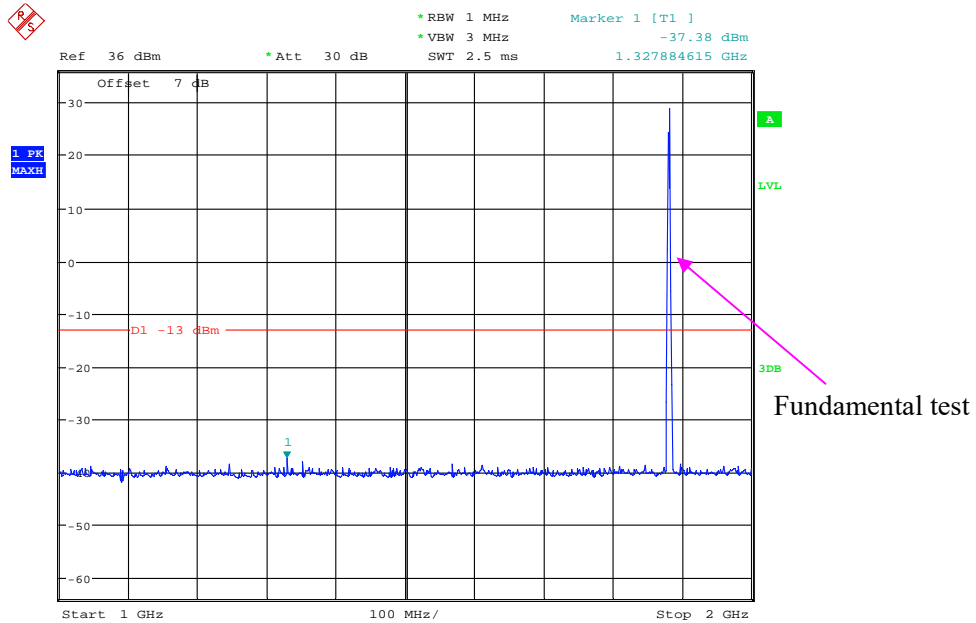

Date: 10.JUL.2021 00:54:37

### 2 GHz – 20 GHz (GSM Mode)

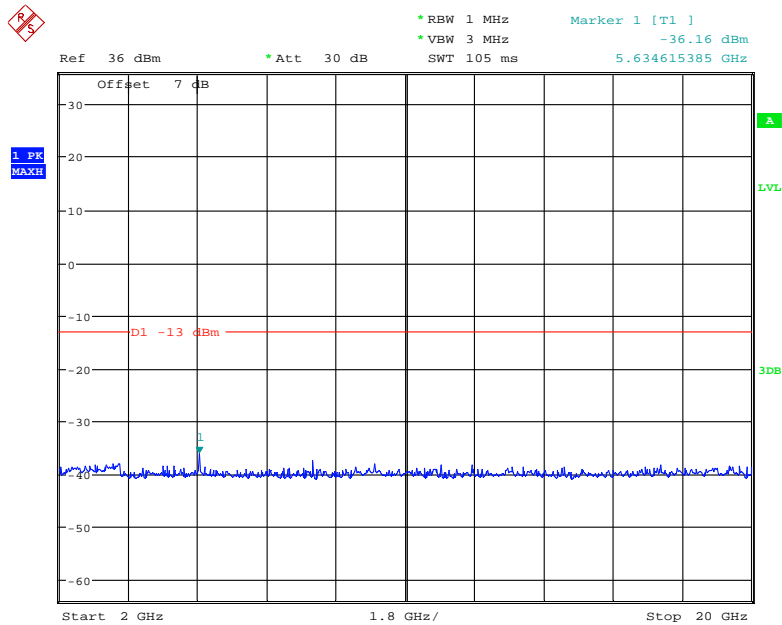

Date: 10.JUL.2021 00:57:13

### 30 MHz – 1 GHz (WCDMA Mode)

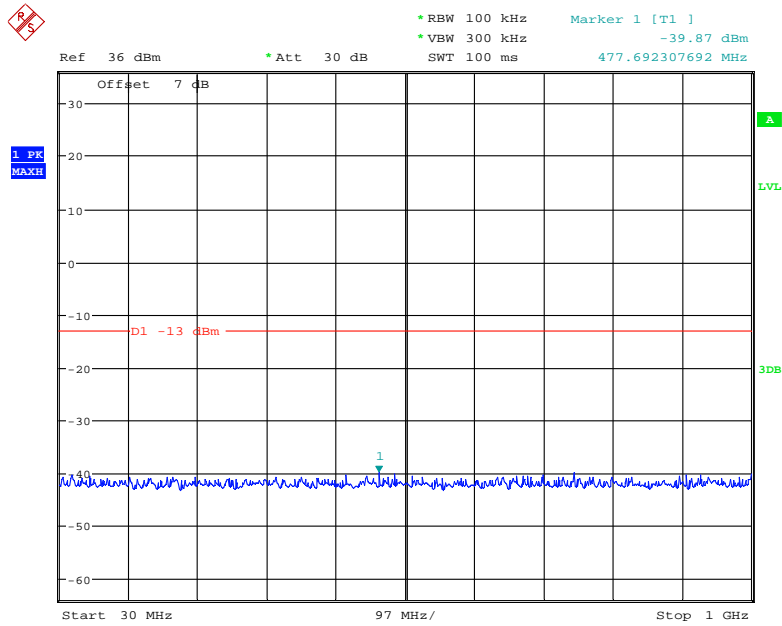

Date: 11.JUL.2021 17:18:10

### 1 GHz – 20 GHz (WCDMA Mode)

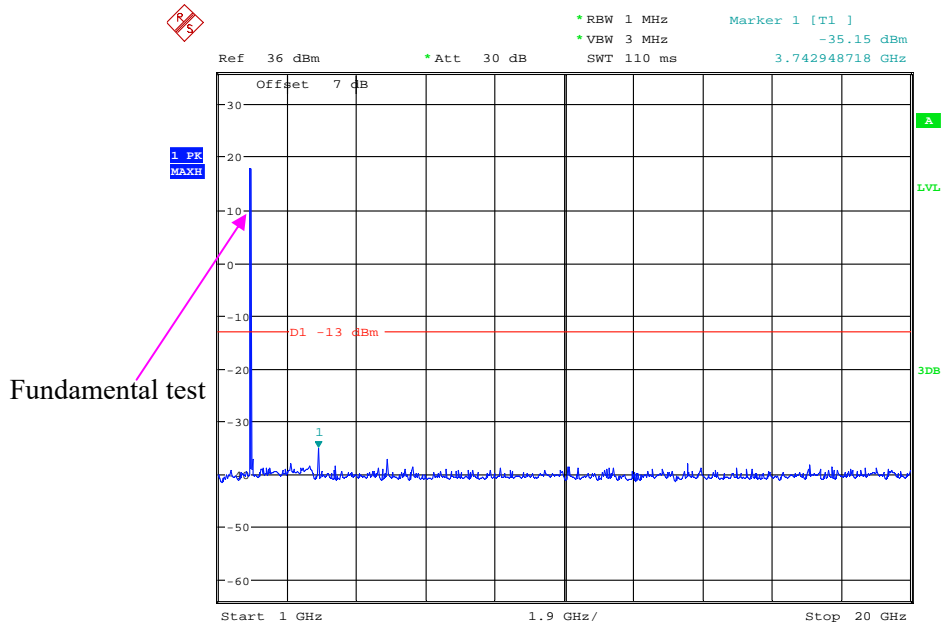

Date: 11.JUL.2021 17:49:06

High Channel:

30 MHz – 1 GHz (GSM Mode)

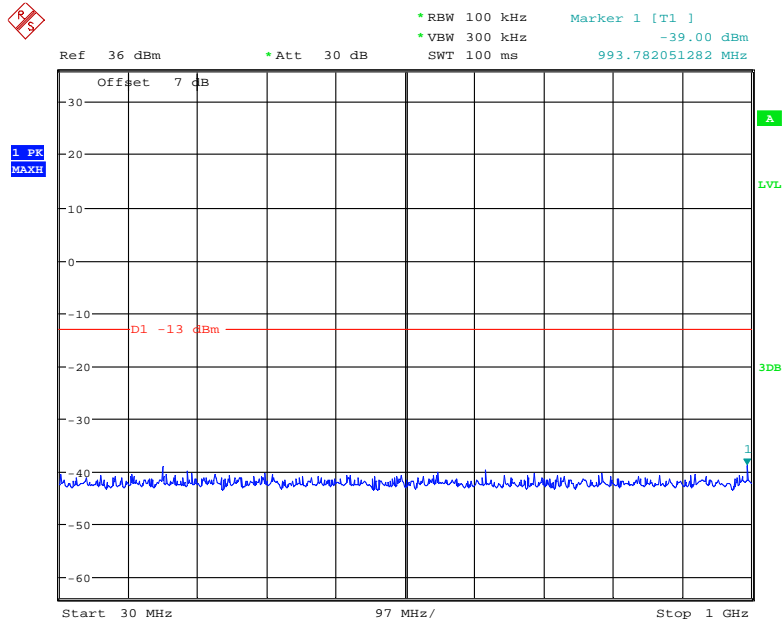

Date: 10.JUL.2021 00:59:30

1 GHz – 2 GHz (GSM Mode)

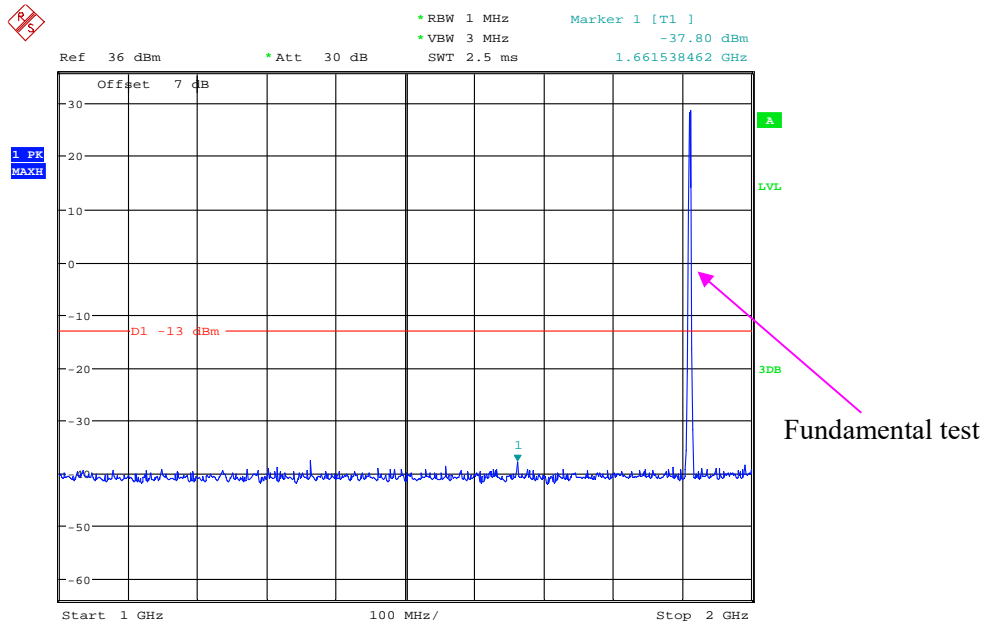

Date: 10.JUL.2021 00:55:39

### 2 GHz – 20 GHz (GSM Mode)

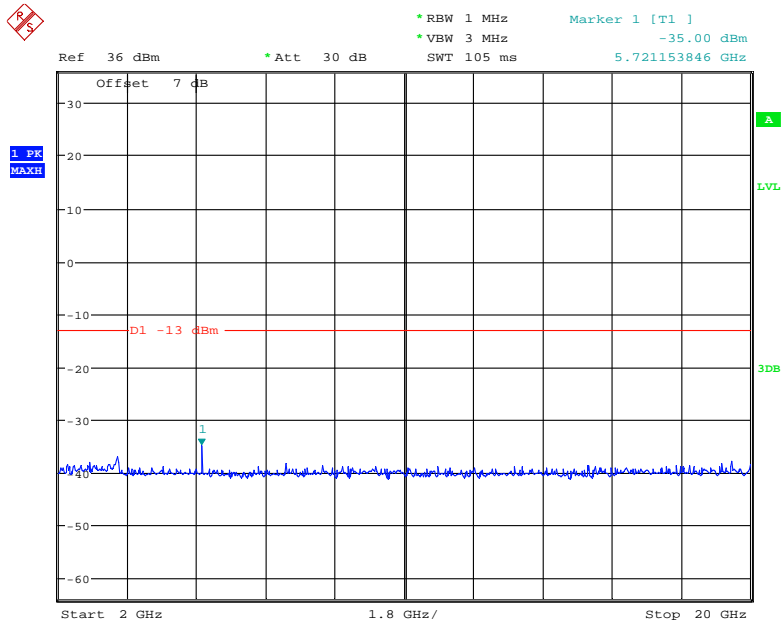

Date: 10.JUL.2021 00:56:11

### 30 MHz – 1 GHz (WCDMA Mode)

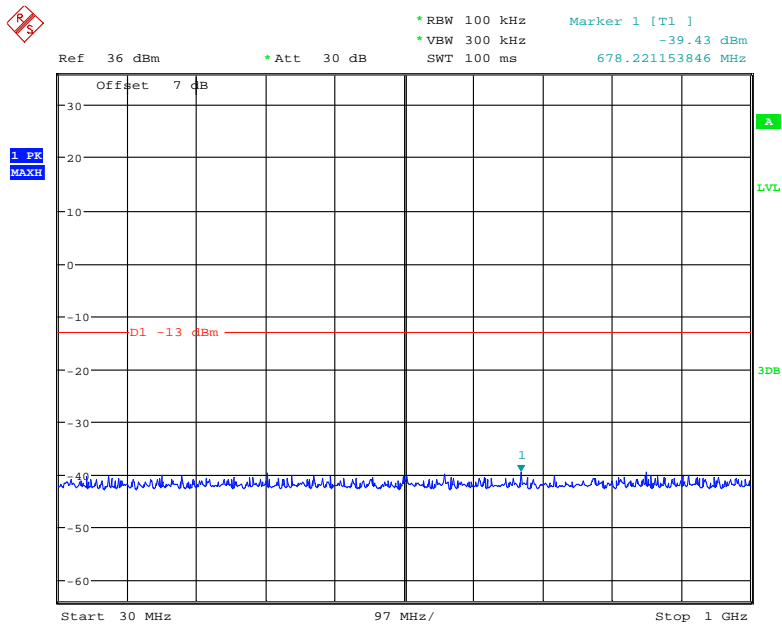

Date: 11.JUL.2021 17:18:50

### 1 GHz – 20 GHz (WCDMA Mode)

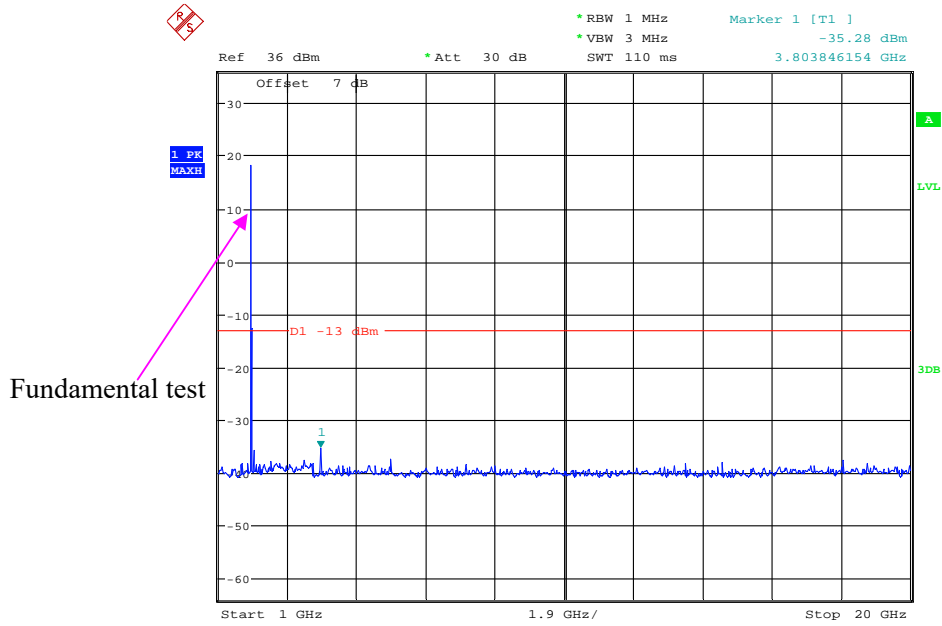

Date: 11.JUL.2021 17:50:15

**AWS Band (Part 27)  
Low Channel:**

**30 MHz – 1 GHz (WCDMA Mode)**

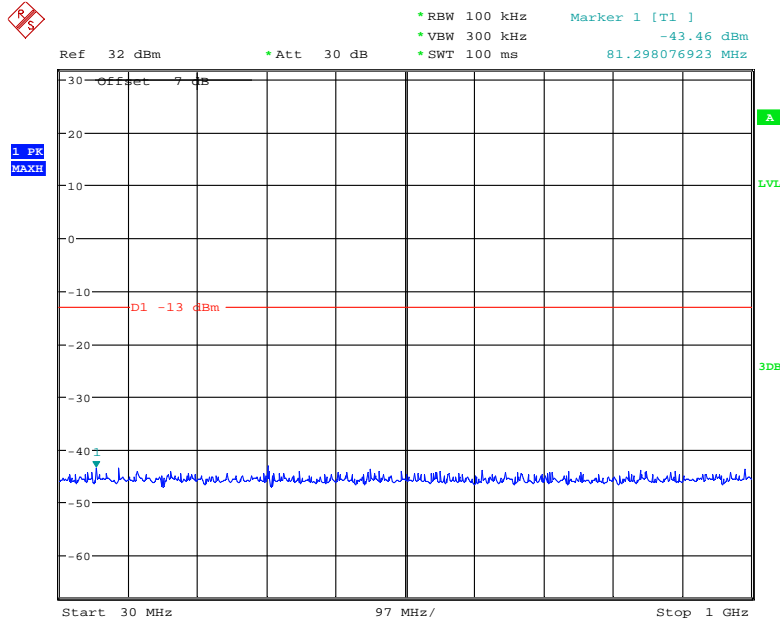

Date: 1.MAY.2021 19:54:32

**1 GHz – 20 GHz (WCDMA Mode)**

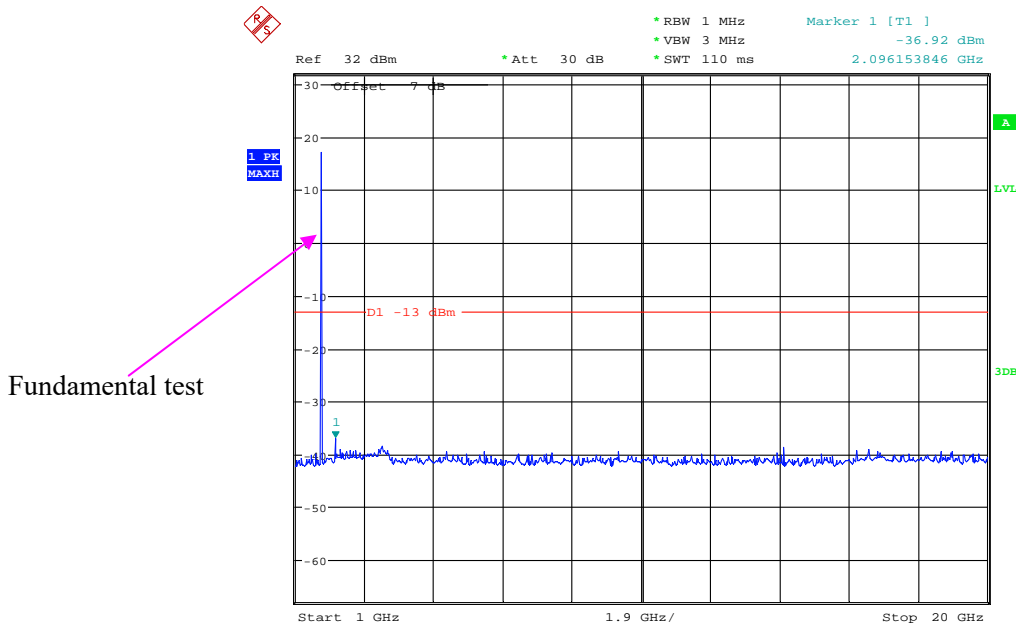

Date: 1.MAY.2021 19:57:46

Middle Channel

30 MHz – 1 GHz (WCDMA Mode)

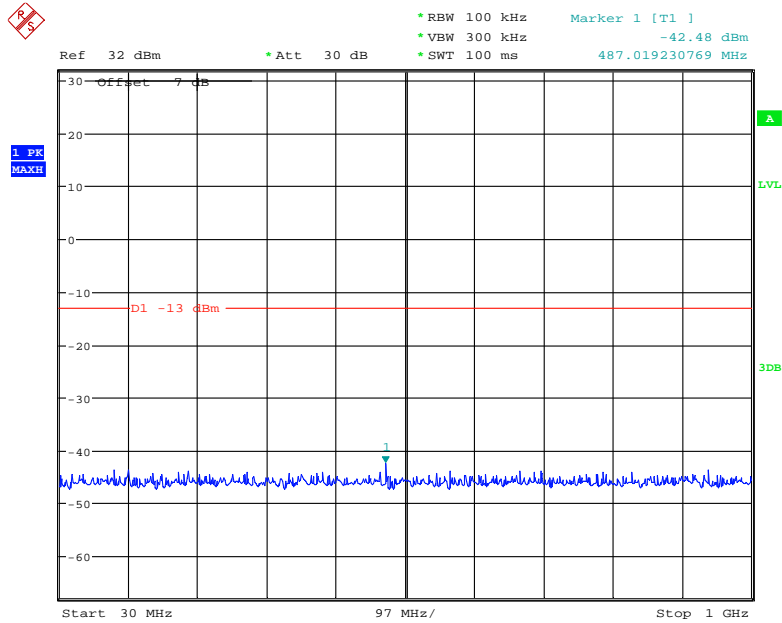

Date: 1.MAY.2021 19:54:58

1 GHz – 20 GHz (WCDMA Mode)

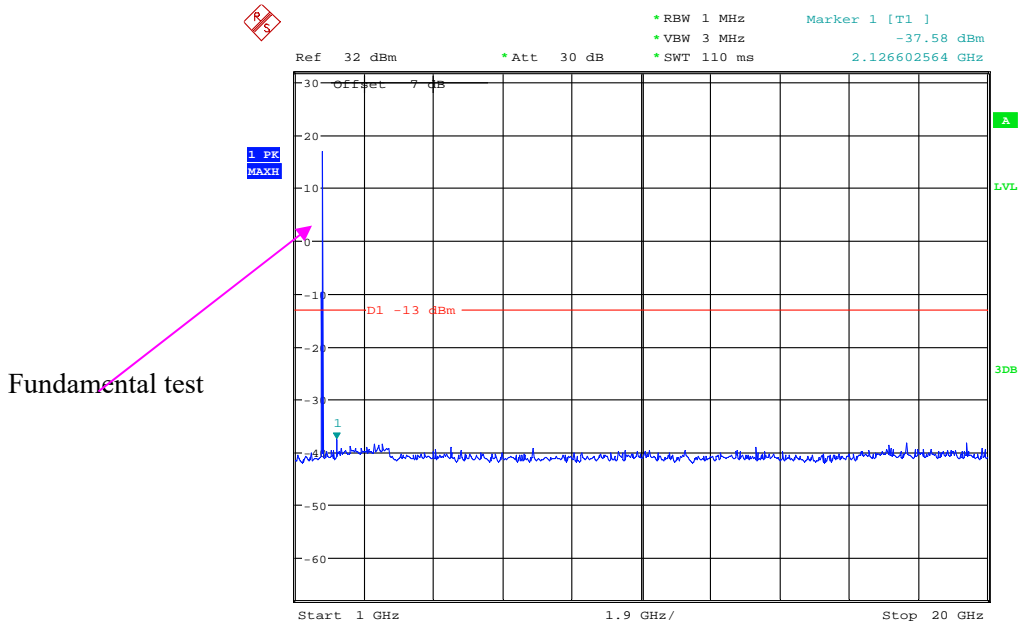

Date: 1.MAY.2021 19:57:13



High Channel:

30 MHz – 1 GHz (WCDMA Mode)

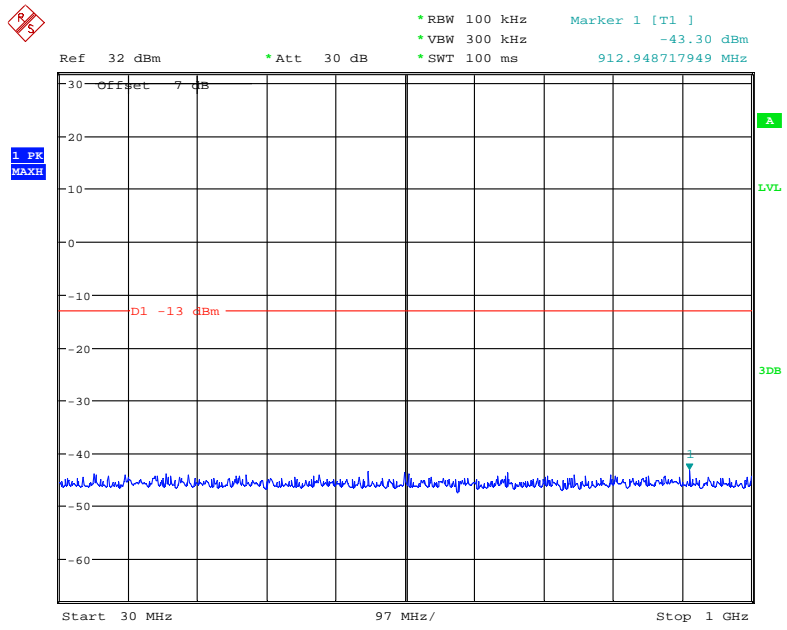

Date: 1.MAY.2021 19:55:23

1 GHz – 20 GHz (WCDMA Mode)

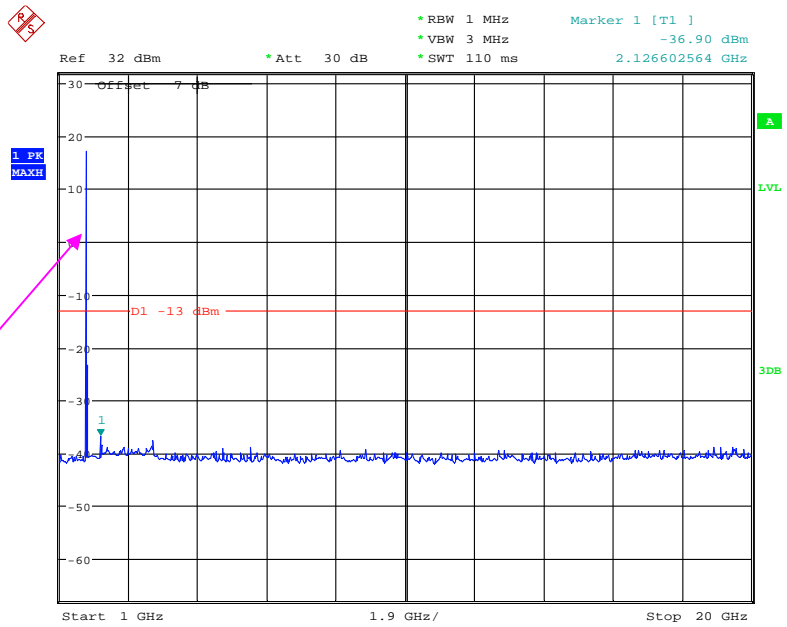

Fundamental test

Date: 1.MAY.2021 19:56:20

The test plots of LTE band please refer to the Appendix B.

**FCC § 2.1053; § 22.917 (a); § 24.238 (a); §27.53 SPURIOUS RADIATED EMISSIONS****Applicable Standard**

FCC § 2.1053, §22.917(a) and § 24.238(a) and § 27.53

**Test Procedure**

The transmitter was placed on a wooden turntable, and it was transmitting into a non-radiating load which was also placed on the turntable.

The measurement antenna was placed at a distance of 3 meters from the EUT. During the tests, the receiving antenna height and polarization as well as EUT azimuth were varied in order to identify the maximum level of emissions from the EUT. The test was performed by placing the EUT on 3-orthogonal axis.

The frequency range up to tenth harmonic of the fundamental frequency was investigated.

**Test Data****Environmental Conditions**

<b>Temperature:</b>	26.8~ 27 °C
<b>Relative Humidity:</b>	51~57 %
<b>ATM Pressure:</b>	101.0~101.2 kPa

*The testing was performed by Cloud Qiu 2021-06-10 for below 1GHz, Alan He on 2021-06-14 for above 1GHz.*

*EUT operation mode: Transmitting*

**30 MHz ~ 10 GHz:**

**Cellular Band (Part 22H)**

Frequency (MHz)	Receiver Reading (dBµV)	Turntable Angle Degree	Rx Antenna		Substituted			Absolute Level (dBm)	FCC Part 22H	
			Height (m)	Polar (H/V)	Level (dBm)	Cable Loss (dB)	Antenna Gain (dBd/dBi)		Limit (dBm)	Margin (dB)
GSM Mode										
Low channel										
965.3	31.69	198	2.0	H	-64.8	1.36	0.0	-66.16	-13	53.16
965.3	32.81	194	1.9	V	-61.2	1.36	0.0	-62.56	-13	49.56
1648.4	51.12	291	1.1	H	-57.0	1.40	8.70	-49.70	-13	36.70
1648.4	50.42	271	1.6	V	-57.4	1.40	8.70	-50.10	-13	37.10
2472.6	60.91	288	1.9	H	-42.4	2.60	10.20	-34.80	-13	21.80
2472.6	57.69	319	1.9	V	-45.1	2.60	10.20	-37.50	-13	24.50
3296.8	44.83	329	2.1	H	-56.1	1.50	11.70	-45.90	-13	32.90
3296.8	44.41	301	1.5	V	-56.5	1.50	11.70	-46.30	-13	33.30
Middle channel										
960.6	31.57	321	1.7	H	-64.9	1.36	0.0	-66.26	-13	53.26
960.6	32.88	75	1.6	V	-61.2	1.36	0.0	-62.56	-13	49.56
1673.2	50.62	356	2.2	H	-55.7	1.30	8.90	-48.10	-13	35.10
1673.2	49.72	228	2.5	V	-56.0	1.30	8.90	-48.40	-13	35.40
2509.8	61.58	246	2.5	H	-41.8	2.60	10.20	-34.20	-13	21.20
2509.8	57.18	31	1.5	V	-45.6	2.60	10.20	-38.00	-13	25.00
3346.4	44.76	36	1.3	H	-56.1	1.50	11.70	-45.90	-13	32.90
3346.4	44.32	341	2.4	V	-56.6	1.50	11.70	-46.40	-13	33.40
High channel										
965.8	31.47	2	1.1	H	-65.0	1.36	0.0	-66.36	-13	53.36
965.8	32.77	318	1.3	V	-61.3	1.36	0.0	-62.66	-13	49.66
1697.6	50.66	248	1.4	H	-55.7	1.30	8.90	-48.10	-13	35.10
1697.6	45.63	140	2.4	V	-60.1	1.30	8.90	-52.50	-13	39.50
2546.4	60.15	347	2.0	H	-43.2	2.60	10.20	-35.60	-13	22.60
2546.4	56.73	44	1.5	V	-46.0	2.60	10.20	-38.40	-13	25.40
3395.2	44.56	305	2.1	H	-56.7	1.40	11.80	-46.30	-13	33.30
3395.2	44.17	255	1.1	V	-56.9	1.40	11.80	-46.50	-13	33.50

Frequency (MHz)	Receiver Reading (dBµV)	Turntable Angle Degree	Rx Antenna		Substituted			Absolute Level (dBm)	FCC Part 22H	
			Height (m)	Polar (H/V)	Level (dBm)	Cable Loss (dB)	Antenna Gain (dBd/dBi)		Limit (dBm)	Margin (dB)
WCDMA Mode										
Low channel										
956.3	31.54	153	1.9	H	-65.0	1.36	0.0	-66.36	-13	53.36
956.3	32.76	356	1.9	V	-61.3	1.36	0.0	-62.66	-13	49.66
1652.80	44.12	346	2.2	H	-62.2	1.30	8.90	-54.60	-13	41.60
1652.80	43.22	80	1.6	V	-62.5	1.30	8.90	-54.90	-13	41.90
2479.20	43.95	297	1.6	H	-59.4	2.60	10.20	-51.80	-13	38.80
2479.20	43.76	152	2.1	V	-59.0	2.60	10.20	-51.40	-13	38.40
3305.60	44.10	99	1.3	H	-56.8	1.50	11.70	-46.60	-13	33.60
3305.60	43.87	282	2.4	V	-57.1	1.50	11.70	-46.90	-13	33.90
Middle channel										
957.6	31.45	355	2.3	H	-65.1	1.36	0.0	-66.46	-13	53.46
957.6	32.67	316	1.2	V	-61.4	1.36	0.0	-62.76	-13	49.76
1673.20	44.86	320	1.3	H	-61.5	1.30	8.90	-53.90	-13	40.90
1673.20	43.76	245	1.3	V	-62.0	1.30	8.90	-54.40	-13	41.40
2509.80	44.15	34	1.4	H	-59.2	2.60	10.20	-51.60	-13	38.60
2509.80	44.07	197	1.9	V	-58.7	2.60	10.20	-51.10	-13	38.10
3346.40	44.63	154	2.1	H	-56.3	1.50	11.70	-46.10	-13	33.10
3346.40	44.37	210	1.5	V	-56.6	1.50	11.70	-46.40	-13	33.40
High channel										
963.8	31.49	42	1.1	H	-65.0	1.36	0.0	-66.36	-13	53.36
963.8	32.78	261	1.4	V	-61.3	1.36	0.0	-62.66	-13	49.66
1693.20	44.34	131	2.0	H	-62.0	1.30	8.90	-54.40	-13	41.40
1693.20	44.18	220	1.7	V	-61.6	1.30	8.90	-54.00	-13	41.00
2539.80	44.86	8	2.1	H	-58.5	2.60	10.20	-50.90	-13	37.90
2539.80	44.23	15	1.9	V	-58.5	2.60	10.20	-50.90	-13	37.90
3386.40	43.88	357	2.3	H	-57.4	1.40	11.80	-47.00	-13	34.00
3386.40	43.57	189	1.9	V	-57.5	1.40	11.80	-47.10	-13	34.10

**30 MHz ~ 20 GHz:**

**PCS Band (Part 24E)**

Frequency (MHz)	Receiver Reading (dBµV)	Turntable Angle Degree	Rx Antenna		Substituted			Absolute Level (dBm)	FCC Part 24E	
			Height (m)	Polar (H/V)	Level (dBm)	Cable Loss (dB)	Antenna Gain (dBd/dBi)		Limit (dBm)	Margin (dB)
GSM Mode										
Low channel										
962.1	31.55	346	1.4	H	-65.0	1.36	0.0	-66.36	-13	53.36
962.1	32.86	45	2.3	V	-61.2	1.36	0.0	-62.56	-13	49.56
3700.4	44.56	122	2.0	H	-57.2	1.60	11.90	-46.90	-13	33.90
3700.4	43.84	357	2.3	V	-57.4	1.60	11.90	-47.10	-13	34.10
Middle channel										
963.2	31.51	200	1.3	H	-65.0	1.36	0.0	-66.36	-13	53.36
963.2	32.81	192	1.5	V	-61.2	1.36	0.0	-62.56	-13	49.56
3760	45.11	174	1.1	H	-56.9	1.50	11.80	-46.60	-13	33.60
3760	44.25	273	1.3	V	-57.3	1.50	11.80	-47.00	-13	34.00
High channel										
962.5	31.62	215	1.6	H	-64.9	1.36	0.0	-66.26	-13	53.26
962.5	32.79	56	2.4	V	-61.3	1.36	0.0	-62.66	-13	49.66
3819.6	44.89	240	1.4	H	-57.2	1.50	11.80	-46.90	-13	33.90
3819.6	44.15	4	1.3	V	-57.4	1.50	11.80	-47.10	-13	34.10
WCDMA Mode										
Low Channel										
956.8	31.64	282	2.3	H	-64.9	1.36	0.0	-66.26	-13	53.26
956.8	32.89	205	2.1	V	-61.2	1.36	0.0	-62.56	-13	49.56
3704.80	44.62	89	2.4	H	-57.2	1.60	11.90	-46.90	-13	33.90
3704.80	44.37	222	2.3	V	-56.9	1.60	11.90	-46.60	-13	33.60
Middle channel										
954.7	31.61	73	2.0	H	-64.9	1.36	0.0	-66.26	-13	53.26
954.7	32.83	14	1.5	V	-61.2	1.36	0.0	-62.56	-13	49.56
3760.00	44.95	314	2.1	H	-57.1	1.50	11.80	-46.80	-13	33.80
3760.00	44.58	188	2.1	V	-57.0	1.50	11.80	-46.70	-13	33.70
High channel										
961.2	31.56	353	2.5	H	-64.9	1.36	0.0	-66.26	-13	53.26
961.2	32.75	85	2.1	V	-61.3	1.36	0.0	-62.66	-13	49.66
3815.20	44.76	19	2.0	H	-57.3	1.50	11.80	-47.00	-13	34.00
3815.20	44.19	98	2.3	V	-57.4	1.50	11.80	-47.10	-13	34.10

**30 MHz ~ 20 GHz:**

**AWS Band**

Frequency (MHz)	Receiver Reading (dBµV)	Turntable Angle Degree	Rx Antenna		Substituted			Absolute Level (dBm)	FCC Part 27	
			Height (m)	Polar (H/V)	Level (dBm)	Cable Loss (dB)	Antenna Gain (dBd/dBi)		Limit (dBm)	Margin (dB)
WCDMA Mode										
Low channel										
953.3	31.51	338	2.5	H	-65.0	1.36	0.0	-66.36	-13	53.36
953.3	32.82	61	1.5	V	-61.2	1.36	0.0	-62.56	-13	49.56
3424.80	45.59	178	1.3	H	-55.2	1.40	11.80	-44.80	-13	31.80
3424.80	44.47	258	1.6	V	-56.1	1.40	11.80	-45.70	-13	32.70
Middle channel										
951.6	31.62	43	1.1	H	-64.9	1.36	0.0	-66.26	-13	53.26
951.6	32.73	29	1.4	V	-61.3	1.36	0.0	-62.66	-13	49.66
3465.20	45.76	228	1.2	H	-55.0	1.50	12.00	-44.50	-13	31.50
3465.20	44.81	285	2.3	V	-56.7	1.50	12.00	-46.20	-13	33.20
High channel										
964.8	31.58	71	1.2	H	-64.9	1.36	0.0	-66.26	-13	53.26
964.8	32.88	149	1.5	V	-61.2	1.36	0.0	-62.56	-13	49.56
3505.20	45.88	117	1.4	H	-54.9	1.50	12.00	-44.40	-13	31.40
3505.20	45.13	303	1.5	V	-56.4	1.50	12.00	-45.90	-13	32.90

**LTE Band:** (Pre-scan with all the bandwidth, and worst case as below)

Frequency (MHz)	Receiver Reading (dBμV)	Turntable Angle Degree	Rx Antenna		Substituted			Absolute Level (dBm)	Limit (dBm)	Margin (dB)
			Height (m)	Polar (H/V)	Level (dBm)	Cable Loss (dB)	Antenna Gain (dBd/dBi)			
Band 2										
Test frequency range: 30 MHz ~ 20 GHz										
1.4MHz, Low channel										
961.6	31.43	267	2.4	H	-65.1	1.36	0.0	-66.46	-13	53.46
961.6	32.84	204	1.9	V	-61.2	1.36	0.0	-62.56	-13	49.56
3701.40	58.21	338	2.0	H	-43.6	1.60	11.90	-33.30	-13	20.30
3701.40	55.23	191	1.9	V	-46.0	1.60	11.90	-35.70	-13	22.70
5552.10	61.28	45	1.1	H	-38.4	1.70	12.40	-27.70	-13	14.70
5552.10	59.88	45	2.1	V	-39.5	1.70	12.40	-28.80	-13	15.80
7402.80	49.13	123	1.8	H	-47.4	2.10	10.60	-38.90	-13	25.90
7402.80	46.94	208	1.8	V	-50.0	2.10	10.60	-41.50	-13	28.50
1.4MHz, Middle channel										
961.3	31.64	172	1.5	H	-64.9	1.36	0.0	-66.26	-13	53.26
961.3	32.91	330	2.4	V	-61.1	1.36	0.0	-62.46	-13	49.46
3760.00	60.20	240	1.1	H	-41.9	1.50	11.80	-31.60	-13	18.60
3760.00	57.09	344	1.3	V	-44.5	1.50	11.80	-34.20	-13	21.20
5640.00	54.77	153	1.2	H	-44.9	1.70	12.40	-34.20	-13	21.20
5640.00	52.41	286	2.3	V	-46.9	1.70	12.40	-36.20	-13	23.20
7520.00	49.35	304	1.8	H	-46.6	1.90	10.70	-37.80	-13	24.80
7520.00	46.54	215	2.1	V	-49.0	1.90	10.70	-40.20	-13	27.20
7520.00	49.35	304	1.8	H	-46.6	1.90	10.70	-37.80	-13	24.80
7520.00	46.54	215	2.1	V	-49.0	1.90	10.70	-40.20	-13	27.20
1.4MHz, High channel										
959.4	31.61	41	1.2	H	-64.9	1.36	0.0	-66.26	-13	53.26
959.4	32.78	253	2.4	V	-61.3	1.36	0.0	-62.66	-13	49.66
3818.60	63.89	55	1.5	H	-38.2	1.50	11.80	-27.90	-13	14.90
3818.60	61.83	210	2.3	V	-39.8	1.50	11.80	-29.50	-13	16.50
5727.90	52.59	126	2.2	H	-47.3	1.60	12.10	-36.80	-13	23.80
5727.90	51.28	129	2.3	V	-48.0	1.60	12.10	-37.50	-13	24.50
7637.20	50.28	83	1.5	H	-47.2	2.10	10.50	-38.80	-13	25.80
7637.20	47.61	344	1.5	V	-49.7	2.10	10.50	-41.30	-13	28.30

Frequency (MHz)	Receiver Reading (dBμV)	Turntable Angle Degree	Rx Antenna		Substituted			Absolute Level (dBm)	Limit (dBm)	Margin (dB)
			Height (m)	Polar (H/V)	Level (dBm)	Cable Loss (dB)	Antenna Gain (dBd/dBi)			
Band 4										
Test frequency range:30 MHz ~ 20 GHz										
1.4MHz, Low channel										
963.9	31.54	54	1.3	H	-65.0	1.36	0.0	-66.36	-13	53.36
963.9	32.69	72	1.7	V	-61.4	1.36	0.0	-62.76	-13	49.76
3421.40	67.54	170	1.3	H	-33.3	1.40	11.80	-22.90	-13	9.90
3421.40	71.25	23	2.3	V	-29.4	1.40	11.80	-19.00	-13	6.00
5132.10	60.78	247	2.0	H	-39.2	1.60	12.10	-28.70	-13	15.70
5132.10	63.27	231	1.1	V	-36.7	1.60	12.10	-26.20	-13	13.20
6842.80	56.82	231	1.8	H	-41.9	1.80	11.20	-32.50	-13	19.50
6842.80	59.66	352	1.7	V	-39.5	1.80	11.20	-30.10	-13	17.10
8553.50	54.24	14	1.6	H	-43.8	2.10	11.40	-34.50	-13	21.50
8553.50	55.25	10	1.6	V	-42.8	2.10	11.40	-33.50	-13	20.50
1.4MHz, Middle channel										
958.6	31.59	13	2.4	H	-64.9	1.36	0.0	-66.26	-13	53.26
958.6	32.74	132	2.1	V	-61.3	1.36	0.0	-62.66	-13	49.66
3465.00	68.24	165	1.2	H	-32.5	1.50	12.00	-22.00	-13	9.00
3465.00	71.15	60	1.8	V	-30.4	1.50	12.00	-19.90	-13	6.90
5197.50	61.37	68	1.6	H	-38.7	1.60	12.10	-28.20	-13	15.20
5197.50	63.29	149	2.4	V	-36.3	1.60	12.10	-25.80	-13	12.80
6930.00	55.88	254	2.3	H	-42.5	1.80	11.30	-33.00	-13	20.00
6930.00	59.53	220	1.9	V	-38.9	1.80	11.30	-29.40	-13	16.40
8662.50	50.27	159	1.5	H	-47.7	2.10	11.40	-38.40	-13	25.40
8662.50	52.18	356	1.2	V	-45.9	2.10	11.40	-36.60	-13	23.60
1.4MHz, High channel										
959.7	31.56	149	1.7	H	-64.9	1.36	0.0	-66.26	-13	53.26
959.7	32.79	131	2.1	V	-61.3	1.36	0.0	-62.66	-13	49.66
3508.60	67.08	302	1.3	H	-33.7	1.50	12.00	-23.20	-13	10.20
3508.60	68.94	35	1.6	V	-32.6	1.50	12.00	-22.10	-13	9.10
5262.90	60.06	191	1.4	H	-39.7	1.60	12.20	-29.10	-13	16.10
5262.90	61.13	204	1.4	V	-38.0	1.60	12.20	-27.40	-13	14.40
7017.20	54.36	52	1.3	H	-44.4	1.90	11.20	-35.10	-13	22.10
7017.20	58.34	237	1.7	V	-40.6	1.90	11.20	-31.30	-13	18.30
8771.50	47.62	269	1.1	H	-49.8	2.10	11.60	-40.30	-13	27.30
8771.50	49.25	339	1.8	V	-47.6	2.10	11.60	-38.10	-13	25.10



Frequency (MHz)	Receiver Reading (dBμV)	Turntable Angle Degree	Rx Antenna		Substituted			Absolute Level (dBm)	Limit (dBm)	Margin (dB)
			Height (m)	Polar (H/V)	Level (dBm)	Cable Loss (dB)	Antenna Gain (dBd/dBi)			
Band 5										
Test frequency range:30 MHz ~ 10 GHz										
1.4MHz, Low channel										
956.8	31.53	180	1.9	H	-65.0	1.36	0.0	-66.36	-13	53.36
956.8	32.86	92	1.5	V	-61.2	1.36	0.0	-62.56	-13	49.56
1649.40	44.25	295	1.0	H	-63.8	1.40	8.70	-56.50	-13	43.50
1649.40	43.97	123	2.5	V	-63.9	1.40	8.70	-56.60	-13	43.60
2474.10	57.79	280	2.2	H	-45.6	2.60	10.20	-38.00	-13	25.00
2474.10	53.84	291	1.9	V	-48.9	2.60	10.20	-41.30	-13	28.30
3298.80	44.13	54	1.7	H	-56.8	1.50	11.70	-46.60	-13	33.60
3298.80	43.76	321	1.4	V	-57.2	1.50	11.70	-47.00	-13	34.00
1.4MHz, Middle channel										
964.7	31.57	151	1.4	H	-64.9	1.36	0.0	-66.26	-13	53.26
964.7	32.77	114	2.0	V	-61.3	1.36	0.0	-62.66	-13	49.66
1673.00	50.14	282	1.1	H	-56.2	1.30	8.90	-48.60	-13	35.60
1673.00	49.57	156	2.2	V	-56.2	1.30	8.90	-48.60	-13	35.60
2509.50	52.91	125	2.2	H	-50.4	2.60	10.20	-42.80	-13	29.80
2509.50	53.33	345	2.4	V	-49.4	2.60	10.20	-41.80	-13	28.80
3346.00	44.37	88	2.2	H	-56.5	1.50	11.70	-46.30	-13	33.30
3346.00	44.76	259	1.1	V	-56.2	1.50	11.70	-46.00	-13	33.00
1.4MHz, High channel										
961.2	31.45	297	1.6	H	-65.1	1.36	0.0	-66.46	-13	53.46
961.2	32.85	327	2.3	V	-61.2	1.36	0.0	-62.56	-13	49.56
1696.60	46.86	306	1.3	H	-59.5	1.30	8.90	-51.90	-13	38.90
1696.60	46.20	198	2.3	V	-59.5	1.30	8.90	-51.90	-13	38.90
2544.90	59.09	182	2.4	H	-44.3	2.60	10.20	-36.70	-13	23.70
2544.90	59.22	96	1.8	V	-43.5	2.60	10.20	-35.90	-13	22.90
3393.20	46.42	111	1.5	H	-54.8	1.40	11.80	-44.40	-13	31.40
3393.20	44.68	123	2.1	V	-56.4	1.40	11.80	-46.00	-13	33.00

Frequency (MHz)	Receiver Reading (dBµV)	Turntable Angle Degree	Rx Antenna		Substituted			Absolute Level (dBm)	Limit (dBm)	Margin (dB)
			Height (m)	Polar (H/V)	Level (dBm)	Cable Loss (dB)	Antenna Gain (dBd/dBi)			
Band 7										
Test frequency range: 30 MHz ~ 26.5 GHz										
5MHz, Low channel										
957.3	31.58	107	1.4	H	-64.9	1.36	0.0	-66.26	-25	41.26
957.3	32.72	180	1.5	V	-61.3	1.36	0.0	-62.66	-25	37.66
5005.00	55.38	118	2.2	H	-45.2	1.70	12.00	-34.90	-25	9.90
5005.00	56.29	188	1.7	V	-43.7	1.70	12.00	-33.40	-25	8.40
7507.50	51.84	316	2.4	H	-44.1	1.90	10.70	-35.30	-25	10.30
7507.50	47.93	186	2.2	V	-47.6	1.90	10.70	-38.80	-25	13.80
10010.00	49.88	11	1.6	H	-46.6	2.40	10.80	-38.20	-25	13.20
10010.00	49.26	66	1.6	V	-47.4	2.40	10.80	-39.00	-25	14.00
12512.50	53.18	13	1.3	H	-43.5	2.60	12.50	-33.60	-25	8.60
12512.50	51.62	270	1.8	V	-45.7	2.60	12.50	-35.80	-25	10.80
5MHz, Middle channel										
957.6	31.55	170	1.3	H	-65.0	1.36	0.0	-66.36	-25	41.36
951.6	32.86	15	2.3	V	-61.2	1.36	0.0	-62.56	-25	37.56
5070.00	56.51	15	2.5	H	-43.5	1.60	12.10	-33.00	-25	8.00
5070.00	57.95	164	2.2	V	-42.1	1.60	12.10	-31.60	-25	6.60
7605.00	52.11	38	1.3	H	-45.4	2.10	10.50	-37.00	-25	12.00
7605.00	49.01	337	2.1	V	-48.3	2.10	10.50	-39.90	-25	14.90
10140.0	50.75	268	2.1	H	-45.7	2.40	10.80	-37.30	-25	12.30
10140.0	50.01	197	1.5	V	-46.7	2.40	10.80	-38.30	-25	13.30
12675.0	53.72	259	2.4	H	-43.5	2.70	12.60	-33.60	-25	8.60
12675.0	51.80	342	1.1	V	-46.2	2.70	12.60	-36.30	-25	11.30
5MHz, High channel										
966.8	31.46	103	2.2	H	-65.0	1.36	0.0	-66.36	-25	41.36
966.8	32.64	47	2.2	V	-61.4	1.36	0.0	-62.76	-25	37.76
5135.00	55.28	224	2.1	H	-44.7	1.60	12.10	-34.20	-25	9.20
5135.00	56.81	77	1.5	V	-43.2	1.60	12.10	-32.70	-25	7.70
7702.50	51.84	209	1.4	H	-45.7	2.10	10.50	-37.30	-25	12.30
7702.50	49.23	120	1.3	V	-48.1	2.10	10.50	-39.70	-25	14.70
10270.00	50.13	250	1.6	H	-46.3	2.60	10.60	-38.30	-25	13.30
10270.00	49.26	128	2.4	V	-46.4	2.60	10.60	-38.40	-25	13.40
12837.50	53.28	335	1.1	H	-45.1	2.70	12.60	-35.20	-25	10.20
12837.50	51.27	255	2.3	V	-48.6	2.70	12.60	-38.70	-25	13.70

Frequency (MHz)	Receiver Reading (dBµV)	Turntable Angle Degree	Rx Antenna		Substituted			Absolute Level (dBm)	Limit (dBm)	Margin (dB)
			Height (m)	Polar (H/V)	Level (dBm)	Cable Loss (dB)	Antenna Gain (dBd/dBi)			
Band 17										
Test frequency range: 30 MHz ~ 10 GHz										
5MHz, Low channel										
962.5	31.39	52	2.2	H	-65.1	1.36	0.0	-66.46	-13	53.46
962.5	32.68	97	2.4	V	-61.4	1.36	0.0	-62.76	-13	49.76
1413.00	51.98	209	2.2	H	-56.2	1.60	7.90	-49.90	-13	36.90
1413.00	46.93	210	1.7	V	-61.5	1.60	7.90	-55.20	-13	42.20
2119.50	56.20	84	1.7	H	-44.9	1.30	9.70	-36.50	-13	23.50
2119.50	53.90	169	1.3	V	-48.1	1.30	9.70	-39.70	-13	26.70
2826.00	44.13	254	2.1	H	-59.8	1.80	10.50	-51.10	-13	38.10
2826.00	43.86	144	1.2	V	-59.8	1.80	10.50	-51.10	-13	38.10
5MHz, Middle channel										
961.7	31.44	27	1.7	H	-65.1	1.36	0.0	-66.46	-13	53.46
961.7	32.71	105	1.9	V	-61.3	1.36	0.0	-62.66	-13	49.66
1420.00	49.80	239	1.6	H	-58.4	1.60	7.90	-52.10	-13	39.10
1420.00	44.99	32	1.3	V	-63.4	1.60	7.90	-57.10	-13	44.10
2130.00	56.57	82	1.7	H	-44.6	1.30	9.70	-36.20	-13	23.20
2130.00	53.09	87	1.1	V	-48.9	1.30	9.70	-40.50	-13	27.50
2840.00	44.37	344	1.2	H	-59.6	1.80	10.50	-50.90	-13	37.90
2840.00	44.02	27	1.1	V	-59.6	1.80	10.50	-50.90	-13	37.90
5MHz, High channel										
963.6	31.47	336	1.1	H	-65.0	1.36	0.0	-66.36	-13	53.36
963.6	32.87	318	1.6	V	-61.2	1.36	0.0	-62.56	-13	49.56
1427.00	48.32	40	1.4	H	-59.9	1.60	7.90	-53.60	-13	40.60
1427.00	44.76	171	1.4	V	-63.7	1.60	7.90	-57.40	-13	44.40
2140.50	55.70	213	1.6	H	-45.4	1.30	9.70	-37.00	-13	24.00
2140.50	51.06	315	2.2	V	-50.9	1.30	9.70	-42.50	-13	29.50
2854.00	44.37	268	1.8	H	-60.3	1.70	10.70	-51.30	-13	38.30
2854.00	44.24	235	1.4	V	-60.5	1.70	10.70	-51.50	-13	38.50

Frequency (MHz)	Receiver Reading (dBµV)	Turntable Angle Degree	Rx Antenna		Substituted			Absolute Level (dBm)	Limit (dBm)	Margin (dB)
			Height (m)	Polar (H/V)	Level (dBm)	Cable Loss (dB)	Antenna Gain (dBd/dBi)			
Band 38										
Test frequency range: 30 MHz ~ 26.5GHz										
5MHz, Low channel										
962.3	31.48	230	1.6	H	-65.0	1.36	0.0	-66.36	-25	41.36
962.3	32.76	169	2.4	V	-61.3	1.36	0.0	-62.66	-25	37.66
5145.00	49.02	218	2.1	H	-51.0	1.60	12.10	-40.50	-25	15.50
5145.00	50.33	201	1.1	V	-49.7	1.60	12.10	-39.20	-25	14.20
7717.50	44.26	4	1.4	H	-53.3	2.10	10.50	-44.90	-25	19.90
7717.50	44.18	87	1.1	V	-53.1	2.10	10.50	-44.70	-25	19.70
10290.00	49.86	34	1.1	H	-46.5	2.60	10.60	-38.50	-25	13.50
10290.00	48.13	287	1.5	V	-47.5	2.60	10.60	-39.50	-25	14.50
12862.50	51.88	91	2.2	H	-46.5	2.70	12.60	-36.60	-25	11.60
12862.50	53.27	324	1.6	V	-46.6	2.70	12.60	-36.70	-25	11.70
5MHz, Middle channel										
959.3	31.43	269	2.1	H	-65.1	1.36	0.0	-66.46	-25	41.46
959.3	32.81	82	2.5	V	-61.2	1.36	0.0	-62.56	-25	37.56
5190.00	48.95	258	1.7	H	-51.1	1.60	12.10	-40.60	-25	15.60
5190.00	50.45	291	2.2	V	-49.2	1.60	12.10	-38.70	-25	13.70
7785.00	44.65	144	1.2	H	-51.6	2.00	10.50	-43.10	-25	18.10
7785.00	44.48	20	2.1	V	-51.7	2.00	10.50	-43.20	-25	18.20
10380.0	50.23	357	1.3	H	-45.2	2.60	10.50	-37.30	-25	12.30
10380.0	48.86	5	2.0	V	-47.1	2.60	10.50	-39.20	-25	14.20
12975.0	52.68	72	1.3	H	-44.5	2.70	12.70	-34.50	-25	9.50
12975.0	53.95	336	1.2	V	-43.4	2.70	12.70	-33.40	-25	8.40
5MHz, High channel										
960.1	31.54	133	1.5	H	-65.0	1.36	0.0	-66.36	-25	41.36
960.1	32.82	262	1.2	V	-61.2	1.36	0.0	-62.56	-25	37.56
5235.00	49.63	249	2.3	H	-50.5	1.60	12.10	-40.00	-25	15.00
5235.00	50.86	343	2.1	V	-48.8	1.60	12.10	-38.30	-25	13.30
7852.50	45.02	57	1.2	H	-51.2	2.00	10.50	-42.70	-25	17.70
7852.50	44.83	5	1.8	V	-51.4	2.00	10.50	-42.90	-25	17.90
10470.00	50.69	229	2.0	H	-44.8	2.60	10.50	-36.90	-25	11.90
10470.00	48.73	32	2.3	V	-47.2	2.60	10.50	-39.30	-25	14.30
13087.50	52.61	272	2.4	H	-44.5	2.70	12.70	-34.50	-25	9.50
13087.50	53.40	358	1.4	V	-43.9	2.70	12.70	-33.90	-25	8.90

Frequency (MHz)	Receiver Reading (dBµV)	Turntable Angle Degree	Rx Antenna		Substituted			Absolute Level (dBm)	Limit (dBm)	Margin (dB)
			Height (m)	Polar (H/V)	Level (dBm)	Cable Loss (dB)	Antenna Gain (dBd/dBi)			
Band 41										
5MHz, Low channel										
963.2	31.33	294	1.8	H	-65.2	1.36	0.0	-66.56	-25	41.56
963.2	32.83	277	2.5	V	-61.2	1.36	0.0	-62.56	-25	37.56
5075.00	49.52	142	2.0	H	-50.5	1.60	12.10	-40.00	-25	15.00
5075.00	50.38	79	1.5	V	-49.6	1.60	12.10	-39.10	-25	14.10
7612.50	44.18	187	2.3	H	-53.3	2.10	10.50	-44.90	-25	19.90
7612.50	43.57	324	1.1	V	-53.7	2.10	10.50	-45.30	-25	20.30
10150.00	49.26	66	2.3	H	-47.1	2.60	10.60	-39.10	-25	14.10
10150.00	49.93	321	2.1	V	-45.7	2.60	10.60	-37.70	-25	12.70
12687.50	51.91	151	1.8	H	-45.3	2.70	12.60	-35.40	-25	10.40
12687.50	53.88	183	1.1	V	-44.1	2.70	12.60	-34.20	-25	9.20
5MHz, Middle Channel										
962.1	31.37	201	2.3	H	-65.1	1.36	0.0	-66.46	-25	41.46
962.1	32.79	268	2.1	V	-61.3	1.36	0.0	-62.66	-25	37.66
5190.00	49.03	173	2.1	H	-51.1	1.60	12.10	-40.60	-25	15.60
5190.00	50.20	101	2.4	V	-49.4	1.60	12.10	-38.90	-25	13.90
7785.00	44.63	302	1.1	H	-51.6	2.00	10.50	-43.10	-25	18.10
7785.00	43.70	109	2.3	V	-52.5	2.00	10.50	-44.00	-25	19.00
10380.00	49.57	264	2.2	H	-45.9	2.60	10.50	-38.00	-25	13.00
10380.00	50.11	130	2.0	V	-45.9	2.60	10.50	-38.00	-25	13.00
12975.00	52.34	91	2.5	H	-44.8	2.70	12.70	-34.80	-25	9.80
12975.00	54.75	87	1.8	V	-42.6	2.70	12.70	-32.60	-25	7.60
5MHz, High Channel										
966.4	31.43	24	2.5	H	-65.1	1.36	0.0	-66.46	-25	41.46
966.4	32.75	207	1.1	V	-61.3	1.36	0.0	-62.66	-25	37.66
5305.00	48.69	99	1.4	H	-51.1	1.60	12.20	-40.50	-25	15.50
5305.00	49.92	8	1.3	V	-49.2	1.60	12.20	-38.60	-25	13.60
7957.50	44.18	205	2.1	H	-53.9	2.10	10.70	-45.30	-25	20.30
7957.50	43.26	314	1.5	V	-54.7	2.10	10.70	-46.10	-25	21.10
10610.00	49.44	119	1.1	H	-46.0	2.60	10.70	-37.90	-25	12.90
10610.00	50.26	206	1.7	V	-44.7	2.60	10.70	-36.60	-25	11.60
13262.50	52.12	128	2.4	H	-45.0	2.70	12.70	-35.00	-25	10.00
13262.50	53.93	273	1.4	V	-43.4	2.70	12.70	-33.40	-25	8.40

**Note:**

Absolute Level = Substituted Level - Cable loss + Antenna Gain

Margin = Limit- Absolute Level

dBd is for the ERP, dBi is for EIRP.

**FCC § 22.917 (a); § 24.238 (a); §27.53(c) (h)(m) - BAND EDGES**

**Applicable Standard**

According to § 22.917(a), the power of any emissions outside of the authorized operating frequency ranges must be attenuated below the transmitting power (P) by a factor of at least  $43 + 10 \log(P)$  dB.

According to §24.238(a), the power of any emissions outside of the authorized operating frequency ranges must be attenuated below the transmitting power (P) by a factor of at least  $43 + 10 \log(P)$  dB.

According to FCC §27.53 (c)(h)(m), the power of any emission outside of the authorized operating frequency ranges must be attenuated below the transmitting power (P) by a factor of at least  $43 + 10 \log(P)$  dB.

**Test Procedure**

The RF output of the transmitter was connected to the input of the spectrum analyzer through sufficient attenuation.

The center of the spectrum analyzer was set to block edge frequency

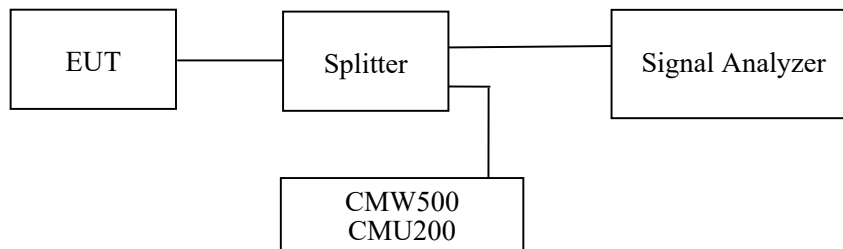

**Test Data**

**Environmental Conditions**

<b>Temperature:</b>	25~28.5 °C
<b>Relative Humidity:</b>	47 ~62 %
<b>ATM Pressure:</b>	101.0 kPa

*The testing was performed by Pedro Yun from 2021-06-08 to 2021-07-24.*

*EUT operation mode: Transmitting (Worst case)*

**Test Result: Pass**

*Please refer to the following plots.*

### Cellular Band, Left Band Edge for GSM (GMSK) Mode

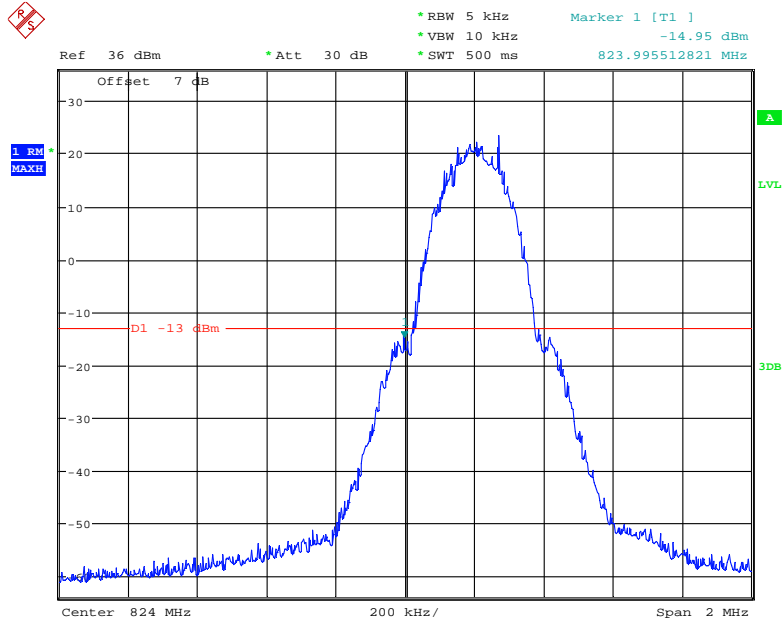

Date: 10.JUL.2021 00:40:03

### Cellular Band, Right Band Edge for GSM (GMSK) Mode

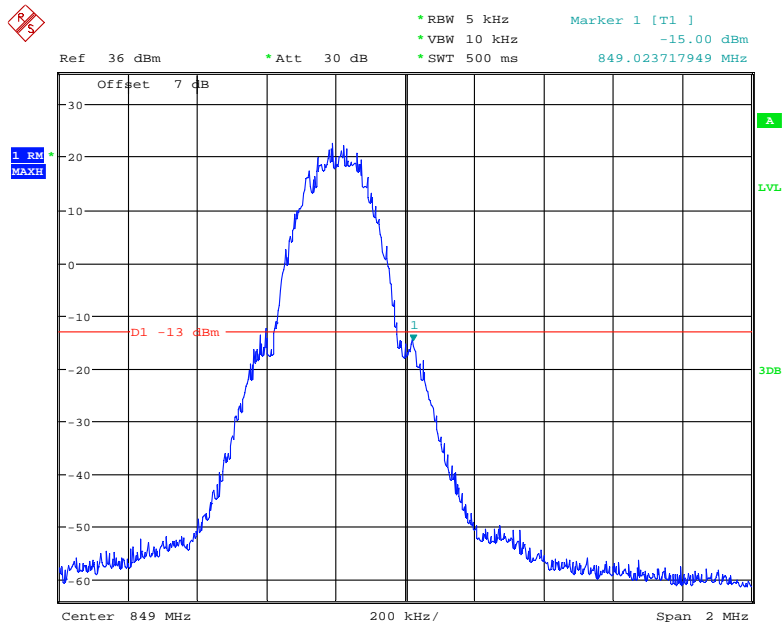

Date: 10.JUL.2021 00:41:14

### Cellular Band, Left Band Edge for EGPRS (8PSK) Mode

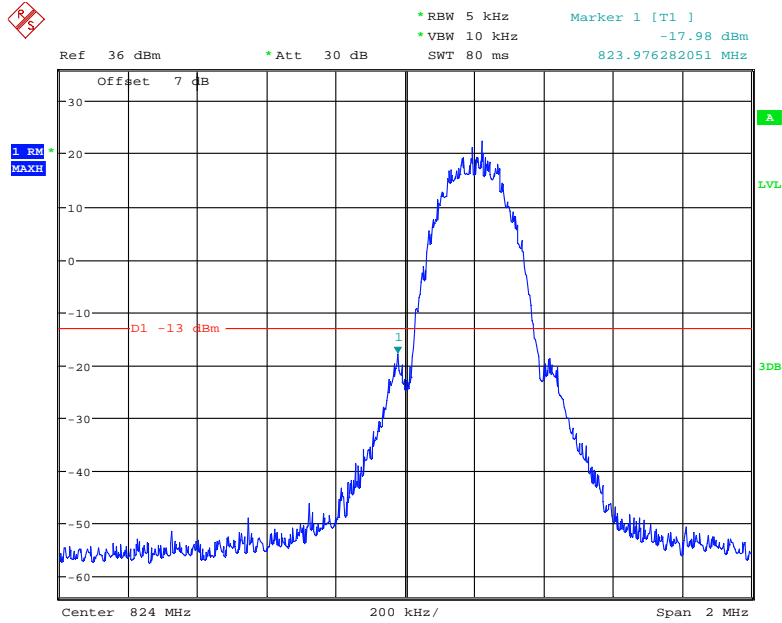

Date: 10.JUL.2021 00:37:28

### Cellular Band, Right Band Edge for EGPRS (8PSK) Mode

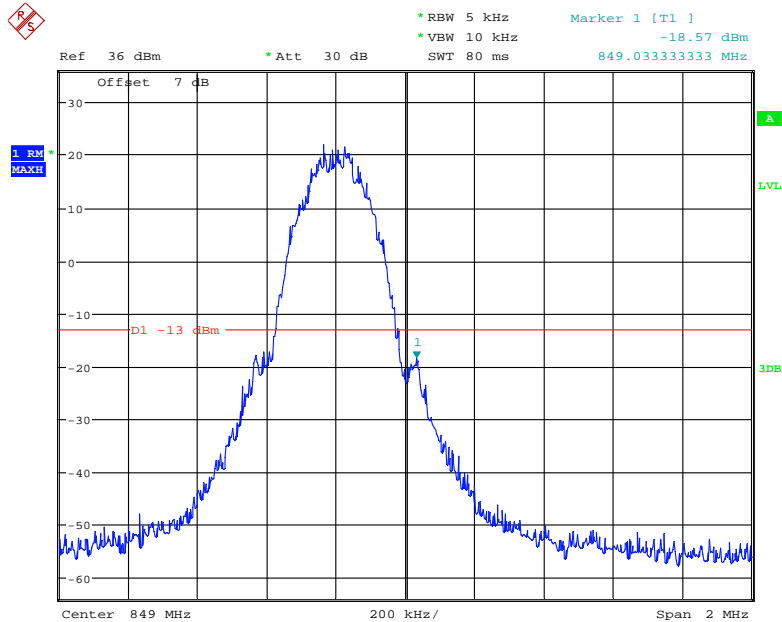

Date: 10.JUL.2021 00:36:20



### Cellular Band, Left Band Edge for RMC (BPSK) Mode

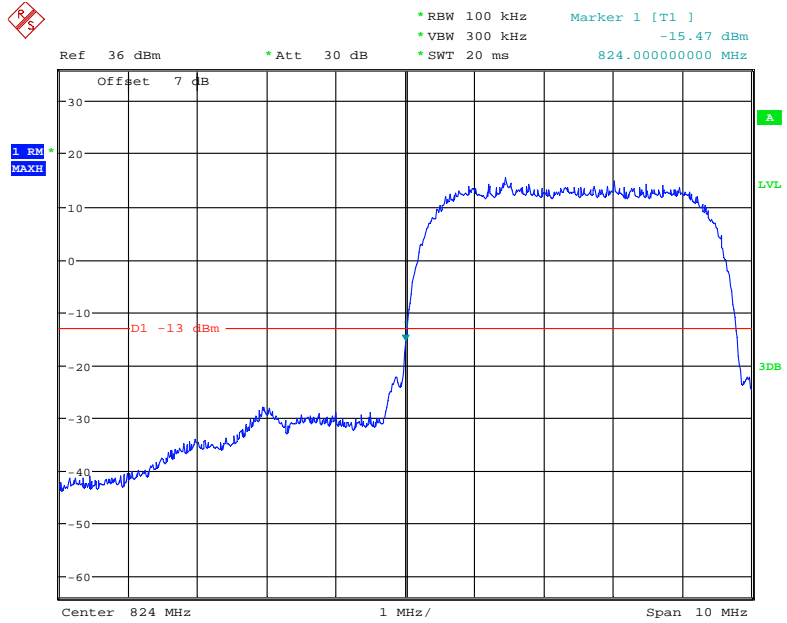

Date: 11.JUL.2021 17:10:19

### Cellular Band, Right Band Edge for RMC (BPSK) Mode

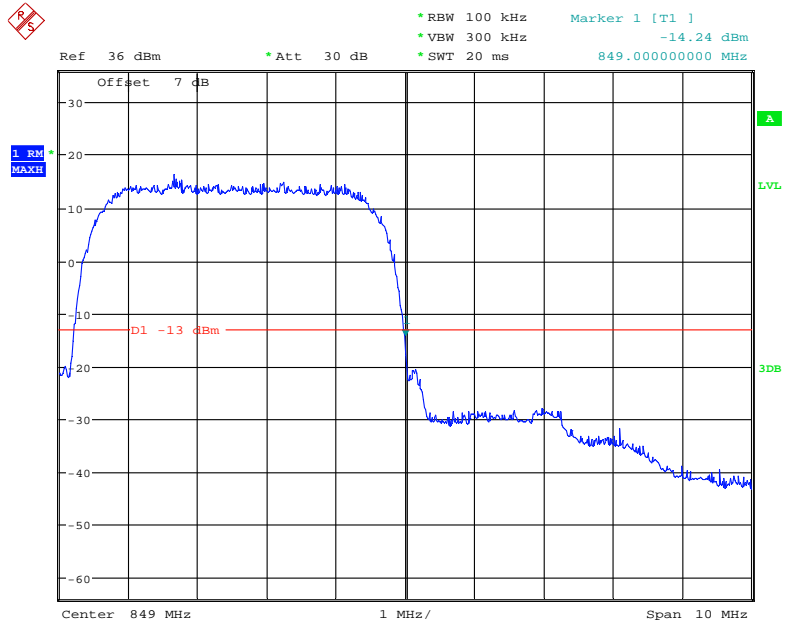

Date: 11.JUL.2021 17:08:13

### Cellular Band, Left Band Edge for HSDPA (16QAM) Mode

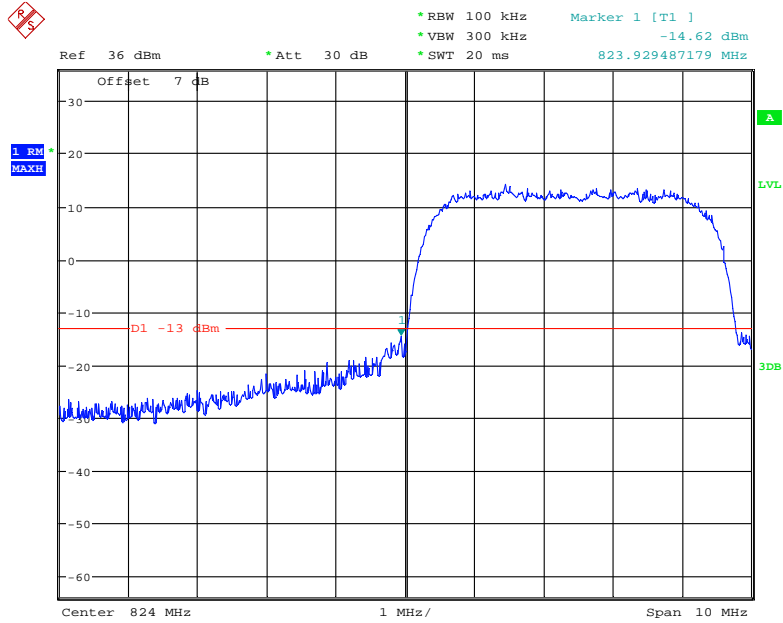

Date: 11.JUL.2021 16:38:18

### Cellular Band, Right Band Edge for HSDPA (16QAM) Mode

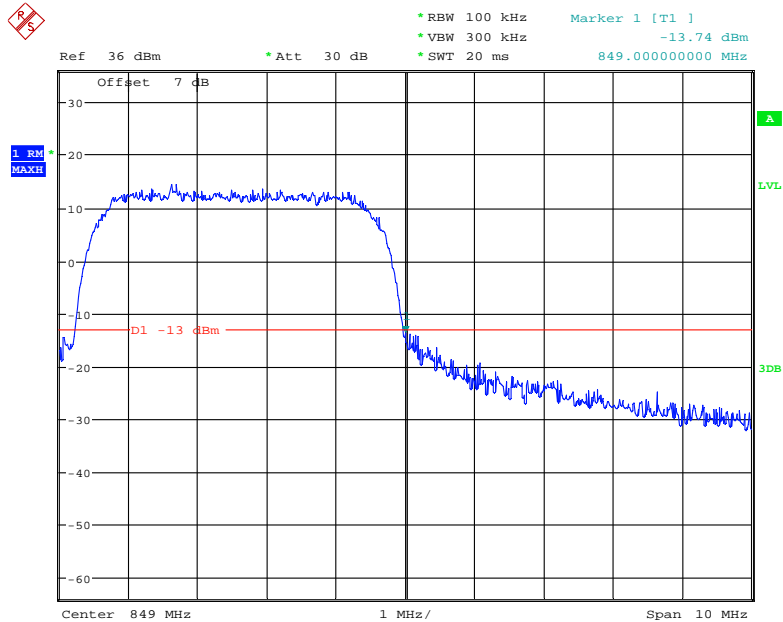

Date: 11.JUL.2021 16:39:17

### Cellular Band, Left Band Edge for HSUPA (BPSK) Mode

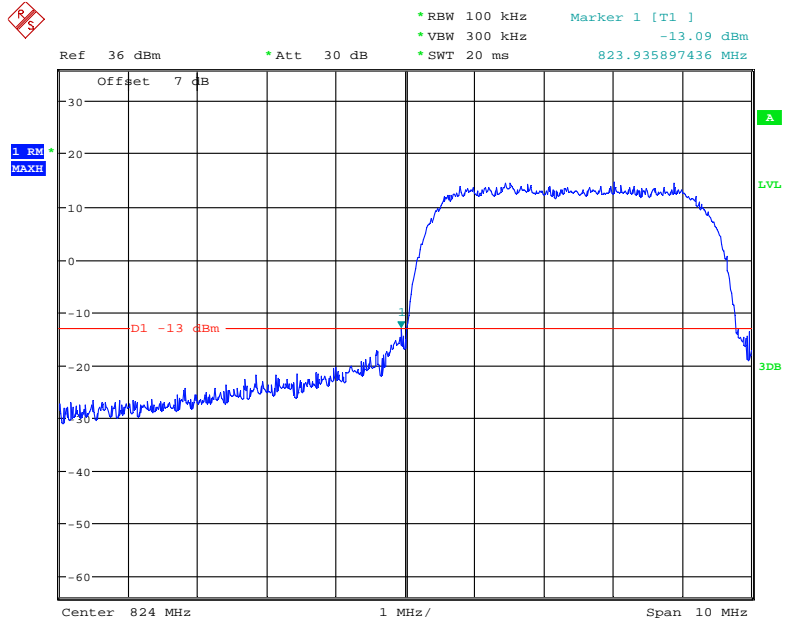

Date: 11.JUL.2021 16:13:13

### Cellular Band, Right Band Edge for HSUPA (BPSK) Mode

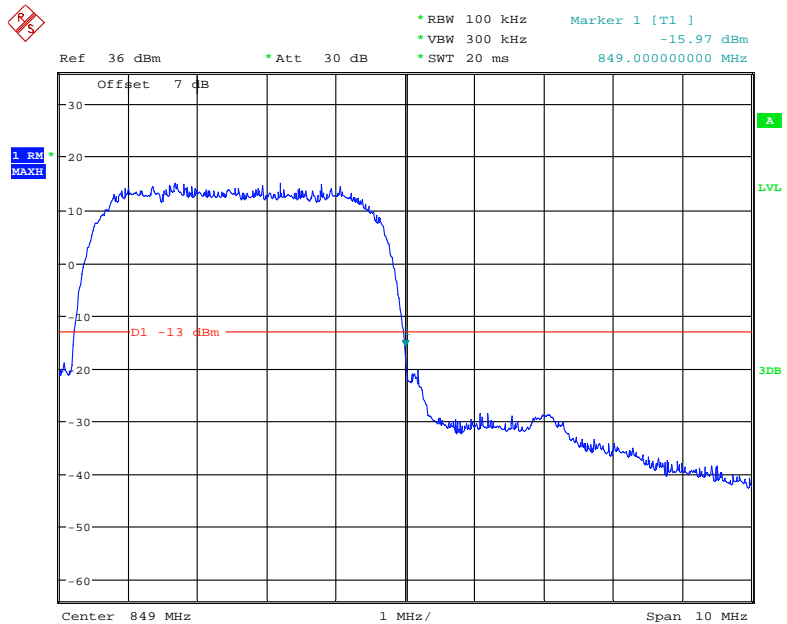

Date: 11.JUL.2021 16:14:33

### PCS Band, Left Band Edge for GSM (GMSK) Mode

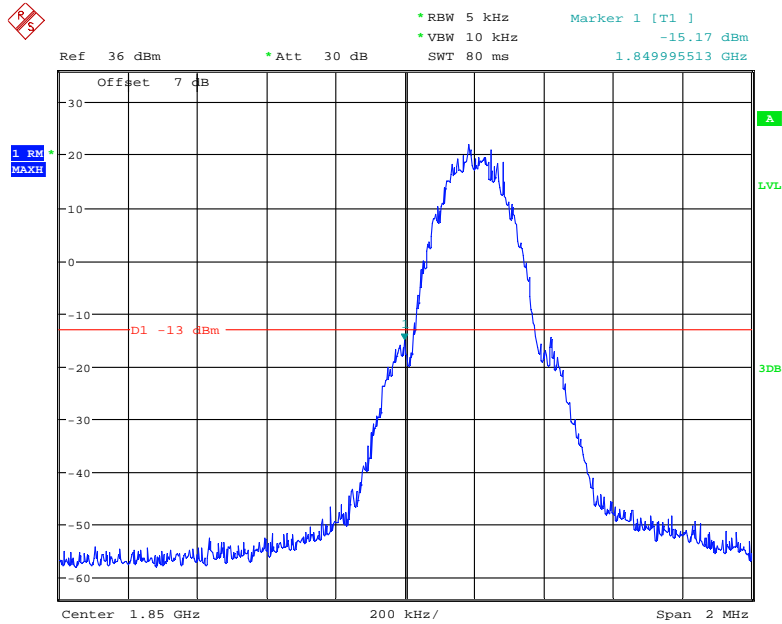

Date: 10.JUL.2021 00:43:19

### PCS Band, Right Band Edge for GSM (GMSK) Mode

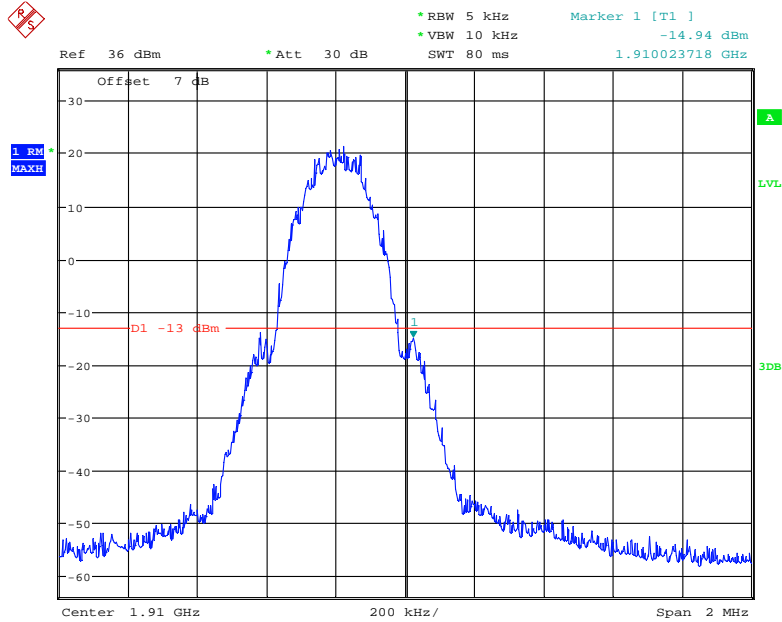

Date: 10.JUL.2021 00:44:12

### PCS Band, Left Band Edge for EGPRS (8PSK) Mode

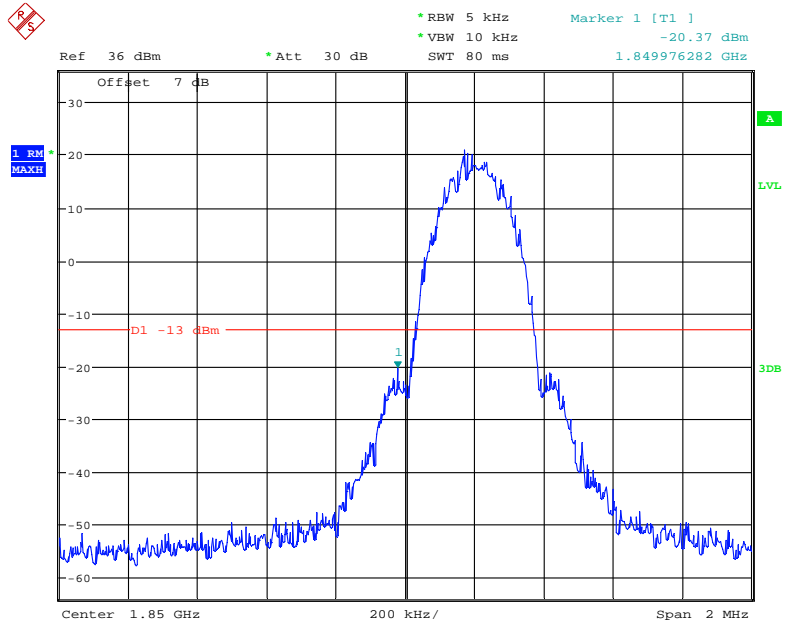

Date: 10.JUL.2021 00:48:22

### PCS Band, Right Band Edge for EGPRS (8PSK) Mode

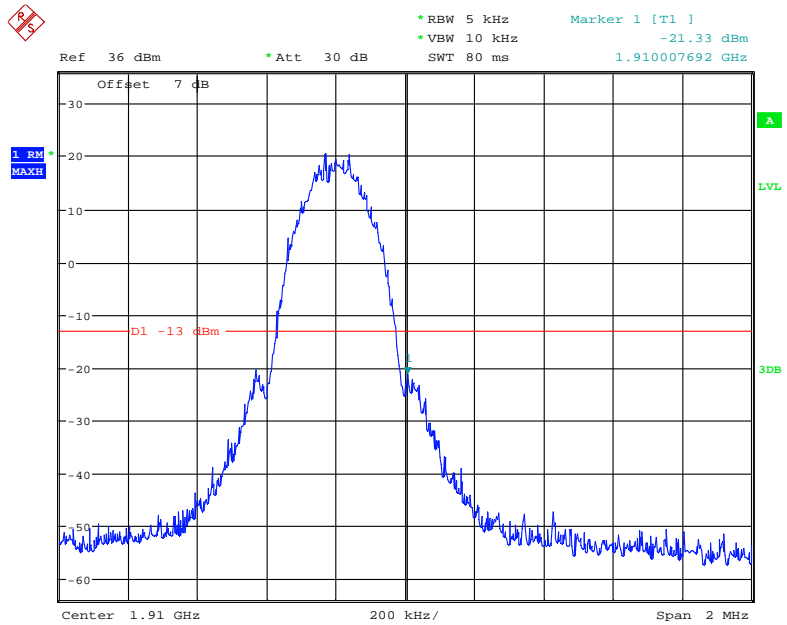

Date: 10.JUL.2021 00:47:11

### PCS Band, Left Band Edge for RMC (BPSK) Mode

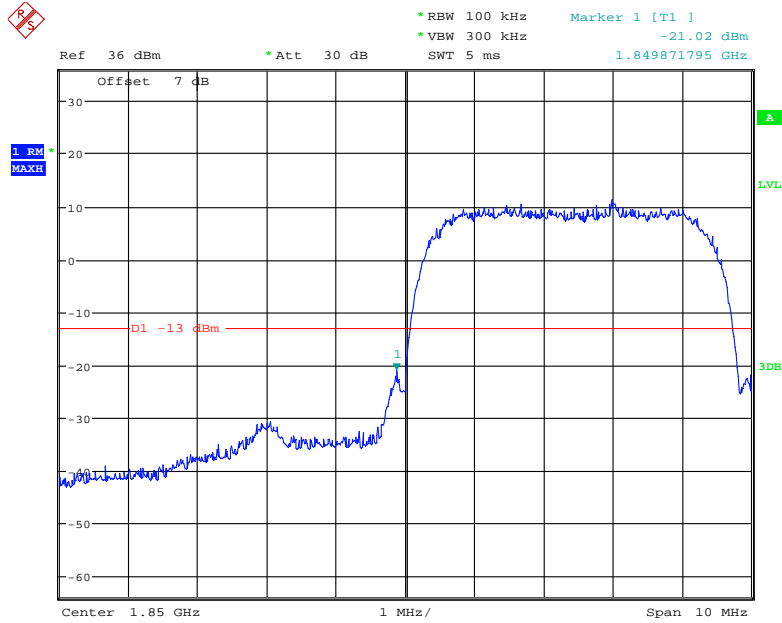

Date: 11.JUL.2021 17:03:36

### PCS Band, Right Band Edge for RMC (BPSK) Mode

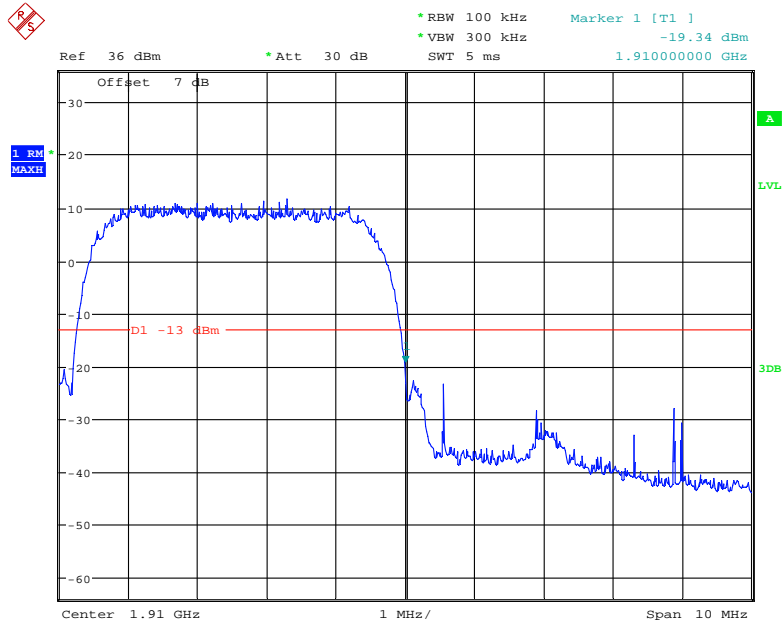

Date: 11.JUL.2021 17:02:08

### PCS Band, Left Band Edge for HSDPA (16QAM) Mode

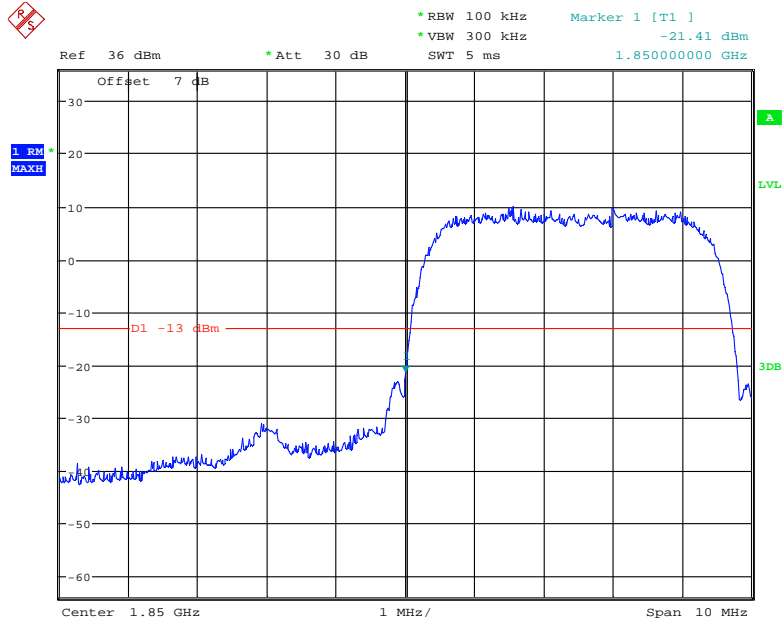

Date: 11.JUL.2021 16:29:23

### PCS Band, Right Band Edge for HSDPA (16QAM) Mode

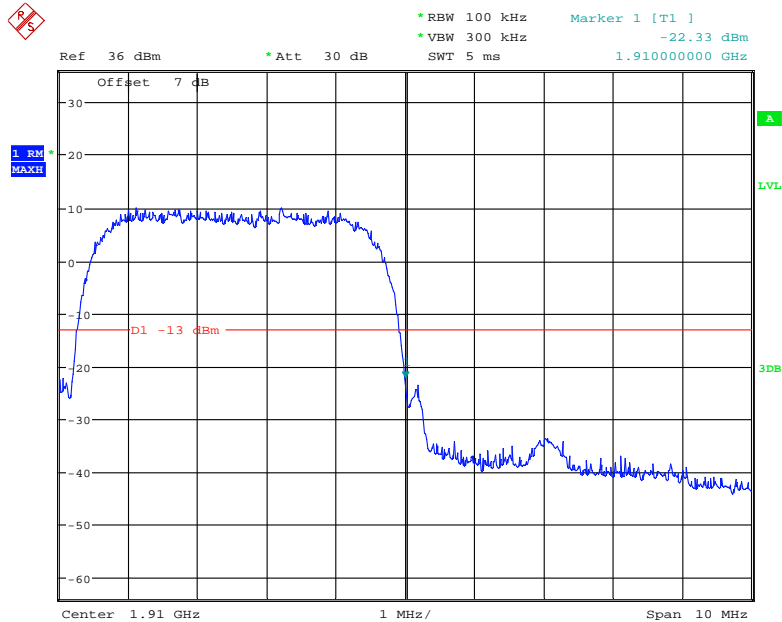

Date: 11.JUL.2021 16:30:25

### PCS Band, Left Band Edge for HSUPA (BPSK) Mode

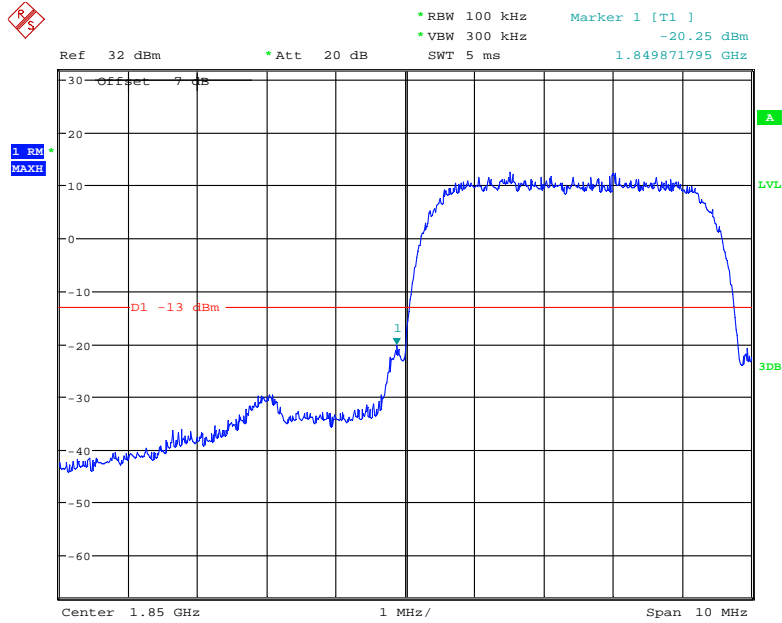

Date: 24.JUL.2021 16:37:04

### PCS Band, Right Band Edge for HSUPA (BPSK) Mode

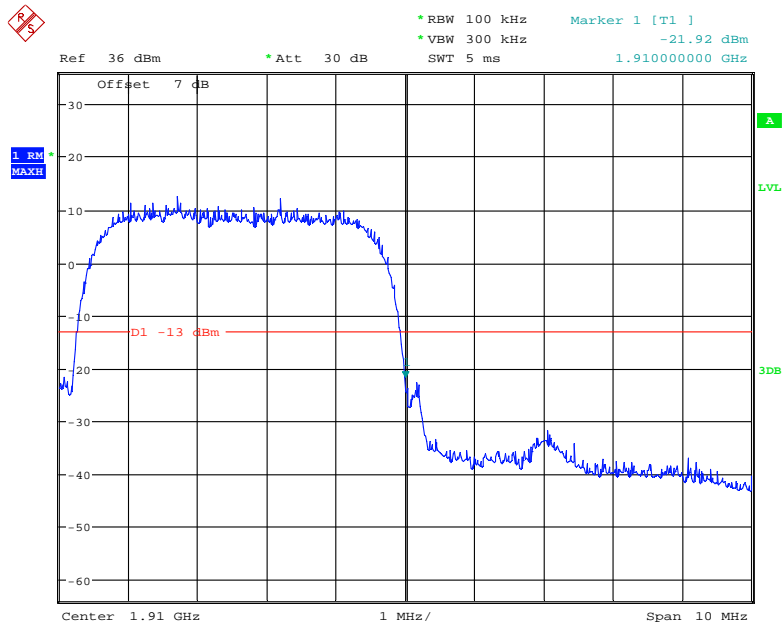

Date: 11.JUL.2021 16:24:18



### AWS Band, Left Band Edge for RMC (BPSK) Mode

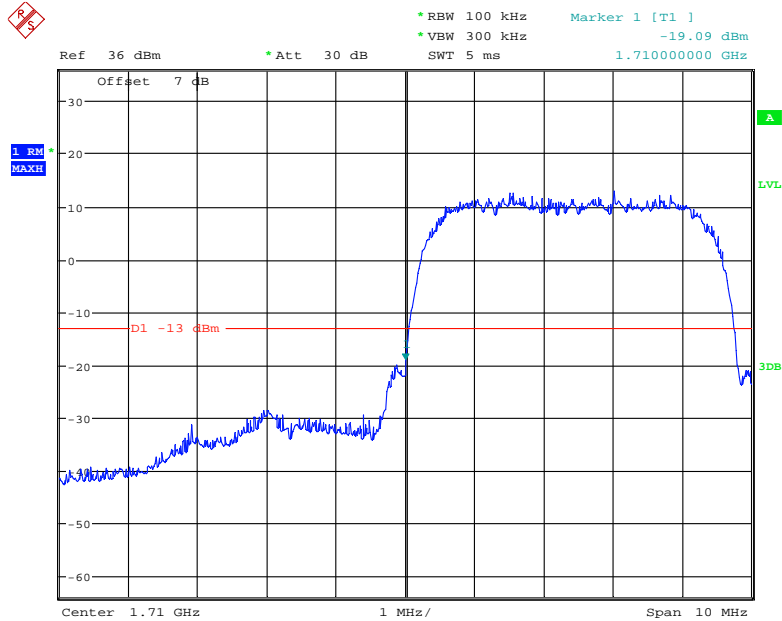

Date: 11.JUL.2021 17:04:42

### AWS Band, Right Band Edge for RMC (BPSK) Mode

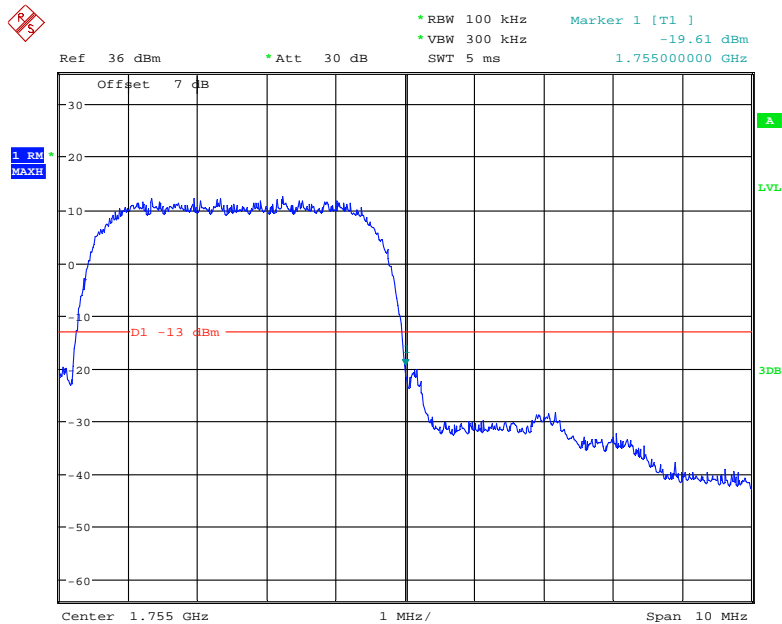

Date: 11.JUL.2021 17:05:46

### AWS Band, Left Band Edge for HSDPA (16QAM) Mode

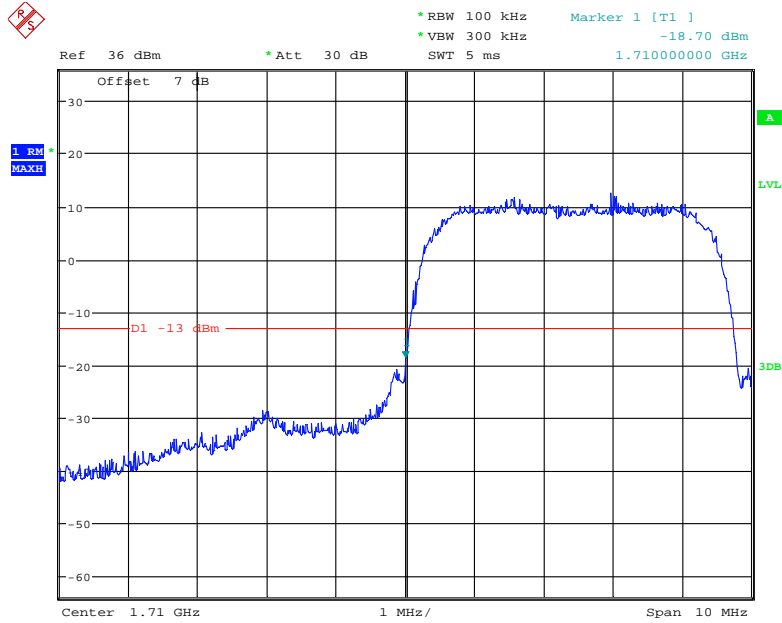

Date: 11.JUL.2021 16:35:39

### AWS Band, Right Band Edge for HSDPA (16QAM) Mode

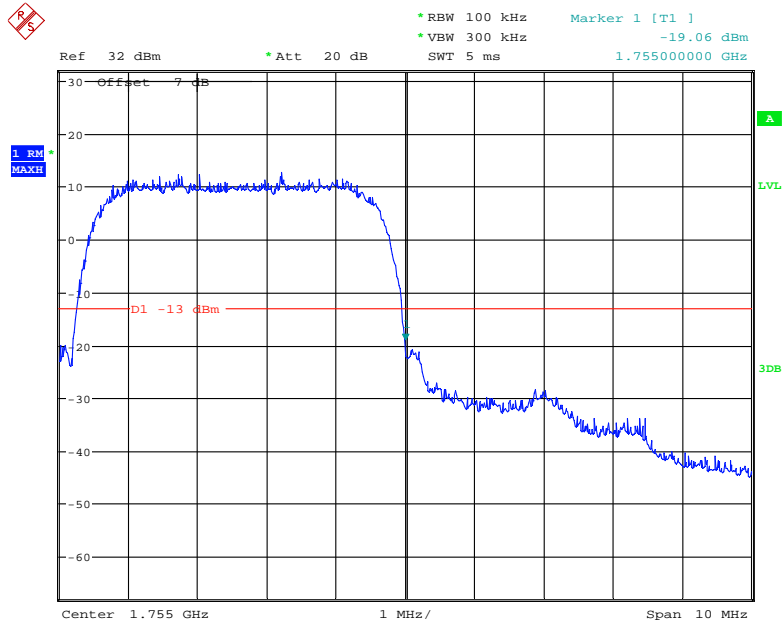

Date: 24.JUL.2021 16:15:35

### AWS Band, Left Band Edge for HSUPA (BPSK) Mode

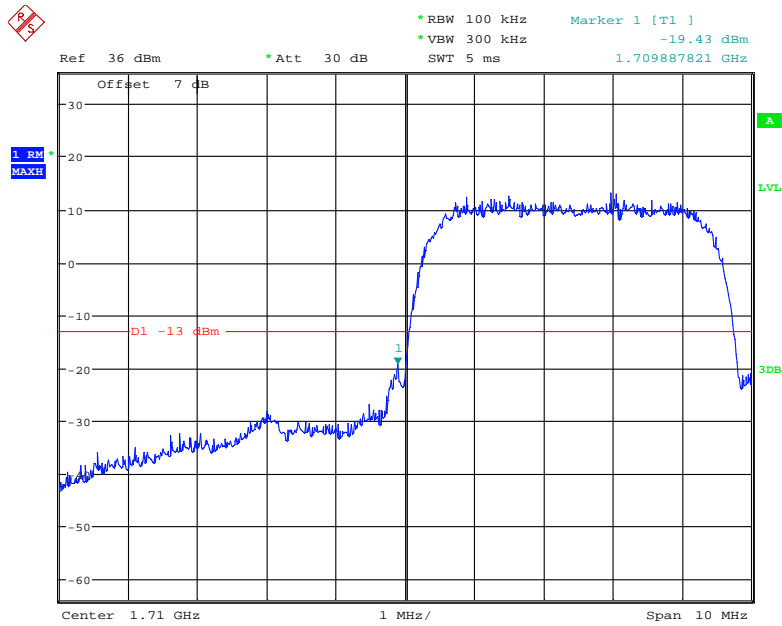

Date: 11.JUL.2021 16:22:33

### AWS Band, Right Band Edge for HSUPA (BPSK) Mode

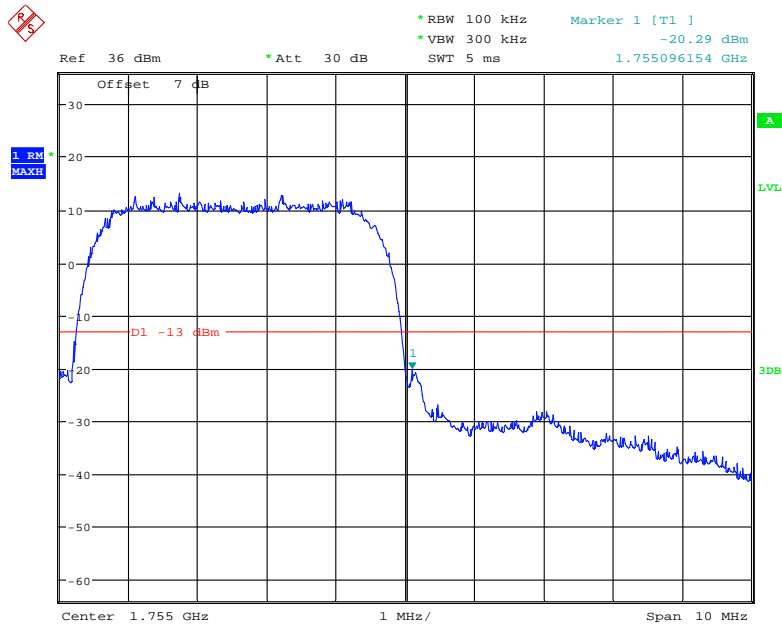

Date: 11.JUL.2021 16:18:34

The test plots of LTE bands please refer to the Appendix C.

**FCC § 2.1055; § 22.355; § 24.235; §27.54 - FREQUENCY STABILITY**

**Applicable Standard**

FCC § 2.1055, §22.355, §24.235 and & §27.54.

According to FCC §2.1055, the frequency stability shall be sufficient to ensure that the fundamental emissions stay within the authorized bands of operation.

According to §22.355, the carrier frequency of each transmitter in the Public Mobile Services must be maintained within the tolerances given in Table below:

Frequency Tolerance for Transmitters in the Public Mobile Services

Frequency Range (MHz)	Base, fixed (ppm)	Mobile ≤ 3 watts (ppm)	Mobile > 3 watts (ppm)
25 to 50	20.0	20.0	50.0
50 to 450	5.0	5.0	50.0
450 to 512	2.5	5.0	5.0
821 to 896	1.5	2.5	2.5
928 to 929.	5.0	N/A	N/A
929 to 960.	1.5	N/A	N/A
2110 to 2220	10.0	N/A	N/A

According to §24.235, the frequency stability shall be sufficient to ensure that the fundamental emissions stays within the authorized frequency block.

**Test Procedure**

Frequency Stability vs. Temperature: The equipment under test was connected to an external DC power supply and the RF output was connected to communication test set via feed-through attenuators. The EUT was placed inside the temperature chamber. The DC leads and RF output cable exited the chamber through an opening made for the purpose.

After the temperature stabilized for approximately 20 minutes, the frequency output was recorded from the communication test set.

Frequency Stability vs. Voltage: For hand carried, battery powered equipment; reduce primary supply voltage to the battery operating end point which shall be specified by the manufacturer.

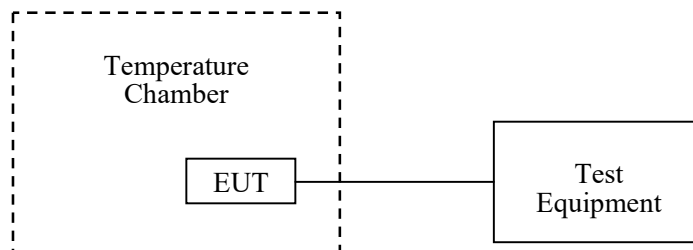

**Test Data**

**Environmental Conditions**

<b>Temperature:</b>	25~28.5 °C
<b>Relative Humidity:</b>	47 ~62 %
<b>ATM Pressure:</b>	101.0 kPa

The testing was performed by Pedro Yun and from 2021-07-09 to 2021-07-19.  
 EUT operation mode: Transmitting

**Test Result: Pass**

Please refer to the following tables.

**Cellular Band (Part 22H)**

**GSM Mode**

Middle Channel, $f_0 = 836.6\text{MHz}$				
Temperature (°C)	Voltage Supplied (V <sub>DC</sub> )	Frequency Error (Hz)	Frequency Error (ppm)	Limit (ppm)
-30	NV	7	0.0084	2.5
-20		3	0.0036	2.5
-10		6	0.0072	2.5
0		2	0.0024	2.5
10		4	0.0048	2.5
20		8	0.0096	2.5
30		6	0.0072	2.5
40		5	0.0060	2.5
50		4	0.0048	2.5
20		LV	3	0.0036
	HV	1	0.0012	2.5

**EDGE Mode**

<b>Middle Channel, <math>f_0 = 836.6\text{MHz}</math></b>				
<b>Temperature (°C)</b>	<b>Voltage Supplied (V<sub>DC</sub>)</b>	<b>Frequency Error (Hz)</b>	<b>Frequency Error (ppm)</b>	<b>Limit (ppm)</b>
-30	NV	4	0.0048	2.5
-20		5	0.0060	2.5
-10		5	0.0060	2.5
0		4	0.0048	2.5
10		5	0.0060	2.5
20		5	0.0060	2.5
30		8	0.0096	2.5
40		6	0.0072	2.5
50		5	0.0060	2.5
20	LV	5	0.0060	2.5
	HV	3	0.0036	2.5

**WCDMA Mode**

<b>Middle Channel, <math>f_0 = 836.6\text{MHz}</math></b>				
<b>Temperature (°C)</b>	<b>Voltage Supplied (V<sub>DC</sub>)</b>	<b>Frequency Error (Hz)</b>	<b>Frequency Error (ppm)</b>	<b>Limit (ppm)</b>
-30	NV	-10	-0.0120	2.5
-20		1	0.0012	2.5
-10		-3	-0.0036	2.5
0		-7	-0.0084	2.5
10		-12	-0.0143	2.5
20		-11	-0.0131	2.5
30		6	0.0072	2.5
40		2	0.0024	2.5
50		1	0.0012	2.5
20	LV	4	0.0048	2.5
	HV	3	0.0036	2.5

**PCS Band (Part 24E)**

**GSM Mode**

Middle Channel, $f_0 = 1880.0$ MHz				
Temperature (°C)	Voltage Supplied (V <sub>DC</sub> )	Frequency Error (Hz)	Frequency Error (ppm)	Result
-30	NV	-5	-0.0027	pass
-20		4	0.0021	pass
-10		2	0.0011	pass
0		-4	-0.0021	pass
10		-2	-0.0011	pass
20		-6	-0.0032	pass
30		-7	-0.0037	pass
40		-6	-0.0032	pass
50		-3	-0.0016	pass
20		LV	-4	-0.0021
	HV	-5	-0.0027	pass

**EDGE Mode**

Middle Channel, $f_0 = 1880.0$ MHz				
Temperature (°C)	Voltage Supplied (V <sub>DC</sub> )	Frequency Error (Hz)	Frequency Error (ppm)	Result
-30	NV	-6	-0.0032	pass
-20		-7	-0.0037	pass
-10		-4	-0.0021	pass
0		-6	-0.0032	pass
10		-4	-0.0021	pass
20		-7	-0.0037	pass
30		-2	-0.0011	pass
40		-5	-0.0027	pass
50		-3	-0.0016	pass
20		LV	-2	-0.0011
	HV	-5	-0.0027	pass

**WCDMA Mode**

Middle Channel, $f_0 = 1880.0$ MHz				
Temperature (°C)	Voltage Supplied (V <sub>DC</sub> )	Frequency Error (Hz)	Frequency Error (ppm)	Result
-30	NV	-2	-0.0011	pass
-20		-5	-0.0027	pass
-10		-9	-0.0048	pass
0		8	0.0043	pass
10		-6	-0.0032	pass
20		-10	-0.0053	pass
30		1	0.0005	pass
40		4	0.0021	pass
50		-5	-0.0027	pass
20		LV	5	0.0027
	HV	-5	-0.0027	pass

**AWS Band (Part 27)**

Temperature (°C)	Power Supplied (V <sub>DC</sub> )	F <sub>L</sub> (MHz)	F <sub>H</sub> (MHz)	F <sub>L</sub> Limit (MHz)	F <sub>H</sub> Limit (MHz)
-30	NV	1710.0144	1754.9718	1710	1755
-20		1710.0164	1754.9773	1710	1755
-10		1710.0103	1754.9756	1710	1755
0		1710.0142	1754.9754	1710	1755
10		1710.0124	1754.9728	1710	1755
20		1710.0122	1754.9725	1710	1755
30		1710.0146	1754.9711	1710	1755
40		1710.0160	1754.9757	1710	1755
50		1710.0103	1754.9732	1710	1755
20		LV	1710.0139	1754.9710	1710
	HV	1710.0171	1754.9719	1710	1755



LTE:  
QPSK:

Band 2:

10.0 MHz Middle Channel, $f_0=1880\text{MHz}$				
Temperature (°C)	Voltage Supplied (V <sub>DC</sub> )	Frequency Error (Hz)	Frequency Error (ppm)	Result
-30	NV	-5.78	-0.0031	pass
-20		-9.85	-0.0052	pass
-10		-6.23	-0.0033	pass
0		6.29	0.0033	pass
10		7.88	0.0042	pass
20		6.65	0.0035	pass
30		-6.46	-0.0034	pass
40		7.29	0.0039	pass
50		-9.53	-0.0051	pass
20		LV	-8.36	-0.0044
	HV	-7.15	-0.0038	pass

Band 4:

10 MHz Bandwidth					
Temperature (°C)	Power Supplied (V <sub>DC</sub> )	F <sub>L</sub> (MHz)	F <sub>H</sub> (MHz)	F <sub>L</sub> Limit (MHz)	F <sub>H</sub> Limit (MHz)
-30	NV	1710.3748	1754.4669	1710	1755
-20		1710.1540	1754.4882	1710	1755
-10		1710.3975	1754.5281	1710	1755
0		1710.0560	1754.8620	1710	1755
10		1710.3262	1754.6057	1710	1755
20		1710.3246	1754.3940	1710	1755
30		1710.1962	1754.5956	1710	1755
40		1710.3490	1754.4978	1710	1755
50		1710.2590	1754.5505	1710	1755
20		LV	1710.2999	1754.5483	1710
	HV	1710.4820	1754.5563	1710	1755

**Band 5:**

10.0 MHz Middle Channel, $f_0=836.5\text{MHz}$				
Temperature (°C)	Voltage Supplied (V <sub>DC</sub> )	Frequency Error (Hz)	Frequency Error (ppm)	Limit (ppm)
-30	NV	-8.84	-0.0106	2.5
-20		9.26	0.0111	2.5
-10		8.52	0.0102	2.5
0		-7.24	-0.0087	2.5
10		-5.38	-0.0064	2.5
20		7.16	0.0086	2.5
30		-5.79	-0.0069	2.5
40		5.56	0.0066	2.5
50		6.92	0.0083	2.5
20		LV	9.76	0.0117
	HV	9.91	0.0118	2.5

**Band 7:**

10 MHz Bandwidth					
Temperature (°C)	Power Supplied (V <sub>DC</sub> )	F <sub>L</sub> (MHz)	F <sub>H</sub> (MHz)	F <sub>L</sub> Limit (MHz)	F <sub>H</sub> Limit (MHz)
-30	NV	2500.3918	2569.5110	2500	2570
-20		2500.1662	2569.4379	2500	2570
-10		2500.4729	2569.5763	2500	2570
0		2500.6617	2569.7118	2500	2570
10		2500.4815	2569.6612	2500	2570
20		2500.4750	2569.6384	2500	2570
30		2500.6216	2569.3721	2500	2570
40		2500.4717	2569.9382	2500	2570
50		2500.3249	2569.6058	2500	2570
20		LV	2500.4924	2569.4544	2500
	HV	2500.2667	2569.2568	2500	2570

**Band 17:**

10 MHz Bandwidth					
Temperature (°C)	Power Supplied (V <sub>DC</sub> )	F <sub>L</sub> (MHz)	F <sub>H</sub> (MHz)	F <sub>L</sub> Limit (MHz)	F <sub>H</sub> Limit (MHz)
-30	NV	704.4478	715.3795	704	716
-20		704.4495	715.3100	704	716
-10		704.4721	715.5749	704	716
0		704.5521	715.3605	704	716
10		704.1836	715.3940	704	716
20		704.4770	715.4317	704	716
30		704.5543	715.4694	704	716
40		704.5503	715.7499	704	716
50		704.5530	715.4796	704	716
20	LV	704.5761	715.5895	704	716

**Band 38:**

10 MHz Bandwidth					
Temperature (°C)	Power Supplied (V <sub>DC</sub> )	F <sub>L</sub> (MHz)	F <sub>H</sub> (MHz)	F <sub>L</sub> Limit (MHz)	F <sub>H</sub> Limit (MHz)
-30	NV	2570.6144	2619.7148	2570	2620
-20		2570.6088	2619.7020	2570	2620
-10		2570.3385	2619.6096	2570	2620
0		2570.5606	2619.4199	2570	2620
10		2570.0047	2619.7944	2570	2620
20		2570.2265	2619.5812	2570	2620
30		2570.5096	2619.8415	2570	2620
40		2570.5092	2619.6749	2570	2620
50		2570.5083	2619.7342	2570	2620
20	LV	2570.2280	2619.8457	2570	2620
	HV	2570.0488	2619.9854	2570	2620

**Band 41**

10 MHz Bandwidth					
Temperature (°C)	Power Supplied (V <sub>DC</sub> )	F <sub>L</sub> (MHz)	F <sub>H</sub> (MHz)	F <sub>L</sub> Limit (MHz)	F <sub>H</sub> Limit (MHz)
-30	NV	2535.4283	2654.5420	2535	2655
-20		2535.4805	2654.8821	2535	2655
-10		2535.3385	2654.6096	2535	2655
0		2535.2047	2654.7398	2535	2655
10		2535.5088	2654.7752	2535	2655
20		2535.3283	2654.4637	2535	2655
30		2535.4084	2654.4885	2535	2655
40		2535.3974	2654.4455	2535	2655
50		2535.3941	2654.6234	2535	2655
20	LV	2535.6323	2654.3806	2535	2655
	HV	2535.3509	2654.7235	2535	2655

Note: the frequency range 2535-2655MHz was declared by applicant.

**16QAM:**

**Band 2:**

10.0 MHz Middle Channel, $f_o = 1880\text{MHz}$				
Temperature (°C)	Voltage Supplied (V <sub>DC</sub> )	Frequency Error (Hz)	Frequency Error (ppm)	Result
-30	NV	-7	-0.0037	pass
-20		-6	-0.0032	pass
-10		12	0.0064	pass
0		-4	-0.0021	pass
10		7	0.0037	pass
20		-8	-0.0043	pass
30		-5	-0.0027	pass
40		-4	-0.0021	pass
50		10	0.0053	pass
20		LV	9	0.0048
	HV	11	0.0059	pass

**Band 4:**

10 MHz Bandwidth					
Temperature (°C)	Power Supplied (V <sub>DC</sub> )	F <sub>L</sub> (MHz)	F <sub>H</sub> (MHz)	F <sub>L</sub> Limit (MHz)	F <sub>H</sub> Limit (MHz)
-30	NV	1710.0464	1754.6367	1710	1755
-20		1710.2598	1754.5474	1710	1755
-10		1710.5072	1754.5642	1710	1755
0		1710.4068	1754.4863	1710	1755
10		1710.5097	1754.8358	1710	1755
20		1710.2744	1754.6456	1710	1755
30		1710.4473	1754.5646	1710	1755
40		1710.5614	1754.8298	1710	1755
50		1710.6572	1754.4647	1710	1755
20		LV	1710.2998	1754.8798	1710
	HV	1710.4945	1754.2520	1710	1755

**Band 5:**

10.0 MHz Middle Channel, $f_0=836.5\text{MHz}$				
Temperature (°C)	Voltage Supplied (V <sub>DC</sub> )	Frequency Error (Hz)	Frequency Error (ppm)	Limit (ppm)
-30	NV	-3.68	-0.0044	2.5
-20		6.92	0.0083	2.5
-10		-9.68	-0.0116	2.5
0		-8.32	-0.0099	2.5
10		-8.87	-0.0106	2.5
20		-9.15	-0.0109	2.5
30		8.42	0.0101	2.5
40		6.61	0.0079	2.5
50		-5.65	-0.0068	2.5
20		LV	8.78	0.0105
	HV	-7.85	-0.0094	2.5

**Band 7:**

10 MHz Bandwidth					
Temperature (°C)	Power Supplied (V <sub>DC</sub> )	F <sub>L</sub> (MHz)	F <sub>H</sub> (MHz)	F <sub>L</sub> Limit (MHz)	F <sub>H</sub> Limit (MHz)
-30	NV	2500.4326	2569.1351	2500	2570
-20		2500.6402	2569.4927	2500	2570
-10		2500.5102	2569.5386	2500	2570
0		2500.3244	2569.7585	2500	2570
10		2500.5305	2569.7396	2500	2570
20		2500.2616	2569.4174	2500	2570
30		2500.7492	2569.7725	2500	2570
40		2500.1979	2569.3558	2500	2570
50		2500.7209	2569.5023	2500	2570
20		LV	2500.8783	2569.4603	2500
	HV	2500.3013	2569.4462	2500	2570

**Band 17:**

10 MHz Bandwidth					
Temperature (°C)	Power Supplied (V <sub>DC</sub> )	F <sub>L</sub> (MHz)	F <sub>H</sub> (MHz)	F <sub>L</sub> Limit (MHz)	F <sub>H</sub> Limit (MHz)
-30	NV	704.6681	715.6569	704	716
-20		704.4448	715.6886	704	716
-10		704.4721	715.5749	704	716
0		704.4354	715.6000	704	716
10		704.0687	715.5625	704	716
20		704.5237	715.5592	704	716
30		704.2994	715.6689	704	716
40		704.7169	715.4866	704	716
50		704.2790	715.3885	704	716
20	LV	704.3387	715.0983	704	716
	HV	704.5853	715.7103	704	716

**Band 38**

10 MHz Bandwidth					
Temperature (°C)	Power Supplied (V <sub>DC</sub> )	F <sub>L</sub> (MHz)	F <sub>H</sub> (MHz)	F <sub>L</sub> Limit (MHz)	F <sub>H</sub> Limit (MHz)
-30	NV	2570.4150	2619.6901	2570	2620
-20		2570.4734	2619.7384	2570	2620
-10		2570.3385	2619.6096	2570	2620
0		2570.2251	2619.8238	2570	2620
10		2570.4140	2619.8792	2570	2620
20		2570.3164	2619.4936	2570	2620
30		2570.3534	2619.5412	2570	2620
40		2570.2216	2619.8780	2570	2620
50		2570.4695	2619.7116	2570	2620
20		LV	2570.3453	2619.0201	2570
	HV	2570.3092	2619.3252	2570	2620

**Band 41**

10 MHz Bandwidth					
Temperature (°C)	Power Supplied (V <sub>DC</sub> )	F <sub>L</sub> (MHz)	F <sub>H</sub> (MHz)	F <sub>L</sub> Limit (MHz)	F <sub>H</sub> Limit (MHz)
-30	NV	2535.0559	2654.8049	2535	2655
-20		2535.4804	2654.8073	2535	2655
-10		2535.3385	2654.6096	2535	2655
0		2535.0110	2654.6804	2535	2655
10		2535.2028	2654.6917	2535	2655
20		2535.4406	2654.4597	2535	2655
30		2535.4617	2654.3627	2535	2655
40		2535.2993	2654.5477	2535	2655
50		2535.7563	2654.6563	2535	2655
20		LV	2535.5058	2654.4692	2535
	HV	2535.0865	2654.8176	2535	2655

Note: the frequency range 2535-2655MHz was declared by applicant.

**\*\*\*\*\* END OF REPORT \*\*\*\*\***