



FCC PART 27  
FCC PART 22H, PART 24E  
TEST REPORT

For

**TECNO MOBILE LIMITED**

FLAT 39 8/F BLOCK D WAH LOK INDUSTRIAL CENTRE 31-35 SHAN MEI STREET  
FOTAN NT Hong Kong

**FCC ID: 2ADYY-KF6**

<b>Report Type:</b> Original Report	<b>Product Type:</b> Mobile phone
<b>Report Number:</b> SZ1210205-04282E-00E	
<b>Report Date:</b> 2021-04-13	
<b>Reviewed By:</b> RF Engineer	Jimmy Xiao
<b>Prepared By:</b> Bay Area Compliance Laboratories Corp. (Shenzhen) 5F(B-West) ,6F,7F,the 3rd Phase of Wan Li Industrial Building D,Shihua Rd, FuTian Free Trade Zone, Shenzhen, China Tel: +86-755-33320018 Fax: +86-755-33320008 <a href="http://www.baclcorp.com.cn">www.baclcorp.com.cn</a>	

**Note:** This report may contain data that are not covered by the A2LA accreditation and are marked with an asterisk “★”.

BACL is not responsible for the authenticity of any test data provided by the applicant. Data included from the applicant that may affect test results are marked with an asterisk “\*”. Customer model name, addresses, names, trademarks etc. are not considered data.

This report cannot be reproduced except in full, without prior written approval of the Company. Unless otherwise stated the results shown in this test report refer only to the sample(s) tested. This report is valid only with a valid digital signature. The digital signature may be available only under the Adobe software above version 7.0.

## TABLE OF CONTENTS

<b>GENERAL INFORMATION.....</b>	<b>3</b>
PRODUCT DESCRIPTION FOR EQUIPMENT UNDER TEST (EUT).....	3
OBJECTIVE.....	3
TEST METHODOLOGY.....	4
MEASUREMENT UNCERTAINTY.....	4
TEST FACILITY.....	4
<b>SYSTEM TEST CONFIGURATION.....</b>	<b>5</b>
DESCRIPTION OF TEST CONFIGURATION.....	5
EQUIPMENT MODIFICATIONS.....	6
SUPPORT EQUIPMENT LIST AND DETAILS.....	6
SUPPORT CABLE DESCRIPTION.....	6
BLOCK DIAGRAM OF TEST SETUP.....	7
<b>SUMMARY OF TEST RESULTS.....</b>	<b>8</b>
<b>TEST EQUIPMENT LIST.....</b>	<b>9</b>
<b>FCC §1.1307(B) &amp; §2.1093 - RF EXPOSURE INFORMATION.....</b>	<b>11</b>
APPLICABLE STANDARD.....	11
TEST RESULT.....	11
<b>FCC §2.1047 - MODULATION CHARACTERISTIC.....</b>	<b>12</b>
<b>FCC § 2.1046, § 22.913 (A) &amp; § 24.232 (C); §27.50 (C) (D) (H) - RF OUTPUT POWER.....</b>	<b>13</b>
APPLICABLE STANDARD.....	13
TEST PROCEDURE.....	13
TEST DATA.....	14
<b>FCC §2.1049, §22.917, §22.905 &amp; §24.238 &amp; §27.53 - OCCUPIED BANDWIDTH.....</b>	<b>46</b>
APPLICABLE STANDARD.....	46
TEST PROCEDURE.....	46
TEST DATA.....	46
<b>FCC §2.1051, §22.917(A) &amp; §24.238(A); §27.53 - SPURIOUS EMISSIONS AT ANTENNA TERMINALS.....</b>	<b>78</b>
APPLICABLE STANDARD.....	78
TEST PROCEDURE.....	78
TEST DATA.....	78
<b>FCC § 2.1053; § 22.917 (A);§ 24.238 (A); §27.53 SPURIOUS RADIATED EMISSIONS.....</b>	<b>96</b>
APPLICABLE STANDARD.....	96
TEST PROCEDURE.....	96
TEST DATA.....	96
<b>FCC § 22.917 (A);§ 24.238 (A); §27.53(C) (H)(M) - BAND EDGES.....</b>	<b>105</b>
APPLICABLE STANDARD.....	105
TEST PROCEDURE.....	105
TEST DATA.....	106
<b>FCC § 2.1055; § 22.355; § 24.235; §27.54 - FREQUENCY STABILITY.....</b>	<b>120</b>
APPLICABLE STANDARD.....	120
TEST PROCEDURE.....	120
TEST DATA.....	121

## GENERAL INFORMATION

### Product Description for Equipment under Test (EUT)

Product	Mobile phone
Tested Model	KF6
Frequency Range	EGSM 850: 824-849MHz(TX); 869-894MHz(RX) PCS 1900: 1850-1910MHz(TX); 1930-1990MHz(RX) WCDMA Band 2: 1850-1910MHz(TX); 1930-1990MHz(RX) WCDMA Band 4: 1710-1755MHz(TX); 2110-2155MHz(RX) WCDMA Band 5: 824-849MHz(TX); 869-894MHz(RX) LTE Band 2: 1850-1910MHz(TX); 1930-1990MHz(RX) LTE Band 4: 1710-1755MHz(TX); 2110-2155MHz(RX) LTE Band 5: 824-849MHz(TX); 869-894MHz(RX) LTE Band 7: 2500-2570MHz(TX); 2620-2690MHz(RX) LTE Band 17: 704-716MHz(TX); 734-746MHz(RX) LTE Band 38: 2570-2620MHz(TX/RX) LTE Band 41: 2535-2655MHz(TX/RX) LTE Band 66: 1710-1780MHz(TX); 2110-2180MHz(RX)
Modulation Technique	2G: GMSK, 8PSK 3G: BPSK, QPSK, 16QAM 4G: QPSK, 16QAM
Antenna Specification*	EGSM850/WCDMA Band 5/LTE Band 5: -1.6dBi PCS1900/WCDMA Band 2/ LTE Band 2: -0.7dBi WCDMA Band 4/ LTE Band 4/ LTE Band 66: -0.7dBi LTE Band 7/LTE Band 38/LTE Band 41: -0.4dBi LTE Band 17: -1.9dBi (provided by the applicant)
Voltage Range	DC 3.87V from battery or DC 5.0V from adapter
Date of Test	2021-02-19 to 2021-04-13
Sample serial number	SZ1210205-04282E-RF-S1(RE&CE Test) , SZ1210205-04282E-RF-S2(RF Test) (Assigned by BAEL, Shenzhen)
Received date	2021-02-05
Sample/EUT Status	Good condition
Adapter information	Model: U100TSA Input: AC 100-240V, 50/60Hz, 0.3A Output: DC 5.0V, 2.0A

### Objective

This test report is in accordance with Part 2-Subpart J, Part 22-Subpart H and Part 24-Subpart E and Subpart 27 of the Federal Communication Commissions rules.

The objective is to determine the compliance of the EUT with FCC rules for output power, modulation characteristic, occupied bandwidth, and spurious emission at antenna terminal, spurious radiated emission, frequency stability and band edge.

## Test Methodology

All tests and measurements indicated in this document were performed in accordance with the Code of Federal Regulations Title 47 Part 2-Subpart J as well as the following parts:

Part 22 Subpart H - Public Mobile Services  
 Part 24 Subpart E - Personal Communication Services  
 Part 27 – Miscellaneous wireless communications services

ANSI C63.26-2015: American National Standard for Compliance Testing of Transmitters Used in Licensed Radio Services

All emissions measurement was performed at Bay Area Compliance Laboratories Corp. (Shenzhen). The radiated testing was performed at an antenna-to-EUT distance of 3 meters.

## Measurement Uncertainty

Parameter		Uncertainty
Occupied Channel Bandwidth		±5%
RF output power, conducted		±0.73dB
Unwanted Emission, conducted		±1.6dB
Emissions, Radiated	Below 1GHz	±4.75dB
	Above 1GHz	±4.88dB
Temperature		±1°C
Humidity		±6%
Supply voltages		±0.4%

*Note: The extended uncertainty given in this report is obtained by combining the standard uncertainty times the coverage factor K with the 95% confidence interval. Otherwise required by the applicant or Product Regulations, Decision Rule in this report did not consider the uncertainty.*

## Test Facility

The Test site used by Bay Area Compliance Laboratories Corp. (Shenzhen) to collect test data is located on the 5F(B-West), 6F, 7F, the 3rd Phase of Wan Li Industrial Building D, Shihua Rd, FuTian Free Trade Zone, Shenzhen, China.

The test site has been approved by the FCC under the KDB 974614 D01 and is listed in the FCC Public Access Link (PAL) database, FCC Registration No.: 342867, the FCC Designation No.: CN1221.

The test site has been registered with ISED Canada under ISED Canada Registration Number 3062B.

## SYSTEM TEST CONFIGURATION

### Description of Test Configuration

The final qualification test was performed with the EUT operating at normal mode.

Test was performed as below table:

Frequency band	Bandwidth (MHz)	Test Frequency(MHz)		
		Low	Middle	High
EGSM850	0.25	824.2	836.6	848.8
DCS1900	0.25	1850.2	1880	1909.8
WCDMA B2	4.2	1852.4	1880	1907.6
WCDMA B4	4.2	1712.4	1732.6	1752.6
WCDMA B5	4.2	826.4	836.6	846.6
LTE B2	1.4	1850.7	1880	1909.3
	3	1851.5	1880	1908.5
	5	1852.5	1880	1907.5
	10	1855	1880	1905
	15	1857.5	1880	1902.5
	20	1860	1880	1900
LTE B4	1.4	1710.7	1732.5	1754.3
	3	1711.5	1732.5	1753.5
	5	1712.5	1732.5	1752.5
	10	1715	1732.5	1750
	15	1717.5	1732.5	1747.5
	20	1720	1732.5	1745
LTE B5	1.4	824.7	836.5	848.3
	3	825.5	836.5	847.5
	5	826.5	836.5	846.5
	10	829	836.5	844
LTE B7	5	2502.5	2535	2567.5
	10	2505	2535	2565
	15	2507.5	2535	2562.5
	20	2510	2535	2560
LTE B17	5	706.5	710	713.5
	10	709	710	711
LTE B38	5	2572.5	2595	2617.5
	10	2575	2595	2615
	15	2577.5	2595	2612.5
	20	2580	2595	2610

Frequency band	Bandwidth (MHz)	Test Frequency(MHz)		
		Low	Middle	High
LTE B41	5	2537.5	2593	2652.5
	10	2540	2593	2650
	15	2542.5	2593	2647.5
	20	2545	2593	2645
LTE B66	1.4	1710.7	1745	1779.3
	3	1711.5	1745	1778.5
	5	1712.5	1745	1777.5
	10	1715	1745	1775
	15	1717.5	1745	1772.5
	20	1720	1745	1770

**Equipment Modifications**

No modification was made to the EUT.

**Support Equipment List and Details**

Manufacturer	Description	Model	Serial Number
Rohde & Schwarz	Wideband Radio Communication Tester	CMW500	1201.002K50-116218-U
Rohde & Schwarz	Universal Radio Communication Tester	CMU200	115500

**Support Cable Description**

Cable Description	Length (m)	From / Port	To
Un-shielded Un-detachable AC cable	1.2	AC Power	CMW500/ CMU200

**Block Diagram of Test Setup**

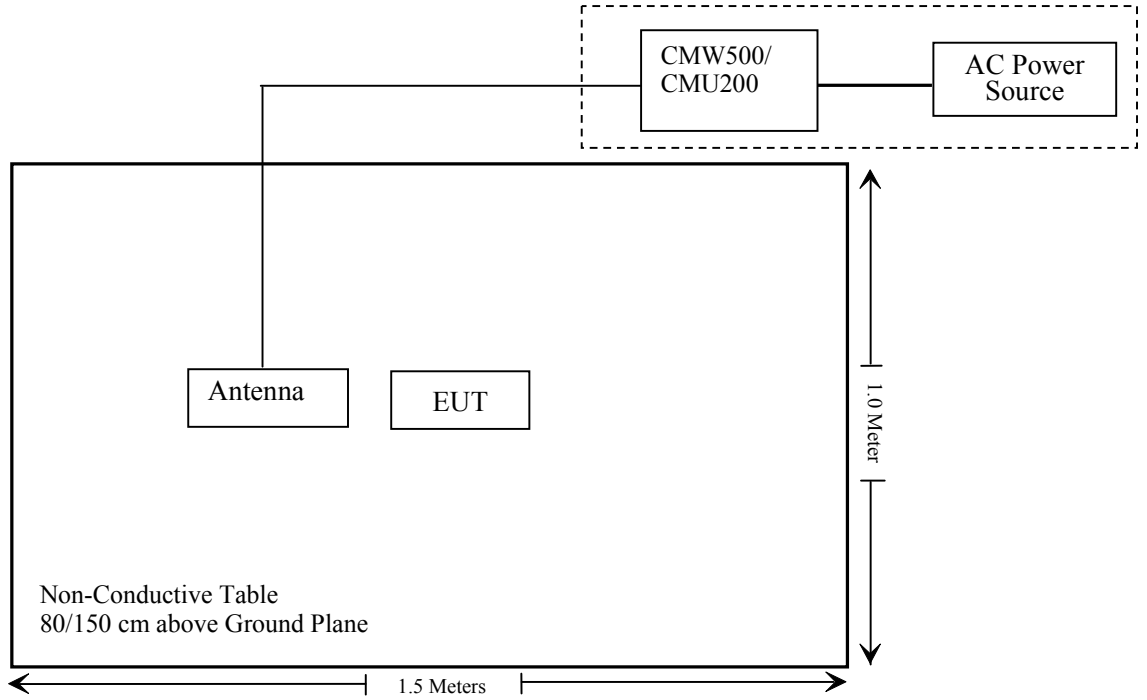

## SUMMARY OF TEST RESULTS

FCC Rules	Description of Test	Result
§ 1.1307 , §2.1093	RF Exposure (SAR)	Compliance*
§2.1046; § 22.913 (a); § 24.232 (c); §27.50 (c) (d) (h)	RF Output Power	Compliance
§ 2.1047	Modulation Characteristics	Not Applicable
§ 2.1049; § 22.905; § 22.917; § 24.238; §27.53	Occupied Bandwidth	Compliance
§ 2.1051; § 22.917 (a); § 24.238 (a); §27.53	Spurious Emissions at Antenna Terminal	Compliance
§ 2.1053; § 22.917 (a); § 24.238 (a); §27.53	Field Strength of Spurious Radiation	Compliance
§ 22.917 (a); § 24.238 (a); §27.53(c)(h) (m)	Band Edge	Compliance
§ 2.1055; § 22.355; § 24.235; §27.54;	Frequency stability	Compliance

Note: \* Please refer to SAR report released by BACL, report number: SZ1210205-04282E-SA.



**TEST EQUIPMENT LIST**

Manufacturer	Description	Model	Serial Number	Calibration Date	Calibration Due Date
<b>Radiated Emission Test</b>					
R&S	EMI Test Receiver	ESR3	102455	2020/08/04	2021/08/03
Sonoma instrument	Pre-amplifier	310 N	186238	2020/08/04	2021/08/03
Sunol Sciences	Broadband Antenna	JB1	A040904-2	2020/12/22	2023/12/21
COM-POWER	Dipole Antenna	AD-100	721027	NCR	NCR
Unknown	Cable 2	RF Cable 2	F-03-EM197	2020/11/29	2021/11/28
Unknown	Cable	Chamber Cable 1	F-03-EM236	2020/11/29	2021/11/28
Rohde & Schwarz	Spectrum Analyzer	FSV40-N	102259	2020/08/04	2021/08/03
COM-POWER	Pre-amplifier	PA-122	181919	2020/11/29	2021/11/28
Quinstar	Amplifier	QLW-18405536-J0	15964001002	2020/11/29	2021/11/28
Sunol Sciences	Horn Antenna	3115	9107-3694	2021/01/15	2024/01/14
A.H.System	Horn Antenna	SAS-200/571	135	2018/09/01	2021/08/31
Insulted Wire Inc.	RF Cable	SPS-2503-3150	02222010	2020/11/29	2021/11/28
Unknown	RF Cable	W1101-EQ1 OUT	F-19-EM005	2020/11/29	2021/11/28
MICRO-TRONICS	Passband filter	HPM50111	F-19-EM006	2020/04/20	2021/04/19
Unknown	High Pass filter	1.3GHz	101120	2020/04/20	2021/04/19
Ducommun Technologies	Horn antenna	ARH-4223-02	1007726-01 1304	2020/12/06	2023/12/05
Ducommun Technologies	Horn antenna	ARH-4223-02	1007726-02 1304	2020/12/06	2023/12/05
Agilent	Signal Generator	N5183A	MY51040755	2020/12/29	2021/12/28
Rohde & Schwarz	Wideband Radio Communication Tester	CMW500	1201.002K50-146520-wh	2020/08/04	2021/08/03
Rohde & Schwarz	Universal Radio Communication Tester	CMU200	115500	2020/07/31	2021/07/30

Manufacturer	Description	Model	Serial Number	Calibration Date	Calibration Due Date
<b>RF Conducted Test</b>					
Rohde & Schwarz	Signal and Spectrum Analyzer	FSV40	101473	2020/08/04	2021/08/03
Rohde & Schwarz	Wideband Radio Communication Tester	CMW500	1201.002K50-146520-wh	2020/08/04	2021/08/03
Unknown	RF Cable	Unknown	2301 276	2020/11/29	2021/11/28
Unknown	RF Cable	Unknown	DLO J5/W6102	2020/11/29	2021/11/28
Weinschel	Power divider	1515	MY628	2020/11/29	2021/11/28
Rohde & Schwarz	Universal Radio Communication Tester	CMU200	115500	2020/07/31	2021/07/30
instek	DC Power Supply	GPS-3030DD	EM832096	NCR	NCR
ESPEC	Temperature & Humidity Chamber	EL-10KA	9107726	2021/01/05	2022/01/05
Fluke	Digital Multimeter	287	19000011	2020/07/23	2021/07/22

\* Statement of Traceability: Bay Area Compliance Laboratories Corp. (Shenzhen) attests that all calibrations have been performed in accordance to requirements that traceable to National Primary Standards and International System of Units (SI).

---

## **FCC §1.1307(b) & §2.1093 - RF EXPOSURE INFORMATION**

---

### **Applicable Standard**

FCC§1.1310 and §2.1093.

### **Test Result**

Compliance, please refer to the SAR report: SZ1210205-04282E-SA.

---

## **FCC §2.1047 - MODULATION CHARACTERISTIC**

---

According to FCC § 2.1047(d), Part 22H & 24E & 27 there is no specific requirement for digital modulation, therefore modulation characteristic is not presented.

## **FCC § 2.1046, § 22.913 (a) & § 24.232 (c); §27.50 (c) (d) (h) - RF OUTPUT POWER**

### **Applicable Standard**

According to FCC §2.1046 and §22.913 (a), the ERP of mobile transmitters and auxiliary test transmitters must not exceed 7 watts.

According to FCC §2.1046 and §24.232 (C), mobile and portable stations are limited to 2 watts EIRP and the equipment must employ a means for limiting power to the minimum necessary for successful communications.

The peak-to-average power ratio (PAPR) of the transmitter output power must not exceed 13 dB.

According to §27.50(c), Portable stations (hand-held devices) in the 600 MHz uplink band and the 698-746 MHz band, and fixed and mobile stations in the 600 MHz uplink band are limited to 3 watts ERP.

According to §27.50(d), the maximum EIRP must not exceed 1Watts (30dBm) for 1710-1780MHz.

According to §27.50(h), the maximum EIRP must not exceed 2Watts (33dBm) for 2500-2570MHz & 2496-2690MHz.

### **Test Procedure**

*Conducted method:*

The RF output of the transmitter was connected to the CMW500/CMU200 through sufficient attenuation.

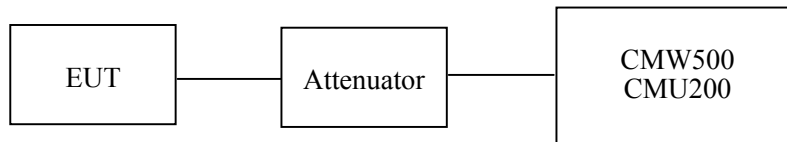

**Test Data**

**Environmental Conditions**

<b>Temperature:</b>	25 °C
<b>Relative Humidity:</b>	55 %
<b>ATM Pressure:</b>	101.0 kPa

*The testing was performed by Coco Liu from 2021-02-19 to 2021-03-31.*

**Conducted Power**

**Cellular Band (Part 22H)**

Mode	Channel	Frequency (MHz)	Average Output Power (dBm)	ERP (dBm)	Limit (dBm)
GSM	128	824.2	31.92	28.17	38.45
	190	836.6	31.97	28.22	38.45
	251	848.8	32.03	28.28	38.45

Mode	Channel	Frequency (MHz)	Average Output Power (dBm)				ERP(dBm)				Limit (dBm)
			1 slot	2 slots	3 slots	4 slots	1 slot	2 slots	3 slots	4 slots	
GPRS	128	824.2	31.67	30.63	28.68	27.46	27.92	26.88	24.93	23.71	38.45
	190	836.6	31.80	30.78	28.74	27.57	28.05	27.03	24.99	23.82	38.45
	251	848.8	31.71	30.81	28.77	27.61	27.96	27.06	25.02	23.86	38.45

Mode	Channel	Frequency (MHz)	Average Output Power (dBm)				ERP(dBm)				Limit (dBm)
			1 slot	2 slots	3 slots	4 slots	1 slot	2 slots	3 slots	4 slots	
EGPRS	128	824.2	27.39	25.73	22.78	21.24	23.64	21.98	19.03	17.49	38.45
	190	836.6	27.16	25.66	22.68	21.13	23.41	21.91	18.93	17.38	38.45
	251	848.8	27.26	25.85	22.56	21.06	23.51	22.1	18.81	17.31	38.45

Mode	Test Mode	3GPP Sub Test	Average Output Power (dBm)			ERP(dBm)		
			Low	Mid	High	Low	Mid	High
WCDMA (Band 5)	RMC12.2k		19.60	19.74	19.73	15.85	15.99	15.98
	HSDPA	1	19.16	19.17	19.19	15.41	15.42	15.44
		2	19.02	19.09	19.03	15.27	15.34	15.28
		3	18.93	18.95	18.91	15.18	15.2	15.16
		4	18.88	18.9	18.82	15.13	15.15	15.07
	HSUPA	1	18.98	19.02	18.96	15.23	15.27	15.21
		2	19.04	19.06	19.07	15.29	15.31	15.32
		3	18.93	18.96	18.91	15.18	15.21	15.16
		4	18.89	18.86	18.88	15.14	15.11	15.13
		5	18.84	18.78	18.82	15.09	15.03	15.07
HSPA+	1	19.53	19.64	19.45	15.78	15.89	15.70	

Note: ERP(dBm) = Conducted Power(dBm) + Antenna Gain(dBd)  
 For GSM850/WCDMA Band5: Antenna Gain = -1.6dBi = -3.75dBd (0dBd=2.15dBi)  
 The limit: ERP ≤ 38.45dBm

**PCS Band (Part 24E)**

Mode	Channel	Frequency (MHz)	Average Output Power (dBm)	EIRP(dBm)	Limit (dBm)
GSM	512	1850.2	28.61	27.91	33
	661	1880.0	28.65	27.95	33
	810	1909.8	28.37	27.67	33

Mode	Channel	Frequency (MHz)	Average Output Power (dBm)				EIRP(dBm)				Limit (dBm)
			1 slot	2 slots	3 slots	4 slots	1 slot	2 slots	3 slots	4 slots	
GPRS	512	1850.2	28.71	27.56	25.62	24.52	28.01	26.86	24.92	23.82	33
	661	1880.0	28.5	27.42	25.46	24.38	27.8	26.72	24.76	23.68	33
	810	1909.8	28.82	27.74	25.79	24.69	28.12	27.04	25.09	23.99	33

Mode	Channel	Frequency (MHz)	Average Output Power (dBm)				EIRP(dBm)				Limit (dBm)
			1 slot	2 slots	3 slots	4 slots	1 slot	2 slots	3 slots	4 slots	
EGPRS	512	1850.2	26.41	25.48	23.17	22.09	25.71	24.78	22.47	21.39	33
	661	1880.0	26.94	25.89	23.43	22.22	26.24	25.19	22.73	21.52	33
	810	1909.8	26.63	25.95	23.46	22.62	25.93	25.25	22.76	21.92	33

Mode	Test Mode	3GPP Sub Test	Average Output Power (dBm)			EIRP(dBm)		
			Low	Mid	High	Low	Mid	High
WCDMA (Band 2)	RMC12.2k		17.90	17.86	17.74	17.2	17.16	17.04
	HSDPA	1	16.67	16.49	16.72	15.97	15.79	16.02
		2	16.72	16.48	16.56	16.02	15.78	15.68
		3	16.44	16.59	16.58	15.74	15.89	15.88
		4	16.60	16.40	16.65	15.9	15.7	15.95
	HSUPA	1	16.59	16.45	16.34	15.89	15.75	15.64
		2	16.53	16.57	16.33	15.83	15.87	15.63
		3	16.22	16.48	16.31	15.52	15.78	15.61
		4	16.28	16.40	16.34	15.58	15.7	15.64
		5	16.33	16.65	16.54	15.63	15.95	15.84
HSPA+	1	16.93	17.11	16.92	16.23	16.41	16.22	

Note: EIRP(dBm) = Conducted Power(dBm) + Antenna Gain(dBi)  
 For PCS1900/WCDMA Band2: Antenna Gain = -0.7dBi  
 The limit: EIRP ≤ 33dBm



**AWS Band (Part 27)**

Mode	Test Mode	3GPP Sub Test	Average Output Power (dBm)			EIRP(dBm)		
			Low	Mid	High	Low	Mid	High
WCDMA (Band 4)	RMC12.2k		17.61	17.50	17.66	16.91	16.80	16.96
	HSDPA	1	15.12	15.11	15.18	14.42	14.41	14.48
		2	15.07	15.06	15.12	14.37	14.36	14.42
		3	15.01	15.02	15.12	14.31	14.32	14.42
		4	14.94	15.00	15.08	14.24	14.30	14.38
	HSUPA	1	15.17	15.13	15.23	14.47	14.43	14.53
		2	15.11	15.09	15.18	14.41	14.39	14.48
		3	15.08	15.03	15.13	14.38	14.33	14.43
		4	15.09	14.93	15.08	14.39	14.23	14.38
		5	15.02	14.85	15.00	14.32	14.15	14.30
	HSPA+	1	15.55	15.60	15.67	14.85	14.90	14.97

Note: EIRP(dBm) = Conducted Power(dBm) + Antenna Gain(dBi)  
 For WCDMA Band4: Antenna Gain = -0.7dBi  
 The limit: EIRP ≤ 30dBm

**Peak-to-average ratio (PAR)**

**Cellular Band**

Mode	Channel	PAR (dB)	Limit (dB)
GSM	Low	3.48	13
	Middle	3.17	13
	High	3.00	13

Mode	Channel	PAR (dB)	Limit (dB)
EGPRS	Low	2.98	13
	Middle	3.84	13
	High	3.06	13

Mode	Channel	PAR (dB)	Limit (dB)
RMC (BPSK)	Low	3.72	13
	Middle	2.97	13
	High	3.12	13
HSDPA (16QAM)	Low	3.02	13
	Middle	3.40	13
	High	3.64	13
HSUPA (BPSK)	Low	3.47	13
	Middle	3.36	13
	High	3.01	13
HSPA+	Low	3.72	13
	Middle	2.97	13
	High	3.12	13

**PCS Band**

Mode	Channel	PAR (dB)	Limit (dB)
GSM	Low	3.78	13
	Middle	3.10	13
	High	3.45	13

Mode	Channel	PAR (dB)	Limit (dB)
EGPRS	Low	3.26	13
	Middle	3.06	13
	High	3.93	13

Mode	Channel	PAR (dB)	Limit (dB)
RMC (BPSK)	Low	3.67	13
	Middle	3.54	13
	High	3.62	13
HSDPA (16QAM)	Low	3.25	13
	Middle	3.47	13
	High	3.20	13
HSUPA (BPSK)	Low	3.09	13
	Middle	3.36	13
	High	2.95	13
HSPA+	Low	3.67	13
	Middle	3.54	13
	High	3.62	13

**AWS Band**

Mode	Channel	PAR (dB)	Limit (dB)
RMC (BPSK)	Low	3.49	13
	Middle	3.15	13
	High	3.07	13
HSDPA (16QAM)	Low	3.41	13
	Middle	3.65	13
	High	3.59	13
HSUPA (BPSK)	Low	3.60	13
	Middle	3.68	13
	High	3.40	13
HSPA+	Low	3.49	13
	Middle	3.15	13
	High	3.07	13

**LTE Band 2:**

**Maximum Output Power**

Bandwidth (MHz)	Modulation	RB size/ RB Offset	Conducted Average Output Power (dBm)			EIRP(dBm)		
			Low	Mid	High	Low	Mid	High
1.4	QPSK	RB1#0	17.50	17.60	17.59	16.80	16.90	16.89
		RB1#2	17.85	17.88	17.97	17.15	17.18	17.27
		RB1#5	17.72	17.70	17.81	17.02	17.00	17.11
		RB3#0	17.85	17.84	17.76	17.15	17.14	17.06
		RB3#1	17.53	17.80	17.80	16.83	17.10	17.10
		RB3#2	16.77	16.71	16.70	16.07	16.01	16.00
		RB6#0	17.83	17.70	17.56	17.13	17.00	16.86
	16QAM	RB1#0	17.88	17.88	18.05	17.18	17.18	17.35
		RB1#2	17.38	17.57	17.35	16.68	16.87	16.65
		RB1#5	17.96	18.01	17.83	17.26	17.31	17.13
		RB3#0	17.80	17.67	17.60	17.10	16.97	16.90
		RB3#1	16.55	16.63	16.74	15.85	15.93	16.04
		RB3#2	17.54	17.70	17.60	16.84	17.00	16.90
		RB6#0	17.78	17.87	17.72	17.08	17.17	17.02
3.0	QPSK	RB1#0	17.79	17.60	17.77	17.09	16.9	17.07
		RB1#7	17.75	17.84	17.88	17.05	17.14	17.18
		RB1#14	17.64	17.42	17.69	16.94	16.72	16.99
		RB8#0	17.67	17.57	17.86	16.97	16.87	17.16
		RB8#4	17.72	17.74	17.42	17.02	17.04	16.72
		RB8#7	16.43	16.37	16.38	15.73	15.67	15.68
		RB15#0	17.42	17.57	17.52	16.72	16.87	16.82
	16QAM	RB1#0	17.98	17.72	17.83	17.28	17.02	17.13
		RB1#7	17.45	17.66	17.41	16.75	16.96	16.71
		RB1#14	17.82	17.72	17.88	17.12	17.02	17.18
		RB8#0	17.49	17.42	17.61	16.79	16.72	16.91
		RB8#4	16.71	16.62	16.85	16.01	15.92	16.15
		RB8#7	17.69	17.58	17.63	16.99	16.88	16.93
		RB15#0	17.71	17.81	17.80	17.01	17.11	17.10

Bandwidth (MHz)	Modulation	RB size/ RB Offset	Conducted Average Output Power (dBm)			EIRP(dBm)		
			Low	Mid	High	Low	Mid	High
5.0	QPSK	RB1#0	17.30	17.48	17.37	16.60	16.78	16.67
		RB1#12	17.70	17.74	17.57	17.00	17.04	16.87
		RB1#24	17.43	17.41	17.36	16.73	16.71	16.66
		RB12#0	17.82	17.53	17.43	17.12	16.83	16.73
		RB12#6	17.41	17.64	17.85	16.71	16.94	17.15
		RB12#11	16.31	16.44	16.50	15.61	15.74	15.8
		RB25#0	17.17	17.13	17.23	16.47	16.43	16.53
	16QAM	RB1#0	17.68	17.78	17.98	16.98	17.08	17.28
		RB1#12	17.46	17.42	17.25	16.76	16.72	16.55
		RB1#24	17.78	17.48	17.67	17.08	16.78	16.97
		RB12#0	17.59	17.82	17.92	16.89	17.12	17.22
		RB12#6	16.34	16.09	16.43	15.64	15.39	15.73
		RB12#11	17.27	17.50	17.32	16.57	16.8	16.62
		RB25#0	17.59	17.61	17.55	16.89	16.91	16.85
10.0	QPSK	RB1#0	17.65	17.69	17.66	16.95	16.99	16.96
		RB1#24	17.65	17.93	17.76	16.95	17.23	17.06
		RB1#49	17.68	17.55	17.56	16.98	16.85	16.86
		RB25#0	17.97	17.81	18.01	17.27	17.11	17.31
		RB25#12	17.83	17.66	17.81	17.13	16.96	17.11
		RB25#24	16.89	16.66	16.65	16.19	15.96	15.95
		RB50#0	17.78	18.01	17.93	17.08	17.31	17.23
	16QAM	RB1#0	18.09	18.00	18.09	17.39	17.30	17.39
		RB1#24	17.85	17.69	17.46	17.15	16.99	16.76
		RB1#49	17.79	17.55	17.85	17.09	16.85	17.15
		RB25#0	17.63	17.49	17.69	16.93	16.79	16.99
		RB25#12	16.68	16.64	16.76	15.98	15.94	16.06
		RB25#24	17.55	17.64	17.73	16.85	16.94	17.03
		RB50#0	17.67	17.91	17.74	16.97	17.21	17.04

Bandwidth (MHz)	Modulation	RB size/ RB Offset	Conducted Average Output Power (dBm)			EIRP(dBm)		
			Low	Mid	High	Low	Mid	High
15.0	QPSK	RB1#0	17.40	17.56	17.36	16.70	16.86	16.66
		RB1#37	17.63	17.56	17.72	16.93	16.86	17.02
		RB1#74	17.61	17.37	17.36	16.91	16.67	16.66
		RB36#0	17.83	17.71	17.76	17.13	17.01	17.06
		RB36#18	17.58	17.68	17.61	16.88	16.98	16.91
		RB36#37	16.81	16.56	16.52	16.11	15.86	15.82
		RB75#0	17.74	17.80	17.71	17.04	17.10	17.01
	16QAM	RB1#0	17.94	17.95	18.07	17.24	17.25	17.37
		RB1#37	17.68	17.67	17.24	16.98	16.97	16.54
		RB1#74	17.62	17.52	17.73	16.92	16.82	17.03
		RB36#0	17.41	17.38	17.57	16.71	16.68	16.87
		RB36#18	16.47	16.51	16.62	15.77	15.81	15.92
		RB36#37	17.44	17.54	17.50	16.74	16.84	16.80
		RB75#0	17.55	17.57	17.57	16.85	16.87	16.87
20.0	QPSK	RB1#0	17.26	17.49	17.23	16.56	16.79	16.53
		RB1#49	17.53	17.41	17.70	16.83	16.71	17.00
		RB1#99	17.44	17.22	17.17	16.74	16.52	16.47
		RB50#0	17.83	17.54	17.73	17.13	16.84	17.03
		RB50#24	17.59	17.54	17.54	16.89	16.84	16.84
		RB50#49	16.81	16.39	16.43	16.11	15.69	15.73
		RB100#0	17.64	17.78	17.61	16.94	17.08	16.91
	16QAM	RB1#0	17.86	17.82	17.94	17.16	17.12	17.24
		RB1#49	17.73	17.49	17.27	17.03	16.79	16.57
		RB1#99	17.64	17.46	17.65	16.94	16.76	16.95
		RB50#0	17.36	17.37	17.46	16.66	16.67	16.76
		RB50#24	16.29	16.45	16.63	15.59	15.75	15.93
		RB50#49	17.12	17.60	17.11	16.42	16.9	16.41
		RB100#0	17.51	17.45	17.61	16.81	16.75	16.91

Note: EIRP(dBm) = Conducted Power(dBm) + Antenna Gain(dBi)  
 For LTE Band2: Antenna Gain = -0.7dBi  
 The Limit: EIRP ≤ 33dBm

**Peak-to-average ratio (PAR)****20MHz Bandwidth**

<b>Modulation</b>	<b>Low channel (dB)</b>	<b>Middle channel (dB)</b>	<b>High channel (dB)</b>	<b>PAR Limit (dB)</b>	<b>Result</b>
QPSK (1RB Size)	3.24	4.08	3.32	13	Pass
QPSK (100RB Size)	5.17	4.89	5.25	13	Pass
16QAM (1RB Size)	3.78	4.55	4.43	13	Pass
16QAM (100RB Size)	6.10	6.19	6.20	13	Pass

**LTE Band 4**

Bandwidth (MHz)	Modulation	RB size/ RB Offset	Conducted Average Output Power (dBm)			EIRP(dBm)		
			Low	Mid	High	Low	Mid	High
1.4	QPSK	RB1#0	16.08	15.87	15.74	15.38	15.17	15.04
		RB1#2	16.09	15.98	16.05	15.39	15.28	15.35
		RB1#5	16.02	15.88	15.81	15.32	15.18	15.11
		RB3#0	16.06	16.03	15.98	15.36	15.33	15.28
		RB3#1	16.24	16.14	15.87	15.54	15.44	15.17
		RB3#2	16.09	15.99	15.98	15.39	15.29	15.28
		RB6#0	15.12	14.99	15.04	14.42	14.29	14.34
	16QAM	RB1#0	16.06	15.94	15.93	15.36	15.24	15.23
		RB1#2	16.09	16.03	16.06	15.39	15.33	15.36
		RB1#5	15.91	15.97	16.03	15.21	15.27	15.33
		RB3#0	15.80	15.67	15.83	15.1	14.97	15.13
		RB3#1	15.62	15.44	15.44	14.92	14.74	14.74
		RB3#2	15.95	15.83	15.40	15.25	15.13	14.7
		RB6#0	15.96	15.94	15.97	15.26	15.24	15.27
3.0	QPSK	RB1#0	15.96	15.95	15.99	15.26	15.25	15.29
		RB1#7	16.12	15.91	16.16	15.42	15.21	15.46
		RB1#14	16.02	15.89	16.12	15.32	15.19	15.42
		RB8#0	15.91	15.86	15.78	15.21	15.16	15.08
		RB8#4	15.97	16.20	16.06	15.27	15.5	15.36
		RB8#7	15.78	15.86	16.19	15.08	15.16	15.49
		RB15#0	14.80	15.00	14.87	14.1	14.3	14.17
	16QAM	RB1#0	16.03	15.97	15.98	15.33	15.27	15.28
		RB1#7	16.01	15.94	15.93	15.31	15.24	15.23
		RB1#14	16.26	16.06	15.99	15.56	15.36	15.29
		RB8#0	15.63	15.46	15.48	14.93	14.76	14.78
		RB8#4	15.43	15.40	15.41	14.73	14.7	14.71
		RB8#7	15.92	15.87	15.97	15.22	15.17	15.27
		RB15#0	15.98	15.91	16.08	15.28	15.21	15.38



Bandwidth (MHz)	Modulation	RB size/ RB Offset	Conducted Average Output Power (dBm)			EIRP(dBm)		
			Low	Mid	High	Low	Mid	High
5.0	QPSK	RB1#0	15.78	15.69	15.76	15.08	14.99	15.06
		RB1#12	15.57	15.49	15.43	14.87	14.79	14.73
		RB1#24	15.93	15.87	15.40	15.23	15.17	14.7
		RB12#0	15.99	15.87	15.90	15.29	15.17	15.2
		RB12#6	15.96	15.89	16.02	15.26	15.19	15.32
		RB12#11	16.07	15.92	16.10	15.37	15.22	15.4
		RB25#0	16.07	15.88	16.15	15.37	15.18	15.45
	16QAM	RB1#0	15.93	15.88	15.85	15.23	15.18	15.15
		RB1#12	15.92	16.22	16.13	15.22	15.52	15.43
		RB1#24	15.74	15.87	16.12	15.04	15.17	15.42
		RB12#0	14.84	15.03	14.83	14.14	14.33	14.13
		RB12#6	15.61	15.45	15.43	14.91	14.75	14.73
		RB12#11	16.00	15.83	15.38	15.3	15.13	14.68
		RB25#0	15.98	15.89	16.00	15.28	15.19	15.3
10.0	QPSK	RB1#0	16.04	15.92	15.97	15.34	15.22	15.27
		RB1#24	16.07	15.93	16.08	15.37	15.23	15.38
		RB1#49	16.00	15.94	16.17	15.3	15.24	15.47
		RB25#0	15.90	15.83	15.85	15.2	15.13	15.15
		RB25#12	15.92	16.25	16.08	15.22	15.55	15.38
		RB25#24	15.77	15.79	16.14	15.07	15.09	15.44
		RB50#0	15.89	15.89	15.82	15.19	15.19	15.12
	16QAM	RB1#0	15.99	16.24	16.13	15.29	15.54	15.43
		RB1#24	15.74	15.84	16.16	15.04	15.14	15.46
		RB1#49	14.86	15.08	14.82	14.16	14.38	14.12
		RB25#0	15.56	15.52	15.39	14.86	14.82	14.69
		RB25#12	15.93	15.87	15.41	15.23	15.17	14.71
		RB25#24	15.98	15.92	15.91	15.28	15.22	15.21
		RB50#0	15.98	15.97	16.05	15.28	15.27	15.35

Bandwidth (MHz)	Modulation	RB size/ RB Offset	Conducted Average Output Power (dBm)			EIRP(dBm)		
			Low	Mid	High	Low	Mid	High
15.0	QPSK	RB1#0	16.23	16.37	16.16	15.53	15.67	15.46
		RB1#37	16.01	15.82	15.67	15.31	15.12	14.97
		RB1#74	16.04	15.72	15.69	15.34	15.02	14.99
		RB36#0	16.37	16.26	16.30	15.67	15.56	15.6
		RB36#18	16.24	16.39	16.11	15.54	15.69	15.41
		RB36#37	16.04	15.85	15.72	15.34	15.15	15.02
		RB75#0	16.00	15.72	15.64	15.3	15.02	14.94
	16QAM	RB1#0	16.20	15.98	15.88	15.50	15.28	15.18
		RB1#37	16.06	15.60	15.82	15.36	14.90	15.12
		RB1#74	16.28	16.35	16.30	15.58	15.65	15.60
		RB36#0	16.12	16.28	16.41	15.42	15.58	15.71
		RB36#18	16.27	16.12	16.12	15.57	15.42	15.42
		RB36#37	14.98	14.92	15.01	14.28	14.22	14.31
		RB75#0	15.10	14.62	14.55	14.4	13.92	13.85
20.0	QPSK	RB1#0	16.28	15.91	16.16	15.58	15.21	15.46
		RB1#49	16.28	15.95	15.88	15.58	15.25	15.18
		RB1#99	16.05	15.62	15.88	15.35	14.92	15.18
		RB50#0	16.29	16.31	16.25	15.59	15.61	15.55
		RB50#24	16.05	16.29	16.34	15.35	15.59	15.64
		RB50#49	16.21	16.04	15.80	15.51	15.34	15.1
		RB100#0	16.05	15.68	15.84	15.35	14.98	15.14
	16QAM	RB1#0	16.26	16.35	16.24	15.56	15.65	15.54
		RB1#49	16.10	16.28	16.40	15.4	15.58	15.7
		RB1#99	16.28	16.36	16.27	15.58	15.66	15.57
		RB50#0	16.06	16.30	16.41	15.36	15.6	15.71
		RB50#24	16.29	16.02	16.11	15.59	15.32	15.41
		RB50#49	14.99	14.91	15.00	14.29	14.21	14.3
		RB100#0	16.20	16.14	16.12	15.5	15.44	15.42

Note: EIRP(dBm) = Conducted Power(dBm) + Antenna Gain(dBi)  
 For LTE Band4: Antenna Gain = -0.7dBi  
 The Limit: EIRP≤30dBm

**Peak-to-average ratio (PAR)****20MHz Bandwidth**

<b>Modulation</b>	<b>Low channel (dB)</b>	<b>Middle channel (dB)</b>	<b>High channel (dB)</b>	<b>PAR Limit (dB)</b>	<b>Result</b>
QPSK (1RB Size)	4.35	3.90	4.43	13	Pass
QPSK (100RB Size)	5.97	5.29	5.75	13	Pass
16QAM (1RB Size)	5.26	5.06	5.08	13	Pass
16QAM (100RB Size)	5.92	6.06	6.27	13	Pass

**LTE Band 5:**

Maximum Output Power

Bandwidth (MHz)	Modulation	RB size/ RB Offset	Conducted Average Output Power (dBm)			ERP(dBm)		
			Low	Mid	High	Low	Mid	High
1.4	QPSK	RB1#0	20.92	20.32	20.36	17.17	16.57	16.61
		RB1#2	20.32	20.14	20.41	16.57	16.39	16.66
		RB1#5	20.30	20.21	19.94	16.55	16.46	16.19
		RB3#0	20.06	20.31	20.24	16.31	16.56	16.49
		RB3#1	20.44	20.75	21.04	16.69	17.00	17.29
		RB3#2	20.57	21.02	20.05	16.82	17.27	16.3
		RB6#0	19.60	19.17	19.08	15.85	15.42	15.33
	16QAM	RB1#0	19.54	19.60	18.66	15.79	15.85	14.91
		RB1#2	19.54	19.21	19.13	15.79	15.46	15.38
		RB1#5	19.40	18.85	19.10	15.65	15.1	15.35
		RB3#0	19.13	19.52	19.59	15.38	15.77	15.84
		RB3#1	19.57	19.21	19.07	15.82	15.46	15.32
		RB3#2	18.48	19.47	19.17	14.73	15.72	15.42
		RB6#0	18.53	18.70	19.02	14.78	14.95	15.27
3.0	QPSK	RB1#0	20.66	20.71	20.22	16.91	16.96	16.47
		RB1#7	20.07	20.44	20.35	16.32	16.69	16.6
		RB1#14	20.04	20.09	20.61	16.29	16.34	16.86
		RB8#0	20.76	20.89	20.46	17.01	17.14	16.71
		RB8#4	20.83	20.65	20.29	17.08	16.90	16.54
		RB8#7	20.46	21.05	20.70	16.71	17.30	16.95
		RB15#0	19.56	18.68	18.87	15.81	14.93	15.12
	16QAM	RB1#0	19.20	19.37	19.24	15.45	15.62	15.49
		RB1#7	19.70	19.17	19.46	15.95	15.42	15.71
		RB1#14	18.85	18.69	19.14	15.1	14.94	15.39
		RB8#0	18.94	19.47	19.63	15.19	15.72	15.88
		RB8#4	19.16	19.14	19.06	15.41	15.39	15.31
		RB8#7	18.33	19.42	19.07	14.58	15.67	15.32
		RB15#0	20.50	20.56	20.61	16.75	16.81	16.86

Bandwidth (MHz)	Modulation	RB size/ RB Offset	Conducted Average Output Power (dBm)			ERP(dBm)		
			Low	Mid	High	Low	Mid	High
5.0	QPSK	RB1#0	20.29	20.84	20.71	16.54	17.09	16.96
		RB1#12	20.60	19.89	20.49	16.85	16.14	16.74
		RB1#24	20.13	20.08	20.15	16.38	16.33	16.4
		RB12#0	20.71	20.53	20.34	16.96	16.78	16.59
		RB12#6	20.39	20.18	20.48	16.64	16.43	16.73
		RB12#11	20.86	21.06	20.55	17.11	17.31	16.80
		RB25#0	19.08	19.00	18.86	15.33	15.25	15.11
	16QAM	RB1#0	19.75	18.75	18.78	16.00	15.00	15.03
		RB1#12	19.68	19.41	19.07	15.93	15.66	15.32
		RB1#24	19.15	18.75	19.31	15.4	15.00	15.56
		RB12#0	19.53	18.89	19.45	15.78	15.14	15.7
		RB12#6	19.13	19.14	19.64	15.38	15.39	15.89
		RB12#11	19.17	19.59	19.26	15.42	15.84	15.51
		RB25#0	18.49	18.36	18.85	14.74	14.61	15.1
10.0	QPSK	RB1#0	20.73	20.45	20.30	16.98	16.7	16.55
		RB1#24	20.31	20.69	20.56	16.56	16.94	16.81
		RB1#49	20.40	20.16	19.84	16.65	16.41	16.09
		RB25#0	20.49	21.09	20.78	16.74	17.34	17.03
		RB25#12	20.11	20.35	20.36	16.36	16.6	16.61
		RB25#24	20.47	20.72	20.22	16.72	16.97	16.47
		RB50#0	19.47	19.41	19.59	15.72	15.66	15.84
	16QAM	RB1#0	19.64	18.74	19.02	15.89	14.99	15.27
		RB1#24	19.19	19.02	19.22	15.44	15.27	15.47
		RB1#49	18.80	18.70	19.31	15.05	14.95	15.56
		RB25#0	18.98	19.56	19.83	15.23	15.81	16.08
		RB25#12	18.99	19.22	19.53	15.24	15.47	15.78
		RB25#24	19.32	19.56	19.25	15.57	15.81	15.5
		RB50#0	18.51	18.78	18.93	14.76	15.03	15.18

Note: ERP(dBm) = Conducted Power(dBm) + Antenna Gain(dBd)  
 For LTE Band 5: Antenna Gain = -1.6dBi = -3.75dBd (0dBd=2.15dBi)  
 Limit: ERP ≤ 38.45dBm

**Peak-to-average ratio (PAR)****10MHz bandwidth**

<b>Modulation</b>	<b>Low channel (dB)</b>	<b>Middle channel (dB)</b>	<b>High channel (dB)</b>	<b>PAR Limit (dB)</b>	<b>Result</b>
QPSK (1RB Size)	4.00	4.13	4.53	13	Pass
QPSK (50RB Size)	5.63	5.73	5.69	13	Pass
16QAM (1RB Size)	5.22	4.91	4.94	13	Pass
16QAM (50RB Size)	6.10	6.89	6.35	13	Pass

**LTE Band 7:**

Maximum Output Power

Bandwidth (MHz)	Modulation	RB size/ RB Offset	Conducted Average Output Power (dBm)			EIRP(dBm)		
			Low	Mid	High	Low	Mid	High
5.0	QPSK	RB1#0	18.10	18.09	17.84	17.70	17.69	17.44
		RB1#12	17.77	17.68	17.72	17.37	17.28	17.32
		RB1#24	17.57	17.55	17.41	17.17	17.15	17.01
		RB12#0	17.86	17.99	18.03	17.46	17.59	17.63
		RB12#6	17.89	17.98	17.71	17.49	17.58	17.31
		RB12#11	18.01	17.89	17.68	17.61	17.49	17.28
		RB25#0	16.83	16.38	16.49	16.43	15.98	16.09
	16QAM	RB1#0	17.04	16.66	16.42	16.64	16.26	16.02
		RB1#12	17.16	16.64	16.48	16.76	16.24	16.08
		RB1#24	16.18	16.41	16.56	15.78	16.01	16.16
		RB12#0	16.12	16.47	16.85	15.72	16.07	16.45
		RB12#6	16.11	16.54	16.32	15.71	16.14	15.92
		RB12#11	16.00	16.68	16.95	15.6	16.28	16.55
		RB25#0	15.89	15.80	15.77	15.49	15.4	15.37
10.0	QPSK	RB1#0	18.14	17.98	17.69	17.74	17.58	17.29
		RB1#24	17.52	17.41	17.59	17.12	17.01	17.19
		RB1#49	17.56	17.52	17.46	17.16	17.12	17.06
		RB25#0	18.10	18.03	17.84	17.7	17.63	17.44
		RB25#12	17.67	17.91	18.01	17.27	17.51	17.61
		RB25#24	17.61	17.90	17.83	17.21	17.5	17.43
		RB50#0	16.40	16.56	16.50	16.00	16.16	16.10
	16QAM	RB1#0	16.62	16.19	16.25	16.22	15.79	15.85
		RB1#24	16.77	16.28	16.69	16.37	15.88	16.29
		RB1#49	16.31	16.50	16.59	15.91	16.10	16.19
		RB25#0	16.05	16.44	16.44	15.65	16.04	16.04
		RB25#12	16.15	16.52	16.53	15.75	16.12	16.13
		RB25#24	16.22	16.77	16.58	15.82	16.37	16.18
		RB50#0	15.91	15.96	15.97	15.51	15.56	15.57

Bandwidth (MHz)	Modulation	RB size/ RB Offset	Conducted Average Output Power (dBm)			EIRP(dBm)		
			Low	Mid	High	Low	Mid	High
15.0	QPSK	RB1#0	18.04	18.32	18.21	17.64	17.92	17.81
		RB1#37	17.86	17.52	17.41	17.46	17.12	17.01
		RB1#74	17.79	17.54	17.18	17.39	17.14	16.78
		RB36#0	18.04	17.64	18.22	17.64	17.24	17.82
		RB36#18	17.38	17.19	17.83	16.98	16.79	17.43
		RB36#37	17.34	17.44	17.45	16.94	17.04	17.05
		RB75#0	16.57	16.40	16.63	16.17	16.00	16.23
	16QAM	RB1#0	17.03	16.41	16.31	16.63	16.01	15.91
		RB1#37	16.66	16.68	16.90	16.26	16.28	16.50
		RB1#74	16.72	16.32	16.33	16.32	15.92	15.93
		RB36#0	16.14	16.76	16.19	15.74	16.36	15.79
		RB36#18	16.61	16.69	16.43	16.21	16.29	16.03
		RB36#37	16.33	16.53	16.80	15.93	16.13	16.4
		RB75#0	15.93	15.49	15.99	15.53	15.09	15.59
20.0	QPSK	RB1#0	18.08	18.26	18.09	17.68	17.86	17.69
		RB1#49	17.71	17.47	17.56	17.31	17.07	17.16
		RB1#99	17.55	17.50	17.67	17.15	17.10	17.27
		RB50#0	17.74	17.83	17.96	17.34	17.43	17.56
		RB50#24	17.68	17.96	18.03	17.28	17.56	17.63
		RB50#49	18.07	18.15	17.72	17.67	17.75	17.32
		RB100#0	16.45	16.73	16.55	16.05	16.33	16.15
	16QAM	RB1#0	16.73	16.32	16.61	16.33	15.92	16.21
		RB1#49	17.14	16.48	16.69	16.74	16.08	16.29
		RB1#99	16.56	16.12	16.79	16.16	15.72	16.39
		RB50#0	16.16	16.48	16.81	15.76	16.08	16.41
		RB50#24	16.47	16.62	16.88	16.07	16.22	16.48
		RB50#49	16.16	16.95	16.83	15.76	16.55	16.43
		RB100#0	16.15	15.64	15.79	15.75	15.24	15.39

Note: ERP(dBm) = Conducted Power(dBm) + Antenna Gain(dBi)  
 For LTE Band7: Antenna Gain = -0.4dBi  
 Limit: EIRP ≤ 33dBm



**Peak-to-average ratio (PAR)****20MHz bandwidth**

<b>Modulation</b>	<b>Low channel (dB)</b>	<b>Middle channel (dB)</b>	<b>High channel (dB)</b>	<b>PAR Limit (dB)</b>	<b>Result</b>
QPSK (1RB Size)	4.99	4.86	3.52	13	Pass
QPSK (100RB Size)	5.44	5.32	5.48	13	Pass
16QAM (1RB Size)	5.62	5.50	4.36	13	Pass
16QAM (100RB Size)	6.11	6.02	6.44	13	Pass

**LTE Band 17:**

**Maximum Output Power**

Bandwidth (MHz)	Modulation	RB size/ RB Offset	Conducted Average Output Power (dBm)			EIRP(dBm)		
			Low	Mid	High	Low	Mid	High
5.0	QPSK	RB1#0	22.64	22.56	22.50	18.59	18.51	18.45
		RB1#12	22.44	22.55	22.27	18.39	18.5	18.22
		RB1#24	22.67	22.03	22.29	18.62	17.98	18.24
		RB12#0	21.73	21.69	21.53	17.68	17.64	17.48
		RB12#6	21.47	21.45	21.56	17.42	17.40	17.51
		RB12#11	21.64	21.55	21.50	17.59	17.50	17.45
		RB25#0	21.57	21.98	21.55	17.52	17.93	17.50
	16QAM	RB1#0	21.34	21.76	21.54	17.29	17.71	17.49
		RB1#12	21.24	21.80	21.50	17.19	17.75	17.45
		RB1#24	20.71	20.50	20.69	16.66	16.45	16.64
		RB12#0	20.58	20.54	20.64	16.53	16.49	16.59
		RB12#6	20.52	20.57	19.89	16.47	16.52	15.84
		RB12#11	20.65	21.07	20.78	16.6	17.02	16.73
		RB25#0	19.80	19.93	20.17	15.75	15.88	16.12
10.0	QPSK	RB1#0	22.74	22.05	22.06	18.69	18.00	18.01
		RB1#24	22.76	22.27	22.28	18.71	18.22	18.23
		RB1#49	22.61	21.94	21.96	18.56	17.89	17.91
		RB25#0	21.61	21.19	21.13	17.56	17.14	17.08
		RB25#12	21.75	21.21	21.02	17.7	17.16	16.97
		RB25#24	21.06	20.93	20.23	17.01	16.88	16.18
		RB50#0	21.36	21.19	21.16	17.31	17.14	17.11
	16QAM	RB1#0	21.67	21.28	21.52	17.62	17.23	17.47
		RB1#24	21.43	21.22	21.25	17.38	17.17	17.2
		RB1#49	20.84	20.28	20.34	16.79	16.23	16.29
		RB25#0	20.60	20.24	20.30	16.55	16.19	16.25
		RB25#12	20.17	19.94	19.89	16.12	15.89	15.84
		RB25#24	20.77	21.02	20.69	16.72	16.97	16.64
		RB50#0	19.87	20.31	20.25	15.82	16.26	16.2

Note: ERP(dBm) = Conducted Power(dBm) + Antenna Gain(dBd)  
 For LTE Band17: Antenna Gain = -1.9dBi = -4.05dBd (0dBd=2.15dBi)  
 Limit: ERP ≤ 34.77dBm

**Peak-to-average ratio (PAR)****10MHz bandwidth**

<b>Modulation</b>	<b>Low channel (dB)</b>	<b>Middle channel (dB)</b>	<b>High channel (dB)</b>	<b>PAR Limit (dB)</b>	<b>Result</b>
QPSK (1RB Size)	5.13	4.97	5.05	13	Pass
QPSK (50RB Size)	5.43	5.38	5.03	13	Pass
16QAM (1RB Size)	5.76	5.60	5.52	13	Pass
16QAM (50RB Size)	5.33	5.33	5.58	13	Pass

**LTE Band 38**

**Maximum Output Power**

Bandwidth (MHz)	Modulation	RB size/ RB Offset	Conducted Average Output Power (dBm)			EIRP (dBm)		
			Low	Mid	High	Low	Mid	High
5	QPSK	RB1#0	19.17	19.08	19.18	18.77	18.68	18.78
		RB1#2	18.96	19.12	19.35	18.56	18.72	18.95
		RB1#5	18.99	18.71	19.02	18.59	18.31	18.62
		RB3#0	18.65	19.21	19.1	18.25	18.81	18.70
		RB3#1	18.65	18.79	19.5	18.25	18.39	19.10
		RB3#2	18.9	18.75	19.19	18.5	18.35	18.79
		RB6#0	19.29	18.9	19.11	18.89	18.50	18.71
	16QAM	RB1#0	19.02	19.36	18.78	18.62	18.96	18.38
		RB1#2	19.13	19.05	19.18	18.73	18.65	18.78
		RB1#5	19.19	19.24	19	18.79	18.84	18.6
		RB3#0	19.19	18.71	19.45	18.79	18.31	19.05
		RB3#1	19.4	18.67	19.41	19.00	18.27	19.01
		RB3#2	19.06	19.28	19.06	18.66	18.88	18.66
		RB6#0	18.54	18.13	18.02	18.14	17.73	17.62
10	QPSK	RB1#0	19.17	19.52	19.35	18.77	19.12	18.95
		RB1#7	18.73	18.72	18.69	18.33	18.32	18.29
		RB1#14	18.54	19.05	18.97	18.14	18.65	18.57
		RB8#0	19.1	18.91	18.9	18.7	18.51	18.5
		RB8#4	19.12	19	19.49	18.72	18.60	19.09
		RB8#7	19.19	19.02	19.04	18.79	18.62	18.64
		RB15#0	17.97	18	18.01	17.57	17.60	17.61
	16QAM	RB1#0	18.18	17.75	18.12	17.78	17.35	17.72
		RB1#7	18.43	17.48	17.75	18.03	17.08	17.35
		RB1#14	17.61	17.6	17.92	17.21	17.20	17.52
		RB8#0	17.53	17.76	18.15	17.13	17.36	17.75
		RB8#4	18.02	17.7	17.74	17.62	17.30	17.34
		RB8#7	17.04	18.13	18.07	16.64	17.73	17.67
		RB15#0	17.46	17.17	17.31	17.06	16.77	16.91

Bandwidth (MHz)	Modulation	RB size/ RB Offset	Conducted Average Output Power (dBm)			EIRP(dBm)		
			Low	Mid	High	Low	Mid	High
15	QPSK	RB1#0	18.72	18.57	18.75	18.32	18.17	18.35
		RB1#12	18.35	18.64	18.75	17.95	18.24	18.35
		RB1#24	18.4	18.49	18.46	18.00	18.09	18.06
		RB12#0	18.56	18.2	18.3	18.16	17.80	17.90
		RB12#6	18.36	18.74	18.4	17.96	18.34	18.00
		RB12#11	18.59	19.02	18.94	18.19	18.62	18.54
		RB25#0	18.72	18.48	18.6	18.32	18.08	18.2
	16QAM	RB1#0	18.52	18.67	18.17	18.12	18.27	17.77
		RB1#12	18.57	18.85	18.9	18.17	18.45	18.50
		RB1#24	18.27	18.67	18.11	17.87	18.27	17.71
		RB12#0	18.82	18.58	18.79	18.42	18.18	18.39
		RB12#6	19.04	18.93	18.91	18.64	18.53	18.51
		RB12#11	18.82	18.61	18.78	18.42	18.21	18.38
		RB25#0	17.8	17.74	17.7	17.4	17.34	17.30
20	QPSK	RB1#0	18.47	18.55	18.73	18.07	18.15	18.33
		RB1#24	18.33	18.13	18.63	17.93	17.73	18.23
		RB1#49	18.43	18.39	19.05	18.03	17.99	18.65
		RB25#0	18.21	18.55	18.46	17.81	18.15	18.06
		RB25#12	18.69	18.53	18.49	18.29	18.13	18.09
		RB25#24	18.55	18.79	18.24	18.15	18.39	17.84
		RB50#0	18.68	18.86	18.71	18.28	18.46	18.31
	16QAM	RB1#0	18.44	18.44	18.22	18.04	18.04	17.82
		RB1#24	18.84	18.81	19.12	18.44	18.41	18.72
		RB1#49	18.28	18.66	18.91	17.88	18.26	18.51
		RB25#0	18.18	18.6	18.47	17.78	18.20	18.07
		RB25#12	18.5	18.47	18.61	18.1	18.07	18.21
		RB25#24	17.95	18.15	18.61	17.55	17.75	18.21
		RB50#0	17.49	17.64	17.39	17.09	17.24	16.99

Note: EIRP(dBm) = Conducted Power(dBm) + Antenna Gain(dBi)  
 For LTE Band38: Antenna Gain = -0.4dBi  
 Limit: EIRP ≤ 33dBm

**Peak-to-average ratio (PAR)****20MHz bandwidth**

<b>Modulation</b>	<b>Low channel (dB)</b>	<b>Middle channel (dB)</b>	<b>High channel (dB)</b>	<b>PAR Limit (dB)</b>	<b>Result</b>
QPSK (1RB Size)	4.45	4.25	4.36	13	Pass
QPSK (100RB Size)	5.89	5.80	4.82	13	Pass
16QAM (1RB Size)	5.07	5.71	5.47	13	Pass
16QAM (100RB Size)	6.05	6.18	7.15	13	Pass

**LTE Band 41:**

**Maximum Output Power**

Bandwidth (MHz)	Modulation	RB size/ RB Offset	Conducted Average Output Power (dBm)			EIRP(dBm)		
			Low	Mid	High	Low	Mid	High
5	QPSK	RB1#0	19.21	19.14	19.03	18.81	18.74	18.63
		RB1#12	18.44	18.99	18.85	18.04	18.59	18.45
		RB1#24	18.86	18.75	18.43	18.46	18.35	18.03
		RB12#0	18.39	18.37	18.6	17.99	17.97	18.20
		RB12#6	18.87	18.46	18.54	18.47	18.06	18.14
		RB12#11	18.6	18.4	18.62	18.2	18.00	18.22
		RB25#0	18.48	18.74	18.74	18.08	18.34	18.34
	16QAM	RB1#0	18.7	18.43	18.58	18.3	18.03	18.18
		RB1#12	18.33	18.83	18.94	17.93	18.43	18.54
		RB1#24	19.17	18.96	18.49	18.77	18.56	18.09
		RB12#0	18.45	19.14	18.71	18.05	18.74	18.31
		RB12#6	18.65	18.89	18.6	18.25	18.49	18.2
		RB12#11	17.42	18.01	18.72	17.02	17.61	18.32
		RB25#0	17.66	18.28	18.28	17.26	17.88	17.88
10	QPSK	RB1#0	18.8	18.91	19.31	18.4	18.51	18.91
		RB1#24	18.97	18.72	18.57	18.57	18.32	18.17
		RB1#49	18.55	18.87	18.97	18.15	18.47	18.57
		RB25#0	18.82	18.93	18.59	18.42	18.53	18.19
		RB25#12	18.98	18.77	18.85	18.58	18.37	18.45
		RB25#24	18.83	18.93	18.86	18.43	18.53	18.46
		RB50#0	18.75	18.48	18.66	18.35	18.08	18.26
	16QAM	RB1#0	18.89	18.76	19.11	18.49	18.36	18.71
		RB1#24	18.64	18.53	18.73	18.24	18.13	18.33
		RB1#49	18.83	18.67	18.78	18.43	18.27	18.38
		RB25#0	18.66	19.01	18.74	18.26	18.61	18.34
		RB25#12	18.56	18.42	18.93	18.16	18.02	18.53
		RB25#24	17.38	18.74	18.69	16.98	18.34	18.29
		RB50#0	17.54	17.93	17.76	17.14	17.53	17.36

Bandwidth (MHz)	Modulation	RB size/ RB Offset	Conducted Average Output Power (dBm)			EIRP(dBm)		
			Low	Mid	High	Low	Mid	High
15	QPSK	RB1#0	18.97	19.03	18.88	18.57	18.63	18.48
		RB1#12	18.62	18.45	18.52	18.22	18.05	18.12
		RB1#24	18.42	18.92	19.03	18.02	18.52	18.63
		RB12#0	18.61	18.43	18.76	18.21	18.03	18.36
		RB12#6	19.15	18.87	19.29	18.75	18.47	18.89
		RB12#11	19.07	19.01	18.62	18.67	18.61	18.22
		RB25#0	18.78	18.76	18.54	18.38	18.36	18.14
	16QAM	RB1#0	18.95	18.84	18.85	18.55	18.44	18.45
		RB1#12	19.04	18.54	18.35	18.64	18.14	17.95
		RB1#24	18.87	18.49	18.33	18.47	18.09	17.93
		RB12#0	19.13	19.19	18.93	18.73	18.79	18.53
		RB12#6	18.59	18.72	18.73	18.19	18.32	18.33
		RB12#11	17.77	18.44	18.7	17.37	18.04	18.3
		RB25#0	17.56	17.64	17.78	17.16	17.24	17.38
20	QPSK	RB1#0	19.05	19.07	19.1	18.65	18.67	18.7
		RB1#24	18.61	19.06	18.3	18.21	18.66	17.9
		RB1#49	18.73	18.63	18.93	18.33	18.23	18.53
		RB25#0	19.04	18.73	18.79	18.64	18.33	18.39
		RB25#12	18.69	18.79	18.65	18.29	18.39	18.25
		RB25#24	18.57	18.83	18.83	18.17	18.43	18.43
		RB50#0	18.88	18.69	18.83	18.48	18.29	18.43
	16QAM	RB1#0	18.53	18.41	18.83	18.13	18.01	18.43
		RB1#24	18.97	18.67	19.08	18.57	18.27	18.68
		RB1#49	18.77	18.72	18.96	18.37	18.32	18.56
		RB25#0	18.89	18.78	18.47	18.49	18.38	18.07
		RB25#12	19.16	18.75	18.65	18.76	18.35	18.25
		RB25#24	17.91	18.63	18.36	17.51	18.23	17.96
		RB50#0	19.11	19.37	18.85	18.71	18.97	18.45

Note: ERP(dBm) = Conducted Power(dBm) + Antenna Gain(dBi)  
 For LTE Band41: Antenna Gain = -0.4dBi  
 Limit: EIRP ≤ 33dBm



**Peak-to-average ratio (PAR)****20MHz bandwidth**

<b>Modulation</b>	<b>Low channel (dB)</b>	<b>Middle channel (dB)</b>	<b>High channel (dB)</b>	<b>PAR Limit (dB)</b>	<b>Result</b>
QPSK (1RB Size)	4.69	4.14	4.79	13	Pass
QPSK (100RB Size)	5.52	5.51	5.22	13	Pass
16QAM (1RB Size)	5.34	5.54	5.60	13	Pass
16QAM (100RB Size)	6.96	6.34	6.08	13	Pass

**LTE Band 66:**

**Maximum Output Power**

Bandwidth (MHz)	Modulation	RB size/ RB Offset	Conducted Average Output Power (dBm)			EIRP(dBm)		
			Low	Mid	High	Low	Mid	High
1.4	QPSK	RB1#0	18.24	18.13	17.97	17.54	17.43	17.27
		RB1#2	18.52	18.61	18.24	17.82	17.91	17.54
		RB1#5	18.31	18.51	18.41	17.61	17.81	17.71
		RB3#0	18.28	18.57	18.01	17.58	17.87	17.31
		RB3#1	18.17	18.53	18.04	17.47	17.83	17.34
		RB3#2	17.62	17.42	17.35	16.92	16.72	16.65
		RB6#0	17.21	17.91	17.31	16.51	17.21	16.61
	16QAM	RB1#0	17.52	17.85	17.58	16.82	17.15	16.88
		RB1#2	17.63	17.52	17.47	16.93	16.82	16.77
		RB1#5	17.42	17.19	17.35	16.72	16.49	16.65
		RB3#0	17.22	17.29	17.18	16.52	16.59	16.48
		RB3#1	16.57	16.24	16.32	15.87	15.54	15.62
		RB3#2	17.87	18.28	18.06	17.17	17.58	17.36
		RB6#0	18.33	18.61	18.12	17.63	17.91	17.42
3.0	QPSK	RB1#0	18.46	18.36	18.64	17.76	17.66	17.94
		RB1#7	18.87	18.90	18.12	18.17	18.2	17.42
		RB1#14	18.53	18.33	18.33	17.83	17.63	17.63
		RB8#0	18.61	18.94	18.64	17.91	18.24	17.94
		RB8#4	18.70	18.96	18.62	18.00	18.26	17.92
		RB8#7	17.62	17.27	17.61	16.92	16.57	16.91
		RB15#0	17.97	17.75	17.46	17.27	17.05	16.76
	16QAM	RB1#0	17.74	17.48	17.58	17.04	16.78	16.88
		RB1#7	17.57	17.68	17.17	16.87	16.98	16.47
		RB1#14	17.64	17.47	17.84	16.94	16.77	17.14
		RB8#0	17.48	17.93	17.54	16.78	17.23	16.84
		RB8#4	16.64	16.81	16.42	15.94	16.11	15.72
		RB8#7	18.67	18.44	18.14	17.97	17.74	17.44
		RB15#0	18.07	18.16	18.27	17.37	17.46	17.57

Bandwidth (MHz)	Modulation	RB size/ RB Offset	Conducted Average Output Power (dBm)			EIRP(dBm)		
			Low	Mid	High	Low	Mid	High
5.0	QPSK	RB1#0	18.84	18.44	18.63	18.14	17.74	17.93
		RB1#12	18.61	18.80	18.88	17.91	18.1	18.18
		RB1#24	18.45	18.63	18.63	17.75	17.93	17.93
		RB12#0	16.81	16.62	17.14	16.11	15.92	16.44
		RB12#6	16.83	16.65	17.14	16.13	15.95	16.44
		RB12#11	17.76	17.42	17.06	17.06	16.72	16.36
		RB25#0	17.75	18.29	17.72	17.05	17.59	17.02
	16QAM	RB1#0	18.16	18.10	18.11	17.46	17.4	17.41
		RB1#12	18.02	18.09	17.89	17.32	17.39	17.19
		RB1#24	16.43	16.72	16.52	15.73	16.02	15.82
		RB12#0	16.80	16.31	16.84	16.10	15.61	16.14
		RB12#6	17.06	16.51	16.66	16.36	15.81	15.96
		RB12#11	16.93	16.90	16.42	16.23	16.2	15.72
		RB25#0	16.15	16.70	16.31	15.45	16.00	15.61
10.0	QPSK	RB1#0	17.78	18.26	17.61	17.08	17.56	16.91
		RB1#24	18.51	18.13	17.78	17.81	17.43	17.08
		RB1#49	18.21	18.11	17.71	17.51	17.41	17.01
		RB25#0	17.09	17.17	16.20	16.39	16.47	15.5
		RB25#12	16.86	16.38	16.99	16.16	15.68	16.29
		RB25#24	16.59	16.97	16.57	15.89	16.27	15.87
		RB50#0	17.14	16.97	16.81	16.44	16.27	16.11
	16QAM	RB1#0	17.22	17.27	17.31	16.52	16.57	16.61
		RB1#24	17.21	16.96	17.06	16.51	16.26	16.36
		RB1#49	16.61	16.82	16.45	15.91	16.12	15.75
		RB25#0	16.00	16.14	16.42	15.3	15.44	15.72
		RB25#12	15.98	16.83	16.67	15.28	16.13	15.97
		RB25#24	15.99	16.10	16.08	15.29	15.4	15.38
		RB50#0	15.93	16.42	16.03	15.23	15.72	15.33

Bandwidth (MHz)	Modulation	RB size/ RB Offset	Conducted Average Output Power (dBm)			EIRP(dBm)		
			Low	Mid	High	Low	Mid	High
15.0	QPSK	RB1#0	18.57	18.77	18.74	17.87	18.07	18.04
		RB1#37	18.27	18.58	18.76	17.57	17.88	18.06
		RB1#74	18.71	18.39	18.85	18.01	17.69	18.15
		RB36#0	18.24	18.83	18.88	17.54	18.13	18.18
		RB36#18	18.83	18.41	18.71	18.13	17.71	18.01
		RB36#37	17.67	17.86	17.82	16.97	17.16	17.12
		RB75#0	17.31	17.69	17.20	16.61	16.99	16.5
	16QAM	RB1#0	17.98	17.94	17.43	17.28	17.24	16.73
		RB1#37	17.70	17.65	18.07	17.00	16.95	17.37
		RB1#74	17.91	18.02	18.11	17.21	17.32	17.41
		RB36#0	17.63	17.59	17.53	16.93	16.89	16.83
		RB36#18	17.57	17.58	17.92	16.87	16.88	17.22
		RB36#37	16.83	16.49	16.35	16.13	15.79	15.65
		RB75#0	16.38	16.42	16.58	15.68	15.72	15.88
20.0	QPSK	RB1#0	18.60	18.54	18.93	17.90	17.84	18.23
		RB1#49	18.71	18.73	18.50	18.01	18.03	17.8
		RB1#99	18.31	18.76	18.39	17.61	18.06	17.69
		RB50#0	17.57	17.75	17.55	16.87	17.05	16.85
		RB50#24	17.44	17.42	17.43	16.74	16.72	16.73
		RB50#49	17.58	17.76	17.49	16.88	17.06	16.79
		RB100#0	17.47	17.23	17.47	16.77	16.53	16.77
	16QAM	RB1#0	17.95	17.69	17.61	17.25	16.99	16.91
		RB1#49	17.74	17.74	17.74	17.04	17.04	17.04
		RB1#99	17.49	17.71	17.87	16.79	17.01	17.17
		RB50#0	16.87	16.36	16.85	16.17	15.66	16.15
		RB50#24	16.73	16.37	16.34	16.03	15.67	15.64
		RB50#49	16.60	16.67	16.42	15.9	15.97	15.72
		RB100#0	16.28	16.30	16.33	15.58	15.6	15.63

Note: EIRP(dBm) = Conducted Power(dBm) + Antenna Gain(dBi)  
 For LTE Band 66: Antenna Gain = -0.7dBi  
 The Limit: EIRP ≤ 30dBm

**Peak-to-average ratio (PAR)****20MHz bandwidth**

<b>Modulation</b>	<b>Low channel (dB)</b>	<b>Middle channel (dB)</b>	<b>High channel (dB)</b>	<b>PAR Limit (dB)</b>	<b>Result</b>
QPSK (1RB Size)	4.72	4.87	4.40	13	Pass
QPSK (100RB Size)	5.21	5.31	5.26	13	Pass
16QAM (1RB Size)	4.99	4.96	4.85	13	Pass
16QAM (100RB Size)	6.07	5.64	6.42	13	Pass

**FCC §2.1049, §22.917, §22.905 & §24.238 & §27.53 - OCCUPIED BANDWIDTH**

**Applicable Standard**

FCC 47 §2.1049, §22.917, §22.905, §24.238 and §27.53.

**Test Procedure**

The RF output of the transmitter was connected to the simulator and the spectrum analyzer through sufficient attenuation.

The resolution bandwidth of the spectrum analyzer was set at 1% to 5% of the anticipated emission bandwidth and the 26 dB & 99% bandwidth was recorded.

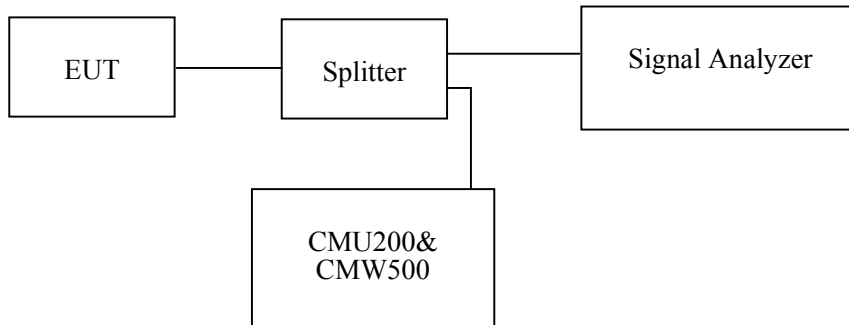

**Test Data**

**Environmental Conditions**

<b>Temperature:</b>	25 °C
<b>Relative Humidity:</b>	55 %
<b>ATM Pressure:</b>	101.0 kPa

*The testing was performed by Coco Liu from 2021-02-19 to 2021-04-13.*

*EUT operation mode: Transmitting*

**Test Result: Pass**

*Please refer to the following tables and plots.*

**Cellular Band (Part 22H)**

Mode	Channel	Frequency (MHz)	99% Occupied Bandwidth (kHz)	26 dB Emission Bandwidth (kHz)
GSM(GMSK)	128	824.2	243.590	325.321
	190	836.6	245.192	312.500
	251	848.8	246.795	320.513
EGPRS(8PSK)	128	824.2	248.397	326.923
	190	836.6	246.795	317.308
	251	848.8	248.397	322.115

	Frequency (MHz)	Occupied Bandwidth (MHz)	26dB Bandwidth (MHz)
RMC	826.4	4.167	4.750
	836.6	4.167	4.712
	846.6	4.167	4.737
HSDPA	826.4	4.199	4.958
	836.6	4.215	4.824
	846.6	4.199	4.824
HSUPA	826.4	4.199	5.119
	836.6	4.199	4.696
	846.6	4.167	4.676

**PCS Band (Part 24E)**

Mode	Channel	Frequency (MHz)	99% Occupied Bandwidth (kHz)	26 dB Emission Bandwidth (kHz)
GSM(GMSK)	512	1850.2	248.397	310.897
	661	1880.0	245.192	314.103
	810	1909.8	246.795	317.308
EGPRS(8PSK)	512	1850.2	250.000	323.718
	661	1880.0	251.603	313.141
	810	1909.8	254.808	318.910

Frequency (MHz)		Occupied Bandwidth (MHz)	26dB Bandwidth (MHz)
RMC	1852.4	4.183	4.712
	1880.0	4.183	4.728
	1907.6	4.183	4.724
HSDPA	1852.4	4.199	4.728
	1880.0	4.183	4.734
	1907.6	4.199	5.096
HSUPA	1852.4	4.215	5.080
	1880.0	4.215	4.968
	1907.6	4.183	4.728

**AWS Band (Part 27)**

Frequency (MHz)		Occupied Bandwidth (MHz)	26dB Bandwidth (MHz)
RMC	1712.4	4.167	4.744
	1732.6	4.183	4.721
	1752.6	4.183	4.728
HSDPA	1712.4	4.199	4.808
	1732.6	4.151	4.699
	1752.6	4.199	5.080
HSUPA	1712.4	4.167	4.728
	1732.6	4.151	4.686
	1752.6	4.183	4.734



**Cellular Band (Part 22H)**

**26 dB Emissions & 99% Occupied Bandwidth for GSM (GMSK) Mode, Low channel**

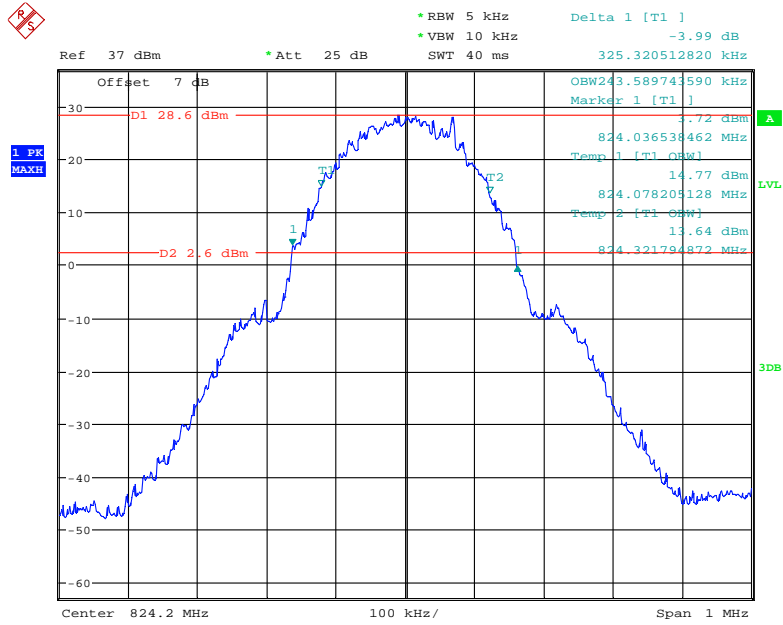

Date: 24.FEB.2021 16:43:08

**26 dB Emissions & 99% Occupied Bandwidth for GSM (GMSK) Mode, Middle channel**

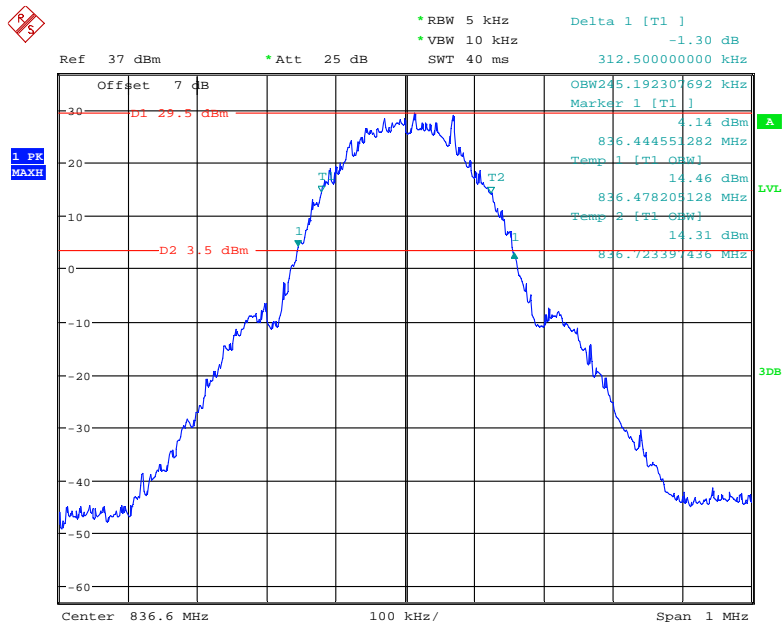

Date: 24.FEB.2021 16:44:51

**26 dB Emissions & 99% Occupied Bandwidth for GSM (GMSK) Mode, High channel**

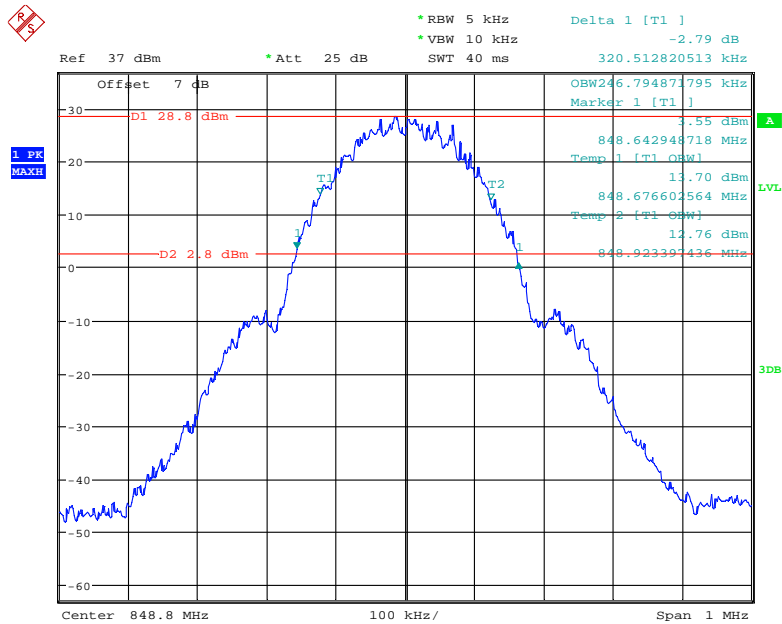

Date: 24.FEB.2021 16:45:56

**26 dB Emissions & 99% Occupied Bandwidth for EGPRS (8PSK) Mode, Low channel**

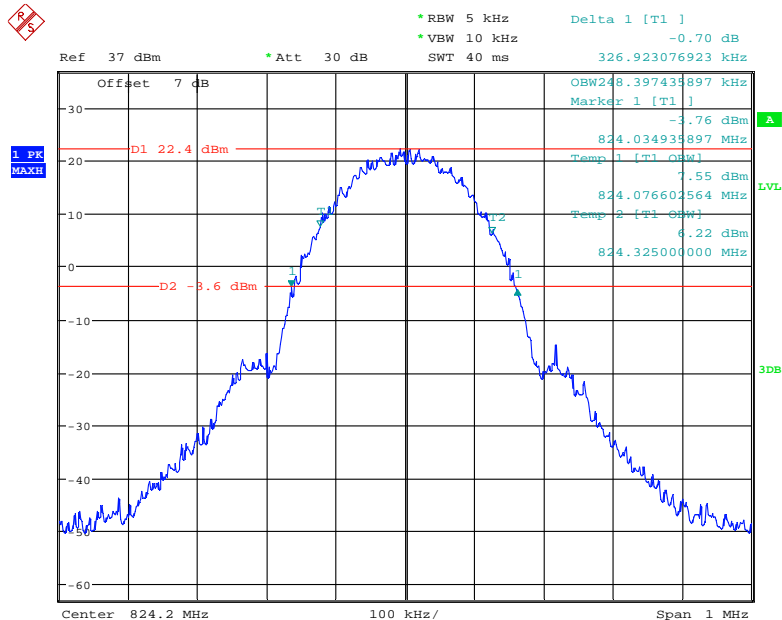

Date: 21.FEB.2021 14:34:30

26 dB Emissions & 99% Occupied Bandwidth for EGPRS (8PSK) Mode, Middle channel

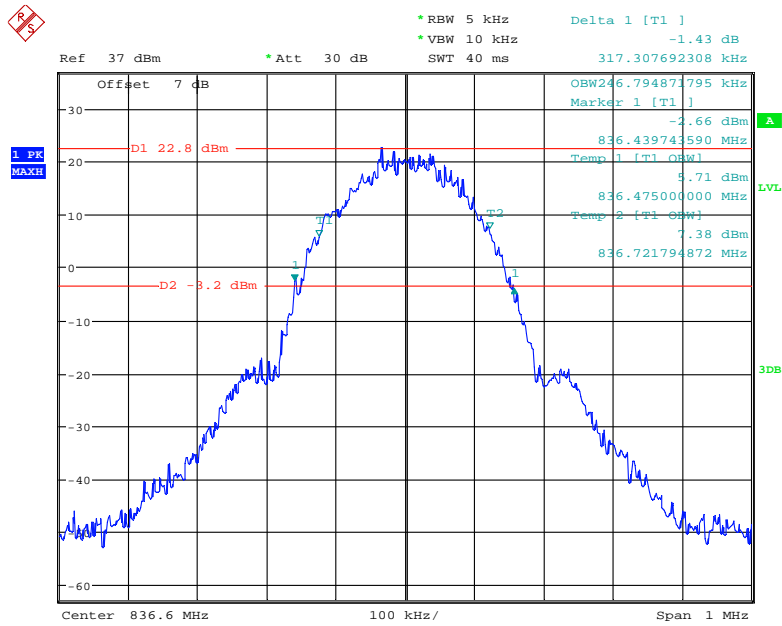

Date: 21.FEB.2021 14:32:54

26 dB Emissions & 99% Occupied Bandwidth for EGPRS (8PSK) Mode, High channel

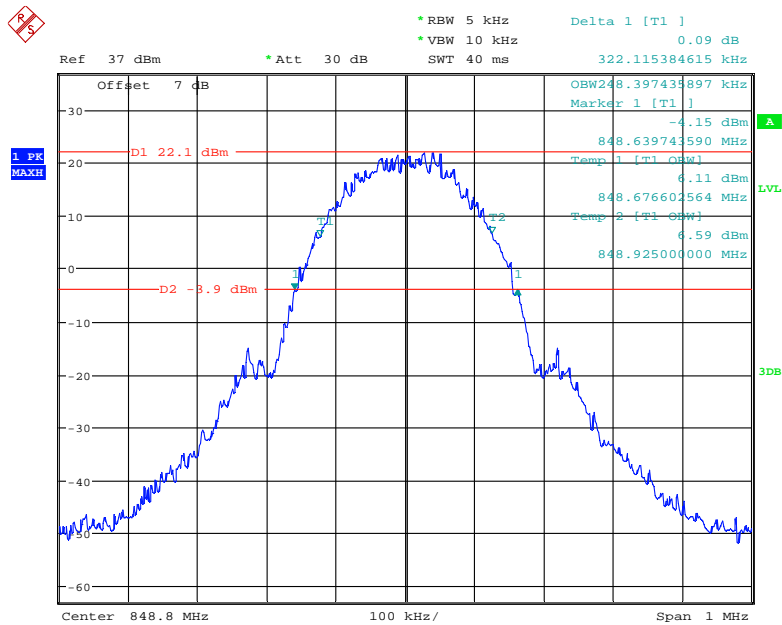

Date: 21.FEB.2021 14:31:10

**26 dB Emissions & 99% Occupied Bandwidth for RMC (BPSK) Mode, Low channel**

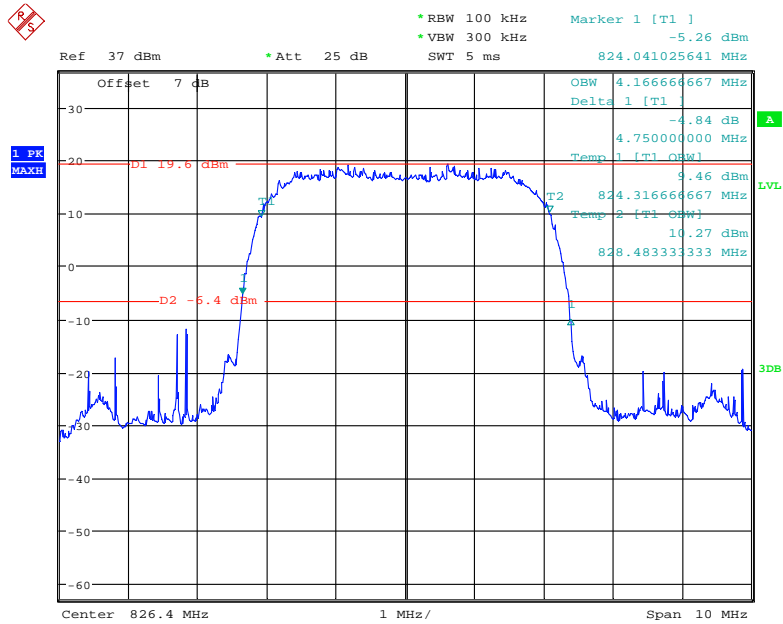

Date: 21.MAR.2021 16:03:49

**26 dB Emissions & 99% Occupied Bandwidth for RMC (BPSK) Mode, Middle channel**

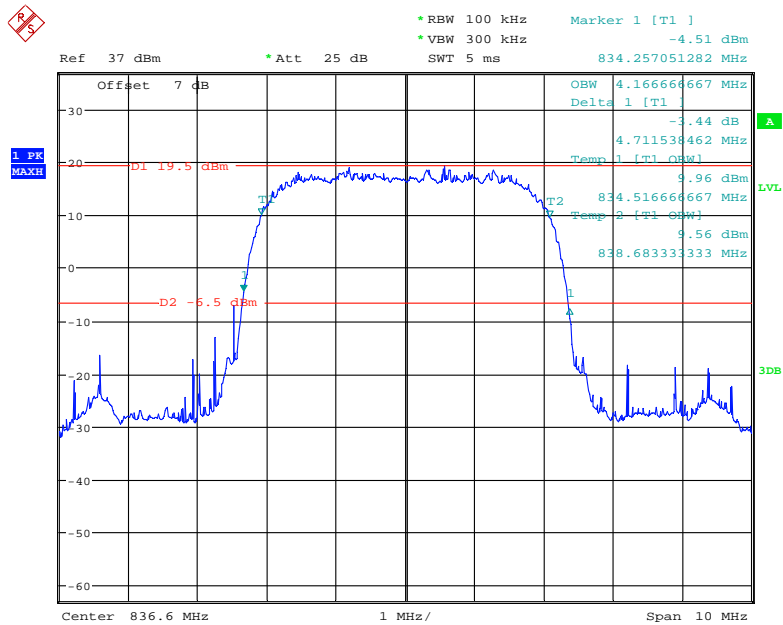

Date: 21.MAR.2021 16:06:23

**26 dB Emissions & 99% Occupied Bandwidth for RMC (BPSK) Mode, High channel**

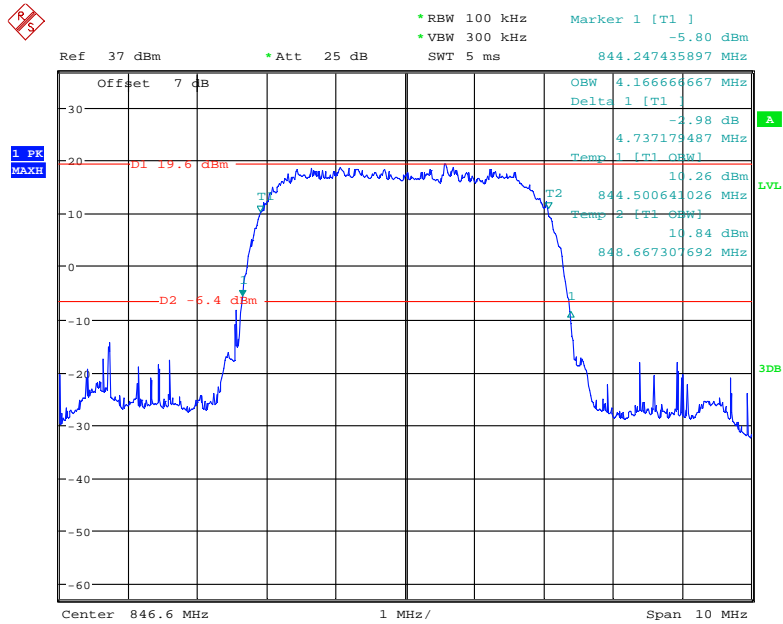

Date: 21.MAR.2021 16:08:46

**26 dB Emissions & 99% Occupied Bandwidth for HSUPA (BPSK) Mode, Low channel**

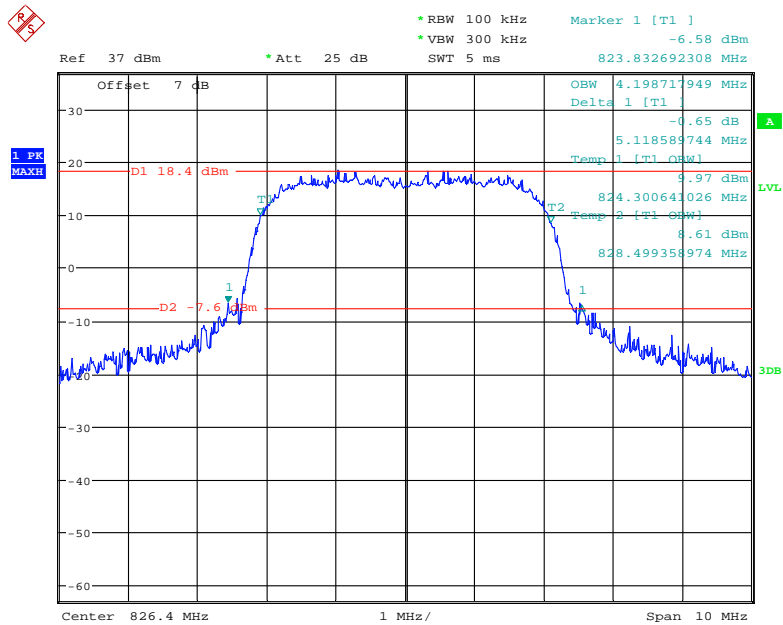

Date: 21.MAR.2021 15:57:17

**26 dB Emissions & 99% Occupied Bandwidth for HSUPA (BPSK) Mode, Middle channel**

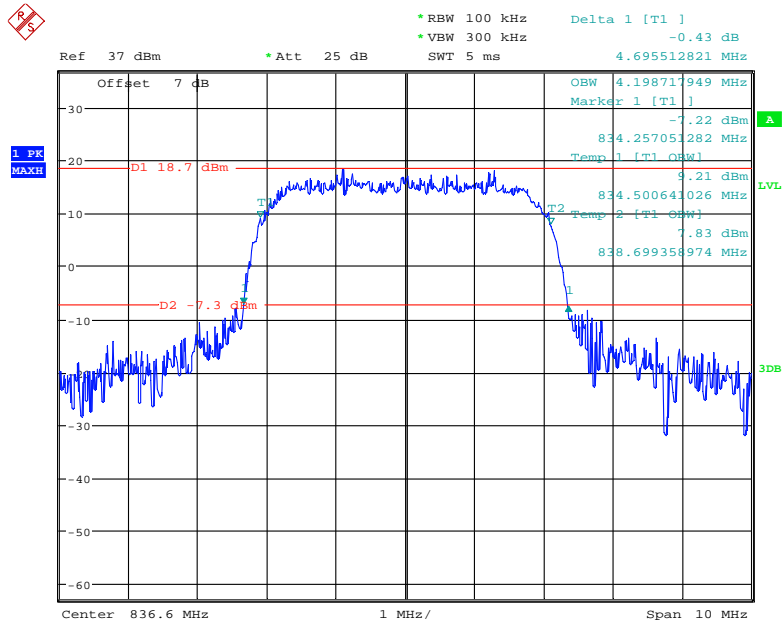

Date: 21.MAR.2021 15:55:55

**26 dB Emissions & 99% Occupied Bandwidth for HSUPA (BPSK) Mode, High channel**

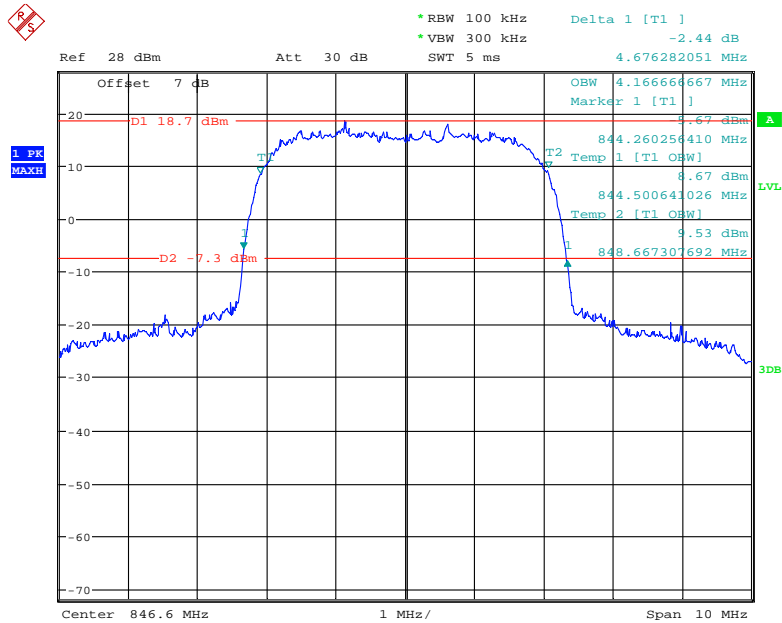

Date: 31.MAR.2021 17:12:21

**26 dB Emissions & 99% Occupied Bandwidth for HSDPA (16QAM) Mode, Low channel**

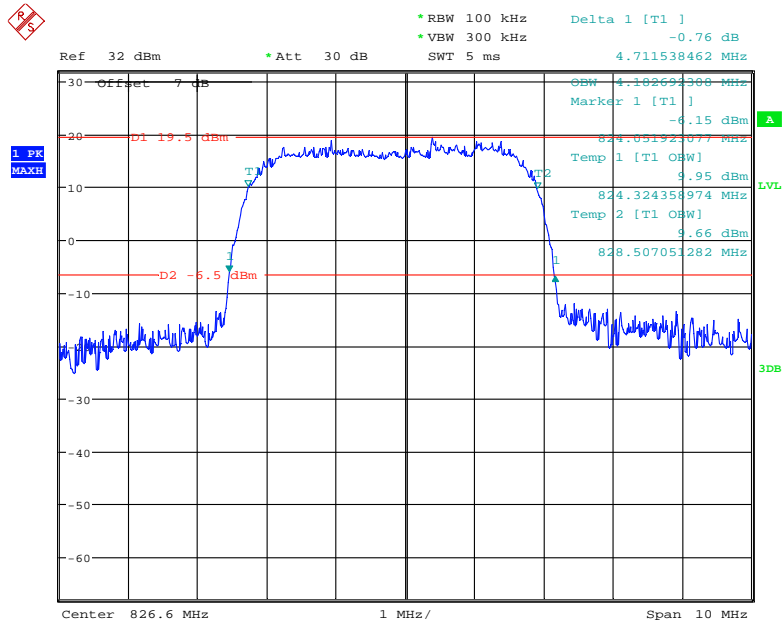

Date: 13.APR.2021 16:15:56

**26 dB Emissions & 99% Occupied Bandwidth for HSDPA (16QAM) Mode, Middle channel**

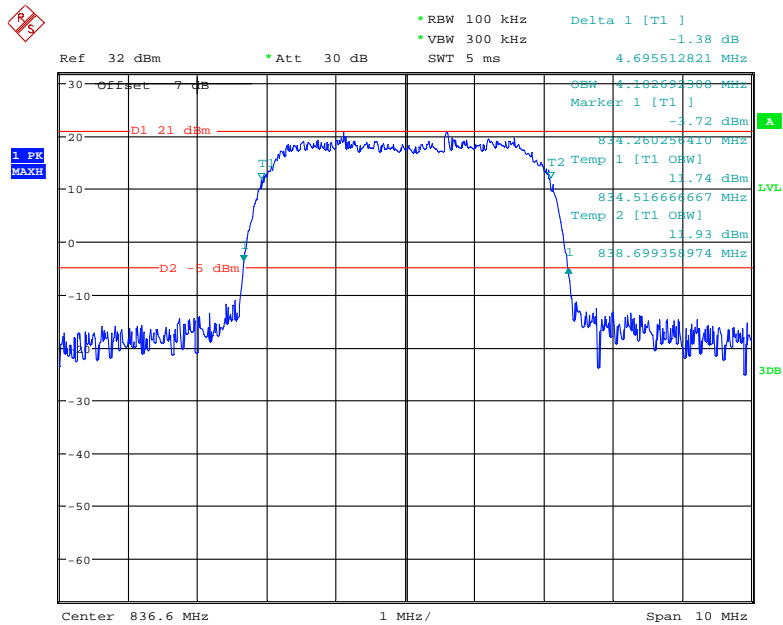

Date: 13.APR.2021 15:59:54

26 dB Emissions & 99% Occupied Bandwidth for HSDPA (16QAM) Mode, High channel

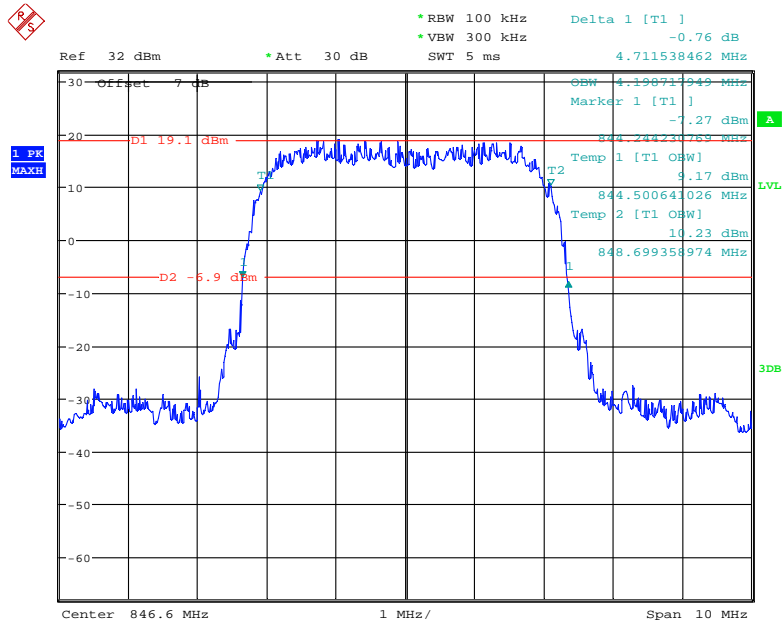

Date: 13.APR.2021 15:57:57



PCS Band (Part 24E)

26 dB Emissions & 99% Occupied Bandwidth for GSM (GMSK) Mode, Low channel

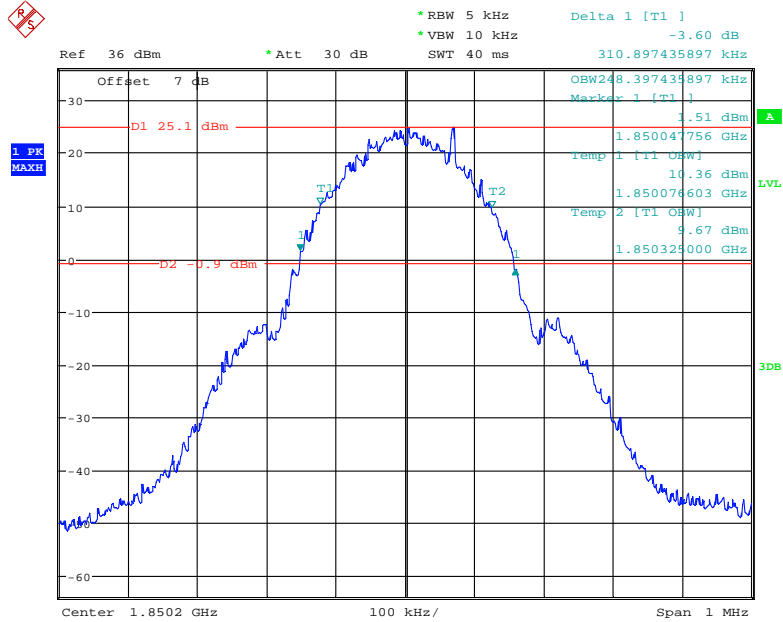

Date: 21.FEB.2021 15:03:06

26 dB Emissions & 99% Occupied Bandwidth for GSM (GMSK) Mode, Middle channel

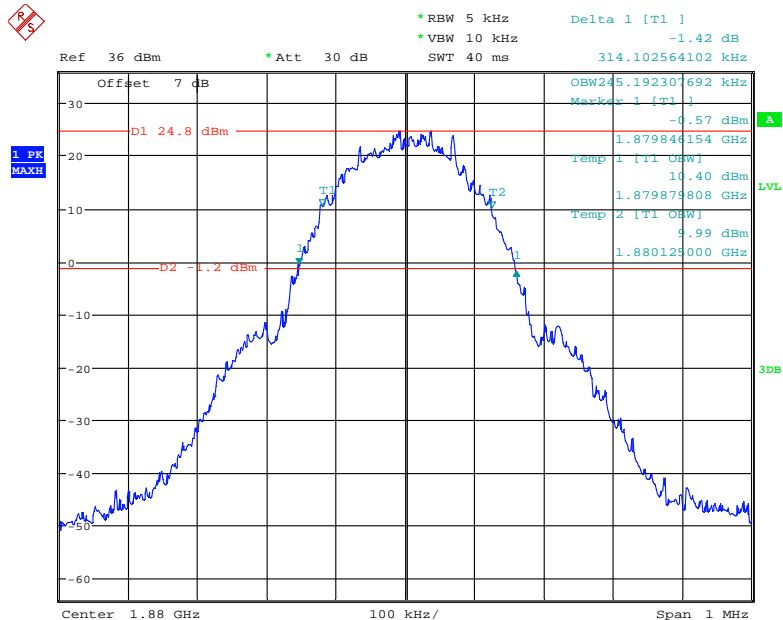

Date: 21.FEB.2021 15:01:50

**26 dB Emissions & 99% Occupied Bandwidth for GSM (GMSK) Mode, High channel**

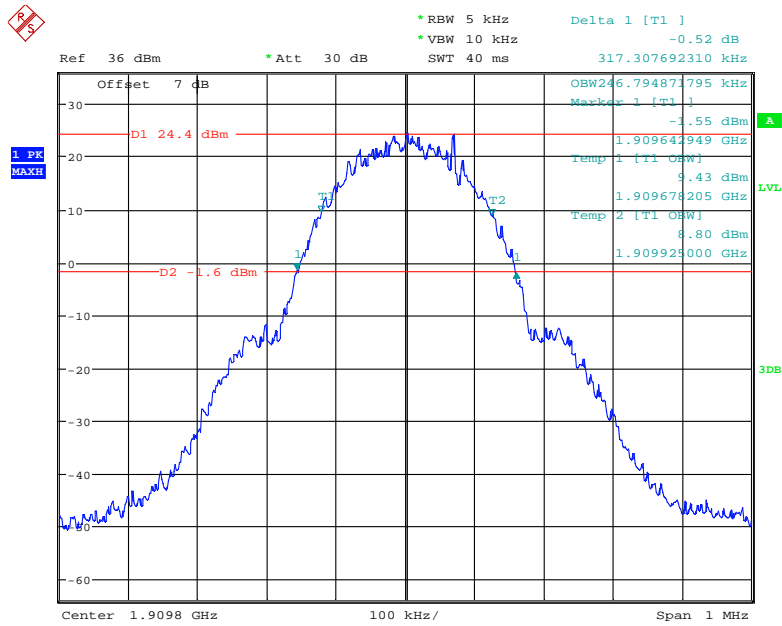

Date: 21.FEB.2021 15:00:24

**26 dB Emissions & 99% Occupied Bandwidth for EGPRS (8PSK) Mode, Low channel**

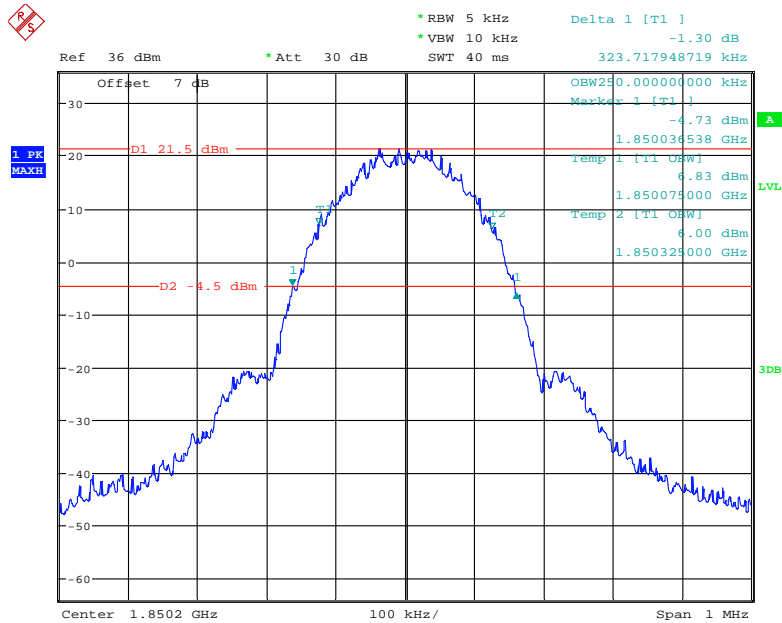

Date: 21.FEB.2021 15:17:06

**26 dB Emissions & 99% Occupied Bandwidth for EGPRS (8PSK) Mode, Middle channel**

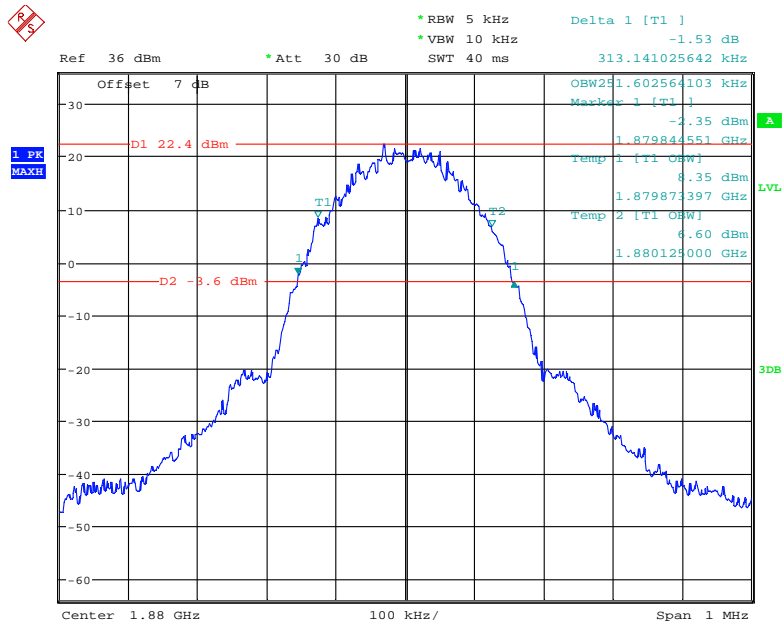

Date: 21.FEB.2021 15:18:53

**26 dB Emissions & 99% Occupied Bandwidth for EGPRS (8PSK) Mode, High channel**

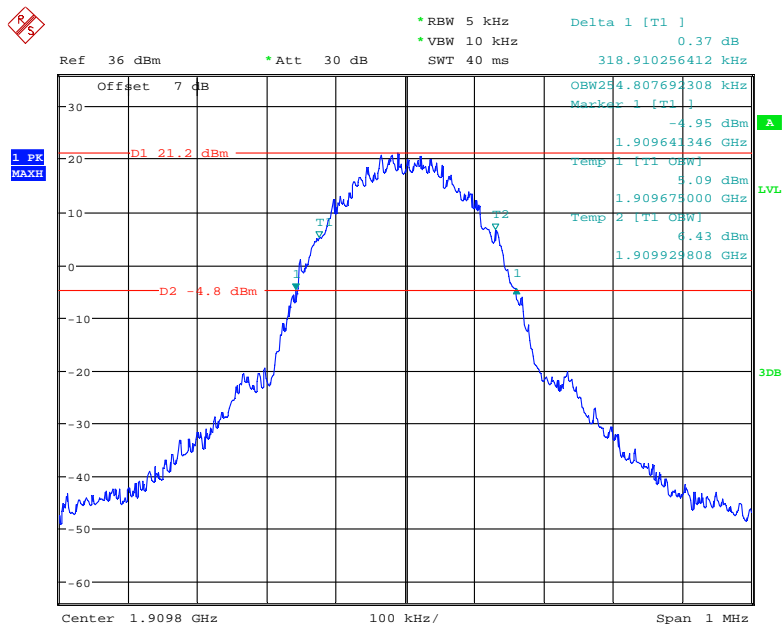

Date: 21.FEB.2021 15:19:55

**26 dB Emissions & 99% Occupied Bandwidth for RMC (BPSK) Mode, Low channel**

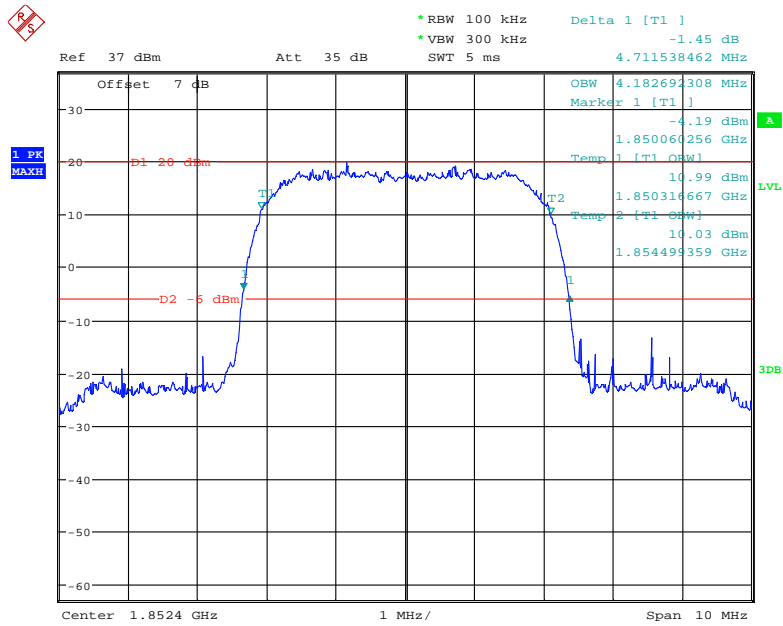

Date: 21.FEB.2021 15:32:34

**26 dB Emissions & 99% Occupied Bandwidth for RMC (BPSK) Mode, Middle channel**

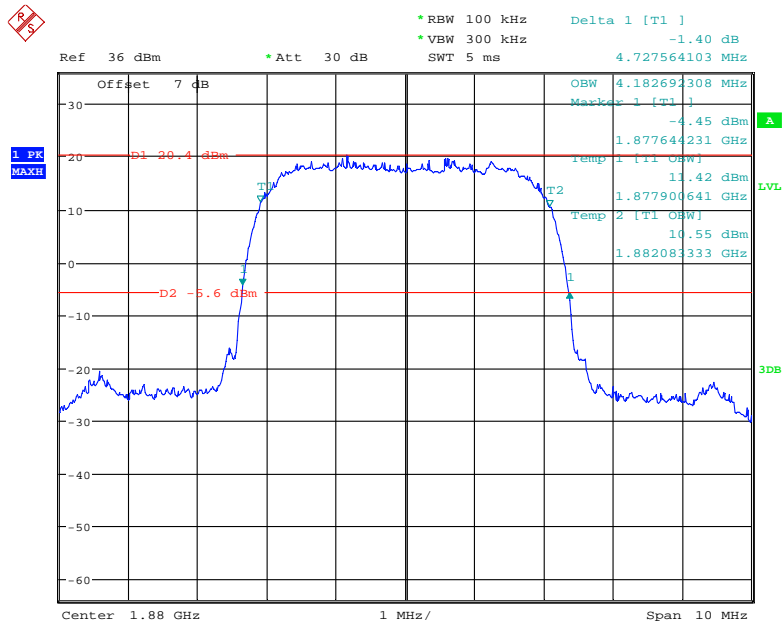

Date: 21.FEB.2021 15:30:14

**26 dB Emissions & 99% Occupied Bandwidth for RMC (BPSK) Mode, High channel**

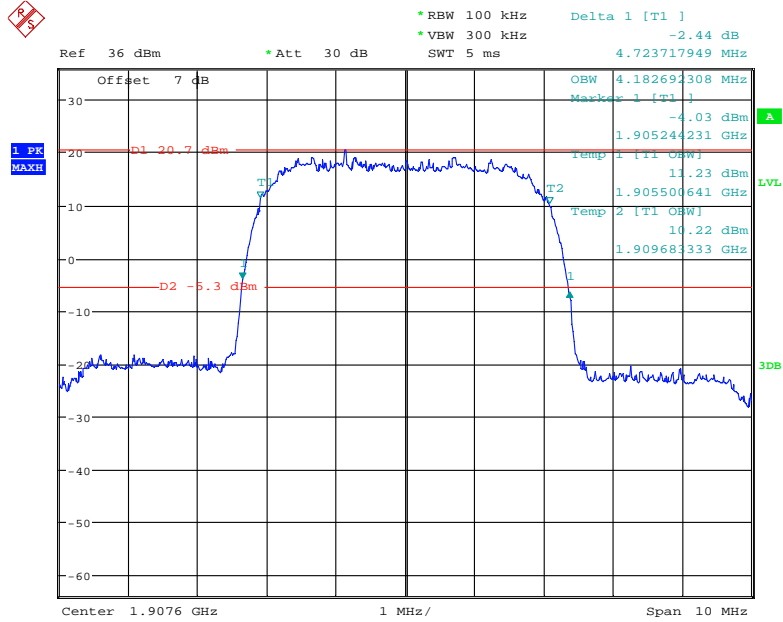

Date: 21.FEB.2021 15:28:45

**26 dB Emissions & 99% Occupied Bandwidth for HSUPA (BPSK) Mode, Low channel**

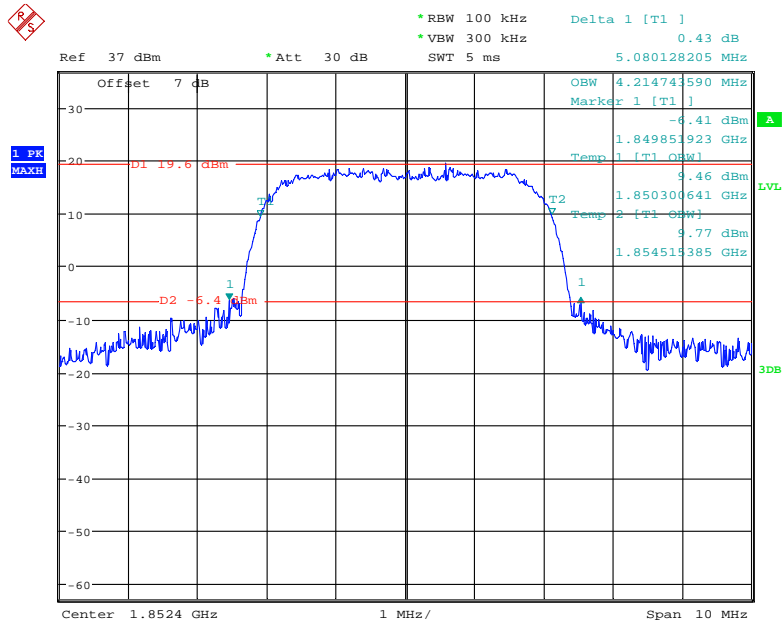

Date: 21.FEB.2021 15:55:36

**26 dB Emissions & 99% Occupied Bandwidth for HSUPA (BPSK) Mode, Middle channel**

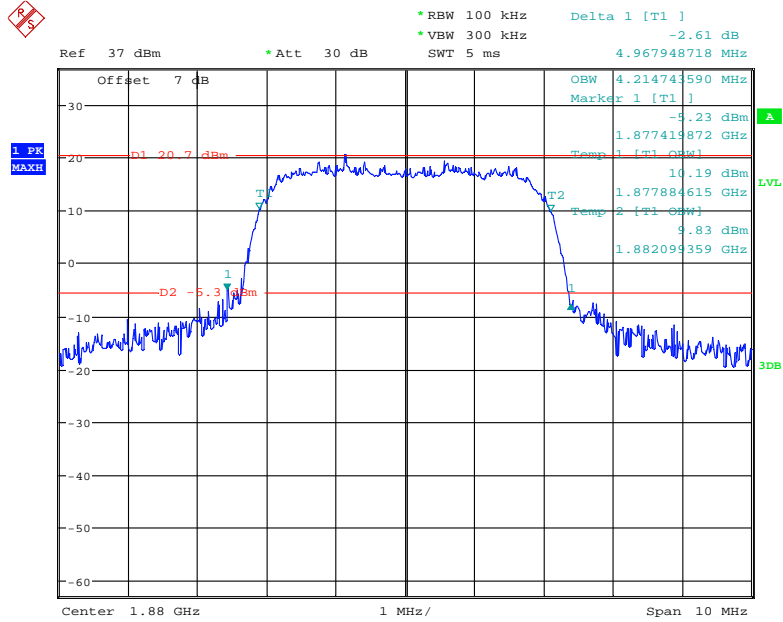

Date: 21.FEB.2021 15:53:51

**26 dB Emissions & 99% Occupied Bandwidth for HSUPA (BPSK) Mode, High channel**

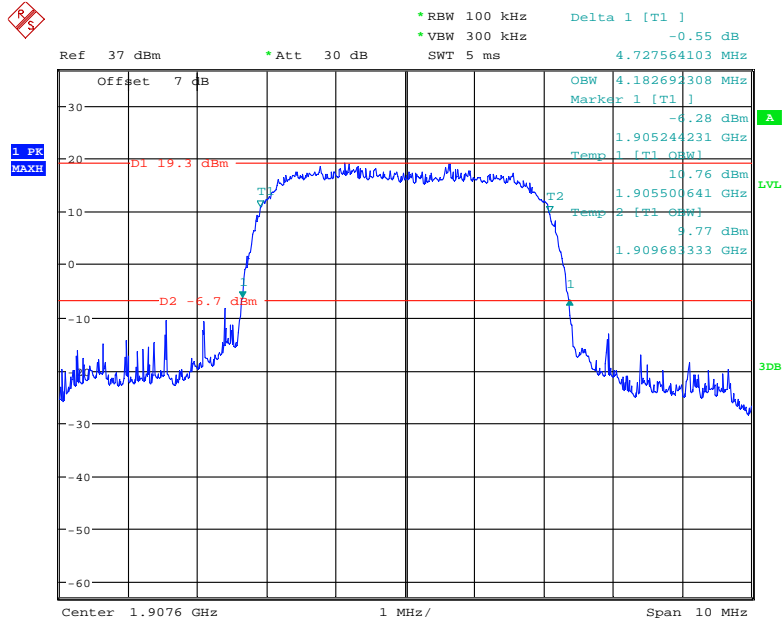

Date: 21.FEB.2021 15:50:11

**26 dB Emissions & 99% Occupied Bandwidth for HSDPA (16QAM) Mode, Low channel**

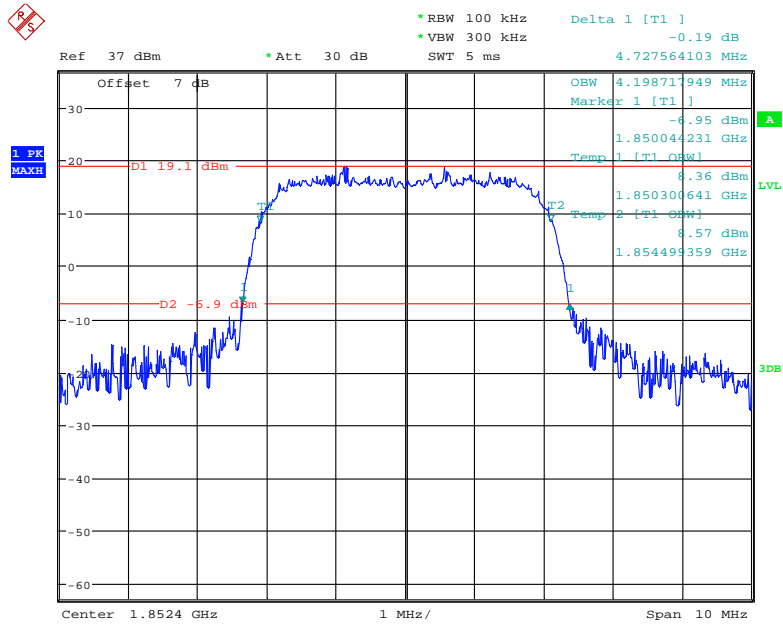

Date: 21.FEB.2021 15:56:47

**26 dB Emissions & 99% Occupied Bandwidth for HSDPA (16QAM) Mode, Middle channel**

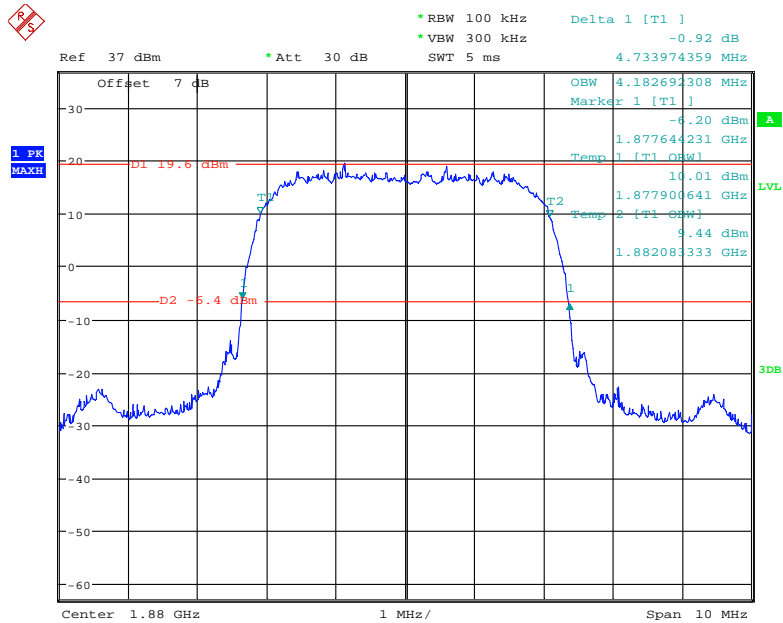

Date: 21.FEB.2021 15:58:03

**26 dB Emissions & 99% Occupied Bandwidth for HSDPA (16QAM) Mode, High channel**

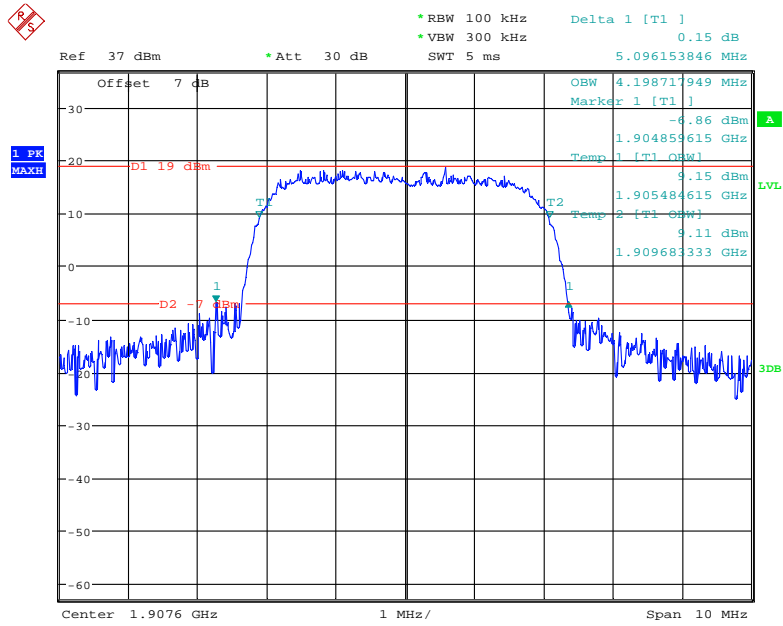

Date: 21.FEB.2021 15:59:20



**AWS Band (Part 27)**

**26 dB Emissions & 99% Occupied Bandwidth for RMC (BPSK) Mode, Low channel**

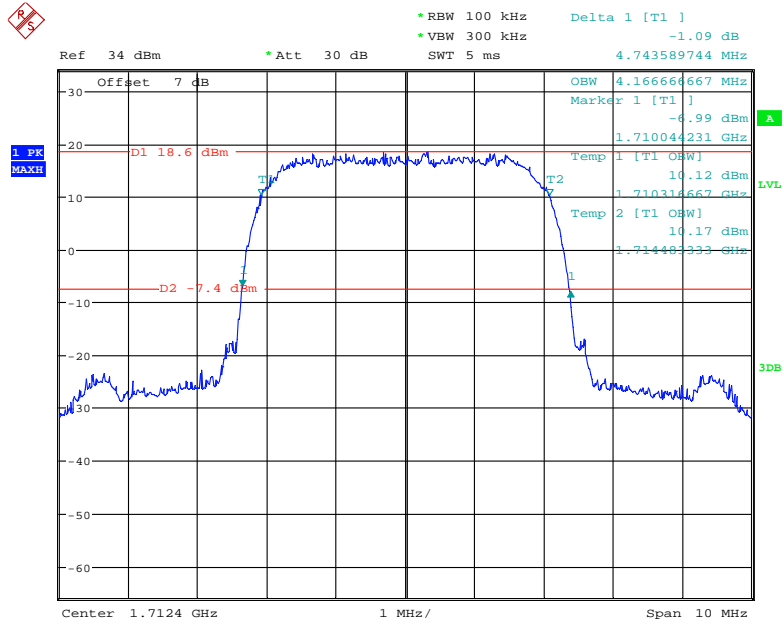

Date: 21.FEB.2021 16:06:42

**26 dB Emissions & 99% Occupied Bandwidth for RMC (BPSK) Mode, Middle channel**

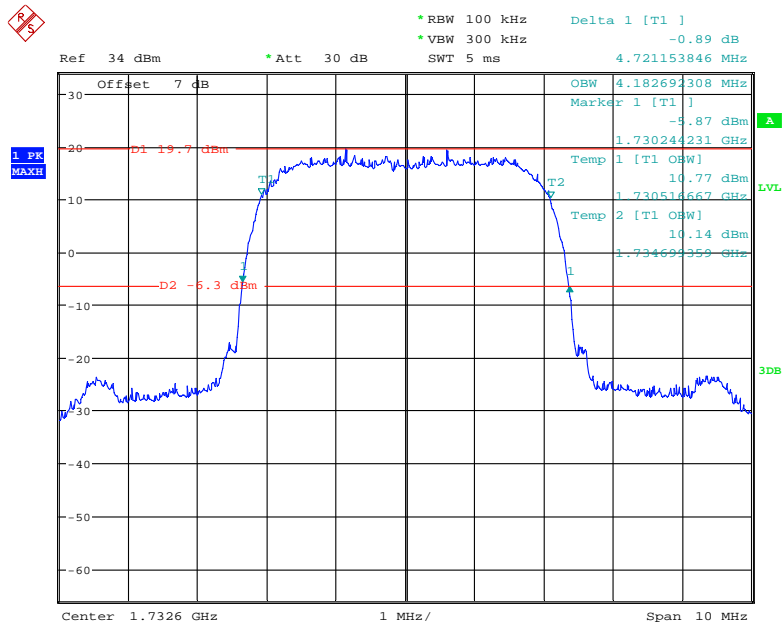

Date: 21.FEB.2021 16:07:47

**26 dB Emissions & 99% Occupied Bandwidth for RMC (BPSK) Mode, High channel**

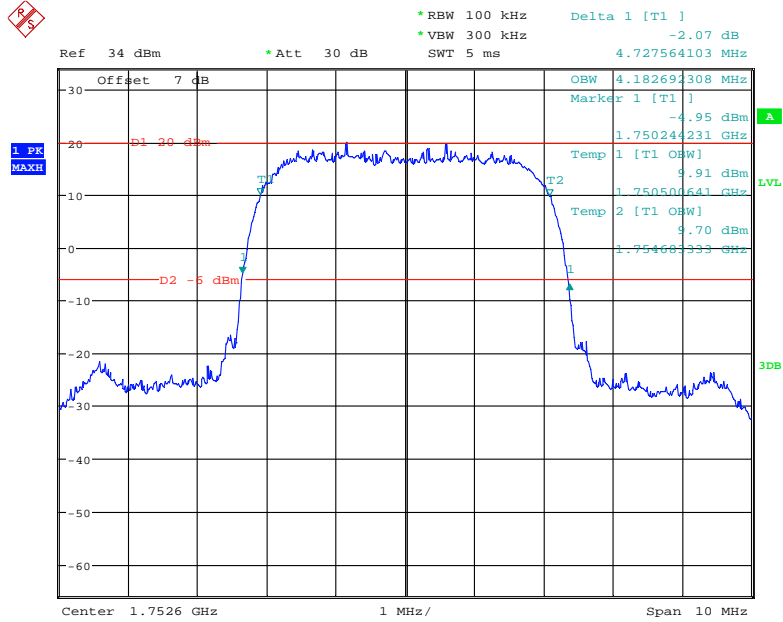

Date: 21.FEB.2021 16:08:35

**26 dB Emissions & 99% Occupied Bandwidth for HSUPA (BPSK) Mode, Low channel**

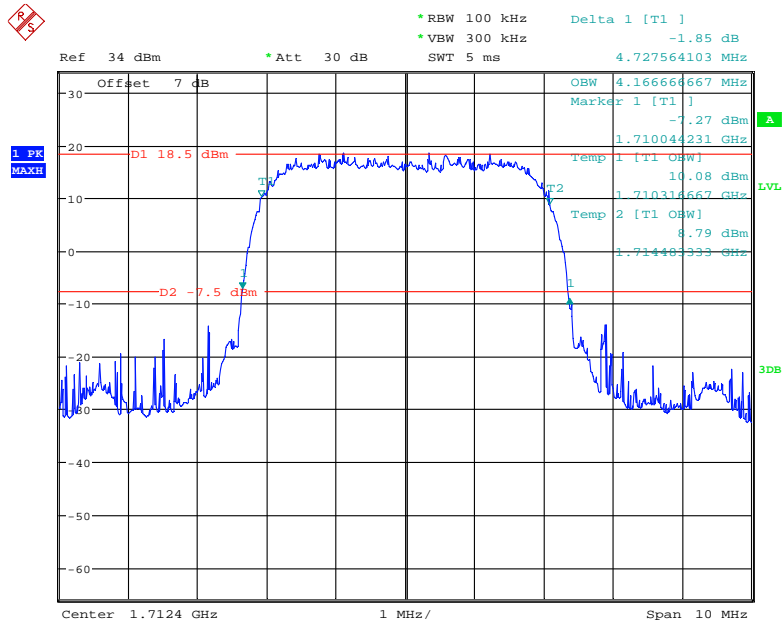

Date: 21.FEB.2021 16:20:18

**26 dB Emissions & 99% Occupied Bandwidth for HSUPA (BPSK) Mode, Middle channel**

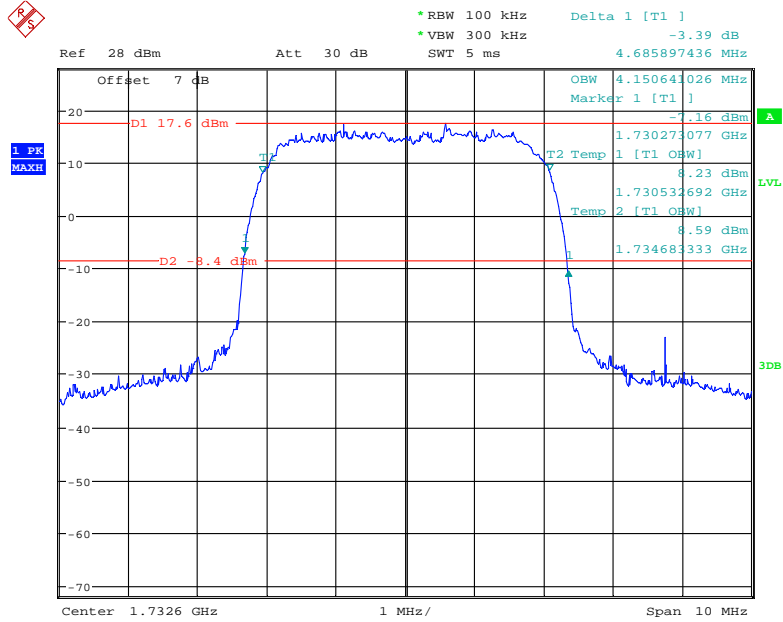

Date: 31.MAR.2021 17:10:05

**26 dB Emissions & 99% Occupied Bandwidth for HSUPA (BPSK) Mode, High channel**

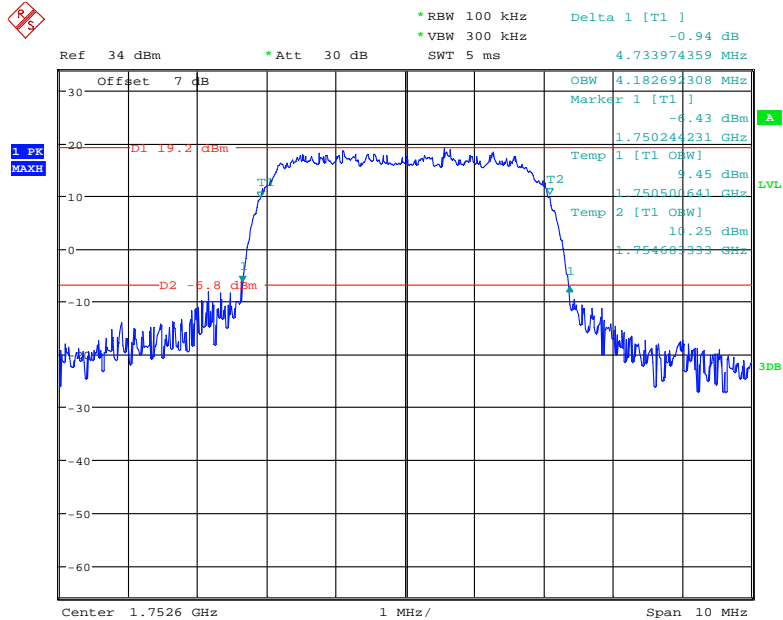

Date: 21.FEB.2021 16:22:42

**26 dB Emissions & 99% Occupied Bandwidth for HSDPA (16QAM) Mode, Low channel**

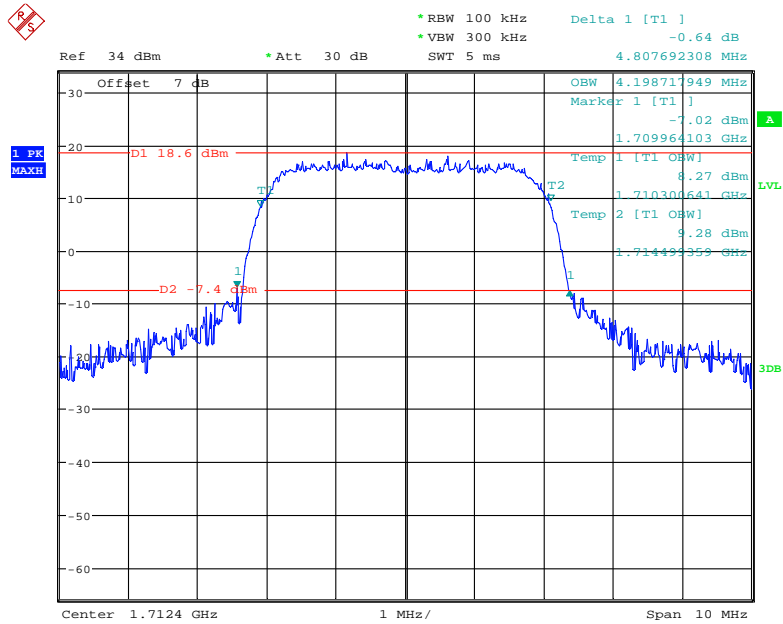

Date: 21.FEB.2021 16:14:10

**26 dB Emissions & 99% Occupied Bandwidth for HSDPA (16QAM) Mode, Middle channel**

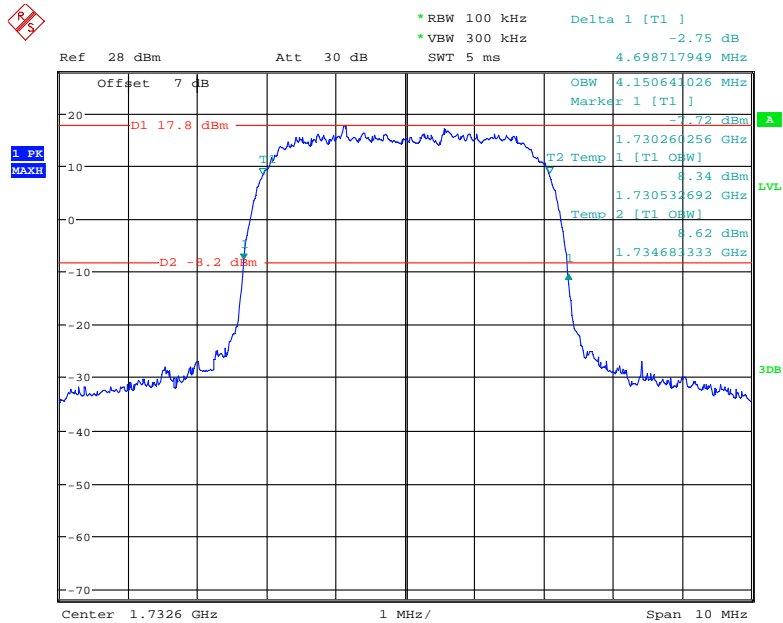

Date: 31.MAR.2021 17:29:18

26 dB Emissions & 99% Occupied Bandwidth for HSDPA (16QAM) Mode, High channel

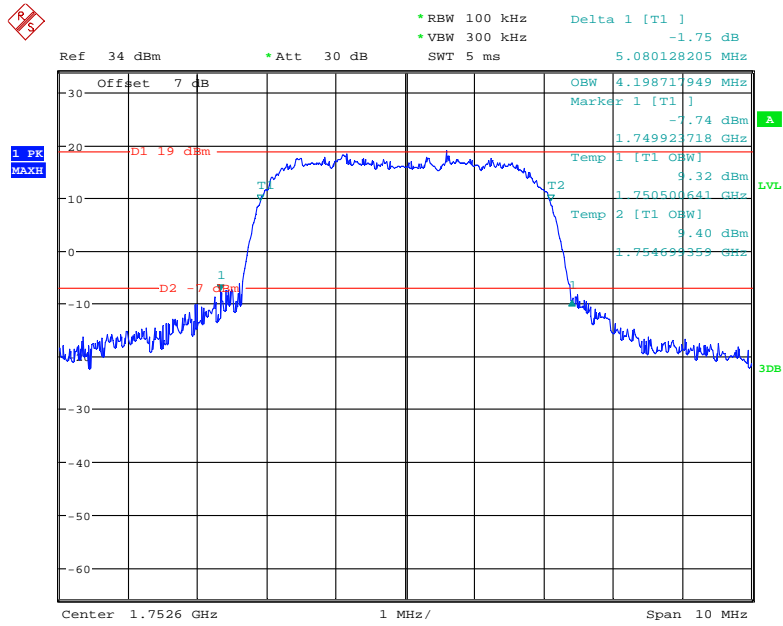

Date: 21.FEB.2021 16:11:39

**LTE Band 2:**

Bandwidth (MHz)	Modulation	Channel	99% Occupied Bandwidth (MHz)	26 dB Emission Bandwidth (MHz)
1.4	QPSK	Low	1.104	1.308
		Middle	1.110	1.308
		High	1.104	1.308
	16QAM	Low	1.098	1.332
		Middle	1.098	1.308
		High	1.098	1.284
3	QPSK	Low	2.688	2.880
		Middle	2.700	2.892
		High	2.688	2.892
	16QAM	Low	2.688	2.880
		Middle	2.688	2.892
		High	2.688	2.880
5	QPSK	Low	4.500	4.960
		Middle	4.520	4.980
		High	4.520	4.920
	16QAM	Low	4.500	4.940
		Middle	4.520	4.980
		High	4.520	4.920
10	QPSK	Low	8.960	9.680
		Middle	8.960	9.600
		High	8.960	9.560
	16QAM	Low	8.960	9.560
		Middle	8.960	9.640
		High	8.960	9.560
15	QPSK	Low	13.560	14.820
		Middle	13.500	14.820
		High	13.500	14.760
	16QAM	Low	13.560	14.880
		Middle	13.500	14.700
		High	13.500	14.820
20	QPSK	Low	18.000	19.520
		Middle	17.920	19.360
		High	18.000	19.440
	16QAM	Low	18.000	19.520
		Middle	18.000	19.360
		High	17.920	19.520

**Band 4:**

Bandwidth (MHz)	Modulation	Channel	99% Occupied Bandwidth (MHz)	26 dB Emission Bandwidth (MHz)
1.4	QPSK	Low	1.110	1.290
		Middle	1.104	1.290
		High	1.110	1.290
	16QAM	Low	1.098	1.290
		Middle	1.098	1.284
		High	1.098	1.284
3	QPSK	Low	2.688	2.892
		Middle	2.688	2.868
		High	2.688	2.892
	16QAM	Low	2.688	2.868
		Middle	2.688	2.880
		High	2.676	2.892
5	QPSK	Low	4.500	5.000
		Middle	4.520	4.940
		High	4.520	4.940
	16QAM	Low	4.540	5.680
		Middle	4.520	4.980
		High	4.520	4.960
10	QPSK	Low	8.960	10.280
		Middle	8.960	9.600
		High	8.960	9.640
	16QAM	Low	8.960	9.560
		Middle	8.960	9.640
		High	8.960	9.640
15	QPSK	Low	13.620	15.480
		Middle	13.500	14.760
		High	13.560	14.820
	16QAM	Low	13.620	17.040
		Middle	13.500	14.880
		High	13.500	14.760
20	QPSK	Low	18.000	19.520
		Middle	18.000	21.040
		High	17.920	19.600
	16QAM	Low	18.000	19.360
		Middle	18.000	19.280
		High	17.920	19.360

**Band 5:**

Bandwidth (MHz)	Modulation	Channel	99% Occupied Bandwidth (MHz)	26 dB Emission Bandwidth (MHz)
1.4	QPSK	Low	1.110	1.308
		Middle	1.092	1.302
		High	1.110	1.290
	16QAM	Low	1.098	1.284
		Middle	1.092	1.284
		High	1.098	1.290
3	QPSK	Low	2.688	2.892
		Middle	2.688	2.892
		High	2.688	2.892
	16QAM	Low	2.688	2.880
		Middle	2.676	2.868
		High	2.676	2.880
5	QPSK	Low	4.500	4.920
		Middle	4.520	4.960
		High	4.500	4.900
	16QAM	Low	4.520	4.980
		Middle	4.520	4.940
		High	4.520	4.960
10	QPSK	Low	8.960	9.600
		Middle	8.960	9.600
		High	8.960	9.560
	16QAM	Low	8.960	9.560
		Middle	8.960	9.560
		High	8.960	9.600



**Band 7**

Bandwidth (MHz)	Modulation	Channel	99% Occupied Bandwidth (MHz)	26 dB Emission Bandwidth (MHz)
5	QPSK	Low	4.540	6.060
		Middle	4.520	5.000
		High	4.500	4.940
	16QAM	Low	4.520	5.500
		Middle	4.540	4.940
		High	4.540	4.960
10	QPSK	Low	9.000	10.120
		Middle	8.960	9.600
		High	8.960	9.600
	16QAM	Low	8.960	9.560
		Middle	8.960	9.600
		High	8.960	9.680
15	QPSK	Low	13.620	17.100
		Middle	13.500	15.000
		High	13.560	14.940
	16QAM	Low	13.560	14.700
		Middle	13.560	14.880
		High	13.560	14.760
20	QPSK	Low	18.000	19.440
		Middle	18.000	19.360
		High	18.000	19.440
	16QAM	Low	18.000	19.440
		Middle	18.000	19.440
		High	18.000	19.440

**Band 17**

Bandwidth (MHz)	Modulation	Channel	99% Occupied Bandwidth (MHz)	26 dB Emission Bandwidth (MHz)
5	QPSK	Low	4.520	5.120
		Middle	4.540	5.160
		High	4.520	5.200
	16QAM	Low	4.520	5.160
		Middle	4.540	5.200
		High	4.560	5.200
10	QPSK	Low	8.960	9.840
		Middle	8.960	9.800
		High	8.960	9.920
	16QAM	Low	8.960	9.880
		Middle	8.960	9.800
		High	8.960	9.840

**LTE Band 38:**

Bandwidth (MHz)	Modulation	Channel	99% Occupied Bandwidth (MHz)	26 dB Emission Bandwidth (MHz)
5	QPSK	Low	4.520	5.080
		Middle	4.520	5.240
		High	4.520	5.080
	16QAM	Low	4.520	4.980
		Middle	4.520	5.080
		High	4.520	5.200
10	QPSK	Low	8.960	9.840
		Middle	8.960	9.800
		High	8.960	9.560
	16QAM	Low	8.960	9.520
		Middle	8.960	9.480
		High	8.960	9.520
15	QPSK	Low	13.500	15.780
		Middle	13.500	15.360
		High	13.500	15.780
	16QAM	Low	13.560	16.140
		Middle	13.560	15.420
		High	13.620	15.840
20	QPSK	Low	18.000	20.720
		Middle	18.000	19.680
		High	18.000	19.760
	16QAM	Low	18.000	20.880
		Middle	18.000	21.600
		High	18.000	21.120

**LTE Band 41:**

Bandwidth (MHz)	Modulation	Channel	99% Occupied Bandwidth (MHz)	26 dB Emission Bandwidth (MHz)
5	QPSK	Low	4.540	5.260
		Middle	4.500	4.980
		High	4.560	6.960
	16QAM	Low	4.500	5.140
		Middle	4.520	5.260
		High	4.520	5.560
10	QPSK	Low	9.000	9.800
		Middle	8.960	9.880
		High	9.039	13.520
	16QAM	Low	9.000	9.480
		Middle	8.960	9.520
		High	8.960	10.720
15	QPSK	Low	13.560	16.440
		Middle	13.500	15.120
		High	13.620	21.945
	16QAM	Low	13.560	15.240
		Middle	13.620	15.660
		High	13.680	21.360
20	QPSK	Low	18.000	19.520
		Middle	18.000	19.200
		High	18.160	29.840
	16QAM	Low	18.000	19.920
		Middle	18.000	21.760
		High	18.080	24.480

**LTE Band 66**

Bandwidth (MHz)	Modulation	Channel	99% Occupied Bandwidth (MHz)	26 dB Emission Bandwidth (MHz)
1.4	QPSK	Low	1.104	1.308
		Middle	1.104	1.308
		High	1.104	1.290
	16QAM	Low	1.098	1.284
		Middle	1.098	1.290
		High	1.098	1.290
3	QPSK	Low	2.688	2.880
		Middle	2.688	2.880
		High	2.688	2.904
	16QAM	Low	2.688	2.880
		Middle	2.688	2.880
		High	2.688	2.868
5	QPSK	Low	4.520	5.220
		Middle	4.520	5.200
		High	4.520	5.220
	16QAM	Low	4.560	5.160
		Middle	4.540	5.180
		High	4.540	5.260
10	QPSK	Low	8.960	9.800
		Middle	8.960	9.840
		High	8.960	9.840
	16QAM	Low	8.960	9.800
		Middle	8.960	9.880
		High	8.960	9.880
15	QPSK	Low	13.560	15.180
		Middle	13.500	15.120
		High	13.560	15.180
	16QAM	Low	13.620	15.180
		Middle	13.560	15.180
		High	13.560	15.120
20	QPSK	Low	18.000	20.320
		Middle	18.000	19.600
		High	17.920	19.680
	16QAM	Low	18.000	20.320
		Middle	18.000	19.680
		High	18.000	19.680

The test plots of LTE band please refer to the Appendix A.

**FCC §2.1051, §22.917(a) & §24.238(a); §27.53 - SPURIOUS EMISSIONS AT ANTENNA TERMINALS**

**Applicable Standard**

FCC §2.1051, §22.917(a) and §24.238(a) and §27.53.

The spectrum was to be investigated to the tenth harmonics of the highest fundamental frequency as specified in § 2.1051.

**Test Procedure**

The RF output of the transceiver was connected to a spectrum analyzer and simulator through appropriate attenuation. The resolution bandwidth of the spectrum analyzer was set at 1MHz. Sufficient scans were taken to show any out of band emissions up to 10<sup>th</sup> harmonic.

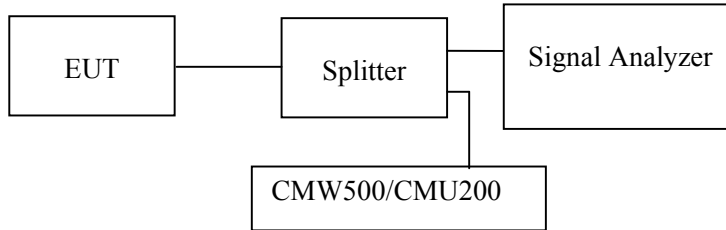

**Test Data**

**Environmental Conditions**

<b>Temperature:</b>	25 °C
<b>Relative Humidity:</b>	55 %
<b>ATM Pressure:</b>	101.0 kPa

*The testing was performed by Coco Liu from 2021-02-19 to 2021-04-09.*

*EUT operation mode: Transmitting*

**Test result: Pass**

*Please refer to the following plots.*

**Cellular Band (Part 22H)  
Low Channel:**

**30 MHz – 1 GHz (GSM Mode)**

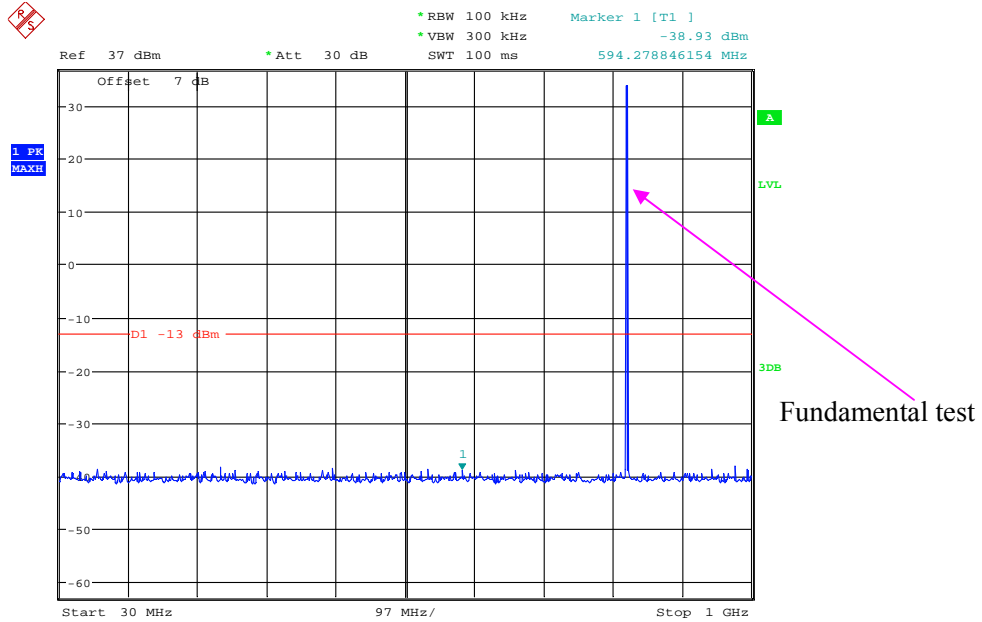

Date: 21.FEB.2021 13:55:24

**1 GHz – 10 GHz (GSM Mode)**

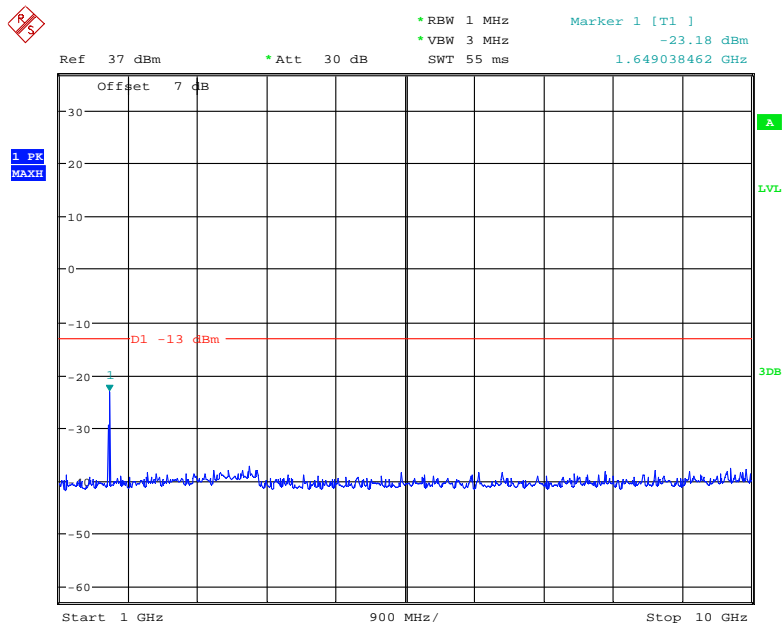

Date: 21.FEB.2021 14:11:57

### 30 MHz – 1 GHz (WCDMA Mode)

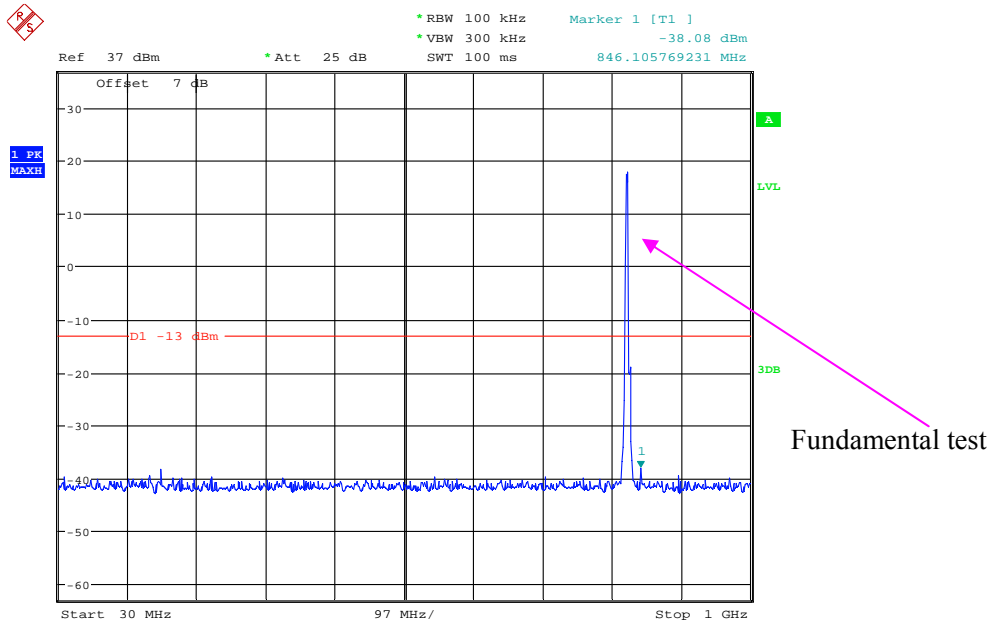

Date: 21.MAR.2021 16:12:33

### 1 GHz – 10 GHz (WCDMA Mode)

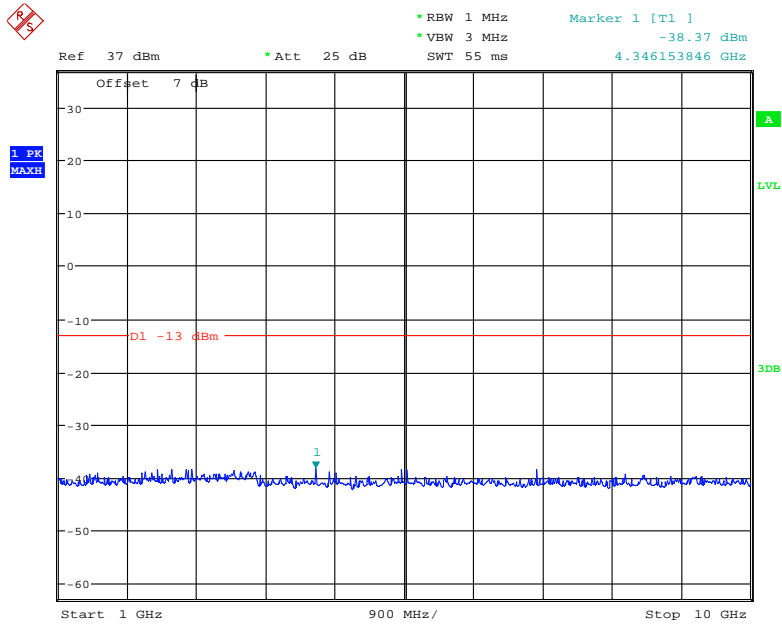

Date: 21.MAR.2021 16:12:54



Middle Channel:

30 MHz – 1 GHz (GSM Mode)

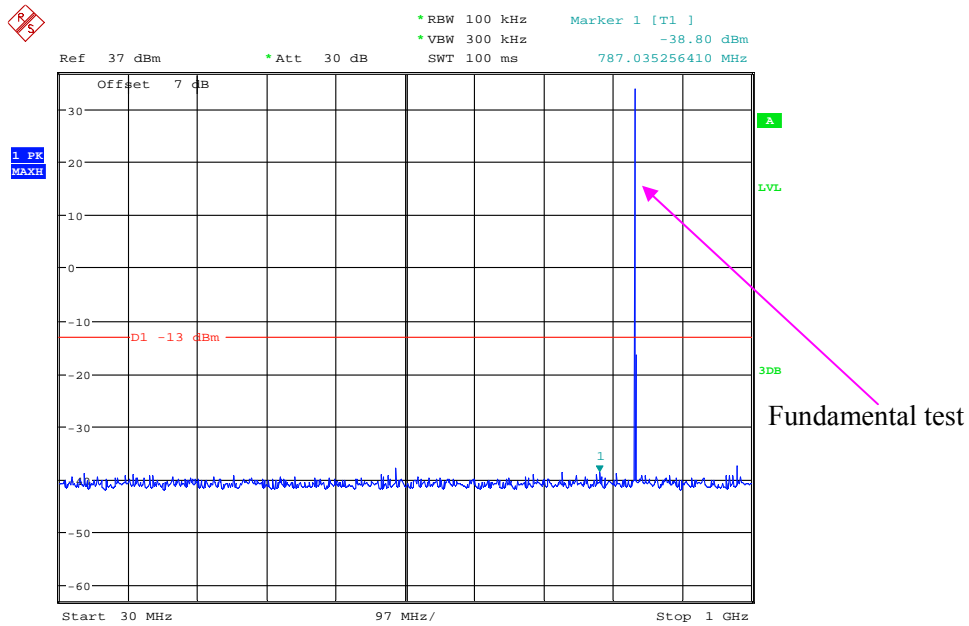

Date: 21.FEB.2021 14:01:44

1 GHz – 10 GHz (GSM Mode)

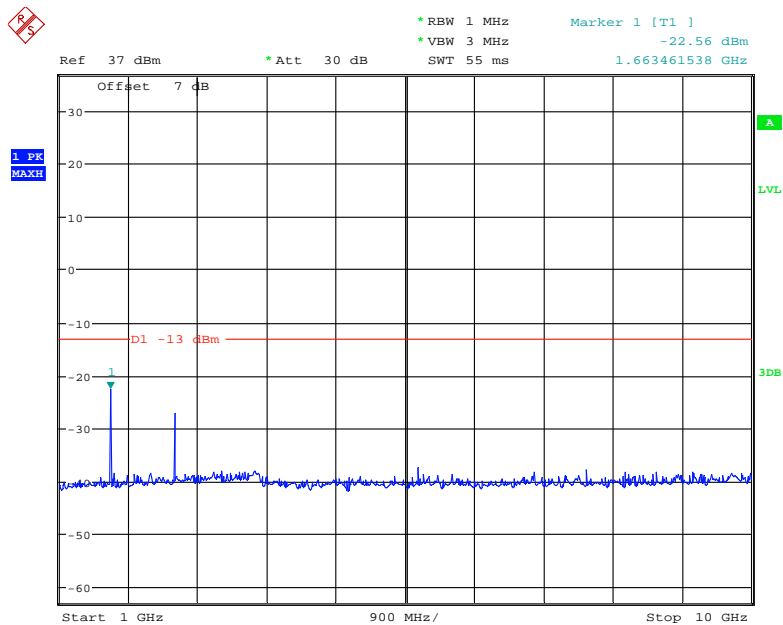

Date: 21.FEB.2021 14:11:46

### 30 MHz – 1 GHz (WCDMA Mode)

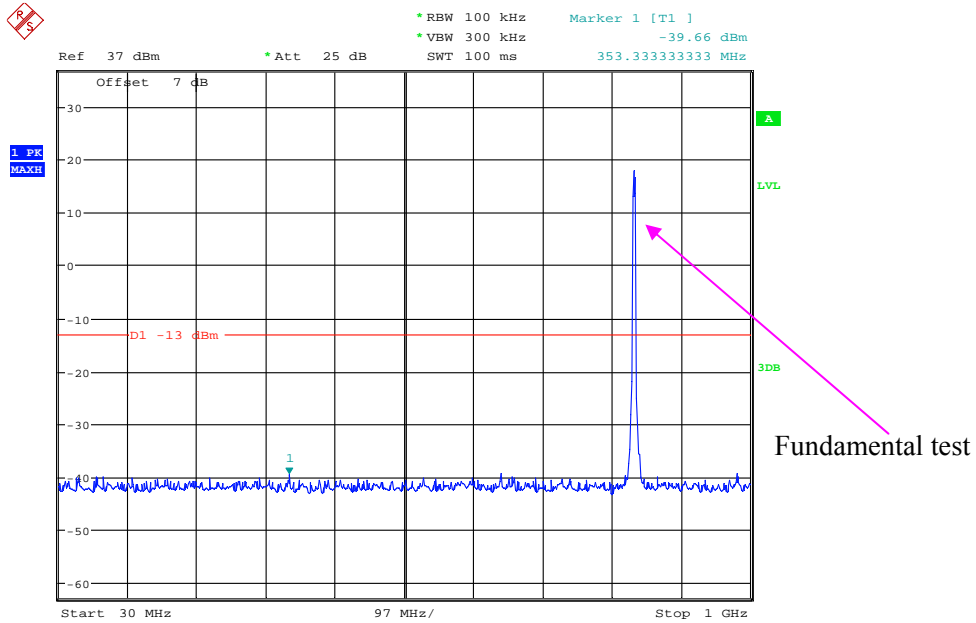

Date: 21.MAR.2021 16:11:38

### 1 GHz – 10 GHz (WCDMA Mode)

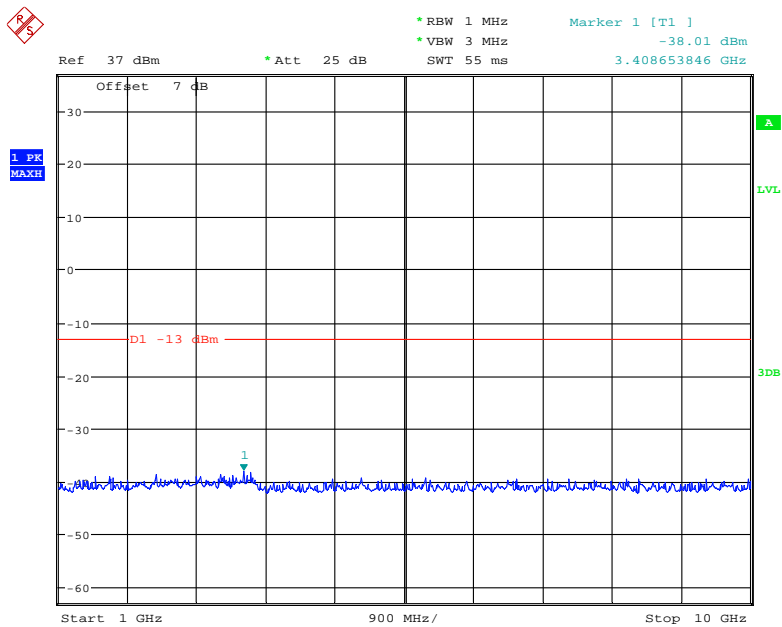

Date: 21.MAR.2021 16:11:15

High Channel:

30 MHz – 1 GHz (GSM Mode)

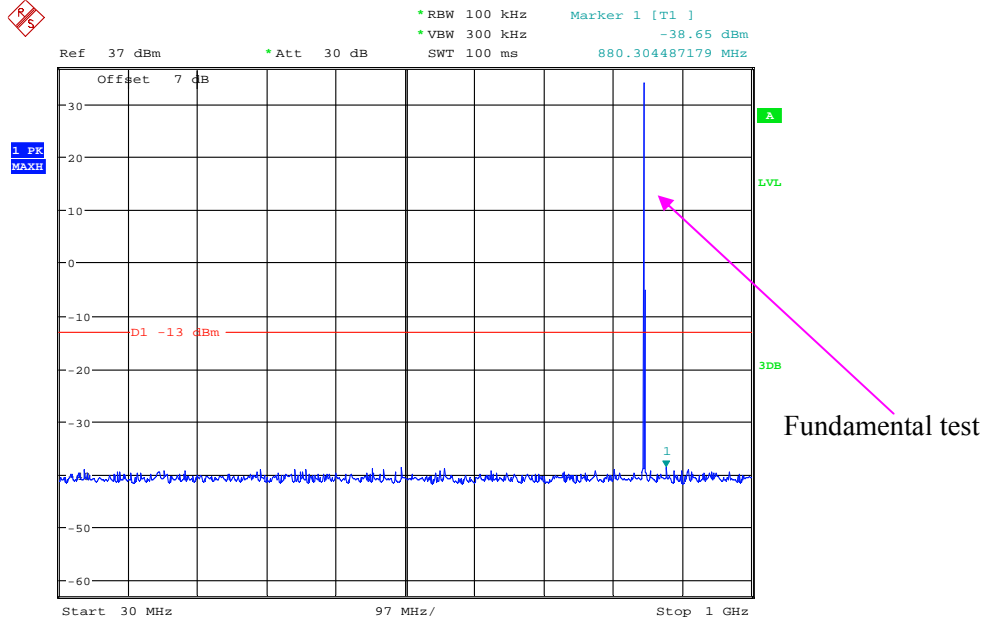

Date: 21.FEB.2021 14:10:35

1 GHz – 10 GHz (GSM Mode)

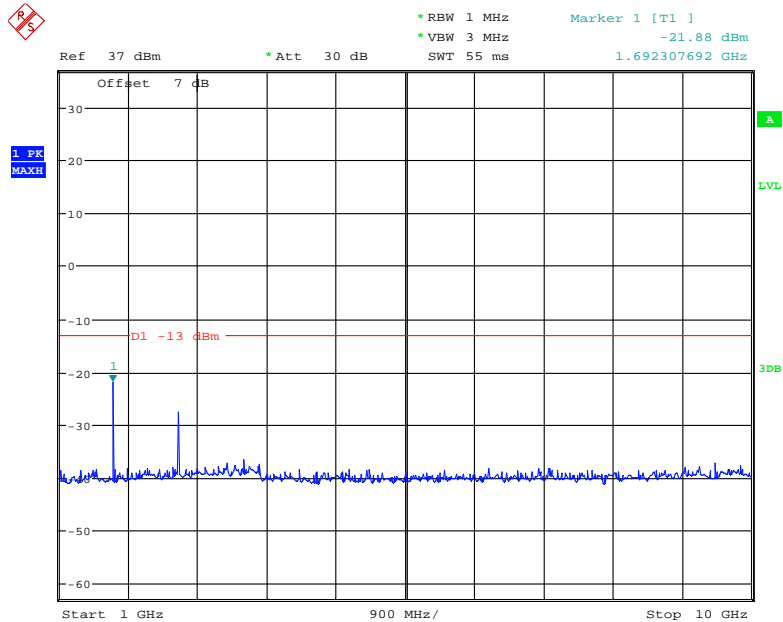

Date: 21.FEB.2021 14:11:25

### 30 MHz – 1 GHz (WCDMA Mode)

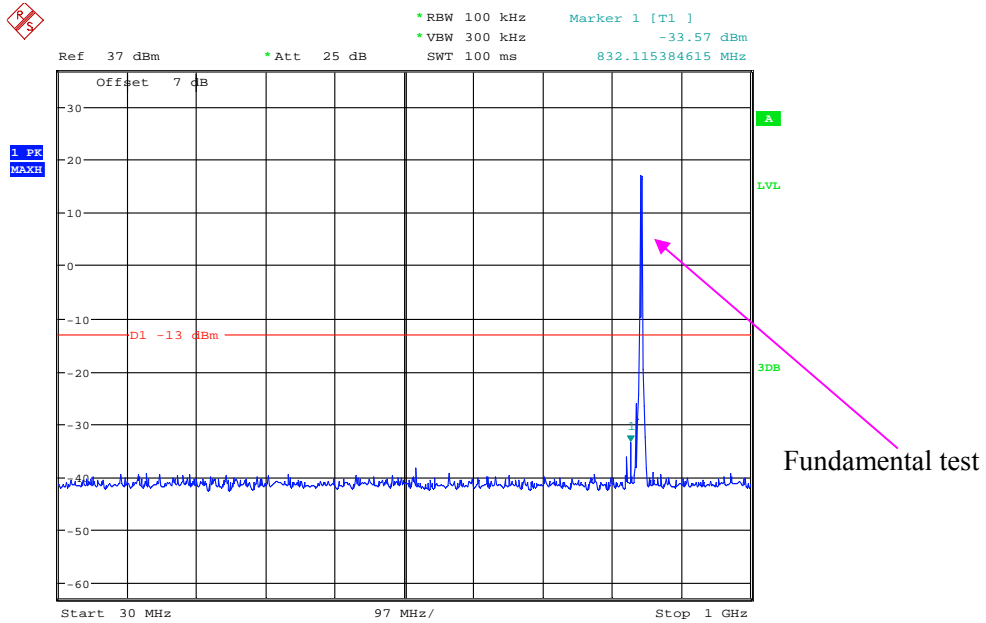

Date: 21.MAR.2021 16:09:48

### 1 GHz – 10 GHz (WCDMA Mode)

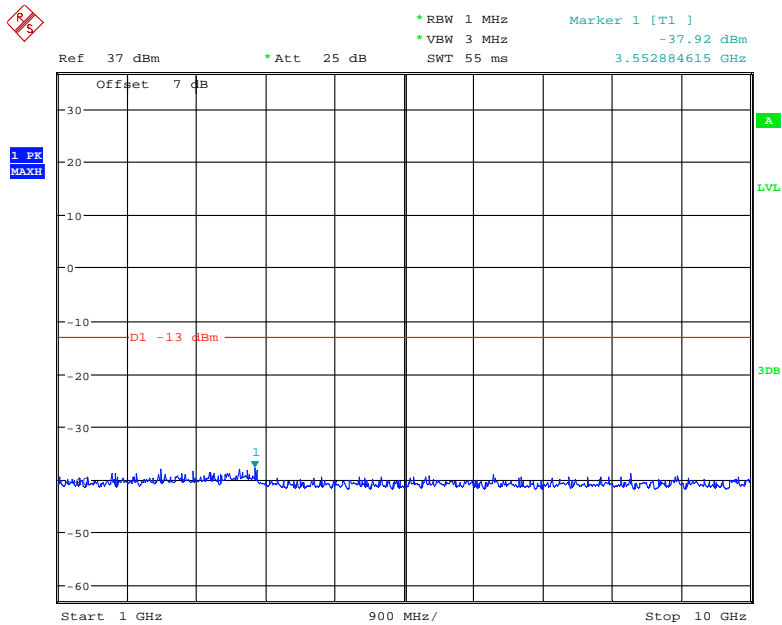

Date: 21.MAR.2021 16:10:35

PCS Band (Part 24E) Low Channel:

30 MHz – 1 GHz (GSM Mode)

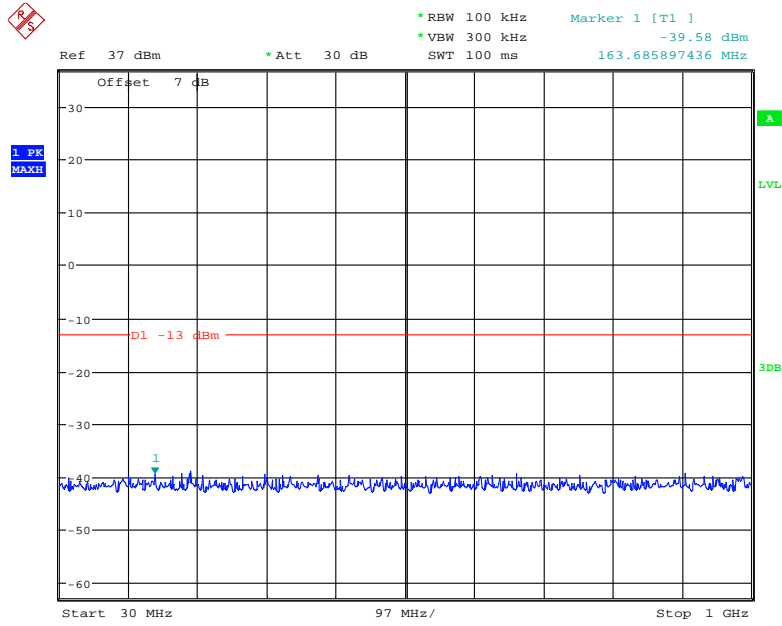

Date: 21.FEB.2021 14:37:52

1 GHz – 2 GHz (GSM Mode)

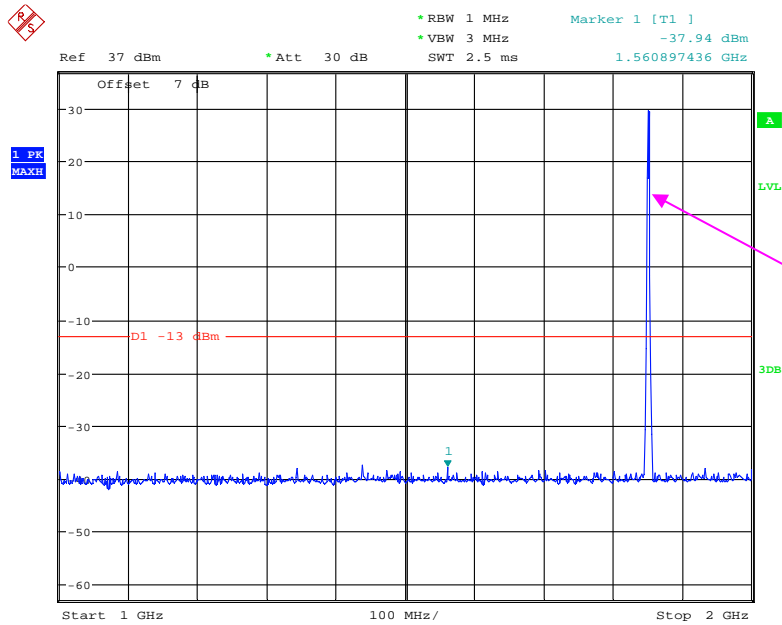

Fundamental test

Date: 21.FEB.2021 14:41:17

### 2 GHz – 2 0GHz (GSM Mode)

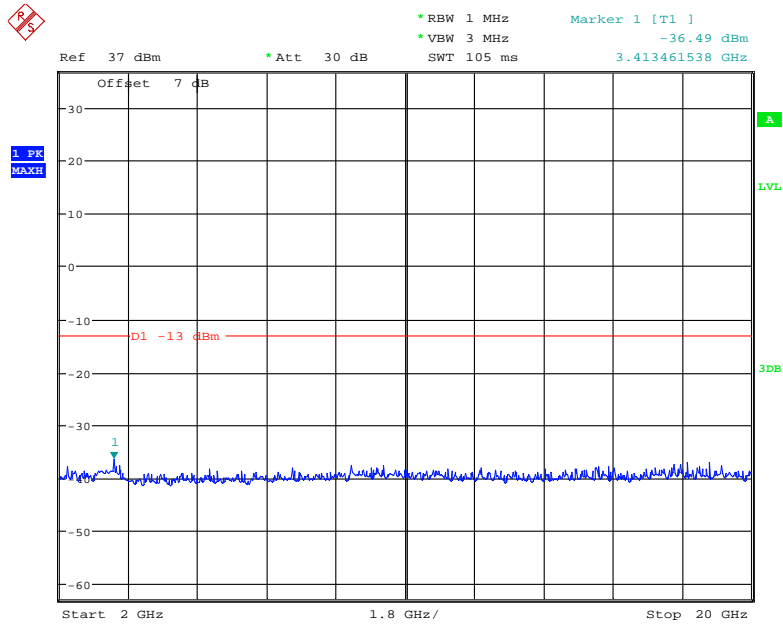

Date: 21.FEB.2021 14:40:48

### 30 MHz – 1 GHz (WCDMA Mode)

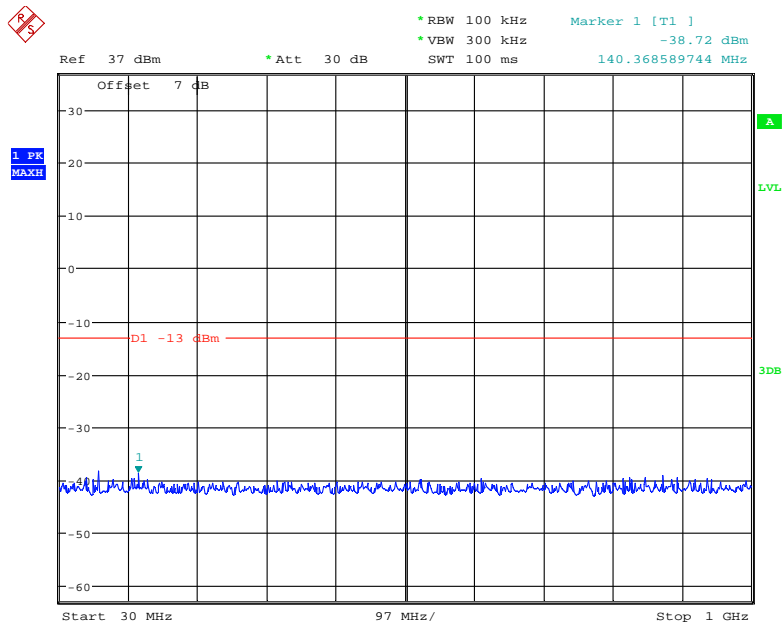

Date: 21.FEB.2021 15:41:58

### 1 GHz – 20 GHz (WCDMA Mode)

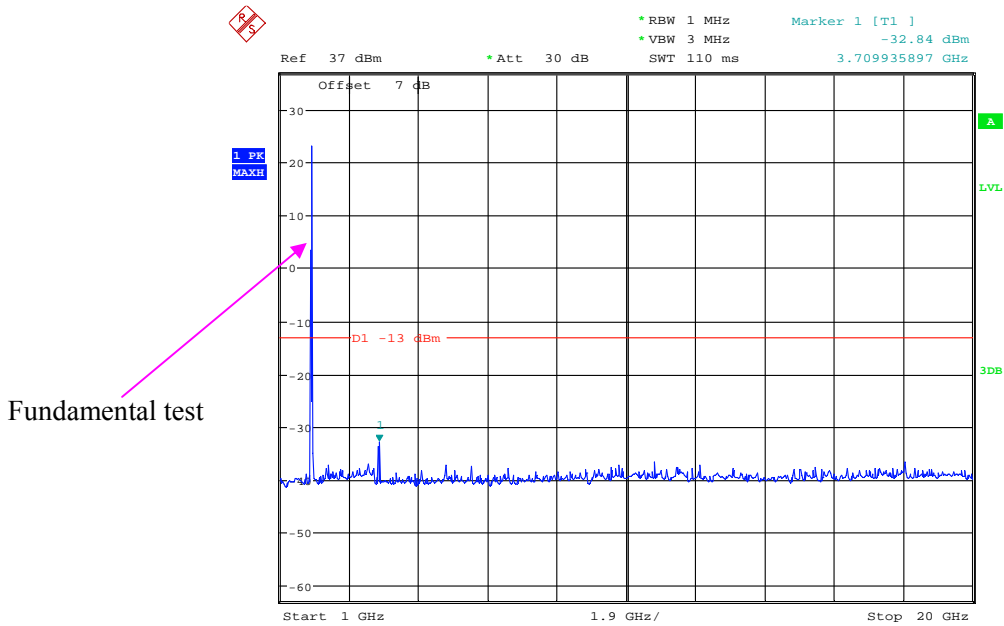

Date: 21.FEB.2021 15:43:45

### Middle Channel:

### 30 MHz – 1 GHz (GSM Mode)

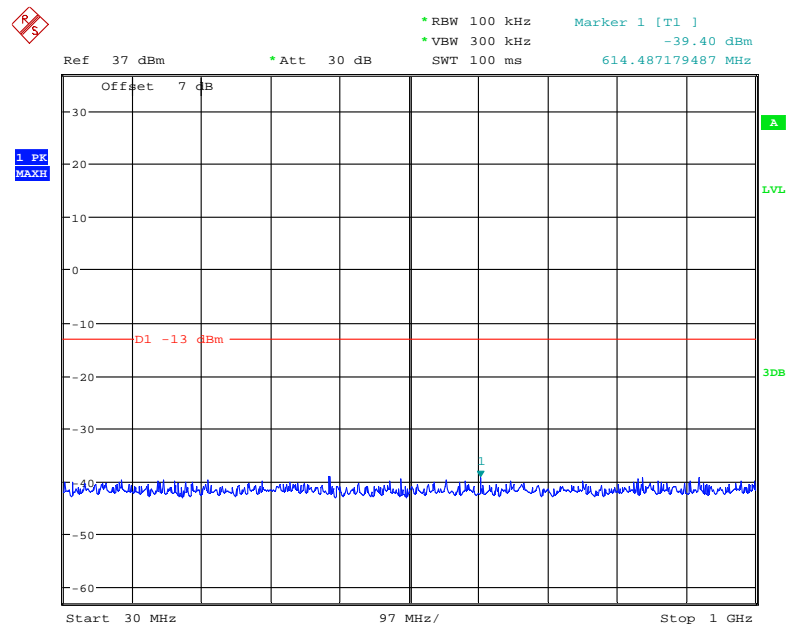

Date: 21.FEB.2021 14:38:33

### 1 GHz – 2 GHz (GSM Mode)

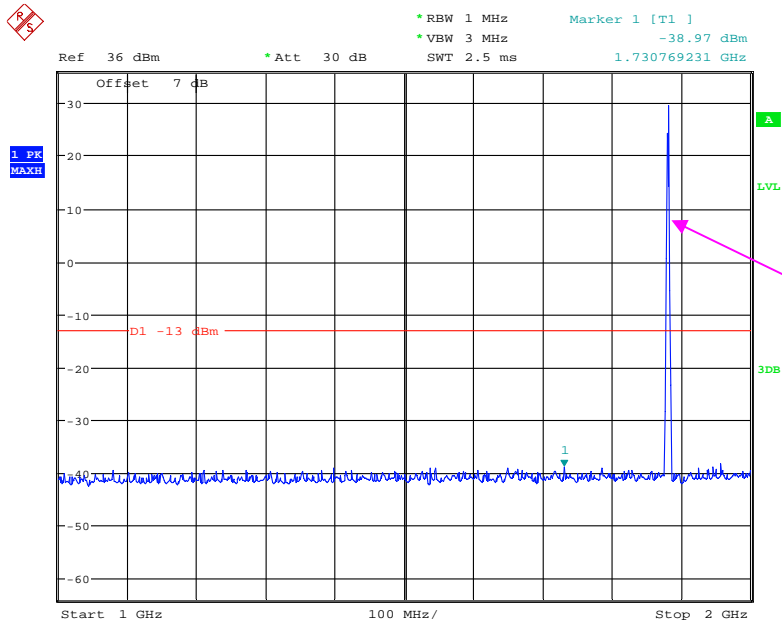

Fundamental test

Date: 21.FEB.2021 14:42:07

### 2 GHz – 20GHz (GSM Mode)

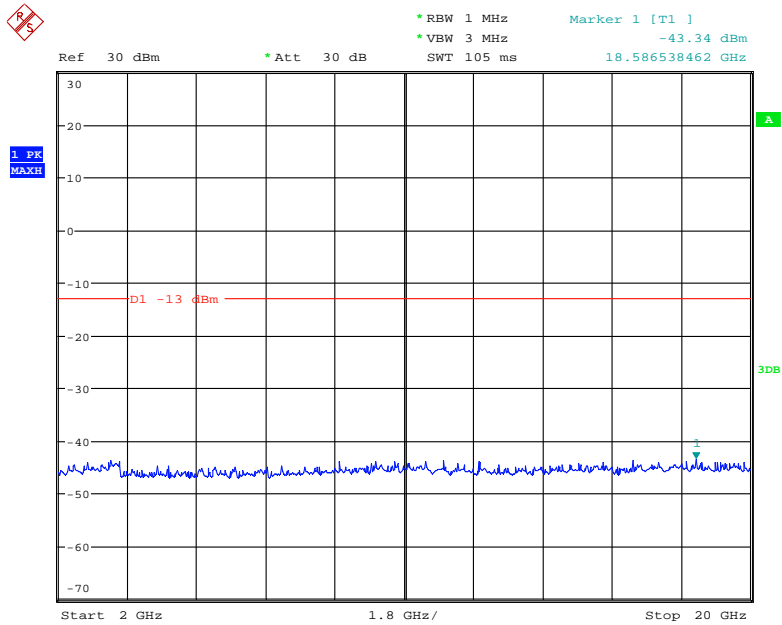

Date: 9.APR.2021 17:23:32



### 30 MHz – 1 GHz (WCDMA Mode)

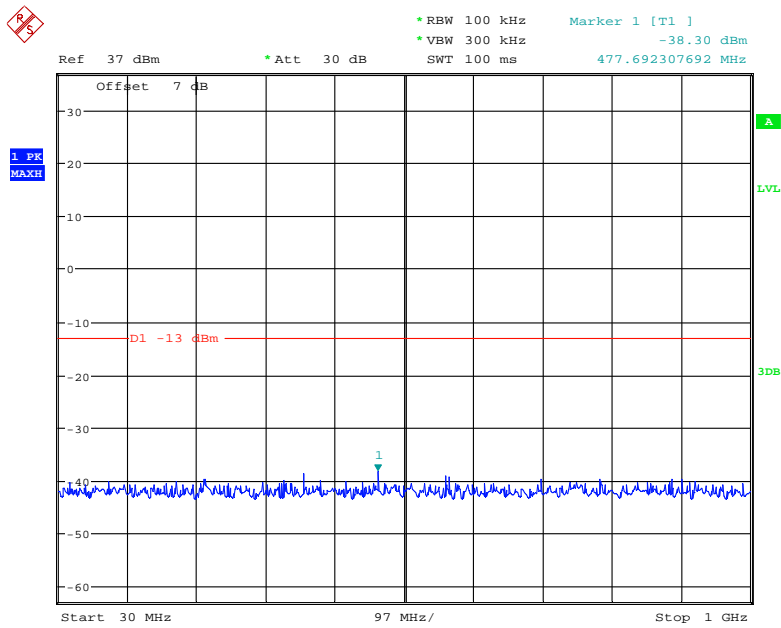

Date: 21.FEB.2021 15:42:25

### 1 GHz – 20 GHz (WCDMA Mode)

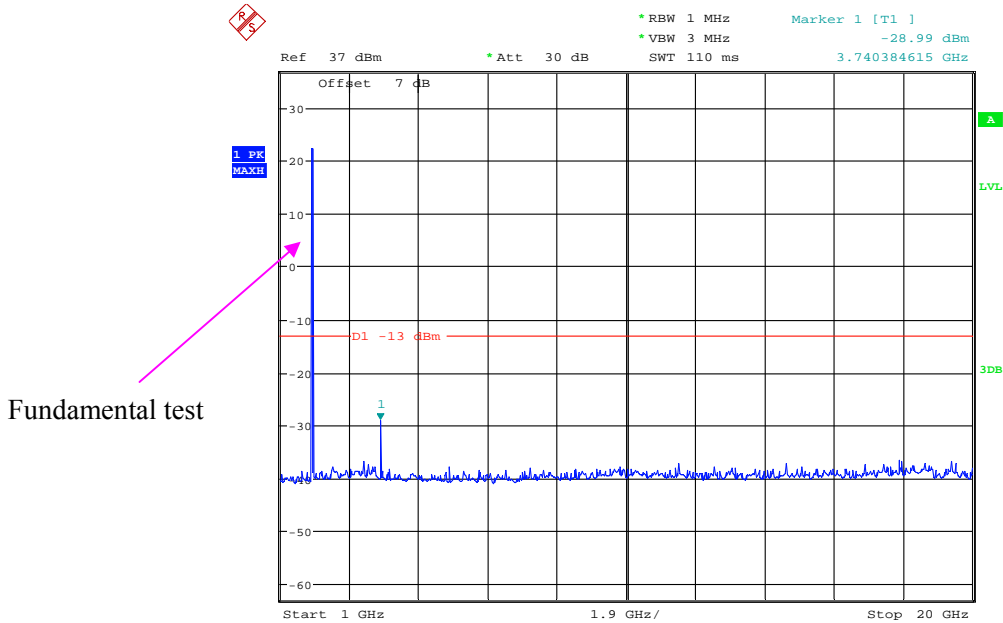

Date: 21.FEB.2021 15:43:33

High Channel:

30 MHz – 1 GHz (GSM Mode)

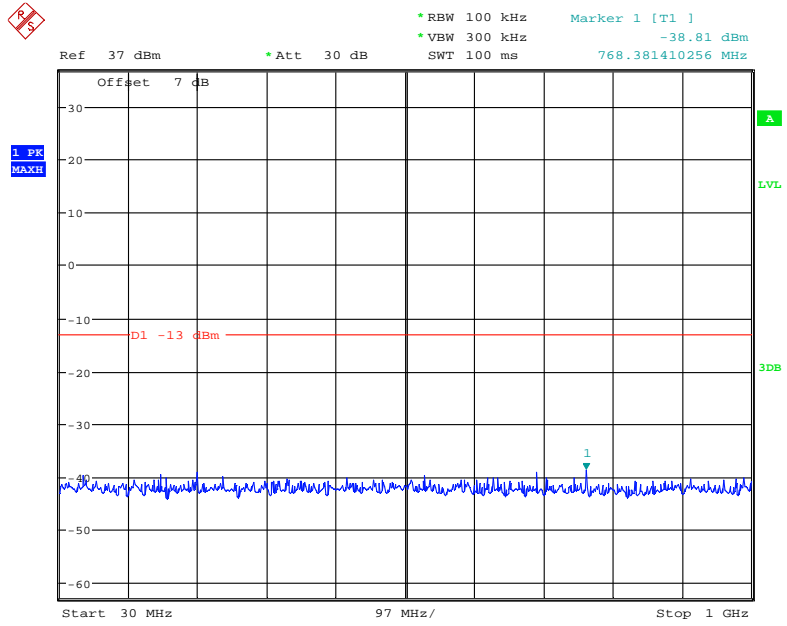

Date: 21.FEB.2021 14:39:02

1 GHz – 2 GHz (GSM Mode)

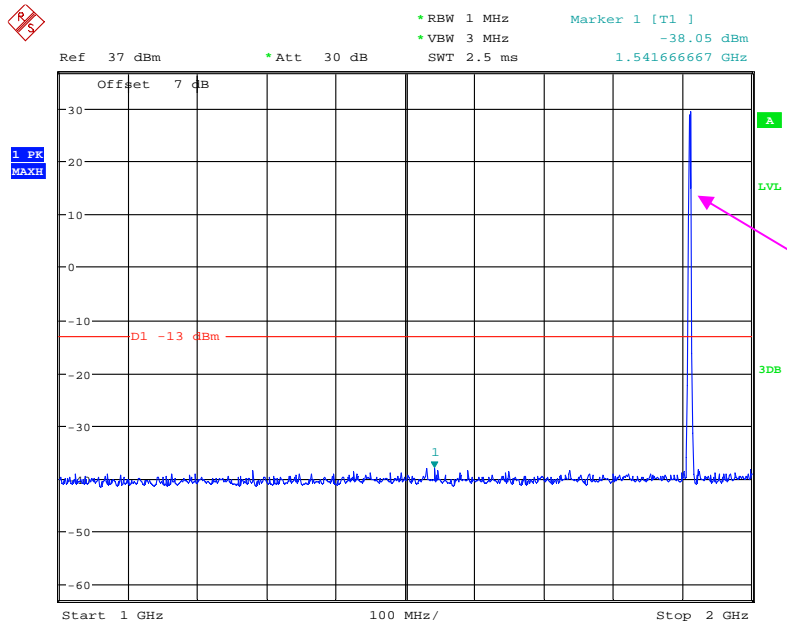

Fundamental test

Date: 21.FEB.2021 14:39:44

### 2 GHz – 20GHz (GSM Mode)

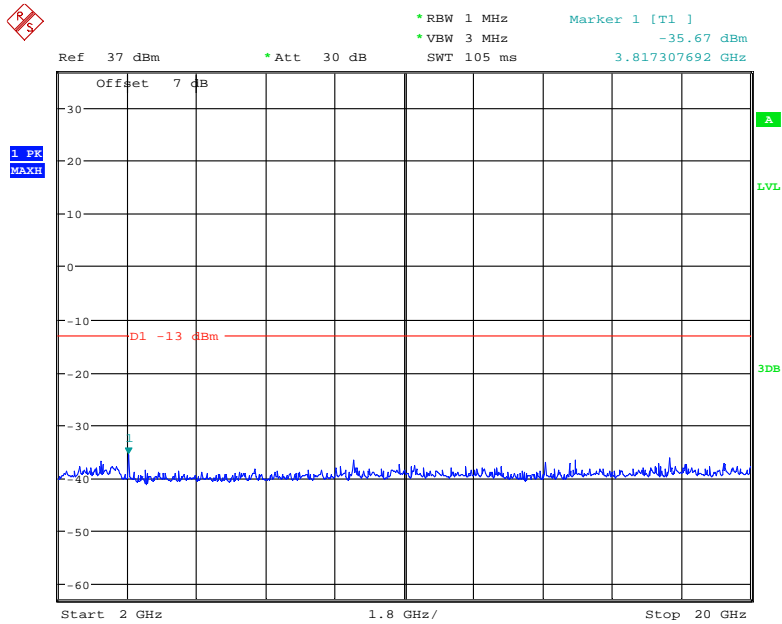

Date: 21.FEB.2021 14:40:12

### 30 MHz – 1 GHz (WCDMA Mode)

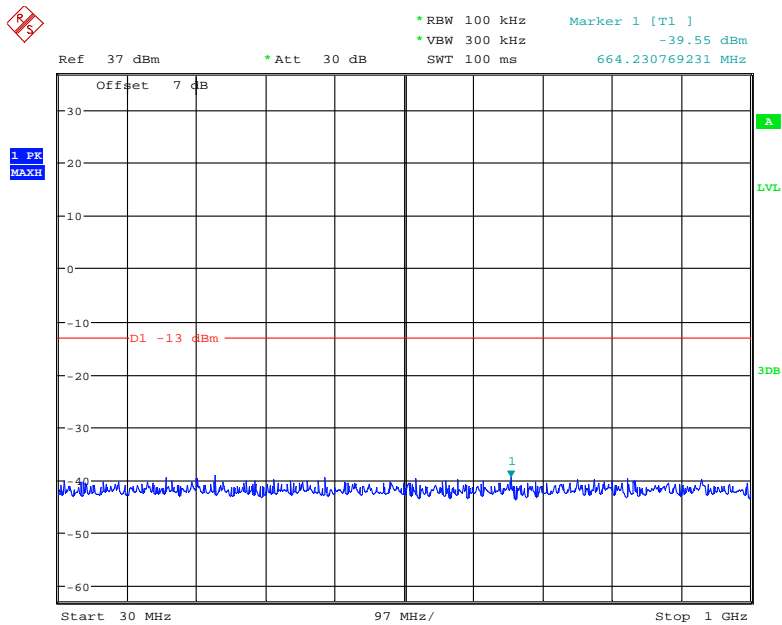

Date: 21.FEB.2021 15:42:38

### 1 GHz – 20 GHz (WCDMA Mode)

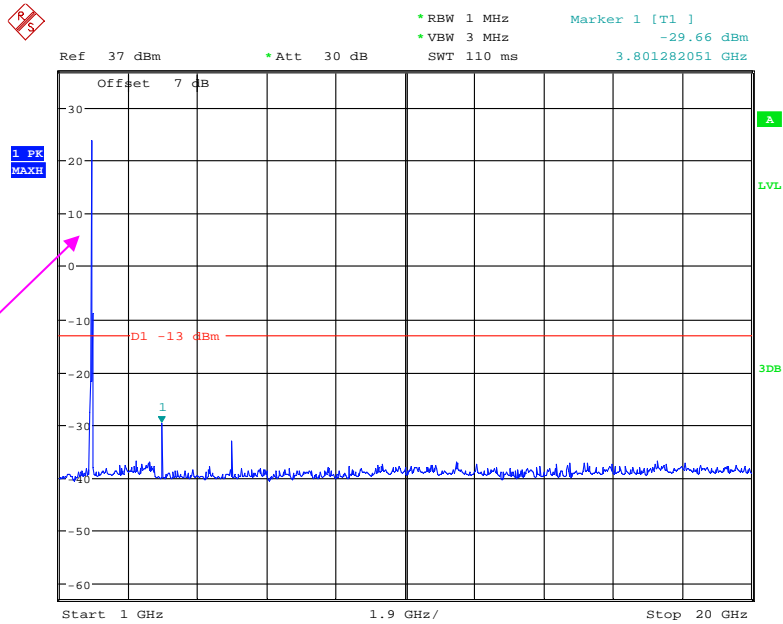

Date: 21.FEB.2021 15:43:11

### AWS Band (Part 27) Low Channel:

### 30 MHz – 1 GHz (WCDMA Mode)

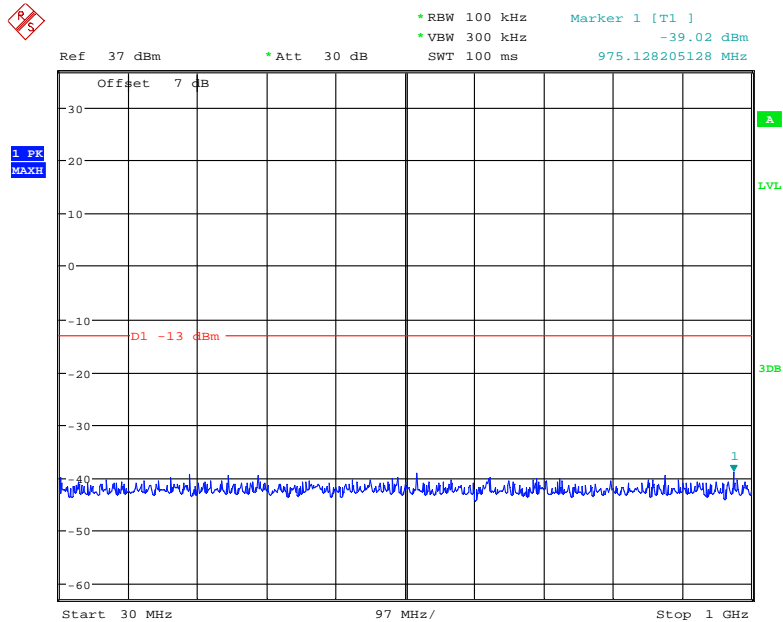

Date: 21.FEB.2021 16:02:28

### 1 GHz – 20 GHz (WCDMA Mode)

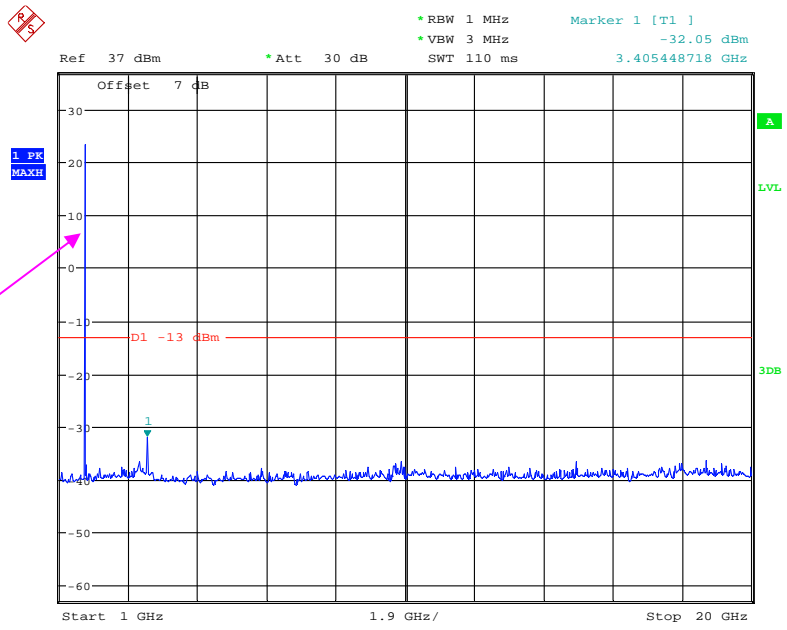

Date: 21.FEB.2021 16:02:52

### Middle Channel

### 30 MHz – 1 GHz (WCDMA Mode)

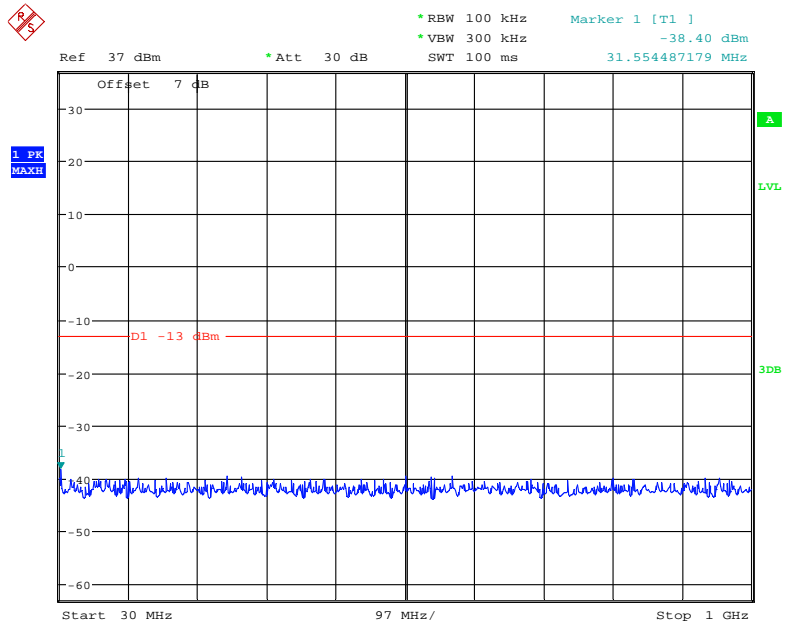

Date: 21.FEB.2021 16:02:16

### 1 GHz – 20 GHz (WCDMA Mode)

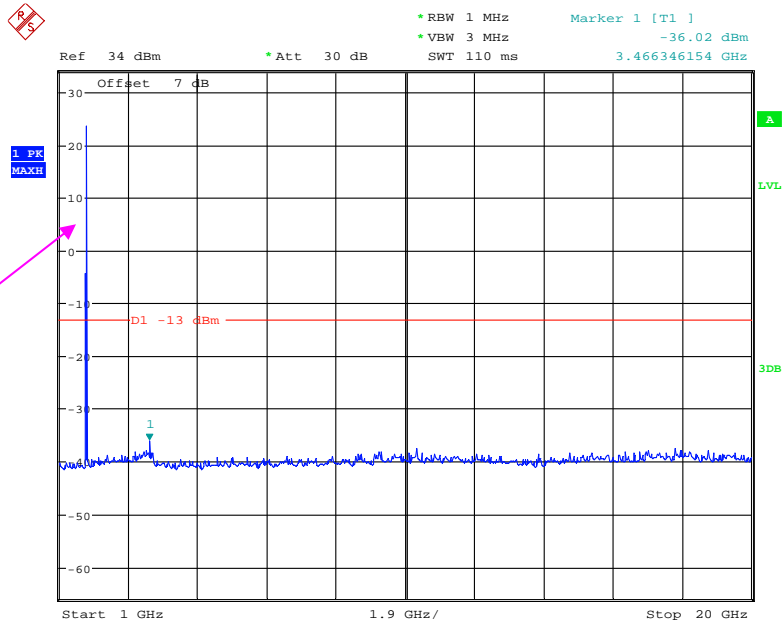

Fundamental test

Date: 21.FEB.2021 16:03:43

### High Channel:

### 30 MHz – 1 GHz (WCDMA Mode)

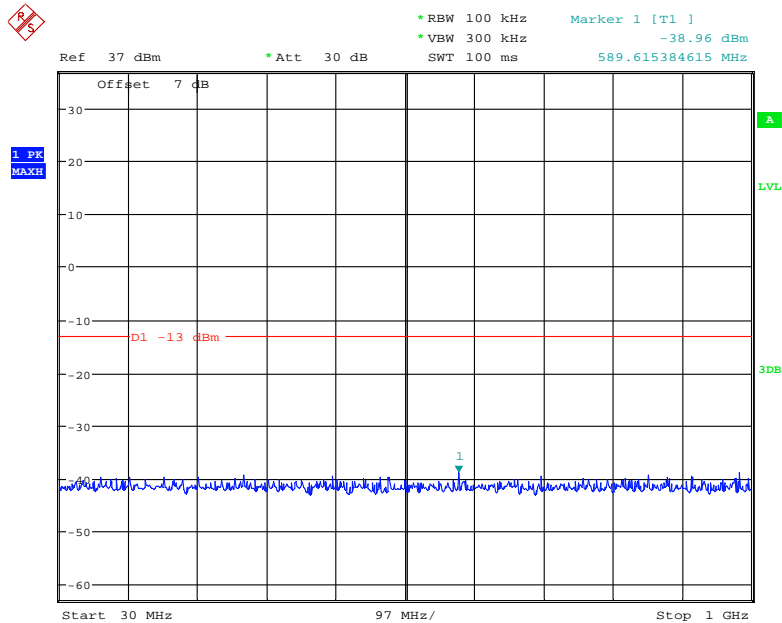

Date: 21.FEB.2021 16:01:54

### 1 GHz – 20 GHz (WCDMA Mode)

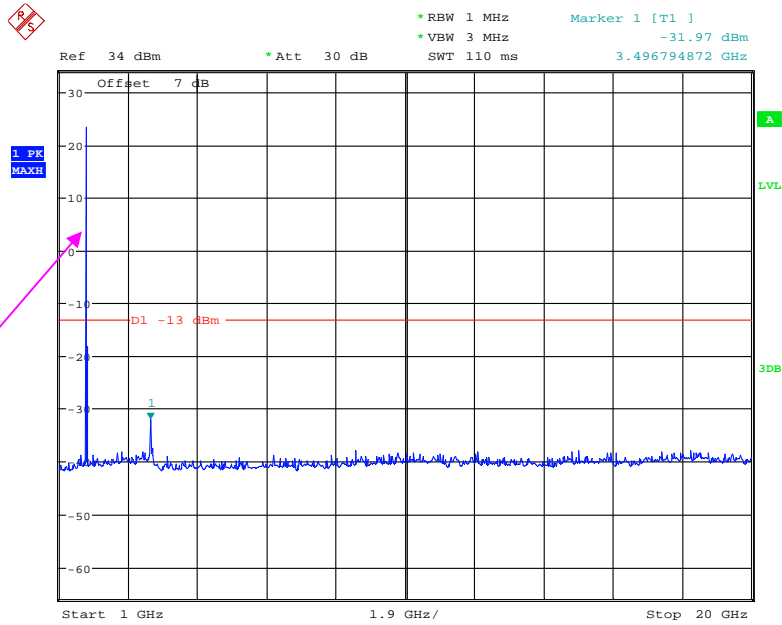

Fundamental test

Date: 21.FEB.2021 16:04:02

The test plots of LTE band please refer to the Appendix B.

**FCC § 2.1053; § 22.917 (a); § 24.238 (a); §27.53 SPURIOUS RADIATED EMISSIONS****Applicable Standard**

FCC § 2.1053, §22.917(a) and § 24.238(a) and § 27.53

**Test Procedure**

The transmitter was placed on a wooden turntable, and it was transmitting into a non-radiating load which was also placed on the turntable.

The measurement antenna was placed at a distance of 3 meters from the EUT. During the tests, the receiving antenna height and polarization as well as EUT azimuth were varied in order to identify the maximum level of emissions from the EUT. The test was performed by placing the EUT on 3-orthogonal axis.

The frequency range up to tenth harmonic of the fundamental frequency was investigated.

**Test Data****Environmental Conditions**

<b>Temperature:</b>	23.5~25.3 °C
<b>Relative Humidity:</b>	46~52 %
<b>ATM Pressure:</b>	101.0~101.1 kPa

*The testing was performed by Harri He from 2021-02-24 to 2021-03-19 for below 1GHz, Troy Wang and Alen He from 2021-02-24 to 2021-04-02 for above 1GHz.*

*EUT operation mode: Transmitting*



**30 MHz ~ 10 GHz:**

**Cellular Band (Part 22H)**

Frequency (MHz)	Receiver Reading (dBµV)	Turntable Angle Degree	Rx Antenna		Substituted			Absolute Level (dBm)	FCC Part 22H	
			Height (m)	Polar (H/V)	Level (dBm)	Cable Loss (dB)	Antenna Gain (dBd/dBi)		Limit (dBm)	Margin (dB)
GSM Mode										
Low channel										
962.3	32.13	299	1.1	H	-64.4	1.36	0.0	-65.76	-13	52.76
962.3	33.25	355	2.1	V	-60.8	1.36	0.0	-62.16	-13	49.16
1648.40	54.85	275	2.2	H	-53.2	1.40	8.70	-45.90	-13	32.90
1648.40	50.31	313	1.6	V	-57.5	1.40	8.70	-50.20	-13	37.20
2472.60	64.87	110	1.7	H	-38.5	2.60	10.20	-30.90	-13	17.90
2472.60	60.15	123	1.2	V	-42.6	2.60	10.20	-35.00	-13	22.00
3296.80	65.14	33	2.3	H	-35.8	1.50	11.70	-25.60	-13	12.60
3296.80	59.47	310	2.4	V	-41.5	1.50	11.70	-31.30	-13	18.30
4121.00	50.32	350	2.0	H	-51.8	1.40	12.20	-41.00	-13	28.00
4121.00	48.75	325	1.0	V	-52.3	1.40	12.20	-41.50	-13	28.50
Middle channel										
963.6	32.26	24	1.4	H	-64.2	1.36	0.0	-65.56	-13	52.56
963.6	33.34	301	1.9	V	-60.7	1.36	0.0	-62.06	-13	49.06
1673.20	57.95	20	1.1	H	-48.4	1.30	8.90	-40.80	-13	27.80
1673.20	51.68	300	1.9	V	-54.1	1.30	8.90	-46.50	-13	33.50
2509.80	65.84	51	1.1	H	-37.5	2.60	10.20	-29.90	-13	16.90
2509.80	60.30	234	2.4	V	-42.4	2.60	10.20	-34.80	-13	21.80
3346.40	64.91	7	1.5	H	-36.0	1.50	11.70	-25.80	-13	12.80
3346.40	59.32	72	2.3	V	-41.6	1.50	11.70	-31.40	-13	18.40
4183.00	51.38	56	1.2	H	-50.6	1.50	11.80	-40.30	-13	27.30
4183.00	49.11	114	1.9	V	-52.0	1.50	11.80	-41.70	-13	28.70
High channel										
966.8	32.36	241	2.2	H	-64.1	1.36	0.0	-65.46	-13	52.46
966.8	33.45	225	1.3	V	-60.6	1.36	0.0	-61.96	-13	48.96
1697.60	55.65	232	2.2	H	-50.7	1.30	8.90	-43.10	-13	30.10
1697.60	50.24	196	1.9	V	-55.5	1.30	8.90	-47.90	-13	34.90
2546.40	65.14	40	2.3	H	-38.2	2.60	10.20	-30.60	-13	17.60
2546.40	59.07	356	1.2	V	-43.7	2.60	10.20	-36.10	-13	23.10
3395.20	63.47	282	2.2	H	-37.8	1.40	11.80	-27.40	-13	14.40
3395.20	59.85	25	2.2	V	-41.2	1.40	11.80	-30.80	-13	17.80
4244.00	51.05	71	2.2	H	-50.9	1.50	11.80	-40.60	-13	27.60
4244.00	49.14	257	1.7	V	-52.0	1.50	11.80	-41.70	-13	28.70

Frequency (MHz)	Receiver Reading (dBμV)	Turntable Angle Degree	Rx Antenna		Substituted			Absolute Level (dBm)	FCC Part 22H	
			Height (m)	Polar (H/V)	Level (dBm)	Cable Loss (dB)	Antenna Gain (dBd/dBi)		Limit (dBm)	Margin (dB)
WCDMA Mode										
Low channel										
950.3	32.71	226	1.2	H	-63.8	1.36	0.0	-65.16	-13	52.16
950.3	33.86	64	1.5	V	-60.2	1.36	0.0	-61.56	-13	48.56
1652.80	45.08	138	1.2	H	-61.3	1.30	8.90	-53.70	-13	40.70
1652.80	44.83	286	1.2	V	-60.9	1.30	8.90	-53.30	-13	40.30
2479.20	43.65	121	1.3	H	-59.7	2.60	10.20	-52.10	-13	39.10
2479.20	43.38	18	2.3	V	-59.4	2.60	10.20	-51.80	-13	38.80
3305.60	42.87	251	1.7	H	-58.0	1.50	11.70	-47.80	-13	34.80
3305.60	42.42	324	2.4	V	-58.5	1.50	11.70	-48.30	-13	35.30
Middle channel										
959.4	32.77	211	2.0	H	-63.7	1.36	0.0	-65.06	-13	52.06
959.4	33.93	359	2.0	V	-60.1	1.36	0.0	-61.46	-13	48.46
1673.20	45.17	204	1.6	H	-61.2	1.30	8.90	-53.60	-13	40.60
1673.20	44.91	256	2.3	V	-60.8	1.30	8.90	-53.20	-13	40.20
2509.80	43.62	179	2.0	H	-59.7	2.60	10.20	-52.10	-13	39.10
2509.80	43.32	282	1.5	V	-59.4	2.60	10.20	-51.80	-13	38.80
3346.40	42.78	108	2.2	H	-58.1	1.50	11.70	-47.90	-13	34.90
3346.40	42.49	157	2.0	V	-58.4	1.50	11.70	-48.20	-13	35.20
High channel										
963.9	32.69	83	2.3	H	-63.8	1.36	0.0	-65.16	-13	52.16
963.9	33.88	117	2.4	V	-60.2	1.36	0.0	-61.56	-13	48.56
1693.20	45.28	175	1.5	H	-61.1	1.30	8.90	-53.50	-13	40.50
1693.20	44.87	299	1.9	V	-60.9	1.30	8.90	-53.30	-13	40.30
2539.80	43.65	95	1.1	H	-59.7	2.60	10.20	-52.10	-13	39.10
2539.80	43.41	338	2.3	V	-59.3	2.60	10.20	-51.70	-13	38.70
3386.40	42.73	307	2.5	H	-58.5	1.40	11.80	-48.10	-13	35.10
3386.40	42.47	105	2.4	V	-58.6	1.40	11.80	-48.20	-13	35.20

**30 MHz ~ 20 GHz:**

**PCS Band (Part 24E)**

Frequency (MHz)	Receiver Reading (dBµV)	Turntable Angle Degree	Rx Antenna		Substituted			Absolute Level (dBm)	FCC Part 24E	
			Height (m)	Polar (H/V)	Level (dBm)	Cable Loss (dB)	Antenna Gain (dBd/dBi)		Limit (dBm)	Margin (dB)
GSM Mode										
Low channel										
960.4	32.28	317	1.6	H	-64.2	1.36	0.0	-65.56	-13	52.56
960.4	33.39	348	1.4	V	-60.7	1.36	0.0	-62.06	-13	49.06
3700.40	51.17	52	2.4	H	-50.6	1.60	11.90	-40.30	-13	27.30
3700.40	48.32	158	1.3	V	-52.9	1.60	11.90	-42.60	-13	29.60
Middle channel										
964.2	32.47	14	1.5	H	-64.0	1.36	0.0	-65.36	-13	52.36
964.2	33.6	216	1.4	V	-60.5	1.36	0.0	-61.86	-13	48.86
3760.00	50.87	189	1.7	H	-51.2	1.50	11.80	-40.90	-13	27.90
3760.00	47.68	110	2.1	V	-53.9	1.50	11.80	-43.60	-13	30.60
High channel										
965.9	32.53	197	1.6	H	-64.0	1.36	0.0	-65.36	-13	52.36
965.9	33.71	52	1.7	V	-60.3	1.36	0.0	-61.66	-13	48.66
3819.60	52.14	63	1.6	H	-49.9	1.50	11.80	-39.60	-13	26.60
3819.60	48.79	344	1.7	V	-52.8	1.50	11.80	-42.50	-13	29.50
WCDMA Mode										
Low channel										
949.5	32.31	230	1.7	H	-64.2	1.36	0.0	-65.56	-13	52.56
949.5	33.46	339	1.9	V	-60.6	1.36	0.0	-61.96	-13	48.96
3704.80	56.56	130	1.6	H	-45.5	1.60	11.90	-35.20	-13	22.20
3704.80	55.32	75	2.1	V	-46.2	1.60	11.90	-35.90	-13	22.90
Middle channel										
953.9	32.37	347	1.6	H	-64.1	1.36	0.0	-65.46	-13	52.46
953.9	33.52	20	1.7	V	-60.5	1.36	0.0	-61.86	-13	48.86
3704.80	57.12	299	1.8	H	-45.0	1.60	11.90	-34.70	-13	21.70
3704.80	55.45	312	1.4	V	-46.1	1.60	11.90	-35.80	-13	22.80
High channel										
966.4	32.41	91	1.2	H	-64.1	1.36	0.0	-65.46	-13	52.46
966.4	33.59	181	1.9	V	-60.5	1.36	0.0	-61.86	-13	48.86
3704.80	57.85	70	1.2	H	-44.2	1.60	11.90	-33.90	-13	20.90
3704.80	55.81	175	1.6	V	-45.7	1.60	11.90	-35.40	-13	22.40

**30 MHz ~ 20 GHz:**

**AWS Band**

Frequency (MHz)	Receiver Reading (dBµV)	Turntable Angle Degree	Rx Antenna		Substituted			Absolute Level (dBm)	FCC Part 27	
			Height (m)	Polar (H/V)	Level (dBm)	Cable Loss (dB)	Antenna Gain (dBd/dBi)		Limit (dBm)	Margin (dB)
WCDMA Mode										
Low channel										
951.6	32.21	187	1.4	H	-64.3	1.36	0.0	-65.66	-13	52.66
951.6	33.35	99	2.3	V	-60.7	1.36	0.0	-62.06	-13	49.06
3424.80	57.68	350	1.2	H	-43.6	1.40	11.80	-33.20	-13	20.20
3424.80	55.32	288	2.2	V	-45.7	1.40	11.80	-35.30	-13	22.30
Middle channel										
957.7	32.10	201	1.6	H	-64.4	1.36	0.0	-65.76	-13	52.76
957.7	33.18	337	1.1	V	-60.9	1.36	0.0	-62.26	-13	49.26
3465.20	56.98	282	2.0	H	-43.9	1.50	12.00	-33.40	-13	20.40
3465.20	55.64	358	1.6	V	-46.0	1.50	12.00	-35.50	-13	22.50
High channel										
964.5	32.19	268	2.2	H	-64.3	1.36	0.0	-65.66	-13	52.66
964.5	33.34	88	1.9	V	-60.7	1.36	0.0	-62.06	-13	49.06
3505.20	58.04	114	2.0	H	-42.8	1.50	12.00	-32.30	-13	19.30
3505.20	55.73	56	1.2	V	-45.9	1.50	12.00	-35.40	-13	22.40

**LTE Band:** (Pre-scan with all the bandwidth, and worst case as below)

Frequency (MHz)	Receiver Reading (dBµV)	Turntable Angle Degree	Rx Antenna		Substituted			Absolute Level (dBm)	Limit (dBm)	Margin (dB)
			Height (m)	Polar (H/V)	Level (dBm)	Cable Loss (dB)	Antenna Gain (dBd/dBi)			
Band 2										
Test frequency range: 30 MHz ~ 20 GHz										
1.4MHz, Low channel										
962.4	32.38	154	2.2	H	-64.1	1.36	0.0	-65.46	-13	52.46
962.4	33.16	307	1.1	V	-60.9	1.36	0.0	-62.26	-13	49.26
3701.40	48.67	217	1.7	H	-53.1	1.60	11.90	-42.80	-13	29.80
3701.40	47.05	10	1.1	V	-54.2	1.60	11.90	-43.90	-13	30.90
1.4MHz, Middle channel										
962.4	32.57	336	1.8	H	-63.9	1.36	0.0	-65.26	-13	52.26
962.4	33.36	14	2.2	V	-60.7	1.36	0.0	-62.06	-13	49.06
3760.00	49.52	270	1.9	H	-52.5	1.50	11.80	-42.20	-13	29.20
3760.00	47.28	128	2.4	V	-54.3	1.50	11.80	-44.00	-13	31.00
1.4MHz, High channel										
960.5	32.37	332	2.1	H	-64.1	1.36	0.0	-65.46	-13	52.46
960.5	33.28	40	1.6	V	-60.8	1.36	0.0	-62.16	-13	49.16
3800.00	49.34	134	1.0	H	-52.7	1.50	11.80	-42.40	-13	29.40
3800.00	47.55	316	1.8	V	-54.0	1.50	11.80	-43.70	-13	30.70
Band 4										
Test frequency range:30 MHz ~ 20 GHz										
1.4MHz, Low channel										
961.2	32.33	235	1.9	H	-64.2	1.36	0.0	-65.56	-13	52.56
961.2	33.45	72	1.2	V	-60.6	1.36	0.0	-61.96	-13	48.96
3421.40	58.64	58	2.2	H	-42.2	1.40	11.80	-31.80	-13	18.80
3421.40	55.74	328	1.3	V	-44.9	1.40	11.80	-34.50	-13	21.50
1.4MHz, Middle channel										
958.1	32.29	64	1.7	H	-64.2	1.36	0.0	-65.56	-13	52.56
958.1	33.88	40	1.5	V	-60.2	1.36	0.0	-61.56	-13	48.56
3465.00	59.23	165	2.4	H	-41.5	1.50	12.00	-31.00	-13	18.00
3465.00	56.21	154	1.3	V	-45.3	1.50	12.00	-34.80	-13	21.80
1.4MHz, High channel										
960.4	32.10	151	2.0	H	-64.4	1.36	0.0	-65.76	-13	52.76
960.4	33.71	193	1.4	V	-60.3	1.36	0.0	-61.66	-13	48.66
3508.60	58.83	82	2.1	H	-41.9	1.50	12.00	-31.40	-13	18.40
3508.60	56.09	292	1.9	V	-45.4	1.50	12.00	-34.90	-13	21.90

Frequency (MHz)	Receiver Reading (dBμV)	Turntable Angle Degree	Rx Antenna		Substituted			Absolute Level (dBm)	Limit (dBm)	Margin (dB)
			Height (m)	Polar (H/V)	Level (dBm)	Cable Loss (dB)	Antenna Gain (dBd/dBi)			
Band 5										
Test frequency range: 30 MHz ~ 10 GHz										
1.4MHz, Low channel										
961.7	32.30	83	1.9	H	-64.2	1.36	0.0	-65.56	-13	52.56
961.7	33.52	9	2.0	V	-60.5	1.36	0.0	-61.86	-13	48.86
1649.40	49.05	352	1.8	H	-59.0	1.40	8.70	-51.70	-13	38.70
1649.40	47.23	102	2.3	V	-60.6	1.40	8.70	-53.30	-13	40.30
1.4MHz, Middle channel										
963.6	32.14	172	1.7	H	-64.4	1.36	0.0	-65.76	-13	52.76
963.6	33.63	95	2.5	V	-60.4	1.36	0.0	-61.76	-13	48.76
1673.00	48.36	32	1.9	H	-58.0	1.30	8.90	-50.40	-13	37.40
1673.00	46.51	338	1.6	V	-59.2	1.30	8.90	-51.60	-13	38.60
1.4MHz, High channel										
961.2	32.21	160	1.4	H	-64.3	1.36	0.0	-65.66	-13	52.66
961.2	33.57	182	2.3	V	-60.5	1.36	0.0	-61.86	-13	48.86
1696.60	48.69	130	1.4	H	-57.6	1.30	8.90	-50.00	-13	37.00
1696.60	46.54	4	1.4	V	-59.2	1.30	8.90	-51.60	-13	38.60
Band 7										
Test frequency range: 30 MHz ~ 26.5 GHz										
5MHz, Low channel										
959.3	32.25	84	1.8	H	-64.3	1.36	0.0	-65.66	-25	40.66
959.3	33.48	19	1.9	V	-60.6	1.36	0.0	-61.96	-25	36.96
5005.00	49.34	140	1.8	H	-51.3	1.70	12.00	-41.00	-25	16.00
5005.00	46.10	216	1.5	V	-53.9	1.70	12.00	-43.60	-25	18.60
5MHz, Middle channel										
956.7	32.17	213	2.4	H	-64.3	1.36	0.0	-65.66	-25	40.66
956.7	33.52	48	1.1	V	-60.5	1.36	0.0	-61.86	-25	36.86
5070.00	49.00	134	1.8	H	-51.0	1.60	12.10	-40.50	-25	15.50
5070.00	45.87	224	2.2	V	-54.1	1.60	12.10	-43.60	-25	18.60
5MHz, High channel										
960.5	32.27	136	1.7	H	-64.2	1.36	0.0	-65.56	-25	40.56
960.5	33.59	22	1.7	V	-60.5	1.36	0.0	-61.86	-25	36.86
5135.00	48.60	256	1.0	H	-51.4	1.60	12.10	-40.90	-25	15.90
5135.00	45.67	72	2.5	V	-54.3	1.60	12.10	-43.80	-25	18.80

Frequency (MHz)	Receiver Reading (dBμV)	Turntable Angle Degree	Rx Antenna		Substituted			Absolute Level (dBm)	Limit (dBm)	Margin (dB)
			Height (m)	Polar (H/V)	Level (dBm)	Cable Loss (dB)	Antenna Gain (dBd/dBi)			
Band 17										
Test frequency range: 30 MHz ~ 10 GHz										
5MHz, Low channel										
958.2	32.05	191	1.8	H	-64.5	1.36	0.0	-65.86	-13	52.86
958.2	33.65	119	1.8	V	-60.4	1.36	0.0	-61.76	-13	48.76
1413.00	50.68	342	1.6	H	-57.5	1.60	7.90	-51.20	-13	38.20
1413.00	51.36	78	2.2	V	-57.1	1.60	7.90	-50.80	-13	37.80
5MHz, Middle channel										
961.6	33.15	325	1.1	H	-63.4	1.36	0.0	-64.76	-13	51.76
961.6	33.73	158	1.1	V	-60.3	1.36	0.0	-61.66	-13	48.66
1420.00	50.57	346	1.3	H	-57.6	1.60	7.90	-51.30	-13	38.30
1420.00	51.27	173	1.8	V	-57.2	1.60	7.90	-50.90	-13	37.90
5MHz, High channel										
962.1	33.34	18	2.1	H	-63.2	1.36	0.0	-64.56	-13	51.56
962.1	33.65	25	1.4	V	-60.4	1.36	0.0	-61.76	-13	48.76
1427.00	51.07	5	1.1	H	-57.1	1.60	7.90	-50.80	-13	37.80
1427.00	52.28	218	1.9	V	-56.2	1.60	7.90	-49.90	-13	36.90
Band 38										
Test frequency range: 30 MHz ~26.5GHz										
5MHz, Low channel										
962.8	33.41	223	2.1	H	-63.1	1.36	0.0	-64.46	-25	39.46
962.8	33.83	1	1.7	V	-60.2	1.36	0.0	-61.56	-25	36.56
5145.00	44.89	127	1.6	H	-55.1	1.60	12.10	-44.60	-25	19.60
5145.00	44.57	151	2.1	V	-55.4	1.60	12.10	-44.90	-25	19.90
5MHz, Middle channel										
963.1	33.32	285	2.2	H	-63.2	1.36	0.0	-64.56	-25	39.56
963.1	33.77	335	2.3	V	-60.3	1.36	0.0	-61.66	-25	36.66
5190.00	45.05	61	1.8	H	-55.0	1.60	12.10	-44.50	-25	19.50
5190.00	44.60	287	1.2	V	-55.0	1.60	12.10	-44.50	-25	19.50
5MHz, High channel										
960.5	33.25	109	1.3	H	-63.3	1.36	0.0	-64.66	-25	39.66
960.5	33.70	33	2.4	V	-60.4	1.36	0.0	-61.76	-25	36.76
5235.00	45.19	129	2.0	H	-54.9	1.60	12.10	-44.40	-25	19.40
5235.00	44.27	304	2.5	V	-55.3	1.60	12.10	-44.80	-25	19.80

Frequency (MHz)	Receiver Reading (dBμV)	Turntable Angle Degree	Rx Antenna		Substituted			Absolute Level (dBm)	Limit (dBm)	Margin (dB)
			Height (m)	Polar (H/V)	Level (dBm)	Cable Loss (dB)	Antenna Gain (dBd/dBi)			
Band 41										
Test frequency range: 30 MHz ~26.5GHz										
5MHz, Low channel										
963.2	33.18	83	1.2	H	-63.3	1.36	0.0	-64.66	-25	39.66
963.2	33.52	326	1.3	V	-60.5	1.36	0.0	-61.86	-25	36.86
5075.00	45.20	235	2.4	H	-54.8	1.60	12.10	-44.30	-25	19.30
5075.00	44.37	129	1.8	V	-55.6	1.60	12.10	-45.10	-25	20.10
5MHz, Middle channel										
959.2	33.12	207	1.0	H	-63.4	1.36	0.0	-64.76	-25	39.76
959.2	33.65	190	1.9	V	-60.4	1.36	0.0	-61.76	-25	36.76
5190.00	45.30	50	1.2	H	-54.8	1.60	12.10	-44.30	-25	19.30
5190.00	44.57	176	1.5	V	-55.0	1.60	12.10	-44.50	-25	19.50
5 MHz, High channel										
962.5	33.31	206	1.7	H	-63.2	1.36	0.0	-64.56	-25	39.56
962.5	33.76	251	1.7	V	-60.3	1.36	0.0	-61.66	-25	36.66
5305.00	45.51	279	1.5	H	-54.2	1.60	12.20	-43.60	-25	18.60
5305.00	44.48	4	1.5	V	-54.7	1.60	12.20	-44.10	-25	19.10
Band 66										
Test frequency range: 30 MHz ~ 20GHz										
1.4MHz, Low channel										
962.1	32.95	32	2.0	H	-63.6	1.36	0.0	-64.96	-13	51.96
962.1	33.52	357	1.3	V	-60.5	1.36	0.0	-61.86	-13	48.86
3421.40	66.49	290	2.2	H	-34.3	1.40	11.80	-23.90	-13	10.90
3421.40	61.35	178	2.1	V	-39.3	1.40	11.80	-28.90	-13	15.90
5132.10	50.07	52	1.5	H	-49.9	1.60	12.10	-39.40	-13	26.40
5132.10	52.13	42	1.8	V	-47.9	1.60	12.10	-37.40	-13	24.40
1.4MHz, Middle channel										
961.4	32.98	336	1.7	H	-63.5	1.36	0.0	-64.86	-13	51.86
961.4	33.43	3	1.7	V	-60.6	1.36	0.0	-61.96	-13	48.96
3490.00	66.06	137	1.6	H	-34.7	1.50	12.00	-24.20	-13	11.20
3490.00	61.13	119	2.4	V	-40.4	1.50	12.00	-29.90	-13	16.90
5235.00	49.07	268	2.2	H	-51.0	1.60	12.10	-40.50	-13	27.50
5235.00	50.45	327	1.9	V	-49.2	1.60	12.10	-38.70	-13	25.70
1.4MHz, High channel										
960.3	33.07	324	2.3	H	-63.4	1.36	0.0	-64.76	-13	51.76
960.3	33.71	242	2.2	V	-60.3	1.36	0.0	-61.66	-13	48.66
3558.60	66.47	87	1.6	H	-35.1	1.50	12.10	-24.50	-13	11.50
3558.60	60.68	13	1.0	V	-40.3	1.50	12.10	-29.70	-13	16.70
5337.90	50.18	294	2.4	H	-49.6	1.60	12.20	-39.00	-13	26.00
5337.90	52.36	315	1.2	V	-46.8	1.60	12.20	-36.20	-13	23.20

**Note:**

Absolute Level = Substituted Level - Cable loss + Antenna Gain

Margin = Limit- Absolute Level

dBd is for the ERP, dBi is for EIRP.



**FCC § 22.917 (a); § 24.238 (a); §27.53(c) (h)(m) - BAND EDGES**

**Applicable Standard**

According to § 22.917(a), the power of any emissions outside of the authorized operating frequency ranges must be attenuated below the transmitting power (P) by a factor of at least  $43 + 10 \log(P)$  dB.

According to §24.238(a), the power of any emissions outside of the authorized operating frequency ranges must be attenuated below the transmitting power (P) by a factor of at least  $43 + 10 \log(P)$  dB.

According to FCC §27.53 (c)(h)(m), the power of any emission outside of the authorized operating frequency ranges must be attenuated below the transmitting power (P) by a factor of at least  $43 + 10 \log(P)$  dB.

**Test Procedure**

The RF output of the transmitter was connected to the input of the spectrum analyzer through sufficient attenuation.

The center of the spectrum analyzer was set to block edge frequency

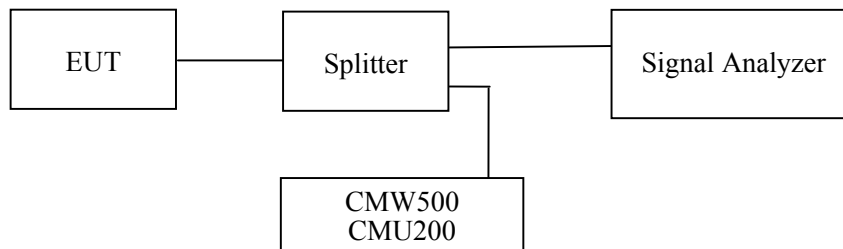

**Test Data****Environmental Conditions**

<b>Temperature:</b>	25 °C
<b>Relative Humidity:</b>	55 %
<b>ATM Pressure:</b>	101.0 kPa

*The testing was performed by Coco Liu from 2021-02-19 to 2021-03-21.*

*EUT operation mode: Transmitting (Worst case)*

**Test Result: Pass**

*Please refer to the following plots.*

### Cellular Band, Left Band Edge for GSM (GMSK) Mode

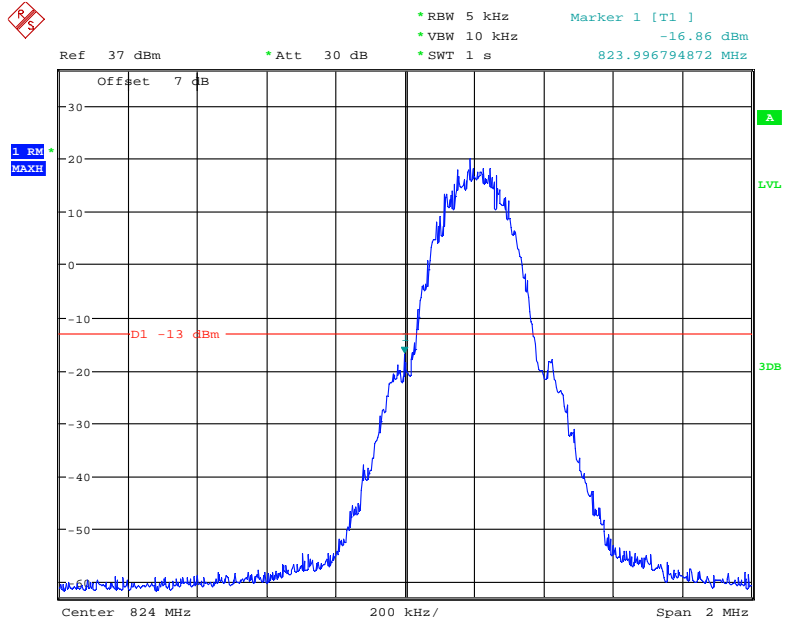

Date: 21.FEB.2021 14:19:50

### Cellular Band, Right Band Edge for GSM (GMSK) Mode

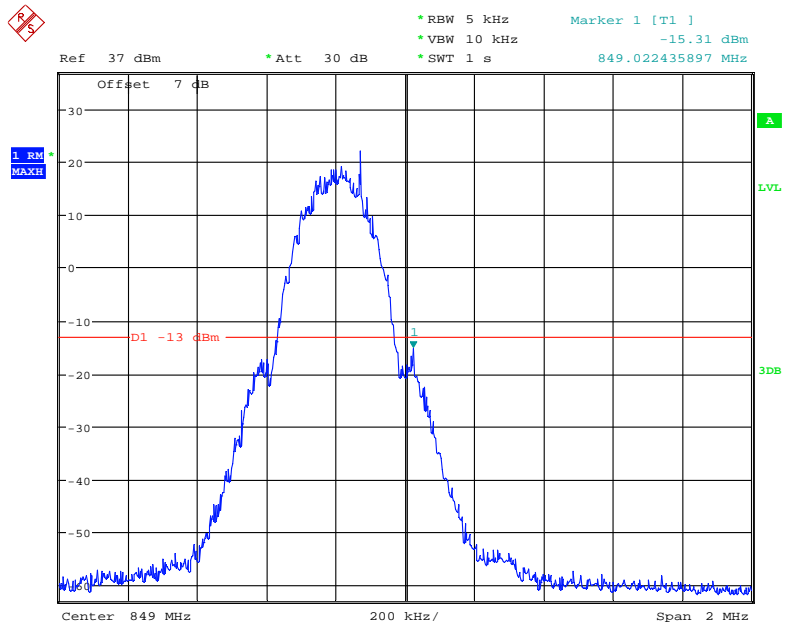

Date: 21.FEB.2021 14:18:30

### Cellular Band, Left Band Edge for EGPRS (GMSK) Mode

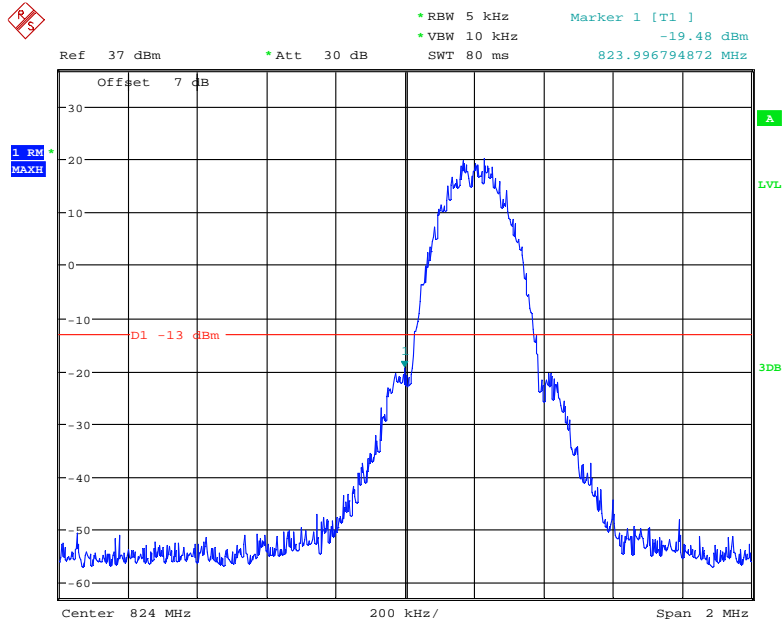

Date: 21.FEB.2021 14:28:59

### Cellular Band, Right Band Edge for EGPRS (GMSK) Mode

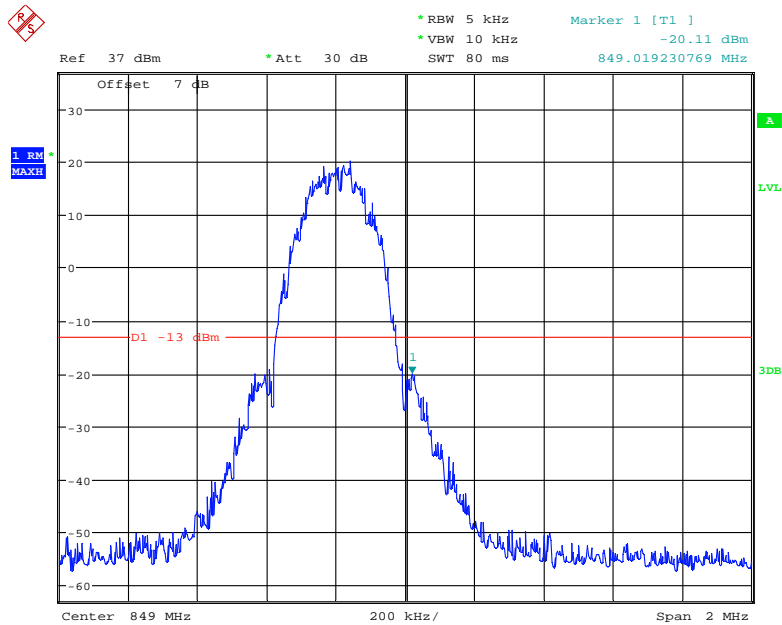

Date: 21.FEB.2021 14:29:47

### Cellular Band, Left Band Edge for WCDMA (BPSK) Mode

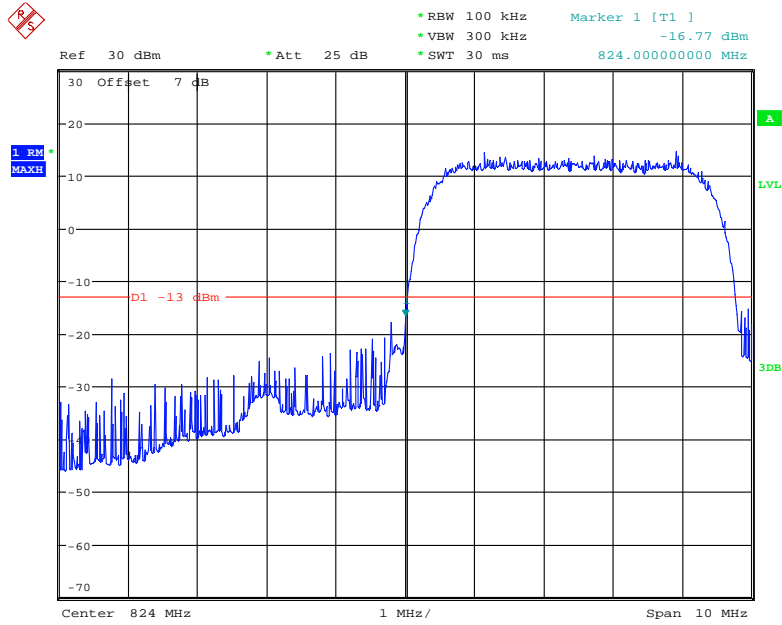

Date: 21.MAR.2021 13:23:48

### Cellular Band, Right Band Edge for WCDMA (BPSK) Mode

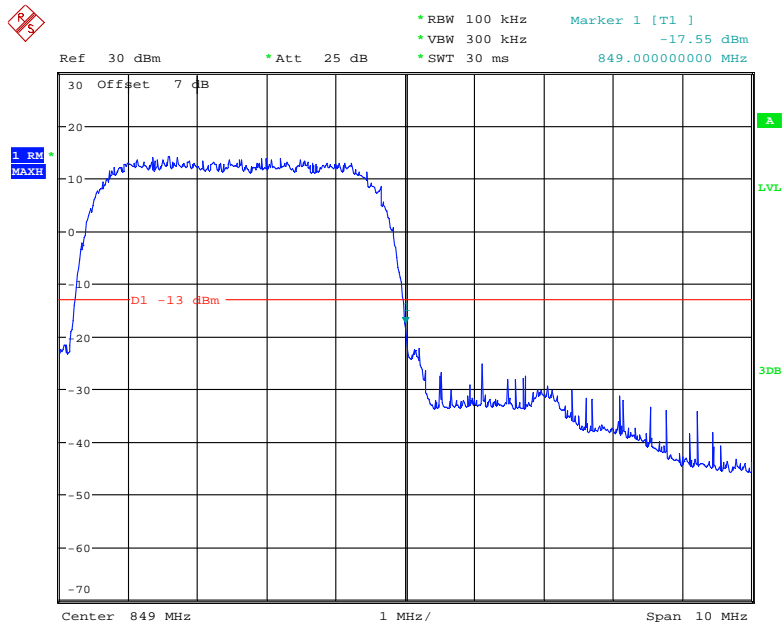

Date: 21.MAR.2021 13:25:23

### Cellular Band, Left Band Edge for HSDPA (16QAM) Mode

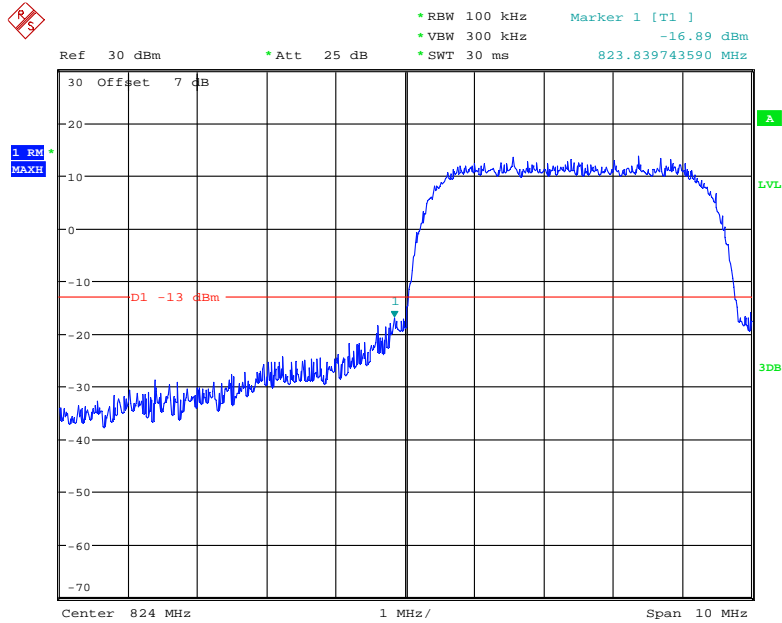

Date: 21.MAR.2021 13:29:01

### Cellular Band, Right Band Edge for HSDPA (16QAM) Mode

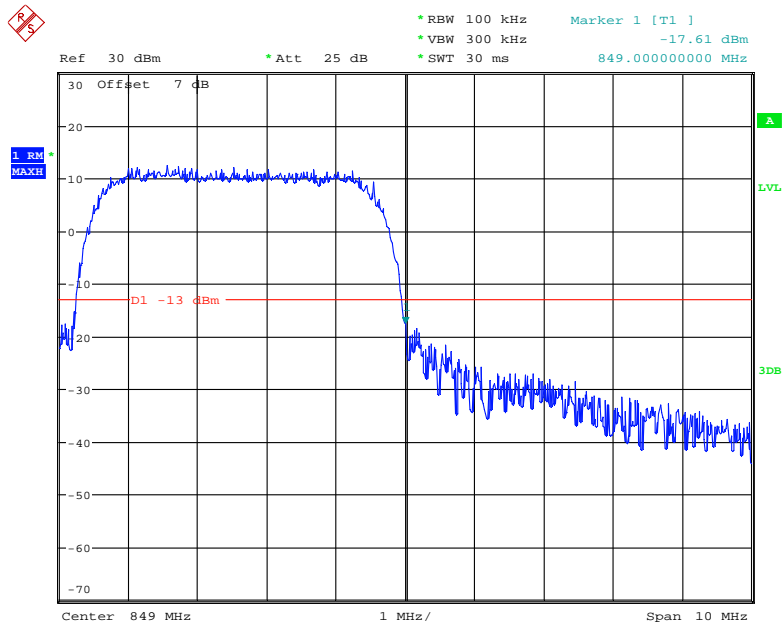

Date: 21.MAR.2021 13:28:03

### Cellular Band, Left Band Edge for HSUPA (BPSK) Mode

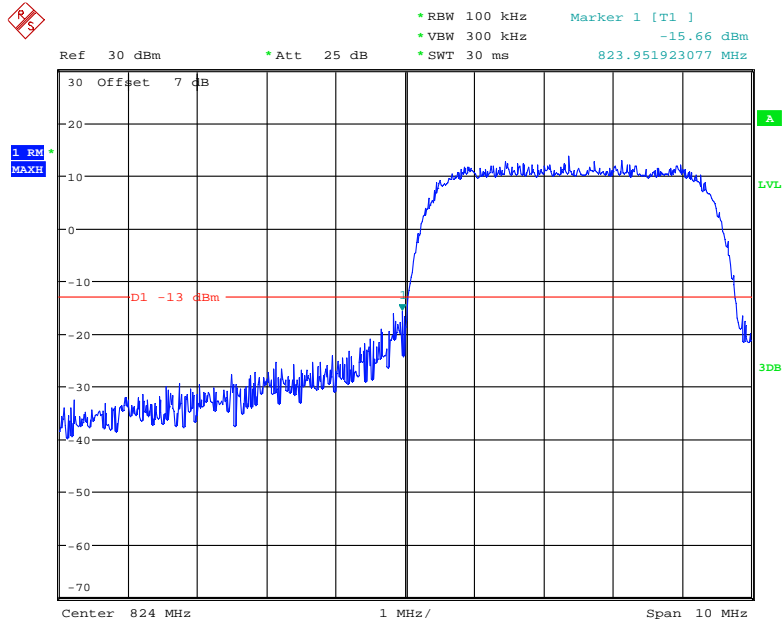

Date: 21.MAR.2021 15:41:01

### Cellular Band, Right Band Edge for HSUPA (BPSK) Mode

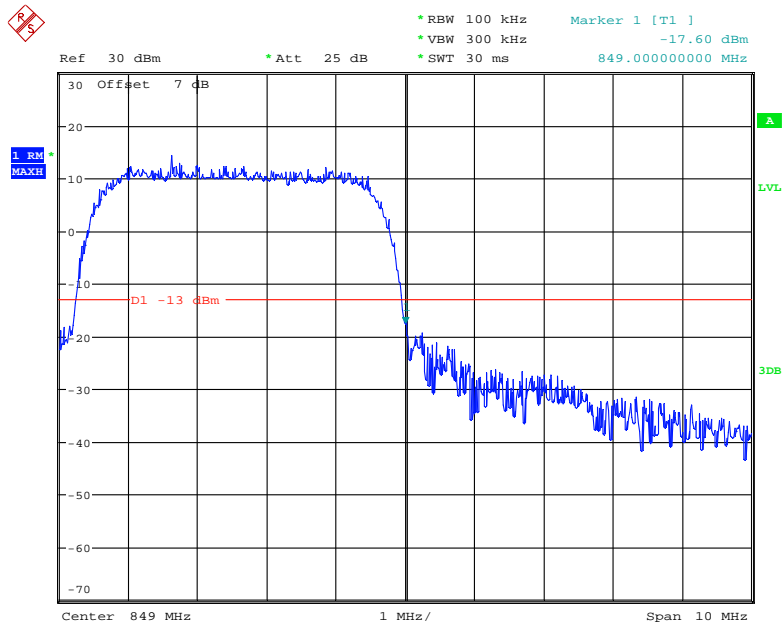

Date: 21.MAR.2021 15:42:05

### PCS Band, Left Band Edge for GSM (GMSK) Mode

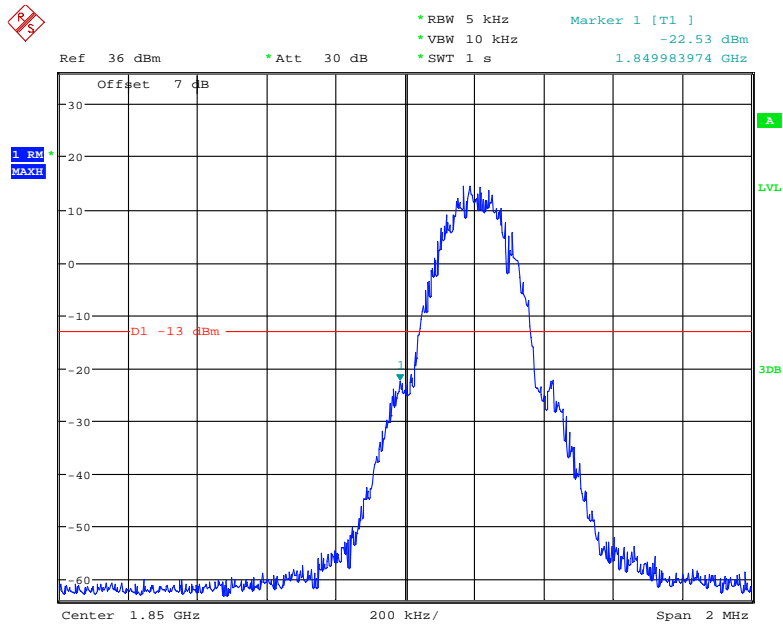

Date: 21.FEB.2021 15:05:38

### PCS Band, Right Band Edge for GSM (GMSK) Mode

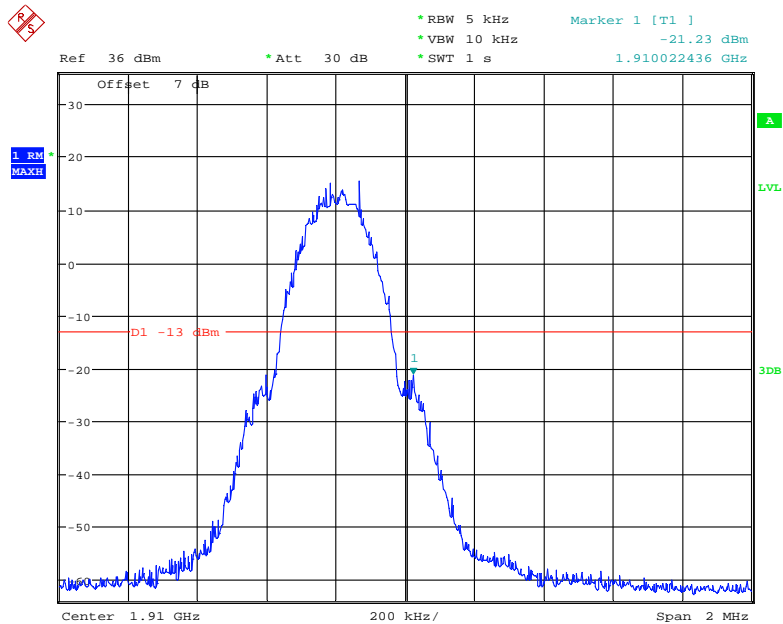

Date: 21.FEB.2021 15:06:45



PCS Band, Left Band Edge for EGPRS (GMSK) Mode

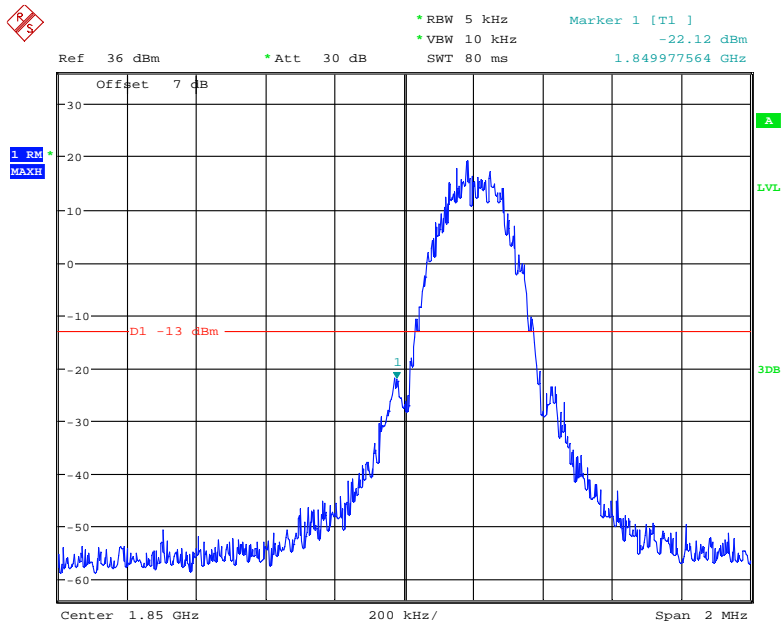

Date: 21.FEB.2021 15:12:42

PCS Band, Right Band Edge for EGPRS (GMSK) Mode

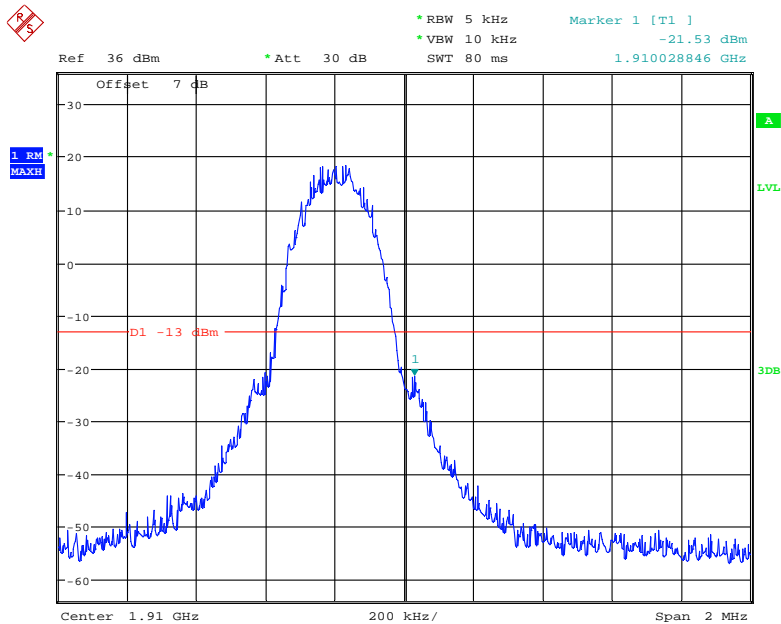

Date: 21.FEB.2021 15:12:09

### PCS Band, Left Band Edge for WCDMA (BPSK) Mode

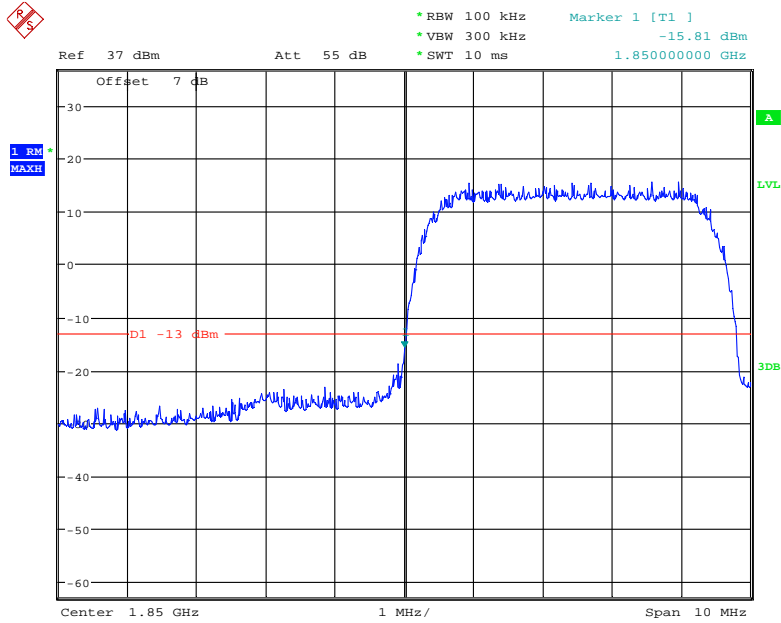

Date: 21.FEB.2021 15:33:23

### PCS Band, Right Band Edge for WCDMA (BPSK) Mode

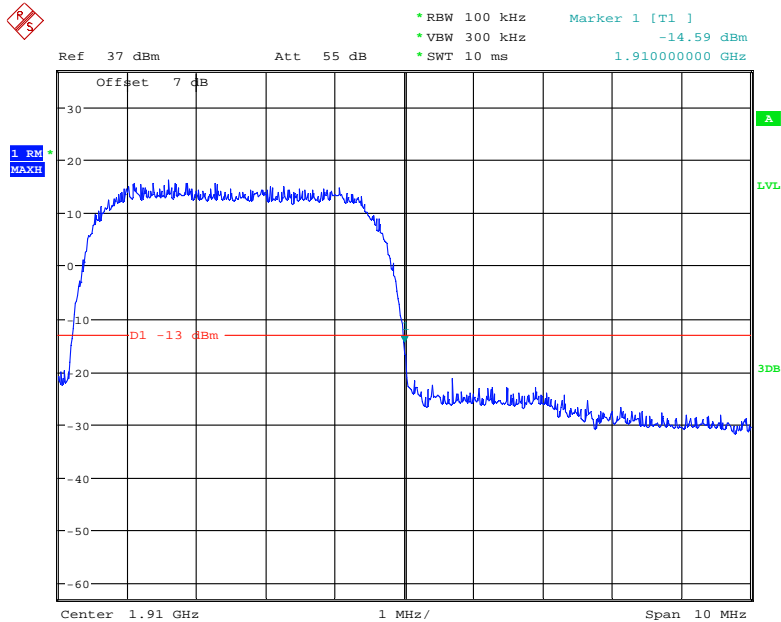

Date: 21.FEB.2021 15:34:12

### PCS Band, Left Band Edge for HSDPA (16QAM) Mode

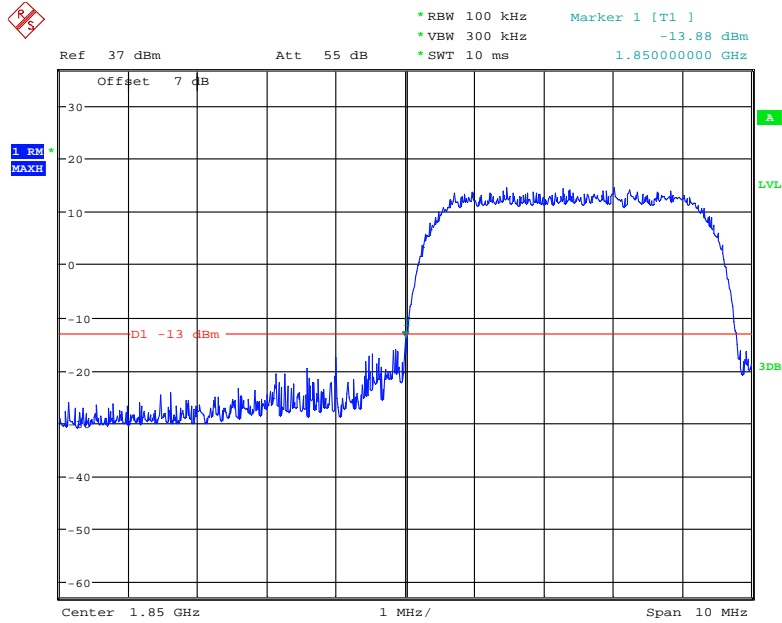

Date: 21.FEB.2021 15:36:46

### PCS Band, Right Band Edge for HSDPA (16QAM) Mode

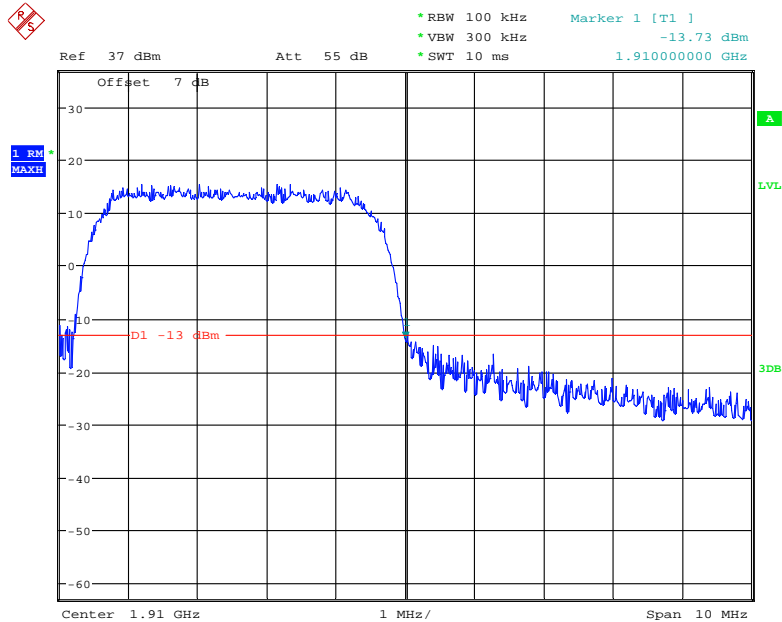

Date: 21.FEB.2021 15:36:03

### PCS Band, Left Band Edge for HSUPA (BPSK) Mode

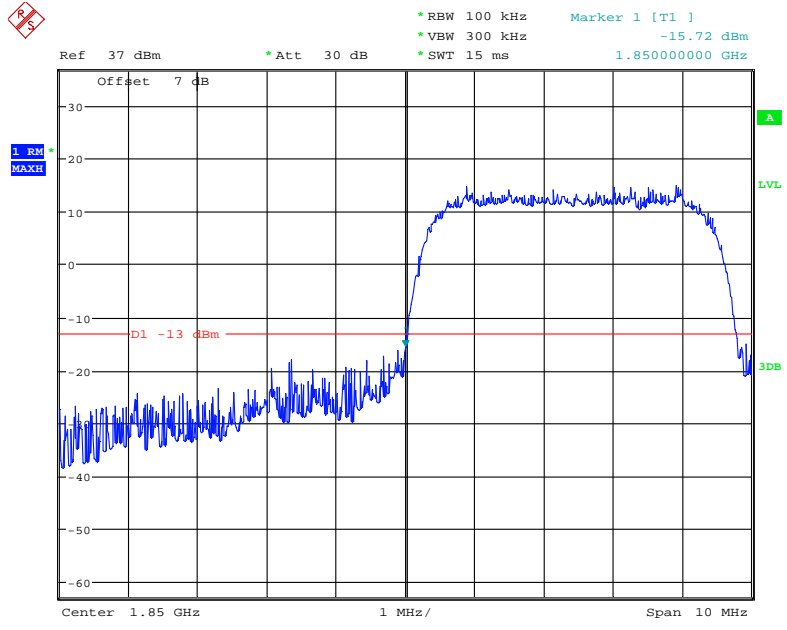

Date: 21.FEB.2021 15:48:20

### PCS Band, Right Band Edge for HSUPA (BPSK) Mode

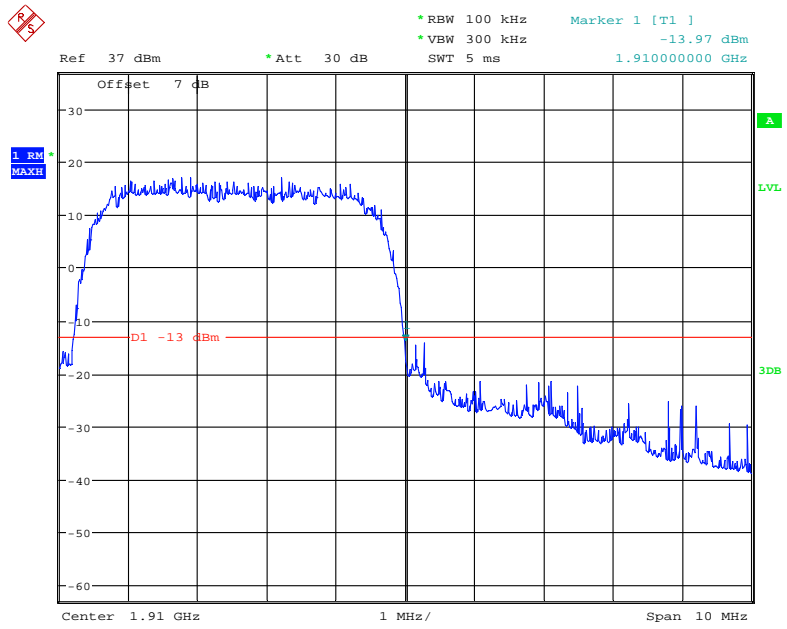

Date: 21.FEB.2021 15:46:36

### AWS Band, Left Band Edge for WCDMA (BPSK) Mode

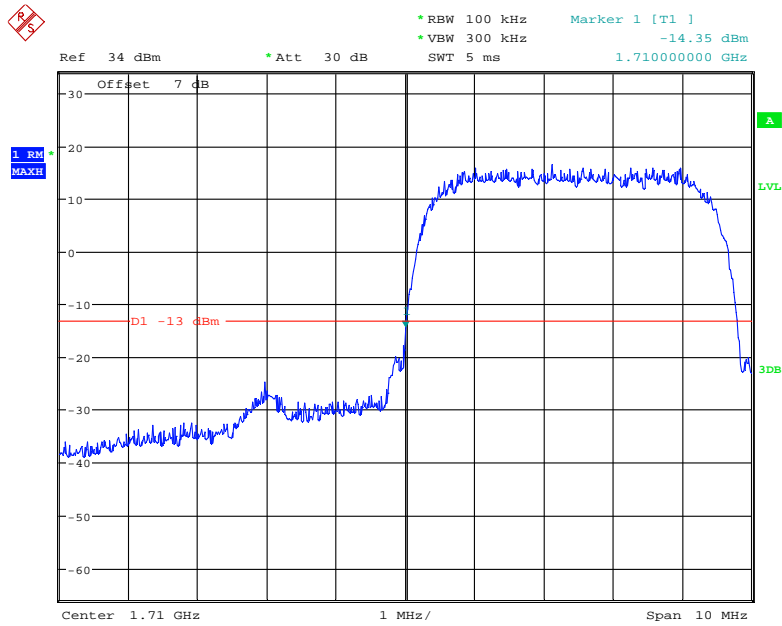

Date: 21.FEB.2021 16:05:27

### AWS Band, Right Band Edge for WCDMA (BPSK) Mode

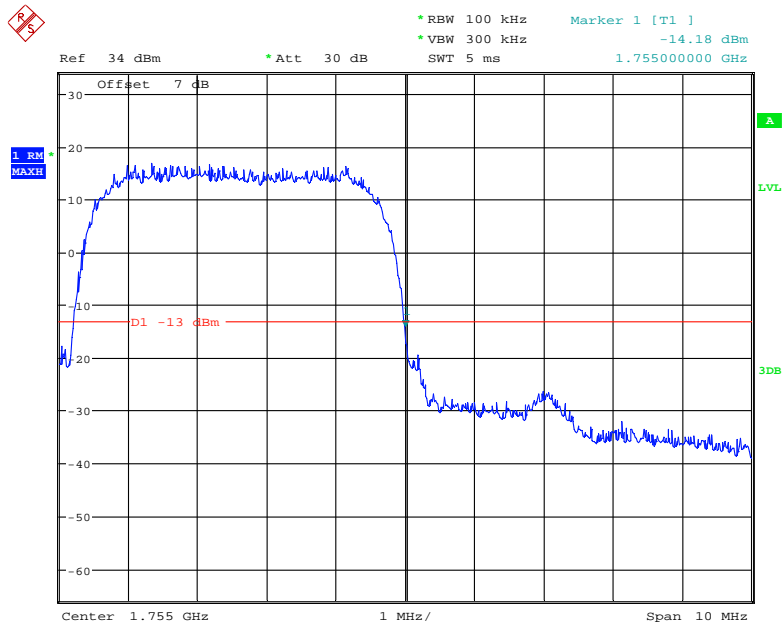

Date: 21.FEB.2021 16:04:57

### AWS Band, Left Band Edge for HSDPA (16QAM) Mode

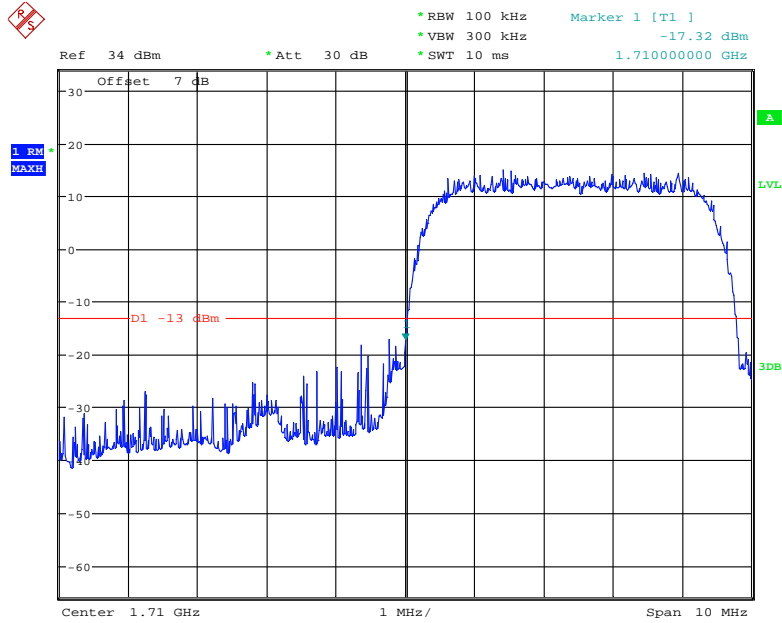

Date: 21.FEB.2021 16:18:55

### AWS Band, Right Band Edge for HSDPA (16QAM) Mode

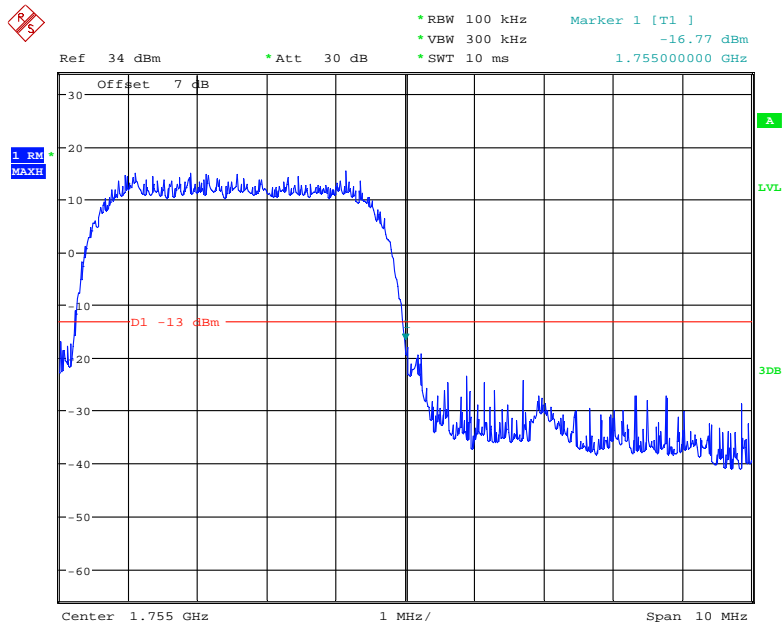

Date: 21.FEB.2021 16:18:10

**AWS Band, Left Band Edge for HSUPA (BPSK) Mode**

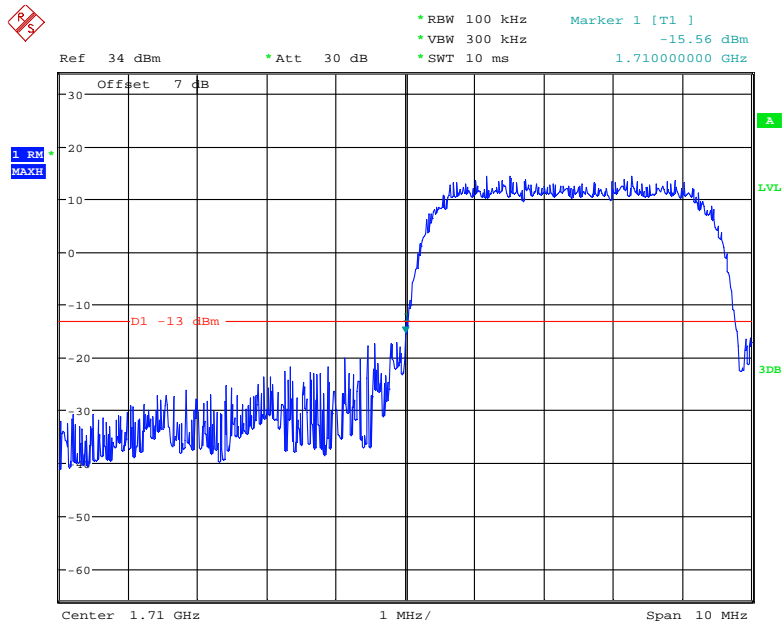

Date: 21.FEB.2021 16:16:48

**AWS Band, Right Band Edge for HSUPA (BPSK) Mode**

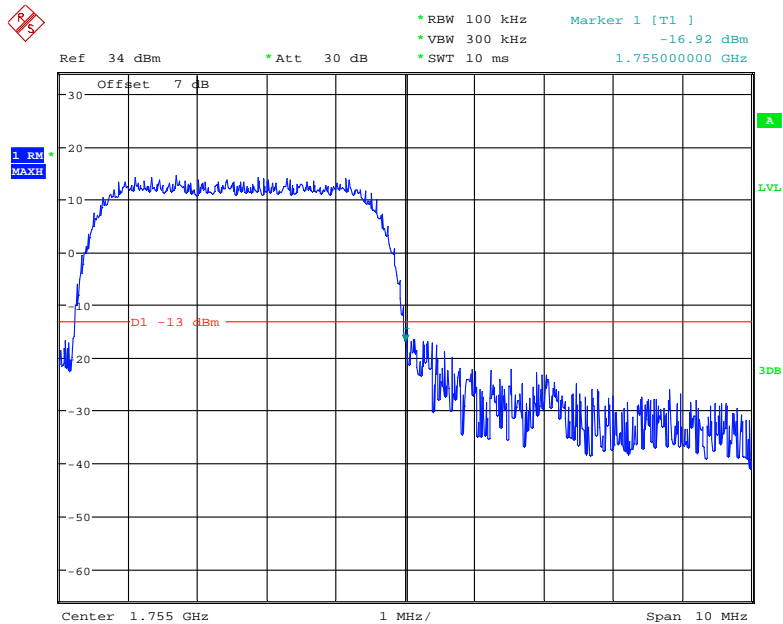

Date: 21.FEB.2021 16:17:29

The test plots of LTE bands please refer to the Appendix C.

**FCC § 2.1055; § 22.355; § 24.235; §27.54 - FREQUENCY STABILITY**

**Applicable Standard**

FCC § 2.1055, §22.355, §24.235 and & §27.54.

According to FCC §2.1055, the frequency stability shall be sufficient to ensure that the fundamental emissions stay within the authorized bands of operation.

According to §22.355, the carrier frequency of each transmitter in the Public Mobile Services must be maintained within the tolerances given in Table below:

Frequency Tolerance for Transmitters in the Public Mobile Services

Frequency Range (MHz)	Base, fixed (ppm)	Mobile ≤ 3 watts (ppm)	Mobile > 3 watts (ppm)
25 to 50	20.0	20.0	50.0
50 to 450	5.0	5.0	50.0
450 to 512	2.5	5.0	5.0
821 to 896	1.5	2.5	2.5
928 to 929.	5.0	N/A	N/A
929 to 960.	1.5	N/A	N/A
2110 to 2220	10.0	N/A	N/A

According to §24.235, the frequency stability shall be sufficient to ensure that the fundamental emissions stays within the authorized frequency block.

**Test Procedure**

Frequency Stability vs. Temperature: The equipment under test was connected to an external DC power supply and the RF output was connected to communication test set via feed-through attenuators. The EUT was placed inside the temperature chamber. The DC leads and RF output cable exited the chamber through an opening made for the purpose.

After the temperature stabilized for approximately 20 minutes, the frequency output was recorded from the communication test set.

Frequency Stability vs. Voltage: For hand carried, battery powered equipment; reduce primary supply voltage to the battery operating end point which shall be specified by the manufacturer.

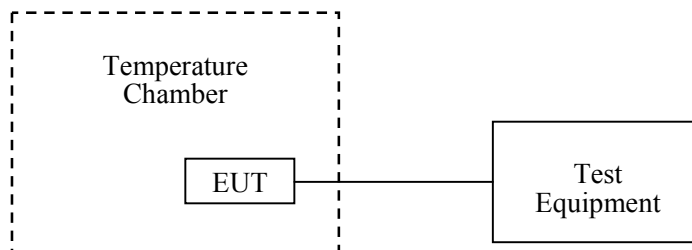



**Test Data**

**Environmental Conditions**

<b>Temperature:</b>	25 °C
<b>Relative Humidity:</b>	55 %
<b>ATM Pressure:</b>	101.0 kPa

*The testing was performed by Coco Liu from 2021-02-19 to 2021-03-21.*

*EUT operation mode: Transmitting*

**Test Result: Pass**

*Please refer to the following tables.*

**Cellular Band (Part 22H)**

**GSM Mode**

<b>Middle Channel, <math>f_0=836.6\text{MHz}</math></b>				
<b>Temperature (°C)</b>	<b>Voltage Supplied (V<sub>DC</sub>)</b>	<b>Frequency Error (Hz)</b>	<b>Frequency Error (ppm)</b>	<b>Limit (ppm)</b>
-30	3.87	4	0.0048	2.5
-20		4	0.0048	2.5
-10		4	0.0048	2.5
0		3	0.0036	2.5
10		7	0.0084	2.5
20		8	0.0096	2.5
30		9	0.0108	2.5
40		11	0.0131	2.5
50		5	0.0060	2.5
20		3.45	3	0.0036
	4.45	6	0.0072	2.5

**EDGE Mode**

Middle Channel, $f_0 = 836.6\text{MHz}$				
Temperature (°C)	Voltage Supplied (V <sub>DC</sub> )	Frequency Error (Hz)	Frequency Error (ppm)	Limit (ppm)
-30	3.87	4	0.0048	2.5
-20		6	0.0072	2.5
-10		7	0.0084	2.5
0		6	0.0072	2.5
10		9	0.0108	2.5
20		8	0.0096	2.5
30		9	0.0108	2.5
40		8	0.0096	2.5
50		12	0.0143	2.5
20	3.45	8	0.0096	2.5
	4.45	8	0.0096	2.5

**WCDMA Mode**

Middle Channel, $f_0 = 836.6\text{MHz}$				
Temperature (°C)	Voltage Supplied (V <sub>DC</sub> )	Frequency Error (Hz)	Frequency Error (ppm)	Limit (ppm)
-30	3.87	3	0.0036	2.5
-20		3	0.0036	2.5
-10		1	0.0012	2.5
0		5	0.0060	2.5
10		7	0.0084	2.5
20		7	0.0084	2.5
30		7	0.0084	2.5
40		2	0.0024	2.5
50		4	0.0048	2.5
20	3.45	6	0.0072	2.5
	4.45	2	0.0024	2.5

**PCS Band (Part 24E)**

**GSM Mode**

Middle Channel, $f_0 = 1880.0$ MHz				
Temperature (°C)	Voltage Supplied (V <sub>DC</sub> )	Frequency Error (Hz)	Frequency Error (ppm)	Result
-30	3.87	-2	-0.0011	pass
-20		7	0.0037	pass
-10		6	0.0032	pass
0		7	0.0037	pass
10		1	0.0005	pass
20		-3	-0.0016	pass
30		0	0.0000	pass
40		-6	-0.0032	pass
50		-4	-0.0021	pass
20		3.45	-1	-0.0005
	4.45	-2	-0.0011	pass

**EDGE Mode**

Middle Channel, $f_0 = 1880.0$ MHz				
Temperature (°C)	Voltage Supplied (V <sub>DC</sub> )	Frequency Error (Hz)	Frequency Error (ppm)	Result
-30	3.87	-1	-0.0011	pass
-20		-5	0.0037	pass
-10		-2	0.0032	pass
0		-5	0.0037	pass
10		-4	0.0005	pass
20		1	-0.0016	pass
30		0	0.0000	pass
40		-4	-0.0032	pass
50		1	-0.0021	pass
20		3.45	-3	-0.0005
	4.45	-5	-0.0011	pass

**WCDMA Mode**

Middle Channel, $f_0 = 1880.0$ MHz				
Temperature (°C)	Voltage Supplied (V <sub>DC</sub> )	Frequency Error (Hz)	Frequency Error (ppm)	Result
-30	3.87	7	0.0037	pass
-20		6	0.0032	pass
-10		10	0.0053	pass
0		13	0.0069	pass
10		8	0.0043	pass
20		4	0.0021	pass
30		5	0.0027	pass
40		6	0.0032	pass
50		4	0.0021	pass
20		3.45	4	0.0021
	4.45	4	0.0021	pass

**AWS Band (Part 27)**

Temperature (°C)	Power Supplied (V <sub>DC</sub> )	F <sub>L</sub> (MHz)	F <sub>H</sub> (MHz)	F <sub>L</sub> Limit (MHz)	F <sub>H</sub> Limit (MHz)
-30	3.87	1710.0658	1754.9365	1710	1755
-20		1710.0655	1754.9328	1710	1755
-10		1710.0643	1754.9309	1710	1755
0		1710.0601	1754.9367	1710	1755
10		1710.0623	1754.9335	1710	1755
20		1710.0613	1754.9351	1710	1755
30		1710.0625	1754.9353	1710	1755
40		1710.0649	1754.9343	1710	1755
50		1710.0601	1754.9320	1710	1755
20		3.45	1710.0654	1754.9348	1710
	4.45	1710.0606	1754.9312	1710	1755

LTE:  
QPSK:

Band 2:

10.0 MHz Middle Channel, $f_0=1880\text{MHz}$				
Temperature (°C)	Voltage Supplied (V <sub>DC</sub> )	Frequency Error (Hz)	Frequency Error (ppm)	Result
-30	3.87	-9	-0.0048	pass
-20		-4	-0.0021	pass
-10		-5	-0.0027	pass
0		7	0.0037	pass
10		7	0.0037	pass
20		11	0.0059	pass
30		-3	-0.0016	pass
40		7	0.0037	pass
50		-7	-0.0037	pass
20		3.45	-6	-0.0032
	4.45	-6	-0.0032	pass

Band 4:

10 MHz Bandwidth					
Temperature (°C)	Power Supplied (V <sub>DC</sub> )	F <sub>L</sub> (MHz)	F <sub>H</sub> (MHz)	F <sub>L</sub> Limit (MHz)	F <sub>H</sub> Limit (MHz)
-30	3.87	1710.4005	1754.5615	1710	1755
-20		1710.4171	1754.5347	1710	1755
-10		1710.3989	1754.5299	1710	1755
0		1710.3808	1754.5883	1710	1755
10		1710.4662	1754.5599	1710	1755
20		1710.3992	1754.4956	1710	1755
30		1710.4002	1754.4626	1710	1755
40		1710.4384	1754.5112	1710	1755
50		1710.3886	1754.5532	1710	1755
20		3.45	1710.4346	1754.5284	1710
	4.45	1710.4657	1754.5903	1710	1755

**Band 5:**

10.0 MHz Middle Channel, $f_0=836.5\text{MHz}$				
Temperature (°C)	Voltage Supplied (V <sub>DC</sub> )	Frequency Error (Hz)	Frequency Error (ppm)	Limit (ppm)
-30	3.87	-2	-0.0024	2.5
-20		-3	-0.0036	2.5
-10		-1	-0.0012	2.5
0		11	0.0131	2.5
10		12	0.0143	2.5
20		9	0.0108	2.5
30		-3	-0.0036	2.5
40		-5	-0.0060	2.5
50		-6	-0.0072	2.5
20	3.45	11	0.0131	2.5
	4.45	-2	-0.0024	2.5

**Band 7:**

10 MHz Bandwidth					
Temperature (°C)	Power Supplied (V <sub>DC</sub> )	F <sub>L</sub> (MHz)	F <sub>H</sub> (MHz)	F <sub>L</sub> Limit (MHz)	F <sub>H</sub> Limit (MHz)
-30	3.87	2500.4082	2569.5475	2500	2570
-20		2500.5085	2569.4883	2500	2570
-10		2500.4720	2569.5753	2500	2570
0		2500.4893	2569.5211	2500	2570
10		2500.4676	2569.5284	2500	2570
20		2500.4650	2569.5680	2500	2570
30		2500.5104	2569.4457	2500	2570
40		2500.4242	2569.5357	2500	2570
50		2500.4701	2569.5590	2500	2570
20	3.45	2500.4103	2569.5146	2500	2570
	4.45	2500.4325	2569.4949	2500	2570

**Band 17:**

10 MHz Bandwidth					
Temperature (°C)	Power Supplied (V <sub>DC</sub> )	F <sub>L</sub> (MHz)	F <sub>H</sub> (MHz)	F <sub>L</sub> Limit (MHz)	F <sub>H</sub> Limit (MHz)
-30	3.87	704.4082	715.5475	704	716
-20		704.5081	715.4885	704	716
-10		704.4718	715.5752	704	716
0		704.4894	715.5210	704	716
10		704.4677	715.5283	704	716
20		704.4649	715.5681	704	716
30		704.5103	715.4458	704	716
40		704.4245	715.5358	704	716
50		704.4699	715.5594	704	716
20	3.45	704.4103	715.5142	704	716
	4.45	704.4328	715.4948	704	716

**Band 38:**

10 MHz Bandwidth					
Temperature (°C)	Power Supplied (V <sub>DC</sub> )	F <sub>L</sub> (MHz)	F <sub>H</sub> (MHz)	F <sub>L</sub> Limit (MHz)	F <sub>H</sub> Limit (MHz)
-30	3.87	2570.0290	2619.9128	2570	2620
-20		2570.0536	2619.9191	2570	2620
-10		2570.0736	2619.9162	2570	2620
0		2570.0467	2619.9020	2570	2620
10		2570.0118	2619.9587	2570	2620
20		2570.0992	2619.9033	2570	2620
30		2570.0170	2619.9339	2570	2620
40		2570.0839	2619.9974	2570	2620
50		2570.0069	2619.9454	2570	2620
20	3.45	2570.0840	2619.9021	2570	2620
	4.45	2570.0999	2619.9819	2570	2620

**Band 41:**

10 MHz Bandwidth					
Temperature (°C)	Power Supplied (V <sub>DC</sub> )	F <sub>L</sub> (MHz)	F <sub>H</sub> (MHz)	F <sub>L</sub> Limit (MHz)	F <sub>H</sub> Limit (MHz)
-30	3.87	2535.0745	2654.9234	2535	2655
-20		2535.0508	2654.9872	2535	2655
-10		2535.0390	2654.9088	2535	2655
0		2535.0272	2654.9030	2535	2655
10		2535.0153	2654.9466	2535	2655
20		2535.0700	2654.9043	2535	2655
30		2535.0480	2654.9643	2535	2655
40		2535.0415	2654.9917	2535	2655
50		2535.0929	2654.9793	2535	2655
20		3.45	2535.0312	2654.9552	2535
	4.45	2535.0262	2654.9785	2535	2655

Note: The applicant declared the operating frequency range is 2535-2655MHz.

**Band 66:**

10 MHz Bandwidth					
Temperature (°C)	Power Supplied (V <sub>DC</sub> )	F <sub>L</sub> (MHz)	F <sub>H</sub> (MHz)	F <sub>L</sub> Limit (MHz)	F <sub>H</sub> Limit (MHz)
-30	3.87	1710.3744	1779.6232	1710	1780
-20		1710.3507	1779.6872	1710	1780
-10		1710.3391	1779.6089	1710	1780
0		1710.3269	1779.6033	1710	1780
10		1710.3150	1779.6466	1710	1780
20		1710.3700	1779.6044	1710	1780
30		1710.3481	1779.6642	1710	1780
40		1710.3414	1779.6914	1710	1780
50		1710.3933	1779.6792	1710	1780
20		3.45	1710.3314	1779.6550	1710
	4.45	1710.3262	1779.6787	1710	1780



**16QAM:**

**Band 2:**

10.0 MHz Middle Channel, $f_0 = 1880\text{MHz}$				
Temperature (°C)	Voltage Supplied (V <sub>DC</sub> )	Frequency Error (Hz)	Frequency Error (ppm)	Result
-30	3.87	-6	-0.0032	pass
-20		-4	-0.0021	pass
-10		15	0.0080	pass
0		-3	-0.0016	pass
10		-10	-0.0053	pass
20		-9	-0.0048	pass
30		-6	-0.0032	pass
40		-5	-0.0027	pass
50		10	0.0053	pass
20		3.45	11	0.0059
	4.45	10	0.0053	pass

**Band 4:**

10 MHz Bandwidth					
Temperature (°C)	Power Supplied (V <sub>DC</sub> )	F <sub>L</sub> (MHz)	F <sub>H</sub> (MHz)	F <sub>L</sub> Limit (MHz)	F <sub>H</sub> Limit (MHz)
-30	3.87	1710.3576	1754.5239	1710	1755
-20		1710.4038	1754.5062	1710	1755
-10		1710.5070	1754.5631	1710	1755
0		1710.3403	1754.5771	1710	1755
10		1710.4149	1754.5562	1710	1755
20		1710.4105	1754.5091	1710	1755
30		1710.4146	1754.5495	1710	1755
40		1710.4415	1754.4746	1710	1755
50		1710.4574	1754.6363	1710	1755
20		3.45	1710.4287	1754.6000	1710
	4.45	1710.4483	1754.5465	1710	1755

**Band 5:**

10.0 MHz Middle Channel, $f_0=836.5\text{MHz}$				
Temperature (°C)	Voltage Supplied (V <sub>DC</sub> )	Frequency Error (Hz)	Frequency Error (ppm)	Limit (ppm)
-30	3.87	-8	-0.0096	2.5
-20		8	0.0096	2.5
-10		-4	-0.0048	2.5
0		13	0.0155	2.5
10		-7	-0.0084	2.5
20		8	0.0096	2.5
30		9	0.0108	2.5
40		-2	-0.0024	2.5
50		-3	-0.0036	2.5
20		3.45	9	0.0108
	4.45	-3	-0.0036	2.5

**Band 7:**

10 MHz Bandwidth					
Temperature (°C)	Power Supplied (V <sub>DC</sub> )	F <sub>L</sub> (MHz)	F <sub>H</sub> (MHz)	F <sub>L</sub> Limit (MHz)	F <sub>H</sub> Limit (MHz)
-30	3.87	2500.4794	2569.4723	2500	2570
-20		2500.5104	2569.5632	2500	2570
-10		2500.5069	2569.5336	2500	2570
0		2500.4748	2569.5735	2500	2570
10		2500.5126	2569.5499	2500	2570
20		2500.4387	2569.5234	2500	2570
30		2500.4975	2569.4931	2500	2570
40		2500.4742	2569.5285	2500	2570
50		2500.4424	2569.5696	2500	2570
20		3.45	2500.4174	2569.5522	2500
	4.45	2500.4528	2569.5061	2500	2570

**Band 17:**

10 MHz Bandwidth					
Temperature (°C)	Power Supplied (V <sub>DC</sub> )	F <sub>L</sub> (MHz)	F <sub>H</sub> (MHz)	F <sub>L</sub> Limit (MHz)	F <sub>H</sub> Limit (MHz)
-30	3.87	704.4086	715.5472	704	716
-20		704.5084	715.4885	704	716
-10		704.4717	715.5754	704	716
0		704.4894	715.5208	704	716
10		704.4680	715.5284	704	716
20		704.4648	715.5677	704	716
30		704.5100	715.4458	704	716
40		704.4248	715.5360	704	716
50		704.4700	715.5592	704	716
20	3.45	704.4106	715.5140	704	716
	4.45	704.4325	715.4948	704	716

**Band 38:**

10 MHz Bandwidth					
Temperature (°C)	Power Supplied (V <sub>DC</sub> )	F <sub>L</sub> (MHz)	F <sub>H</sub> (MHz)	F <sub>L</sub> Limit (MHz)	F <sub>H</sub> Limit (MHz)
-30	3.87	2570.0368	2619.9323	2570	2620
-20		2570.0314	2619.9335	2570	2620
-10		2570.0329	2619.9347	2570	2620
0		2570.0332	2619.9336	2570	2620
10		2570.0323	2619.9316	2570	2620
20		2570.0312	2619.9351	2570	2620
30		2570.0308	2619.9293	2570	2620
40		2570.0315	2619.9305	2570	2620
50		2570.0298	2619.9319	2570	2620
20	3.45	2570.0365	2619.9361	2570	2620
	4.45	2570.0332	2619.9343	2570	2620

**Band 41:**

10 MHz Bandwidth					
Temperature (°C)	Power Supplied (V <sub>DC</sub> )	F <sub>L</sub> (MHz)	F <sub>H</sub> (MHz)	F <sub>L</sub> Limit (MHz)	F <sub>H</sub> Limit (MHz)
-30	3.87	2535.0744	2654.9233	2535	2655
-20		2535.0507	2654.9876	2535	2655
-10		2535.0389	2654.9086	2535	2655
0		2535.0275	2654.9030	2535	2655
10		2535.0154	2654.9465	2535	2655
20		2535.0697	2654.9044	2535	2655
30		2535.0483	2654.9643	2535	2655
40		2535.0412	2654.9916	2535	2655
50		2535.0927	2654.9796	2535	2655
20	3.45	2535.0313	2654.9551	2535	2655
	4.45	2535.0260	2654.9782	2535	2655

Note: The applicant declared the operating frequency range is 2535-2655MHz.

**Band 66:**

10 MHz Bandwidth					
Temperature (°C)	Power Supplied (V <sub>DC</sub> )	F <sub>L</sub> (MHz)	F <sub>H</sub> (MHz)	F <sub>L</sub> Limit (MHz)	F <sub>H</sub> Limit (MHz)
-30	3.87	1710.3741	1779.6234	1710	1780
-20		1710.3505	1779.6871	1710	1780
-10		1710.3389	1779.6088	1710	1780
0		1710.3267	1779.6031	1710	1780
10		1710.3147	1779.6461	1710	1780
20		1710.3704	1779.6043	1710	1780
30		1710.3481	1779.6645	1710	1780
40		1710.3414	1779.6915	1710	1780
50		1710.3933	1779.6794	1710	1780
20	3.45	1710.3314	1779.6552	1710	1780
	4.45	1710.3262	1779.6785	1710	1780

\*\*\*\*\* END OF REPORT \*\*\*\*\*